



Installing Transceivers and Optical Components on Avaya Ethernet Routing Switch 4800 Series

Release 5.9
NN47205-301
Issue 08.02
August 2016

Notice

While reasonable efforts have been made to ensure that the information in this document is complete and accurate at the time of printing, Avaya assumes no liability for any errors. Avaya reserves the right to make changes and corrections to the information in this document without the obligation to notify any person or organization of such changes.

Documentation disclaimer

"Documentation" means information published in varying mediums which may include product information, operating instructions and performance specifications that are generally made available to users of products. Documentation does not include marketing materials. Avaya shall not be responsible for any modifications, additions, or deletions to the original published version of Documentation unless such modifications, additions, or deletions were performed by or on the express behalf of Avaya. End User agrees to indemnify and hold harmless Avaya, Avaya's agents, servants and employees against all claims, lawsuits, demands and judgments arising out of, or in connection with, subsequent modifications, additions or deletions to this documentation, to the extent made by End User.

Link disclaimer

Avaya is not responsible for the contents or reliability of any linked websites referenced within this site or Documentation provided by Avaya. Avaya is not responsible for the accuracy of any information, statement or content provided on these sites and does not necessarily endorse the products, services, or information described or offered within them. Avaya does not guarantee that these links will work all the time and has no control over the availability of the linked pages.

Warranty

Avaya provides a limited warranty on Avaya hardware and software. Refer to your sales agreement to establish the terms of the limited warranty. In addition, Avaya's standard warranty language, as well as information regarding support for this product while under warranty is available to Avaya customers and other parties through the Avaya Support website: <https://support.avaya.com/helpcenter/getGenericDetails?detailId=C20091120112456651010> under the link "Warranty & Product Lifecycle" or such successor site as designated by Avaya. Please note that if You acquired the product(s) from an authorized Avaya Channel Partner outside of the United States and Canada, the warranty is provided to You by said Avaya Channel Partner and not by Avaya.

"Hosted Service" means an Avaya hosted service subscription that You acquire from either Avaya or an authorized Avaya Channel Partner (as applicable) and which is described further in Hosted SAS or other service description documentation regarding the applicable hosted service. If You purchase a Hosted Service subscription, the foregoing limited warranty may not apply but You may be entitled to support services in connection with the Hosted Service as described further in your service description documents for the applicable Hosted Service. Contact Avaya or Avaya Channel Partner (as applicable) for more information.

Hosted Service

THE FOLLOWING APPLIES ONLY IF YOU PURCHASE AN AVAYA HOSTED SERVICE SUBSCRIPTION FROM AVAYA OR AN AVAYA CHANNEL PARTNER (AS APPLICABLE), THE TERMS OF USE FOR HOSTED SERVICES ARE AVAILABLE ON THE AVAYA WEBSITE, [HTTPS://SUPPORT.AVAYA.COM/LICENSEINFO](https://support.avaya.com/LICENSEINFO) UNDER THE LINK "Avaya Terms of Use for Hosted Services" OR SUCH SUCCESSOR SITE AS DESIGNATED BY AVAYA, AND ARE APPLICABLE TO ANYONE WHO ACCESSES OR USES THE HOSTED SERVICE. BY ACCESSING OR USING THE HOSTED SERVICE, OR AUTHORIZING OTHERS TO DO SO, YOU, ON BEHALF OF YOURSELF AND THE ENTITY FOR WHOM YOU ARE DOING SO (HEREINAFTER REFERRED TO INTERCHANGEABLY AS "YOU" AND "END USER"), AGREE TO THE TERMS OF USE. IF YOU ARE ACCEPTING THE TERMS OF USE ON BEHALF A COMPANY OR OTHER LEGAL ENTITY, YOU REPRESENT THAT YOU HAVE THE AUTHORITY TO BIND SUCH ENTITY TO THESE TERMS OF USE. IF YOU DO NOT HAVE SUCH AUTHORITY, OR

IF YOU DO NOT WISH TO ACCEPT THESE TERMS OF USE, YOU MUST NOT ACCESS OR USE THE HOSTED SERVICE OR AUTHORIZE ANYONE TO ACCESS OR USE THE HOSTED SERVICE.

Licenses

THE SOFTWARE LICENSE TERMS AVAILABLE ON THE AVAYA WEBSITE, [HTTPS://SUPPORT.AVAYA.COM/LICENSEINFO](https://support.avaya.com/LICENSEINFO), UNDER THE LINK "AVAYA SOFTWARE LICENSE TERMS (Avaya Products)" OR SUCH SUCCESSOR SITE AS DESIGNATED BY AVAYA, ARE APPLICABLE TO ANYONE WHO DOWNLOADS, USES AND/OR INSTALLS AVAYA SOFTWARE, PURCHASED FROM AVAYA INC., ANY AVAYA AFFILIATE, OR AN AVAYA CHANNEL PARTNER (AS APPLICABLE) UNDER A COMMERCIAL AGREEMENT WITH AVAYA OR AN AVAYA CHANNEL PARTNER. UNLESS OTHERWISE AGREED TO BY AVAYA IN WRITING, AVAYA DOES NOT EXTEND THIS LICENSE IF THE SOFTWARE WAS OBTAINED FROM ANYONE OTHER THAN AVAYA, AN AVAYA AFFILIATE OR AN AVAYA CHANNEL PARTNER; AVAYA RESERVES THE RIGHT TO TAKE LEGAL ACTION AGAINST YOU AND ANYONE ELSE USING OR SELLING THE SOFTWARE WITHOUT A LICENSE. BY INSTALLING, DOWNLOADING OR USING THE SOFTWARE, OR AUTHORIZING OTHERS TO DO SO, YOU, ON BEHALF OF YOURSELF AND THE ENTITY FOR WHOM YOU ARE INSTALLING, DOWNLOADING OR USING THE SOFTWARE (HEREINAFTER REFERRED TO INTERCHANGEABLY AS "YOU" AND "END USER"), AGREE TO THESE TERMS AND CONDITIONS AND CREATE A BINDING CONTRACT BETWEEN YOU AND AVAYA INC. OR THE APPLICABLE AVAYA AFFILIATE ("AVAYA").

Avaya grants You a license within the scope of the license types described below, with the exception of Heritage Nortel Software, for which the scope of the license is detailed below. Where the order documentation does not expressly identify a license type, the applicable license will be a Designated System License. The applicable number of licenses and units of capacity for which the license is granted will be one (1), unless a different number of licenses or units of capacity is specified in the documentation or other materials available to You. "Software" means computer programs in object code, provided by Avaya or an Avaya Channel Partner, whether as stand-alone products, pre-installed on hardware products, and any upgrades, updates, patches, bug fixes, or modified versions thereto. "Designated Processor" means a single stand-alone computing device. "Server" means a Designated Processor that hosts a software application to be accessed by multiple users. "Instance" means a single copy of the Software executing at a particular time: (i) on one physical machine; or (ii) on one deployed software virtual machine ("VM") or similar deployment.

License types

Designated System(s) License (DS). End User may install and use each copy or an Instance of the Software only on a number of Designated Processors up to the number indicated in the order. Avaya may require the Designated Processor(s) to be identified in the order by type, serial number, feature key, Instance, location or other specific designation, or to be provided by End User to Avaya through electronic means established by Avaya specifically for this purpose.

Database License (DL). End User may install and use each copy or an Instance of the Software on one Server or on multiple Servers provided that each of the Servers on which the Software is installed communicates with no more than one Instance of the same database.

Heritage Nortel Software

"Heritage Nortel Software" means the software that was acquired by Avaya as part of its purchase of the Nortel Enterprise Solutions Business in December 2009. The Heritage Nortel Software is the software contained within the list of Heritage Nortel Products located at <https://support.avaya.com/LicenseInfo> under the link "Heritage Nortel Products" or such successor site as designated by Avaya. For Heritage Nortel Software, Avaya grants Customer a license to use Heritage Nortel Software provided hereunder solely to the extent of the authorized activation or authorized usage level, solely for the purpose specified in the Documentation, and solely as embedded in, for execution on, or for communication with Avaya equipment.

Charges for Heritage Nortel Software may be based on extent of activation or use authorized as specified in an order or invoice.

Copyright

Except where expressly stated otherwise, no use should be made of materials on this site, the Documentation, Software, Hosted Service, or hardware provided by Avaya. All content on this site, the documentation, Hosted Service, and the product provided by Avaya including the selection, arrangement and design of the content is owned either by Avaya or its licensors and is protected by copyright and other intellectual property laws including the sui generis rights relating to the protection of databases. You may not modify, copy, reproduce, republish, upload, post, transmit or distribute in any way any content, in whole or in part, including any code and software unless expressly authorized by Avaya. Unauthorized reproduction, transmission, dissemination, storage, and or use without the express written consent of Avaya can be a criminal, as well as a civil offense under the applicable law.

Virtualization

The following applies if the product is deployed on a virtual machine. Each product has its own ordering code and license types. Note that each Instance of a product must be separately licensed and ordered. For example, if the end user customer or Avaya Channel Partner would like to install two Instances of the same type of products, then two products of that type must be ordered.

Third Party Components

"Third Party Components" mean certain software programs or portions thereof included in the Software or Hosted Service may contain software (including open source software) distributed under third party agreements ("Third Party Components"), which contain terms regarding the rights to use certain portions of the Software ("Third Party Terms"). As required, information regarding distributed Linux OS source code (for those products that have distributed Linux OS source code) and identifying the copyright holders of the Third Party Components and the Third Party Terms that apply is available in the products, Documentation or on Avaya's website at: <https://support.avaya.com/Copyright> or such successor site as designated by Avaya. The open source software license terms provided as Third Party Terms are consistent with the license rights granted in these Software License Terms, and may contain additional rights benefiting You, such as modification and distribution of the open source software. The Third Party Terms shall take precedence over these Software License Terms, solely with respect to the applicable Third Party Components to the extent that these Software License Terms impose greater restrictions on You than the applicable Third Party Terms.

The following applies only if the H.264 (AVC) codec is distributed with the product. THIS PRODUCT IS LICENSED UNDER THE AVC PATENT PORTFOLIO LICENSE FOR THE PERSONAL USE OF A CONSUMER OR OTHER USES IN WHICH IT DOES NOT RECEIVE REMUNERATION TO (i) ENCODE VIDEO IN COMPLIANCE WITH THE AVC STANDARD ("AVC VIDEO") AND/OR (ii) DECODE AVC VIDEO THAT WAS ENCODED BY A CONSUMER ENGAGED IN A PERSONAL ACTIVITY AND/OR WAS OBTAINED FROM A VIDEO PROVIDER LICENSED TO PROVIDE AVC VIDEO. NO LICENSE IS GRANTED OR SHALL BE IMPLIED FOR ANY OTHER USE. ADDITIONAL INFORMATION MAY BE OBTAINED FROM MPEG LA, L.L.C. SEE [HTTP://WWW.MPEGLA.COM](http://www.mpegla.com).

Service Provider

THE FOLLOWING APPLIES TO AVAYA CHANNEL PARTNER'S HOSTING OF AVAYA PRODUCTS OR SERVICES. THE PRODUCT OR HOSTED SERVICE MAY USE THIRD PARTY COMPONENTS SUBJECT TO THIRD PARTY TERMS AND REQUIRE A SERVICE PROVIDER TO BE INDEPENDENTLY LICENSED DIRECTLY FROM THE THIRD PARTY SUPPLIER. AN AVAYA CHANNEL PARTNER'S HOSTING OF AVAYA PRODUCTS MUST BE AUTHORIZED IN WRITING BY AVAYA AND IF THOSE HOSTED PRODUCTS USE OR EMBED CERTAIN THIRD PARTY SOFTWARE, INCLUDING BUT NOT LIMITED TO MICROSOFT SOFTWARE OR CODECS, THE AVAYA CHANNEL PARTNER IS REQUIRED TO INDEPENDENTLY OBTAIN ANY APPLICABLE LICENSE AGREEMENTS, AT THE AVAYA CHANNEL PARTNER'S EXPENSE, DIRECTLY FROM THE APPLICABLE THIRD PARTY SUPPLIER.

WITH RESPECT TO CODECS, IF THE AVAYA CHANNEL PARTNER IS HOSTING ANY PRODUCTS THAT USE OR EMBED THE G.729 CODEC, H.264 CODEC, OR H.265 CODEC, THE AVAYA CHANNEL PARTNER ACKNOWLEDGES AND AGREES THE AVAYA CHANNEL PARTNER IS RESPONSIBLE FOR ANY AND ALL RELATED FEES AND/OR ROYALTIES. THE G.729 CODEC IS LICENSED BY SIPRO LAB TELECOM INC. SEE [WWW.SIPRO.COM/CONTACT.HTML](http://www.sipro.com/contact.html). THE H.264 (AVC) CODEC IS LICENSED UNDER THE AVC PATENT PORTFOLIO LICENSE FOR THE PERSONAL USE OF A CONSUMER OR OTHER USES IN WHICH IT DOES NOT RECEIVE REMUNERATION TO: (I) ENCODE VIDEO IN COMPLIANCE WITH THE AVC STANDARD ("AVC VIDEO") AND/OR (II) DECODE AVC VIDEO THAT WAS ENCODED BY A CONSUMER ENGAGED IN A PERSONAL ACTIVITY AND/OR WAS OBTAINED FROM A VIDEO PROVIDER LICENSED TO PROVIDE AVC VIDEO. NO LICENSE IS GRANTED OR SHALL BE IMPLIED FOR ANY OTHER USE. ADDITIONAL INFORMATION FOR H.264 (AVC) AND H.265 (HEVC) CODECS MAY BE OBTAINED FROM MPEG LA, L.L.C. SEE [HTTP://WWW.MPEGLA.COM](http://www.mpegla.com).

Compliance with Laws

You acknowledge and agree that it is Your responsibility for complying with any applicable laws and regulations, including, but not limited to laws and regulations related to call recording, data privacy, intellectual property, trade secret, fraud, and music performance rights, in the country or territory where the Avaya product is used.

Preventing Toll Fraud

"Toll Fraud" is the unauthorized use of your telecommunications system by an unauthorized party (for example, a person who is not a corporate employee, agent, subcontractor, or is not working on your company's behalf). Be aware that there can be a risk of Toll Fraud associated with your system and that, if Toll Fraud occurs, it can result in substantial additional charges for your telecommunications services.

Avaya Toll Fraud intervention

If You suspect that You are being victimized by Toll Fraud and You need technical assistance or support, call Technical Service Center Toll Fraud Intervention Hotline at +1-800-643-2353 for the United States and Canada. For additional support telephone numbers, see the Avaya Support website: <https://support.avaya.com> or such successor site as designated by Avaya.

Security Vulnerabilities

Information about Avaya's security support policies can be found in the Security Policies and Support section of <https://support.avaya.com/security>.

Suspected Avaya product security vulnerabilities are handled per the Avaya Product Security Support Flow (<https://support.avaya.com/css/P8/documents/100161515>).

Downloading Documentation

For the most current versions of Documentation, see the Avaya Support website: <https://support.avaya.com>, or such successor site as designated by Avaya.

Contact Avaya Support

See the Avaya Support website: <https://support.avaya.com> for product or Hosted Service notices and articles, or to report a problem with your Avaya product or Hosted Service. For a list of support telephone numbers and contact addresses, go to the Avaya Support website: <https://support.avaya.com> (or such successor site as designated by Avaya), scroll to the bottom of the page, and select Contact Avaya Support.

Trademarks

The trademarks, logos and service marks ("Marks") displayed in this site, the Documentation, Hosted Service(s), and product(s) provided by Avaya are the registered or unregistered Marks of Avaya, its affiliates, its licensors, its suppliers, or other third parties. Users are not permitted to use such Marks without prior written consent from Avaya or such third party which may own the Mark. Nothing contained in this site, the Documentation, Hosted Service(s) and product(s) should be construed as granting, by implication, estoppel,

or otherwise, any license or right in and to the Marks without the express written permission of Avaya or the applicable third party.

Avaya is a registered trademark of Avaya Inc.

All non-Avaya trademarks are the property of their respective owners. Linux[®] is the registered trademark of Linus Torvalds in the U.S. and other countries.

Contents

Chapter 1: Introduction	7
Purpose.....	7
Chapter 2: New in this release	8
Features.....	8
Other changes.....	8
Chapter 3: Safety and equipment care information	9
Handling, safety, and environmental guidelines.....	9
Electrostatic discharge prevention.....	9
Care of fiber optic equipment.....	10
Fiber optic cable care.....	10
Fiber optic connector care.....	10
Cleaning single connectors.....	11
Cleaning duplex connectors.....	12
Cleaning receptacles.....	13
Product safety warnings and information.....	14
ESD and installation caution messages.....	15
Laser safety warnings.....	16
Chapter 4: Small form factor pluggable transceivers	18
Selecting an SFP.....	18
Installing an SFP.....	22
Removing an SFP.....	24
Chapter 5: Small form factor pluggable plus transceivers	25
Selecting an SFP+.....	25
Installing an SFP+.....	26
Removing an SFP+.....	28
Chapter 6: 10 Gigabit small form factor pluggable transceivers	29
Selecting an XFP.....	29
Installing an XFP.....	30
Removing an XFP.....	32
Chapter 7: SFP specifications	33
SFP labels.....	33
General SFP specifications.....	34
100BASE-FX SFP specifications.....	34
T1 SFP specifications.....	35
T1 SFP—default settings.....	37
1000BASE-T SFP specifications.....	38
1000BASE-SX (LC) SFP specifications.....	39
1000BASE-SX (MT-RJ) SFP specifications.....	39
1000BASE-LX SFP specifications.....	40

1000BASE-XD CWDM SFP specifications.....	41
1000BASE-ZX CWDM SFP specifications.....	41
1000BASE-SX DDI SFP specifications.....	42
1000BASE-LX DDI SFP specifications.....	43
1000BASE-XD DDI 1310 nm SFP specifications.....	43
1000BASE-XD DDI 1550 nm SFP specifications.....	44
1000BASE-ZX DDI SFP specifications.....	45
1000BASE-XD DDI CWDM SFP specifications.....	45
1000BASE-ZX DDI CWDM SFP specifications.....	46
1000BASE-BX10 DDI SFP specifications.....	47
1000BASE-BX40 DDI SFP specifications.....	48
1000BASE-EX DDI SFP specifications.....	49
Chapter 8: SFP+ specifications.....	51
SFP+ labels.....	51
General SFP+ specifications.....	52
SFP+ transceiver specifications.....	52
10GBASE-ER CWDM SFP+ specifications.....	59
Chapter 9: XFP specifications.....	61
XFP labels.....	61
General XFP specifications.....	61
10GBASE-SR XFP specifications.....	62
10GBASE-LRM XFP specifications.....	63
10GBASE-LR/LW XFP specifications.....	65
10GBASE-ZR/ZW XFP specifications.....	67
Chapter 10: Resources.....	69
Support.....	69
Searching a documentation collection.....	70
Subscribing to e-notifications.....	71

Chapter 1: Introduction

Purpose

You can use this document to help you select, install, and remove Small Form Factor Pluggable (SFP), Small Form Factor Pluggable Plus (SFP+), and 10 Gigabit Small Form Factor Pluggable (XFP) transceivers. Specifications for each supported device are also included.

Chapter 2: New in this release

The following sections detail what is new in *Installing Transceivers and Optical Components on Avaya Ethernet Routing Switch 4800 Series*, NN47205-301 for release 5.9.

Features

There are no feature changes for this release.

Other changes

See the following sections for information about changes that are not feature-related.

Document title change

Installing Transceivers and Optical Components on Avaya Ethernet Routing Switch 4000 Series is renamed *Installing Transceivers and Optical Components on Avaya Ethernet Routing Switch 4800 Series*.

Introduction chapter

Information about Related resources and Support are moved to the last chapter in this document.

SFP + specifications

Information is added for 10GBASE-ER CWDM SFP+ transceivers.

Chapter 3: Safety and equipment care information

This section contains important safety and regulatory information. Read this section before you install Small Form Factor Pluggable (SFP), Small Form Factor Pluggable Plus (SFP+), or 10 Gigabit Small Form Factor Pluggable (XFP) transceivers.

Handling, safety, and environmental guidelines

Before you install an SFP, SFP+, or XFP transceiver, read the following handling, safety, and environmental guidelines:

- SFP, SFP+, and XFP transceivers are static sensitive. For more information about how to prevent damage from electrostatic discharge (ESD), see [Electrostatic discharge prevention](#) on page 9.
- Dust contamination can reduce the performance of optical parts in transceivers. When you store a transceiver, or after you disconnect it from a fiber optic cable, always keep a dust cover over the optical bore.
- Dispose of this product according to all national laws and regulations.

Electrostatic discharge prevention

To prevent equipment damage, observe the following electrostatic discharge (ESD) precautions when you handle or install the components.

- Ground yourself and the equipment to an earth or building ground. Use a grounded workbench mat (or foam that dissipates static charge) and a grounding wrist strap. The wrist strap must touch the skin and be grounded through a one megaohm resistor.
- Do not touch anyone who is not grounded.
- Leave all components in their ESD-safe packaging until installation, and use only a static-shielding bag for all storage, transport, and handling.
- Clear the area of synthetic materials such as polyester, plastic, vinyl, or styrofoam because these materials carry static electricity that damages the equipment.

Care of fiber optic equipment

You must keep fiber optic equipment connections clean and damage-free. Use the information in this section to properly maintain and care for fiber optic equipment.

Fiber optic cable care

Although the glass fiber in fiber optic cable is protected with reinforcing material and plastic insulation, it is subject to damage. Use the following precautions to avoid damaging the glass fiber.

- Do not kink, knot, or vigorously flex the cable.
- Do not bend the cable to less than a 40 mm radius.
- Do not stand on fiber optic cable; keep the cable off the floor.
- Do not pull fiber optic cable harder than you do a cable containing copper wire of comparable size.
- Do not allow a static load of more than a few pounds on a section of the cable.
- Place protective caps on fiber optic connectors that are not in use.
- Store unused fiber optic patch cables in a cabinet, on a cable rack, or flat on a shelf.

Frequent overstressing of fiber optic cable causes progressive degeneration that leads to failure.

If you suspect damage to a fiber optic cable, either due to mishandling or an abnormally high error rate observed in one direction, reverse the cable pairs. If the high error rate appears in the other direction, replace the cable.

 **Caution:**

Risk of equipment damage

Do not crush fiber optic cable. If fiber optic cable is in the same tray or duct with large, heavy electrical cables, it can be damaged by the weight of the electrical cable.

Fiber optic connector care

Before connecting fiber optic connectors to transmission equipment, test equipment, patch panels, or other connectors, ensure fiber optic connectors are clean. The performance of an optical fiber connector depends on how clean the connector and coupling are at the time of connection.

A damaged or dirty connector can damage a connector with which it pairs. A connector must be absolutely clean before you insert it into a transmitter or receiver.

Never clean an optical connector while it carries light. Optical power can cause ignition of the cleaning material when it contacts the end of the optical connector and destroy the connector. Typical cleaning materials, for example, tissues saturated with alcohol, combust almost instantaneously after you expose them to optical power levels of +15 dBm or higher.

Visually inspect the connector to determine cleanliness and to determine if it needs replacing. You must replace a connector that has a scratch across the core, or a scratch that appears to end in the core.

The proper connector cleaning method depends on the connector contaminants:

- Judge cleanliness by visual inspection with a fiber microscope. First inspect the connector, and then clean as required.

 **Warning:**

Risk of eye injury

When you inspect a connector, ensure that light sources are off. The light source in fiber optic cables can damage your eyes.

- If you suspect only the possibility of dust particles (for example, which can occur when you leave a connector uncapped in a clean environment), use high-quality canned air or a reel cleaner, for example, a Cletop, to clean the connector. A reel cleaner is a good choice to ensure that no dust contaminates the connector.
- If the connector is visibly dirty or you suspect it to be contaminated by chemicals (for example, matching gel), use high-quality alcohol and canned air to clean the connector. This method is the most thorough cleaning method. In some cases, a reel cleaner can suffice.

The more surface manipulation you apply to the connector, the more likely the connector is to become damaged.

When you insert a connector ferrule into a connector or adapter, ensure that the ferrule tip does not touch the outside of the mating connector or adapter. This can produce scratches and dirt deposits on the connector.

To help prevent connectors from collecting dust, cover them when not in use. To avoid the transfer of oil or other contaminants from your fingers to the end face of the ferrule, handle connectors with care. Do not touch the connector end face.

Cleaning single connectors

Clean connectors so that the optical signal is minimally attenuated by the connector.

This procedure is appropriate when you suspect more than dust contamination.

Prerequisites

- You need a lens-grade, lint-free tissue, for example, Kimwipes.
- You need an optical-grade isopropyl alcohol (IPA) (98% or more pure).
- You need a high-quality canned compressed air with extension tube.

Compressed air must be free of dust, water, and oil, or filmy deposits or scratches on the surface of the connector can result.

- You need a fiber optic microscope to inspect connectors.

 **Warning:**

Risk of eye injury

When inspecting a connector, ensure that light sources are off. The light source used in fiber optic cables can damage your eyes.

To avoid getting debris in your eyes, wear safety glasses when working with the canned air duster.

To avoid eye irritation on contact, wear safety glasses when working with isopropyl alcohol.

Procedure steps

1. Remove dust or debris by applying canned air to the cylindrical and end-face surfaces of the connector.
2. Gently wipe the cylindrical and end-face surfaces with a tissue dampened with optical-grade isopropyl alcohol.
3. Gently wipe the cylindrical and end-face surfaces with a dry tissue.

 **Important:**

Do not let the IPA evaporate; wipe it dry immediately. Alcohols can leave a residue that is difficult to remove.

4. Dry the connector surfaces by applying canned air.
5. Inspect the connector to ensure it is clean and undamaged.

To prevent contamination, do not touch the connector surfaces after cleaning; and cover connectors with dust caps if you are not going to use them right away.

Cleaning duplex connectors

Clean connectors so that the optical signal is minimally attenuated by the connector.

This procedure is appropriate when you suspect more than dust contamination.

Prerequisites

- You need a lens-grade, lint-free tissue, for example, Kimwipes.
- You need an optical-grade isopropyl alcohol (IPA) (98% or more pure).
- You need a high-quality canned compressed air with extension tube.

Compressed air must be free of dust, water, and oil, or filmy deposits or scratches on the surface of the connector can result.

- You need a fiber optic microscope to inspect connectors.

⚠ Warning:**Risk of eye injury**

When you inspect a connector, ensure that light sources are off. The light source in fiber optic cables can damage your eyes.

To avoid getting debris in your eyes, wear safety glasses when you work with the canned air duster.

To avoid eye irritation on contact, wear safety glasses when you work with isopropyl alcohol.

Procedure steps

1. To remove or retract the shroud, do one of the following.
 - On removable shroud connectors, hold the shroud on the top and bottom at the letter designation, apply medium pressure, and then pull it free from the connector body. Do not discard the shroud.
 - On retractable shroud connectors, hold the shroud in its retracted position.
2. Remove dust or debris by applying canned air to the cylindrical and end-face surfaces of the connector.
3. Gently wipe the cylindrical and end-face surfaces of both ferrules using a tissue saturated with optical-grade isopropyl alcohol.
4. Gently wipe the cylindrical and end-face surfaces with a dry tissue.

! Important:

Do not let the IPA evaporate; wipe it dry immediately. Alcohols can leave a residue that is difficult to remove.

5. Blow dry the connector surfaces with canned air.
6. Inspect the connector to ensure it is clean and undamaged.
7. Using care to not touch the clean ferrules, gently push the shroud back onto the connector until it seats and locks in place.

Cleaning receptacles

Clean connector receptacles or ports so that the optical signal is minimally attenuated by the connection.

Prerequisites

- You need an optical-grade isopropyl alcohol (IPA) (98% or more pure).
- You need cleaning swabs (also called cleaning sticks or wands).
- You need a high-quality canned compressed air with extension tube.

Compressed air must be free of dust, water, and oil, or filmy deposits or scratches on the surface of the connector can result.

 **Caution:**

Risk of equipment damage

To avoid contamination, optical ports must only be cleaned when there is evidence of contamination or reduced performance, or during their initial installation.

To prevent oil contamination of connectors, use only high-quality canned compressed air.

Do not allow the air extension tube to touch the bottom of the optical port.

Procedure steps

1. Remove dust or debris by blowing canned air into the optical port of the device using the canned air extension tube.
2. Clean the optical port by inserting a wand moistened with alcohol into the receptacle and rotating it.

Each cleaning wand must only be used to clean one optical port.

3. Dry the optical port by inserting a dry wand into the receptacle and rotating it.

 **Important:**

Do not let the IPA evaporate; wipe it dry immediately. Alcohols can leave a residue that is difficult to remove.

4. Remove lint by blowing compressed air into the optical port.
5. Reconnect the optical connector and check for proper function.

If you are not reinstalling the connector, be sure to use a protective cap.

If problems persist, ensure that the connector or receptacle is free from damage.

Product safety warnings and information

The products described in this guide meet requirements of:

- IEC 60950 3rd edition
- CSA 22.2 No. 60950 3rd edition
- UL 60950 3rd edition
- EN60950 3rd edition
- EN60825-1, +A11, +A2

ESD and installation caution messages

This section provides electrostatic discharge (ESD) and installation caution messages.

 **Electrostatic alert:**

Risk of equipment damage

To prevent damage from electrostatic discharge, always wear an antistatic wrist strap connected to an ESD jack.

 **Electrostatic alert:**

ATTENTION

Risque d'endommagement de l'équipement

Pour prévenir tout dommage dû à une décharge électrostatique, vous devez toujours porter un bracelet antistatique connecté à une prise ESD.

 **Electrostatic alert:**

ACHTUNG

Risiko eines Geräteschadens

Risiko eines Geräteschadens Um Schäden durch elektrostatische Entladung zu verhindern, tragen Sie bei der Instandhaltung dieses Produkts immer ein antistatisches Band am Handgelenk, welches mit einer ESD-Buchse verbunden ist.

 **Electrostatic alert:**

PRECAUCIÓN

Riesgo de daño del equipo

Para prevenir el daño producido por una descarga electrostática, use siempre una pulsera antiestática conectada a un enchufe ESD.

 **Electrostatic alert:**

CUIDADO

Risco de danos ao equipamento

Para evitar danos com descarga eletrostática, sempre use uma pulseira antiestática que esteja conectada a uma tomada ESD.

 **Electrostatic alert:**

ATTENZIONE

Rischio di danni all'apparecchiatura

Per evitare danni derivanti da scariche elettrostatiche, indossare sempre un polsino antistatico collegato a una presa ESD.



Caution:

Risk of equipment damage

Only trained personnel can install this product.



Caution:

ATTENTION

Risque d'endommagement de l'équipement

L'installation doit être effectuée exclusivement par un personnel qualifié.



Caution:

ACHTUNG

Risiko eines Geräteschadens

Nur geschultes Personal kann dieses Produkt installieren.



Caution:

PRECAUCIÓN

Riesgo de daño del equipo

Sólo el personal capacitado puede instalar este producto.



Caution:

CUIDADO

Risco de danos ao equipamento

Somente pessoal treinado pode instalar este produto.



Caution:

ATTENZIONE

Rischio di danni all'apparecchiatura

Questo prodotto può essere installato solo da personale esperto.

Laser safety warnings

This section provides laser safety warnings.



8769EB

 **Warning:****Risk of eye injury by laser**

Fiber optic equipment can emit laser or infrared light that can injure your eyes. Never look into an optical fiber or connector port. Always assume that fiber optic cables are connected to a light source.

 **Warning:****AVERTISSEMENT**

Risques de blessure oculaire par lumière laser L'équipement de fibres optiques peut émettre une lumière laser ou infrarouge nuisible à vos yeux. Ne regardez jamais en direction de fibres optiques ou d'un port connecteur. Supposez toujours que les câbles de fibres optiques sont connectés à une source de lumière.

 **Warning:****WARNUNG**

Risiko einer Augenverletzung durch Laser Glasfasergeräte können Laserstrahlen oder ultraviolette Licht aussenden, das Ihre Augen verletzen kann. Schauen Sie nie direkt in einen Glasfaserleiter oder Verbindungsanschluss. Gehen Sie immer davon aus, dass Glasfaserkabel mit einer Lichtquelle verbunden sind.

 **Warning:****ADVERTENCIA**

Riesgo de lesión en los ojos por láser El equipo de fibra óptica puede emitir una luz láser o infrarroja que dañe sus ojos. Nunca mire un puerto de fibra óptica o conector. Siempre asuma que los cables de fibra óptica están conectados a una fuente de luz.

 **Warning:****AVISO**

O laser pode causar ferimentos no olho O equipamento de fibra ótica pode emitir laser ou luz infravermelha que pode causar danos a sua vista. Nunca olhe para dentro da fibra ótica ou da porta do conector. Tenha sempre em mente que os cabos de fibra ótica estão ligados a uma fonte de luz.

 **Warning:****AVVISO**

Rischio di ustioni agli occhi dovute al laser Le apparecchiature con fibre ottiche possono emettere raggi laser o infrarossi in grado di provocare ferite agli occhi. Non guardare mai all'interno di una porta di connessione o una fibra ottica. Tenere sempre presente che i cavi a fibra ottica sono collegati a una sorgente luminosa.

Chapter 4: Small form factor pluggable transceivers

This section describes how to select and install small form factor pluggable (SFP) transceivers.

Use an SFP to connect a device motherboard to a fiber optic or unshielded twisted pair network cable. The SFPs described in this section provide Ethernet at 1 gigabit per second (Gb/s).

Selecting an SFP

Use an SFP transceiver to connect a device motherboard to a fiber optic or unshielded twisted pair network cable. Select the appropriate transceiver to provide the required reach.

Procedure steps

1. Determine the required reach.

Depending on the product, SFPs are available for cable distances of up to 100 meters (m), 550 m, 10 kilometers (km), 40 km, 70 km, and 120 km.

2. Determine the required media and connector type.

You need fiber optic cable for a reach over 100 m.

Possible media include CAT5, single mode fiber, and multimode fiber. Possible connectors include Lucent connector (LC), MT-RJ, and RJ-45.

3. If the media is optical fiber, determine wavelength restrictions or requirements.

To expand available bandwidth on a common optical fiber, use Coarse Wavelength Division Multiplexing (CWDM) SFPs.

4. Determine if you need digital diagnostic monitoring (DDM).

Not all SFPs or products support DDM.

5. Use the following job aids to determine the appropriate SFP for your application.

Job aid

The following table describes the reach provided by various SFPs. This table is informational only—not all Avaya Ethernet switching and routing products support all the SFPs listed here.

SFP model	Common application
T1 Fast Ethernet to T1 Remote Bridge	Provides 1.544 Mb/s connectivity with up to 2874 m reach over 22 AWG cable. You can reduce the distance when you use common 24 AWG UTP CAT5/5E cable. Applications include connecting remote LANs and providing transparent LAN services over leased lines.
100BASE-FX	Provides 100 Mb/s LAN services with up to 2 km reach.
1000BASE-BX10	Up to 10 km reach. Bidirectional over one single mode fiber.
1000BASE-BX40	Up to 40 km reach. Bidirectional over one single mode fiber.
1000BASE-LX	Up to 10 km reach over a single mode fiber (SMF) pair. Up to 550 m reach over a multimode fiber (MMF) pair.
1000BASE-SX	Well-suited for campus local area networks (LAN) and intrabuilding links. Up to 275 or 550 m reach (fiber-dependent) over a fiber pair.
1000BASE-T	Lowest-cost gigabit Ethernet solution. Up to 100 m reach over Category 5 (CAT5) unshielded twisted pair (UTP).
1000BASE-XD	Up to 40 km reach over a single mode fiber pair.
1000BASE-ZX	Up to 70 km reach over a single mode fiber pair.

Job aid

SFPs are hot-swappable input and output enhancement components designed for use with Avaya products to allow gigabit Ethernet ports to link with other gigabit Ethernet ports over various media types.

The SFPs described in this section do not have Digital Diagnostic Interface capability, and are RoHS -E5 compliant.

The system also supports CWDM SFPs. CWDM technology consolidates multiple optical channels on a common optical fiber. CWDM uses multiple wavelengths to expand available bandwidth.

CWDM SFPs support high speed data communications for Metropolitan Area Networks (MAN). The system uses a grid of eight CWDM optical wavelengths in both ring and point-to-point configurations. All components are color-coded by wavelength.

Important:

The attainable cable length can vary depending on the quality of the fiber optic cable used.

Model and connector	Product number	Description
1000BASE-SX (LC)	AA1419013-E5	850 (nm), up to 275 or 550 m

Table continues...

Model and connector	Product number	Description
		<p>NOTE: After December 31, 2008 the Ethernet Routing Switch 4000 also supports the DDI-capable SFP, part number AA1419048-E6. The DDI-capable version is compatible with AA1419013-E5. The 1000Base-SX non-DDI SFP order code is still supported, but it is discontinued and no longer available for purchase.</p>
1000BASE-SX (MT-RJ)	AA1419014-E5	<p>850 nm, up to 275 or 550 m</p> <p>The 1000Base-SX non-DDI SFP order code is still supported, but it is discontinued and is no longer available for purchase.</p>
1000BASE-LX (LC)	AA1419015-E5	<p>1310 nm, up to 10 km</p> <p>* Note:</p> <p>After December 31, 2008 the Ethernet Routing Switch 4000 also supports the DDI-capable SFP, part number AA1419049-E6. The DDI-capable version is compatible with AA1419015-E5. The 1000Base-LX non-DDI SFP order code is still supported, but is discontinued and is no longer available for purchase.</p>
1000BASE-XD CWDM (LC)	AA1419025-E5 to AA1419032-E5	<p>1470 nm to 1610 nm, up to 40 km</p> <p>The 1000Base-XD non-DDI CWDM (40 km) SFP order codes are still supported, but are discontinued and no longer available for purchase.</p>
1000BASE-ZX CWDM (LC)	AA1419033-E5 to AA1419040-E5	<p>1470 nm to 1610 nm, up to 70 km</p> <p>The 1000Base-ZX non-DDI CWDM (70 km) SFP order codes are still supported, but are discontinued and no longer available for purchase.</p>
1000BASE-T (RJ-45)	AA1419043-E5	<p>CAT5 UTP, up to 100 m.</p> <p>Supports 1 Gbps.</p> <p>* Note:</p> <p>Supports 1 Gbps and 100 Mbps in the following units:</p> <ul style="list-style-type: none"> • ERS 4826GTS

Table continues...

Model and connector	Product number	Description
		<ul style="list-style-type: none"> • ERS 4826GTS-PWR+ • ERS 4850GTS • ERS 4850GTS-PWR+
100BASE-FX (LC)	AA1419074-E6	1310 nanometers (nm), up to 2 km Supported by the following switch models: 4826GTS, 4826GTS-PWR+, 4850GTS, and 4850GTS-PWR+.
T1 (RJ-48C)	AA1419075-E6	1.544 Mb/s Fast Ethernet to T1 remote bridge. Supported by the following switch models: 4826GTS, 4826GTS-PWR+, 4850GTS, and 4850GTS-PWR+.

For more information about specifications for these SFPs, see [SFP specifications](#) on page 33.

Job aid

You can use a Digital Diagnostic Indicating (DDI) SFP in a switch that supports SFPs beginning with Release 5.2. The switch supports the optical functions of the SFP. A future release will provide access to the DDI information.

The following table lists and describes the Avaya SFP models with DDI capability.

Model	Product number	Description
1000BASE-T (RJ-45)	AA1419043-E6	CAT5 UTP, up to 100 m. Because the 1000BASE-T device is all electrical, there is no need for DDI support.
1000BASE-SX	AA1419048-E6	850 nm, up to 275 or 550 m
1000BASE-LX	AA1419049-E6	1310 nm, up to 10 km
1000BASE-XD	AA1419050-E6	1310 nm, up to 40 km
1000BASE-XD	AA1419051-E6	1550 nm, up to 40 km
1000BASE-ZX	AA1419052-E6	1550 nm, up to 70 km
1000BASE-XD CWDM	AA1419053-E6 to AA1419060-E6	1470 nm to 1630 nm, up to 40 km
1000BASE-ZX CWDM	AA1419061-E6 to AA1419068-E6	1470 nm to 1630 nm, up to 70 km
1000BASE-BX (LC type)	AA1419069-E6, AA1419070-E6	Bidirectional 1310 nm and 1490 nm, up to 10 km
1000BASE-EX	AA1419071-E6	1550 nm, up to 120 km
1000BASE-BX (LC type)	AA1419076-E6, AA1419077-E6	Bidirectional 1310 nm and 1490 nm, up to 40 km

Installing an SFP

Install an SFP to provide an interface between the switch and the network cable.

Installing an SFP takes about three minutes.

For translations of the following messages, see [Product safety warnings and information](#) on page 14.

Prerequisites

- Verify that the SFP is the correct model for your network configuration.
- Before you install the optical connector, ensure it is clean.

 **Warning:**

Risk of eye injury by laser

Fiber optic equipment can emit laser or infrared light that can injure your eyes. Never look into an optical fiber or connector port. Always assume that fiber optic cables are connected to a light source.

 **Electrostatic alert:**

Risk of equipment damage

To prevent damage from electrostatic discharge, always wear an antistatic wrist strap connected to an ESD jack.

 **Caution:**

Risk of equipment damage

Only trained personnel can install this product.

Procedure steps

1. Remove the SFP from its protective packaging.
2. Grasp the SFP between your thumb and forefinger.
3. As shown in the following figure, insert the device into the slot on the module.

 **Caution:**

Risk of equipment damage

SFPs are keyed to prevent incorrect insertion. If the SFP resists pressure, do not force it; turn it over, and reinsert it.

Apply a light pressure to the device until it clicks and locks into position.

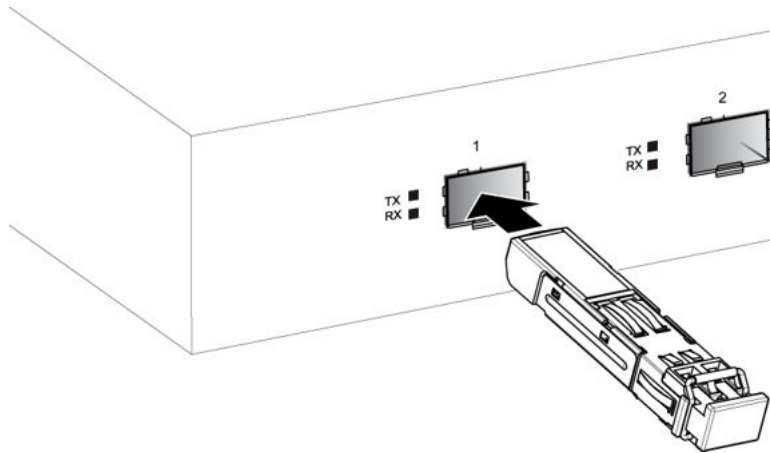

4. Remove the dust cover from the optical bore and insert the fiber optic connector.

Job aid

Depending on the transceiver manufacturer, your SFP transceiver can have various types of locking and extractor mechanisms.

The following figures show a typical mechanism used on SFP transceivers; other locking and extractor mechanisms exist, although they are not shown here. In the following figure, the SFP still has the bore plug installed. Pull the bail to release the device.

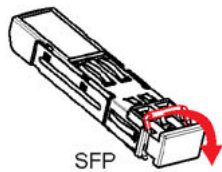

The following figure shows the 1000BASE-SX MT-RJ SFP. Push the tab to release the device.

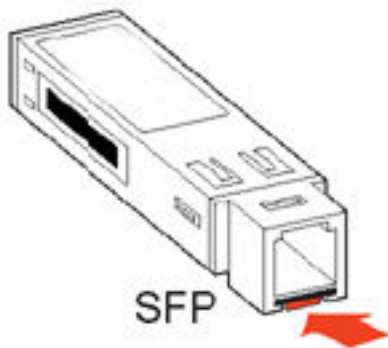

Removing an SFP

Remove an SFP to replace it or to commission it elsewhere.

Prerequisites

- Wear an antistatic wrist strap.

 **Warning:**

Risk of eye injury by laser

Fiber optic equipment can emit laser or infrared light that can injure your eyes. Never look into an optical fiber or connector port. Always assume that fiber optic cables are connected to a light source.

 **Electrostatic alert:**

Risk of equipment damage

To prevent damage from electrostatic discharge, always wear an antistatic wrist strap connected to an ESD jack.

Procedure steps

1. Disconnect the network fiber optic cable from the SFP connector.
2. Affix dust covers over the fiber optic bore and connector.
3. Depending on your SFP model, to release the SFP, press the locking and extractor mechanism.
4. Slide the SFP out of the module SFP slot.

If the SFP does not slide easily from the module slot, use a gentle side-to-side rocking motion while firmly pulling the SFP from the slot.

5. Store the SFP in a safe place until needed.

 **Important:**

If you discard the SFP, be sure to dispose of it according to all national laws and regulations.

Chapter 5: Small form factor pluggable plus transceivers

This section describes how to select and install small form factor pluggable plus (SFP+) transceivers.

Use an SFP+ transceiver to connect a device motherboard to fiber optic or direct attached cables. SFP+ transceivers are similar to SFP transceivers in physical appearance but SFP+ transceivers support 10 gigabit per second (Gb/s) connections. You must ensure that your switch supports SFP+ transceivers before installation or use. SFP+ transceivers and XFP transceivers both support 10 Gb/s connections, but are not compatible devices. SFP+ transceivers are physically smaller than XFP transceivers.

Important:

Avaya recommends that you only use Avaya qualified transceivers. If you use other vendor transceivers, Avaya does not support them.

Selecting an SFP+

About this task

Use an SFP+ transceiver to interface a device motherboard to a fiber optic cable. Select the appropriate transceiver to provide the required reach.

Procedure

1. Determine the required reach.
Depending on the product, you can obtain SFP+s for cable distances of up to 15 meters (m), 300 m, 10 kilometers (km), and 40 km.
2. Determine wavelength restrictions or requirements.
3. Use the following job aid to determine the appropriate SFP+ for your application.

Job aid

SFP+ transceivers are hot-swappable input and output enhancement components that allow 10 gigabit connections.

All Avaya SFP+ transceivers use Lucent connectors (LC) to provide precision keying and low interface losses.

The following table lists and describes the Avaya SFP+ models.

Model number	Product number	Description
10GBASE-SR	AA1403015-E6	850 nanometers (nm). The range is up to <ul style="list-style-type: none"> • 22 m using 62.5 micrometer (μm), 160 megaHertz times km (MHz-km) MMF • 33 m using 62.5 μm, 200 MHz-km MMF • 66 m using 62.5 μm, 500 MHz-km MMF • 82 m using 50 μm, 500 MHz-km MMF • 300 m using 50 μm, 2000 MHz-km MMF
10GBASE-LRM	AA1403017-E6	1310 nm. Up to 220 m reach over Fiber Distributed Data Interface (FDDI)-grade 62.5 μm multimode fiber. Suited for campus LANs.
10GBASE-LR	AA1403011-E6	1310 nm SMF. The range is up to 10 km.
10GBASE-ER	AA1403013-E6	1550 nm SMF. The range is up to 40 km.
10GBASE-CX	AA1403018-E6 to AA1403021-E6	4-pair direct attach twinaxial copper cable to connect 10 Gb ports. The maximum range is 15 m.
10GBASE-ZR/ZW	AA1403016-E6	1550 nm 80km SMF

Installing an SFP+

Before you begin

! **Important:**

Do not install an SFP+ transceiver in an SFP slot. The two transceivers look the same but function differently. Do not install an SFP+ transceiver in an XFP slot. You must ensure the slot is an SFP+ slot before installation.

- Verify that the SFP+ is the correct model for your network configuration.
- Before you install the optical connector, ensure it is clean.

⚠ Warning:**Risk of eye injury by laser**

Fiber optic equipment can emit laser or infrared light that can injure your eyes. Never look into an optical fiber or connector port. Always assume that fiber optic cables connect to a light source.

⚠ Electrostatic alert:**Risk of equipment damage**

To prevent damage from electrostatic discharge, always wear an antistatic wrist strap connected to an ESD jack.

⚠ Caution:**Risk of equipment damage**

Only trained personnel can install this product.

⚠ Caution:**Risk of equipment damage**

SFP+ transceivers are keyed to prevent incorrect insertion. If the SFP+ resists pressure, do not force it; turn it over, and reinsert it.

About this task

Install an SFP+ to provide a 10 Gb Ethernet interface between the device and other network devices.

Installing an SFP+ takes approximately three minutes.

Procedure

1. Remove the SFP+ transceiver from its protective packaging.
2. Grasp the SFP+ transceiver between your thumb and forefinger.
3. Insert the SFP+ transceiver into an SFP+ slot on the switch.
Apply a light pressure to the SFP+ transceiver until the device clicks and locks into position.
4. Remove the dust cover from the SFP+ optical bores and insert the fiber optic cable.

Job aid

Depending on the transceiver manufacturer, the SFP+ transceiver uses bail-latch type of locking and extractor mechanism.

The following figure shows typical mechanism used on SFP+ transceivers; other locking and extractor mechanisms exist. SFP+ transceivers are similar to SFPs in physical appearance. In the following figure, the SFP+ uses the bore plug. Pull the bail to release the device.

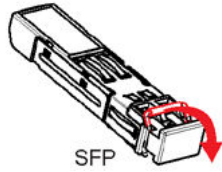

Removing an SFP+

About this task

Remove an SFP+ transceiver to replace it or to commission it elsewhere.

Warning:

Risk of eye injury by laser

Fiber optic equipment can emit laser or infrared light that can injure your eyes. Never look into an optical fiber or connector port. Always assume that fiber optic cables connect to a light source.

Electrostatic alert:

Risk of equipment damage

To prevent damage from electrostatic discharge, always wear an antistatic wrist strap connected to an ESD jack.

Procedure

1. Disconnect the network fiber optic cable from the SFP+ connector.
2. Affix dust covers over the fiber optic bore and connector.
3. Pull the swing-down latch handle and use it to extract the module.
4. Pull and slide the SFP+ transceiver out of the SFP+ slot.

If the SFP+ does not slide out easily from the slot, use a gentle side-to-side rocking motion while firmly pulling the SFP+ from the slot.

5. Store the SFP+ transceiver in a safe place until needed.

Important:

If you discard the SFP+ transceiver, dispose of it according to all national laws and regulations.

Chapter 6: 10 Gigabit small form factor pluggable transceivers

This section describes how to install and remove 10 gigabit small form factor pluggable (XFP) transceivers, and lists some technical specifications for the supported XFP models.

! **Important:**

Avaya recommends that you only use Avaya-qualified XFPs. If you do choose to use other vendor XFPs, be aware that Avaya does not support the use of other XFPs.

Selecting an XFP

Use an XFP transceiver to interface a device motherboard to a fiber optic cable. Select the appropriate transceiver to provide the required reach.

Procedure steps

1. Determine the required reach.

Depending on the product, XFPs are available for cable distances of up to 300 meters (m), 10 kilometers (km), 40 km, and 80 km.

2. Determine wavelength restrictions or requirements.
3. Use the following job aids to determine the appropriate XFP for your application.

Job aid

XFPs are hot-swappable input and output enhancement components designed for use with Avaya products to allow 10 gigabit Ethernet ports to link with other 10 gigabit Ethernet ports.

***** **Note:**

XFP transceivers are not compatible with SFP+ transceivers.

All Avaya XFPs use Lucent connectors (LC) to provide precision keying and low interface losses.

The following table lists and describes the Avaya XFP models. For more information about specifications for these XFPs, see [XFP specifications](#) on page 61. Not all products support all XFPs.

Model number	Product number	Description
10GBASE-SR	AA1403005-E5	850 nanometers (nm). The range is up to <ul style="list-style-type: none"> • 22 m using 62.5 micrometer (μm), 160 megaHertz times km (MHz-km) MMF • 33 m using 62.5 μm, 200 MHz-km MMF • 66 m using 62.5 μm, 500 MHz-km MMF • 82 m using 50 μm, 500 MHz-km MMF • 300 m using 50 μm, 2000 MHz-km MMF
10GBASE-ZR/ZW	AA1403006-E5	1550 nm SMF. The range is up to 80 km.
10GBASE-LR/LW	AA1403001-E5	1310 nm SMF. The range is up to 10 km.
10GBASE-LRM	AA1403007-E6	1310 nm. Up to 220 m reach over Fiber Distributed Data Interface (FDDI)-grade 62.5 μm multimode fiber. Suited for campus LANs.

Installing an XFP

Install an XFP to provide a 10 gigabit Ethernet interface between the switch and other network devices.

Installing an XFP takes approximately three minutes.

Prerequisites

- Verify that the XFP is the correct model for your network configuration.
- Before you install the optical connector, ensure it is clean.

Warning:

Risk of eye injury by laser

Fiber optic equipment can emit laser or infrared light that can injure your eyes. Never look into an optical fiber or connector port. Always assume that fiber optic cables are connected to a light source.

Electrostatic alert:

Risk of equipment damage

To prevent damage from electrostatic discharge, always wear an antistatic wrist strap connected to an ESD jack.

⚠ Caution:

Risk of equipment damage

Only trained personnel can install this product.

Procedure steps

⚠ Caution:

Risk of equipment damage

XFPs are keyed to prevent incorrect insertion. If the XFP resists pressure, do not force it; turn it over, and reinsert it.

1. Remove the XFP from its protective packaging.
2. Grasp the XFP between your thumb and forefinger.
3. Insert the XFP into the XFP slot on the module.

Apply a light pressure to the XFP until the device clicks and locks into position in the module.

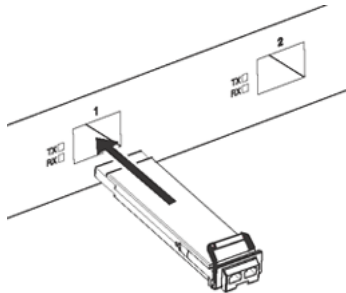

4. Remove the dust cover from the XFP optical bores and insert the fiber optic cable.

Job aid

Depending on the transceiver manufacturer, your XFP transceiver can have various types of locking and extractor mechanisms.

The following figure shows a typical bail-type mechanism used on XFP transceivers. Pull the bail down to release the device.

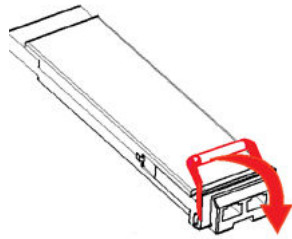

Removing an XFP

Remove an XFP to replace it or to commission it elsewhere.

Warning:

Risk of eye injury by laser

Fiber optic equipment can emit laser or infrared light that can injure your eyes. Never look into an optical fiber or connector port. Always assume that fiber optic cables are connected to a light source.

Electrostatic alert:

Risk of equipment damage

To prevent damage from electrostatic discharge, always wear an antistatic wrist strap connected to an ESD jack.

Procedure steps

1. Disconnect the network fiber cable from the XFP connector.
2. Affix a dust cover over the optical connector.
3. Pull the bail mechanism on the XFP to release the XFP.
4. Slide the XFP out of the module XFP slot.

If the XFP does not slide easily from the module slot, use a gentle side-to-side rocking motion while firmly pulling the XFP from the slot.

5. Replace the port dust cover or EMI plug in the module.
6. Store the XFP in a safe place until needed.

Important:

If you discard the XFP, be sure to dispose of it according to all national laws and regulations.

Chapter 7: SFP specifications

This section provides technical specifications for the supported small form factor pluggable (SFP) models. Use this information to aid in proper network design.

The specifications in this section meet or exceed those specified in the applicable IEEE standards, where they exist.

In these specifications, unless otherwise noted, receiver sensitivity is the minimum average input optical power for which the receiver is guaranteed to meet the bit error rate (BER) of 10^{-12} .

SFP labels

The Avaya label on a typical SFP contains an Avaya serial number, a bar code, a manufacturer code, an interface type, and a part number.

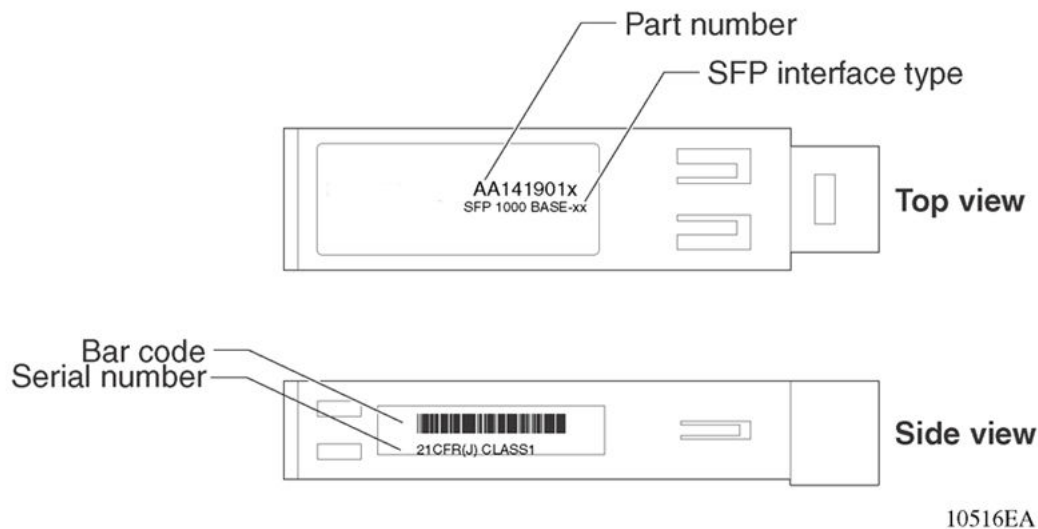

Figure 1: SFP label

General SFP specifications

The following table describes general SFP specifications.

Table 1: General SFP specifications

Parameter	Description
Dimensions (H x W x D)	13.4 x 8.50 x 56.4 millimeters (mm) 0.53 x 0.33 x 2.22 inches (in.) unless otherwise stated
Operating temperature	– 5 to 85C for RoHS -E6 models 0 to 60C for RoHS -E5 models
Storage temperature	– 40 to 85C
Maximum supply current	300 mA unless otherwise stated
Maximum power consumption	1.0 W unless otherwise stated

100BASE-FX SFP specifications

The 100BASE-FX SFP provides 100 Mb/s Ethernet Carrier Sense Multiple Access with Collision Detection (CSMA-CD) connectivity using multimode optical fiber. The part number for this model is AA1419074-E6

You can use this device with the 4826GTS, 4826GTS-PWR+, 4850GTS, and 4850GTS-PWR+ switch models.

*** Note:**

You cannot use a 100BASE-FX SFP on ERS 48xx SFP+ ports.

The following table describes the 100BASE-FX SFP specifications.

Table 2: 100BASE-FX SFP specifications

Parameter	Specifications
Maximum electrical power consumption	1.5 W
Connectors	Duplex LC (Lucent connector)
Cabling	<ul style="list-style-type: none"> • 62.5 µm MMF optic cable • 50 µm MMF optic cable
Distance	• Up to 2 km using 500 MHz-km MMF optic cable
Wavelength	1310 nm
Link optical power budget	10 dB
Transmitter characteristics	

Table continues...

Parameter	Specifications
Maximum launch power	– 14 dBm
Minimum launch power	– 23.5 to -20 dBm
Receiver characteristics	
Receiver sensitivity	– 33.5 dBm
Maximum input power	—

T1 SFP specifications

The T1 SFP provides full-duplex Fast Ethernet to T1 connectivity. The part number for this model is AA1419075-E6.

You can use this device with 4826GTS, 4826GTS-PWR+, 4850GTS, and 4850GTS-PWR+ switch models.

*** Note:**

You cannot use a T1 SFP on ERS 48xx SFP+ ports.

! Important:

The switch displays the interface speed of the T1/E1 SFP as a 100 Mb/s connection even though the interface is operating at the appropriate WAN speed. The system uses this value for STP path cost and MLT utilization.

! Important:

Avaya recommends that you enable egress traffic shaping on the port to 1.544 Mbps when using the T1 SFP to guarantee appropriate Quality of Service and traffic prioritization.

The following table describes the T1 SFP specifications.

Table 3: Fast Ethernet to T1 remote bridge specifications

Parameter	Specifications
Maximum power consumption	1 W
Dimensions	Height: 13.8 mm (0.54 in) Width: 15.8 mm (0.62 in) Depth: 75.9 mm (2.99 in)
Standards	Compliant with G.703, G.775, G.823, T1.403, IEEE 802.3
Connectors	RJ-48C
Cabling	CAT5 with RJ-48C pin connection
Distance	Up to 2874 m over 22 AWG cable. You can reduce the distance when you use common 24 AWG UTP CAT5/5E cable.

Table continues...

Parameter	Specifications
Line code	Binary 8 Zero Substitution (B8ZS) or Alternate Mark Inversion (AMI)

The T1 SFP uses an RJ-48C connector (see the following figure), which is similar to an RJ-45 connection, but with different pinouts.

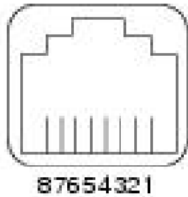

The following table describes the RJ-48C pinouts.

Table 4: RJ-48C pinouts

Pin	Description
1	Receive ring
2	Receive tip
3	Receive shield
4	Transmit ring
5	Transmit tip
6	Transmit shield
7	Not used
8	Not used

The T1 equipment at the far end of the T1 connection must also use an RJ-48C jack. After you determine the pinout of the RJ-48C jack at the far end, determine if you need a straight-through or crossover cable. You can use an off-the-shelf straight-through cable to directly connect the T1 SFP module and the far-end T1 equipment if the far end has the pinout shown in the following table.

Table 5: RJ-48C pinouts (opposite Tx and Rx connection)

Pin	Description
1	Transmit (Tx) ring
2	Transmit tip
3	Transmit shield
4	Receive (Rx) ring
5	Receive tip
6	Receive shield
7	Not used
8	Not used

If the far end connection does not match the connections shown in this table ([Table 5: RJ-48C pinouts \(opposite Tx and Rx connection\)](#) on page 36), then you must use a crossover cable. The following table shows the crossover connections.

Table 6: RJ-48C crossover cable connections

Terminal A		Terminal B	
Pin	Description	Pin	Description
1	Receive ring	1	Transmit ring
2	Receive tip	2	Transmit tip
3	Receive shield	3	Transmit shield
4	Transmit ring	4	Receive ring
5	Transmit tip	5	Receive tip
6	Transmit shield	6	Receive shield
7	Not used	7	Not used
8	Not used	8	Not used

You can use a short crossover cable with a straight-through cable adapter to connect to a straight-through cable. Do this to convert a straight-through cable to a crossover cable.

T1 SFP—default settings

The switches automatically configure the following T1 SFP parameters after the system powers up:

- Transmit Line Build Out (TLBO): set according to cable length.
- Framed or Unframed: Insert framing word into the frame (1 bit for each T1 frame) or do not insert framing word into the frame.
- Line code: Binary 8 Zero Substitution (B8ZS) or Alternate Mark Inversion (AMI).
- Clock: Use Rx clock or internal clock for Tx clock (Avaya recommends internal clock for Tx clock).
- Framing: D4 or Extended Super Frame (ESF), depends on the framing word required by the T1 equipment at the far end.

Table 7: T1 SFP—default parameters

Parameter	Default setting
TLBO	0 (0 ft–133 ft)
Framed or unframed	1 (framed)
Line code	0 (B8ZS)
Tx clock source	1 (Tx clock)

Table continues...

Parameter	Default setting
Framing	1 (ESF)
Rx sensitivity	1 (limited long haul)
Yellow alarm	0 (normal operation)
Fault propagation	0 (normal operation)
Tx disabled behavior	2 (Alarm Indications Signal—AIS)
Transmit AIS	0 (normal operation)

! Important:

You must configure the T1 SFP module to match the parameters of the T1 equipment at the far end. If you must change the parameters, contact Avaya Technical Support.

1000BASE-T SFP specifications

The 1000BASE-T SFP provides gigabit Ethernet connectivity using a single eight-pin RJ-45 connector. The 1000BASE-T SFP model AA1419043-E6 operates at 1 Gbps.

*** Note:**

AA1419043-E6 operates at 1 Gbps, and can support 100 Mbps in the following units:

- ERS 4826GTS
- ERS 4826GTS-PWR+
- ERS 4850GTS
- ERS 4850GTS-PWR+

! Important:

Avaya recommends setting all 1000BaseT ports to auto-negotiate in accordance with the IEEE 802.3ab standard. By default, SFPs inserted into certain product-specific modules are set for autonegotiation = True.

The maximum current requirement of the SFP is 375 milliamperes (mA) at 5 volts (V).

The following table describes the 1000BASE-T SFP specifications.

Table 8: IEEE 802.3z 1000BASE-T SFP specifications

Parameter	Specifications
Standards	IEEE 802.3z, IEEE 802.3ab
Connectors	RJ-45
Cabling	CAT5E or better UTP
Distance	Up to 100 m

1000BASE-SX (LC) SFP specifications

The 1000BASE-SX SFP provides 1000BASE-SX gigabit Ethernet connectivity at 850 nm using multimode optical fiber. This SFP supports full-duplex operation only. The part number for this model is AA1419013-E5.

The following table describes standards, connectors, cabling, and distance for the 1000BASE-SX SFP.

Table 9: IEEE 802.3z 1000BASE-SX (LC) SFP specifications

Parameter	Specifications
Connectors	Duplex LC
Cabling	<ul style="list-style-type: none"> • 62.5 μm MMF optic cable • 50 μm MMF optic cable
Distance	<ul style="list-style-type: none"> • up to 275 m using 62.5 μm MMF optic cable • up to 550 m using 50 μm MMF optic cable
Wavelength	850 nanometers (nm)
Link optical power budget	7.0 deciBels (dB)
Transmitter characteristics	
Launch power	-10 to -4.0 deciBels referenced to 1 milliwatt (dBm)
Receiver characteristics	
Receiver sensitivity	-17 dBm
Maximum input power	0 dBm

1000BASE-SX (MT-RJ) SFP specifications

The 1000BASE-SX (MT-RJ type) SFP provides gigabit Ethernet connectivity using MT-RJ multimode fiber connectors. The following table describes standards, connectors, cabling, and distance for the 1000BASE-SX (MT-RJ type) SFP. The part number for this model is AA1419014-E5.

Table 10: IEEE 802.3z 1000BASE-SX (MT-RJ) SFP specifications

Parameter	Specifications
Connectors	Duplex MT-RJ
Cabling	<ul style="list-style-type: none"> • 62.5 μm MMF optic cable • 50 μm MMF optic cable
Distance	<ul style="list-style-type: none"> • up to 275 m using 62.5 μm MMF optic cable

Table continues...

Parameter	Specifications
	• up to 550 m using 50 μ m MMF optic cable
Wavelength	850 nm
Link optical power budget	7.0 dB
Transmitter characteristics	
Launch power	– 10 to – 4.0 dBm
Receiver characteristics	
Receiver sensitivity	– 17 dBm
Maximum input power	0 dBm

1000BASE-LX SFP specifications

The 1000BASE-LX SFP provides 1000BASE-LX gigabit Ethernet connectivity at 1310 nanometers (nm) using single mode or multimode optical fiber. The 1000BASE-LX SFP supports full-duplex operation only. The part number for this model is AA1419015-E5.

The following table describes standards, connectors, cabling, and distance for the 1000BASE-LX SFP.

Table 11: IEEE 802.3z 1000BASE-LX SFP specifications

Parameter	Specifications
Connectors	Duplex LC
Cabling	<ul style="list-style-type: none"> • 50 micrometer (μm) multimode fiber (MMF) • 62.5 μm multimode fiber • 9 μm single mode fiber (SMF)
Distance	<ul style="list-style-type: none"> • Up to 550 meters (m) using MMF • Up to 10 kilometers (km) using SMF
Wavelength	1310 nm
Link optical power budget	10.5 dB
Transmitter characteristics	
Launch power	– 9.5 to – 3.0 dBm
Receiver characteristics	
Receiver sensitivity	– 20 dBm
Maximum input power	– 3.0 dBm

1000BASE-XD CWDM SFP specifications

The 1000BASE-XD SFPs provides CWDM gigabit Ethernet connectivity using single mode fiber. These SFPs support full-duplex operation only. The part numbers of the 40 km models range from AA1419025-E5 to AA1419032-E5.

! **Important:**

For the 40 km CWDM SFPs, a minimum attenuation of 4 dB must be present between the transmitter and receiver. To avoid receiver saturation, you must insert a minimum attenuation of 4 dB when you test the CWDM SFP in loopback mode, or use short runs of fiber with no intermediate CWDM OADM or CWDM OMUX.

Table 12: 1000BASE-XD CWDM (40 km) SFP specifications

Parameter	Specifications
Connectors	Duplex LC
Cabling	SMF, 9 μ m
Data rate	1.0 Gb/s
Line rate (8B/10B code)	1.25 Gb/s
Operating temperature range	0 to 60C
Link optical power budget	17 dB
Transmitter characteristics	
Launch power	- 4.0 to 1.0 dBm
Receiver characteristics	
Receiver sensitivity	- 21 dBm
Maximum input power	- 3.0 dBm

1000BASE-ZX CWDM SFP specifications

The 1000BASE-ZX SFPs provides CWDM gigabit Ethernet connectivity using single mode fiber. These SFPs support full-duplex operation only. The part numbers of the 70 km models range from AA1419033-E5 to AA1419040-E5.

! **Important:**

For the 70 km CWDM SFPs, a minimum attenuation of 10 dB must be present between the transmitter and receiver.

Table 13: 1000BASE-ZX CWDM (70 km) SFP specifications

Parameter	Specifications
Connectors	Duplex LC
Cabling	SMF, 9 µm
Data rate	1.0 Gb/s
Line rate (8B/10B code)	1.25 Gb/s
Operating temperature range	0 to 60C
Link optical power budget	20 dB
Transmitter characteristics	
Launch power	– 3.0 to 2.0 dBm
Receiver characteristics	
Receiver sensitivity	– 23 dBm
Maximum input power	– 3.0 dBm

1000BASE-SX DDI SFP specifications

The following table describes the 1000BASE-SX DDI SFP, which has a reach of up to 550 m using 50 µm MMF, and of 275 m using 62.5 µm MMF. This SFP operates at 850 nm. The part number of this SFP is AA1419048-E6.

Table 14: 1000BASE-SX SFP DDI (550 m) specifications

Parameter	Specifications
Maximum electrical power consumption	1 watt (W)
Connector	Duplex LC
Cabling	MMF
Data rate	1.0 Gb/s
Line rate (8B/10B code)	1.25 Gb/s
Link optical power budget	7.5 dB
Transmitter characteristics	
Launch power	– 9.5 to -4.0 dBm
Receiver characteristics	
Receiver sensitivity	– 17 dBm
Maximum receiver power	0 dBm

1000BASE-LX DDI SFP specifications

This SFP provides 1000BASE-LX gigabit Ethernet connectivity at 1310 nanometers (nm) using single mode or multimode optical fiber. The part number of this SFP is AA1419049-E6.

Table 15: 1000BASE-LX DDI SFP specifications

Parameter	Specifications
Maximum electrical power consumption	1.0 watt (W)
Connectors	Duplex LC
Cabling	<ul style="list-style-type: none"> • 50 micrometer (μm) multimode fiber (MMF) • 62.5 μm multimode fiber • 9 μm single mode fiber (SMF)
Distance	<ul style="list-style-type: none"> • Up to 550 meters (m) using MMF • Up to 10 kilometers (km) using SMF
Data rate	1.0 Gb/s
Line rate (8B/10B code)	1.25 Gb/s
Link optical power budget	9.5 dB
Transmitter characteristics	
Launch power	- 9.5 to -3.0 dBm
Receiver characteristics	
Receiver sensitivity	- 19.0 dBm
Maximum receiver power	- 3.0 dBm

1000BASE-XD DDI 1310 nm SFP specifications

The following table describes the 1000BASE-XD DDI SFP. This SFP operates at 1310 nm and has a reach of up to 40 km. The part number is AA1419050-E6.

Table 16: 1000BASE-XD DDI 1310 nm SFP specifications

Parameter	Specifications
Maximum electrical power consumption	1.0 W
Connectors	Duplex LC
Cabling	SMF, 9 μm
Data rate	1.0 Gb/s
Line rate (8B/10B) code	1.25 Gb/s

Table continues...

Parameter	Specifications
Link optical power budget	18 dB
Transmitter characteristics	
Launch power	– 4.5 to 0 dBm
Receiver characteristics	
Receiver sensitivity	– 22.5 dBm
Maximum receiver power	0 dBm

1000BASE-XD DDI 1550 nm SFP specifications

The following table describes the 1000BASE-XD DDI SFP. This SFP operates at 1550 nm and has a reach of up to 40 km. The part number is AA1419051-E6.

 **Caution:**

Risk of equipment damage

To prevent damage to the optical receiver, ensure that at least 3 dB of attenuation is present between the transmit and receive ports.

Table 17: 1000BASE-XD DDI 1550 nm SFP specifications

Parameter	Specification
Maximum electrical power consumption	1.0 W
Connectors	Duplex LC
Cabling	SMF, 9 µm
Data rate	1.0 Gb/s
Line rate (8B/10B code)	1.25 Gb/s
Link optical power budget	22 dB
Maximum dispersion power penalty	2 dB at 40 km
Transmitter characteristics	
Launch power	– 2.0 to 3.0 dBm
Receiver characteristics	
Receiver sensitivity	– 24 dBm
Maximum receiver power	0 dBm

1000BASE-ZX DDI SFP specifications

The following table describes the 1000BASE-ZX DDI SFP. This SFP operates at 1550 nm and has a reach of up to 70 km. The part number is AA1419052-E6.

 **Caution:**

Risk of equipment damage

To prevent damage to the optical receiver, ensure that at least 5 dB of attenuation is present between the transmit and receive ports.

Table 18: 1000BASE-ZX DDI 1550 nm SFP specifications

Parameter	Specifications
Maximum electrical power consumption	1.0 W
Connectors	Duplex LC
Cabling	SMF, 9 μm
Data rate	1.0 Gb/s
Line rate (8B/10B code)	1.25 Gb/s
Link optical power budget	24 dB
Maximum dispersion power penalty	2 dB at 70 km
Transmitter characteristics	
Launch power	0 to 5 dBm
Receiver characteristics	
Receiver sensitivity	- 24 dBm
Maximum receiver power	- 0 dBm

1000BASE-XD DDI CWDM SFP specifications

The following table describes specifications for 1000BASE-XD DDI CWDM SFPs numbered AA1419053-E6 to AA1419060-E6.

 **Caution:**

Risk of equipment damage

To prevent damage to the optical receiver, ensure that at least 4 dB of attenuation is present between the transmit and receive ports.

Table 19: 1000BASE-XD CWDM SFP DDI (40 km) specifications

Parameter	Specifications
Maximum electrical power consumption	1.0 W
Connectors	Duplex LC
Cabling	SMF, 9 µm
Data rate	1.0 Gb/s
Line rate (8B/10B code)	1.25 Gb/s
Link optical power budget	17 dB
Maximum dispersion power penalty	1 dB at 40 km
Transmitter characteristics	
Launch power	– 4.0 to 1.0 dBm
Receiver characteristics	
Receiver sensitivity	– 21 dBm
Maximum receiver power	– 3.0 dBm

1000BASE-ZX DDI CWDM SFP specifications

The following table describes specifications for CWDM SFPs numbered AA1419061-E6 to AA1419068-E6.

 **Caution:**

Risk of equipment damage

To prevent damage to the optical receiver, ensure that at least 8 dB of attenuation is present between the transmit and receive ports.

Table 20: 1000BASE-ZX CWDM SFP DDI (70 km) specifications

Parameter	Specifications
Maximum electrical power consumption	1.0 W
Connectors	Duplex LC
Cabling	SMF, 9 µm
Data rate	1.0 Gb/s
Line rate (8B/10B code)	1.25 Gb/s
Link optical power budget	24 dB
Maximum dispersion power penalty	2 dB at 70 km
Transmitter characteristics	

Table continues...

Parameter	Specifications
Launch power	0 to 5.0 dBm
Receiver characteristics	
Receiver sensitivity	- 24 dBm
Maximum receiver power	- 3.0 dBm

1000BASE-BX10 DDI SFP specifications

The 1000BASE-BX bidirectional SFPs (part numbers AA1419069-E6 and AA1419070-E6) provide gigabit Ethernet connectivity over a single fiber.

The following figure shows an example of a 1000BASE-BX10 SFP pair. The appearance of the connector can vary in shape and latch color.

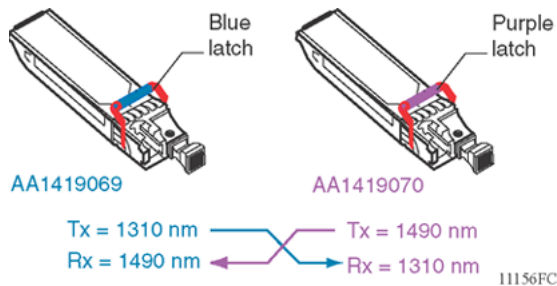

Figure 2: 1000BASE-BX

As shown in the previous figure, the transmit (Tx) and receive (Rx) paths share the same fiber by using two different wavelengths. One model transmits at 1310 nm and receives at 1490 nm, while the mating model transmits at 1490 nm and receives at 1310 nm. You can only connect a mating pair.

You can use 1000BASE-BX SFPs to double the number of your fiber links. For example, if you install 20 fiber pairs with 20 conventional ports connected, you can use 1000BASE-BX SFPs to expand to 40 ports, using the same fiber.

The long wavelength optical transceivers used in these models provide variable distance ranges using single mode fiber optic cabling.

The following table describes standards, connectors, cabling, and distances for the 1000BASE-BX SFP.

Table 21: IEEE 802.3ah 1000BASE-BX10 SFP specifications

Parameter	Specifications
Connectors	Single-fiber LC
Data rate	1.0 Gb/s

Table continues...

Parameter	Specifications
Line rate (8B/10B code)	1.25 Gb/s
Distance	Up to 10 km
Wavelength	1310 nm and 1490 nm
Link optical power budget	11.0 dB
Maximum transmitter and dispersion power penalty	3.3 dB
Transmitter characteristics	
Maximum launch power	– 3.0 dBm
Minimum launch power	– 9.0 dBm
Receiver characteristics	
Maximum receiver sensitivity	– 19.5 dBm
Maximum input power (maximum average receive power)	– 3.0 dBm

1000BASE-BX40 DDI SFP specifications

The 1000BASE-BX bidirectional SFPs (part numbers AA1419076-E6 and AA1419077-E6) provide gigabit Ethernet connectivity over a single fiber.

The transmit and receive paths share the same fiber by using two different wavelengths. One model transmits at 1310 nm and receives at 1490 nm, while the mating model transmits at 1490 nm and receives at 1310 nm. You can only connect a mating pair.

You can use 1000BASE-BX SFPs to double the number of your fiber links. For example, if you have 20 installed fiber pairs with 20 conventional ports connected, you can use 1000BASE-BX SFPs to expand to 40 ports, using the same fiber.

The long wavelength optical transceivers used in these models provide variable distance ranges using single mode fiber optic cabling.

The 1000BASE-BX SFPs (part numbers AA1419076-E6 and AA1419077-E6) can attain a reach of up to 40 km.

The following table describes standards, connectors, cabling, and distances for the 1000BASE-BX40 SFP.

Caution:

Risk of equipment damage

Connect 1000BASE-BX SFP AA1419076-E6 to 1000BASE-BX SFP AA1419077-E6 using a single mode fiber with at least 6 dB of attenuation. Damage can result if insufficient attenuation is provided or if the same 1000-BASE-BX SFPs are connected.

Table 22: IEEE 802.3ah 1000BASE-BX40 SFP specifications

Parameter	Specifications
Connectors	Single-fiber LC
Data rate	1.0 Gb/s
Line rate (8B/10B code)	1.25 Gb/s
Distance	Up to 40 km with SMF
Wavelength	1310 nm and 1490 nm
Link optical power budget	20.0 dB
Maximum transmitter and dispersion power penalty	3.3 dB
Transmitter characteristics	
Maximum launch power	3.0 dBm
Minimum launch power	– 3.0 dBm
Receiver characteristics	
Maximum receiver sensitivity	– 23 dBm
Maximum input power (maximum average receive power)	– 3.0 dBm

1000BASE-EX DDI SFP specifications

The following table describes the 1000BASE-EX DDI SFP. This SFP operates at 1550 nm and has a reach of up to 120 km. The part number of this SFP is AA1419071-E6.

 **Caution:**

Risk of equipment damage

To prevent damage to the optical receiver, ensure that at least 14 dB of attenuation is present between the transmit and receive ports.

To attain the BER of 10^{-12} , the minimum attenuation between the transmit and receive ports is 15 dB.

Table 23: 1000BASE-EX DDI SFP specifications

Parameter	Specifications
Maximum electrical power consumption	1.2 W
Connectors	Duplex LC
Cabling	SMF, 9 µm
Data rate	1.0 Gb/s
Line rate (8B/10B code)	1.25 Gb/s

Table continues...

SFP specifications

Parameter	Specifications
Link optical power budget	30 dB
Maximum dispersion power penalty	2.0 dB at 120 km
Transmitter characteristics	
Launch power	0 to 5.0 dBm
Receiver characteristics	
Receiver sensitivity	– 30 dBm
Maximum receiver power	– 9.0 dBm

Chapter 8: SFP+ specifications

This section provides technical specifications for the supported 10 gigabit SFP+ models. Use these specifications to aid in network design.

The specifications in this section are a subset of the IEEE 802.3ae, 802.3aq, and 802.3ak specifications. For more information, see these standards documents. All Avaya SFP+ transceivers meet or exceed these standards.

! Important:

Avaya recommends that you only use Avaya qualified transceivers. If you do choose to use other vendor transceivers, Avaya does not support them.

SFP+ labels

The typical Avaya SFP+ has a label on the top and bottom or side of the transceiver. The following figures show example labels. Avaya does use alternate labels, depending on the size of the device and space available for label information.

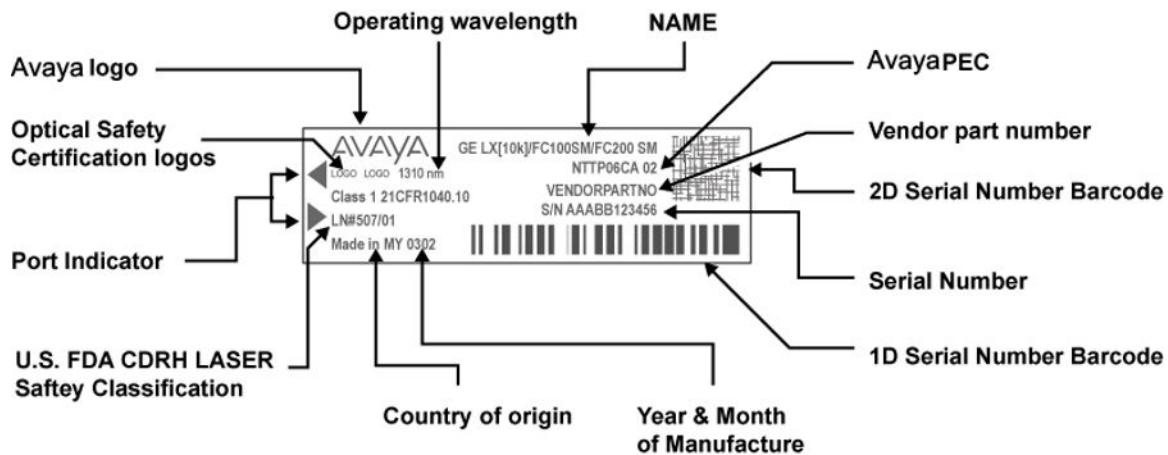

Figure 3: SFP+ top label



Figure 4: SFP+ bottom label

General SFP+ specifications

The following table describes general SFP+ specifications.

Table 24: General SFP+ specifications

Parameter	Specifications
Dimensions (H x W x D)	13.4 x 8.50 x 56.4 millimeters (mm) 0.53 x 0.33 x 2.22 inches (in.) unless otherwise stated
Connectors	LC ultra physical contact (UPC)
Storage temperature	−40 to 85C
Operating temperature	0 to 60C for RoHS -E5 models − 5 to 85C for RoHS -E6 models

SFP+ transceiver specifications

The following sections provide specifications for supported SFP+ transceivers:

- [10GBASE-SR/SW SFP+ specifications](#) on page 52
- [10GBASE-LRM SFP+ specifications](#) on page 54
- [10GBASE-LR/LW SFP+ specifications](#) on page 56
- [10GBASE-ER/EW SFP+ specifications](#) on page 57
- [10GBASE-CX specifications](#) on page 58
- [10GBASE-ZR/ZW SFP+ specifications](#) on page 58

10GBASE-SR/SW SFP+ specifications

The 10GBASE-SR/SR SFP+ provides 10 GbE service at 850 nm.

The following table lists the specifications for the 10GBASE-SR/SW SFP+. The part number of this SFP+ is AA1403015-E6.

For more information about the 10GBASE-SR/SW SFP+, including test and measurement information, see the IEEE 802.3ae standard.

Caution:

Risk of equipment damage

To prevent damage to the optical receiver, ensure that at least 1 dB of attenuation exists between the transmit and receive ports.

Table 25: IEEE 802.3ae 10GBASE-SR/SW SFP+ specifications

Parameter	Specifications
Data rate	10.0 Gb/s
Line rate (64B/66B code)	10.3125 gigabits per second (Gb/s) \pm 100 parts per million (ppm)
Mean Time Between Failures (MTBF)	675 000 hours
Center wavelength range	840 to 860 nanometers (nm), nominal 850 nm
Distance	Using 62.5 μ m MMF optic cable: <ul style="list-style-type: none"> • 160 MHz-km fiber: 2 to 26 m • 200 MHz-km fiber: 2 to 33 m Using 50 μ m MMF optic cable: <ul style="list-style-type: none"> • 400 MHz-km fiber: 2 to 66 m • 500 MHz-km fiber: 2 to 82 m • 2000 MHz-km fiber: 2 to 300 m • 4700 MHz-km fiber (OM4): 2 to 400 m
Link optical power budget	7.3 dB
Maximum transmitter and dispersion penalty	3.9 dB at 300 m
Transmitter characteristics	
Root-mean-square spectral width	0.05 to 0.40 nm
Launch power	– 7.3 to – 1.0 decibels referenced to 1 milliwatt (dBm)
Maximum average launch power of OFF transmitter	– 30 dBm
Minimum extinction ratio	3.0 dB
Maximum relative intensity noise $_{12}$ OMA	– 128 dB per Hertz (dB/Hz)
Maximum optical return loss tolerance	– 12 dB
Receiver characteristics	
Average receive power for BER 10^{-12}	– 9.9 to – 1.0 dBm
Maximum average receive power for damage	0 dBm
Maximum receiver sensitivity in OMA	– 11.1 dBm
Maximum receiver reflectance	– 12 dB
Stressed receiver sensitivity in OMA	– 7.5 dBm
Receiver electrical 3 dB upper cutoff frequency	12.3 gigaHertz (GHz)

The stressed sensitivity values are for system level BER measurements, which include the effects of clock and data recovery (CDR) circuits. Avaya recommends that you allocate at least 0.4 dB additional margin if you make component level measurements without the effect of CDR circuits.

10GBASE-LRM SFP+ specifications

The 10GBASE-LRM SFP+ provides 10 GbE service at a wavelength of 1310 nm. This SFP+ can attain a reach of up to 220 m on 62.5 μ m multimode fiber. This SFP+ provides built-in electronic dispersion compensation.

The following table lists the transmitter and receiver specifications for the 10GBASE-LRM SFP+. These parameters meet the IEEE 802.3aq-2006 standard. The part number of this SFP+ is AA1403017-E6.

In this table, the OMA, average launch power, and peak power specifications apply at TP2, after accounting for patch cord loss.

Table 26: IEEE 802.3aq 10GBASE-LRM SFP+ specifications

Parameter	Specifications
Data rate	10.0 Gb/s
Line rate (64B/66B code)	10.3125 Gb/s \pm 100 ppm
Center wavelength range	1260 to 1355 nm; 1310 nm nominal
Distance	Up to 220 m
Link optical power budget	1.7 to 1.9 dB
Maximum transmitter waveform and dispersion penalty (TWDP)	4.7 dB
Transmitter characteristics	
Average launch power	– 6.5 to 0.5 dBm
Peak launch power	3 dBm
Root-mean-square spectral width	2.4 to 4 nm
Launch power in OMA	– 4.5 to 1.5 dBm
Maximum average launch power of OFF transmitter	– 30 dBm
Minimum extinction ratio	3.5 dB
Maximum relative intensity noise at OMA— RIN _{12OMA}	– 128 dB/Hz
Optical return loss tolerance (minimum)	– 20 dB
Receiver characteristics	
Maximum receive average power for damage	1.5 dBm
Receiver reflectance (maximum)	– 12 dB

For more information about the conditions used for the stressed receiver tests, and other information, see the IEEE 802.3aq standard.

The following table (from IEEE 802.3aq) describes the maximum channel insertion loss. The channel insertion loss includes both attenuation and connector loss (1.5 dB); therefore the maximum fiber attenuation is 0.2 to 0.4 dB.

Table 27: 10GBASE-LRM channel insertion loss and range

Fiber type (core diameter and OFL bandwidth)	Range	Maximum channel insertion loss
62.5 μm (FDDI grade) <ul style="list-style-type: none"> • 160 MHz-km at 850 nm • 500 MHz-km at 1300 nm 	Up to 220 m	1.9 dB
62.5 μm (ISO/IEC OM1) <ul style="list-style-type: none"> • 200 MHz-km at 850 nm • 500 MHz-km at 1300 nm 	Up to 220 m	1.9 dB
50 μm (ISO/IEC OM2) <ul style="list-style-type: none"> • 500 MHz-km at 850 nm • 500 MHz-km at 1300 nm 	Up to 220 m	1.9 dB
50 μm <ul style="list-style-type: none"> • 400 MHz-km at 850 nm • 400 MHz-km at 1300 nm 	Up to 100 m	1.7 dB
50 μm (ISO/IEC OM3) <ul style="list-style-type: none"> • 1500 MHz-km at 850 nm (includes laser launch bandwidth) • 500 MHz-km at 1300 nm (includes laser launch bandwidth) 	Up to 220 m	1.9 dB
50 μm (ISO/IEC OM4) <ul style="list-style-type: none"> • 3500 MHz-km at 850 nm (includes laser launch bandwidth) • 500 MHz-km at 1300 nm (includes laser launch bandwidth) 	Up to 220 m	1.9 dB

In the table, FDDI denotes Fiber Distributed Data Interface, ISO denotes International Standards Organization, IEC denotes International Electrotechnical Commission, and OFL denotes Over Filled Launch.

The following table uses the 802.3aq standard and specifies the measurement conditions for each fiber type.

Table 28: Launch conditions for each fiber type

Parameter	Minimum encircled flux	Notes
Optical launch for OM1 and FDDI-grade fiber	<ul style="list-style-type: none"> • 30% within 5 μm radius • 81% within 11 μm radius 	Uses 62.5 μm mode conditioning patch cord
Optical launch for OM2 and 50 μm 400/400 fiber	<ul style="list-style-type: none"> • 30% within 5 μm radius 	Uses 50 μm mode conditioning patch cord

Table continues...

Parameter	Minimum encircled flux	Notes
	<ul style="list-style-type: none"> • 81% within 11 μm radius 	
Optical launch for OM3 and 50 μm fiber	<ul style="list-style-type: none"> • 30% within 5 μm radius • 81% within 11 μm radius 	—
Optical launch for OM4 and 50 μm fiber	<ul style="list-style-type: none"> • 30% within 5 μm radius • 81% within 11 μm radius 	—

10GBASE-LR/LW SFP+ specifications

The 10GBASE-LR/LW SFP+ provides 10 GbE or OC-192 service at a nominal wavelength of 1310 nm. This SFP+ can attain link lengths of up to 10 km.

The following table lists the transmitter and receiver specifications for the 10GBASE-LR/LW SFP+. The part number of this SFP+ is AA1403011-E6.

For more information about the 10GBASE-LR/LW SFP+, including test and measurement information, see the IEEE 802.3ae standard.

Table 29: IEEE 802.3ae 10GBASE-LR/LW SFP+ specifications

Parameter	Specifications
Center wavelength range	1260 to 1355 nm; 1310 nm nominal
Distance	Up to 10 km
Link optical power budget	9.4 dB
Maximum transmitter and dispersion penalty	3.2 dB at 10 km
Transmitter characteristics	
Line rate (nominal)	10GBASE-LR 10.3125 Gb/s \pm 100 ppm (10 GbE)
Average launch power	– 8.2 to 0.5 dBm
Minimum side mode suppression ratio	30 dB
Minimum launch power in OMA minus transmission and dispersion penalty (TDP)	– 6.2 dBm
Minimum optical modulation amplitude	– 5.2 dBm
Maximum average launch power of OFF transmitter ^c	– 30 dBm
Minimum extinction ratio	3.5 dB
RIN _{12OMA} (maximum)	– 128 dB/Hz
Maximum optical return loss tolerance	– 12 dB
Maximum transmitter reflectance	– 12 dB
Receiver characteristics	
Line rate (nominal)	10GBASE-LR 10.3125 Gb/s \pm 100 ppm (10 GbE)
Average receive power for BER 10 ⁻¹²	– 14.4 dBm to 0.5 dBm
Maximum average receive power for damage	1.5 dBm

Table continues...

Parameter	Specifications
Maximum receiver sensitivity in OMA	– 12.6 dBm
Maximum receiver reflectance	– 12 dB
Stressed receiver sensitivity in OMA	– 10.3 dBm
Receiver electrical 3 dB upper cutoff frequency	12.3 GHz

Examples of an OFF transmitter are as follows: no power supplied to the PDM, laser shutdown for safety conditions, activation of a PMD_global_transmit_disable or other optional transmitter shut down condition

10GBASE-ER/EW SFP+ specifications

The following table lists the transmitter and receiver specifications for the 10GBASE-ER/EW SFP+. The reach for this SFP+ is up to 40 km at a wavelength of 1550 nm. The part number of this SFP+ is AA1403013-E6.

For more information about the 10GBASE-ER/EW SFP+, including test and measurement information and more specifications, see the IEEE 802.3ae standard.

Table 30: IEEE 802.3ae 10GBASE-ER/EW SFP+ specifications

Parameter	Specifications
Line rate (nominal)	10GBASE-ER 10.3125 Gb/s \pm 100 ppm (10 GbE)
Center wavelength range	1530 to 1565 nm; nominal 1550 nm
Distance	Up to 40 km
Link optical power budget	15 dB
Transmitter and dispersion power penalty	3.0 dB at 40 km
Transmitter characteristics	
Launch power	– 4.7 to 4.0 dBm
Minimum side mode suppression ratio	30 dB
Minimum launch power in OMA minus transmission and dispersion penalty (TDP)	– 2.1 dBm
Minimum optical modulation amplitude	– 1.7 dBm
Maximum average launch power of OFF transmitter	– 30 dBm
Minimum extinction ratio	3.0 dB
Maximum RIN_{12OMA}	– 128 dB/Hz
Maximum optical return loss tolerance	– 21 dB
Receiver characteristics	
Average receive power for BER 10^{-12}	– 15.8 dBm to – 1.0 dBm
Maximum receive power for damage	4.0 dBm
Maximum receiver sensitivity in OMA	– 14.1 dBm
Maximum receiver reflectance	– 26 dB

Table continues...

Parameter	Specifications
Stressed receiver sensitivity in OMA	– 11.3 dBm
Receive electrical 3 dB upper cutoff frequency (maximum)	12.3 GHz

Examples of an OFF transmitter are as follows: no power supplied to the PDM, laser shutdown for safety conditions, activation of a PMD_global_transmit_disable or other optional transmitter shut down conditions.

10GBASE-CX specifications

The 10GBASE-CX is a 4-pair twinaxial copper cable that plugs into the SFP+ socket and connects two 10 Gb ports. The reach for this cable is up to 15 m with a bit error rate (BER) better than 10^{-12} . The signaling speed for each lane is 3.125 Gb/s \pm 100 ppm. The 10GBASE-CX is a lower cost alternative to the optical SFP+ devices.

For more information about the 10GBASE-CX, including test and measurement information and more specifications, see the IEEE 802.3ak standard. The following table identifies the part numbers for specific cable lengths.

Table 31: 10GBASE-CX cables

Cable length	Part number
3 meter	AA1403019-E6
5 meter	AA1403020-E6
10 meter	AA1403018-E6
15 meter	AA1403021-E6

10GBASE-ZR/ZW SFP+ specifications

The following table lists the transmit and receive specifications for the 10GBASE-ZR/ZW SFP+. The reach for this SFP+ is up to 80 km* at a wavelength of 1550 nm. The part number of this SFP+ is AA1403016–E6.

 **Caution:**

Risk of BER increase

For proper SFP+ operation, ensure that at least 11 dB of attenuation is present between the transmit and receive ports.

Table 32: 10GBASE-ZR/ZW SFP+ specifications

Parameter	Specifications
Line rate (nominal)	10GBASE-ZR 10.3125 Gb/s \pm 100 ppm (10GbE)
Distance	Up to 80 km*
Link optical power budget	24 dB
Dispersion power penalty	3.0 dB at 80 km (G.652 fiber)

Table continues...

Parameter	Specifications
Transmitter characteristics	
Center wavelength range	1530 nm to 1565 nm, nominal 1550 nm
Side mode suppression ratio (minimum)	30 dB
Average launch power	0 to 4.0 dBm
Optical modulation amplitude (minimum)	+1.7 dBm
Average launch power of OFF transmitter (maximum)	-30 dBm
Extinction ratio (ER) (minimum)	8.2 dB
RIN12OMA (maximum)	-128 dB/Hz
Maximum transmitter reflectance	-12 dB
Receiver specifications	
Wavelength range	1280 to 1575 nm. Sensitivity specified for 1530 to 1565 nm.
Maximum receiver sensitivity (average power)	-24 dBm
Maximum receiver (average) power, BER 10 ¹²	-7.0 dBm
Receiver damage threshold (average power)	+5.0 dBm
Receiver reflectance (maximum)	-27 dB

* Achievable link distance is primarily dependent on cable plant insertion loss. 80 km is not possible in some situations.

10GBASE-ER CWDM SFP+ specifications

The following table lists the part numbers for the 10GBASE-ER CWDM SFP+ transceivers with corresponding wavelengths.

Table 33: Part number and center wavelength assignment

Part number	Center wavelength assignment	Reach	Minimum insertion loss
AA1403153-E6	1471 nm	Up to 40 km	5 dB between Tx and Rx
AA1403154-E6	1491 nm	Up to 40 km	5 dB between Tx and Rx
AA1403155-E6	1511 nm	Up to 40 km	5 dB between Tx and Rx
AA1403156-E6	1531 nm	Up to 40 km	5 dB between Tx and Rx
AA1403157-E6	1551 nm	Up to 40 km	5 dB between Tx and Rx
AA1403158-E6	1571 nm	Up to 40 km	5 dB between Tx and Rx
AA1403159-E6	1591 nm	Up to 40 km	5 dB between Tx and Rx

Table continues...

Part number	Center wavelength assignment	Reach	Minimum insertion loss
AA1403160-E6	1611 nm	Up to 40 km	5 dB between Tx and Rx
AA1403161-E6	1471 nm	Up to 70 km.	5 dB between Tx and Rx
AA1403162-E6	1491 nm	Up to 70 km	5 dB between Tx and Rx
AA1403163-E6	1511 nm	Up to 70 km	5 dB between Tx and Rx
AA1403164-E6	1531 nm	Up to 70 km	5 dB between Tx and Rx
AA1403165-E6	1551 nm	Up to 70 km	5 dB between Tx and Rx
AA1403166-E6	1571 nm	Up to 70 km	5 dB between Tx and Rx
AA1403167-E6	1591 nm	Up to 70 km	5 dB between Tx and Rx
AA1403168-E6	1611 nm	Up to 70 km	5 dB between Tx and Rx

The following table lists the transmitter and receiver specifications for the 10GBASE-ER CWDM SFP+ transceivers.

Table 34: 10GBASE-ER CWDM SFP+ specifications

Parameter	Specifications
Transmitter characteristics	
Optical Data Rate (nominal)	9.95 Gbps to 10.313 Gbps
Center wavelength	Nominal –6.5 nm to nominal +6.5 nm
Spectral width (rms at –20 dB)	1 nm
Side Mode Suppression ratio	30 dB
RIN	–128 dB/Hz
Average launched power	–0.2 dBm to 4 dBm
Average launched power, Tx OFF	–30 dBm
Extinction ratio (minimum)	8.2 dB
Tx power, OMA (minimum)	+1.5 dBm
Tx power, OMA-TDP (minimum)	–0.2 dBm
TDP at 800 ps dispersion (maximum)	2.8 dB
IEEE 10GBASE-ER eye mask margin	10%
Receiver characteristics	
Wavelength (requirement)	1450 nm to 1620 nm
Receiver sensitivity (unstressed), OMA	–14.1 dBm, P_OMA
IEEE 10GBASE-ER Stressed Rx Sensitivity	–11.3 dBm, P_OMA
Receiver overload	–1 dBm, P_avg
Receiver reflectance	–26 dB
Receiver damage threshold	+4 dBm

Chapter 9: XFP specifications

This section provides technical specifications for the supported 10 gigabit SFP (XFP) models. Use these specifications to aid in network design.

The specifications in this section are a subset of the IEEE 802.3ae and 802.3aq specifications. For more information, see these standards documents. All Avaya XFPs meet or exceed these standards.

! Important:

Avaya recommends that you only use Avaya-qualified XFPs. If you do choose to use other vendor XFPs, be aware that Avaya does not support the use of other XFPs.

XFP labels

As shown in the following figure, the Avaya label on a typical XFP contains an Avaya serial number, a bar code, a manufacturer code, an interface type, and a part number.

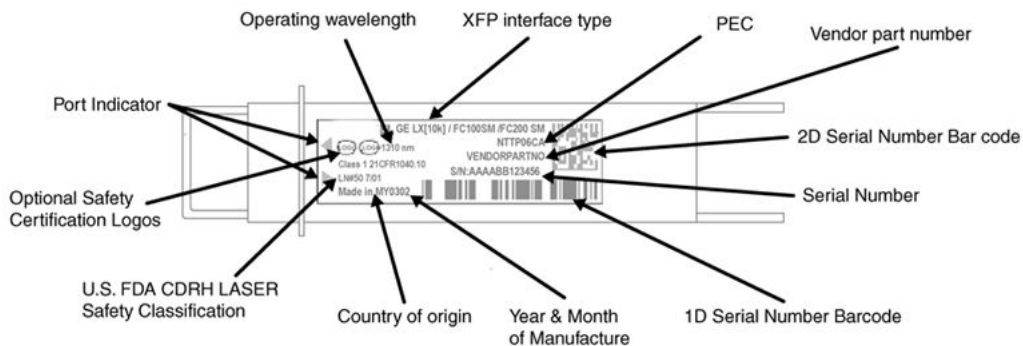

Figure 5: XFP label

General XFP specifications

The following table describes general XFP specifications.

Table 35: General XFP specifications

Parameter	Specifications
Dimensions (H x W x D)	0.49 x 0.72 x 2.79 inches (in.) 12.5 x 18.35 x 71.1 millimeters (mm)
Connectors	Duplex LC ultra physical contact (UPC)
Storage temperature	- 40 to 85C
Operating temperature	0 to 70C

10GBASE-SR XFP specifications

The 10GBASE-SR SFP provides 10 GbE service at 850 nm.

The following table lists the specifications for the 10GBASE-SR XFP. The part number of this XFP is AA1403005-E5.

For more information about the 10GBASE-SR XFP, including test and measurement information, see the IEEE 802.3ae standard.

 **Caution:**

Risk of equipment damage

To prevent damage to the optical receiver, ensure that at least 1 dB of attenuation is present between the transmit and receive ports.

Table 36: IEEE 802.3ae 10GBASE-SR XFP specifications

Parameter	Specifications
Data rate	10.0 Gb/s
Line rate (64B/66B code)	10.3125 gigabits per second (Gb/s) ± 100 parts per million (ppm)
Mean Time Between Failures (MTBF)	675 000 hours
Center wavelength range	840 to 860 nanometers (nm), nominal 850 nm
Distance	Using 62.5 µm MMF optic cable: <ul style="list-style-type: none"> • 160 MHz-km fiber: 2 to 26 m • 200 MHz-km fiber: 2 to 33 m Using 50 µm MMF optic cable: <ul style="list-style-type: none"> • 400 MHz-km fiber: 2 to 66 m • 500 MHz-km fiber: 2 to 82 m • 2000 MHz-km fiber: 2 to 300 m

Table continues...

Parameter	Specifications
Link optical power budget	7.3 dB
Maximum transmitter and dispersion penalty	3.9 dB at 300 m
Transmitter characteristics	
Root-mean-square spectral width	0.05 to 0.40 nm
Launch power	– 7.3 to – 1.0 decibels referenced to 1 milliwatt (dBm)
Maximum average launch power of OFF transmitter	– 30 dBm
Minimum extinction ratio	3.0 dB
Maximum relative intensity noise ₁₂ OMA	– 128 dB per Hertz (dB/Hz)
Maximum optical return loss tolerance	– 12 dB
Receiver characteristics	
Average receive power for BER 10 ⁻¹²	– 9.9 to – 1.0 dBm
Maximum average receive power for damage	0 dBm
Maximum receiver sensitivity in OMA	– 11.1 dBm
Maximum receiver reflectance	– 12 dB
Stressed receiver sensitivity in OMA	– 7.5 dBm
Receiver electrical 3 dB upper cutoff frequency	12.3 gigaHertz (GHz)

The stressed sensitivity values are for system level BER measurements, which include the effects of clock and data recovery (CDR) circuits. Avaya recommends that you allocate at least 0.4 dB additional margin if you make component level measurements without the effect of CDR circuits.

10GBASE-LRM XFP specifications

The 10GBASE-LRM XFP provides 10 GbE service at a wavelength of 1310 nm. This XFP can attain a reach of up to 220 m on 62.5 μm multimode fiber. This XFP provides built-in electronic dispersion compensation.

The following table lists the transmitter and receiver specifications for the 10GBASE-LRM XFP. These parameters meet the IEEE 802.3aq-2006 standard. The part number of this XFP is AA1403007-E6.

In this table, the OMA, average launch power, and peak power specifications apply at TP2, after patch cord loss is accounted for.

Table 37: IEEE 802.3aq 10GBASE-LRM XFP specifications

Parameter	Specifications
Data rate	10.0 Gb/s
Line rate (64B/66B code)	10.3125 Gb/s \pm 100 ppm
Center wavelength range	1260 to 1355 nm; 1310 nm nominal
Distance	Up to 220 m, for more information, see Table 38: 10GBASE-LRM channel insertion loss and range on page 64
Link optical power budget	1.7 to 1.9 dB, for more information, see Table 38: 10GBASE-LRM channel insertion loss and range on page 64
Maximum transmitter waveform and dispersion penalty (TWDP)	4.7 dB
Transmitter characteristics	
Average launch power	– 6.5 to 0.5 dBm
Peak launch power	3 dBm
Root-mean-square spectral width	2.4 to 4 nm
Launch power in OMA	– 4.5 to 1.5 dBm
Maximum average launch power of OFF transmitter	– 30 dBm
Minimum extinction ratio	3.5 dB
Maximum relative intensity noise at OMA— RIN _{12OMA}	– 128 dB/Hz
Optical return loss tolerance (minimum)	– 20 dB
Receiver characteristics	
Maximum receive average power for damage	1.5 dBm
Receiver reflectance (maximum)	– 12 dB

For more information about the conditions used for the stressed receiver tests, and other information, see the IEEE 802.3aq standard.

The following table (from IEEE 802.3aq) describes the maximum channel insertion loss. The channel insertion loss includes both attenuation and connector loss (1.5 dB); therefore the maximum fiber attenuation is 0.2 to 0.4 dB.

Table 38: 10GBASE-LRM channel insertion loss and range

Fiber type (core diameter and OFL bandwidth)	Range	Maximum channel insertion loss
62.5 μ m (FDDI grade) <ul style="list-style-type: none"> • 160 MHz-km at 850 nm • 500 MHz-km at 1300 nm 	Up to 220 m	1.9 dB

Table continues...

Fiber type (core diameter and OFL bandwidth)	Range	Maximum channel insertion loss
62.5 μm (ISO/IEC OM1) <ul style="list-style-type: none"> • 200 MHz-km at 850 nm • 500 MHz-km at 1300 nm 	Up to 220 m	1.9 dB
50 μm (ISO/IEC OM2) <ul style="list-style-type: none"> • 500 MHz-km at 850 nm • 500 MHz-km at 1300 nm 	Up to 220 m	1.9 dB
50 μm <ul style="list-style-type: none"> • 400 MHz-km at 850 nm • 400 MHz-km at 1300 nm 	Up to 100 m	1.7 dB
50 μm (ISO/IEC OM3) <ul style="list-style-type: none"> • 1500 MHz-km at 850 nm (includes laser launch bandwidth) • 500 MHz-km at 1300 nm (includes laser launch bandwidth) 	Up to 220 m	1.9 dB

In the table, FDDI denotes Fiber Distributed Data Interface, ISO denotes International Standards Organization, IEC denotes International Electrotechnical Commission, and OFL denotes Over Filled Launch.

The following table is based on the 802.3aq standard and specifies the measurement conditions for each fiber type.

Table 39: Launch conditions for each fiber type

Parameter	Minimum encircled flux	Notes
Optical launch for OM1 and FDDI-grade fiber	<ul style="list-style-type: none"> • 30% within 5 μm radius • 81% within 11 μm radius 	Uses 62.5 μm mode conditioning patch cord
Optical launch for OM2 and 50 μm 400/400 fiber	<ul style="list-style-type: none"> • 30% within 5 μm radius • 81% within 11 μm radius 	Uses 50 μm mode conditioning patch cord
Optical launch for OM3 and 50 μm fiber	<ul style="list-style-type: none"> • 30% within 5 μm radius • 81% within 11 μm radius 	—

10GBASE-LR/LW XFP specifications

The 10GBASE-LX XFP provides 10 GbE or OC-192 service at a nominal wavelength of 1310 nm. This XFP can attain link lengths of up to 10 km.

The following table lists the transmitter and receiver specifications for the 10GBASE-LR/LW XFP. The part number of this XFP is AA1403001-E5.

For more information about the 10GBASE-LX XFP, including test and measurement information, see the IEEE 802.3ae standard.

Table 40: IEEE 802.3ae 10GBASE-LR/LW XFP specifications

Parameter	Specifications
MTBF	675 000 hours
Center wavelength range	1260 to 1355 nm; 1310 nm nominal
Distance	Up to 10 km
Link optical power budget	9.4 dB
Maximum transmitter and dispersion penalty	3.2 dB at 10 km
Transmitter characteristics	
Line rate (nominal)	10GBASE-LR 10.3125 Gb/s \pm 100 ppm (10 GbE) 10GBASE-LW 9.95328 Gb/s \pm 20 ppm (OC-192)
Average launch power	– 8.2 to 0.5 dBm
Minimum side mode suppression ratio	30 dB
Minimum launch power in OMA minus transmission and dispersion penalty (TDP)	– 6.2 dBm
Minimum optical modulation amplitude	– 5.2 dBm
Maximum average launch power of OFF transmitter ^c	– 30 dBm
Minimum extinction ratio	3.5 dB
RIN ₁₂ OMA (maximum)	– 128 dB/Hz
Maximum optical return loss tolerance	– 12 dB
Maximum transmitter reflectance	– 12 dB
Receiver characteristics	
Line rate (nominal)	10GBASE-LR 10.3125 Gb/s \pm 100 ppm (10 GbE) 10GBASE-LW 9.95328 Gb/s \pm 100 ppm (OC-192)
Average receive power for BER 10 ⁻¹²	– 14.4 dBm to 0.5 dBm
Maximum average receive power for damage	1.5 dBm
Maximum receiver sensitivity in OMA	– 12.6 dBm
Maximum receiver reflectance	– 12 dB
Stressed receiver sensitivity in OMA	– 10.3 dBm
Receiver electrical 3 dB upper cutoff frequency	12.3 GHz

Examples of an OFF transmitter are as follows: no power supplied to the PDM, laser shutdown for safety conditions, activation of a PMD_global_transmit_disable or other optional transmitter shut down condition

10GBASE-ZR/ZW XFP specifications

The following table lists the transmit and receive specifications for the 10GBASE-ZR/ZW XFP. The reach is up to 80 km at a wavelength of 1550 nm. The part number of this XFP is AA1403006-E5.

For more information about the 10GBASE-ZX XFP, including test and measurement information and more specifications, see the IEEE 802.3ae standard.

Caution:

Risk of BER increase

For proper XFP operation, ensure that at least 11 dB of attenuation is present between the transmit and receive ports.

Table 41: 10GBASE-ZR/ZW XFP specifications

Parameter	Specifications
Line rate (nominal)	10GBASE-ZR 10.3125 Gb/s \pm 100 ppm (10 GbE) 10GBASE-ZW 9.95328 Gb/s \pm 20 ppm (OC-192)
MTBF	675 000 hours
Distance	Up to 80 km
Link optical power budget	24 dB
Maximum transmitter and dispersion penalty	3.0 dB at 80 km (G.652 fiber)
Transmitter characteristics	
Center wavelength range	1530 to 1565 nm; nominal 1550 nm
Side mode suppression ratio (minimum)	30 dB
Average launch power	0 to 4.0 dBm
Optical modulation amplitude (minimum)	– 1.7 dBm
Average launch power of OFF transmitter (maximum)	– 30 dBm
Extinction ratio (ER)	minimum 3.5 dB end of life maximum 7.0 dB start of life
RIN ₁₂ OMA (maximum)	– 128 dB/Hz
Maximum optical return loss tolerance	– 26 dB
Maximum transmitter reflectance	– 12 dB
Receiver characteristics	
Wavelength range	1280 to 1575 nm. Sensitivity specified for 1530 to 1565 nm.
Signaling speed (nominal)	10GBASE-ZR 10.3125 Gb/s \pm 100 ppm (10 GbE) 10GBASE-ZW 9.95328 Gb/s \pm 100 ppm (OC-192)
Maximum average receiver sensitivity	– 24 dBm

Table continues...

XFP specifications

Parameter	Specifications
Maximum receive power (for BER 10^{-12} and 9 dB ER)	- 7.0 dBm
Maximum average receive power for damage	5.0 dBm
Receiver reflectance (maximum)	- 27 dB
Receive electrical 3 dB upper cutoff frequency	9.3 GHz

Chapter 10: Resources

Support

Go to the Avaya Support website at <http://support.avaya.com> for the most up-to-date documentation, product notices, and knowledge articles. You can also search for release notes, downloads, and resolutions to issues. Use the online service request system to create a service request. Chat with live agents to get answers to questions, or request an agent to connect you to a support team if an issue requires additional expertise.

Documentation

For a list of the documentation for this product and more information about documents on how to configure other switch features, see *Documentation Reference for Avaya Ethernet Routing Switch 4800 Series*, NN47205–101.

For more information on new features of the switch and important information about the latest release, see *Release Notes for Avaya Ethernet Routing Switch 4800 Series*, NN47205-400.

For more information about how to configure security, see *Configuring Security on Avaya Ethernet Routing Switch 4800 Series*, NN47205-505.

For the current documentation, see the Avaya Support web site: www.avaya.com/support.

Training

Ongoing product training is available. For more information or to register, see <http://avaya-learning.com/>.

Enter the course code in the **Search** field and click **Go** to search for the course.

Course code	Course title
8D00020E	Stackable ERS and VSP Products Virtual Campus Offering

Viewing Avaya Mentor videos

Avaya Mentor videos provide technical content on how to install, configure, and troubleshoot Avaya products.

About this task

Videos are available on the Avaya Support website, listed under the video document type, and on the Avaya-run channel on YouTube.

Procedure

- To find videos on the Avaya Support website, go to <http://support.avaya.com> and perform one of the following actions:
 - In **Search**, type `Avaya Mentor Videos` to see a list of the available videos.
 - In **Search**, type the product name. On the Search Results page, select **Video** in the **Content Type** column on the left.
- To find the Avaya Mentor videos on YouTube, go to www.youtube.com/AvayaMentor and perform one of the following actions:
 - Enter a key word or key words in the **Search Channel** to search for a specific product or topic.
 - Scroll down Playlists, and click the name of a topic to see the available list of videos posted on the website.

 **Note:**

Videos are not available for all products.

Searching a documentation collection

On the Avaya Support website, you can download the documentation library for a specific product and software release to perform searches across an entire document collection. For example, you can perform a single, simultaneous search across the collection to quickly find all occurrences of a particular feature. Use this procedure to perform an index search of your documentation collection.

Before you begin

- Download the documentation collection zip file to your local computer.
- You must have Adobe Acrobat or Adobe Reader installed on your computer.

Procedure

1. Extract the document collection zip file into a folder.
2. Navigate to the folder that contains the extracted files and open the file named `<product_name_release>.pdx`.

3. In the Search dialog box, select the option **In the index named <product_name_release>.pdx**.
4. Enter a search word or phrase.
5. Select any of the following to narrow your search:
 - Whole Words Only
 - Case-Sensitive
 - Include Bookmarks
 - Include Comments
6. Click **Search**.

The search results show the number of documents and instances found. You can sort the search results by Relevance Ranking, Date Modified, Filename, or Location. The default is Relevance Ranking.

Subscribing to e-notifications

Subscribe to e-notifications to receive an email notification when documents are added to or changed on the Avaya Support website.

About this task

You can subscribe to different types of general notifications, for example, Product Correction Notices (PCN), which apply to any product or a specific product. You can also subscribe to specific types of documentation for a specific product, for example, Application & Technical Notes for Virtual Services Platform 7000.

Procedure

1. In an Internet browser, go to <https://support.avaya.com>.
2. Type your username and password, and then click **Login**.
3. Under **My Information**, select **SSO login Profile**.
4. Click **E-NOTIFICATIONS**.
5. In the GENERAL NOTIFICATIONS area, select the required documentation types, and then click **UPDATE**.

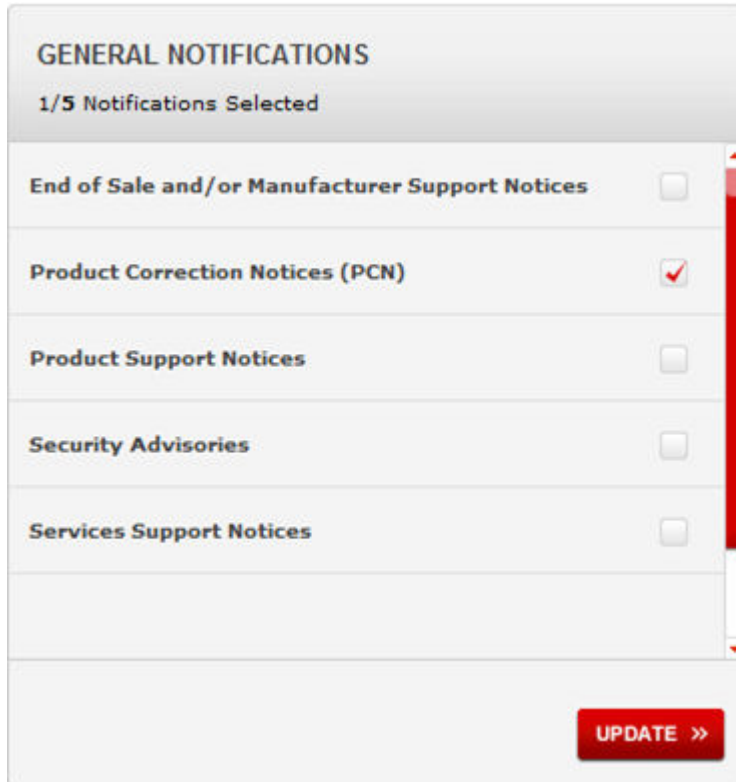

6. Click **OK**.
7. In the **PRODUCT NOTIFICATIONS** area, click **Add More Products**.

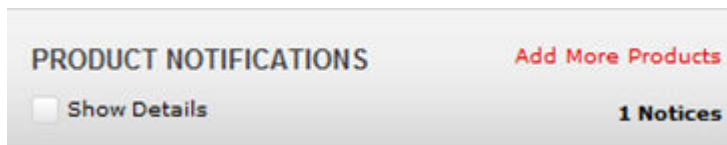

8. Scroll through the list, and then select the product name.
9. Select a release version.
10. Select the check box next to the required documentation types.

The screenshot shows a web interface for selecting e-notifications. It is divided into two main sections:

- PRODUCTS**: A list of products with a 'My Notifications' link. The products listed are:
 - Virtual Services Platform 7000
 - Virtualization Provisioning Service
 - Visual Messenger™ for OCTEL® 250/350
 - Visual Vectors
 - Visualization Performance and Fault Manager
 - Voice Portal
 - Voice over IP Monitoring
 - W310 Wireless LAN Gateway
 - WLAN 2200 Series
 - WLAN Handset 2200 Series
- VIRTUAL SERVICES PLATFORM 7000**: A detailed view for this product. It includes a 'Select a Release Version' dropdown menu set to 'All and Future'. Below this are several notification categories, each with a checkbox:
 - Administration and System Programming
 - Application Developer Information
 - Application Notes
 - Application and Technical Notes
 - Declarations of Conformity
 - Documentation LibraryA red 'SUBMIT >>' button is located at the bottom right of this section.

11. Click **Submit**.