

53-1003658-01  
27 February 2015

# Network OS Layer 3

---

## Routing Configuration Guide

Supporting Network OS v6.0.0

**BROCADE** 

**© 2015, Brocade Communications Systems, Inc. All Rights Reserved.**

ADX, Brocade, Brocade Assurance, the B-wing symbol, DCX, Fabric OS, HyperEdge, ICX, MLX, MyBrocade, OpenScript, The Effortless Network, VCS, VDX, Vplane, and Vyatta are registered trademarks, and Fabric Vision and vADX are trademarks of Brocade Communications Systems, Inc., in the United States and/or in other countries. Other brands, products, or service names mentioned may be trademarks of others.

Notice: This document is for informational purposes only and does not set forth any warranty, expressed or implied, concerning any equipment, equipment feature, or service offered or to be offered by Brocade. Brocade reserves the right to make changes to this document at any time, without notice, and assumes no responsibility for its use. This informational document describes features that may not be currently available. Contact a Brocade sales office for information on feature and product availability. Export of technical data contained in this document may require an export license from the United States government.

The authors and Brocade Communications Systems, Inc. assume no liability or responsibility to any person or entity with respect to the accuracy of this document or any loss, cost, liability, or damages arising from the information contained herein or the computer programs that accompany it.

The product described by this document may contain open source software covered by the GNU General Public License or other open source license agreements. To find out which open source software is included in Brocade products, view the licensing terms applicable to the open source software, and obtain a copy of the programming source code, please visit <http://www.brocade.com/support/oscd>.

# Contents

---

<b>Preface.....</b>	<b>10</b>
Document conventions.....	10
Text formatting conventions.....	10
Command syntax conventions.....	10
Notes, cautions, and warnings.....	11
Brocade resources.....	12
Contacting Brocade Technical Support.....	12
Document feedback.....	13
<b>About this document.....</b>	<b>14</b>
Supported hardware and software.....	14
Using the Network OS CLI .....	15
What's new in this document.....	15
<b>IP Route Policy.....</b>	<b>16</b>
IP route policy overview.....	16
IP prefix lists.....	16
Route maps.....	16
Configuring IP route policy.....	17
<b>Configuring IP Route Management.....</b>	<b>18</b>
IP route management overview.....	18
How IP route management determines best route.....	18
Configuring static routes.....	18
Specifying the next-hop gateway.....	19
Specifying the egress interface.....	19
Configuring the default route.....	19
<b>Configuring PBR.....</b>	<b>20</b>
Policy-Based Routing.....	20
Policy-Based Routing behavior.....	21
Policy-Based Routing with differing next hops.....	22
Policy-Based Routing uses of NULL0.....	23
Policy-Based Routing and NULL0 with match statements.....	23
Policy-Based Routing and NULL0 as route map default action.....	24
<b>Configuring PIM.....</b>	<b>26</b>
PIM overview.....	26
Important notes.....	26
PIM Sparse Mode.....	26
PIM topologies.....	27
PIM Sparse device types.....	30
PIM prerequisites.....	30
PIM standards conformity.....	31
PIM limitations.....	31

PIM supportability.....	31
Configuring PIM.....	32
PIM configuration prerequisites.....	33
Configuring PIM Sparse.....	33
Restricting unknown multicast.....	35
<b>Configuring OSPF.....</b>	<b>36</b>
OSPF overview.....	36
Autonomous System.....	36
OSPF components and roles.....	37
OSPF areas.....	39
Virtual links.....	41
OSPFv2 graceful restart.....	42
OSPF over VRF.....	43
OSPF in a VCS environment.....	43
OSPF considerations and limitations.....	44
Configuring OSPF.....	45
Performing basic OSPF configuration.....	45
Disabling OSPFv2 graceful restart.....	48
Re-enabling OSPFv2 graceful restart.....	48
Disabling OSPFv2 graceful restart helper.....	49
OSPFv2 non-stop routing (NSR).....	49
Enabling OSPF over VRF.....	50
Enabling OSPF in a VCS environment.....	50
Changing default settings.....	51
Disabling and re-enabling OSPF event logging.....	51
Disabling OSPF on the router.....	52
<b>Configuring OSPFv3.....</b>	<b>53</b>
OSPFv3 overview.....	53
OSPFv3 considerations and limitations.....	54
OSPFv3 areas.....	54
Backbone area.....	54
Area types.....	55
Area range.....	55
Stub area.....	55
Totally stubby area.....	56
Not-so-stubby area.....	56
LSA types for OSPFv3.....	57
Virtual links.....	57
Virtual link source address assignment.....	59
OSPFv3 route redistribution.....	59
Default route origination.....	60
Filtering OSPFv3 routes.....	61
SPF timers.....	61
OSPFv3 administrative distance.....	61
OSPFv3 LSA refreshes.....	62
OSPFv3 over VRF.....	62
OSPFv3 graceful restart helper.....	63
OSPFv3 non-stop routing (NSR).....	63
IPsec for OSPFv3.....	63
IPsec for OSPFv3 configuration.....	64
Configuring OSPFv3.....	65
Configuring the router ID.....	65
Enabling OSPFv3.....	65
Enabling OSPFv3 in a nondefault VRF.....	66

Assigning OSPFv3 areas.....	67
Assigning OSPFv3 areas in a nondefault VRF.....	67
Assigning OSPFv3 areas to interfaces.....	68
Configuring an NSSA.....	69
Assigning a stub area.....	70
Configuring virtual links.....	70
Redistributing routes into OSPFv3.....	71
Modifying Shortest Path First timers.....	72
Configuring the OSPFv3 LSA pacing interval.....	73
Configuring default route origin.....	73
Disabling and re-enabling OSPFv3 event logging.....	74
Configuring administrative distance based on route type.....	74
Changing the reference bandwidth for the cost on OSPFv3.....	75
Setting all OSPFv3 interfaces to the passive state.....	76
Disabling OSPFv3 graceful restart helper.....	76
Re-enabling OSPFv3 graceful restart helper.....	77
Configuring IPsec on an OSPFv3 area.....	77
Configuring IPsec on an OSPFv3 interface.....	78
Configuring IPsec on OSPFv3 virtual links.....	79
Specifying the key rollover and key add-remove timers.....	79
Displaying OSPFv3 results.....	80
Clearing OSPFv3 redistributed routes.....	83
<b>Configuring VRF-lite for OSPF.....</b>	<b>85</b>
Overview of VRF-lite for OSPF.....	85
Benefits and applications of VRF-lite.....	86
OSPF VRF-lite for customer-edge routers.....	86
Example of VRF-lite usage in a service provider network.....	87
Configuring OSPF VRF-lite for customer-edge routers.....	87
VRF-lite for OSPF configuration example.....	88
<b>Configuring BGP.....</b>	<b>92</b>
BGP overview.....	92
BGP support.....	92
Deployment scenarios.....	92
BGP peering.....	95
BGP attributes.....	98
Best-path algorithm.....	98
BGP limitations and considerations.....	99
Understanding BGP configuration fundamentals.....	99
Configuring BGP.....	100
Device ID.....	100
Local AS number.....	100
IPv4 unicast address family.....	100
BGP global mode.....	101
Neighbor configuration.....	102
Peer groups.....	103
Four-byte AS numbers.....	103
Route redistribution.....	104
Advertised networks.....	104
Static networks.....	104
Route reflection.....	105
Route flap dampening.....	105
Default route origination.....	106
Multipath load sharing.....	106
Configuring the default route as a valid next-hop.....	106

Next-hop recursion.....	107
Route filtering.....	107
Timers.....	107
BGP4 outbound route filtering.....	107
BGP4 confederations.....	108
BGP4 extended community.....	108
BGP4+ graceful restart.....	109
Using route maps.....	109
Configuring BGP.....	112
Adjusting defaults to improve routing performance.....	113
Configuring BGP4 outbound route filtering.....	113
Configuring BGP4 confederations.....	114
Defining BGP4 extended communities.....	115
Applying a BGP4 extended community filter.....	116
Configuring BGP4 graceful restart.....	117
Using route maps with match and set statements.....	118
Clearing configurations.....	121
Displaying BGP4 statistics.....	122
<b>Configuring BGP4+.....</b>	<b>124</b>
BGP4+ overview.....	124
BGP global mode.....	124
IPv6 unicast address family.....	125
BGP4+ neighbors.....	126
BGP4+ peer groups.....	126
BGP4+ next hop recursion.....	127
BGP4+ NLRIs and next hop attributes.....	127
BGP4+ route reflection.....	128
BGP4+ route aggregation.....	128
BGP4+ multipath.....	128
Route maps.....	129
BGP4+ outbound route filtering.....	129
BGP4+ confederations.....	129
BGP4+ extended community.....	130
BGP4+ graceful restart.....	130
Configuring BGP4+.....	130
Configuring BGP4+ neighbors using global IPv6 addresses.....	131
Configuring BGP4+ neighbors using link-local addresses.....	131
Configuring BGP4+ peer groups.....	132
Configuring a peer group with IPv4 and IPv6 peers.....	133
Importing routes into BGP4+.....	134
Advertising the default BGP4+ route.....	135
Advertising the default BGP4+ route to a specific neighbor.....	135
Using the IPv6 default route as a valid next hop for a BGP4+ route.....	136
Enabling next-hop recursion.....	136
Configuring a cluster ID for a route reflector.....	137
Configuring a route reflector client.....	137
Aggregating routes advertised to BGP neighbors.....	138
Enabling load-balancing across different paths.....	139
Configuring a route map for BGP4+ prefixes.....	139
Redistributing prefixes into BGP4+.....	141
Configuring BGP4+ outbound route filtering.....	141
Configuring BGP4+ confederations.....	142
Defining BGP4+ extended communities.....	143
Applying a BGP4+ extended community filter.....	144
Configuring BGP4+ graceful restart.....	145

Disabling the BGP AS_PATH check function.....	147
Displaying BGP4+ statistics.....	147
Displaying BGP4+ neighbor statistics.....	149
Clearing BGP4+ dampened paths.....	151
<b>VRRP.....</b>	<b>152</b>
VRRPv2 Overview.....	152
VRRP Terminology.....	154
VRRP-Ev2 overview.....	155
VRRPv2 limitations on Brocade VDX devices.....	155
VRRP hold timer.....	156
VRRP interval timers.....	156
ARP and VRRP control packets.....	156
Enabling a master VRRP device.....	157
Enabling a backup VRRP device.....	158
Enabling a VRRP-E device.....	159
VRRP multigroup clusters.....	160
Configuring multigroup VRRP routing.....	161
Track ports and track priority with VRRP and VRRP-E.....	163
Tracking ports and setting VRRP priority.....	163
VRRP backup preemption.....	165
Enabling VRRP backup preemption.....	165
VRRP-E load-balancing using short-path forwarding.....	166
Short-path forwarding with revert priority.....	167
Configuring VRRP-E load-balancing in VCS mode.....	168
Clearing VRRPv2 statistics.....	169
Displaying VRRPv2 information.....	170
<b>VRRPv3.....</b>	<b>172</b>
VRRPv3 overview.....	172
VRRPv3 functionality differences on Brocade VDX devices.....	173
VRRPv3 performance and scalability metrics for Network OS devices.....	173
Enabling IPv6 VRRPv3.....	173
Enabling IPv4 VRRPv3.....	174
Enabling IPv6 VRRP-Ev3.....	175
Track ports and track priority with VRRP and VRRP-E.....	176
Port tracking using IPv6 VRRPv3.....	177
VRRP hold timer.....	178
Configuring VRRP hold timer support.....	178
VRRP-E load-balancing using short-path forwarding.....	179
Short-path forwarding with revert priority.....	180
Configuring VRRP-Ev3 load-balancing in VCS mode.....	181
VRRP-Ev3 sub-second failover.....	182
Configuring sub-second failover using VRRP-Ev3.....	182
VRRPv3 router advertisement suppression.....	183
Disabling VRRPv3 router advertisements.....	183
Alternate VRRPv2 checksum for VRRPv3 IPv4 sessions.....	184
Enabling the v2 checksum computation method in a VRRPv3 IPv4 session.....	184
Displaying VRRPv3 statistics.....	185
Clearing VRRPv3 statistics.....	187
<b>Configuring Virtual Routing and Forwarding.....</b>	<b>189</b>
VRF overview.....	189

VRF topology.....	189
Configuring VRF .....	190
Enabling VRRP for VRF.....	191
Inter-VRF route leaking.....	192
Configuring Static Inter-VRF route leaking.....	193
Configuring Dynamic Inter-VRF route leaking.....	196
Understanding and using the management VRF.....	198
Configuring management VRFs.....	199
Managing management VRFs.....	200
<b>Configuring IP DHCP Relay.....</b>	<b>202</b>
DHCP protocol.....	202
IP DHCP Relay function.....	202
Brocade IP DHCP relay overview.....	203
Supported platforms.....	204
Configuring IP DHCP Relay.....	204
Displaying IP DHCP relay addresses for an interface.....	206
Displaying IP DHCP Relay addresses on specific switches.....	207
Displaying IP DHCP Relay statistics.....	208
Clearing IP DHCP Relay statistics.....	209
VRF support.....	210
High Availability support.....	211
<b>Configuring IP DHCPv6 Relay.....</b>	<b>212</b>
DHCPv6 relay agent.....	212
DHCPv6 multicast addresses and UDP ports.....	213
DHCPv6 address assignment.....	214
DHCPv6 message format.....	215
DHCPv6 relay provisioning.....	216
Configuring IPv6 DHCP Relay.....	217
Displaying DHCPv6 Relay addresses on a specific switch.....	218
Displaying DHCPv6 Relay addresses for an interface.....	219
Displaying IPv6 DHCP Relay statistics.....	220
Clearing IP DHCPv6 Relay statistics.....	221
<b>Configuring Dual-Stack Support.....</b>	<b>223</b>
Understanding dual-stack support.....	223
Configuring IPv6 addressing and connectivity.....	225
Understanding IPv6 addresses and prefixes.....	225
Configuring a global IPv6 address with a manually configured interface ID.....	226
Configuring a global IPv6 address with an automatically computed EUI-64 interface ID.....	227
Configuring a link-local IPv6 address.....	227
Configuring an IPv6 anycast address.....	228
Configuring IPv4 and IPv6 protocol stacks.....	228
Configuring an IPv6 address family .....	229
Configuring static IPv6 routes.....	229
Changing the IPv6 MTU.....	231
Configuring IPv6 Neighbor Discovery.....	232
Neighbor Solicitation and Neighbor Advertisement messages.....	233
Router Advertisement and Router Solicitation messages.....	233
Neighbor Redirect messages.....	234
Duplicate address detection (DAD).....	234
Setting Neighbor Solicitation parameters for DAD.....	235



Configuring IPv6 static neighbor entries.....	236
Setting IPv6 Router Advertisement parameters.....	236
Controlling prefixes advertised in IPv6 Router Advertisement messages.....	237
Setting flags in IPv6 Router Advertisement messages.....	237
Configuring MLD snooping.....	238
Enabling and disabling MLD snooping globally.....	239
Enabling and disabling MLD snooping at the interface level.....	240
Enabling and disabling MLD querier functionality on a VLAN.....	240
Configuring and unconfiguring an MLD static group on a VLAN.....	240
Enabling and disabling MLD fast-leave on a VLAN.....	241
Configuring the MLD query interval.....	241
Configuring the MLD last-member query interval.....	242
Configuring the MLD last-member query count.....	242
Configuring the MLD query maximum response time.....	243
Configuring the MLD snooping robustness variable.....	243
Configuring the MLD startup query count.....	243
Configuring the MLD startup query interval.....	244
Configuring a VLAN port member to be a multicast router port.....	244
Managing the flooding of multicast data traffic.....	244
Monitoring and managing MLD snooping.....	245
Monitoring and managing IPv6 networks.....	245

# Preface

---

- [Document conventions](#).....10
- [Brocade resources](#)..... 12
- [Contacting Brocade Technical Support](#).....12
- [Document feedback](#)..... 13

## Document conventions

The document conventions describe text formatting conventions, command syntax conventions, and important notice formats used in Brocade technical documentation.

### Text formatting conventions

Text formatting conventions such as boldface, italic, or Courier font may be used in the flow of the text to highlight specific words or phrases.

Format	Description
<b>bold text</b>	Identifies command names Identifies keywords and operands Identifies the names of user-manipulated GUI elements Identifies text to enter at the GUI
<i>italic text</i>	Identifies emphasis Identifies variables Identifies document titles
<code>Courier font</code>	Identifies CLI output Identifies command syntax examples

### Command syntax conventions

Bold and italic text identify command syntax components. Delimiters and operators define groupings of parameters and their logical relationships.

Convention	Description
<b>bold text</b>	Identifies command names, keywords, and command options.
<i>italic text</i>	Identifies a variable.
value	In Fibre Channel products, a fixed value provided as input to a command option is printed in plain text, for example, <b>--show</b> WWN.

Convention	Description
[ ]	Syntax components displayed within square brackets are optional. Default responses to system prompts are enclosed in square brackets.
{ x   y   z }	A choice of required parameters is enclosed in curly brackets separated by vertical bars. You must select one of the options. In Fibre Channel products, square brackets may be used instead for this purpose.
x   y	A vertical bar separates mutually exclusive elements.
< >	Nonprinting characters, for example, passwords, are enclosed in angle brackets.
...	Repeat the previous element, for example, <i>member{member...}</i> .
\	Indicates a “soft” line break in command examples. If a backslash separates two lines of a command input, enter the entire command at the prompt without the backslash.

## Notes, cautions, and warnings

Notes, cautions, and warning statements may be used in this document. They are listed in the order of increasing severity of potential hazards.

---

### NOTE

A Note provides a tip, guidance, or advice, emphasizes important information, or provides a reference to related information.

---



---

### ATTENTION

An Attention statement indicates a stronger note, for example, to alert you when traffic might be interrupted or the device might reboot.

---



### CAUTION

A Caution statement alerts you to situations that can be potentially hazardous to you or cause damage to hardware, firmware, software, or data.

---



### DANGER

A Danger statement indicates conditions or situations that can be potentially lethal or extremely hazardous to you. Safety labels are also attached directly to products to warn of these conditions or situations.

---

## Brocade resources

Visit the Brocade website to locate related documentation for your product and additional Brocade resources.

You can download additional publications supporting your product at [www.brocade.com](http://www.brocade.com). Select the Brocade Products tab to locate your product, then click the Brocade product name or image to open the individual product page. The user manuals are available in the resources module at the bottom of the page under the Documentation category.

To get up-to-the-minute information on Brocade products and resources, go to [MyBrocade](#). You can register at no cost to obtain a user ID and password.

Release notes are available on [MyBrocade](#) under Product Downloads.

White papers, online demonstrations, and data sheets are available through the [Brocade website](#).

## Contacting Brocade Technical Support

As a Brocade customer, you can contact Brocade Technical Support 24x7 online, by telephone, or by e-mail. Brocade OEM customers contact their OEM/Solutions provider.

### Brocade customers

For product support information and the latest information on contacting the Technical Assistance Center, go to <http://www.brocade.com/services-support/index.html>.

If you have purchased Brocade product support directly from Brocade, use one of the following methods to contact the Brocade Technical Assistance Center 24x7.

Online	Telephone	E-mail
<p>Preferred method of contact for non-urgent issues:</p> <ul style="list-style-type: none"> <li>• <a href="#">My Cases</a> through MyBrocade</li> <li>• <a href="#">Software downloads</a> and licensing tools</li> <li>• <a href="#">Knowledge Base</a></li> </ul>	<p>Required for Sev 1-Critical and Sev 2-High issues:</p> <ul style="list-style-type: none"> <li>• Continental US: 1-800-752-8061</li> <li>• Europe, Middle East, Africa, and Asia Pacific: +800-AT FIBREE (+800 28 34 27 33)</li> <li>• For areas unable to access toll free number: +1-408-333-6061</li> <li>• <a href="#">Toll-free numbers</a> are available in many countries.</li> </ul>	<p><a href="mailto:support@brocade.com">support@brocade.com</a></p> <p>Please include:</p> <ul style="list-style-type: none"> <li>• Problem summary</li> <li>• Serial number</li> <li>• Installation details</li> <li>• Environment description</li> </ul>

### Brocade OEM customers

If you have purchased Brocade product support from a Brocade OEM/Solution Provider, contact your OEM/Solution Provider for all of your product support needs.

- OEM/Solution Providers are trained and certified by Brocade to support Brocade® products.
- Brocade provides backline support for issues that cannot be resolved by the OEM/Solution Provider.
- Brocade Supplemental Support augments your existing OEM support contract, providing direct access to Brocade expertise. For more information, contact Brocade or your OEM.
- For questions regarding service levels and response times, contact your OEM/Solution Provider.

## Document feedback

To send feedback and report errors in the documentation you can use the feedback form posted with the document or you can e-mail the documentation team.

Quality is our first concern at Brocade and we have made every effort to ensure the accuracy and completeness of this document. However, if you find an error or an omission, or you think that a topic needs further development, we want to hear from you. You can provide feedback in two ways:

- Through the online feedback form in the HTML documents posted on [www.brocade.com](http://www.brocade.com).
- By sending your feedback to [documentation@brocade.com](mailto:documentation@brocade.com).

Provide the publication title, part number, and as much detail as possible, including the topic heading and page number if applicable, as well as your suggestions for improvement.

# About this document

---

- [Supported hardware and software](#)..... 14
- [Using the Network OS CLI](#) ..... 15
- [What's new in this document](#)..... 15

## Supported hardware and software

In those instances in which procedures or parts of procedures documented here apply to some switches but not to others, this guide identifies exactly which switches are supported and which are not.

Although many different software and hardware configurations are tested and supported by Brocade Communications Systems, Inc. for Network OS 6.0.0, documenting all possible configurations and scenarios is beyond the scope of this document.

The following hardware platforms are supported by this release of Network OS:

- Brocade VDX 2740

---

### NOTE

The Brocade VDX 2740 is the equivalent of the Lenovo Flex System EN4023 10Gb Scalable Switch. This platform is identified in the system as EN4023.

---

- Brocade VDX 6740
  - Brocade VDX 6740-48
  - Brocade VDX 6740-64
- Brocade VDX 6740T
  - Brocade VDX 6740T-48
  - Brocade VDX 6740T-64
  - Brocade VDX 6740T-1G
- Brocade VDX 6940-36Q
- Brocade VDX 8770
  - Brocade VDX 8770-4
  - Brocade VDX 8770-8

To obtain information about a Network OS version other than this release, refer to the documentation specific to that version.

## Using the Network OS CLI

For complete instructions and support for using the Network OS v5.0.1 command line interface (CLI), refer to the *Network OS Command Reference*.

## What's new in this document

This document is released in conjunction with Network OS 6.0.0 and incorporates minor editorial improvements. There are no new Layer 3 features for this release.

For complete information, refer to the *Network OS Release Notes*.

# IP Route Policy

---

- [IP route policy overview.....](#) 16
- [Configuring IP route policy.....](#) 17

## IP route policy overview

IP route policy controls how routes or IP subnets are transported from one subsystem to another subsystem. The IP route policy may perform "permit" or "deny" actions so that matched routes may be allowed or denied to the target subsystem accordingly. Additionally, IP route policy may also be used for modify the characteristics of a matched route and IP subnet pair.

Two types of IP route policies are supported, *prefix-list* and *route-map*, as discussed in the following sections

### IP prefix lists

An IP prefix list is identified by its name. Each IP prefix list may consist of one or more instances. The following is an example of IP prefix list,

```
switch# ip prefix-list test 1 deny 1.2.0.0/16 ge 17 le 30
switch# ip prefix-list test 2 permit 1.1.0.0/16
```

A matching condition of a prefix-list instance contains two portions: (1) an IP subnet prefix and(2) an optional prefix (mask) length, where **ge** (greater than or equal to) is the lower limit of the mask length, and **le** (less than or equal to) is the upper limit of the mask length. If no **ge** or **le** is given in an instance, the exact match of subnet prefix length is needed.

In the example above, a route is considered a match for instance 1 if this route is inside subnet 1.2.0.0/16 *and* whose mask length is between 17 and 30. That is, route 1.2.1.0/24 matches but route 1.2.1.1/32 does not match because of the difference in mask length.

Similar to a route map, when finding a match, each prefix-list instance is looked at in the order specified by its instance ID. The look-up terminates at the first match. A route that does not find a match in the prefix list is denied.

At present, a prefix list is not used by itself. The IP prefix list can be used as part of route-map **match** clauses. In this context, **permit** means "match" this pattern, and **deny** means "do not match this pattern".

### Route maps

A route map is identified by its name. Each route map may consist of one or more instances. Each route map instance may contain zero or more **match** clauses, and zero or more **set** clauses.

At present, a route map instance represents the largest granularity of configuration. That is, the end user is required to add *and* delete route maps by means of its instance. For example, when removing a route map, an end user is required to remove this route-map in all of its instances. A route map



instance may contain more than one match condition. The overall matching condition of the instance is true only if all matching conditions are met. The following is an example of a route map:

```
switch# route-map test deny 1 match interface te 0/1
switch# route-map test permit 2 match ip next-hop prefix-list pre-test set tag 5000
```

In the example above, **route-map test** comprises of two instances: instance 1 denies entry for any routes whose next-hop interface is te 0/1, and instance 2 allows entry for routes whose next-hop address matches the IP subnets specified by **prefix-list pre-test** (the prefix-list instance is not shown). Additionally, each matched route has its tag set to 5000.

---

#### NOTE

The maximum number of OSPF networks that can be advertised and processed in a single area in a router is limited to 600.

---

A route map instance does not need to contain a matching condition; its existence implies that the matching condition for this instance is true.

A route map instance may contain more than one set clause. All **set** clauses are applied to the **match** routes when applicable.

When a route map is applied, each instance is looked at in the order specified by the instance ID. If there is a match, the instance's action are applied, and its **set** clauses are applied if the action is permitted. The search terminates at the first match. A route that does not find a match in a route map is denied.

## Configuring IP route policy

Similar to ACLs, a route map and IP prefix list need to be applied for a specified policy to take effect. The following example applies a route-map to the redistribution of static routes into an OSPF domain. (For complete information on these commands, refer to the *Network OS Command Reference*.)

To set an IP route policy, perform the following steps in privileged EXEC mode.

1. Enter the **router ospf (or router bgp)** command to enable the appropriate Layer 3 protocol. This example uses OSPF and creates the route map instance "test."  

```
switch# router ospf redistribute static route-map test area 0
```
2. Enter the **ip route** command to create the prefix for a static route.  

```
switch# ip route 11.11.11.0/24 2.2.2.1
```
3. Enter the **ip route** command to create the next hop in the static route. Repeat as needed.  

```
switch# ip route 11.11.11.0/24 2.2.2.2
```
4. Enter the **route-map** command to create the route map and prefix list instance.  

```
switch# route-map test permit 1 match ip address prefix-list pretest
```
5. Enter the **ip prefix-list** command to configure the IP prefix list instance.  

```
switch# ip prefix-list pretest 2 permit 1.1.1.0/24
```

In the example above, when the **route-map test permit 1** command executes, only the static route 1.1.1.0/24 is exported into the OSPF domain, because there are no matching rules in **pretest** for route 11.11.11.0/24. The default action of **pretest** is **deny** (there is no match); therefore, the route 11.11.11.0/24 is not exported into the OSPF domain.

You can configure the router to permit or deny specific IP addresses explicitly. The router permits all IP addresses by default. If you want **permit** to remain the default behavior, define individual filters to deny specific IP addresses. If you want to change the default behavior to **deny**, define individual filters to permit specific IP addresses. Once you define a filter, the default action for addresses that do not match a filter is **deny**. To change the default action to **permit**, configure the last filter as **permit any any**.

# Configuring IP Route Management

---

- [IP route management overview](#)..... 18
- [Configuring static routes](#)..... 18

## IP route management overview

*IP route management* is the term used to refer to software that manages routes and next hops from different sources in a routing table, from which the Brocade device selects the best routes for forwarding IP packets. This route management software gets activated automatically at system bootup and does not require preconfiguration.

IP route management runs on all platforms configured for Layer 3 and does the following:

- Maintains routes submitted by other protocols.
- Supports route redistribution.
- Supports router identification.
- Selects and synchronizes routes to the forwarding information base (FIB).
- Synchronizes the Layer 3 interface to the FIB.
- Supports the following Layer 3 interfaces: virtual ethernet (Ve), router port, loopback, and management.

---

### NOTE

IP route management supports both IPv4 and IPv6 routes.

---

## How IP route management determines best route

The sources of routes that are added into IP route management are the following:

- Dynamic routes from routing protocols. Open Shortest Path First (OSPF) and Border Gateway Protocol (BGP) are both supported.
- Static configured routes: You can add routes directly to the route table. When you add a route to the IP route table, you are creating a static IP route.
- Directly connected routes from interface configuration: When you add an IP interface, the Brocade device automatically creates a route for the network.

Administrative distance can be configured for route types other than connected routes. IP route management prefers routes with lower administrative distances.

## Configuring static routes

You can add a static route to IP route management by using the **ip route** commands in RBridge ID configuration mode. With these commands, you can specify either the next-hop gateway or the egress interface for the route.

## Specifying the next-hop gateway

To configure a static route to network 10.95.7.0/24, using 10.95.6.157 as the next-hop gateway, use the **ip route** command in RBridge ID configuration mode, as shown in this example:

```
switch (config)# rbridge-id 30
switch (config-rbridge-id-30)# ip route 10.95.7.0/24 10.95.6.157
```

## Specifying the egress interface

To configure a static IP route with an IPv4 address on a 10-gigabit Ethernet port, enter an **ip route** command such as the following.

```
switch (config)# rbridge-id 30
switch (config-rbridge-id-30)# ip route 192.128.2.0/24 te 101/4/1
```

The command configures a static IP route for destination network 192.128.2.0/24. Because an Ethernet port is specified instead of a gateway IP address as the next hop, the Brocade device forwards traffic for network 192.128.2.0/24 to the 10-gigabit Ethernet port 101/4/1.

This example is the same command using IPv6.

```
switch (config)# rbridge-id 30
switch (config-rbridge-id-30)# ipv6 route fe80::21b:edff:fe0b:3c00/64 te 101/4/1
```

## Configuring the default route

A default route is configured with an all-zero prefix/netmask (for example, 0.0.0.0/0). The default route is an example of a special static route with a destination prefix of zero. All traffic that does not have other matching routes is forwarded to the default route.

Once the maximum number of routes are installed in the IP route table and if you delete some of those routes, the **clear ip route all** command needs to be executed for the routes to be refreshed, so that previously uninstalled routes can be re-installed up to the maximum limit.

To configure a default route with a next hop address of 10.95.6.157, enter the following **ip route** command.

```
switch(config)# rbridge-id 30
switch(config-rbridge-id-30)# ip route 0.0.0.0/0 10.95.6.157
```

---

### ATTENTION

Beginning with release 5.0.0, support is provided for the management VRF. The default VRF and other user-configured (nondefault) VRFs can no longer be used for router management. This feature is allowed only on management VRF ports. For details, refer to [Understanding and using the management VRF](#) on page 198.

---

To view the status of management routes, use the **show ip route vrf** command and enter **mgmt-vrf** as follows. You must enter the name of the management VRF manually. Example output is shown below.

```
switch# show ip route vrf mgmt-vrf
```

```
Total number of IP routes: 3
Type Codes - B:BGP D:Connected O:OSPF S:Static; Cost - Dist/Metric
BGP Codes - i:iBGP e:eBGP
OSPF Codes - i:Inter Area 1:External Type 1 2:External Type 2 s:Sham Link
Destination      Gateway          Port           Cost           Type  Uptime
0.0.0.0/0         10.25.224.1     mgmt 1         1/1             S    10d17h
10.25.224.0/24   DIRECT          mgmt 1         0/0             D    10d17h
10.25.224.18/32  DIRECT          mgmt 1         0/0             D    10d17h
```

# Configuring PBR

---

- [Policy-Based Routing.....20](#)
- [Policy-Based Routing behavior.....21](#)
- [Policy-Based Routing with differing next hops.....22](#)
- [Policy-Based Routing uses of NULL0.....23](#)

## Policy-Based Routing

Policy-Based Routing (PBR) allows you to use ACLs and route maps to selectively modify and route IP packets in hardware.

Basically, the ACLs classify the traffic and route maps that match on the ACLs set routing attributes for the traffic. A PBR policy specifies the next hop for traffic that matches the policy, as follows:

- For standard ACLs with PBR, you can route IP packets based on their source IP address.
- For extended ACLs with PBR, you can route IP packets based on all of the matching criteria in the extended ACL.

---

### NOTE

For details about ACLs, refer to the "Managing and Configuring ACLs" section of the *Network OS Security Configuration Guide*.

---

To configure PBR, you define the policies using IP ACLs and route maps, then enable PBR on individual interfaces. The platform programs the ACLs on the interfaces, and routes traffic that matches the ACLs according to the instructions provided by the "set" statements in the route map entry.

Currently, the following platforms support PBR:

- Brocade VDX 8770
- Brocade VDX 6740
- Brocade VDX 6740T
- Brocade VDX 6740T-1G

You can configure the Brocade device to perform the following types of PBR based on a packet's Layer 3 and Layer 4 information:

- Select the next-hop gateway.
- Set the DSCP value.
- Send the packet to the null interface (null0) to drop the packets.

Using PBR, you can define a set of classifications that, when met, cause a packet to be forwarded to a predetermined next-hop interface, bypassing the path determined by normal routing. You can define multiple match and next-hop specifications on the same interface. The configuration of a set of match criteria and corresponding routing information (for example next hops and DSCP values) is referred to as a stanza.

You can create multiple stanzas within a route-map configuration and assign the stanza an "Instance\_ID" that controls the program positioning within the route map. Furthermore, when the route

map is created, you specify a deny or permit construct for the stanza. In addition, the ACL used for the “match” criteria also contains a deny or permit construct.

The deny or permit nomenclature has a different meaning within the context of the PBR operation than it does within the normal context of user-applied ACLs (where deny and permit are directly correlated to the forwarding actions of forward and drop). The following table lists the behavior between the permit and deny actions specified at the route-map level, in conjunction with the permit and deny actions specified at the ACL rule level.

Route-map level permit and deny actions	ACL clause permit and deny actions	Resulting Ternary Content Addressable Memory (TCAM) action
Permit	Permit	The “set” statement of the route-map entry is applied.
Permit	Deny	The packet is “passed” and routed normally. The contents of the “set” command are not applied. A rule is programmed in the TCAM as a “permit” with no result actions preventing any further statements of the route-map ACL from being applied.
Deny	Permit	The packet is “passed” and routed normally. There should be no “set” commands following the “match” command of a deny route-map stanza. A rule is programmed in the TCAM as a “permit” with no result actions preventing any further statements of the route-map ACL from being applied.
Deny	Deny	No TCAM entry is provisioned; no other route-map ACL entries will be compared against. If no subsequent matches are made, the packet is forwarded as normal.

## Notes:

- Ternary Content Addressable Memory is high-speed hardware memory.
- Consider the permit and deny keywords as allowing the specified match content as either being permitted to or denied from using the defined “set criteria” of the route map. The permit and deny keywords do not correlate to the forwarding action of forward and drop as they do in the ACL application.
- PBR route maps may only be applied to Layer 3 (L3) interfaces. Application of a route map to a non-L3 interface results in the configuration being rejected.
- Deletion of a route map or deletion of an ACL used in the route map “match” is not allowed when the route map is actively bound to an interface. Attempts to delete an active route map or associated ACL is rejected, and an error and log will be generated.
- The “set” commands are only available within the context of a “permit” stanza. The CLI should not allow the use of a “set” command within a PBR “deny” stanza.

## Policy-Based Routing behavior

Policy-Based Routing (PBR) next-hop behavior selects the first live next-hop specified in the policy that is “UP”.

If none of the policy's direct routes or next hops is available, the packets are forwarded as per the routing table. The order in which the next hop addresses are listed in the route map is an implicit preference for next hop selection. For example, if you enter the next hop addresses A, B, and C (in that order), and all paths are reachable, then A is the preferred selection. If A is not reachable, the next hop is B. If the path to A becomes reachable, the next hop logic will switch to next-hop A.

PBR does not have implicit “deny ip any any” ACL rule entry, as used in ACLs, to ensure that for route maps that use multiple ACLs (stanzas), the traffic is compared to all ACLs. However, if an explicit “deny ip any any” is configured, traffic matching this clause is routed normally using L3 paths and is not compared to any ACL clauses that follow the clause.

The set clauses are evaluated in the following order:

1. Set clauses where the next hop is specified.
2. Set interface NULL0.

The order in which you enter either the **set ip next-hop** or the **set ipv6 next-hop** command determines the order preference. If no next-hops are reachable, the egress interface is selected based on the order of interface configuration. The set interface NULL0 clause — regardless of which position it was entered — is always placed as the last selection in the list.

For example if you enter the order shown below, the PBR logic will treat 3.3.3.5 as its first choice. If 3.3.3.5 is unavailable, the PBR logic will determine if 6.6.6.7 is available. NULL0 is recognized only if 3.3.3.5 and 6.6.6.7 are both unavailable.

```
route-map foo permit 20
  match ip address acl Vincent
  set ip next-hop 3.3.3.5
  set ip interface NULL0
  set ip next-hop 6.6.6.7
```

---

#### NOTE

If a PBR route map is applied to an interface that is actively participating in a control protocol, and the ACL specified in the route map also matches the control protocol traffic, the control protocol traffic is trapped to the local processor and is not forwarded according to the route map.

---

## Policy-Based Routing with differing next hops

In this example, traffic is routed from different sources to different places (next hops). Packets arriving from source 1.1.1.1 are sent to the VRF `pulp_fiction`'s next hop at 3.3.3.3; packets arriving from source 2.2.2.2 are sent to the VRF `pulp_fiction`'s next hop at 3.3.3.5. If next hop 3.3.3.5 is not available, then the packet is sent to the next hop 2001:db8:0:0:0:ff00:42:8329.

1. Configure the ACLs.

```
switch(config)# ip access-list standard Jules
switch(conf-ipacl-std)# permit ip 1.1.1.1
```

```
switch(config)# ip access-list standard Vincent
switch(conf-ipacl-std)# permit ip 2.2.2.2
```

2. Create the first stanza of the route map, which is done in RBridge ID configuration mode. (The example is using a route-map named `pulp_fiction`.)

```
switch(config)# rbridge-id 1
switch(config-rbridge-id-1)# route-map pulp_fiction permit 10
switch(config-routemap pulp_fiction)# match ip address acl Jules
switch(config-routemap pulp_fiction)# set ip vrf pulp_fiction next-hop 3.3.3.3
```

3. Create the second stanza of the route-map (in this example we'll define a route-map named `pulp_fiction`.)

```
switch(config-rbridge-id-1)# route-map pulp_fiction permit 20
switch(config-routemap pulp_fiction)# match ip address acl Vincent
switch(config-routemap pulp_fiction)# set ip vrf pulp_fiction next-hop 3.3.3.5
switch(config-routemap pulp_fiction)# set ip next-hop 6.6.6.7
```

4. Bind the route map to the desired interface.

```
switch(config)# interface TenGigabitEthernet 4/1
switch(conf-if-te-4/1)# ip policy route-map pulp_fiction
```

### 5. View the route map configuration contents.

```
switch# show running-config route-map pulp-fiction
route-map pulp-fiction permit 10
  match ip address acl Jules
  set ip vrf pulp_fiction next-hop 3.3.3.3
!
route-map pulp-fiction permit 20
  match ip address acl Vincent
  set ip vrf pulp_fiction next-hop 3.3.3.5
  set ip next-hop 6.6.6.7
!
```

### 6. View the route map application.

```
switch# show route-map pulp-fiction
Interface TenGigabitEthernet 3/3
  route-map pulp-fiction permit 10
    match ip address acl Jules (Active)
    set ip vrf pulp_fiction next-hop 3.3.3.3
    Policy routing matches: 0 packets; 0 bytes

  route-map pulp-fiction permit 20
    match ip address acl Vincent (Active)
    set ip vrf pulp_fiction next-hop 3.3.3.5 (selected)
    set ip next-hop 6.6.6.7
    Policy routing matches: 0 packets; 0 bytes
```

---

#### NOTE

For the first stanza (10) created in step 2, the absence of the keyword selected indicates that the none of the next hops in the list is being used; the packet is being routed by the standard routing mechanism.

---

## Policy-Based Routing uses of NULL0

NULL0 is a mechanism used to drop packets in policy-based routing.

NULL0 is a mechanism used to drop packets in policy-based routing. If the NULL0 interface is specified within a stanza and the stanza also contains a “match ACL” statement, only traffic meeting the match criteria within the ACL is forwarded to the NULL0 interface. If the NULL0 interface is specified within a stanza that does not contain a “match” statement, the match criteria is implicitly “match any.”

Examples of using NULL0 include:

- NULL0 in conjunction with a “match” statement.
- NULL0 as a default action of a route map.

### Policy-Based Routing and NULL0 with match statements

NULL0 is a mechanism used to drop packets in the Policy-Based Routing (PBR). If the NULL0 interface is specified within a stanza and the stanza also contains a “match ACL” statement, only traffic meeting the match criteria within the ACL is forwarded to the NULL0 interface. If the NULL0 interface is specified within a stanza that does not contain a “match” statement, the match criteria is implicitly “match any.”

In this example, the use of the NULL0 interface is only applicable to frames that meet the match criteria defined in the created ACL, or implicit “permit any” when no explicit match statement is listed for the stanza.

#### 1. Configure the ACLs.

```
sw0(config)# ip access-list standard Jules
sw0(conf-ipacl-std)# permit ip 1.1.1.1
sw0(conf-ipacl-std)# deny ip 11.11.11.11
```

```
sw0(config)# ip access-list standard Vincent
sw0(conf-ipacl-std)# permit ip 2.2.2.2
```

2. Create the first stanza of the route map, which is done in RBridge ID configuration mode. (The example is using a route-map named pulp\_fiction.)

```
sw0(config)# rbridge-id 1
sw0(config-rbridge-id-1)# route-map pulp_fiction permit 10
sw0(config-routemap pulp_fiction)# match ip address acl Jules
sw0(config-routemap pulp_fiction)# set ip vrf pulp_fiction next-hop 3.3.3.3
sw0(config-routemap pulp_fiction)# set ip interface NULL0
```

3. Create the second stanza of the route map. (The example is using a route map named pulp\_fiction.)

```
sw0(config-rbridge-id-1)# route-map pulp_fiction permit 20
sw0(config-routemap pulp_fiction)# match ip address acl Vincent
sw0(config-routemap pulp_fiction)# set ip vrf pulp_fiction next-hop 3.3.3.5
sw0(config-routemap pulp_fiction)# set ipv6 next-hop 2001:db8:0:0:ff00:42:8329
```

Based on the above configuration, when address 1.1.1.1 is received, it matches stanza 10:

- If the next hop 3.3.3.3 is selected, the packet is forwarded to 3.3.3.3.
- If 3.3.3.3 is not selected by the PBR logic, the packet is sent to the next specified next-hop, which is the NULL0 interface, resulting in the traffic being dropped.
- If address 11.11.11.11 is received, since it matches the deny case of the ACL, it is denied from using the next hops specified in the route map and is forwarded according to the standard logic.
- If address 12.12.12.12 is received, because it meets none of the specified match criteria in either of the two stanzas, it basically falls off the end of the route map and reverts to using the standard routing logic.

## Policy-Based Routing and NULL0 as route map default action

This example shows the use of the NULL0 interface.

In this example, the use of the NULL0 interface is only applicable to frames that meet the match criteria defined in the created ACL.

1. Configure the ACLs.

```
sw0(config)# ip access-list standard Jules
sw0(conf-ipacl-std)# permit ip 1.1.1.1
sw0(conf-ipacl-std)# deny ip 11.11.11.11
sw0(config)# ip access-list standard Vincent
sw0(conf-ipacl-std)# permit ip 2.2.2.2
```

2. Create the first stanza of the route map, which is done in RBridge ID configuration mode. (The example is using a route-map named pulp\_fiction.)

```
sw0(config)# rbridge-id 1
sw0(config-rbridge-id-1)# route-map pulp_fiction permit 10
sw0(config-routemap pulp_fiction)# match ip address acl Jules
sw0(config-routemap pulp_fiction)# set ip vrf pulp_fiction next-hop 3.3.3.3
sw0(config-routemap pulp_fiction)# set ip interface NULL0
```

3. Create the second stanza of the route map. (The example is using a route-map named pulp\_fiction.)

```
sw0(config-rbridge-id-1)# route-map pulp_fiction permit 20
sw0(config-routemap pulp_fiction)# match ip address acl Vincent
sw0(config-routemap pulp_fiction)# set ip vrf pulp_fiction next-hop 3.3.3.5
```

4. Create the third stanza, which provides the default action of the route map.

```
sw0(config-rbridge-id-1)# route-map pulp_fiction permit 30
sw0(config-routemap pulp_fiction)# set ip interface NULL0
```

The above configuration introduces a third stanza that defines the routing desired for all frames that do not meet any of the match criteria defined by the route map.

Based on the above configuration, when address 1.1.1.1 is received, it matches stanza 10:

- If the next hop 3.3.3.3 is selected, the packet is forwarded to 3.3.3.3.
- If 3.3.3.3 is not selected by the PBR logic, the packet is sent to the next specified next-hop, which is the NULL0 interface, resulting in the traffic being dropped.



- If address 11.11.11.11 is received, since it matches the deny case of the ACL, it is denied from using the next hops specified in the route map and will be forwarded according to the standard logic.
- If address 12.12.12.12 is received, because it meets none of the specified match criteria in either of the first two stanzas, it reaches the third stanza. Since a no “match” statement is specified, it is an implicit “match any.” The address 12.12.12.12 is forwarded to the NULL0 interface where it is dropped.

Providing the default stanza enables a mechanism whereby if any packet is received that does not meet the match criteria set by the route map, the traffic is dropped.

# Configuring PIM

---

• PIM overview.....	26
• PIM Sparse Mode.....	26
• PIM topologies.....	27
• PIM Sparse device types.....	30
• PIM prerequisites.....	30
• PIM standards conformity.....	31
• PIM limitations.....	31
• PIM supportability.....	31
• Configuring PIM.....	32

## PIM overview

The Protocol Independent Multicast (PIM) protocol is a family of IP multicast protocols. PIM does not rely on any particular routing protocol for creating its network topology state. Instead, PIM uses routing information supplied by other traditional routing protocols such as the Routing Information Protocol, Open Shortest Path First, Border Gateway Protocol, and Multicast Source Discovery Protocol.

PIM messages are sent encapsulated in an IP packet with the IP protocol field set to 103. Depending on the type of message, the packet is either sent to the PIM All-Router-Multicast address (224.0.0.13) or sent as unicast to a specific host.

As with IP multicast, the main use case of PIM is for the source to be able to send the same information to multiple receivers by using a single stream of traffic. This helps minimize the processing load on the source as it needs to maintain only one session irrespective of the number of actual receivers. It also minimizes the load on the IP network since the packets are sent only on links which lead to an interested receiver.

Several types of PIM exist, but in this release Brocade supports only PIM Sparse Mode (PIM-SM). PIM-SM explicitly builds unidirectional shared trees rooted at a rendezvous point (RP) per group, and optionally creates shortest-path trees per source.

### Important notes

- PIM can be enabled on the Brocade VDX 6740 and VDX 8770 series platforms only.
- PIM-SM can be used in VCS mode only.

## PIM Sparse Mode

PIM-SM (Sparse Mode) is the most commonly deployed flavor of PIM. PIM-SM is most effective in large networks sparsely populated with hosts interested in multicast traffic. It is assumed that most hosts within a network are not interested in all multicast data streams.

PIM Sparse devices are organized into domains. A PIM Sparse domain is a contiguous set of devices that all implement PIM and are configured to operate within a common boundary.

PIM-SM creates unidirectional shared trees which are rooted at a common node in the network called the rendezvous point (RP). The RP acts as the messenger between the source and the interested hosts or routers.

There are various ways of identifying an RP within a network. It can either be statically configured per PIM router or configured using Bootstrap Router (BSR). Within a network, the RP should always be upstream compared to the destination hosts.

Once the RP has been identified, each interested host and/or router sends join messages to the RP for the group that they are interested in. To reduce incoming join messages to a RP, the local network selects one of its upstream routers as the designated router (DR). All hosts below a DR send IGMP join messages to the DR. The DR sends only one join message to the RP on behalf of all its interested hosts.

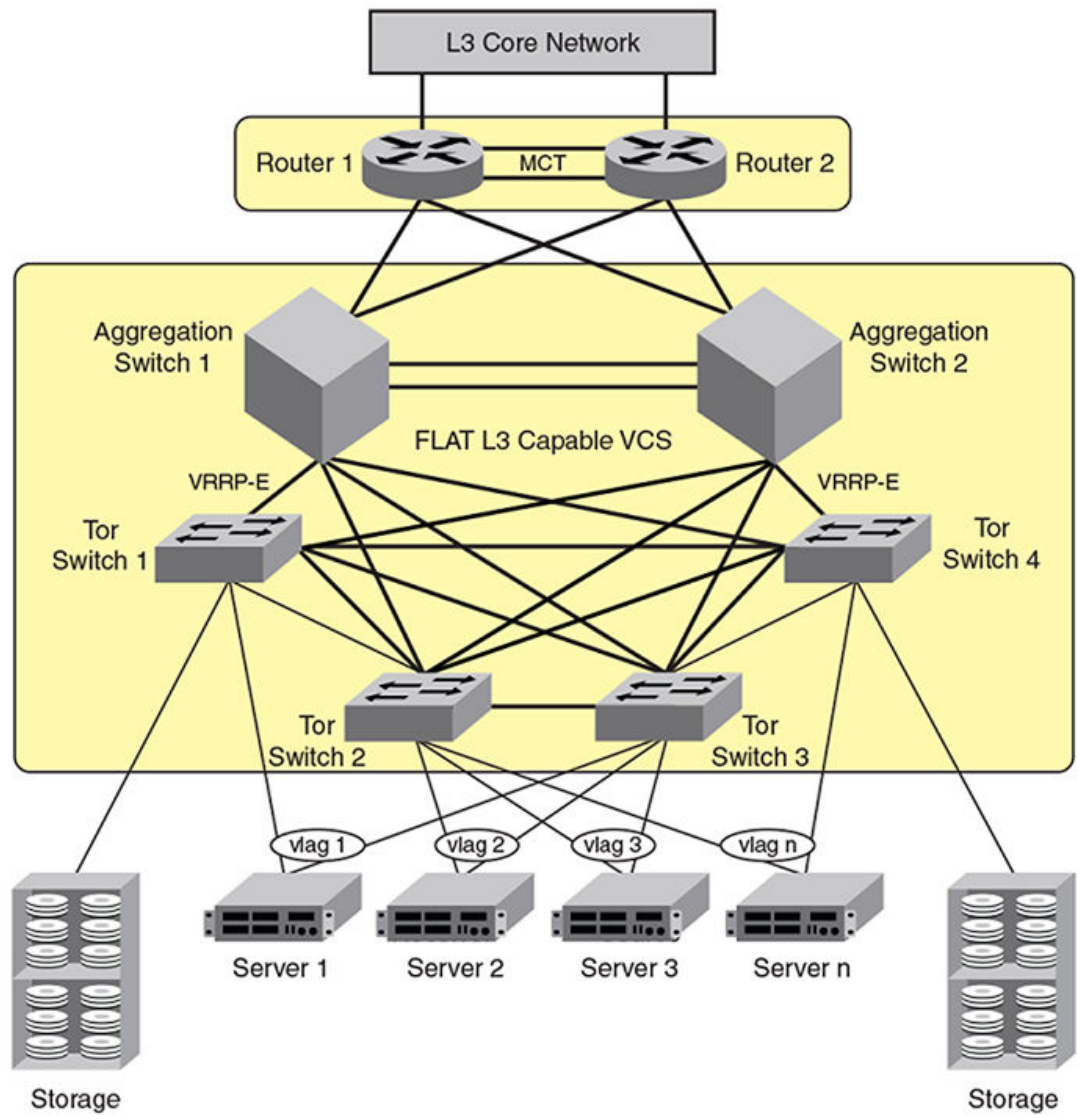
PIM-SM also provides the option of creating a source-based tree rooted at a router adjacent to the tree. This provides the destination hosts with an option of switching from the shared tree to the source-based tree if this is a shorter path between the source and the destination.

## PIM topologies

This section shows diagrams of two supported PIM topologies.

The figure below shows the components for a single-VCS PIM topology.

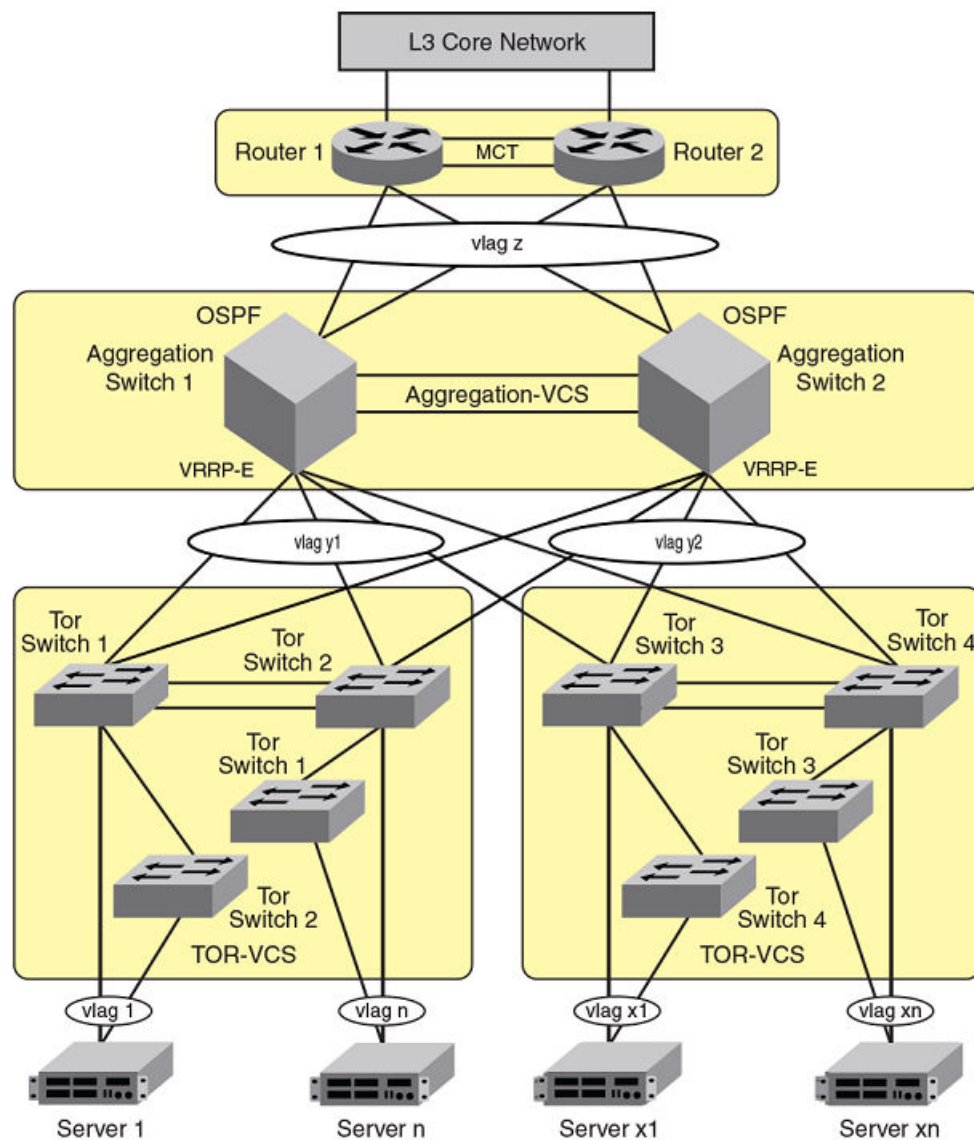
**FIGURE 1** Single VCS deployment



The following requirements apply to the single-VCS deployment depicted in the figure above:

- Top of rack switches can be Brocade VDX 6740, VDX 6740T, VDX 6740T-1G, or VDX 8770 models. However, top of rack switches are typically only Layer 2-capable when used in this context as part of a PIM environment, and PIM can be enabled on the Brocade VDX 8770 and VDX 6740 models only.
- Top of rack switches must have IGMP-snooping enabled.
- Aggregation-layer switches must be Brocade VDX 8770 or VDX 6740 models only.
- Aggregation-layer switches can be PIM-enabled.
- L3 (VRRP-E and OSPF) can be configured on all interfaces with L3 connectivity to the data-center core.
- IGMP snooping must be enabled on the aggregation-layer switches.
- PIM DR-priority is configured on ve interfaces of all PIM-capable aggregation routers to optimize load-sharing abilities within the aggregation.

The figure below shows the components for a two-tier VCS PIM topology.

**FIGURE 2** Two-tier VCS deployment

The following requirements apply to the two-tier-VCS deployment depicted in the figure above:

- Top of rack switches can be Brocade VDX 6740 or VDX 8770 models. However, Top of rack switches are typically only L2-capable when used in this context as part of a PIM environment, and PIM can be enabled on the Brocade VDX 8770 or VDX 6740 models only.
- Top of rack VCS are typically only L2 capable.
- Top of rack switches must have IGMP-snooping enabled.
- Aggregation-layer VCS must be VDX 8770 or VDX 6740 models only.
- Aggregation-layer switches can be PIM-enabled.
- L3 (VRRP-E and OSPF) can be configured on all interfaces with L3 connectivity to the data-center core.
- IGMP snooping must be enabled on the aggregation-layer switches.

- PIM can be enabled on all Brocade VDX 8770 or VDX 6740 models where VRRP-E is enabled.
- PIM DR-priority is configured on ve interfaces of all PIM-capable aggregation routers to optimize load-sharing abilities within the aggregation.

## PIM Sparse device types

Devices that are configured with PIM Sparse interfaces also can be configured to fill one or more of the following roles:

- PIM multicast border router (PMBR) — A PIM device that has interfaces within the PIM domain and other interface outside the PIM domain. PBMRs connect the PIM domain to the Internet.
- Bootstrap router (BSR) — A router that distributes rendezvous point (RP) information to the other PIM Sparse devices within the domain. Each PIM Sparse domain has one active BSR. For redundancy, you can configure ports on multiple devices as candidate BSRs. The PIM Sparse protocol uses an election process to select one of the candidate BSRs as the BSR for the domain. The BSR with the highest BSR priority (a user-configurable parameter) is elected. If the priorities result in a tie, then the candidate BSR interface with the highest IP address is elected.

The BSR must be configured as part of the L3 core network.

- Rendezvous point (RP) — The meeting point for PIM Sparse sources and receivers. A PIM Sparse domain can have multiple RPs, but each PIM Sparse multicast group address can have only one active RP. PIM Sparse devices learn the addresses of RPs and the groups for which they are responsible from messages that the BSR sends to each of the PIM Sparse devices.

The RP must be configured as part of the L3 core network.

---

### NOTE

Brocade recommends that you configure the same ports as candidate BSRs and RPs.

- PIM designated router (DR) — Once the RP has been identified, each interested host and/or router sends join messages to the RP for the group that they are interested in. The local network selects one of its upstream routers as the designated router (DR). All hosts below a DR send IGMP join messages to the DR. The DR in turn sends only one join message to the RP on behalf of all its interested hosts. The RP receives the first few packets of the multicast stream, encapsulated in the PIM register message, from the source hosts. These messages are sent as a unicast to the RP. The RP de-encapsulates these packets and forwards them to the respective DRs.

---

### NOTE

DR election is based first on the router with the highest configured DR priority for an interface (if DR priority has been configured), and based next on the router with the highest IP address. To configure DR priority, use the **ip pim dr-priority** command. For more information about this command, refer to *Network OS Command Reference*.

---

## PIM prerequisites

PIM requires the following to function properly:

- The system should support receiving and transmitting unicast as well as multicast packets.
- A Routing Information Base (RIB) must be accessible for obtaining routing information.
- An IPC mechanism must be available.

- A timer mechanism must be available.
- An IGMP module should be available for correct operation of PIM when working as a DR.

## PIM standards conformity

The table below lists the level of Brocade conformity for various PIM-related RFCs.

**TABLE 1** PIM RFCs supported

Standard	Level (Y/N/Partial)	Notes
RFC 4601	Y	PIM-SM Protocol Specification
RFC 3973	N	PIM-DM Protocol Specification
RFC 5059	Partial	BSR mechanism for PIM supported
RFC 5060	Partial	PIM MIB supported
RFC 5240	N	BSR MIB
RFC 4610	N	Anycast-RP
RFC 3618	N	MSDP

## PIM limitations

In this release, PIM can be enabled on Brocade VX 6740 and VDX 8770 series platforms only. Also, only PIM Sparse Mode (PIM-SM) is supported at this time.

Static RP is not supported within the VCS cluster.

All PIM-enabled aggregation layer devices should have a direct Layer 3 connection to RP.

The following PIM features are not supported in this release:

- Non-stop routing (NSR)
- IP version 6
- VRF
- Prefix list
- Configuring the switch as the BSR candidate. However, the switch will be able to receive and process the BSR messages from other routers.
- Configuring the switch as the RP candidate.

## PIM supportability

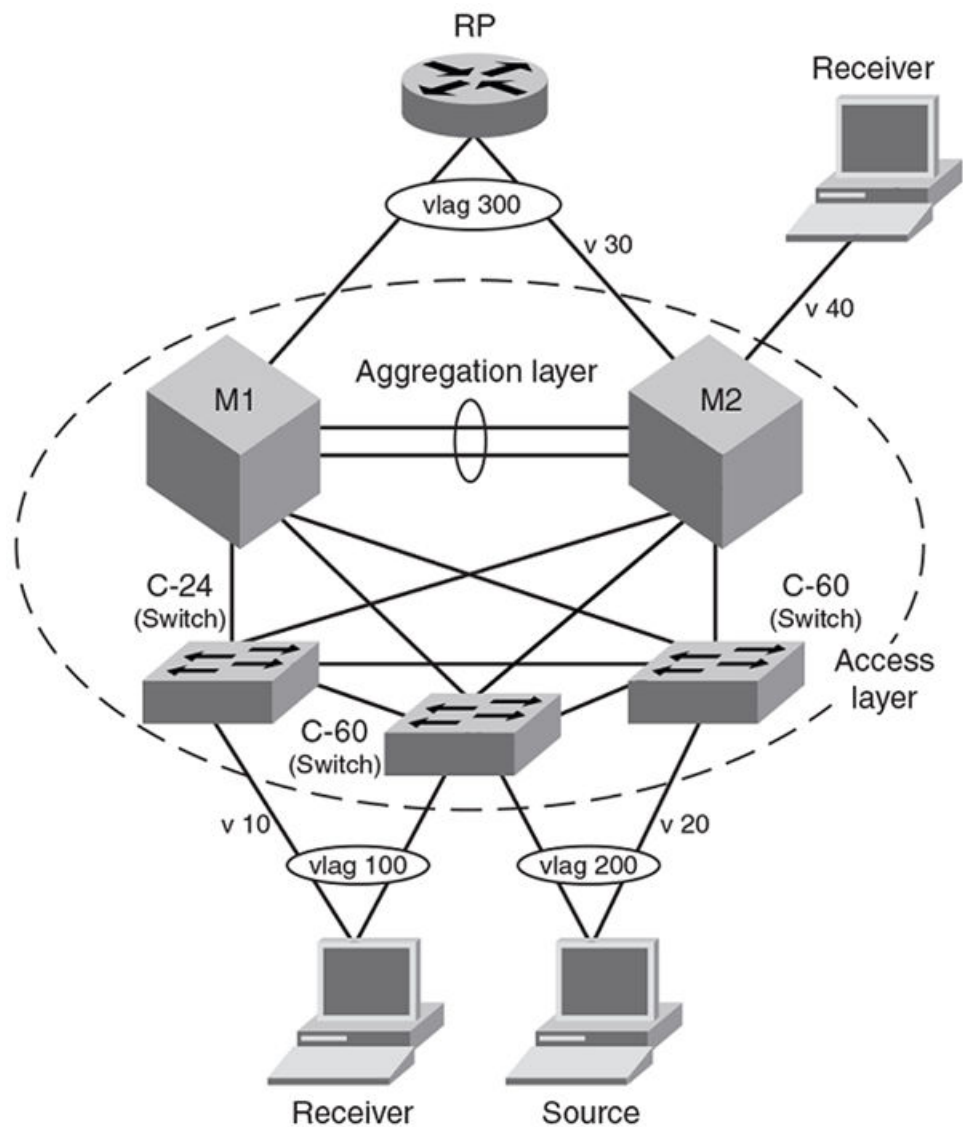
This release of Network OS includes the following PIM support:

- 32 virtual interfaces. The virtual interfaces can be either Layer 3 VLAN or router ports
- 32 output interfaces
- 4,000 Layer 3 multicast group IDs
- 2,000 (S,G) forwarding entries
- 256 (\*, G) forwarding entries
- A learning rate of 32 routes per second

## Configuring PIM

This section shows you an example PIM Sparse deployment and configuration, based on the figure below.

**FIGURE 3** Example deployment using single VCS





## PIM configuration prerequisites

- VLAGs must belong to PIM-enabled VLANs. For more information, refer to the “Configuring Link Aggregation” chapter of the *Network OS Layer 2 Switching Configuration Guide*.
- Set up your VLAGs before performing any PIM-specific configuration.
- Make sure that the rendezvous point (RP) is configured. This functionality should be provided by another router that is outside of the VCS Fabric.

---

### NOTE

RP functionality, either static or dynamic, is not supported inside the VCS Fabric.

- Make sure that the bootstrap router (BSR), if applicable to your setup, is configured. The BSR can be any third-party box that supports PIM, BSR, and rendezvous point (RP) functionality. If you are using a Brocade MLX switch as the bootstrap router, refer to the *Brocade MLX Series and NetTron Family Configuration Guide* for more information.

## Configuring PIM Sparse

---

### NOTE

If you are statically configuring the RP per PIM router, use the **router pim** and **rp-addr** commands, as described in the *Network OS Command Reference*

Refer to the example figure for a deployment using a single VCS in [Configuring PIM](#) on page 32

- M1 and M2 must be Brocade VDX 8770 or VDX 6740 switches.
- M1 is the designated router (DR) for virtual LAN 10 (labeled "v10") and virtual LAN 30 (labeled "v30").
- M2 is the designated router (DR) for virtual LAN 20 (labeled "v20") and virtual LAN 40 (labeled "v40").
- The switches labeled C-24 and C-60 can be any combination of Brocade VDX 6740 or VDX 8770 models. These switches are pure Layer 2 devices and need IGMP snooping enabled only.

The following steps show you how to configure PIM Sparse for the scenario depicted in the example figure for a deployment using a single VCS shown in [Configuring PIM](#) on page 32. These steps show you where to enable IGMP snooping, where to create IP addresses for Ve interfaces, and where to enable PIM Sparse:

1. Enable IGMP snooping on each access-level switch by performing the following steps on each of these switches:
  - a) From the switch console, in privileged EXEC mode, enter global configuration mode.  
switch# configure
  - b) Enter VLAN interface configuration mode for the first VLAN.  
switch (config)# int vlan 10
  - c) Enable IGMP snooping.  
switch(config-Vlan-10)# ip igmp snooping enable
  - d) Exit interface configuration mode.  
switch(config-Vlan-10)# exit
  - e) Enter VLAN interface configuration mode for the second VLAN.  
switch (config)# int vlan 20
  - f) Enable IGMP snooping.  
switch(config-Vlan-20)# ip igmp snooping enable
  - g) Exit interface configuration mode.  
switch(config-Vlan-20)# exit
  - h) Enter VLAN interface configuration mode for the third VLAN.  
switch (config)# int vlan 30

- i) Enable IGMP snooping.  
switch(config-Vlan-30)# ip igmp snooping enable
  - j) Exit interface configuration mode.  
switch(config-Vlan-30)# exit
  - k) Enter VLAN interface configuration mode for the fourth VLAN.  
switch (config)# int vlan 40
  - l) Enable IGMP snooping.  
switch(config-Vlan-40)# ip igmp snooping enable
  - m) Exit interface configuration mode.  
switch(config-Vlan-40)# exit
2. Do the following on switch M1 in the example figure for a deployment using a single VCS in [Configuring PIM](#) on page 32.
- a) From the switch console, in privileged EXEC mode, enter global configuration mode.  
switch# configure
  - b) Enter VLAN interface configuration mode for the first VLAN.  
switch (config)# int vlan 10
  - c) Enable IGMP snooping.  
switch(config-Vlan-10)# ip igmp snooping enable
  - d) Exit interface configuration mode.  
switch(config-Vlan-10)# exit
  - e) Enter RBridge ID configuration mode for the RBridge associated with this switch (for this example, it is assumed that an RBridge ID of 17 has already been configured for this switch).  
switch (config)# rbridge-id 17
  - f) Issue the **router pim** command to enable PIM for this switch.  
switch(config-rbridge-id-17)# router pim
  - g) To add a static rendezvous point (RP) configuration, add the RP address for the router PIM.  
switch(config-rbridge-id-17)# rp-address 10.22.22.22
  - h) Enter interface subconfiguration mode for the Ve interface associated with VLAN 10.  
switch(config-rbridge-id-17)# int ve 10
  - i) Enter the **no shut** command to activate the Ve interface and bring the ports online.  
switch (config-ve-10)# no shut
  - j) Assign a unique IP address for the interface:  
switch (config-ve-10)# ip addr 10.1.1.11/24
  - k) Enable PIM Sparse for this interface.  
switch (config-ve-10)# ip pim-sparse
  - l) Exit Ve configuration mode.  
switch (config-ve-10)# end
  - m) Repeat the configuration steps for each of the other VLANs in the example figure for a deployment using a single VCS in [Configuring PIM](#) on page 32.
3. Do the following on M2 in the example figure for a deployment using a single VCS in [Configuring PIM](#) on page 32:
- a) From the switch console, in privileged EXEC mode, enter global configuration mode.  
switch# configure
  - b) Enter VLAN interface configuration mode for the first VLAN.  
switch (config)# int vlan 10
  - c) Enable IGMP snooping.  
switch(config-Vlan-10)# ip igmp snooping enable
  - d) Exit interface configuration mode:  
switch(config-Vlan-10)# exit
  - e) Enter RBridge ID configuration mode for the RBridge associated with this switch (for this example, it is assumed that an RBridge ID of 2 has already been configured for this switch).  
switch (config)# rbridge-id 2
  - f) Issue the **router pim** command to enable PIM for this switch.  
switch(config-rbridge-id-2)# router pim
  - g) Enter interface subconfiguration mode for the Ve interface associated with VLAN 10.  
switch(config-rbridge-id-2)# int ve 10

- h) Enter the **no shut** command to activate the Ve interface and bring the ports online.  
switch (config-ve-10)# no shut
- i) Assign a unique IP address for the interface.  
switch (config-ve-10)# ip addr 10.1.1.12/24
- j) Enable PIM Sparse for this interface.  
switch (config-ve-10)# ip pim-sparse
- k) Exit Ve configuration mode.  
switch (config-ve-10)# end
- l) Repeat the configuration steps for each of the other VLANs shown in the example figure for a deployment using a single VCS in [Configuring PIM](#) on page 32.

**NOTE**

For more information about PIM, refer to the *Network OS Command Reference*. Global PIM CLIs are found in RBridge ID configuration mode, whereas the interface-level PIM CLIs are found under their respective interface subconfiguration modes.

## Restricting unknown multicast

The restrict-unknown-multicast feature prevents the default flooding of multicast traffic on all ports of a VLAN.

The PIM topology and VLANs must be configured before activating this feature.

1. Enter interface configuration mode for the VLAN whose unknown multicast traffic is to be restricted.  
switch(config)# interface vlan 100
2. Enter the **ip igmp snooping restrict-unknown-multicast** command.  
switch(config-Vlan-100)# ip igmp snooping restrict-unknown-multicast

# Configuring OSPF

---

- [OSPF overview](#)..... 36
- [Configuring OSPF](#)..... 45

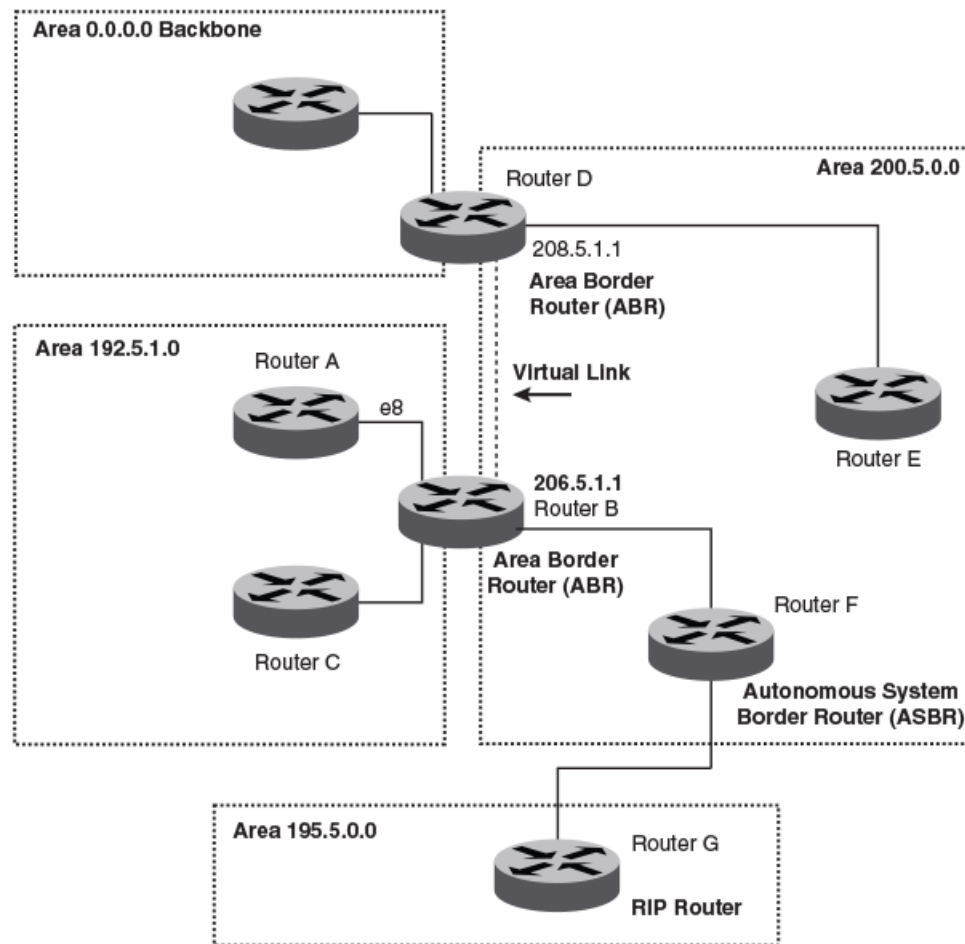
## OSPF overview

Open Shortest Path First (OSPF) is a link-state routing protocol that uses link-state advertisements (LSAs) to update neighboring routers about a router's interfaces. Each router maintains an identical area-topology database to determine the shortest path to any neighboring router.

OSPF is built upon a hierarchy of network components and *areas*. The highest level of the hierarchy is the *Autonomous System* (AS). An autonomous system is defined as a number of networks, all of which share the same routing and administration characteristics. A backbone area forms the core of the network, connecting all other areas. Details of these and other OSPF components are provided below.

### Autonomous System

An AS can be divided into multiple areas as shown in the figure below. Each area represents a collection of contiguous networks and hosts (refer to [OSPF areas](#) on page 39). Areas limit the amount of advertisements sent (called flooding) within the network. An area is represented in OSPF by either an IP address or a number.

**FIGURE 4** OSPF operating in a network**NOTE**

For details of components and virtual links, refer to [OSPF components and roles](#) on page 37 and [Virtual links](#) on page 41, respectively.

Once OSPF is enabled on the system, the user assigns an IP address or number as the *area ID* for each area. The area ID is representative of all IP addresses (subnets) on a router port. Each port on a router can support one area.

## OSPF components and roles

Routers can take a variety of roles in an OSPF topology, as discussed below.

### ***Area Border Routers***

An OSPF router can be a member of multiple areas. Routers with membership in multiple areas are known as *Area Border Routers (ABRs)*. All ABRs must have either a direct or indirect link to an OSPFv3 backbone area (0 or 0.0.0.0). Each ABR maintains a separate topological database for each area the router is in. Each topological database contains all LSA databases for each router within a given area.

The routers within the same area have identical topological databases. An ABR is responsible for forwarding routing information or changes among its border areas.

### ***Autonomous System Boundary Routers***

An *Autonomous System Boundary Router (ASBR)* is a router that is running multiple protocols and serves as a gateway to routers outside the OSPF domain and those operating with different protocols. The ASBR is able to import and translate different protocol routes into OSPF through a process known as *redistribution*. (For more information about redistribution, refer to the **redistribute** command in *Network OS Command Reference*.)

### ***Designated routers***

In an OSPF broadcast network, OSPF elects one router to serve as the designated router (DR) and another router on the segment to act as the backup designated router (BDR). This minimizes the amount of repetitive information that is forwarded on the network. OSPF forwards all messages to the designated router.

On broadcast networks such as LAN links, all routers on the LAN other than the DR and BDR form full adjacencies with the DR and BDR and pass LSAs only to them. The DR forwards updates received from one neighbor on the LAN to all other neighbors on that same LAN. One of the main functions of a DR is to ensure that all the routers on the same LAN have identical LSDBs. Therefore, on broadcast networks, an LSDB is synchronized between a DROther (a router that is not a DR or a BDR) and its DR and BDR.

---

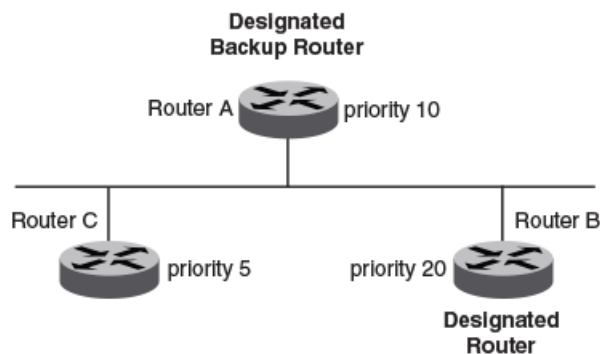
#### **NOTE**

In an OSPF point-to-point network, where a direct Layer 3 connection exists between a single pair of OSPF routers, there is no need for designated or backup designated routers.

---

In a network with no designated router and no backup designated router, the neighboring router with the highest priority is elected as the DR, and the router with the next highest priority is elected as the BDR, as shown in the figure below. Priority is a configurable option at the interface level; refer to the **ip ospf priority** command in *Network OS Command Reference*.

**FIGURE 5** Designated and backup router election



If the DR goes off line, the BDR automatically becomes the DR. The router with the next highest priority becomes the new BDR.

If two neighbors share the same priority, the router with the highest router ID is designated as the DR. The router with the next highest router ID is designated as the BDR. The DR and BDRs are recalculated after the OSPF protocol is disabled and re-enabled by means of the **[no] router ospf** command.

**NOTE**

By default, the Brocade device's router ID is the IP address configured on the lowest numbered loopback interface. If the device does not have a loopback interface, the default router ID is the lowest numbered IP address configured on the device.

When multiple routers on the same network are declaring themselves DRs, then both the priority and router ID are used to select the designated router and backup designated routers.

The DR and BDR election process is performed when one of the following events occurs:

- An interface is in a waiting state and the wait time expires.
- An interface is in a waiting state and receives a hello packet that addresses the BDR.
- A change in the neighbor state occurs, such as the following:
  - A neighbor state transitions from ATTEMPT state to a higher state.
  - Communication to a neighbor is lost.
  - A neighbor declares itself to be the DR or BDR for the first time.

## OSPF areas

Consider the topics discussed below when configuring OSPF areas.

### ***Backbone area***

The backbone area forms the core of OSPF and OSPFv3 networks. All OSPF and OSPFv3 areas are connected to the backbone area.

The backbone area (also known as area 0 or area 0.0.0.0) forms the core of OSPF and OSPFv3 networks. All other areas are connected to it, and inter-area routing happens by way of routers connected to the backbone area and to their own associated areas. The backbone area is the logical and physical structure for the OSPF domain and is attached to all non-zero areas in the OSPF domain.

The backbone area is responsible for distributing routing information between non-backbone areas. The backbone must be contiguous, but it does not need to be physically contiguous; backbone connectivity can be established and maintained through the configuration of virtual links.

### ***Area types***

An area can be *normal*, a *stub*, a *not-so-stubby area* (NSSA), or a *totally stubby area* (TSA).

- *Normal* — OSPF and OSPFv3 routers within a normal area can send and receive external link state advertisements (LSAs).
- *Stub* — OSPF and OSPFv3 routers within a stub area cannot send or receive external LSAs. In addition, OSPF and OSPFv3 routers in a stub area must use a default route to the area's Area Border Router (ABR) to send traffic out of the area.
- *NSSA* — The ASBR of an NSSA can import external route information into the area.
  - ASBRs redistribute (import) external routes into the NSSA as type 7 LSAs. Type 7 External LSAs are a special type of LSA generated only by ASBRs within an NSSA, and are flooded to all the routers within only that NSSA.
  - ABRs translate Type 7 LSAs into type-5 External LSAs, which can then be flooded throughout the AS. The NSSA translator converts type 7 LSA to type 5 LSA, if F-bit and P-bit are set and there is a reachable forwarding address. You can configure summary-addresses on the ABR of an NSSA so that the ABR converts multiple Type 7 external LSAs received from the NSSA into a single Type 5 external LSA.

When an NSSA contains more than one ABR, OSPF elects one of the ABRs to perform the LSA translation for NSSA. OSPF elects the ABR with the highest router ID. If the elected ABR becomes unavailable, OSPF automatically elects the ABR with the next highest router ID to take over translation of LSAs for the NSSA. The election process for NSSA ABRs is automatic.

- *TSA* — Similar to a stub area, a TSA does not allow summary routes in addition to not having external routes.

### ***Area range***

An aggregate value can be assigned to a range of IP and IPv6 addresses. This aggregate value is then advertised rather than all of the individual addresses it represents.

You can further consolidate routes at an area boundary by defining an area range. The area range allows you to assign an aggregate value to a range of IP and IPv6 addresses. This aggregate value becomes the address that is advertised instead of all the individual addresses it represents being advertised. You have the option of adding the cost to the summarized route. If you do not specify a value, the cost value is the default range metric calculation for the generated summary LSA cost. You can temporarily pause route summarization from the area by suppressing the Type 3 LSA so that the component networks remain hidden from other networks.

- You can assign up to 32 ranges in an OSPF area.
- You can assign up to 4 ranges in an OSPFv3 area.

### ***Totally stubby area***

By default, the area border router (ABR) sends summary LSAs (LSA Type 3) into stub areas. You can further reduce the number of link state advertisements (LSA) sent into a stub area by configuring the device to stop sending summary LSAs (Type 3 LSAs) into the area. This is called *assigning a totally stubby area (TSA)*. You can disable the summary LSAs when you are configuring the stub area or later after you have configured the area.

This feature disables origination of summary LSAs, but the device still accepts summary LSAs from OSPF neighbors and floods them to other neighbors.

When you enter a command to disable the summary LSAs, the change takes effect immediately. If you apply the option to a previously configured area, the device flushes all the summary LSAs it has generated (as an ABR) from the area.

---

#### **NOTE**

This feature applies only when the device is configured as an Area Border Router (ABR) for the area. To completely prevent summary LSAs from being sent to the area, disable the summary LSAs on each OSPF router that is an ABR for the area.

---

### ***Not-so-stubby area (NSSA)***

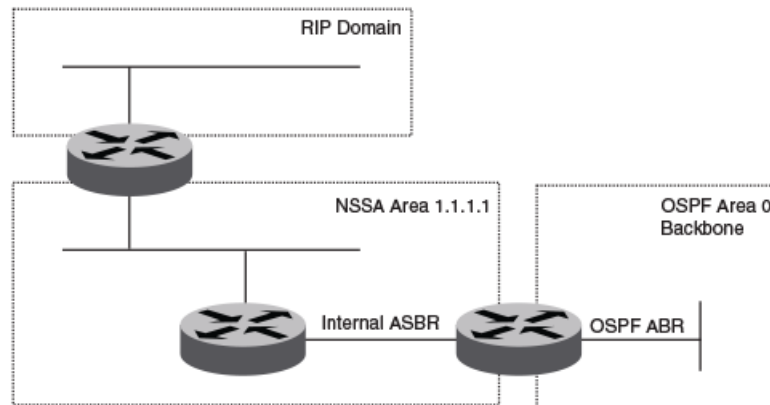
The OSPF not-so-stubby area (NSSA) feature enables you to configure OSPF areas that provide the benefits of stub areas, but that also are capable of importing external route information. OSPF does not flood external routes from other areas into an NSSA, but does translate and flood route information from the NSSA into other areas such as the backbone.

NSSAs are especially useful when you want to summarize Type 5 External LSAs (external routes) before forwarding them into an OSPF area. The OSPF specification prohibits summarization of Type 5 LSAs and requires OSPF to flood Type 5 LSAs throughout a routing domain. When you configure an NSSA, you can specify a summary-address for aggregating the external routes that the NSSA's ABR exports into other areas.



The figure below shows an example of an OSPF network containing an NSSA.

**FIGURE 6** OSPF network containing an NSSA



This example shows two routing domains, a RIP domain and an OSPF domain. The ASBR inside the NSSA imports external routes from RIP into the NSSA as Type 7 LSAs, which the ASBR floods throughout the NSSA.

The ABR translates the Type 7 LSAs into Type 5 LSAs. If a summary-address is configured for the NSSA, the ABR also summarizes the LSAs into an aggregate LSA before flooding the Type 5 LSAs into the backbone.

Because the NSSA is partially stubby the ABR does not flood external LSAs from the backbone into the NSSA. To provide access to the rest of the Autonomous System (AS), the ABR generates a default Type 7 LSA into the NSSA.

### ***Link state advertisements***

Communication among areas is provided by means of link state advertisements (LSAs). The LSAs supported for each area type are as follows:

- Backbone (area 0) supports LSAs 1, 2, 3, 4, 5, and 7.
- Nonbackbone, supports LSAs 1, 2, 3, 4, and 5.
- Stub area supports LSAs 1, 2, and 3.
- Totally stubby area (TSA) supports LSAs 1 and 2, and also supports a single LSA 3 per ABR, advertising a default route.
- No so stubby area (NSSA) supports LSAs 1, 2, 3, and 7.

## **Virtual links**

All ABRs must have either a direct or indirect link to the OSPF backbone area (0.0.0.0 or 0). If an ABR does not have a physical link to the area backbone, the ABR can configure a *virtual link* to another router within the same area, which has a physical connection to the area backbone.

The path for a virtual link is through an area shared by the neighbor ABR (router with a physical backbone connection), and the ABR requires a logical connection to the backbone.

Two parameters fields must be defined for all virtual links — transit area ID and neighbor router:

- The *transit area ID* represents the shared area of the two ABRs and serves as the connection point between the two routers. This number should match the area ID value.
- The *neighbor router* field is the router ID (IP address) of the router that is physically connected to the backbone, when assigned from the router interface requiring a logical connection. When assigning

the parameters from the router with the physical connection, be aware that the router ID is the IP address of the router requiring a logical connection to the backbone.

---

#### NOTE

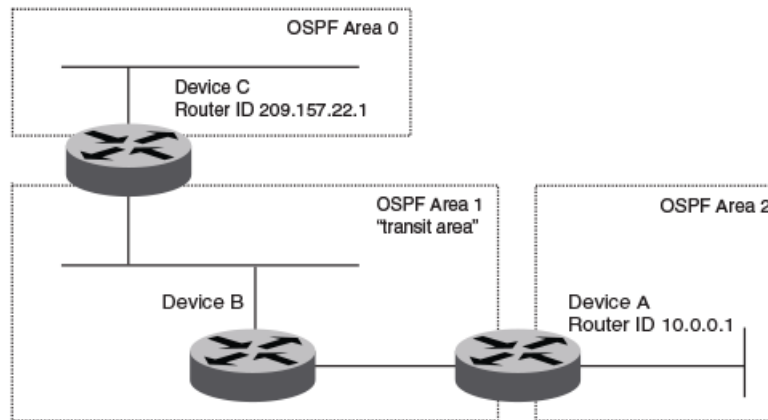
By default, a device's router ID is the IP address configured on the lowest numbered loopback interface. If the device does not have a loopback interface, the default router ID is the lowest numbered IP address configured on the device. When you establish an area virtual link, you must configure it on both of the routers (both ends of the virtual link).

---

Virtual links cannot be configured in stub areas and NSSAs.

The figure below shows an OSPF area border router, Device A, that is cut off from the backbone area (area 0). To provide backbone access to Device A, you can add a virtual link between Device A and Device C using area 1 as a transit area. To configure the virtual link, you define the link on the router that is at each end of the link. No configuration for the virtual link is required on the routers in the transit area.

**FIGURE 7** Defining OSPF virtual links within a network



## OSPFv2 graceful restart

OSPFv2 GR allows for planned and unplanned restarts where neighboring devices participate in the restart, helping to ensure that no route and topology changes occur in the network for the duration of the restart.

The graceful restart (GR) feature provides a routing device with the capability to inform its neighbors when it is performing a restart. Neighboring devices, known as GR helpers, are informed via protocol extensions that the device is undergoing a restart and assist in the restart. For the duration of the graceful restart, the restarting device and its neighbors continue forwarding packets ensuring there is no disruption to network performance or topology. When the restart is complete, the device is able to quickly resume full operation due to the assistance of the GR helpers.

There are two types of OSPFv2 graceful restart:

- **Planned restart:** the restarting routing device informs its neighbors before performing the restart. The GR helpers act as if the routing device is still within the network topology, continuing to forward traffic to the restarting routing device. A defined interval, known as a "grace period" is set to specify when the neighbors should consider the restart complete and the restarting routing device as part of the network topology again.
- **Unplanned restart:** the routing device restarts without warning due to a software fault.

---

**NOTE**

In order for a graceful restart on a routing device to be successful, the OSPF neighbors must have GR-helper mode enabled. GR-helper mode is enabled by default.

---

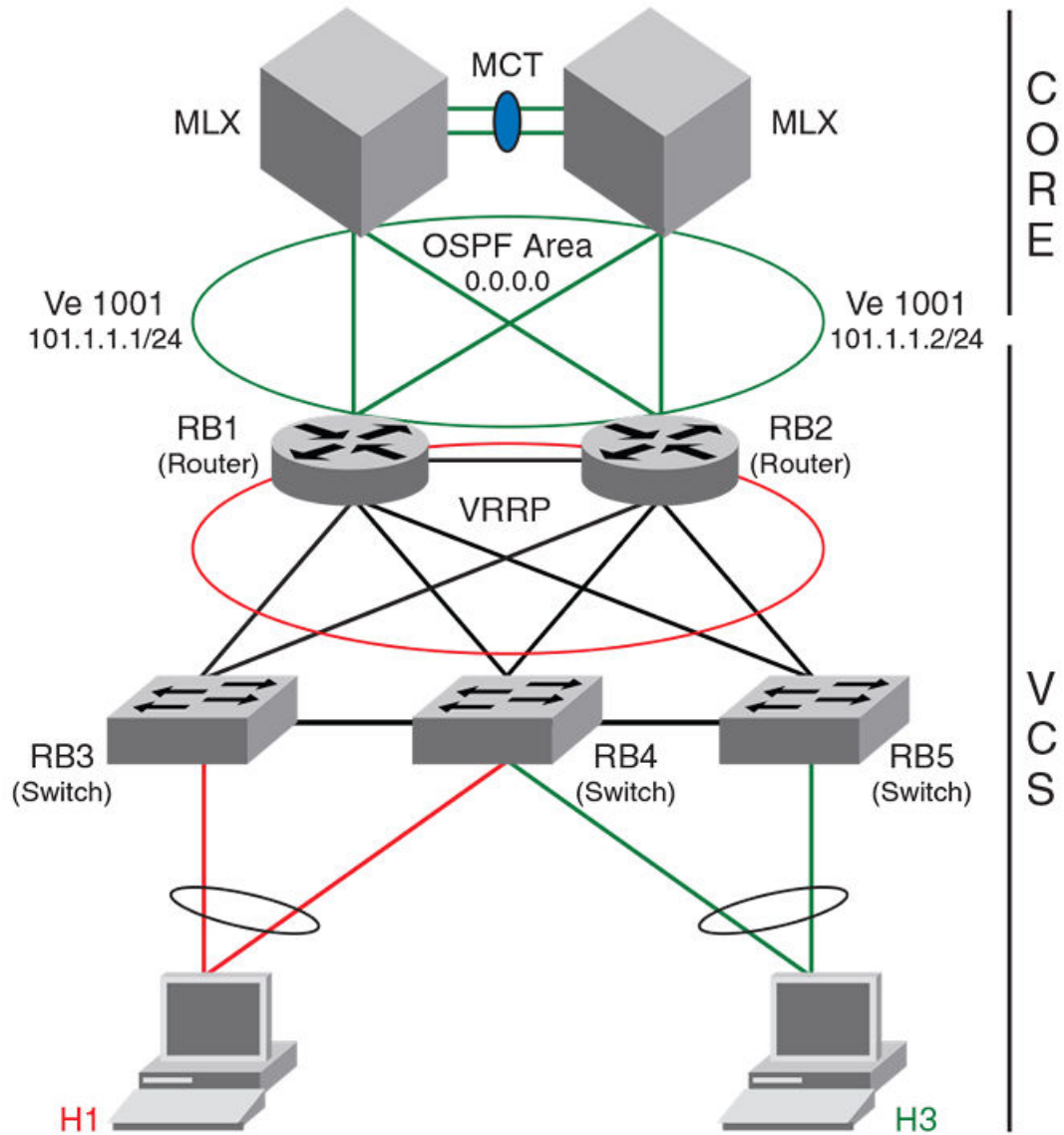
## OSPF over VRF

With Network OS 4.0 and later, OSPF can run over multiple Virtual Routing and Forwarding (VRF) instances. OSPF maintains multiple instances of the routing protocol to exchange route information among various VRF instances. A multi-VRF-capable router maps an input interface to a unique VRF, based on user configuration. These input interfaces can be physical or a switched virtual interface (SVI). By default, all input interfaces are attached to the default VRF instance. All OSPF commands supported in Network OS 4.0 and later are available over default and nondefault OSPF instances.

## OSPF in a VCS environment

The figure below shows one way in which OSPF can be used in a VCS fabric cluster environment. Routers RB1 and RB2, as well as the MLX switches, are configured with OSPF. Switches RB3, RB4, and RB5 are Layer 2 switches.

**FIGURE 8** OSPF example in a VCS environment



## OSPF considerations and limitations

- OSPF must be configured in a Virtual Cluster Switching (VCS) environment.
- The following platforms support OSPF:
  - Brocade VDX 6740
  - Brocade VDX 6740T
  - Brocade VDX 6740T-1G
  - Brocade VDX 8770-4
  - Brocade VDX 8770-8
- OSPF can be configured on either a point-to-point or broadcast network.
- OSPF can be enabled on the following interfaces: gigabitethernet, tengigabitethernet, fortygigabitethernet, loopback, and ve.

- On enabling OSPF over a loopback interface, the network is advertised as a stub network in the router LSA for the attached area. OSPF control packets, such as *hellos*, are not transmitted on loopback interfaces and adjacencies will not form.
- For VXLAN, if you are configuring a loopback interface to serve as a VTEP, you must manually configure distinct router-ids, using the **ip router id command**, for use by routing protocols.

## Configuring OSPF

Consider the topics discussed below when configuring OSPF.

### Performing basic OSPF configuration

This section addresses the basics of OSPF configuration.

#### *Enabling OSPF*

To begin using OSPF on the router, perform these steps:

1. Follow the rules below.
  - If a router is to operate as an ASBR, you must enable the ASBR capability at the system level.
  - Redistribution must be enabled on routers configured to operate as ASBRs.
  - All router ports must be assigned to one of the defined areas on an OSPF router. When a port is assigned to an area, all corresponding subnets on that port are automatically included in the assignment.
2. Enter the **router ospf** command in RBridge ID configuration mode to enable OSPF on the router. This is shown in [OSPF over VRF](#) on page 43.
3. Assign the areas to which the router will be attached. Refer to [Area types](#) on page 39.
4. Assign individual interfaces to the OSPF areas. Refer to [Assigning interfaces to an area](#) on page 47.
5. Assign a virtual link to any ABR that does not have a direct link to the OSPF backbone area. Refer to [Virtual links](#) on page 41.
6. Refer to [Changing default settings](#) on page 51.

#### *Setting up the backbone area*

To set up the backbone area shown in [Autonomous System](#) on page 36, do the following:

1. In privileged EXEC mode on Router A, issue the **configure** command to enter global configuration mode.
2. Enter the **rbridge-id** command followed by the RBridge ID to enter RBridge configuration mode.
3. Enter the **router ospf** command to enter OSPF configuration mode and enable OSPF on the router.
4. Enter the **area** command and specify *0.0.0.0* to configure the backbone area.
5. Enter the **exit** command until you return to global configuration mode.
6. Enter the **interface vlan** command followed by the VLAN number to create a VLAN.
7. Enter the **rbridge-id** command followed by the RBridge ID to enter RBridge configuration mode.
8. Enter the **interface ve** command followed by the VLAN number to enter interface configuration mode.

9. Enter the **ip address** operand followed by the IP address/subnet for the interface.
10. Issue the **ip ospf area** operand followed by the area ID to assign the interface to this area.

```
switch# configure
switch(config)# rbridge 10
switch(config-rbridge-id-10)# router ospf
switch(config-router-ospf-vrf-default-vrf)# area 0.0.0.0
switch(config-router-ospf-vrf-default-vrf)# exit
switch(config-rbridge-id-10)# exit
switch(config)# interface vlan 1001
switch(config-Vlan-1001)# rbridge 10
switch(config-rbridge-id-10)# interface Ve 1001
switch(config-Ve-1001)# ip address 101.1.1.1/24
switch(config-Ve-1001)# ip ospf area 0.0.0.0
```

### ***Configuring an NSSA***

To configure OSPF area 1.1.1.1 as an NSSA, do the following:

1. In privileged EXEC mode, enter the **configure** command to enter global configuration mode.
2. Enter the **rbridge-id** command followed by the RBridge ID to enter RBridge configuration mode.
3. Enter the **router ospf** command to enable OSPF on the router.
4. Enter **area** followed by the *area ID*, then **nssa** followed by the *NSSA ID*.

```
switch# configure
switch(config)# rbridge-id 101
switch(config-rbridge-id-101)# router ospf
Switch(config-router-ospf-vrf-default-vrf)# area 1.1.1.1 nssa 1
```

### ***Configuring a summary-address for the NSSA***

If you want the ABR that connects the NSSA to other areas to summarize the routes in the NSSA before translating them into Type 5 LSAs and flooding them into the other areas, configure a **summary-address**. The ABR creates an aggregate value based on the **summary-address**. The aggregate value becomes the address that the ABR advertises instead of advertising the individual addresses represented by the aggregate. You can configure up to 32 ranges in an OSPF area.

To configure a **summary-address** in NSSA 1.1.1.1 (this example assumes that you have already configured NSSA 1.1.1.1.), do the following:

1. In privileged EXEC mode, issue the **configure** command to enter global configuration mode.
2. Enter **rbridge-id** followed by the RBridge ID to enter RBridge configuration mode.
3. Enter **router ospf** to enable OSPF on the router and to enter router OSPF configuration mode.
4. Enter **area** followed by the *area ID*, then **nssa** followed by the *NSSA ID*.
5. Enter **summary-address** followed by the IP address and mask for the summary route.

```
switch# configure
switch(config)# rbridge-id 101
switch(config-rbridge-id-101)# router ospf
switch(config-router-ospf-vrf-default-vrf)# area 1.1.1.1 nssa 10
switch(config-router-ospf-vrf-default-vrf)# summary-address 209.157.1.0
255.255.255.0
```

### ***Disabling summary LSAs for a stub area***

To disable summary LSAs for a stub area, enter a command such as the following:

```
switch(config-router-ospf-vrf-default-vrf)area 40 stub 99 no-summary
```

### ***Assigning an area range (optional)***

You can assign a *range* for an area, but it is not required. Ranges allow a specific IP address and mask to represent a range of IP addresses within an area, so that only that reference range address is advertised to the network, instead of all the addresses within that range. Each area can have up to 32 range addresses. For example, to define an area range for subnets on 0.0.0.10 and 0.0.0.20, do the following:

1. In privileged EXEC mode, issue the **configure** command to enter global configuration mode.
2. Issue the **rbridge-id** command followed by the RBridge ID to enter RBridge configuration mode.
3. Issue the **router ospf** command to enable OSPF on the router.
4. Issue the **area** operand followed by the area ID, then enter the range, and repeat as necessary.

```
switch# configure
switch(config)# rbridge-id 101
switch(config-rbridge-id-101)# router ospf
switch(config-router-ospf-vrf-default-vrf)# area 0.0.0.10 range 192.45.0.0 255.255.0.0
switch(config-router-ospf-vrf-default-vrf)# area 0.0.0.20 range 192.45.0.0 255.255.0.0
```

### ***Assigning interfaces to an area***

Once you define OSPF areas, you can assign interfaces to the areas. All router ports must be assigned to one of the defined areas on an OSPF router. When a port is assigned to an area, all corresponding subnets on that port are automatically included in the assignment.

For example, to assign a tengigabitethernet interface 101/0/1 to a router area whose IP address is 192.5.0.0, do the following:

1. In privileged EXEC mode, issue the **configure** command to enter global configuration mode.
2. Issue the **rbridge-id** command followed by the RBridge ID to enter RBridge sub-configuration mode.
3. Issue the **interface** command followed by the interface ID to enter interface configuration mode.
4. Issue the **ip ospf area** command followed by the IP address of the area.

```
switch# configure
switch(config)# rbridge-id 101
switch(config-rbridge-id-101)# int te 101/0/1
switch(config-if-te-101/0/1)# ip ospf area 192.5.0.0
```

If you want to set an interface to passive mode, use the **ip ospf passive** command. If you want to block flooding of outbound LSAs on specific OSPF interfaces, use the **ip ospf database-filter all out** command.(Refer to the *Network OS Command Reference* for details.)

### ***Configuring virtual links***

Refer to [Virtual links](#) on page 41.

Do the following to configure virtual links. To define the virtual link on Device A:

1. In privileged EXEC mode, issue the **configure** command to enter global configuration mode.
2. Enter the **rbridge-id** command followed by the RBridge ID to enter RBridge configuration mode.
3. Enter the **router ospf** command to enable OSPF on the router.
4. Enter the **area** operand followed by the area ID, and repeat as necessary.
5. Enter the **area** operand followed by the area address in decimal or dotted-decimal format, then enter the **virtual-link** operand followed by ID of the OSPF router at the remote end of the virtual link.

```
Device A# configure
Device A(config)# rbridge-id 101
Device A(config-rbridge-id-101)# router ospf
Device A(config-router-ospf-vrf-default-vrf)# area 2
Device A(config-router-ospf-vrf-default-vrf)# area 1
Device A(config-router-ospf-vrf-default-vrf)# area 1 virtual-link 209.157.22.1
```

To configure the virtual link on Device C:

6. In privileged EXEC mode, issue the **configure** command to enter global configuration mode.
7. Enter the **rbridge-id** command followed by the RBridge ID to enter RBridge configuration mode.
8. Enter the **router ospf** command to enable OSPF on the router.
9. Enter the **area** operand followed by the area ID, and repeat as necessary.
10. Enter the **area** operand followed by the area address in decimal or dotted-decimal format, then enter the **virtual-link** operand followed by ID of the OSPF router at the remote end of the virtual link

```
Device C# configure
Device C(config)# rbridge-id 101
Device C(config-rbridge-id-101)# router ospf
Device C(config-router-ospf-vrf-default-vrf)# area 0
Device C(config-router-ospf-vrf-default-vrf)# area 1
Device C(config-router-ospf-vrf-default-vrf)# area 1 virtual-link 10.0.0.1
```

## Disabling OSPFv2 graceful restart

The OSPFv2 graceful restart (GR) feature is enabled by default, and can be disabled on a routing device.

1. Enter **configure**.

```
device# configure
```

2. Enter the **rbridge-id** command with an RBridge ID to enter RBridge ID configuration mode.

```
device(config)# rbridge-id 122
```

3. Enter the **router ospf** command to enter OSPF VRF router configuration mode and enable OSPFv2 globally.

```
device(config-rbridge-id-122)# router ospf
```

4. (Optional) Enter the **no graceful restart** command to disable GR on the device.

```
device(config-router-ospf-vrf-default-vrf)# no graceful-restart
```

In the following example, the GR feature is disabled.

```
device# configure
device(config)# rbridge-id 122
device(config-rbridge-id-122)# router ospf
device(config-router-ospf-vrf-default-vrf)# no graceful restart
```

## Re-enabling OSPFv2 graceful restart

If you disable the OSPFv2 graceful restart (GR) feature, you can re-enable it. You can also change the maximum restart wait time from the default value of 120 seconds.

1. Enter **configure**.

```
device# configure
```

2. Enter the **rbridge-id** command with an RBridge ID to enter RBridge ID configuration mode.

```
device(config)# rbridge-id 122
```



3. Enter the **router ospf** command to enter OSPF VRF router configuration mode and enable OSPFv2 globally.

```
device(config-rbridge-id-122)# router ospf
```

4. (Optional) Enter the **graceful restart** command with the **restart-time** parameter and specify a value to re-enable GR on the device, and change the maximum restart wait time from the default value of 120 seconds.

```
device(config-router-ospf-vrf-default-vrf)# graceful-restart restart-time 240
```

In the following example, the GR feature is re-enabled and the maximum restart wait time is changed from the default value of 120 seconds to 240 seconds.

```
device# configure
device(config)# rbridge-id 122
device(config-rbridge-id-122)# router ospf
device(config-router-ospf-vrf-default-vrf)# graceful-restart restart-time 240
```

## Disabling OSPFv2 graceful restart helper

The OSPFv2 graceful restart (GR) helper feature is enabled by default, and can be disabled on a routing device.

1. Enter **configure**.

```
device# configure
```

2. Enter the **rbridge-id** command with an RBridge ID to enter RBridge ID configuration mode.

```
device(config)# rbridge-id 122
```

3. Enter the **router ospf** command to enter OSPF VRF router configuration mode and enable OSPFv2 globally.

```
device(config-rbridge-id-122)# router ospf
```

4. Enter the **graceful-restart** command using the **helper-disable** keyword to disable the GR helper feature.

```
device(config-router-ospf-vrf-default-vrf)# graceful-restart helper-disable
```

In the following example, the GR helper feature is disabled.

```
device# configure
device(config)# rbridge-id 122
device(config-rbridge-id-122)# router ospf
device(config-router-ospf-vrf-default-vrf)# graceful restart helper-disable
```

## OSPFv2 non-stop routing (NSR)

OSPFv2 can continue operation without interruption during hitless failover when the NSR feature is enabled.

In graceful restart (GR), the restarting neighbors need to help build routing information during a failover. However, the GR helper may not be supported by all devices in a network. The non-stop routing (NSR) feature eliminates this dependency.

NSR does not require support from neighboring devices to perform hitless failover, and OSPF can continue operation without interruption.

**NOTE**

NSR does not support IPv6-over-IPv4 tunnel and virtual link, so traffic loss is expected while performing hitless failover.

**Enabling OSPF over VRF**

Do the following to enable OSPF over VRF.

- To enable OSPF on a default VRF and to enter OSPF VRF router configuration mode, run the **router ospf** command in RBridge ID configuration mode, as shown in the following example:
 

```
switch# configure
switch(config)# rbridge-id 5
switch(config-rbridge-id-5)# router ospf
switch(config-router-ospf-vrf-default-vrf)#
```
- To enable OSPF on a non-default VRF and to enter OSPF VRF router configuration mode, run the **router ospf vrf name** command in RBridge ID configuration mode, as shown in the following example:
 

```
switch# configure
switch(config)# rbridge-id 5
switch(config-rbridge-id-5)# router ospf vrf vrfname
switch(config-router-ospf-vrf-vrfname)#
```
- OSPF **show** commands include the optional **vrf name** keyword to display data from non-default OSPF instances.
- Router-ID calculation for an OSPF instance includes IP addresses that are attached to the same VRF. The same subnets can coexist on multiple VRFs.

**Enabling OSPF in a VCS environment**

Do the following to enable OSPF in a VCS environment.

**NOTE**

If no RBridge ID is configured on the switch, deleting an VE interface will cause a spike in CPU usage. To prevent this, configure an RBridge ID before deleting a VE interface.

1. On Router RB1, do the following:
  - a) Enter the **conf t** command to enter terminal configuration mode.
  - b) Enter the **interface vlan** command followed by the VLAN number to create a VLAN for the router.
  - c) Enter the **exit** command to exit interface configuration mode.
  - d) Enter the **rbridge-id** command followed by the RBridge ID to enter RBridge configuration mode.
  - e) Enter the **router ospf** command to enable the OSPF routing protocol and to enter OSPF VRF router configuration mode.
  - f) Enter the **area** operand followed by the area ID to create this OSPF area on this router.
  - g) Enter the **exit** command to exit OSPF VRF router configuration mode.
  - h) Enter the **interface ve** command followed by the VLAN number to enter interface configuration mode.
  - i) Enter the **ip address** operand followed by the IP address/subnet of the interface.
  - j) Enter the **ip ospf area** operand followed by the area ID to assign the interface to this area.
  - k) Enter the **no shutdown** command:
 

```
RB1# conf t
RB1(config)# interface vlan 1001
```

```

RB1(config-Vlan-1001)# exit
RB1(config)# rbridge-id 1

RB1(config-rbridge-id-1)# router ospf
RB1(config-router-ospf-vrf-default-vrf)# area 0.0.0.0
RB1(config-router-ospf-vrf-default-vrf)# exit
RB1(config-rbridge-id-1)# interface ve 1001
RB1(config-Ve-1001)# ip address 101.1.1.1/24
RB1(config-Ve-1001)# ip ospf area 0.0.0.0
RB1(config-Ve-1001)# no shutdown

```

2. On Router RB2, do the following:

- a) Enter the **conf t** command to enter terminal configuration mode.
- b) Enter the **interface vlan** command followed by the VLAN number to create a VLAN for the router.
- c) Enter the **exit** command to exit interface configuration mode.
- d) Enter the **rbridge-id** command followed by the RBridge ID to enter RBridge configuration mode.
- e) Enter the **router ospf** command to enable the OSPF routing protocol and to enter OSPF VRF router configuration mode.
- f) Enter the **area** operand followed by the area ID to create this OSPF area on this router.
- g) Enter the **exit** command to exit OSPF VRF router configuration mode.
- h) Enter the **interface ve** command followed by the VLAN number to enter interface configuration mode.
- i) Enter the **ip address** operand followed by the IP address/subnet of the interface.
- j) Enter the **ip ospf area** operand followed by the area ID to assign the interface to this area.
- k) Enter the **no shutdown** command:
 

```

RB2# conf t
RB2(config)# interface vlan 1001
RB2(config-Vlan-1001)# exit
RB2(config)# rbridge-id 2

RB2(config-rbridge-id-2)# router ospf
RB2(config-router-ospf-vrf-default-vrf)# area 0.0.0.0
RB2(config-router-ospf-vrf-default-vrf)# exit
RB2(config-rbridge-id-2)# interface ve 1001
RB2(config-Ve-1001)# ip address 101.1.1.2/24
RB2(config-Ve-1001)# ip ospf area 0.0.0.0
RB2(config-Ve-1001)# no shutdown

```
- l) Assign VLAN 1001 to a vLAG.

## Changing default settings

Refer to the *Network OS Command Reference* for other commands you can use to change default OSPF settings. Some commonly configured items include the following:

- Changing reference bandwidth to change interface costs by using the **auto-cost reference-bandwidth** command.
- Defining redistribution filters for the Autonomous System Boundary Router (ASBR) by using the **redistribute** command.

## Disabling and re-enabling OSPF event logging

OSPF event logging can be configured, disabled, and re-enabled.

1. Enter the **configure terminal** command to access global configuration mode.

```
device# configure terminal
```

2. Enter the **rbridge-id** command with an RBridge ID to enter RBridge ID configuration mode.

```
device(config)# rbridge-id 1
```

3. Enter the **router ospf** command to enter OSPF configuration mode and enable OSPF globally.

```
device(config-rbridge-id-1)# router ospf
```

4. Enter the **no log** command to disable the logging of OSPF events.

```
device(config-router-ospf-vrf-default-vrf)# no log
```

The following example re-enables the logging of all OSPF events.

```
device# configure terminal
device(config)# rbridge-id 1
device(config-rbridge-id-1)# router ospf
device(config-router-ospf-vrf-default-vrf)# log all
```

## Disabling OSPF on the router

Consider the topics discussed below when disabling OSPF.

### *Understanding the effects of disabling OSPF*

Consider the following before disabling OSPF on a router:

- If you disable OSPF, the device removes all the configuration information for the disabled protocol from the running configuration. Moreover, when you save the configuration to the startup configuration file after disabling one of these protocols, all the configuration information for the disabled protocol is removed from the startup configuration file.
- If you are testing an OSPF configuration and are likely to disable and re-enable the protocol, you might want to make a backup copy of the startup configuration file containing the protocol's configuration information. This way, if you remove the configuration information by saving the configuration after disabling the protocol, you can restore the configuration by copying the backup copy of the startup configuration file into the flash memory.
- If the management default route information is available in the Chassis ID (CID) card, the OSPF default route is overwritten by the management default route when the switch reboots. In order to prevent this, remove the management default route after the switch reboots. The OSPF default route is automatically re-instated. Refer to the "Using the Chassis ID (CID) Recovery Tool" chapter in the *Network OS Software Troubleshooting Guide*.

### *Disabling OSPF*

To disable OSPF on the router, use the **no router ospf** command:

1. In privileged EXEC mode, issue the **configure** command to enter global configuration mode.
2. Enter the **rbridge-id** command followed by the RBridge ID to enter RBridge configuration mode.
3. Issue the **no router ospf** command to disable OSPF on the router.

```
switch# configure
switch(config)# rbridge-id 101
switch(config-rbridge-id-101)# no router ospf
```

# Configuring OSPFv3

---

• OSPFv3 overview.....	53
• OSPFv3 considerations and limitations.....	54
• OSPFv3 areas.....	54
• Virtual links.....	57
• OSPFv3 route redistribution.....	59
• Default route origination.....	60
• Filtering OSPFv3 routes.....	61
• SPF timers.....	61
• OSPFv3 administrative distance.....	61
• OSPFv3 LSA refreshes.....	62
• OSPFv3 over VRF.....	62
• OSPFv3 graceful restart helper.....	63
• OSPFv3 non-stop routing (NSR).....	63
• IPsec for OSPFv3.....	63
• IPsec for OSPFv3 configuration.....	64
• Configuring OSPFv3.....	65

## OSPFv3 overview

IPv6 supports OSPF Version 3 (OSPFv3). OSPFv3 functions similarly to OSPF Version 2 (OSPFv2), with several enhancements.

Open Shortest Path First (OSPF) is a link-state routing protocol. OSPF uses link-state advertisements (LSAs) to update neighboring routers about its interfaces and information on those interfaces. A device floods LSAs to all neighboring routers to update them about the interfaces. Each router maintains an identical database that describes its area topology to help a router determine the shortest path between it and any neighboring router.

IPv6 supports OSPF Version 3 (OSPFv3), which functions similarly to OSPF Version 2 (OSPFv2), the version that IPv4 supports, except for the following enhancements:

- Support for IPv6 addresses and prefixes.
- Ability to configure several IPv6 addresses on a device interface. (While OSPFv2 runs per IP subnet, OSPFv3 runs per link. In general, you can configure several IPv6 addresses on a router interface, but OSPFv3 forms one adjacency per interface only, using the interface associated link-local address as the source for OSPF protocol packets. On virtual links, OSPFv3 uses the global IP address as the source. OSPFv3 imports all or none of the address prefixes configured on a router interface. You cannot select the addresses to import.)
- Ability to run one instance of OSPFv2 and one instance of OSPFv3 concurrently on a link.
- Support for IPv6 link-state advertisements (LSAs).

---

### NOTE

Although OSPFv2 and OSPFv3 function in a similar manner, Brocade has implemented the user interface for each version independently of the other. Therefore, any configuration of OSPFv2 features will not affect the configuration of OSPFv3 features and vice versa.

---

---

**NOTE**

You are required to configure a router ID when running only IPv6 routing protocols.

---

## OSPFv3 considerations and limitations

There are a number of things to consider when configuring OSPFv3.

- OSPFv3 must be configured in a VCS environment.
- OSPFv3 can be configured on either a point-to-point or broadcast network.
- OSPFv3 can be enabled on the following interfaces: gigabitethernet, tengigabitethernet, fortygigabitethernet, hundredgigabitethernet, loopback, and ve.
- On enabling OSPFv3 over a loopback interface, the network is advertised as a stub network in the router LSA for the attached area. OSPFv3 control packets, such as *hellos*, are not transmitted on loopback interfaces and adjacencies will not form.

## OSPFv3 areas

IPv6 addresses or a number can be assigned as the area ID for an OSPFv3 area.

After OSPFv3 is enabled, you can assign OSPFv3 areas. You can assign an IPv6 address or a number as the area ID for each area. The area ID is representative of all IPv4 addresses (subnets) on a device interface. Each device interface can support one area.

---

**NOTE**

You can assign only one area on a device interface.

---

### Backbone area

The backbone area forms the core of OSPF and OSPFv3 networks. All OSPF and OSPFv3 areas are connected to the backbone area.

The backbone area (also known as area 0 or area 0.0.0.0) forms the core of OSPF and OSPFv3 networks. All other areas are connected to it, and inter-area routing happens by way of routers connected to the backbone area and to their own associated areas. The backbone area is the logical and physical structure for the OSPF domain and is attached to all non-zero areas in the OSPF domain.

The backbone area is responsible for distributing routing information between non-backbone areas. The backbone must be contiguous, but it does not need to be physically contiguous; backbone connectivity can be established and maintained through the configuration of virtual links.

## Area types

OSPFv3 areas can be normal, a stub area, a totally stubby area, or a not-so-stubby area (NSSA).

- Normal - OSPFv3 devices within a normal area can send and receive External Link State Advertisements (LSAs).
- Stub - OSPFv3 devices within a stub area cannot send or receive External LSAs. In addition, OSPF devices in a stub area must use a default route to the area's Area Border Router (ABR) to send traffic out of the area.
- TSA – Similar to a stub area, a TSA does not allow summary routes in addition to not having external routes.
- NSSA - The ASBR of an NSSA can import external route information into the area.
  - ASBRs redistribute (import) external routes into the NSSA as type 7 LSAs. Type 7 External LSAs are a special type of LSA generated only by ASBRs within an NSSA, and are flooded to all the routers within only that NSSA.
  - ABRs translate type 7 LSAs into type 5 External LSAs, which can then be flooded throughout the autonomous system. The NSSA translator converts type 7 LSA to type 5 LSA, if F-bit and P-bit are set and there is a reachable forwarding address. ABR translates to type 5 only when P bit is set in type 7 LSA.

When an NSSA contains more than one ABR, OSPFv3 elects one of the ABRs to perform the LSA translation for NSSA. OSPF elects the ABR with the highest router ID. If the elected ABR becomes unavailable, OSPFv3 automatically elects the ABR with the next highest router ID to take over translation of LSAs for the NSSA. The election process for NSSA ABRs is automatic.

## Area range

An aggregate value can be assigned to a range of IP and IPv6 addresses. This aggregate value is then advertised rather than all of the individual addresses it represents.

You can further consolidate routes at an area boundary by defining an area range. The area range allows you to assign an aggregate value to a range of IP and IPv6 addresses. This aggregate value becomes the address that is advertised instead of all the individual addresses it represents being advertised. You have the option of adding the cost to the summarized route. If you do not specify a value, the cost value is the default range metric calculation for the generated summary LSA cost. You can temporarily pause route summarization from the area by suppressing the Type 3 LSA so that the component networks remain hidden from other networks.

- You can assign up to 32 ranges in an OSPF area.
- You can assign up to 4 ranges in an OSPFv3 area.

## Stub area

A stub area is an area in which you don't allow advertisements of external routes, reducing the size of the database. The number of LSAs sent into a stub area can be reduced.

By default, the Area Border Router (ABR) sends summary LSAs (type 3 LSAs) into stub areas. You can reduce the number of LSAs sent into a stub area by configuring the device to stop sending summary LSAs into the area. You can disable the summary LSAs when you are configuring the stub area or after you have configured the area.

The **area stub no-summary** feature disables origination of summary LSAs into a stub area, but the device still accepts summary LSAs from OSPFv3 neighbors and floods them to other areas. The device can form adjacencies with other routers regardless of whether summarization is enabled or disabled for areas on each router.

When you disable the summary LSAs, the change takes effect immediately. If you apply the option to a previously configured area, the device flushes all of the summary LSAs it has generated (as an ABR) from the area.

---

**NOTE**

This feature applies only when the Brocade device is configured as an Area Border Router (ABR) for the area. To completely prevent summary LSAs from being sent to the area, disable the summary LSAs on each OSPFv3 router that is an ABR for the area.

---

## Totally stubby area

By default, the area border router (ABR) sends summary LSAs (LSA Type 3) into stub areas. You can further reduce the number of link state advertisements (LSA) sent into a stub area by configuring the device to stop sending summary LSAs (Type 3 LSAs) into the area. This is called *assigning a totally stubby area (TSA)*. You can disable the summary LSAs when you are configuring the stub area or later after you have configured the area.

This feature disables origination of summary LSAs, but the device still accepts summary LSAs from OSPF neighbors and floods them to other neighbors.

When you enter a command to disable the summary LSAs, the change takes effect immediately. If you apply the option to a previously configured area, the device flushes all the summary LSAs it has generated (as an ABR) from the area.

---

**NOTE**

This feature applies only when the device is configured as an Area Border Router (ABR) for the area. To completely prevent summary LSAs from being sent to the area, disable the summary LSAs on each OSPF router that is an ABR for the area.

---

## Not-so-stubby area

NSSAs are OSPFv3 areas that provide the benefits of stub areas with the extra capability of importing external route information.

The OSPFv3 not-so-stubby-area (NSSA) enables you to configure OSPFv3 areas that provide the benefits of stub areas, but that also are capable of importing external route information. OSPFv3 does not flood external routes from other areas into an NSSA, but does translate and flood route information from the NSSA into other areas such as the backbone.

NSSAs are especially useful when you want to advertise type 5 External LSAs (external routes) before forwarding them into an OSPFv3 area. The OSPFv3 specification (RFC 5340) prohibits the advertising of type 5 LSAs and requires OSPFv3 to flood type 5 LSAs throughout a routing domain. When you configure a NSSA, you can specify an address range for aggregating the external routes that the ABR of the NSSAs exports into other areas.

You can block the generation of type 3 and type 7 LSAs into an NSSA. You can also configure the NSSAs translator role. If the router is an ABR, a type 3 summary LSA is originated into the NSSA. If the router is an ASBR, type 7 NSSA External LSA is generated into the NSSA with a default external metric value of 10. The router's NSSA translator role is set to candidate and the router participates in NSSA translation election.

In the case where an ASBR should generate type 5 LSA into normal areas and should not generate type 7 LSA into a NSSA, you can prevent an NSSA ABR from generating type 7 LSA into a NSSA.



If the router is an ABR, you can prevent any type 3 and type 4 LSA from being injected into the area. The only exception is that a default route is injected into the NSSA by the ABR, and strictly as a type 3 LSA.

## LSA types for OSPFv3

Communication among OSPFv3 areas is provided by means of link state advertisements (LSAs). OSPFv3 supports a number of types of LSAs.

- Router LSAs (Type 1)
- Network LSAs (Type 2)
- Interarea-prefix LSAs for ABRs (Type 3)
- Interarea-router LSAs for ASBRs (Type 4)
- Autonomous system External LSAs (Type 5)
- Group Membership LSA (Type 6)
- NSSA External LSAs (Type 7)
- Link LSAs (Type 8)
- Intra-area-prefix LSAs (Type 9)

For more information about these LSAs, refer to RFC 5340.

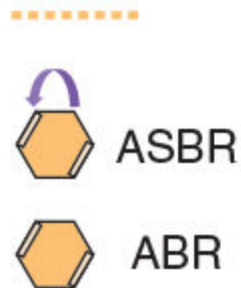
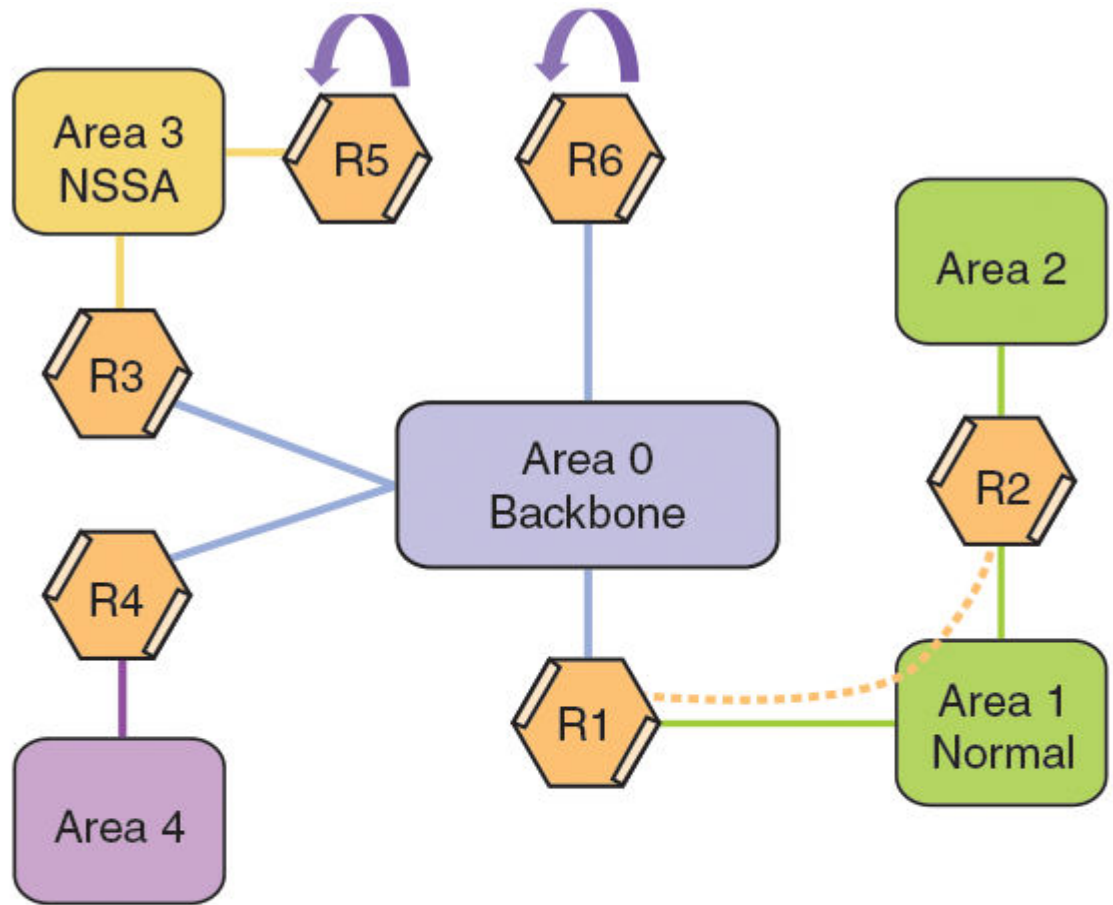
## Virtual links

If an ABR does not have a physical link to a backbone area, a virtual link can be configured from the ABR to another device within the same area that has a physical connection to the backbone area.

All ABRs must have either a direct or indirect link to an OSPFv3 backbone area (0 or 0.0.0.0). If an ABR does not have a physical link to a backbone area, you can configure a virtual link from the ABR to another router within the same area that has a physical connection to the backbone area.

The path for a virtual link is through an area shared by the neighbor ABR (router with a physical backbone connection) and the ABR requiring a logical connection to the backbone.

In the figure below a virtual link has been created between ABR1 and ABR2. ABR1 has a direct link to the backbone area, while ABR2 has an indirect link to the backbone area through Area 1.



Two parameters must be defined for all virtual links -- transit area ID and neighbor router:

- The transit area ID represents the shared area of the two ABRs and serves as the connection point between the two routers. This number should match the area ID value.
- The neighbor router is the router ID (IPv4 address) of the router that is physically connected to the backbone when assigned from the router interface requiring a logical connection. The neighbor router is the router ID (IPv4 address) of the router requiring a logical connection to the backbone when assigned from the router interface with the physical connection.

---

**NOTE**

By default, the router ID is the IPv4 address configured on the lowest-numbered loopback interface. If the device does not have a loopback interface, the default router ID is the highest-numbered IPv4 address configured on the device.

---

When you establish an area virtual link, you must configure it on both ends of the virtual link. For example, imagine that ABR1 in areas 1 and 2 is cut off from the backbone area (area 0). To provide backbone access to ABR1, you can add a virtual link between ABR1 and ABR2 in area 1 using area 1 as a transit area. To configure the virtual link, you define the link on the router that is at each end of the link. No configuration for the virtual link is required on the routers in the transit area.

Virtual links cannot be configured in stub areas and NSSAs.

## Virtual link source address assignment

When routers at both ends of a virtual link communicate, the source address included in the packets must be a global IPv6 address that is automatically selected for each transit area.

When routers at both ends of a virtual link communicate with one another, the source address included in the packets must be a global IPv6 address. A global IPv6 address is automatically selected for each transit area and this address is advertised into the transit area of the intra-area-prefix LSA. The automatically selected global IPv6 address for a transit area is the first global IPv6 address of any loopback interface in the transit area. If no global IPv6 address is available on a loopback interface in the area, the first global IPv6 address of the lowest-numbered interface in the UP state (belonging to the transit area) is assigned. If no global IPv6 address is configured on any of the OSPFv3 interfaces in the transit area, the virtual links in the transit area do not operate. The automatically selected IPv6 global address is updated whenever the previously selected IPv6 address of the interface changes, is removed, or if the interface goes down.

---

**NOTE**

The existing selected virtual link address does not change because the global IPv6 address is now available on a loopback interface or a lower-numbered interface in the transit area. To force the global IPv6 address for the virtual link to be the global IPv6 address of a newly configured loopback, or a lower-numbered interface in the area, you must either disable the existing selected interface or remove the currently selected global IPv6 address from the interface.

---

## OSPFv3 route redistribution

Routes from various sources can be redistributed into OSPFv3. These routes can be redistributed in a number of ways.

You can configure the device to redistribute routes from the following sources into OSPFv3:

- IPv6 static routes
- Directly connected IPv6 networks
- BGP4+

You can redistribute routes in the following ways:

- By route types. For example, the Brocade device redistributes all IPv6 static routes.
- By using a route map to filter which routes to redistribute. For example, the device redistributes specified IPv6 static routes only.

---

**NOTE**

You must configure the route map before you configure a redistribution filter that uses the route map.

---

**NOTE**

When you use a route map for route redistribution, the software disregards the permit or deny action of the route map.

---

**NOTE**

For an external route that is redistributed into OSPFv3 through a route map, the metric value of the route remains the same unless the metric is set by the **set metric** command inside the route map or the **default-metric** command. For a route redistributed without using a route map, the metric is set by the metric parameter if set or the **default-metric** command if the metric parameter is not set.

---

**NOTE**

The CLI VRF-lite-capability present in OSPFv2 is not present in OSPFv3. Therefore, when a BGP route is redistributed from an MPLS domain into OSPFv3 and the DN (down) bit is set, the routes must be installed in the OSPFv3 routing table. Such routes could get propagated back into the MLPS cloud if there are OSPFv3 back-door links configured.

---

## Default route origination

An ASBR can be configured to automatically advertise a default external route into an OSPFv3 routing domain.

When the Brocade device is an OSPFv3 Autonomous System Boundary Router (ASBR), you can configure it to automatically generate a default external route into an OSPFv3 routing domain.

By default, the Brocade device does not advertise the default route into the OSPFv3 domain. If you want the device to advertise the OSPFv3 default route, you must explicitly enable default route origination.

When you enable OSPFv3 default route origination, the device advertises a type 5 default route that is flooded throughout the autonomous system, with the exception of stub areas.

The device advertises the default route into OSPFv3 even if OSPFv3 route redistribution is not enabled, and even if the default route is learned through an IBGP neighbor. The router does not, however, originate the default route if the active default route is learned from an OSPFv3 router in the same domain.

---

**NOTE**

The Brocade device does not advertise the OSPFv3 default route, regardless of other configuration parameters, unless you explicitly enable default route origination.

---

If default route origination is enabled and you disable it, the default route originated by the device is flushed. Default routes generated by other OSPFv3 routers are not affected. If you re-enable the default route origination, the change takes effect immediately and you do not need to reload the software.

## Filtering OSPFv3 routes

You can filter the routes to be placed in the OSPFv3 route table by configuring distribution lists. OSPFv3 distribution lists can be applied globally or to an interface.

The functionality of OSPFv3 distribution lists is similar to that of OSPFv2 distribution lists. However, unlike OSPFv2 distribution lists, which filter routes based on criteria specified in an Access Control List (ACL), OSPFv3 distribution lists can filter routes using information specified in an IPv6 prefix list or a route map.

## SPF timers

The device uses a SPF delay timer and a SPF hold time timer to calculate the shortest path for OSPFv3 routes. The values for both timers can be changed.

The Brocade device uses the following timers when calculating the shortest path for OSPFv3 routes:

- **SPF delay** - When the Brocade device receives a topology change, the device waits before it starts a Shortest Path First (SPF) calculation. By default, the device waits 5 seconds. You can configure the SPF delay to a value from 0 through 65535 seconds. If you set the SPF delay to 0 seconds, the device immediately begins the SPF calculation after receiving a topology change.
- **SPF hold time** - The device waits a specific amount of time between consecutive SPF calculations. By default, it waits 10 seconds. You can configure the SPF hold time to a value from 0 through 65535 seconds. If you set the SPF hold time to 0 seconds, the device does not wait between consecutive SPF calculations.

You can set the SPF delay and hold time to lower values to cause the device to change to alternate paths more quickly if a route fails. Note that lower values for these parameters require more CPU processing time.

You can change one or both of the timers.

---

### NOTE

If you want to change only one of the timers, for example, the SPF delay timer, you must specify the new value for this timer as well as the current value of the SPF hold timer, which you want to retain. The device does not accept only one timer value.

---



---

### NOTE

If you configure SPF timers between 0 through 100, they default to 0.

---

## OSPFv3 administrative distance

Devices can learn about networks from various protocols and select a route based on the source of the route information. This decision can be influenced if the default administrative distance for OSPFv3 routes is changed.

The Brocade device can learn about networks from various protocols. Consequently, the routes to a network may differ depending on the protocol from which the routes were learned.

The device selects one route over another based on the source of the route information. To do so, the device can use the administrative distances assigned to the sources. You can influence the device's decision by changing the default administrative distance for OSPFv3 routes.

You can configure a unique administrative distance for each type of OSPFv3 route. For example, you can configure the Brocade device to prefer a static route over an OSPFv3 inter-area route and to prefer OSPFv3 intra-area routes over static routes.

The distance you specify influences the choice of routes when the device has multiple routes to the same network from different protocols. The device prefers the route with the lower administrative distance.

You can specify unique default administrative distances for the following OSPFv3 route types:

- Intra-area routes
- Inter-area routes
- External routes

---

**NOTE**

The choice of routes within OSPFv3 is not influenced. For example, an OSPFv3 intra-area route is always preferred over an OSPFv3 inter-area route, even if the intra-area route's distance is greater than the inter-area route's distance.

---

## OSPFv3 LSA refreshes

In order that a refresh is not performed each time an individual LSA's refresh timer expires, OSPFv3 LSA refreshes are delayed for a specified time interval. This pacing interval can be altered.

The Brocade device paces OSPFv3 LSA refreshes by delaying the refreshes for a specified time interval instead of performing a refresh each time an individual LSA's refresh timer expires. The accumulated LSAs constitute a group, which the device refreshes and sends out together in one or more packets.

The pacing interval, which is the interval at which the Brocade device refreshes an accumulated group of LSAs, is configurable in a range from 10 through 1800 seconds (30 minutes). The default is 240 seconds (four minutes). Thus, every four minutes, the device refreshes the group of accumulated LSAs and sends the group together in the same packets.

The pacing interval is inversely proportional to the number of LSAs the Brocade device is refreshing and aging. For example, if you have approximately 10,000 LSAs, decreasing the pacing interval enhances performance. If you have a very small database (40 to 100 LSAs), increasing the pacing interval to 10 to 20 minutes may enhance performance only slightly.

## OSPFv3 over VRF

OSPFv3 can run over multiple Virtual Routing and Forwarding (VRF) instances. OSPFv3 maintains multiple instances of the routing protocol to exchange route information among various VRF instances. A multi-VRF-capable router maps an input interface to a unique VRF, based on user configuration. These input interfaces can be physical or a switched virtual interface (SVI). By default, all input interfaces are attached to the default VRF instance. All OSPFv3 commands are available over default and non-default VRF instances.

## OSPFv3 graceful restart helper

The OSPFv3 graceful restart (GR) helper provides a device with the capability to participate in a graceful restart in helper mode so that it assists a neighboring routing device that is performing a graceful restart.

The OSPFv3 graceful restart helper feature assists a neighboring routing device that is attempting a graceful restart. When OSPFv3 GR helper is enabled on a device, the device enters helper mode upon receipt of a grace-LSA where the neighbor state is FULL. By default, the helper capability is enabled when you start OSPFv3, even if graceful restart is not globally enabled.

## OSPFv3 non-stop routing (NSR)

OSPFv3 can continue operation without interruption during hitless failover when the NSR feature is enabled.

In graceful restart (GR), the restarting neighbors need to help build routing information during a failover. However, the GR helper may not be supported by all devices in a network. The non-stop routing (NSR) feature eliminates this dependency.

NSR does not require support from neighboring devices to perform hitless failover, and OSPF can continue operation without interruption.

---

### NOTE

NSR does not support IPv6-over-IPv4 tunnel and virtual link, so traffic loss is expected while performing hitless failover.

---

## IPsec for OSPFv3

IP Security (IPsec) secures OSPFv3 communications by authenticating and encrypting each IP packet of a communication session.

OSPFv3 relies on the IPsec protocol suite to secure IP communications by authenticating and encrypting IP packets. IPsec provides security features such as authentication of data origin, data integrity, replay protection, and message confidentiality. You can use IPsec to secure specific OSPFv3 areas and interfaces and protect OSPFv3 virtual links.

IPsec for OSPFv3 constitutes two basic protocols to authenticate routing information between peers:

- **Authentication header (AH):** AH provides data origin authentication and connectionless integrity, as well as providing the optional replay protection feature. AH authenticates as much of the IP header as possible, as well as the upper-level protocol data such as source IPv6 address, destination IPv6 address, flags, and IP payload. However, some IP header fields, such as TTL and checksum are often modified in transit and, therefore, cannot be protected by AH.
- **Encapsulation Security Payload (ESP):** Encapsulating Security Payload (ESP): ESP can provide message confidentiality, connectionless data integrity, and optional replay protection. ESP has both a header and a trailer. The authentication data of ESP cannot protect the outer IP header, just the payload that is being encrypted.

IPsec is available for OSPFv3 traffic only and only for packets that are “for-us”. A for-us packet is addressed to one of the IPv6 addresses on the device or to an IPv6 multicast address. Packets that are just forwarded by the line card do not receive IPsec scrutiny.

Brocade devices support the following components of IPsec for IPv6-addressed packets:

- Authentication through AH
- Authentication through ESP in transport mode
- Hashed Message Authentication Code-Secure Hash Algorithm 1 (HMAC-SHA-1) as the authentication algorithm
- Hashed Message Authentication Code-Message Digest 5 (HMAC-MD5) as the authentication algorithm
- Manual configuration of keys
- Configurable rollover timer

IPsec can be enabled on the following logical entities:

- Interface
- Area
- Virtual link

IPsec is based on security associations (SAs). With respect to traffic classes, this implementation of IPsec uses a single security association between the source and destination to support all traffic classes and so does not differentiate between the different classes of traffic that the DSCP bits define.

IPsec on a virtual link is a global configuration. Interface and area IPsec configurations are more granular.

Among the entities that can have IPsec protection, the interfaces and areas can overlap. The interface IPsec configuration takes precedence over the area IPsec configuration when an area and an interface within that area use IPsec. Therefore, if you configure IPsec for an interface and an area configuration also exists that includes this interface, the interface's IPsec configuration is used by that interface. However, if you disable IPsec on an interface, IPsec is disabled on the interface even if the interface has its own, specific authentication.

For IPsec, the system generates two types of databases. The Security Association Database (SAD) contains a security association for each interface or one global database for a virtual link. Even if IPsec is configured for an area, each interface that uses the area's IPsec still has its own security association in the SAD. Each SA in the SAD is a generated entry that is based on your specifications of an authentication protocol, destination address, and a security policy index (SPI). The SPI number is user-specified according to the network plan. Consideration for the SPI values to specify must apply to the whole network.

The system-generated security policy databases (SPDs) contain the security policies against which the system checks the for-us packets. For each for-us packet that has an ESP header, the applicable security policy in the security policy database (SPD) is checked to see if this packet complies with the policy. The IPsec task drops the non-compliant packets. Compliant packets continue on to the OSPFv3 task.

## IPsec for OSPFv3 configuration

IPsec authentication is disabled by default. IPsec authentication can be enabled on both default and as non-default vrfs.

The following IPsec parameters are configurable:

- AH security protocol
- ESP security protocol



- Authentication
- Hashed Message Authentication Code-Message Digest 5 (HMAC-MD5) authentication algorithm
- Hashed Message Authentication Code-Secure Hash Algorithm 1 (HMAC-SHA-1) authentication algorithm
- Security parameter index (SPI)
- A 40-character key using hexadecimal characters
- An option for not encrypting the keyword when it appears in **show** command output
- Key rollover timer
- Specifying the key add remove timer

## Configuring OSPFv3

A number of steps are required when configuring OSPFv3.

- Configure the router ID.
- Enable OSPFv3 globally.
- Assign OSPFv3 areas.
- Assign OSPFv3 areas to interfaces.

### Configuring the router ID

When configuring OSPFv3 the router ID for a device must be specified.

1. Enter the **configure terminal** command to access global configuration mode.

```
device# configure terminal
```

2. Enter the **rbridge-id** command with an RBridge ID to enter RBridge ID configuration mode.

```
device(config)# rbridge-id 122
```

3. Enter the **ip router-id** command to specify the router ID.

```
device(config-rbridge-id-122)# ip router-id 10.11.12.13
```

The following example configures the router ID for a device.

```
device# configure
device(config)# rbridge-id 122
device(config-rbridge-id-122)# ip router-id 10.11.12.13
device(config-rbridge-id-122)#
```

### Enabling OSPFv3

When OSPFv3 is enabled on a device, the device enters IPv6 OSPF configuration level. Several commands can then be accessed that allow the configuration of OSPFv3.

1. Enter the **configure terminal** command to access global configuration mode.

```
device# configure terminal
```

2. Enter the **rbridge-id** command with an RBridge ID to enter RBridge ID configuration mode.

```
device(config)# rbridge-id 122
```

3. Enter the **ip router-id** command to specify the router ID.

```
device(config-rbridge-id-122)# ip router-id 10.11.12.13
```

4. Enter the **ipv6 router ospf** command to enter IPv6 OSPF configuration mode and enable OSPFv3 on the router.

```
device(config-rbridge-id-122)# ipv6 router ospf
```

The following example enables OSPFv3 on a router.

```
device# configure
device(config)# rbridge-id 122
device(config-rbridge-id-122)# ip router-id 10.11.12.13
device(config-rbridge-id-122)# ipv6 router ospf
```

## Enabling OSPFv3 in a nondefault VRF

When OSPFv3 is enabled on a device, the device enters IPv6 OSPF configuration level. Several commands can then be accessed that allow the configuration of OSPFv3.

1. Enter the **configure terminal** command to access global configuration mode.

```
device# configure terminal
```

2. Enter the **rbridge-id** command with an RBridge ID to enter RBridge ID configuration mode.

```
device(config)# rbridge-id 122
```

3. Enter the **vrf** command and specify a name to enter Virtual Routing and Forwarding (VRF) configuration mode and create a nondefault VRF instance.

```
device(config-rbridge-id-122)# vrf vrf_1
```

4. Enter the **ip router-id** command to specify the router ID.

```
device(config-vrf-vrf_1)# ip router-id 10.11.12.14
```

5. Enter the **address-family ipv6 unicast** command to enter IPv6 address-family configuration mode.

```
device(config-vrf-vrf_1)# address-family ipv6 unicast
```

6. Enter the **exit** command until you return to RBridge ID configuration mode.

```
device(vrf-ipv6-unicast)# exit
```

7. Enter the **ipv6 router ospf** command and specify a VRF name to enter IPv6 OSPF configuration mode and enable OSPFv3 on a nondefault VRF.

```
device(config-rbridge-id-122)# ipv6 router ospf vrf vrf_1
```

The following example enables OSPFv3 in a nondefault VRF.

```
device# configure terminal
device(config)# rbridge-id 122
device(config-rbridge-id-122)# vrf vrf_1
device(config-vrf-vrf_1)# ip router-id 10.11.12.14
device(config-vrf-vrf_1)# address-family ipv6 unicast
device(vrf-ipv6-unicast)#
device(vrf-ipv6-unicast)# exit
device(config-vrf-vrf_1)#exit
device(config-rbridge-id-122)#ipv6 router ospf vrf vrf_1
device(config-ipv6-router-ospf-vrf-vrf_1)#
```

## Assigning OSPFv3 areas

Areas can be assigned as OSPFv3 areas.

Enable IPv6 on each interface over which you plan to enable OSPFv3. You enable IPv6 on an interface by configuring an IP address or explicitly enabling IPv6 on that interface.

1. Enter the **configure terminal** command to access global configuration mode.

```
device# configure terminal
```

2. Enter the **rbridge-id** command with an RBridge ID to enter RBridge ID configuration mode.

```
device(config)# rbridge-id 122
```

3. Enter the **ip router-id** command to specify the router ID.

```
device(config-rbridge-id-122)# ip router-id 10.11.12.13
```

4. Enter the **ipv6 router ospf** command to enter IPv6 OSPF configuration mode and enable OSPFv3 on the router.

```
device(config-rbridge-id-122)# ipv6 router ospf
```

5. Enter the **area** command to define an OSPFv3 area id.

```
device(config-ipv6-router-ospf-vrf-default-vrf)# area 0
```

6. Enter the **area** command to define a second OSPFv3 area id.

```
device(config-ipv6-router-ospf-vrf-default-vrf)# area 10.1.1.1
```

The following assigns an OSPFv3 ID to two areas. One of the areas is assigned by decimal number. The second area is assigned by IP address.

```
device# configure terminal
device(config)# rbridge-id 122
device(config-rbridge-id-122)# ip router-id 10.11.12.13
device(config-rbridge-id-122)# ipv6 router ospf
device(config-ipv6-router-ospf-vrf-default-vrf)# area 0
device(config-ipv6-router-ospf-vrf-default-vrf)# area 10.1.1.1
```

## Assigning OSPFv3 areas in a nondefault VRF

Areas can be assigned as OSPFv3 areas in a nondefault VRF.

Enable IPv6 on each interface over which you plan to enable OSPFv3. You enable IPv6 on an interface by configuring an IP address or explicitly enabling IPv6 on that interface.

1. Enter the **configure terminal** command to access global configuration mode.

```
device# configure terminal
```

2. Enter the **rbridge-id** command with an RBridge ID to enter RBridge ID configuration mode.

```
device(config)# rbridge-id 122
```

3. Enter the **vrf** command and specify a name to enter Virtual Routing and Forwarding (VRF) configuration mode and create a nondefault VRF instance.

```
device(config-rbridge-id-122)# vrf_1
```

4. Enter the **ip router-id** command to specify the router ID.

```
device(config-vrf-vrf_1)# ip router-id 10.11.12.14
```

5. Enter the **address-family ipv6 unicast** command to enter IPv6 address-family configuration mode.

```
device(config-vrf-vrf_1)# address-family ipv6 unicast
```

6. Enter the **exit** command until you return to RBridge ID configuration mode.

```
device(vrf-ipv6-unicast)# exit
```

7. Enter the **ipv6 router ospf** command and specify a VRF name to enter IPv6 OSPF configuration mode and enable OSPFv3 on a nondefault VRF.

```
device(config-rbridge-id-122)# ipv6 router ospf vrf vrf_1
```

8. Enter the **area** command to define an OSPFv3 area id.

```
device(config-ipv6-router-ospf-vrf-vrf_1)# area 0
```

9. Enter the **area** command to define a second OSPFv3 area ID.

```
device(config-ipv6-router-ospf-vrf-vrf_1)# area 10.1.1.1
```

The following example assigns an OSPFv3 ID to two areas in a nondefault VRF instance. One of the areas is assigned by decimal number. The second area is assigned by IP address.

```
device# configure terminal
device(config)# rbridge-id 122
device(config-rbridge-id-122)# vrf vrf_1
device(config-vrf-vrf_1)# ip router-id 10.11.12.13
device(config-vrf-vrf_1)# address-family ipv6 unicast
device(vrf-ipv6-unicast)#
device(vrf-ipv6-unicast)# exit
device(config-vrf-vrf_1)#exit
device(config-rbridge-id-122)#ipv6 router ospf vrf vrf_1
device(config-ipv6-router-ospf-vrf-vrf_1)# area 0
device(config-ipv6-router-ospf-vrf-vrf_1)# area 10.1.1.1
```

## Assigning OSPFv3 areas to interfaces

Defined OSPFv3 areas can be assigned to device interfaces.

Ensure that OSPFv3 areas are assigned.

---

### NOTE

All device interfaces must be assigned to one of the defined areas on an OSPFv3 router. When an interface is assigned to an area, all corresponding subnets on that interface are automatically included in the assignment.

---

1. Enter the **configure terminal** command to access global configuration mode. .

```
device# configure terminal
```

2. Enter the **interface** command and specify an interface.

```
device(config)# interface te 1/0/1
```

3. Enter the **ipv6 address** command to specify the router ID.

```
device(config-if-te-1/0/1)# ipv6 address 2001:1:0:1::1/64
```

4. Enter the **ipv6 ospf area** command.

```
device(config-if-te-1/0/1)# ipv6 ospf area 0
```

Area 0 is assigned to the 10-gigabit Ethernet interface whose IPv6 address is 2001:2:0:1::2/64

5. Enter the **exit** command.

```
device(config-if-te-1/0/1)# exit
```

6. Enter the **interface** command and specify an interface.

```
device(config)# interface te 1/0/2
```

7. Enter the **ipv6 address** command to specify the router ID.

```
device(config-if-te-1/0/2)# ipv6 address 2001:1:0:2::1/64
```

8. Enter the **ipv6 ospf area** command.

```
device(config-if-te-1/0/2)# ipv6 ospf area 1
```

Area 1 is assigned to the 10-gigabit Ethernet interface whose IPv6 address is 2001:1:0:2::1/64

The following example configures and enables OSPFv3 on two specified interfaces, and assigns a 10-gigabit Ethernet interface 1/0/1 to two router areas.

```
device# configure terminal
device(config)# interface te 1/0/1
device(config-if-te-1/0/1)# ipv6 address 2001:1:0:1::1/64
device(config-if-te-1/0/1)# ipv6 ospf area 0
device(config-if-te-1/0/1)# exit
device(config)# interface Te 1/0/2
device(config-if-te-1/0/2)# ipv6 address 2001:1:0:2::1/64
device(config-if-te-1/0/2)# ipv6 ospf area 1
```

## Configuring an NSSA

OSPFv3 areas can be defined as NSSA areas with modifiable parameters.

1. Enter the **configure terminal** command to access global configuration mode.

```
device# configure terminal
```

2. Enter the **rbridge-id** command with an RBridge ID to enter RBridge ID configuration mode.

```
device(config)# rbridge-id 122
```

3. Enter the **ip router-id** command to specify the router ID.

```
device(config-rbridge-id-122)# ip router-id 10.3.3.3
```

4. Enter the **ipv6 router ospf** command to enter IPv6 OSPF configuration mode and enable OSPFv3 on the router.

```
device(config-rbridge-id-122)# ipv6 router ospf
```

5. Enter the **area nssa** command.

```
device(config-ipv6-router-ospf-vrf-default-vrf)# area 3 nssa default-information-originate metric 33
```

Area 3 is defined as an NSSA with the default route option and an additional cost of 33.

The following example sets an additional cost of 33 on an NSSA defined as 3.

```
device# configure terminal
device(config)# rbridge-id 122
device(config-rbridge-id-122)#ip router-id 10.3.3.3
device(config-rbridge-id-122)#ipv6 router ospf
device(config-ipv6-router-ospf-vrf-default-vrf)# area 3 nssa default-information-originate metric 33
```

## Assigning a stub area

OSPFv3 areas can be defined as stub areas with modifiable parameters.

1. Enter the **configure terminal** command to access global configuration mode.

```
device# configure terminal
```

2. Enter the **rbridge-id** command with an RBridge ID to enter RBridge ID configuration mode.

```
device(config)# rbridge-id 122
```

3. Enter the **ip router-id** command to specify the router ID.

```
device(config-rbridge-id-122)# ip router-id 10.4.4.4
```

4. Enter the **ipv6 router ospf** command to enter IPv6 OSPF configuration mode and enable OSPFv3 on the router.

```
device(config-rbridge-id-122)# ipv6 router ospf
```

5. Enter the **area stub** command.

```
device(config-ipv6-router-ospf-vrf-default-vrf)# area 4 stub 100
Area 4 is defined as a stub area with an additional cost of 100.
```

The following example sets an additional cost of 100 on a stub area defined as 4.

```
device# configure terminal
device(config)# rbridge-id 122
device(config-rbridge-id-122)# ip router-id 10.4.4.4
device(config-rbridge-id-122)# ipv6 router ospf
device(config-ipv6-router-ospf-vrf-default-vrf)# area 4 stub 100
```

## Configuring virtual links

If an ABR does not have a physical link to a backbone area, a virtual link can be configured between that ABR and another device within the same area that has a physical link to a backbone area.

A virtual link is configured, and a virtual link endpoint on two devices, ABR1 and ABR2, is defined.

1. On ABR1, enter the **configure terminal** command to access global configuration mode.

```
device# configure terminal
```

2. Enter the **rbridge-id** command with an RBridge ID to enter RBridge ID configuration mode.

```
device(config)# rbridge-id 122
```

3. Enter the **ip router-id** command to specify the router ID.

```
device(config-rbridge-id-122)# ip router-id 10.1.1.1
```

4. Enter the **ipv6 router ospf** command to enter IPv6 OSPF configuration mode and enable OSPFv3 on the router.

```
device(config-rbridge-id-122)# ipv6 router ospf
```

5. Enter the **area** command to assign an OSPFv3 area ID.

```
device(config-ipv6-router-ospf-vrf-default-vrf)# area 0
```

6. Enter the **area** command to assign an OSPFv3 area ID.

```
device(config-ipv6-router-ospf-vrf-default-vrf)# area 1
```

7. Enter the **area virtual-link** command and the ID of the OSPFv3 router at the remote end of the virtual link to configure the virtual link endpoint.

```
device(config-ipv6-router-ospf-vrf-default-vrf)# area 1 virtual-link 10.2.2.2
```

- On ABR2, enter the **configure terminal** command to access global configuration mode.

```
device# configure terminal
```

- Enter the **rbridge-id** command with an RBridge ID to enter RBridge ID configuration mode.

```
device(config)# rbridge-id 104
```

- Enter the **ip router-id** command to specify the router ID.

```
device(config-rbridge-id-104)# ip router-id 10.2.2.2
```

- Enter the **ipv6 router ospf** command to enter IPv6 OSPF configuration mode and enable OSPFv3 on the router.

```
device(config-rbridge-id-104)# ipv6 router ospf
```

- Enter the **area** command to assign an OSPFv3 area ID.

```
device(config-ipv6-router-ospf-vrf-default-vrf)# area 1
```

- Enter the **area** command to assign an OSPFv3 area ID.

```
device(config-ipv6-router-ospf-vrf-default-vrf)# area 2
```

- Enter the **area virtual-link** command and the ID of the OSPFv3 router at the remote end of the virtual link to configure the virtual link endpoint.

```
device(config-ipv6-router-ospf-vrf-default-vrf)# area 1 virtual-link 10.1.1.1
```

The following example configures a virtual link between two devices.

```
ABR1:
device1# configure terminal
device1(config)# rbridge-id 122
device1(config-rbridge-id-122)# ip router-id 10.1.1.1
device1(config-rbridge-id-122)# ipv6 router ospf
device1(config-router-ospf-vrf-default-vrf)# area 0
device1(config-router-ospf-vrf-default-vrf)# area 1
device1(config-ipv6-router-ospf-vrf-default-vrf)# area 1 virtual-link 10.2.2.2
```

```
ABR2:
device2# configure terminal
device2(config)# rbridge-id 104
device2(config-rbridge-id-104)# ip router-id 10.2.2.2
device2(config-rbridge-id-104)# ipv6 router ospf
device2(config-router-ospf-vrf-default-vrf)# area 1
device2(config-router-ospf-vrf-default-vrf)# area 2
device2(config-ipv6-router-ospf-vrf-default-vrf)# area 1 virtual-link 10.1.1.1
```

## Redistributing routes into OSPFv3

OSPFv3 routes can be redistributed, and the routes to be redistributed can be specified.

The redistribution of static routes into OSPFv3 is configured on device1. The redistribution of connected routes into OSPFv3 is configured on device2, and the connected routes to be redistributed specified.

- On device1, enter the **configure terminal** command to access global configuration mode.

```
device# configure terminal
```

- Enter the **rbridge-id** command with an RBridge ID to enter RBridge ID configuration mode.

```
device(config)# rbridge-id 122
```

- Enter the **ipv6 router ospf** command to enter IPv6 OSPF configuration mode and enable OSPFv3 on the router.

```
device(config-rbridge-id-122)# ipv6 router ospf
```

- Enter the **redistribute** command with the **static** parameter to redistribute static routes.

```
device(config-ipv6-router-ospf-vrf-default-vrf)# redistribute static
```

5. On device2, enter the **configure terminal** command to access global configuration mode.

```
device# configure terminal
```

6. Enter the **rbridge-id** command with an RBridge ID to enter RBridge ID configuration mode.

```
device(config)# rbridge-id 122
```

7. Enter the **ipv6 router ospf** command to enter IPv6 OSPF configuration mode and enable OSPFv3 on the router.

```
device(config-rbridge-id-122)# ipv6 router ospf
```

8. Enter the **redistribute** command with the **connected** and **route-map** parameters to redistribute connected routes and specify a route map.

```
device(config-ipv6-router-ospf-vrf-default-vrf)# redistribute connected route-map rmap1
```

The following example redistributes static routes into OSPFv3 on a device.

```
device# configure terminal
device(config)# rbridge-id 122
device(config-rbridge-id-122)# ipv6 router ospf
device(config-ipv6-router-ospf-vrf-default-vrf)# redistribute static
```

The following example redistributes connected routes into OSPFv3 on a device and specifies a route map.

```
device# configure terminal
device(config)# rbridge-id 122
device(config-rbridge-id-122)# ipv6 router ospf
device(config-ipv6-router-ospf-vrf-default-vrf)# redistribute connected route-map rmap1
```

## Modifying Shortest Path First timers

The Shortest Path First (SPF) delay and hold time can be modified.

1. Enter the **configure terminal** command to access global configuration mode.

```
device# configure terminal
```

2. Enter the **rbridge-id** command with an RBridge ID to enter RBridge ID configuration mode..

```
device(config)# rbridge-id 122
```

3. Enter the **ipv6 router ospf** command to enter IPv6 OSPF configuration mode and enable OSPFv3 globally.

```
device(config-rbridge-id-122)# ipv6 router ospf
```

4. Enter the **timers** command with the **spf** parameter.

```
device(config-ipv6-router-ospf-vrf-default-vrf)# timers spf 10 20
```

The SPF delay is changed to 10 seconds and the SPF hold time is changed to 20 seconds.

The following example changes the SPF delay and hold time.

```
device# configure terminal
device(config)# rbridge-id 122
device(config-rbridge-id-122)# ipv6 router ospf
device(config-ipv6-router-ospf-vrf-default-vrf)# timers spf 10 20
```



## Configuring the OSPFv3 LSA pacing interval

The interval between OSPFv3 LSA refreshes can be modified.

1. Enter the **configure terminal** command to access global configuration mode.

```
device# configure terminal
```

2. Enter the **rbridge-id** command with an RBridge ID to enter RBridge ID configuration mode.

```
device(config)# rbridge-id 122
```

3. Enter the **ipv6 router ospf** command to enter IPv6 OSPF configuration mode and enable OSPFv3 globally.

```
device(config-rbridge-id-122)# ipv6 router ospf
```

4. Enter the **timers** command with the **lsa-group-pacing** parameter.

```
device(config-ipv6-router-ospf-vrf-default-vrf)# timers lsa-group-pacing 120
The OSPFv3 LSA pacing interval is changed to two minutes (120 seconds).
```

5. Enter the **no timers** command with the **lsa-group-pacing** parameter.

```
device(config-ipv6-router-ospf-vrf-default-vrf)# no timers lsa-group-pacing
The pacing interval is restored to its default value of 4 minutes (240 seconds).
```

The following example changes the interval between OSPFv3 LSA refreshes and then restores the pacing interval to its default value.

```
device# configure terminal
device(config)# rbridge-id 122
device(config-rbridge-id-122)# ipv6 router ospf
device(config-ipv6-router-ospf-vrf-default-vrf)# timers lsa-group-pacing 120
device(config-ipv6-router-ospf-vrf-default-vrf)# no timers lsa-group-pacing
```

## Configuring default route origin

OSPFv3 default routes can be created and advertised.

1. Enter the **configure terminal** command to access global configuration mode.

```
device# configure terminal
```

2. Enter the **rbridge-id** command with an RBridge ID to enter RBridge ID configuration mode.

```
device(config)# rbridge-id 122
```

3. Enter the **ipv6 router ospf** command to enter IPv6 OSPF configuration mode and enable OSPFv3 globally.

```
device(config-rbridge-id-122)# ipv6 router ospf
```

4. Enter the **default-information-originate** command with the **always**, **metric**, and **metric-type** parameters.

```
device(config-ipv6-router-ospf-vrf-default-vrf)# default-information-originate
always metric 2 metric-type type1
```

A default type 1 external route with a metric of 2 is created and advertised.

The following example creates and advertises a default route with a metric of 2 and a type 1 external route.

```
device# configure terminal
device(config)# rbridge-id 122
device(config-rbridge-id-122)# ipv6 router ospf
device(config-ipv6-router-ospf-vrf-default-vrf)# default-information-originate
always metric 2 metric-type type1
```

## Disabling and re-enabling OSPFv3 event logging

OSPFv3 event logging, such as neighbor state changes and database overflow conditions, can be disabled and re-enabled.

1. Enter the **configure terminal** command to access global configuration mode.

```
device# configure terminal
```

2. Enter the **rbridge-id** command with an RBridge ID to enter RBridge ID configuration mode.

```
device(config)# rbridge-id 122
```

3. Enter the **ipv6 router ospf** command to enter IPv6 OSPF configuration mode and enable OSPFv3 globally.

```
device(config-rbridge-id-122)# ipv6 router ospf
```

4. Enter the **no log-status-change** command to disable the logging of OSPFv3 events.

```
device(config-ipv6-router-ospf-vrf-default-vrf)# no log-status-change
```

The following example re-enables the logging of OSPFv3 events.

```
device# configure terminal
device(config)# rbridge-id 122
device(config-rbridge-id-122)# ipv6 router ospf
device(config-ipv6-router-ospf-vrf-default-vrf)# log-status-change
```

## Configuring administrative distance based on route type

The default administrative distances for intra-area routes, inter-area routes, and external routes can be altered.

1. Enter the **configure terminal** command to access global configuration mode.

```
device# configure terminal
```

2. Enter the **rbridge-id** command with an RBridge ID to enter RBridge ID configuration mode.

```
device(config)# rbridge-id 122
```

3. Enter the **ipv6 router ospf** command to enter IPv6 OSPF configuration mode and enable OSPFv3 globally.

```
device(config-rbridge-id-122)# ipv6 router ospf
```

4. Enter the **distance** command with the **intra-area** parameter.

```
device(config-ipv6-router-ospf-vrf-default-vrf)# distance intra-area 80
The administrative distance for intra-area routes is changed from the default to 80.
```

5. Enter the **distance** command with the **inter-area** parameter.

```
device(config-ipv6-router-ospf-vrf-default-vrf)# distance inter-area 90
```

The administrative distance for inter-area routes is changed from the default to 90.

6. Enter the **distance** command with the **external** parameter.

```
device(config-ipv6-router-ospf-vrf-default-vrf)# distance external 100
```

The administrative distance for external routes is changed from the default to 100.

The following example changes the default administrative distances for intra-area routes, inter-area routes, and external routes.

```
device# configure terminal
device(config)# rbridge-id 122
device(config-rbridge-id-122)# ipv6 router ospf
device(config-ipv6-router-ospf-vrf-default-vrf)# distance intra-area 80
device(config-ipv6-router-ospf-vrf-default-vrf)# distance inter-area 90
device(config-ipv6-router-ospf-vrf-default-vrf)# distance external 100
```

## Changing the reference bandwidth for the cost on OSPFv3

The reference bandwidth for OSPFv3 can be altered, resulting in various costs.

1. Enter the **configure terminal** command to access global configuration mode.

```
device# configure terminal
```

2. Enter the **rbridge-id** command with an RBridge ID to enter RBridge ID configuration mode.

```
device(config)# rbridge-id 122
```

3. Enter the **ipv6 router ospf** command to enter IPv6 OSPF configuration mode and enable OSPFv3 globally.

```
device(config-rbridge-id-122)# ipv6 router ospf
```

4. Enter the **auto-cost reference-bandwidth** command to change the reference bandwidth.

```
device(config-ipv6-router-ospf-vrf-default-vrf)# auto-cost reference-bandwidth 500
```

The following example changes the auto-cost reference-bandwidth to 500.

```
device# configure terminal
device(config)# rbridge-id 122
device(config-rbridge-id-122)# ipv6 router ospf
device(config-ipv6-router-ospf-vrf-default-vrf)# auto-cost reference-bandwidth 500
```

The reference bandwidth specified in this example results in the following costs:

- 10-Mbps port cost =  $500/10 = 50$
- 100-Mbps port cost =  $500/100 = 5$
- 1000-Mbps port cost =  $500/1000 = 0.5$ , which is rounded up to 1
- 155-Mbps port cost =  $500/155 = 3.23$ , which is rounded up to 4
- 622-Mbps port cost =  $500/622 = 0.80$ , which is rounded up to 1
- 2488-Mbps port cost =  $500/2488 = 0.20$ , which is rounded up to 1

The costs for 10-Mbps, 100-Mbps, and 155-Mbps ports change as a result of the changed reference bandwidth. Costs for higher-speed interfaces remain the same.

## Setting all OSPFv3 interfaces to the passive state

All OSPFv3 interfaces for a specified RBridge can be set as passive. This causes them to drop all OSPFv3 control packets.

1. Enter the **configure terminal** command to access global configuration mode.

```
device# configure terminal
```

2. Enter the **rbridge-id** command with an RBridge ID to enter RBridge ID configuration mode.

```
device(config)# rbridge-id 122
```

3. Enter the **ipv6 router ospf** command to enter IPv6 OSPF configuration mode and enable OSPFv3 globally.

```
device(config-rbridge-id-122)# ipv6 router ospf
```

4. Enter the **default-passive-interface** command to mark all interfaces passive by default.

```
device(config-ipv6-router-ospf-vrf-default-vrf)# default-passive-interface
```

The following example sets all OSPFv3 interfaces for a specified RBridge as passive, causing them to drop all the OSPFv3 control packets.

```
device# configure terminal
device(config)# rbridge-id 122
device(config-rbridge-id-122)# ipv6 router ospf
device(config-ipv6-router-ospf-vrf-default-vrf)# default-passive-interface
```

## Disabling OSPFv3 graceful restart helper

The OSPFv3 graceful restart (GR) helper feature is enabled by default, and can be disabled on a routing device.

1. Enter the **configure terminal** command to access global configuration mode.

```
device# configure terminal
```

2. Enter the **rbridge-id** command with an RBridge ID to enter RBridge ID configuration mode.

```
device(config)# rbridge-id 122
```

3. Enter the **ipv6 router ospf** command to enter OSPFv3 VRF router configuration mode and enable OSPFv3 globally.

```
device(config-rbridge-id-122)# ipv6 router ospf
```

4. Enter the **no graceful-restart helper** command to disable the GR helper feature.

```
device(config-ipv6-router-ospf-vrf-default-vrf)# no graceful-restart helper
```

The following example disables the GR helper feature.

```
device# configure terminal
device(config)# rbridge-id 122
device(config-rbridge-id-122)# ipv6 router ospf
device(config-ipv6-router-ospf-vrf-default-vrf)# no graceful-restart helper
```

## Re-enabling OSPFv3 graceful restart helper

If the OSPFv3 graceful restart (GR) helper feature has been disabled on a routing device, it can be re-enabled. GR helper mode can also be enabled with strict link-state advertisement (LSA) checking.

1. Enter the **configure terminal** command to access global configuration mode.

```
device# configure terminal
```

2. Enter the **rbridge-id** command with an RBridge ID to enter RBridge ID configuration mode.

```
device(config)# rbridge-id 122
```

3. Enter the **ipv6 router ospf** command to enter OSPFv3 VRF router configuration mode and enable OSPFv3 globally.

```
device(config-rbridge-id-122)# ipv6 router ospf
```

4. Enter the **graceful-restart helper** command and specify the **strict-lsa-checking** parameter to re-enable the GR helper feature with strict LSA checking.

```
device(config-ipv6-router-ospf-vrf-default-vrf)# graceful-restart helper strict-lsa-checking
```

The following example re-enables the GR helper feature with strict LSA checking.

```
device# configure terminal
device(config)# rbridge-id 122
device(config-rbridge-id-122)# ipv6 router ospf
device(config-ipv6-router-ospf-vrf-default-vrf)# graceful-restart helper strict-lsa-checking
```

## Configuring IPsec on an OSPFv3 area

IP Security (IPsec) secures OSPFv3 communications by authenticating and encrypting each IP packet of a communication session. IPsec can be configured on an OSPF area.

---

### NOTE

When IPsec is configured for an area, the security policy is applied to all the interfaces in the area.

---

1. Enter **configure terminal**.

```
device# configure terminal
```

2. Enter the **rbridge-id** command with an RBridge ID to enter RBridge ID configuration mode.

```
device(config)# rbridge-id 122
```

3. Enter the **ip router-id** command to specify the router ID.

```
device(config-rbridge-id-122)# ip router-id 10.11.12.13
```

4. Enter the **ipv6 router ospf** command to enter IPv6 OSPF configuration mode and enable OSPFv3 on the router.

```
device(config-rbridge-id-122)# ipv6 router ospf
```

5. Enter **area authentication spi spi ah hmac-md5 key**.

```
device(config-ipv6-router-ospf-vrf-default-vrf)# area 0 authentication spi 600 ah
hmac-md5 key abcef12345678901234fedcba098765432109876
```

Configures IPsec in OSPF area 0. The security parameter index (SPI) value is 600, and the authentication header (AH) protocol is selected. Message Digest 5 (MD5) authentication on the area is enabled.

The following example enables AH and MD5 authentication for the OSPF area, setting a SPI value of 600.

```
device# configure terminal
device(config)# rbridge-id 122
device(config-rbridge-id-122)# ip router-id 10.11.12.13
device(config-rbridge-id-122)# ipv6 router ospf
device(config-ipv6-router-ospf-vrf-default-vrf)# area 0 authentication spi 600 ah
hmac-md5 key abcef12345678901234fedcba098765432109876
```

## Configuring IPsec on an OSPFv3 interface

IP Security (IPsec) secures OSPFv3 communications by authenticating and encrypting each IP packet of a communication session. Specific OSPFv3 interfaces can be secured using IPsec.

Ensure that OSPFv3 areas are assigned. For IPsec to work, the IPsec configuration must be the same on all the routers to which an interface connects.

---

### NOTE

All device interfaces must be assigned to one of the defined areas on an OSPFv3 router. When an interface is assigned to an area, all corresponding subnets on that interface are automatically included in the assignment.

---

1. Enter the **configure terminal** command to access global configuration mode.

```
device# configure terminal
```

2. Enter the **interface** command and specify an interface.

```
device(config)# interface te 1/0/1
```

3. Enter the **ipv6 ospf area** command to assign a specified area to the interface.

```
device(config-if-te-1/0/1)# ipv6 ospf area 0
```

4. Enter **ipv6 ospf authentication spi spi esp null hmac-sha1 key**.

```
device(config-if-te-1/0/1)# ipv6 ospf authentication spi 512 esp null hmac-sha1
key abcef12345678901234fedcba098765432109876
```

Configures IPsec on the specified interface. The SPI value is 512, and the Encapsulating Security Payload (ESP) protocol is selected. Secure Hash Algorithm 1 (SHA-1) authentication is enabled.

The following example enables ESP and SHA-1 on a specified OSPFv3 10-gigabit interface.

```
device# configure terminal
device(config)# interface te 1/0/1
device(config-if-te-1/0/1)# ipv6 ospf area 0
device(config-if-te-1/0/1)# ipv6 ospf authentication spi 512 esp null hmac-sha1 key
abcef12345678901234fedcba098765432109876
```

## Configuring IPsec on OSPFv3 virtual links

IP Security (IPsec) can be configured for virtual links.

The virtual link IPsec security associations (SAs) and policies are added to all interfaces of the transit area for the outbound direction. For the inbound direction, IPsec SAs and policies for virtual links are added to the global database.

1. Enter the **configure terminal** command to access global configuration mode.

```
device# configure terminal
```

2. Enter the **rbridge-id** command with an RBridge ID to enter RBridge ID configuration mode.

```
device(config)# rbridge-id 122
```

3. Enter the **ip router-id** command to specify the router ID.

```
device(config-rbridge-id-122)# ip router-id 10.1.1.1
```

4. Enter the **ipv6 router ospf** command to enter IPv6 OSPF configuration mode and enable OSPFv3 on the router.

```
device(config-rbridge-id-122)# ipv6 router ospf
```

5. Enter **area virtual-link authentication spi spi ah hmac-sha1 no-encrypt key**.

```
device(config-ipv6-router-ospf-vrf-default-vrf)# area 1 virtual-link 10.1.1.1
authentication spi 512 ah hmac-sha1 no-encrypt key
1134567890223456789012345678901234567890
```

Configures IPsec on the specified virtual link in OSPF area 0. The router ID associated with the virtual link neighbor is 10.1.1.1, the SPI value is 512, and the authentication header (AH) protocol is selected. Secure Hash Algorithm 1 (SHA-1) authentication is enabled. The 40-character key is not encrypted in **show** command displays.

The following example configures IPsec on an OSPF area.

```
device# configure terminal
device(config)# rbridge-id 122
device(config-rbridge-id-122)# ip router-id 10.1.1.1
device(config-rbridge-id-122)# ipv6 router ospf
device(config-ipv6-router-ospf-vrf-default-vrf)# area 1 virtual-link 10.1.1.1
authentication spi 512 ah hmac-sha1 no-encrypt key
1134567890223456789012345678901234567890
```

## Specifying the key rollover and key add-remove timers

The key rollover timer can be configured so that rekeying takes place on all the nodes at the same time and the security parameters are consistent across all the nodes. The timing of the authentication key add-remove interval can also be altered.

1. Enter the **configure terminal** command to access global configuration mode.

```
device# configure terminal
```

2. Enter the **rbridge-id** command with an RBridge ID to enter RBridge ID configuration mode.

```
device(config)# rbridge-id 122
```

3. Enter the **ip router-id** command to specify the router ID.

```
device(config-rbridge-id-122)# ip router-id 10.11.12.13
```

4. Enter the **ipv6 router ospf** command to enter IPv6 OSPF configuration mode and enable OSPFv3 on the router.

```
device(config-rbridge-id-122)# ipv6 router ospf
```

5. Enter the **key-add-remove-interval** command and specify the desired interval to set the timing of the authentication key add-remove interval.

```
device(config-ipv6-router-ospf-vrf-default-vrf)# key-add-remove-interval 240
```

6. Enter the **key-rollover interval** command and specify the desired interval to set the timing of the configuration changeover.

```
device(config-ipv6-router-ospf-vrf-default-vrf)# key-rollover interval 240
```

The following example specifies the timing of the configuration changeover.

```
device# configure terminal
device(config)# rbridge-id 122
device(config-rbridge-id-122)# ip router-id 10.11.12.13
device(config-rbridge-id-122)# ipv6 router ospf
device(config-ipv6-router-ospf-vrf-default-vrf)# key-add-remove-interval 240
device(config-ipv6-router-ospf-vrf-default-vrf)# key-rollover interval 240
```

## Displaying OSPFv3 results

Various **show** OSPFv3 commands verify information about OSPFv3 configurations.

1. Enter the **exit** command to enter privileged EXEC mode. Repeat as necessary.

```
device(config)# exit
```

2. Enter the **show ipv6 ospf** command.

```
device# show ipv6 ospf

OSPFv3 Process number 0 with Router ID 0x01010101(1.1.1.1)
Running 0 days 0 hours 24 minutes 36 seconds
Number of AS scoped LSAs is 0
Sum of AS scoped LSAs Checksum is 00000000
External LSA Limit is 250000
Database Overflow Interval is 10
Database Overflow State is NOT OVERFLOWED
Route calculation executed 34 times
Pending outgoing LSA count 0
Authentication key rollover interval 300 seconds
Number of areas in this router is 2
Router is operating as ABR
High Priority Message Queue Full count: 0
Graceful restart helper is enabled, strict lsa checking is disabled
Nonstop Routing is disabled
```

This example output gives general OSPFv3 information and indicates that the device is not operating as an ASBR. If the device is not operating as an ASBR, there is no information about redistribution in the output.

3. Enter the **show ipv6 ospf summary** command.

```
device# show ipv6 ospf summary

Total number of IPv6 OSPF instances: 1
Seq Instance      Intfs  Nbrs  Nbrs-Full LSAs  Routes
1  default-vrf     3      2      2      25      6
```

This example shows summary output for the one IPv6 OSPF session that is configured.

4. Enter the **show ipv6 ospf area** command.

```
device# show ipv6 ospf area 0
```



```
Area 0:
Authentication: Not Configured
Active interface(s) attached to this area: Te 1/0/1 VLink 1
Inactive interface(s) attached to this area: None
Number of Area scoped LSAs is 12
Sum of Area LSAs Checksum is 0006e83c
Statistics of Area 0:
  SPF algorithm executed 17 times
  SPF last updated: 333 sec ago
  Current SPF node count: 2
    Router: 2 Network: 0
    Maximum of Hop count to nodes: 1
```

This example shows detailed output for an assigned OSPFv3 area, area 0.

5. Enter the **show ipv6 ospf interface** command with the **brief** keyword.

```
device# show ipv6 ospf interface brief
Interface      Area      Status Type Cost   State   Nbrs(F/C)
Te 1/0/1       0         up     BCST 1   DR      0/0
Te 1/0/2       1         up     BCST 1   BDR     1/1
```

This example shows limited OSPFv3 interface information.

6. Enter the **show ipv6 ospf neighbor** command.

```
device# show ipv6 ospf neighbor
Total number of neighbors in all states: 1
Number of neighbors in state Full      : 1
RouterID      Pri State  DR          BDR          Interface    [State]
2.2.2.2       1 Full   2.2.2.2     1.1.1.1     Te 1/0/2    [BDR]
```

This example shows detailed output for an assigned OSPFv3 area, area 0.

7. Enter the **show ipv6 ospf virtual-neighbor** command.

```
device# show ipv6 ospf virtual-neighbor

Index Router ID      Address                      State      Interface
1      2.2.2.2           2001:2:0:2::2              Full       Te 1/0/2
Option: 00-00-00      QCount: 0      Timer: 46
```

This example shows information about an OSPFv3 virtual neighbor.

8. Enter the **show ipv6 ospf virtual-links** command.

```
device# show ipv6 ospf virtual-links
Transit Area ID Router ID      Interface Address      State
1         1.1.1.1       2001:2:0:2::2 P2P
Timer intervals(sec) :
Hello 10, Hello Jitter 10, Dead 40, Retransmit 5, TransmitDelay 1
DelayedLSAck: 4 times
Authentication: Not Configured
Statistics:
Type      tx      rx      tx-byte  rx-byte
Unknown  0        0        0         0
Hello    79       77       3156      3076
DbDesc   4        5        352       500
LSReq    2        2        200       152
LSUpdate 9        10       1056      1188
LSAck    5        5        460       440
OSPF messages dropped,no authentication: 0
Neighbor: State: Full Address: 2001:1:0:2::1 Interface: Te 2/0/2
```

This example shows information about OSPFv3 virtual links.

9. Enter the **show ipv6 ospf database** command with the **type-7** keyword.

```
device# show ipv6 ospf database type-7

Area ID      Type LSID      Adv Rtr      Seq(Hex) Age Cksum Len  Sync
4            Typ7 1         5.5.5.5     80000001 280 58ee 60  Yes
  Bits: EF-
  Metric: 0
  Prefix Options: P,
  Referenced LSType: 0
  Prefix: 100::100/128
  Forwarding-Address: 2001:5:0:3::5
Area ID      Type LSID      Adv Rtr      Seq(Hex) Age Cksum Len  Sync
```

```

4          Typ7 2          3.3.3.3          80000002 8          02c9 44          Yes
  Bits: EF-
  Metric: 33
  Prefix Options:
  Referenced LSType: 0
  Prefix: ::/0
  Forwarding-Address: 2001:3:0:2::3

```

This example shows detailed output for a configured NSSA.

10 Enter the **show ipv6 ospf routes** command.

```

device# show ipv6 ospf routes

Destination          Cost          E2Cost        Tag          Flags        Dis
E2 ::/0              1             33            0            00000027    110
Next_Hop_Router     Outgoing_Interface Adv_Router
2001:3:0:2::3       Te 4/0/2     3.3.3.3
Destination          Cost          E2Cost        Tag          Flags        Dis
E2 100::100/128     1             0             0            0000000b    110
Next_Hop_Router     Outgoing_Interface Adv_Router
2001:5:0:3::5       Te 4/0/3     5.5.5.5

```

This example shows output for OSPFv3 routes.

11 Enter the **show ipv6 ospf database as-external** command.

```

device# show ipv6 ospf database as-external

Area ID          Type LSID          Adv Rtr          Seq(Hex) Age Cksum Len Sync
N/A              Extn 106          6.6.6.6          80000001 533 7993 36 Yes
  Bits: E--
  Metric: 0
  Prefix Options:
  Referenced LSType: 0
  Prefix: 4001::/64

Area ID          Type LSID          Adv Rtr          Seq(Hex) Age Cksum Len Sync
N/A              Extn 105          6.6.6.6          80000001 533 d230 44 Yes
  Bits: E--
  Metric: 0
  Prefix Options:
  Referenced LSType: 0
  Prefix: 2::2/128

```

This example shows information about external LSAs.

12 Enter the **show ipv6 ospf database** command.

```

device# show ipv6 ospf database
LSA Key - Rtr:Router Net:Network Inap:InterPrefix Inar:InterRouter
          Extn:ASExternal Grp:GroupMembership Typ7:Type7 Link:Link
          Iap:IntraPrefix Grc:Grace

Area ID          Type LSID          Adv Rtr          Seq(Hex) Age Cksum Len Sync
0                Link 145          6.6.6.6          80000002 1036 0432 56 Yes
0                Link 7            1.1.1.1          80000002 595 b6b2 56 Yes
0                Rtr 0            6.6.6.6          80000004 560 d1f4 40 Yes
0                Rtr 0            1.1.1.1          80000004 1756 ce98 40 Yes
0                Net 145          6.6.6.6          80000002 560 c899 32 Yes
0                Iap 4350         6.6.6.6          80000002 560 903a 44 Yes
1                Rtr 0            1.1.1.1          80000003 1756 0c20 24 Yes
N/A              Extn 106          6.6.6.6          80000002 560 7794 36 Yes
N/A              Extn 108          6.6.6.6          80000001 1678 9888 36 Yes

```

This example shows information about different OSPFv3 LSAs.

13 Enter the **show ipv6 ospf spf** command with the **tree** keyword.

```

device# show ipv6 ospf spf tree
SPF tree for Area 0
+- 1.1.1.1 cost 0
   +- 6.6.6.6:145 cost 1
      +- 6.6.6.6:0 cost 1

SPF tree for Area 1
+- 1.1.1.1 cost 0

```

This example shows information about the SPF table for Area 4.

14 Enter the **show ipv6 ospf spf** command with the **table** keyword.

```
device# show ipv6 ospf spf table
SPF table for Area 4
  Destination          Bits Options  Cost  Nexthop                               Interface
R 3.3.3.3              ---EB V6---NR--    1 fe80::227:f8ff:feca:bbb8 Te 4/0/2
R 5.5.5.5              ---E- V6---NR--    1 fe80::205:33ff:fee5:4eda Te 4/0/3
N 4.4.4.4[2]          ----- V6---NR--    1 :: Te 4/0/2
N 5.5.5.5[3]          ----- V6---NR--    1 :: Te 4/0/3
```

This example shows information about the SPF table for Area 4.

15 Enter the **show ipv6 ospf redistribute route** command.

```
device# show ipv6 ospf redistribute route

Id      Prefix                Protocol  Metric Type  Metric
105     2::2/128              Connect  Type-2  0
108     2001:6:4::/64         Connect  Type-2  0
106     4001::/64             Connect  Type-2  0
```

This example shows information about routes that the device has redistributed into OSPFv3.

16 Enter the **show ipv6 ospf routes** command and specify an IPv6 address.

```
device# show ipv6 ospf routes 2001:3:0:1::/64
Destination          Cost      E2Cost      Tag      Flags      Dis
OA 2001:3:0:1::/64   2         0           0        00000003 110
Next_Hop_Router      Outgoing_Interface Adv_Router
fe80::227:f8ff:feca:bbb8 Te 4/0/2      3.3.3.3
```

This example shows information about a specified OSPFv3 route.

## Clearing OSPFv3 redistributed routes

OSPFv3 redistributed routes for a device can be cleared using a CLI command.

The **show ipv6 ospf redistribute route** command is entered to verify that there are IPv6 routes on the device that have been redistributed into OSPFv3. The **clear ipv6 ospf redistribution** command is entered to clear all OSPFv3 redistributed routes. The **show ipv6 ospf redistribute route** command is re-entered to verify that the OSPFv3 redistributed routes have been cleared.

1. Enter the **exit** command. Repeat as necessary.

```
device(config)# exit
Enters privileged EXEC mode.
```

2. Enter the **show ipv6 ospf redistribute route** command.

```
device# show ipv6 ospf redistribute route
Id      Prefix                Protocol  Metric Type  Metric
34      1900:53:131::130/124 Connect  Type-2  0
36      2001:2031::/64        Connect  Type-2  0
37      2001:3031::/64        Connect  Type-2  0
38      2001:3032::/64        Connect  Type-2  0
39      2001:3033::/64        Connect  Type-2  0
32      2001:a131:131:132::/64 Static   Type-2  1
35      2131:131::/64         Connect  Type-2  0
33      3001::132/128         Connect  Type-2  0
device#
```

Displays all IPv6 routes that the device has redistributed into OSPFv3.

3. Enter the **clear ipv6 ospf redistribution** command.

```
device# clear ipv6 ospf redistribution
```

Clears OSPFv3 redistributed routes.

4. Enter the **show ipv6 ospf redistribute route** command.

```
device# show ipv6 ospf redistribute route
Id      Prefix                               Protocol  Metric  Type  Metric
41      1900:53:131::130/124                 Connect  Type-2  0
43      2001:2031::/64                       Connect  Type-2  0
44      2001:3031::/64                       Connect  Type-2  0
45      2001:3032::/64                       Connect  Type-2  0
46      2001:3033::/64                       Connect  Type-2  0
47      2001:a131:131:132::/64                Static   Type-2  1
42      2131:131::/64                       Connect  Type-2  0
40      3001::132/128                       Connect  Type-2  0
device#
```

Displays all IPv6 routes that the device has redistributed into OSPFv3.

The following example clears OSPFv3 redistributed routes for a device and verifies that the OSPFv3 redistributed routes have been cleared:

```
device(config-ipv6-router-ospf-vrf)# exit
device(config-rbridge-id-122)# exit
device(config)# exit
device# show ipv6 ospf redistribute route
device# clear ipv6 ospf redistribution
device# show ipv6 ospf redistribute route
```

# Configuring VRF-lite for OSPF

---

- Overview of VRF-lite for OSPF..... 85
- Benefits and applications of VRF-lite..... 86
- OSPF VRF-lite for customer-edge routers..... 86
- Example of VRF-lite usage in a service provider network..... 87
- Configuring OSPF VRF-lite for customer-edge routers..... 87
- VRF-lite for OSPF configuration example..... 88

## Overview of VRF-lite for OSPF

VRF-lite provides a reliable mechanism for trusted VPNs to be built over a shared infrastructure. The ability to maintain multiple virtual routing or forwarding tables allows overlapping private IP addresses to be maintained across VPNs.

Virtual Private Networks (VPNs) have been a key application in networking for a long time. Many possible solutions have been proposed over the last several years. Among the many requirements driving this need have been the need for secure transport of sensitive information and controlling information access to those who need it. In large enterprises, particularly those distributed across disparate locations, sensitivity to information pertinent to a department drives the requirement for an IT manager to logically demarcate information flows to be within that department. The need for privacy is another driver behind deployment of VPN solutions.

VPN technologies can be broadly classified into two types:

- secure VPNs.
- trusted VPNs.

**Secure VPNs** require traffic to be encrypted and authenticated and are most important when communication occurs across an infrastructure that is not trusted (e.g. over the public Internet). The most commonly deployed types of secure VPNs are IPSec VPNs and SSL (Secure Sockets Layer) VPNs. Both offer encryption of data streams. While IPSec VPNs operate at the network layer and require special client software, SSL VPNs are more application centric and can generally work with any SSL-enabled browser.

**Trusted VPNs** ensure integrity and privacy of the data transfers but do not provide any encryption capabilities. Trusted VPNs are most useful when the goal is to leverage a shared infrastructure to allow virtual networks to be built. Examples of such "trusted VPN" technologies include IP based Layer 2 VPNs (VPLS, VLL), ATM or Frame Relay circuits, Layer 2 Tunneling Protocol (L2TP), etc. In short, all these technologies allow a shared infrastructure to be used without compromising the privacy needs of different users or user groups.

Central to VRF-lite is the ability to maintain multiple "Virtual Routing and Forwarding" (VRF) tables on the same Provider Edge (PE) Router. VRF-lite uses multiple instances of a routing protocol such as OSPF to exchange route information for a VPN among peer PE routers. The VRF-lite capable PE router maps an input customer interface to a unique VPN instance. The router maintains a different VRF table for each VPN instance on that PE router. Multiple input interfaces may also be associated with the same VRF on the router, if they connect to sites belonging to the same VPN. This input interface can be a physical interface or a virtual Ethernet interface on a port.

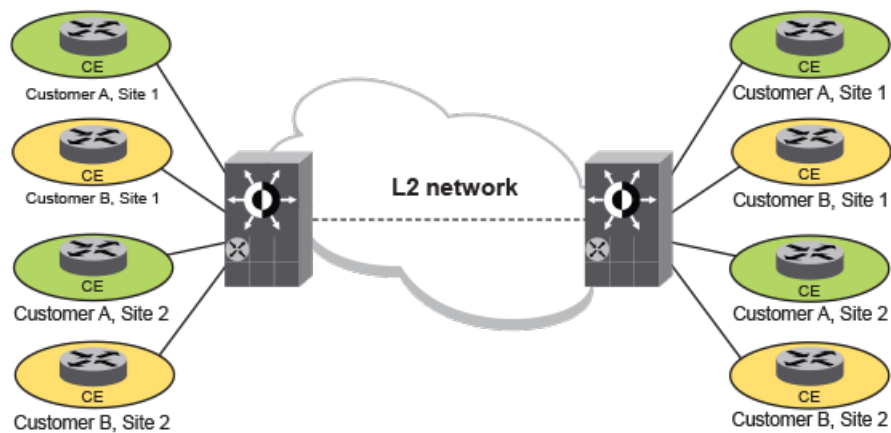
VRF-lite routers communicate with one another by exchanging route information in the VRF table with the neighboring PE router. This exchange of information among the PE routers is done using OSPF.

The PE routers that communicate with one another should be directly connected at Layer 3. Customers connect to PE routers in the network using Customer Edge (CE) routers as shown in the figure below.

Different routing protocols may be used for exchanging information between the PE-PE routers and between the adjacent PE-CE routers. Further, different PE-CE routing protocols may be used in a VPN to exchange customer routes with the various customer sites in that VPN. The routes learned from the PE-CE protocol are added to the corresponding VRF instance and redistributed through the PE-PE protocol to the peer router in the backbone network.

The below figure depicts a network using VRF-lite to provide connectivity among sites that belong to multiple VPNs. To share the VPN route table information with remote PEs, each PE creates separate virtual interfaces and run different instances of the PE-PE routing protocol for each VRF.

**FIGURE 9** A Network deploying VRF-lite



## Benefits and applications of VRF-lite

VRF-lite provides a reliable mechanism for a network administrator to maintain multiple virtual routers on the same device. The goal of providing isolation among different VPN instances is accomplished without the overhead of heavyweight protocols used in secure VPN technologies. Overlapping address spaces can be maintained among the different VPN instances.

Both OSPFv2 for IPv4 and OSPFv3 for IPv6 have VRF-lite support.

## OSPF VRF-lite for customer-edge routers

A customer edge (CE) router acts as the provider edge (PE) router in VRF-Lite.

When a type 3, 5, or 7 link-state advertisement (LSA) is sent from a PE router running multiprotocol BGP to a CE router, the DN (down) bit in the LSA options field must be set. This prevents any type 3, 5, or 7 LSA messages sent from the CE router to the PE router from being distributed any farther. The PE router ignores messages with the DN bit set and does not add these routes to the VRF (Virtual Routing and Forwarding) routing table.

**NOTE**

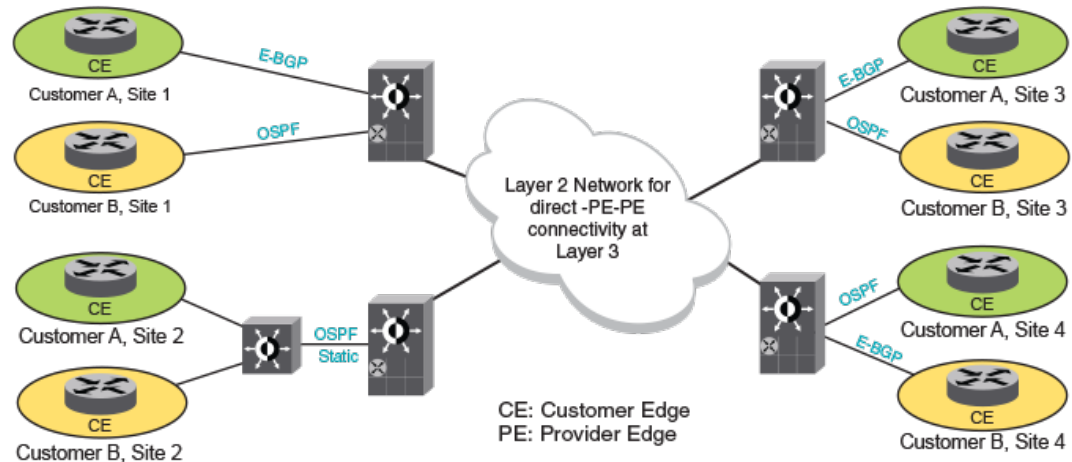
The CLI VRF-lite-capability present in OSPFv2 is not present in OSPFv3. Therefore, when a BGP route is redistributed from an MPLS domain into OSPFv3 and the DN (down) bit is set, the routes must be installed in the OSPFv3 routing table. Such routes could get propagated back into the MPLS cloud if there are OSPFv3 back-door links configured.

## Example of VRF-lite usage in a service provider network

The figure below depicts the use of VRF-lite in a typical service provider application. This service provider owns a Layer 2 network connecting the PEs and offers managed VPN services to end users. As shown in the figure below, a host of PE-CE routing protocols can be used-E-BGP, OSPF, or Static Routing.

It is also possible that a site (such as site 2) may have several customers in close geographical proximity as in a business park. This may warrant a dedicated MTU to be placed on-site, which is owned by the service provider. In such a scenario, the different customers may share the same MTU and still use overlapping private address spaces. The MTU is a switch that adds a unique VLAN tag for each connected customer. The PE router (labeled PE2) maps a Layer 3 tagged interface to a unique VRF. Thus, it could be sharing routes using OSPF with one CE and just using Static Routing with another CE (both of these may occur over different virtual interfaces on the same physical interface).

**FIGURE 10** VRF-lite in a service provider application



## Configuring OSPF VRF-lite for customer-edge routers

When you enable VRF-Lite on a customer-edge (CE) router, the down (DN) bit setting is ignored, allowing the CE router to add these routes to the Virtual Routing and Forwarding (VRF) routing table.

To enable VRF-Lite, perform the following steps:

1. Access global configuration mode.  
switch# configure
2. Enter RBridge ID configuration mode.  
switch(config)# rbridge-id 122
3. Enable OSPF routing on a VRF instance.  
switch(rbridge-id 122)# router ospf vrf 1
4. Enable VRF-Lite for the VRF instance.  
switch(config-ospf-router-vrf-1)# vrf-lite-capability

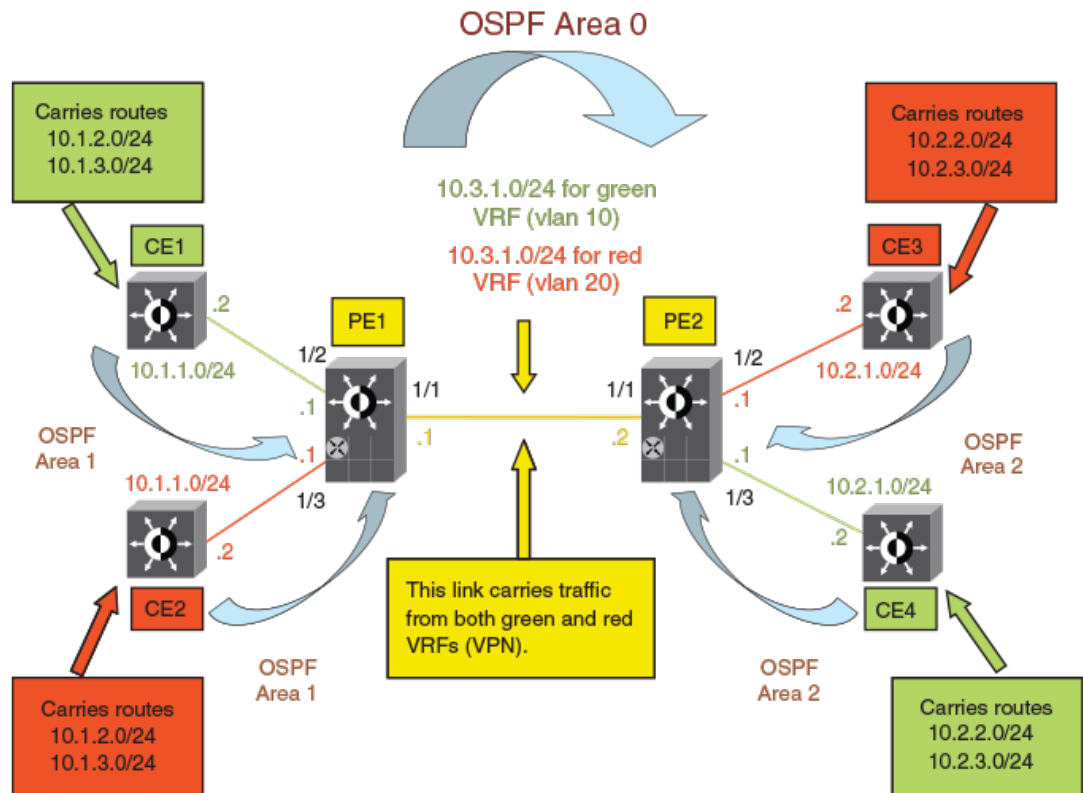
**NOTE**

To disable VRF-Lite, use the **no vrf-lite-capability** command. This disables the VRF instance only. It does not disable the default VRF.

## VRF-lite for OSPF configuration example

In this configuration example, OSPF (Area 0) is configured between PE1 and PE2 and OSPF (Area 1 and Area 2) is configured between PEs and CEs.

**FIGURE 11** OSPF (Area 0) configured between PE1 and PE2 with OSPF (Area 1 and Area 2) configured between PEs and CEs



The following configuration examples for PE1, PE2, CE1, CE2, CE3, and CE4 describe how to create the example shown in the figure above.



## PE1 configuration

In this configuration, VLANs 10 and 20 are created as a link on a tagged port (e 1/10) between PE1 and PE2. Two VRFs ("RED" and "GREEN") are then defined with each having a unique Route Distinguisher (RD). VRF "Green" is assigned an RD value of 10:10, and VRF "Red" is assigned an RD value of 20:20.

Because OSPF is the only routing protocol used in this set-up, multiple OSPF areas are used. Area 0 is configured between the two PEs. Area 1 is configured PE1 and CE's 1 and 2. Area 0 is configured between the two PEs. Area 2 is configured PE2 and CE's 3 and 4.

The virtual Interfaces (ve10 and ve20) are configured with the same IP address (10.3.1.1/24) and for VRF forwarding in the appropriate VRF (Green or Red)

```
switch# config
switch(config)# interface te 1/2/1
switch(conf-if-te-1/2/1)# interface vlan 10
switch(config-Vlan-10)# interface vlan 20
switch(config-Vlan-20)# interface te 1/2/1
switch(conf-if-te-1/2/1)# switchport mode trunk
switch(conf-if-te-1/2/1)# switchport trunk allowed vlan add 10
switch(conf-if-te-1/2/1)# switchport trunk allowed vlan add 20
switch(config)# rbridge-id 1
switch(config-rbridge-id-1)# vrf green
switch(config-vrf-green)# rd 10:10
switch(config-vrf-green)# address-family ipv4 unicast
switch(vrf-ipv4-unicast)# address-family ipv6 unicast
switch(config-vrf-green)# vrf red
switch(config-vrf-red)# rd 20:20
switch(config-vrf-red)# address-family ipv4 unicast
switch(vrf-ipv4-unicast)# address-family ipv6 unicast
switch(vrf-ipv6-unicast)# router ospf vrf green
switch(config-router-ospf-vrf-green)# area 0
switch(config-router-ospf-vrf-green)# area 1
switch(config-router-ospf-vrf-green)# router ospf vrf red
switch(config-router-ospf-vrf-red)# area 0
switch(config-router-ospf-vrf-red)# area 1
switch(config)# interface te 1/2/2
switch(conf-if-te-1/2/2)# vrf forwarding green
switch(conf-if-te-1/2/2)# ip ospf area 1
switch(conf-if-te-1/2/2)# ip address 10.1.1.1/24
switch(conf-if-te-1/2/2)# interface te 1/2/3
switch(conf-if-te-1/2/3)# vrf forwarding red
switch(conf-if-te-1/2/3)# ip ospf area 1
switch(conf-if-te-1/2/3)# ip address 10.1.1.1/24
switch(conf-if-te-1/2/3)# rbridge-id 1
switch(config-rbridge-id-1)# interface ve 10
switch(config-Ve-10)# vrf forwarding green
switch(config-Ve-10)# ip ospf area 0
switch(config-Ve-10)# ip address 10.3.1.1/24
switch(config-Ve-10)# interface ve 20
switch(config-Ve-20)# vrf forwarding red
switch(config-Ve-20)# ip ospf area 0
switch(config-Ve-20)# ip address 10.3.1.1/24
. Both are also configured in OSPF Area 0.
```

## PE2 configuration

The PE2 configuration is a mirror image of the PE1 configuration. The only difference is that PE2 connects to CE3 and CE 4 in OSPF Area 2.

```
switch# config
switch(config)# interface te 1/2/1
switch(conf-if-te-1/2/1)# interface vlan 10
switch(config-Vlan-10)# interface vlan 20
switch(config-Vlan-20)# interface te 1/2/1
switch(conf-if-te-1/2/1)# switchport mode trunk
switch(conf-if-te-1/2/1)# switchport trunk allowed vlan add 10
switch(conf-if-te-1/2/1)# switchport trunk allowed vlan add 20
switch(config)# rbridge-id 1
switch(config-rbridge-id-1)# vrf green
switch(config-vrf-green)# rd 10:10
```

```

switch(config-vrf-green)# address-family ipv4 unicast
switch(vrf-ipv4-unicast)# address-family ipv6 unicast
switch(config-vrf-green)# vrf red
switch(config-vrf-red)# rd 20:20
switch(config-vrf-red)# address-family ipv4 unicast
switch(vrf-ipv4-unicast)# address-family ipv6 unicast
switch(vrf-ipv6-unicast)# router ospf vrf green
switch(config-router-ospf-vrf-green)# area 0
switch(config-router-ospf-vrf-green)# area 2
switch(config-router-ospf-vrf-green)# router ospf vrf red
switch(config-router-ospf-vrf-red)# area 0
switch(config-router-ospf-vrf-red)# area 2
switch(config)# interface te 1/2/2
switch(conf-if-te-1/2/2)# vrf forwarding green
switch(conf-if-te-1/2/2)# ip ospf area 2
switch(conf-if-te-1/2/2)# ip address 10.1.1.1/24
switch(conf-if-te-1/2/2)# interface te 1/2/3
switch(conf-if-te-1/2/3)# vrf forwarding red
switch(conf-if-te-1/2/3)# ip ospf area 2
switch(conf-if-te-1/2/3)# ip address 10.1.1.1/24
switch(conf-if-te-1/2/3)# rbridge-id 1
switch(config-rbridge-id-1)# interface ve 10
switch(config-Ve-10)# vrf forwarding green
switch(config-Ve-10)# ip ospf area 0
switch(config-Ve-10)# ip address 10.3.1.1/24
switch(config-Ve-10)# interface ve 20
switch(config-Ve-20)# vrf forwarding red
switch(config-Ve-20)# ip ospf area 0
switch(config-Ve-20)# ip address 10.3.1.1/24

```

## CE 1 and CE 2 configurations

The CE1 and CE2 router configurations are exactly the same. Both are configured in OSPF Area 1 with route redistribution enabled. The IP addresses: 10.1.2.1/24 and 10.1.3.1/24 are configured for the Loopback1 interface allowing them to carry routes from these networks.

```

switch# config
switch(config)# rbridge-id 1
switch(config-rbridge-id-1)# interface ve 10
switch(config-Ve-10)# rb 18
switch(config)# rb 18
switch(config-rbridge-id-18)# router ospf
switch(config-router-ospf-vrf-default-vrf)# area 1
switch(config-router-ospf-vrf-default-vrf)# redistribute connected
switch(config-router-ospf-vrf-default-vrf)# exit
switch(config-rbridge-id-18)# interface Loopback 1
switch(config-Loopback-1)# ip address 10.1.2.1/32
switch(config-Loopback-1)# ip address 10.1.3.1/32 (Loopback is /32 format for
ipv4 ).
switch(config-Loopback-1)# exit
switch(config-rbridge-id-18)# exit
switch(config)# interface TenGigabitEthernet 18/2/4
switch(conf-if-te-18/2/4)# ip ospf area 1
switch(conf-if-te-18/2/4)# ip address 10.1.1.2/24

```

## CE 3 and CE 4 configurations

The CE3 and CE4 router configurations are exactly the same. Both are configured in OSPF Area 2 with route redistribution enabled. The IP addresses: 10.2.2.1/24 and 10.2.3.1/24 are configured for the Loopback1 interface allowing them to carry routes from these networks

```

switch# config
switch(config)# rbridge-id 1
switch(config-rbridge-id-1)# interface ve 10
switch(config-Ve-10)# rb 18
switch(config)# rb 18
switch(config-rbridge-id-18)# router ospf
switch(config-router-ospf-vrf-default-vrf)# area 2
switch(config-router-ospf-vrf-default-vrf)# redistribute connected
switch(config-router-ospf-vrf-default-vrf)# exit
switch(config-rbridge-id-18)# interface Loopback 1

```

```
switch(config-Loopback-1)# ip address 10.1.2.1/32
switch(config-Loopback-1)# ip address 10.1.3.1/32 (Loopback is /32 format for ipv4 ).
switch(config-Loopback-1)# exit
switch(config-rbridge-id-18)# exit
switch(config)# interface TenGigabitEthernet 18/2/4
switch(conf-if-te-18/2/4)# ip ospf area 2
switch(conf-if-te-18/2/4)# ip address 10.1.1.2/24
```

# Configuring BGP

---

- [BGP overview](#)..... 92
- [Understanding BGP configuration fundamentals](#)..... 99
- [Configuring BGP](#)..... 112

## BGP overview

Border Gateway Protocol (BGP) is an exterior gateway protocol that performs inter-autonomous system (AS) or inter-domain routing. It peers to other BGP-speaking systems over TCP to exchange network reachability and routing information. BGP primarily performs two types of routing: inter-AS routing, and intra-AS routing. BGP peers belonging to different autonomous systems use the inter-AS routing, referred as Exterior BGP (EBGP). On the other hand, within an AS BGP can be used to maintain a consistent view of network topology, to provide optimal routing, or to scale the network.

BGP is a path vector protocol and implements this scheme on large scales by treating each AS as a single point on the path to any given destination. For each route (destination), BGP maintains the AS path and uses this to detect and prevent loops between autonomous systems.

The Open Shortest Path First (OSPF) protocol (supported in Network OS 3.0 and later) provides dynamic routing within the VCS and internal domain. However, even though OSPF suffices for most of the routing needs within the VCS, an exterior gateway protocol such as BGP is needed for inter-domain routing outside the VCS domain.

## BGP support

Support for BGP on Network OS platforms is for BGP4 (compliant with RFC 1771 and 4271), and provides the following:

- Connectivity from the VCS to a core/external network or cloud
- A foundation to support virtual routing and forwarding (VRF) for multi-tenancy and remote-VCS access and route distribution across VRFs
- A foundation to support VRF scaling (OSPF does not scale well with lots of VRFs)
- A foundation to support OSPF Interior Gateway Protocol (IGP) scaling needs in future

---

### NOTE

An L3 License is required to enable BGP routing.

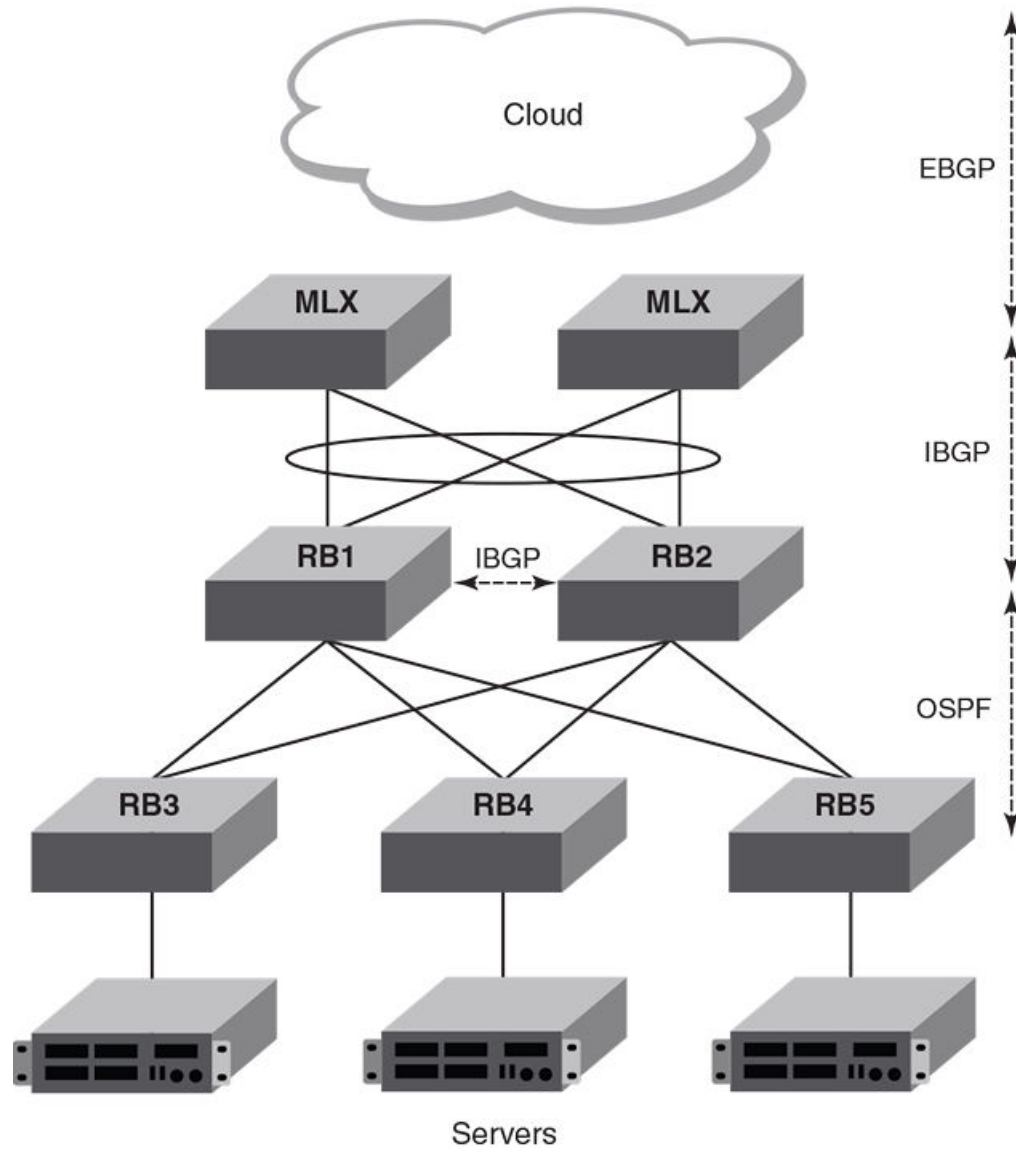
---

## Deployment scenarios

BGP is typically used in a VCS Fabric at the aggregation layer and in connecting to the core. Routing bridges at the aggregation layer can either connect directly to the core, or connect through an MLX. The topologies below illustrate connectivity with and without an MLX. The details of these topologies are discussed in subsequent sections.

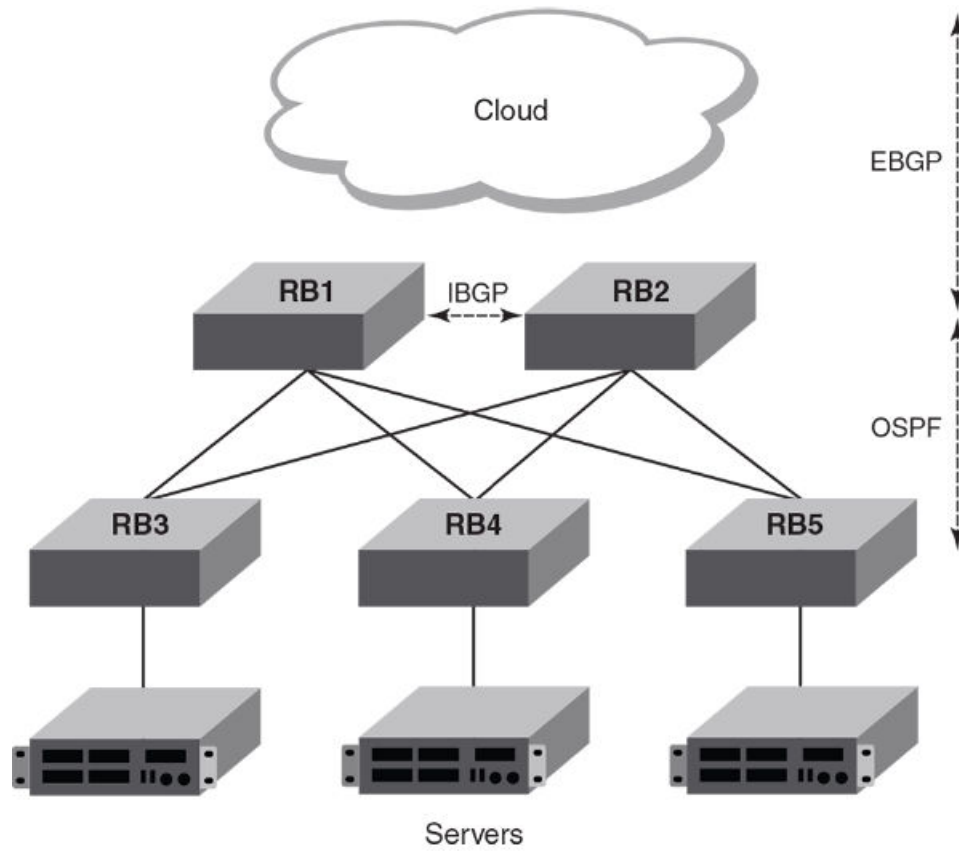
The figure below illustrates connectivity to the core through an MLX. The Rbridges use OSPF and IBGP to communicate with each other, connecting to the MLX through IBGP. The MLX connects in turn to the core through EBGP.

**FIGURE 12** Connectivity to the core through an MLX

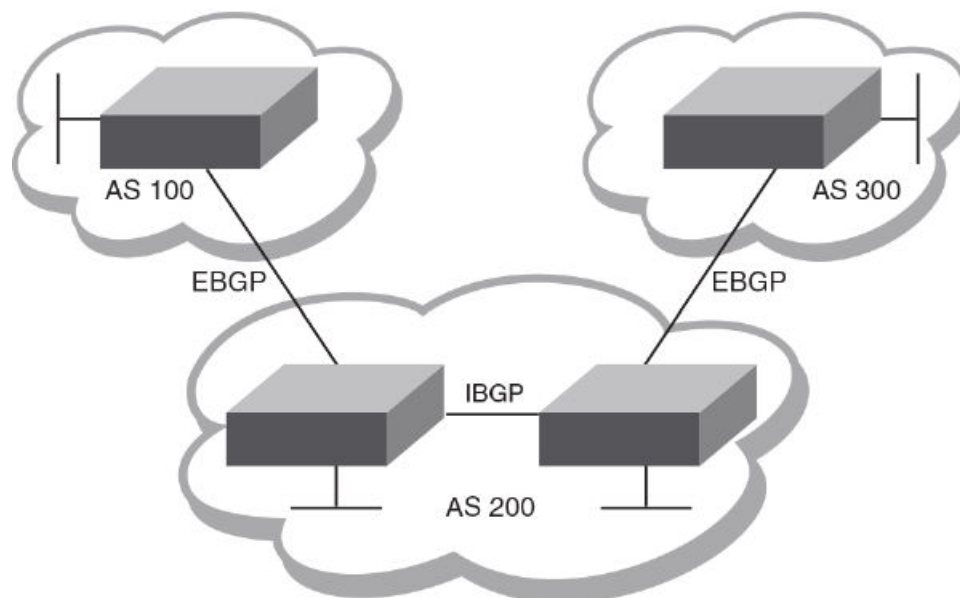


The figure below illustrates the previous topology but without an MLX.

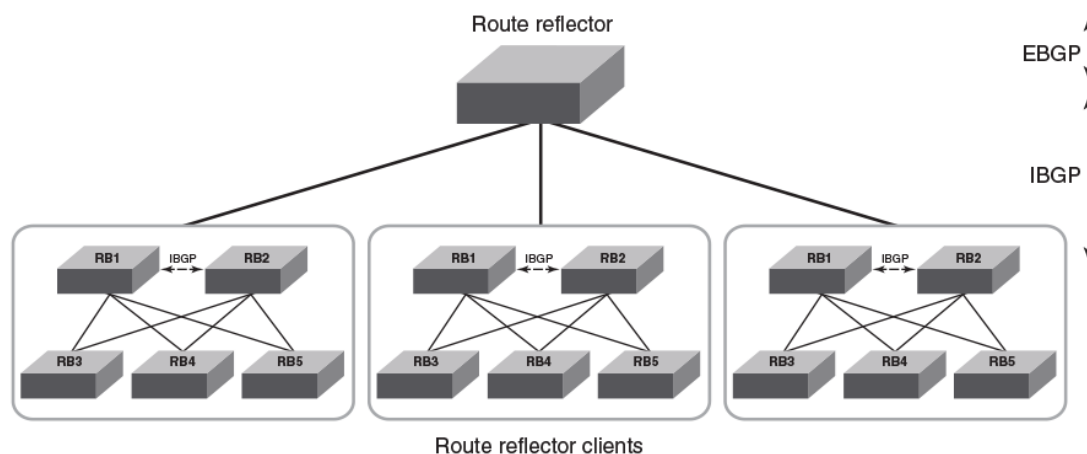
**FIGURE 13** Connectivity to the core without an MLX



The figure below illustrates the role of BGP in communicating through multiple VCS clusters and autonomous systems.

**FIGURE 14** BGP with multiple VCS clusters and autonomous systems

The figure below illustrates a BGP topology that incorporates a route-reflector server and route-reflector clients.

**FIGURE 15** BGP route-reflector server and clients

## BGP peering

Unlike OSPF or other IGP protocols, BGP does not have neighbor detection capability. BGP neighbors (or peers) must be configured manually. A router configured to run BGP is called a BGP "speaker." A BGP speaker connects to another speaker (either in the same or a different AS) by using a TCP connection to port 179 (the well-known BGP port), to exchange the routing information. The TCP connection is maintained throughout the peering session. While the connection between BGP peers is alive, two peers communicate by means of the following types of messages:

- OPEN
- UPDATE

- KEEPALIVE
- NOTIFICATION
- ROUTE REFRESH

BGP peering can be internal or external, depending on whether the two BGP peers belong to the same AS or different ASs. A BGP session between peers within a single AS is referred to as an Interior BGP (IBGP) session; a session between peers belonging to different ASs is referred to as an Exterior BGP (EBGP) session.

In order to establish a TCP connection between two IBGP peers, the IP reachability should be established either by means of the underlying IGP protocol (OSPF) or by means of static routes. When routes are advertised within IBGP peers, the following primary actions are taken in contrast to EBGP peering:

- Routes learned from an IBGP peer are not usually advertised to other IBGP peers, in order to prevent loops within an AS.
- Path attributes are not usually changed, in order to maintain the best path selection at other nodes within an AS.
- The AS path and next hop are not normally changed.

### ***BGP message types***

All BGP messages use a common packet header, with the following byte lengths:

Marker	Length	Type	Data
16	2	1	variable

#### **NOTE**

All values in the following tables are in bytes.

Type can be OPEN, UPDATE, NOTIFICATION, or KEEPALIVE, as described below.

### **OPEN message**

After establishing TCP connection, BGP peers exchange OPEN message to identify each other.

Version	Autonomous System	Hold-Time	BGP Identifier	Optional Parameter Len	Optional Parameters
1	2 or 4	2	4	1	4

#### **Version**

Only BGP4 version 4 is supported.

#### **Autonomous System**

Both 2-byte and 4-byte AS numbers are supported.

#### **KEEPALIVE and HOLDTIME messages**

A BGP **timer** command specifies both **keep-alive** and **hold-time** operands that manage the intervals for BGP KEEPALIVE and HOLDTIME messages. The first operand sets the number of seconds the device waits for UPDATE/KEEPALIVE message before closing the TCP connection. The second operand sets the number of seconds that BGP maintains a session with a neighbor without receiving



messages. When two neighbors have different hold-time values, the lowest value is used. A hold-time value of 0 means "always consider neighbor to be active."

### BGP Identifier

Indicates the router (or device) ID of the sender. When router-id is not configured, device-id is taken from the loopback interface. Otherwise, the lowest IP address in the system is used.

### Parameter List

Optional list of additional parameters used in peer negotiation.

## UPDATE message

The UPDATE message is used to advertise new routes, withdraw previously advertised routes, or both.

WithdrawnRoutesLength	WithdrawnRoutes	Total PathAttributes Len	Path Attributes	NLRI
2	variable	2	variable	variable

### Withdrawn Routes Length

Indicates the length of next (withdrawn routes) field. It can be 0.

### Withdrawn Routes

Contains list of routes (or IP-prefix/Length) to indicate routes being withdrawn.

Total Path Attribute Len

Indicates length of next (path attributes) field. It can be 0.

### Path Attributes

Indicates characteristics of the advertised path. Possible attributes: Origin, AS Path, Next Hop, MED (Multi-Exit Discriminator), Local Preference, Atomic Aggregate, Aggregator.

### NLRI

Network Layer Reachability Information — the set of destinations whose addresses are represented by one prefix. This field contains a list of IP address prefixes for the advertised routes.

## NOTIFICATION message

In case of an error that causes the TCP connection to close, the closing peer sends a notification message to indicate the type of error.

Error Code	ErrorSubcode	Error Data
1	1	variable

### Error Code

Indicates the type of error, which can be one of following:

- Message header error
- Open message error
- Update message error
- Hold timer expired

- Finite state-machine error
- Cease (voluntarily)

#### **Error Subcode**

Provides specific information about the error reported.

#### **Error Data**

Contains data based on error code and subcode.

### **KEEPALIVE message**

Because BGP does not regularly exchanges route updates to maintain a session, KEEPALIVE messages are sent to keep the session alive. A KEEPALIVE message contains just the BGP header without data field. Default KEEPALIVE time is 60 seconds and is configurable.

### **REFRESH message**

A REFRESH message is sent to a neighbor requesting that the neighbor resend the route updates. This is useful when the inbound policy has been changed.

## **BGP attributes**

BGP attributes are passed in UPDATE messages to describe the characteristics of a BGP path by the advertising router. At a high level, there are only two types of attributes: well-known and optional. All of the well-known attributes as described in RFC 4271 are supported in Network OS 4.0 and later.

## **Best-path algorithm**

The BGP decision process is applied to the routes contained in the Routing Information Base, Incoming (RIB-In), which contains routes learned from inbound update messages. The output of the decision process is the set of routes that will be advertised to BGP speakers in local or remote autonomous systems and are stored in the Adjacency RIB, Outgoing (RIB-Out).

When multiple paths for the same route prefix are known to a BGP4 device, the device uses the following algorithm to weigh the paths and determine the optimal path for the route. (The optimal path depends on various parameters, which can be modified.)

1. Verify that the next hop can be resolved by means of Interior Gateway Protocol (IGP).
2. Use the path with the largest weight.
3. Prefer the path with the higher local preference.
4. Prefer the route that was self-originated locally.
5. Prefer the path with the shortest AS-path. An AS-SET counts as 1. A confederation path length, if present, is not counted as part of the path length. (An **as-path ignore** command disables the comparison of the AS path lengths of otherwise equal paths.)
6. Prefer the path with the lowest origin type. From low to high, route origin types are valued as follows:
  - IGP is lowest.
  - EGP is higher than IGP, but lower than INCOMPLETE.
  - INCOMPLETE is highest.
7. Prefer the path with the lowest MED.

The device compares the MEDs of two otherwise equivalent paths if and only if the routes were learned from the same neighboring AS. This behavior is called deterministic MED. Deterministic MED is always enabled and cannot be disabled.

To ensure that the MEDs are always compared, regardless of the AS information in the paths, the **always-compare-med** command can be used. This option is disabled by default.

The **med-missing-as-worst** command can be used to make the device regard a BGP4 route with a missing MED attribute as the least-favorable path when the MEDs of the route paths are compared.

MED comparison is not performed for internal routes that originate within the local AS or confederation, unless the **compare-med-empty-aspath** command is configured.

8. Prefer paths in the following order:

- Routes received through EBGp from a BGP4 neighbor outside of the confederation
- Routes received through EBGp from a BGP4 device within the confederation or routes received through IBGP.

9. If all the comparisons above are equal, prefer the route with the lowest IGP metric to the BGP4 next hop. This is the closest internal path inside the AS to reach the destination.

10. If the internal paths also are the same and BGP4 load sharing is enabled, load-share among the paths. Otherwise go to Step 11.

---

#### NOTE

For EBGp routes, load sharing applies only when the paths are from neighbors within the same remote AS. EBGp paths from neighbors in different ASs are not compared, unless multipath multi-as is enabled.

---

11. If **compare-routerid** is enabled, prefer the path that comes from the BGP4 device with the lowest device ID. If a path contains originator ID attributes, then the originator ID is substituted for the router ID in the decision.

12. Prefer the path with the minimum cluster-list length.

13. Prefer the route that comes from the lowest BGP4 neighbor address.

## BGP limitations and considerations

The following limitations and considerations apply to BGP support on Network OS platforms:

- VRF functionality is not supported.
- There is no backward compatibility. In case of a downgrade, BGP configurations are lost.
- There is no support for nonstop routing.
- RASLogs are generated when a BGP session begins.
- RASTRACE logs are available with module ID "261 BGP".
- BGP logs are generated with module ID "BGP-1002".

## Understanding BGP configuration fundamentals

This section provides an overview of the configuration considerations and basic steps required to enable BGP functionality. Examples are provided in [Configuring BGP](#) on page 112.

Similar to other Layer 3 protocols in Network OS, BGP is supported only in the VCS mode of operation. Each RBridge in a VCS fabric running BGP acts as an individual BGP device. BGP can form IBGP peering with other RBridges in the same VCS fabric running BGP.

## Configuring BGP

To enable BGP on an RBridge, enter Bridge ID configuration mode and issue the **router bgp** command:

```
switch(config-rbridge-id-12)# router bgp
```

There are two CLI modes for BGP:

- Global BGP
- BGP Address-Family IPv4 Unicast

After issuing the **router bgp** command, you first enter into BGP configuration mode, where an address-family-specific configuration can be applied. In order to apply an IPv4 address-family-specific configuration, issue the **address-family ipv4 unicast** command.

To create a route map, enter the **route-map** command while in RBridge ID configuration mode. Then declare a route-map name by using a **permit** or **deny** statement and an instance number.

To remove the entire BGP configuration, issue the **no router bgp** command.

## Device ID

BGP automatically calculates the device identifier it uses to specify the origin in routes it advertises. If a router-id configuration is already present in the system, then device-id is used as the router-id. Otherwise, BGP first checks for a loopback interface, and the IP address configured on that interface is chosen as the device-id. However, if a loopback interface is not configured, the device-id is chosen from lowest-numbered IP interface address configured on the device. Once device-id is chosen, the device identifier is not calculated unless the IP address configured above is deleted.

## Local AS number

The local AS number (ASN) identifies the AS in which the BGP device resides. It can be configured from BGP global mode:

```
switch(config-bgp-router)# local-as 6500
```

Use well-known private ASNs in the range from 64512 through 65535 if the AS number of the organization is not known.

## IPv4 unicast address family

The IPv4 unicast address family configuration level provides access to commands that allow you to configure BGP4 unicast routes. The commands that you enter at this level apply only to the IPv4 unicast address family.

BGP4 supports the IPv4 address family configuration level. This configuration is applied in the IPv4 address-family unicast submode of BGP:

```
device(config-bgp-router)# address-family ipv4 unicast
device(config-bgp-ipv4u)#
```

The commands that you can access while at the IPv4 unicast address family configuration level are also available at the IPv6 unicast address family configuration levels. Each address family configuration level allows you to access commands that apply to that particular address family only.

Where relevant, this chapter discusses and provides IPv4-unicast-specific examples. You must first configure IPv4 unicast routing for any IPv4 routing protocol to be active.

The following configurations are allowed under BGP IPv4 address-family unicast mode:

- Network (including static networks)
- Route aggregation
- Route redistribution
- Route reflection
- Dampening
- Graceful restart
- Default route origination
- Multipathing (including maximum paths)
- Address-family-specific neighbor configuration
- Explicit specification of networks to advertise
- BGP confederations
- BGP extended communities

The following configuration options are allowed under BGP IPv4 address family unicast mode

```
device(config-bgp-router)# address-family ipv4 unicast

device(config-bgp-ipv4u)# ?
Possible completions:
 aggregate-address          Configure BGP aggregate entries
 always-propagate          Allow readvertisement of best BGP routes not in IP
 Forwarding table
  bgp-redistribute-internal Allow redistribution of iBGP routes into IGP
  client-to-client-reflection Configure client to client route reflection
  dampening                Enable route-flap dampening
  default-information-originate Originate Default Information
  default-metric           Set metric of redistributed routes
  do                       Run an operational-mode command
  exit                     Exit from current mode
  graceful-restart        Enables the BGP graceful restart capability
  help                    Provide help information
  maximum-paths           Forward packets over multiple paths
  multipath               Enable multipath for ibgp or ebgp neighbors only
  neighbor                Specify a neighbor router
  network                 Specify a network to announce via BGP
  next-hop-enable-default Enable default route for BGP next-hop lookup
  next-hop-recursion      Perform next-hop recursive lookup for BGP route
  no                       Negate a command or set its defaults
  pwd                     Display current mode path
  redistribute            Redistribute information from another routing
 protocol
  rib-route-limit         Limit BGP rib count in routing table
  static-network         Special network that do not depends on IGP and
 always treat as best route in BGP
  table-map              Map external entry attributes into routing table
  top                    Exit to top level and optionally run command
  update-time            Configure igp route update interval
```

## BGP global mode

Configurations that are not specific to address-family configuration are available in the BGP global configuration mode:

```
switch(config-bgp-router)# ?
Possible completions:
 address-family            Enter Address Family command mode
 always-compare-med       Allow comparing MED from different neighbors
 as-path-ignore           Ignore AS_PATH length for best route selection
 capability               Set capability
 cluster-id               Configure Route-Reflector Cluster-ID
 compare-med-empty-aspah Allow comparing MED from different neighbors even with
 empty as-path attribute
 compare-routerid         Compare router-id for identical BGP paths
 default-local-preference Configure default local preference value
 distance                 Define an administrative distance
 enforce-first-as         Enforce the first AS for EBGp routes
```

fast-external-fallover	Reset session if link to EBGp peer goes down
install-igp-cost	Install igp cost to nexthop instead of MED value as
BGP cost	
local-as	Configure local AS number
log-dampening-debug	Log dampening debug messages
maxas-limit	Impose limit on number of ASes in AS-PATH attribute
med-missing-as-worst	Consider routes missing MED attribute as least
desirable	
neighbor	Specify a neighbor router
timers	Adjust routing timers

## Neighbor configuration

For each neighbor a device is going to peer with, there must be a neighbor configuration that specifies an IP address (which must be the primary IP address of interface connection to get established) and an AS number of the neighbor. For each neighbor, you can specify a set of attributes. However, in case a set of neighbors share same set of attributes, then it is advisable to use a peer-group. The peer-group configuration is described in the next subsection.

The following illustrates the configuration of a neighbor's IP address and AS number:

```
switch(config-bgp-router)# neighbor 10.231.64.10 remote-as 6500
switch(config-bgp-router)#
```

Notice that the neighbor configuration appears in both the global and address-family modes of BGP. The neighbor parameters/attributes that are common to all of the address families appear in the BGP global mode; the parameters/attributes that are specific to an address family appear within the BGP address-family submode. Even though only the IPv4 unicast address family is supported currently, the options of the **neighbor** command are divided, to support future address families such as IPv6.

The following **running-config** excerpt illustrates the neighbor configurations that are allowed in BGP global mode and IPv4 address-family submode:

```
router bgp
  local-as 6500
  neighbor 10.231.64.10 advertisement-interval 60
  neighbor as-override
  neighbor 10.231.64.10 capability as4-enable
  neighbor 10.231.64.10 description "Example Neighbor Configuration"
  neighbor 10.231.64.10 ebgp-multihop 2
  neighbor 10.231.64.10 enforce-first-as
  neighbor 10.231.64.10 local-as 64900
  neighbor 10.231.64.10 maxas-limit in disable
  neighbor 10.231.64.10 next-hop-self always
  neighbor 10.231.64.10 password default
  neighbor 10.231.64.10 remote-as 1200
  neighbor 10.231.64.10 remove-private-as
  neighbor 10.231.64.10 shutdown generate-rib-out
  neighbor 10.231.64.10 soft-reconfiguration inbound
  neighbor 10.231.64.10 timers keep-alive 120 hold-time 240
  neighbor 10.231.64.10 update-source loopback lo0
  address-family ipv4 unicast
    neighbor 10.231.64.10 default-originate route-map test-map
    neighbor 10.231.64.10 filter-list [ 1 ] in
    neighbor 10.231.64.10 maximum-prefix 15000 teardown
    neighbor 10.231.64.10 prefix-list test-prefix in
    neighbor 10.231.64.10 route-map in test-map
    neighbor 10.231.64.10 send-community both
    neighbor 10.231.64.10 unsuppress-map test-map-2
    neighbor 10.231.64.10 weight 10
```

As mentioned above, a set of configurations can be specified for each neighbor, with support for the following:

- Advertisement interval
- Default route origination
- Enforcing of first AS in AS-path list as AS of originator
- AS path filter list
- Enforcing of local ASN of neighbor

- Enabling/disabling of 4-byte ASN capability at the BGP global level
- Maximum AS path length
- Ignoring of AS path lengths of otherwise equal paths
- Maximum routes learned from neighbor
- Enforcing of nexthop as self in routes advertised
- MD5 password authentication
- Prefix list for route filtering
- Remote AS
- Removing of private ASN while advertising routes
- Route map filtering
- Sending community attributes
- Shutting down of neighbor without removing the configuration
- Applying policy changes without resetting neighbor
- Keepalive and hold time
- Specifying of routes not to be suppressed in route aggregation
- Specifying of source IP to be used in TCP connection to neighbor
- Adding of weight to each route received from neighbor

## Peer groups

Neighbors having the same attributes and parameters can be grouped together by means of the **peer-group** command. You must first create a peer-group, after which you can associate neighbor IP addresses with the peer-group. All of the attributes that are allowed on a neighbor are allowed on a peer-group as well.

Configurations for both creating a peer-group and associating neighbors to the peer-group are available in BGP global mode. As an example, you can create a peer-group named "external-group" as follows:

```
switch(config-bgp-router)# neighbor external-group peer-group
```

Subsequently, you can associate neighbors to "external-group," and configure attributes on the peer-group as illustrated below:

```
switch(config-bgp-router)# neighbor 172.29.233.2 peer-group external-group
switch(config-bgp-router)# neighbor 10.120.121.2 peer-group external-group
switch(config-bgp-router)# neighbor external-group remote-as 1720
```

An attribute value configured explicitly for a neighbor takes precedence over the attribute value configured on peer-group. In case neither the peer-group nor the individual neighbor has the attribute configured, the default value for the attribute is used.

## Four-byte AS numbers

Four-byte autonomous system numbers (ASNs) can be optionally configured on a device, peer-group, or neighbor. If this is enabled, the device announces and negotiates "AS4" capability with its neighbors. You can configure AS4 capability to be enabled or disabled at the BGP global level:

```
switch(config-bgp-router)# capability as4-enable
```

You can do the same at the neighbor or peer-group level:

```
switch(config-bgp-router)# neighbor 172.29.233.2 capability as4-enable
```

You can configure AS4 capability to be enabled for a neighbor while still keeping AS4 numbers disabled at the global level, or vice-versa. The neighbor AS4 capability configuration takes precedence. If AS4 capability is not configured on the neighbor, then the peer-group configuration takes effect. The global configuration is used if AS4 capability is configured neither at the neighbor nor at the peer-group level. If

a device having a 4-byte ASN tries to connect to a device that does not have AS4 support, peering will not be established.

## Route redistribution

The redistribution of static, connected, and OSPF routes into BGP is supported. Similarly, routes learned through BGP can also be redistributed into OSPF. An optional route-map can be specified, and this map will be consulted before routes are added to BGP. Management routes are not redistributed.

You configure redistribution under IPv4 address-family mode:

```
switch(config-bgp-router)# address-family ipv4 unicast
switch(config-bgp-ipv4u)# redistribute ?
Possible completions:
  connected          Connected
  ospf                Open Shortest Path First (OSPF)
  static              Static routes
```

While redistributing routes learned by OSPF, you can specify the type of routes to be redistributed. You can choose to redistribute internal, external type1, or external type2 routes.

The **redistribute ospf** command redistributes internal OSPF routes in a way that is equivalent to the effect of the **redistribute ospf match internal** command, as illustrated in this running-config excerpt:

```
router bgp
  local-as 6500
  address-family ipv4 unicast
    redistribute ospf match internal
    redistribute ospf match external1
    redistribute ospf match external2
```

## Advertised networks

As described in the previous section, you can advertise routes into BGP by redistributing static, connected, or OSPF routes. However, you can explicitly specify routes to be advertised by BGP by using the **network** command in IPv4 address-family submode:

```
switch(config-bgp-ipv4u)# network 10.40.25.0/24
```

Before BGP can advertise this route, the routing table must have this route already installed.

Another use of the **network** command is to specify a route to be local. In case the same route is received by means of EBGP, the local IGP route will be preferred. The **backdoor** parameter changes the administrative distance of the route to this network from the EBGP administrative distance (20 by default) to the local BGP4 weight (200 by default), tagging the route as a backdoor route. Use this parameter when you want the device to prefer IGP routes such as RIP or OSPF routes over the EBGP route for the network.

```
switch(config-bgp-ipv4u)# network 10.40.25.0/24 backdoor
```

The **neighbor weight** command specifies a weight that the device adds to routes that are received from the specified BGP neighbor. (BGP4 prefers larger weights over smaller weights.)

## Static networks

Before advertising any route, BGP checks for its existence in the routing table. If you want BGP to advertise a stable route that does not depend on its existence in the routing table, then use the **static-network** command to advertise that network:

```
switch(config-bgp-ipv4u)# static-network 10.40.25.0/24
```



When the configured route is lost, BGP installs the "null0" route in the routing table. Later, when the route is resolved, the null0 route is removed. You can override the administrative local distance of 200 by specifying the distance value in the command:

```
switch(config-bgp-ipv4u)# static-network 10.40.25.0/24 distance 300
```

## Route reflection

A BGP device can act as a route-reflector client or as a route reflector. You can configure a BGP peer as a route-reflector client from the device that is going to reflect the routes and act as the route reflector:

```
switch(config-bgp-ipv4u)# neighbor 10.61.233.2 route-reflector-client
```

When there is more than one route-reflector, they should all belong to the same cluster. By default, the value for **cluster-id** is used as the device ID. However, the device ID can be changed:

```
switch(config-bgp-router)# cluster-id ipv4-address 10.30.13.4
switch(config-bgp-router)# cluster-id 2300
```

The route-reflector server reflects the routes as follows:

- Routes from the client are reflected to client as well as to nonclient peers.
- Routes from nonclient peers are reflected only to client peers.

In case route-reflector clients are connected in a full IBGP mesh, you may wish to disable client-to-client reflection on the route reflector:

```
switch(config-bgp-ipv4u)# no client-to-client-reflection
```

A BGP device advertises only those routes that are preferred ones and are installed into the Routing Table Manager (RTM). When a route could not be installed into the RTM because the routing table was full, the route reflector may not reflect that route. In case the route reflector is not placed directly in the forwarding path, you can configure the route reflector to reflect routes even though those routes are not in the RTM:

```
switch(config-bgp-ipv4u)# always-propagate
```

## Route flap dampening

Unstable routes can trigger a lot of route state changes. You can configure dampening in IPv4 address-family mode to avoid this churn by penalizing the unstable routes:

```
switch(config-bgp-ipv4u)# dampening
```

This command uses default values for the dampening parameters described below:

### ***half-life***

Number of minutes after which penalty for a route becomes half of its value. The route penalty allows routes that have remained stable for a period despite earlier instability to become eligible for reuse after the interval configured by this parameter. The decay rate of the penalty is proportional to the value of the penalty. After the half-life expires, the penalty decays to half its value. A dampened route that is no longer unstable can eventually again become eligible for use. You can configure the half-life to be from 1 through 45 minutes. The default is 15 minutes.

### ***reuse***

Minimum penalty below which routes becomes reusable again. You can set the reuse threshold to a value from 1 through 20000. The default is 750 (0.75, or three-fourths, of the penalty assessed for one flap).

***suppress***

Maximum penalty above which route is suppressed by the device. You can set the suppression threshold to a value from 1 through 20000. The default is 2000 (more than two flaps).

***max-suppress-time***

Maximum number of minutes a route can be suppressed by the device, regardless of how unstable the route is. You can set maximum suppress time to a value from 1 through 255 minutes. The default is 40 minutes.

**NOTE**

A dampening value for half-life can also be adjusted through a route map, by means of the **set dampening** option for the **route-map** command.

**Default route origination**

While redistributing routes from OSPF, BGP does not advertise default route 0.0.0.0/0 even if it exists. You can enable default route origination by using the **default-information-originate** command under IPv4 address-family mode:

```
switch(config-bgp-ipv4u)# default-information-originate
```

In order to advertise a default route without OSPF redistribution, use the **network** command.

**Multipath load sharing**

Unlike IGP, BGP does not perform multipath load sharing by default. Therefore, the maximum number of paths across which BGP can balance the traffic is set to 1 by default. You can change this value by using the **maximum-paths** command in IPv4 address-family mode:

```
switch(config-bgp-ipv4u)# maximum-paths 4
```

You can specify the maximum path value explicitly for IBGP or EBGP:

```
switch(config-bgp-ipv4u)# maximum-paths ebgp 2
```

In case the maximum-path value must be picked up from the **ip load-sharing** configuration on the router, use the following:

```
sw0(config-bgp-ipv4u)# maximum-paths use-load-sharing
```

You can enable multipathing for both IBGP or EBGP. By default, the AS numbers of the two paths should match for them to be considered for multipathing. However, you can remove this restriction by specifying a **multi-as** option, as illustrated in the following **running-config** excerpt:

```
router bgp
  local-as 6500
  address-family ipv4 unicast
    multipath ebgp
    multipath ibgp
    multipath multi-as
```

**Configuring the default route as a valid next-hop**

BGP does not use the default route installed in the device to resolve the BGP next-hop. You can change this in IPv4 address-family mode to enable BGP to use default route for next-hop resolution:

```
sw0(config-bgp-ipv4u)# next-hop-enable-default
```

## Next-hop recursion

Next-hop recursion is disabled by default in BGP, but you can enable it. When next-hop recursion is disabled, only one route lookup is performed to obtain the next-hop IP address. If the lookup result does not succeed or the result points to another BGP path, then route destination is considered unreachable. Enable it as follows:

```
sw0(config-bgp-ipv4u)# next-hop-recursion
```

When next-hop recursion is enabled, if the first lookup for the destination IP address results in an IBGP path that originated in the same AS, the device performs lookup for the IP address of the next-hop gateway. This goes on until the final lookup results in an IGP route. Otherwise, the route is declared unreachable.

## Route filtering

The following route filters are supported:

- AS-path filter
- Community filter
- Prefix list
- Route map
- Table map

---

### NOTE

Support for access lists in route filtering is not available, and has been replaced by prefix-list filtering. BGP does not use community and extended-community filters directly. Rather, it uses them indirectly through route-map filtering by means of the **route-map** command.

---

## Timers

You can change keepalive and hold-time values from their default values of 60 and 180 seconds, respectively:

```
sw0(config-bgp-router)# timers keep-alive 10 hold-time 60
```

A hold-time value of 0 means that the device will wait indefinitely for messages from a neighbor without tearing down the session.

Once the IGP routes are changed, BGP routing tables are affected after 5 seconds by default. You can change this value by using the **update-time** command:

```
sw0(config-bgp-ipv4u)# update-time 0
```

An **update-time** value of 0 will trigger BGP route calculation immediately after the IGP routes are changed.

## BGP4 outbound route filtering

The BGP4 Outbound Route Filtering Capability (ORF) feature is used to minimize the number of BGP updates sent between BGP peers.

When the ORF feature is enabled, unwanted routing updates are filtered out, reducing the amount of system resources required for generating and processing routing updates. The ORF feature is enabled through the advertisement of ORF capabilities to peer routers. The locally configured BGP4 inbound

prefix filters are sent to the remote peer so that the remote peer applies the filter as an outbound filter for the neighbor.

The ORF feature can be configured with send and receive ORF capabilities. The local peer advertises the ORF capability in send mode, indicating that it will accept a prefix list from a neighbor and apply the prefix list to locally configured ORFs. The local peer exchanges the ORF capability in send mode with a remote peer for a prefix list that is configured as an inbound filter for that peer locally. The remote peer only sends the first update once it receives a ROUTEREFRESH request or BGP ORF with IMMEDIATE from the peer. The local and remote peers exchange updates to maintain the ORF on each router.

## BGP4 confederations

A large autonomous system (AS) can be divided into multiple subautonomous systems and grouped into a single BGP4 confederation.

Each subautonomous system must be uniquely identified within the confederation AS by a subautonomous system number. Within each subautonomous system, all the rules of internal BGP (IBGP) apply. For example, all BGP routers inside the subautonomous system must be fully meshed. Although EBGP is used between subautonomous systems, the subautonomous systems within the confederation exchange routing information like IBGP peers. Next hop, Multi Exit Discriminator (MED), and local preference information is preserved when crossing subautonomous system boundaries. To the outside world, a confederation looks like a single AS.

The AS path list is a loop-avoidance mechanism used to detect routing updates leaving one subautonomous system and attempting to re-enter the same subautonomous system. A routing update attempting to re-enter a subautonomous system it originated from is detected because the subautonomous system sees its own subautonomous system number listed in the update's AS path.

## BGP4 extended community

The BGP4 extended community feature filters routes based on a regular expression specified when a route has multiple community values in it.

A BGP community is a group of destinations that share a common property. Community information identifying community members is included as a path attribute in BGP UPDATE messages. You can perform actions on a group using community and extended community attributes to trigger routing decisions. All communities of a particular type can be filtered out, or certain values can be specified for a particular type of community. You can also specify whether a particular community is transitive or non-transitive across an autonomous system (AS) boundary.

An extended community is an 8-octet value and provides a larger range for grouping or categorizing communities. BGP extended community attributes are specified in RFC 4360.

You define the extended community list using the **ip extcommunity-list** command. The extended community can then be matched or applied to the neighbor through the route map. The route map must be applied on the neighbor to which routes need to carry the extended community attributes. The "send-community" should be enabled for the neighbor configuration to start including the attributes while sending updates to the neighbor.

## BGP4+ graceful restart

BGP4+ graceful restart (GR) allows for restarts where neighboring devices participate in the restart, helping to ensure that no route and topology changes occur in the network for the duration of the restart.

The GR feature provides a routing device with the capability to inform its neighbors and peers when it is performing a restart.

When a BGP session is established, GR capability for BGP is negotiated by neighbors and peers through the BGP OPEN message. If the neighbor also advertises support for GR, GR is activated for that neighbor session. If both peers do not exchange the GR capability, the session is not GR-capable. If the BGP session is lost, the BGP peer router, known as a GR helper, marks all routes associated with the device as “stale” but continues to forward packets to these routes for a set period of time. The restarting device also continues to forward packets for the duration of the graceful restart. When the graceful restart is complete, routes are obtained from the helper so that the device is able to quickly resume full operation.

When the GR feature is configured on a device, both helper router and restarting router functionalities are supported. It is not possible to disable helper functionality explicitly.

GR is disabled by default and can be enabled in both IPv4 and IPv6 address families. When the GR timer expires, the BGP RASlog message is triggered.

## Using route maps

A route map is a named set of match conditions and parameter settings that the device can use to modify route attributes and to control redistribution of the routes into other protocols. A route map consists of a sequence of instances, the equivalent of rows in a table. The device evaluates a route according to route map instances in ascending numerical order. The route is first compared against instance 1, then against instance 2, and so on. When a match is found, the device stops evaluating the route.

Route maps can contain **match** clauses and **set** statements. Each route map contains a **permit** or **deny** statement for routes that match the **match** clauses:

- If the route map contains a **permit** statement, a route that matches a match statement is permitted; otherwise, the route is denied.
- If the route map contains a **deny** statement, a route that matches a match statement is denied.
- If a route does not match any **match** statements in the route map, then the route is denied. This is the default action. To change the default action, configure the last **match** statement in the last instance of the route map to **permit any any**.
- If there is no **match** statement, the software considers the route to be a match.
- For route maps that contain address filters, AS-path filters, or community filters, if the action specified by a filter conflicts with the action specified by the route map, the route map action takes precedence over the filter action.

If the route map contains **set** statements, routes that are permitted by the route map **match** statements are modified according to the **set** statements.

Match statements compare the route against one or more of the following:

- The route BGP4 MED (metric)
- The IP address of the next hop device
- The route tag
- For OSPF routes only, the route type (internal, external type 1, or external type 2)
- An AS-path access control list (ACL)

- A community ACL
- An IP prefix list

For routes that match all of the **match** statements, the route map **set** statements can perform one or more of the following modifications to the route attributes:

- Prepend AS numbers to the front of the route AS-path. By adding AS numbers to the AS-path, you can cause the route to be less preferred when compared to other routes based on the length of the AS-path.
- Add a user-defined tag or an automatically calculated tag to the route.
- Set the community attributes.
- Set the local preference.
- Set the MED (metric).
- Set the IP address of the next-hop device.
- Set the origin to IGP or INCOMPLETE.
- Set the weight.

When you configure parameters for redistributing routes into BGP4, one of the optional parameters is a route map. If you specify a route map as one of the redistribution parameters, the device matches the route against the match statements in the route map. If a match is found and if the route map contains **set** statements, the device sets the attributes in the route according to the set statements.

To create a route map, you define instances of the map by a sequence number.

The **route-map name** is a string of characters that defines the map instance. Map names can be up to 80 characters long. The following is the complete syntax of the **route-map** command:

```
[no] route-map name [permit | deny] instance_number] | [continue sequence_number | match [as-path ACL_name | community ACL_name | interface [fortygigabitethernet rbridge-id/slot/port | gigabitethernet rbridge-id/slot/port | loopback port | tengigabitethernet rbridge-id/slot/port | ve port] | ip [address prefix-list name] | next-hop prefix-list name | route-source prefix-list name] | metric number | protocol bgp [external | internal | static-network] | route-type [internal | type-1 | type-2] | tag number | set [as-path [prepend | tag] | automatic-tag | comm-list | community community_number | additive | local-as | no-advertise | no-export | none] | dampening number | distance number | ip next-hop [A.B.C.D | peer-address] | local-preference number] | metric [add number | assign | none | sub] | metric-type [external | internal | type-1 | type-2] | origin [igp | incomplete] | route-type [internal | type-1 | type-2] | tag number | weight number]
```

Operands for this command are defined below.

The **permit | deny** options specify the action the device will take if a route matches a match statement:

- If you specify **deny**, the device does not advertise or learn the route.
- If you specify **permit**, the device applies the match and set clauses associated with this route map instance.

The *instance-number* parameter specifies the instance of the route map you are defining. The following illustrates a creation of a route-map instance 10, which is done in RBridge ID mode. Notice the change in the command prompt.

```
switch(config)# rbridge-id 5
switch(config-rbridge-id-5)# routemap myroutemap1 permit 10
switch(config-route-map-myroutemap1/permit/10)#
```

To delete a route map, enter a command such as the following in RBridge ID configuration mode. When you delete a route map, all the permit and deny entries in the route map are deleted.

```
switch(config-rbridge-id-5)# no route-map myroutemap1
```

This command deletes a route map named myroutemap1. All entries in the route map are deleted.

To delete a specific instance of a route map without deleting the rest of the route map, enter a command such as the following.

```
switch(config-rbridge-id-5)# no route-map myroutemap1 permit 10
```

This command deletes the specified instance from the route map but leaves the other instances of the route map intact.

### ***Specifying the match conditions***

Use the **match** command to define the match conditions for instance 10 of the route map myroutemap1.

```
switch(config-route-map-myroutemap1/permit/10)# match ?
```

Operands for the route-map **match** statement are as follows:

**community num** — Specifies a community ACL. (The ACL must already be configured.)

**ip address | next-hop acl-num | prefix-list string** — Specifies an ACL or IP prefix list. Use this parameter to match based on the destination network or next-hop gateway. To configure an IP ACL for use with this command, use the **ip access-list** command. To configure an IP prefix list, use the **ip prefix-list** command.

**ip route-source acl | prefix name** — Matches on the source of a route (the IP address of the neighbor from which the device learned the route).

**metric num** — Compares the route MED (metric) to the specified value.

**next-hop address-filter-list** — Compares the IP address of the route next-hop to the specified IP address filters. The filters must already be configured.

**route-type [internal | type-1 | type-2]** — Applies only to OSPF routes.

- **internal** — Sets an internal route type.
- **type-1** — Sets an OSPF external route type 1.
- **type-2** — Sets an OSPF external route type 2.

**tag tag-value** — Compares the route tag to the specified tag value.

**protocol bgp static-network** — Matches on BGP4 static-network routes.

**protocol bgp external** — Matches on EBGP (external) routes.

**protocol bgp internal** — Matches on IBGP (internal) routes.

### ***Setting parameters in the routes***

Use the following command to define a **set** statement that prepends an AS number to the AS path on each route that matches the corresponding match statement.

```
switch(config-routemap-myroutemap1/permit10)# set as-path prepend 7701000
```

Operands for the route-map **set** statement are as follows:

**as-path prepend num,num,...** — Adds the specified AS numbers to the front of the AS-path list for the route. Values range from 1 through 65535 for two-byte ASNs, and from 1 through 4294967295 if AS4s have been enabled.

**automatic-tag** — Calculates and sets an automatic tag value for the route. (This parameter applies only to routes redistributed into OSPF.)

**comm-list** — Deletes a community from the community attributes field for a BGP4 route.

**community** — Sets the community attribute for the route to the number or well-known type specified.

**dampening [half-life]** — Sets route dampening parameters for the route; *half-life* specifies the number of minutes after which the route penalty becomes half its value.

**ip next hop ip-addr** — Sets the next-hop IP address for a route that matches a **match** statement in the route map.

**ip next hop** *peer-address* — Sets the BGP4 next hop for a route to the neighbor address.

**local-preference** *num* — Sets the local preference for the route. Values range from 0 through 4294967295.

**metric** [+ | -] *num* | **none** — Sets the Multi-Exit Discriminator (MED) value for the route. Values range from 0 through 4294967295. The default is 0.

- **set metric** *num* — Sets the metric for the route to the specified number.
- **set metric+** *num* — Increases the route metric by the specified number.
- **set metric-** *num* — Decreases route metric by the specified number.
- **set metric none** — Removes the metric from the route (removes the MED attribute from the BGP4 route).

**metric-type type-1 | type-2** — Changes the metric type of a route redistributed into OSPF.

**metric-type internal** — Sets the route MED to the same value as the IGP metric of the BGP4 next-hop route, for advertising a BGP4 route to an EBGp neighbor.

**next hop** *ip-addr* — Sets the IP address of the next-hop device.

**origin igp incomplete** — Sets the route's origin to IGP or INCOMPLETE.

**tag** — Keyword that sets the tag to be an AS-path attribute. (This parameter applies only to routes redistributed into OSPF.)

**weight** *num* — Sets the weight for the route. Values range from 0 through 65535.

### ***Using a route-map continue statement for BGP4 routes***

A **continue** statement in a route-map directs program flow to skip over route-map instances to another, user-specified instance. If a matched instance contains a **continue** statement, the system looks for the instance that is identified in the statement.

The **continue** statement in a matching instance initiates another traversal at the instance specified. The system records all of the matched instances and, if no **deny** statements are encountered, proceeds to execute the **set** clauses of the matched instances.

If the system scans all route-map instances but finds no matches, or if a **deny** condition is encountered, then it does not update the routes. Whenever a matched instance contains a **deny** statement, the current traversal terminates, and none of the updates specified in the **set** statements of the matched instances in both current and previous traversals are applied to the routes.

This supports a more programmable route-map configuration and route filtering scheme for BGP4 peering. It can also execute additional instances in a route map after an instance is executed by means of successful **match** statements. You can configure and organize more-modular policy definitions to reduce the number of instances that are repeated within the same route map.

This feature currently applies to BGP4 routes only. For protocols other than BGP4, **continue** statements are ignored.

## **Configuring BGP**

This section expands upon the preceding overview and provides the following additional BGP management examples.



## Adjusting defaults to improve routing performance

The following examples illustrate a variety of options for enabling and fine-tuning route flap dampening.

To enable default dampening as an address-family function:

```
switch(config)# rbridge-id 10
switch(config-rbridge-id-10)# router bgp
switch(config-bgp-router)# address-family ipv4 unicast
switch(config-bgp-ipv4u)# dampening
```

To change the all dampening values as an address-family function:

```
switch(config)# rbridge-id 10
switch(config-rbridge-id-10)# router bgp
switch(config-bgp-router)# address-family ipv4 unicast
switch(config-bgp-ipv4u)# dampening 20 200 2500 40
```

---

### NOTE

To change any of the parameters, you must specify all the parameters in the command in the following order: **half-life**, **reuse**, **suppress**, **max-suppress-time**. To leave any parameters unchanged, enter their default values.

---

For more details about the use of route maps, including more flap-dampening options, refer to [Using route maps with match and set statements](#) on page 118.

## Configuring BGP4 outbound route filtering

The BGP4 Outbound Route Filtering (ORF) prefix list capability can be configured in receive mode, send mode, or both send and receive modes, minimizing the number of BGP updates exchanged between BGP peers.

1. Enter the **configure terminal** command to access global configuration mode.

```
device# configure terminal
```

2. Enter the **rbridge-id** command with an RBridge ID to enter RBridge ID configuration mode.

```
device(config)# rbridge-id 122
```

3. Enter the **router bgp** command to enable BGP routing.

```
device(config-rbridge-id-122)# router bgp
```

4. Enter the **address-family** command and specify the **ipv4** and **unicast** keywords to enter IPv4 address family configuration mode.

```
device(config-bgp-router)# address-family ipv4 unicast
```

5. Enter the **neighbor ip-address activate** command to add a neighbor.

```
device(config-bgp-ipv4u)# neighbor 10.1.2.3 activate
```

6. Enter the **neighbor ip-address prefix-list** command and specify the **in** keyword to filter the incoming route updates from a specified BGP neighbor.

```
device(config-bgp-ipv4u)# neighbor 10.1.2.3 prefix-list myprefixlist in
```

7. Do one of the following:

- Enter the **neighbor capability orf prefixlist** command and specify the **send** keyword to advertise ORF send capabilities.

```
device(config-bgp-ipv4u)# neighbor 10.1.2.3 capability orf prefixlist send
```

- Enter the **neighbor capability orf prefixlist** command and specify the **receive** keyword to advertise ORF receive capabilities.

```
device(config-bgp-ipv4u)# neighbor 10.1.2.3 capability orf prefixlist receive
```

- Enter the **neighbor capability orf prefixlist** command to configure ORF capability in both send and receive modes.

```
device(config-bgp-ipv4u)# neighbor 10.1.2.3 capability orf prefixlist
```

The following example configures ORF in receive mode.

```
device# configure terminal
device(config)# rbridge-id 122
device(config-rbridge-id-122)# router bgp
device(config-bgp-router)# address-family ipv4 unicast
device(config-bgp-ipv4u)# neighbor 10.1.2.3 activate
device(config-bgp-ipv4u)# neighbor 10.1.2.3 capability orf prefixlist receive
```

The following example configures ORF in send mode.

```
device# configure terminal
device(config)# rbridge-id 122
device(config-rbridge-id-122)# router bgp
device(config-bgp-router)# address-family ipv4 unicast
device(config-bgp-ipv4u)# neighbor 10.1.2.3 activate
device(config-bgp-ipv4u)# 10.1.2.3 prefix-list myprefixlist in
device(config-bgp-ipv4u)# 10.1.2.3 capability orf prefixlist send
```

The following example configures ORF in both send and receive modes.

```
device# configure terminal
device(config)# rbridge-id 122
device(config-rbridge-id-122)# router bgp
device(config-bgp-router)# address-family ipv4 unicast
device(config-bgp-ipv4u)# neighbor 10.1.2.3 activate
device(config-bgp-ipv4u)# neighbor 10.1.2.3 prefix-list myprefixlist in
device(config-bgp-ipv4u)# neighbor 10.1.2.3 capability orf prefixlist
```

## Configuring BGP4 confederations

BGP4 confederations, composed of multiple subautonomous systems, can be created.

1. Enter the **configure terminal** command to access global configuration mode.

```
device# configure terminal
```

2. Enter the **rbridge-id** command with an RBridge ID to enter RBridge ID configuration mode.

```
device(config)# rbridge-id 122
```

3. Enter the **router bgp** command to enable BGP routing.

```
device(config-rbridge-id-122)# router bgp
```

4. Enter the **local-as** command to configure the autonomous system number (ASN) in which your device resides.

```
device(config-bgp-router)# local-as 65520
```

5. Enter the **confederation identifier** command and specify an ASN to configure a BGP confederation identifier.

```
device(config-bgp-router)# confederation identifier 100
```

6. Enter the **confederation peers** command and specify as many ASNs as needed to list all BGP peers that will belong to the confederation.

```
device(config-bgp-router)# confederation peers 65520 65521 65522
```

The following example creates a confederation with the confederation ID “100” and adds three subautonomous systems to the confederation.

```
device# configure terminal
device(config)# rbridge-id 122
device(config-rbridge-id-122)# router bgp
device(config-bgp-router)# local-as 65520
device(config-bgp-router)# confederation identifier 100
device(config-bgp-router)# confederation peers 65520 65521 65522
```

## Defining BGP4 extended communities

In order to apply a BGP4 extended community filter, a BGP4 extended community filter must be defined.

1. Enter the **configure terminal** command to access global configuration mode.

```
device# configure terminal
```

2. Enter the **rbridge-id** command with an RBridge ID to enter RBridge ID configuration mode.

```
device(config)# rbridge-id 122
```

3. Enter the **ip extcommunity-list** command and specify a number to set a BGP extended community filter.

```
device(config-rbridge-id-122)# ip extcommunity-list 1 permit soo 123:2
```

4. Enter the **route-map name** command to create and define a route map and enter route-map configuration mode.

```
device(config-rbridge-id-122)# route-map extComRmap permit 10
Permits a matching pattern.
```

5. Enter the **match extcommunity** command and specify an extended community list number.

```
device(config-route-map-extComRmap/permit/10)# match extcommunity 1
```

6. Enter the **exit** command to return to Rbridge-ID configuration mode.

```
device(config-route-map-extComRmap/permit/10)# exit
```

7. Enter the **route-map name** command to define a route map and enter route-map configuration mode.

```
device(config-rbridge-id-122)# route-map sendExtComRmap permit 10
Permits a matching pattern.
```

8. Enter the **set extcommunity** command and specify the **rt extcommunity value** keyword to specify the route target (RT) extended community attribute.

```
device(config-route-map-sendExtComRmap/permit/10)# set extcommunity rt 3:3
```

9. Enter the **set extcommunity** command and specify the **soo extcommunity value** keyword to the site of origin (SOO) extended community attribute.

```
device(config-route-map-sendExtComRmap/permit/10)# set extcommunity soo 2:2
```

The following example configures an extended community ACL called “extended”, defines a route map, and permits and sets a matching pattern.

```
device# configure terminal
device(config)# rbridge-id 122
device(config-rbridge-id-122)# ip extcommunity-list 1 permit soo 123:2
device(config-rbridge-id-122)# route-map extComRmap permit 10
device(config-route-map-extComRmap/permit/10)# match extcommunity 1
device(config-route-map-extComRmap/permit/10)# exit
device(config-rbridge-id-122)# route-map sendExtComRmap permit 10
device(config-route-map-sendExtComRmap/permit/10)# set extcommunity rt 3:3
device(config-route-map-sendExtComRmap/permit/10)# set extcommunity soo 2:2
```

## Applying a BGP4 extended community filter

A BGP4 extended community filter can be applied .

1. Enter the **configure terminal** command to access global configuration mode.

```
device# configure terminal
```

2. Enter the **rbridge-id** command with an RBridge ID to enter RBridge ID configuration mode.

```
device(config)# rbridge-id 122
```

3. Enter the **ip extcommunity-list** command and specify a number to set a BGP extended community filter.

```
device(config-rbridge-id-122)# ip extcommunity-list 1 permit rt 123:2
```

4. Enter the **router bgp** command to enable BGP routing.

```
device(config-rbridge-id-122)# router bgp
```

5. Enter the **local-as** command to configure the autonomous system number (ASN) in which your device resides.

```
device(config-bgp-router)# local-as 1000
```

6. Enter the **neighbor ip-address remote-as** command to specify the ASN in which the remote neighbor resides.

```
device(config-bgp-router)# neighbor 10.1.2.3 remote-as 1001
```

7. Enter the **address-family** command and specify the **ipv4** and **unicast** keywords to enter IPv4 address family configuration mode.

```
device(config-bgp-router)# address-family ipv4 unicast
```

8. Enter the **neighbor ip-address activate** command to enable the exchange of information with the neighbor.

```
device(config-bgp-ipv4u)# neighbor 10.1.2.3 activate
```

9. Enter the **neighbor ip-address route-map** command and specify the **in** keyword to apply a route map to incoming routes.

```
device(config-bgp-ipv4u)# neighbor 10.1.2.3 route-map in extComRmap
```

10. Enter the **neighbor ip-address route-map** command and specify the **out** keyword to apply a route map to outgoing routes.

```
device(config-bgp-ipv4u)# neighbor 10.1.2.3 route-map out sendExtComRmap
```

11. Enter the **neighbor ip-address send-community** command and specify the **both** keyword to enable the sending of standard and extended attributes in updates to the specified BGP neighbor.

```
device(config-bgp-ipv4u)# neighbor 10.1.2.3 send-community both
```

The following example applies a BGP4 extended community filter.

```
device# configure terminal
device(config)# rbridge-id 122
device(config-rbridge-id-122)# ip extcommunity-list 1 permit rt 123:2
device(config-rbridge-id-122)# router bgp
device(config-bgp-router)# local-as 1000
device(config-bgp-router)# neighbor 10.1.2.3 remote-as 1001
device(config-bgp-router)# address-family ipv4 unicast
device(config-bgp-ipv4u)# neighbor 10.1.2.3 activate
device(config-bgp-ipv4u)# neighbor 10.1.2.3 route-map in extComRmap
device(config-bgp-ipv4u)# neighbor 10.1.2.3 route-map out sendExtComRmap
device(config-bgp-ipv4u)# neighbor 10.1.2.31 send-community both
```

## Configuring BGP4 graceful restart

The graceful restart feature can be configured on a routing device, providing it with the capability to inform its neighbors and peers when it is performing a restart.

1. Enter the **configure** command to access global configuration mode.

```
device# configure
```

2. Enter the **rbridge-id** command with an RBridge ID to enter RBridge ID configuration mode.

```
device(config)# rbridge-id 122
```

3. Enter the **router bgp** command to enable BGP routing.

```
device(config-rbridge-id-122)# router bgp
```

4. Enter the **local-as** command to configure the autonomous system number (ASN) in which your device resides.

```
device(config-bgp-router)# local-as 1000
```

5. Enter the **neighbor ip address remote-as** command to add a neighbor.

```
device(config-bgp-router)# neighbor 10.11.12.13 remote-as 2
```

6. Enter the **address-family** command and specify the **ipv4** and **unicast** keywords to enter IPv4 address-family configuration mode.

```
device(config-bgp-router)# address-family ipv4 unicast
```

7. Enter the **graceful-restart** command to enable the graceful restart feature.

```
device(config-bgp-ipv4u)# graceful-restart
```

8. Do any of the following:

- Enter the **graceful-restart** command and use **purge-time** parameter to overwrite the default purge-time value.

```
device(config-bgp-ipv4u)# graceful-restart purge-time 300
```

- Enter the **graceful-restart** command and use **restart-time** parameter to overwrite the default restart-time advertised to graceful restart-capable neighbors.

```
device(config-bgp-ipv4u)# graceful-restart restart-time 180
```

- Enter the **graceful-restart** command and use **stale-routes-time** parameter to overwrite the default amount of time that a helper device will wait for an EOR message from a peer.

```
device(config-bgp-ipv4u)# graceful-restart stale-routes-time 100
```

The following example enables the GR feature.

```
device# configure
device(config)# rbridge-id 122
device(config-rbridge-id-122)# router bgp
device(config-bgp-router)# local-as 1
device(config-bgp-router)# neighbor 10.11.12.13 remote-as 2
device(config-bgp-router)# address-family ipv4 unicast
device(config-bgp-ipv4u)# graceful-restart
```

The following example enables the GR feature and sets the purge time to 300 seconds, over-writing the default value.

```
device# configure
device(config)# rbridge-id 122
device(config-rbridge-id-122)# router bgp
device(config-bgp-router)# local-as 1
device(config-bgp-router)# neighbor 10.11.12.13 remote-as 2
device(config-bgp-router)# address-family ipv4 unicast
device(config-bgp-ipv4u)# graceful-restart purge-time 180
```

The following example enables the GR feature and sets the restart time to 180 seconds, over-writing the default value.

```
device# configure
device(config)# rbridge-id 122
device(config-rbridge-id-122)# router bgp
device(config-bgp-router)# local-as 1
device(config-bgp-router)# neighbor 10.11.12.13 remote-as 2
device(config-bgp-router)# address-family ipv4 unicast
device(config-bgp-ipv4u)# graceful-restart restart-time 180
```

The following example enables the GR feature and sets the stale-routes time to 100 seconds, over-writing the default value.

```
device# configure
device(config)# rbridge-id 122
device(config-rbridge-id-122)# router bgp
device(config-bgp-router)# local-as 1
device(config-bgp-router)# neighbor 10.11.12.13 remote-as 2
device(config-bgp-router)# address-family ipv4 unicast
device(config-bgp-ipv4u)# graceful-restart stale-routes-time 100
```

Use the **clear ip bgp neighbor all** command with the **all** parameter for the changes to the GR parameters to take effect immediately.

## Using route maps with match and set statements

This section presents the following match and set examples.

### ***Matching on an AS-path ACL***

To configure a route map that matches on AS-path ACL 1:

```
switch(config)# rbridge-id 5
switch(config-rbridge-id-5)# route-map myaclroutemap1 permit 10
switch(config-route-map-myaclroutemap1/permit/10)# match as-path 1
```

***Matching on a community ACL***

To configure a route map that matches on community ACL 1:

```
switch(config)# rbridge-id 5
switch(config-rbridge-id-5)# ip community-list standard 1 permit 123:2
switch(config-rbridge-id-5)# route-map mycommroutemap1 permit 10
switch(config-route-map-mycommroutemap1/permit/10)# match community 1
```

***Matching on a destination network*****NOTE**

You can use the results of an IP ACL or an IP prefix list as the match condition.

To configure a route map that matches on a destination network:

```
switch(config)# rbridge-id 5
switch(config-rbridge-id-5)# route-map mynetroutemap1 permit 10
switch(config-route-map-mynetroutemap1/permit/10)# match ip address prefix-list 1
```

***Matching on a next-hop device***

To configure a route map that matches on a next-hop device:

```
switch(config)# rbridge-id-5
switch(config-rbridge-id-5)# route-map myhoproutemap1 permit 10
switch(config-route-map-myhoproutemap1/permit/10)# match ip next-hop prefix-list 1
```

***Matching on a route source***

To configure a route map that matches on a route source:

```
switch(config)# rbridge-id 5
switch(config)# access-list 10 permit 192.168.6.0 0.0.0.255
switch(config-rbridge-id-5)# route-map mysourceroutemap1 permit 1
switch(config-route-map-mysourceroutemap1/permit/10)# match ip route-source prefix-list 10
```

***Matching on routes containing a specific set of communities***

To configure a route map that matches on a set of communities:

```
switch(config)# rbridge-id 5
switch(config-rbridge-id-5)# ip community-list standard std_1 permit 12:34 no-export
switch(config-rbridge-id-5)# route-map mycommroutemap2 permit 1
switch(config-routemap-mycommroutemap2/permit/1)# match community std_1 exact-match
```

**NOTE**

The first command configures a community ACL that contains community number 12:34 and community name "no-export." The remaining commands configure a route map that matches the community attributes field in BGP4 routes against the set of communities in the ACL. A route matches the route map only if the route contains all the communities in the ACL and no other communities.

To configure an additional community-based route map for comparison with the first:

```
switch(config)# rbridge-id 5
switch(config-rbridge-id-5)# ip community-list standard std_2 permit 23:45 56:78
switch(config-rbridge-id-5)# route-map mycommroutemap3 permit 1
switch(config-routemap-mycommroutemap3/permit/1)# match community std_1 std_2 exact-match
```

**NOTE**

These commands configure an additional community ACL, `std_2`, that contains community numbers 23:45 and 57:68. Route map `mycommroutemap3` compares each BGP4 route against the sets of communities in ACLs `std_1` and `std_2`. A BGP4 route that contains either but not both sets of communities matches the route map. For example, a route containing communities 23:45 and 57:68 matches. However, a route containing communities 23:45, 57:68 and 12:34, or communities 23:45, 57:68, 12:34, and "no-export" does not match. To match, the route communities must be the same as those in exactly one of the community ACLs used by the **match community** statement.

***Matching on a BGP4 static network***

To configure a route map that matches on a static network:

```
switch(config)# rbridge-id 5
switch(config-rbridge-id-5)# route-map mystaticroutemap3 permit 1
switch(config-routemap-mystaticroutemap3/permit/1)# match protocol bgp static-network
switch(config-routemap-mystaticroutemap3/permit/1)# set local-preference 150
switch(config-routemap-mystaticroutemap3/permit/1)# set community no-export
switch(config-routemap-mystaticroutemap3/permit/1)# exit
switch(config)# router bgp
switch(config-bgp)# neighbor 192.168.6.0 route-map out mystaticroutemap3
```

***Matching on an interface***

To configure a route map that matches on an interface:

```
switch(config)# rbridge-id 5
switch(config-rbridge-id-5)# route-map myintroutemap1 permit 99
switch(config-routemap-mymedroutemap/permit/1)# match interface ten 5/1/1 ten 5/3/2
```

***Setting a BGP4 route MED to equal the next-hop route IGP metric***

To set a route's Multi-Exit Discriminator (MED) to the same value as the IGP metric of the BGP4 next-hop route, when advertising the route to a neighbor:

```
switch(config)# rbridge-id 5
switch(config-rbridge-id-5)# route-map mymedroutemap1 permit 1
switch(config-routemap-mymedroutemap/permit/1)# match ip address 1
switch(config-routemap-mymedroutemap/permit/1)# set metric-type internal
```

***Setting the next-hop of a BGP4 route***

To set the next-hop address of a BGP4 route to a neighbor address:

```
switch(config)# rbridge-id 5
switch(config-rbridge-id-5)# route-map mhoproutemap1 permit 1
switch(config-routemap-myhoproutemap/permit/1)# match ip address 1
switch(config-routemap-myhoproutemap/permit/1)# set ip next-hop peer-address
```

***Deleting a community from a BGP4 route***

To delete a community from a BGP4 route's community attributes field:

```
switch(config)# rbridge-id 5
switch(config-rbridge-id-5)# ip community-list standard std_3 permit 12:99 12:86
switch(config-rbridge-id-5)# route-map mcommroutemap1 permit 1
switch(config-routemap-mycommroutemap/permit/1)# match ip address 1
switch(config-routemap-mycommroutemap/permit/1)# set comm-list std_3 delete
```



**NOTE**

The first command configures a community ACL containing community numbers 12:99 and 12:86. The remaining commands configure a route map that matches on routes whose destination network is specified in ACL 1, and deletes communities 12:99 and 12:86 from those routes. The route does not need to contain all the specified communities in order for them to be deleted. For example, if a route contains communities 12:86, 33:44, and 66:77, community 12:86 is deleted.

***Using route-map continue statements***

To configure **continue** statements in a route map:

```
switch(config)# rbridge-id 5
switch(config-rbridge-id-5)# route-map mcontroutemap1 permit 1
switch(config-routemap-mycontroutemap/permit/1)# match metric 10
switch(config-routemap-mycontroutemap/permit/1)# set weight 10
switch(config-routemap-mycontroutemap/permit/1)# match metric 10
switch(config-routemap-mycontroutemap/permit/1)# continue 2
switch(config-routemap-mycontroutemap/permit/1)# route-map mcontroutemap1 permit 2
switch(config-routemap-mycontroutemap/permit/2)# match tag 10
switch(config-routemap-mycontroutemap/permit/2)# set weight 20
```

**NOTE**

This configures the route map to continue to evaluate and execute **match** statements after a successful match occurs. The **continue** statement proceeds to the route map with the specified sequence number. If no sequence number is specified, the statement proceeds to the route map with the next sequence number (an "implied" continue).

***Using a route map to configure dampening***

To apply the dampening half-life established in a route map:

```
switch(config)# rbridge-id 10
switch(config-rbridge-id-10)# route-map myroutemap permit 1
switch(config-routemap-myroutemap/permit/1)# set dampening 20
```

**NOTE**

To change any of the parameters, you must specify all the parameters with the command. To leave any parameters unchanged, enter their default values.

**Clearing configurations**

To refresh all BGP4 neighbor routes:

```
switch# clear ip bgp neighbor all
```

To refresh a route to a specific neighbor:

```
switch# clear ip bgp neighbor 10.11.12.13
```

To clear BGP4 routes:

```
switch# clear ip bgp routes 10.0.0.0/16
```

To clear the BGP4 message counters:

```
switch# clear ip bgp traffic
```

To unsuppress all suppressed BGP4 routes:

```
switch# clear ip bgp dampening
```

To clear the dampening statistics for a BGP4 route:

```
switch# clear ip bgp flap-statistics 10.0.0.0/16
```

## Displaying BGP4 statistics

Various **show ip bgp** commands verify information about BGP4 configurations.

1. Enter the **show ip bgp summary** command.

```
device# show ip bgp summary

BGP4 Summary
Router ID: 10.10.1.4   Local AS Number: 200
Confederation Identifier: not configured
Confederation Peers:
Maximum Number of IP ECMP Paths Supported for Load Sharing: 1
Number of Neighbors Configured: 67, UP: 67
Number of Routes Installed: 258088, Uses 22195568 bytes
Number of Routes Advertising to All Neighbors: 17,035844 (3,099146 entries),
Uses 192,147052 bytes
Number of Attribute Entries Installed: 612223, Uses 55100070 bytes
Neighbor Address  AS#           State      Time      Rt:Accepted Filtered Sent
ToSend
10.1.1.1          100          CONN       1h 3m16s  0          0          0          0
10.1.1.2          100          CONN       1h 3m16s  0          0          0          0
10.1.1.3          100          CONN       1h 3m16s  0          0          0          0
10.1.1.4          100          CONN       1h 3m16s  0          0          0          0
10.1.1.5          100          CONN       1h 3m16s  0          0          122       0
10.1.1.6          100          CONN       1h 3m16s  0          0          122       0
10.1.1.7          100          CONN       1h 3m16s  0          0          0          2
```

This example output gives summarized BGP4 information.

2. Enter the **show ip bgp routes** command, using the **summary** keyword.

```
device# show ip bgp routes summary
Total number of BGP routes (NLRIs) Installed      : 20
Distinct BGP destination networks                 : 20
Filtered BGP routes for soft reconfig              : 100178
Routes originated by this router                   : 2
Routes selected as BEST routes                    : 19
BEST routes not installed in IP forwarding table   : 1
Unreachable routes (no IGP route for NEXTHOP)    : 1
IBGP routes selected as best routes                : 0
EBGP routes selected as best routes                : 17
```

This example shows summarized BGP4 route information.

3. Enter the **show ip bgp routes** command.

```
device# show ip bgp routes
Total number of BGP Routes: 26
Status A:AGGREGATE B:BEST b:NOT-INSTALLED-BEST C:CONFED EBGP D:DAMPED
       E:EBGP H:HISTORY I:IBGP L:LOCAL M:MULTIPATH m:NOT-INSTALLED-MULTIPATH
       S:SUPPRESSED F:FILTERED s:STALE
Prefix      Next Hop      MED      LocPrf      Weight Status
1  10.3.0.0/8  192.168.4.106  1          100          0      BE
   AS_PATH: 65001 4355 701 80
2  10.4.0.0/8  192.168.4.106  107         100          0      BE
   AS_PATH: 65001 4355 1
3  10.60.212.0/22  192.168.4.106  107         100          0      BE
   AS_PATH: 65001 4355 701 1 189
4  10.6.0.0/8   192.168.4.106  107         100          0      BE
   AS_PATH: 65001 4355 3356 7170 1455
5  10.8.1.0/24  192.168.4.106  0           100          0      BE
   AS_PATH: 65001
```

This example shows general BGP4 route information.

4. Enter the **show ip bgp routes** command, using the **unreachable** keyword.

```
device# show ip bgp routes unreachable
Status A:AGGREGATE B:BEST b:NOT-INSTALLED-BEST C:CONFED_EBGP D:DAMPED
```

```

E:EBGP H:HISTORY I:IBGP L:LOCAL M:MULTIPATH m:NOT-INSTALLED-MULTIPATH
S:SUPPRESSED F:FILTERED s:STALE
Prefix          Next Hop      MED      LocPrf      Weight Status
1 10.8.8.0/24    192.168.5.1  0         101         0
AS_PATH: 65001 4355 1

```

This example shows BGP4 routes whose destinations are unreachable using any of the BGP4 paths in the BGP4 route table.

5. Enter the **show ip bgp flap-statistics** command.

```

device# show ip bgp flap-statistics
Total number of flapping routes: 414
Status Code >:best d:damped h:history *:valid
Network      From      Flaps Since  Reuse  Path
h> 10.50.206.0/23 10.90.213.77 1 0 :0 :13 0 :0 :0 65001 4355 1 701
h> 10.255.192.0/20 10.90.213.77 1 0 :0 :13 0 :0 :0 65001 4355 1 7018
h> 10.252.165.0/24 10.90.213.77 1 0 :0 :13 0 :0 :0 65001 4355 1 7018
h> 10.50.208.0/23 10.90.213.77 1 0 :0 :13 0 :0 :0 65001 4355 1 701
h> 10.33.0.0/16 10.90.213.77 1 0 :0 :13 0 :0 :0 65001 4355 1 701
*> 10.17.220.0/24 10.90.213.77 1 0 :1 :4 0 :0 :0 65001 4355 701 62

```

This example shows the routes in the BGP4 route table that have changed state and have been marked as flapping routes.

# Configuring BGP4+

---

• BGP4+ overview.....	124
• BGP global mode .....	124
• IPv6 unicast address family.....	125
• BGP4+ neighbors.....	126
• BGP4+ peer groups.....	126
• BGP4+ next hop recursion.....	127
• BGP4+ NLRI and next hop attributes.....	127
• BGP4+ route reflection.....	128
• BGP4+ route aggregation.....	128
• BGP4+ multipath.....	128
• Route maps.....	129
• BGP4+ outbound route filtering.....	129
• BGP4+ confederations.....	129
• BGP4+ extended community.....	130
• BGP4+ graceful restart.....	130
• Configuring BGP4+.....	130

## BGP4+ overview

The implementation of IPv6 supports multiprotocol BGP (MBGP) extensions that allow Border Gateway Protocol version 4 plus (BGP4+) to distribute routing information. BGP4+ supports all of the same features and functionality as IPv4 BGP (BGP4).

IPv6 MBGP enhancements include:

- An IPv6 unicast address family and network layer reachability information (NLRI)
- Next hop attributes that use IPv6 addresses

---

### NOTE

The implementation of BGP4+ supports the advertising of routes among different address families. However, it supports BGP4+ unicast routes only; it does not currently support BGP4+ multicast routes.

---

## BGP global mode

Configurations that are not specific to address family configuration are available in the BGP global configuration mode.

```
device(config-bgp-router)# ?
```

Possible completions:

address-family	Enter Address Family command mode
always-compare-med	Allow comparing MED from different neighbors

as-path-ignore	Ignore AS_PATH length for best route selection
capability	Set capability
cluster-id	Configure Route-Reflector Cluster-ID
compare-med-empty-aspath	Allow comparing MED from different neighbors even with
empty as-path attribute	
compare-routerid	Compare router-id for identical BGP paths
confederation	Configure AS confederation parameters
default-local-preference	Configure default local preference value
distance	Define an administrative distance
enforce-first-as	Enforce the first AS for EBGP routes
fast-external-fallover	Reset session if link to EBGP peer goes down
install-igp-cost	Install igp cost to nexthop instead of MED value as
BGP cost	
local-as	Configure local AS number
log-dampening-debug	Log dampening debug messages
maxas-limit	Impose limit on number of ASes in AS-PATH attribute
med-missing-as-worst	Consider routes missing MED attribute as least
desirable	
neighbor	Specify a neighbor router
timers	Adjust routing timers

## IPv6 unicast address family

The IPv6 unicast address family configuration level provides access to commands that allow you to configure BGP4+ unicast routes. The commands that you enter at this level apply only to the IPv6 unicast address family.

BGP4+ supports the IPv6 address family configuration level.

You can generate a configuration for BGP4+ unicast routes that is separate and distinct from configurations for IPv4 unicast routes.

The commands that you can access while at the IPv6 unicast address family configuration level are also available at the IPv4 unicast address family configuration levels. Each address family configuration level allows you to access commands that apply to that particular address family only.

Where relevant, this chapter discusses and provides IPv6-unicast-specific examples. You must first configure IPv6 unicast routing for any IPv6 routing protocol to be active.

The following configuration options are allowed under BGP IPv6 address family unicast mode:

```
device(config-bgp-ipv6u)# ?
```

Possible completions:

aggregate-address	Configure BGP aggregate entries
always-propagate	Allow readvertisement of best BGP routes not in IP Forwarding table
bgp-redistribute-internal	Allow redistribution of iBGP routes into IGPs
client-to-client-reflection	Configure client to client route reflection
dampening	Enable route-flap dampening
default-information-originate	Originate Default Information
default-metric	Set metric of redistributed routes
graceful-restart	Enables the BGP graceful restart capability
maximum-paths	Forward packets over multiple paths
multipath	Enable multipath for ibgp or ebgp neighbors only
neighbor	Specify a neighbor router
network	Specify a network to announce via BGP
next-hop-enable-default	Enable default route for BGP next-hop lookup
next-hop-recursion	Perform next-hop recursive lookup for BGP route
redistribute	Redistribute information from another routing protocol
rib-route-limit	Limit BGP rib count in routing table
table-map	Map external entry attributes into routing table
update-time	Configure igp route update interval

## BGP4+ neighbors

BGP4+ neighbors can be configured using link-local addresses or global addresses.

BGP4+ neighbors can be created using link-local addresses for peers in the same link. For link-local peers, the neighbor interface over which the neighbor and local device exchange prefixes is specified through the **neighbor update-source** command, and a route map is configured to set up a global next hop for packets destined for the neighbor.

To configure BGP4+ neighbors that use link-local addresses, you must do the following:

- Add the IPv6 address of a neighbor in a remote autonomous system (AS) to the BGP4+ neighbor table of the local device.
- Identify the neighbor interface over which the neighbor and local device will exchange prefixes using the **neighbor update-source** command.
- Configure a route map to set up a global next hop for packets destined for the neighbor.

The neighbor should be activated in the IPv6 address family configuration mode using the **neighbor activate** command.

BGP4+ neighbors can also be configured using a global address. The global IPv6 address of a neighbor in a remote AS must be added, and the neighbor should be activated in the IPv6 address family configuration mode using the **neighbor activate** command.

## BGP4+ peer groups

Neighbors having the same attributes and parameters can be grouped together by means of the **peer-group** command.

You must first create a peer group, after which you can associate neighbor IPv6 addresses with the peer group. All of the attributes that are allowed on a neighbor are allowed on a peer group as well.

BGP4+ peers and peer groups are activated in the IPv6 address family configuration mode to establish the BGP4+ peering sessions.

An attribute value configured explicitly for a neighbor takes precedence over the attribute value configured on the peer group. In the case where neither the peer group nor the individual neighbor has the attribute configured, the default value for the attribute is used.

---

### NOTE

BGP4 neighbors are established and the prefixes are advertised using the **neighbor IP address remote-as** command in router BGP mode. However, when establishing BGP4+ peer sessions and exchanging IPv6 prefixes, neighbors must also be activated using the **neighbor IPv6 address activate** command in IPv6 address family configuration mode.

---



---

### NOTE

You can add IPv6 neighbors only to an IPv6 peer group. You cannot add an IPv4 neighbor to an IPv6 peer group and vice versa. IPv4 and IPv6 peer groups must remain separate.

---

## BGP4+ next hop recursion

A device can find the IGP route to the next-hop gateway for a BGP4+ route.

For each BGP4+ route learned, the device performs a route lookup to obtain the IPv6 address of the next hop for the route. A BGP4+ route is eligible for addition in the IPv6 route table only if the following conditions are true:

- The lookup succeeds in obtaining a valid next-hop IPv6 address for the route.
- The path to the next-hop IPv6 address is an IGP path or a static route path.

By default, the software performs only one lookup for the next-hop IPv6 address for the BGP4+ route. If the next hop lookup does not result in a valid next hop IPv6 address, or the path to the next hop IPv6 address is a BGP4+ path, the BGP4+ route destination is considered unreachable. The route is not eligible to be added to the IPv6 route table.

The BGP4+ route table can contain a route with a next hop IPv6 address that is not reachable through an IGP route, even though the device can reach a hop farther away through an IGP route. This can occur when the IGP does not learn a complete set of IGP routes, so the device learns about an internal route through IBGP instead of through an IGP. In this case, the IPv6 route table will not contain a route that can be used to reach the BGP4+ route destination.

To enable the device to find the IGP route to the next-hop gateway for a BGP4+ route, enable recursive next-hop lookups. With this feature enabled, if the first lookup for a BGP4+ route results in an IBGP path that originated within the same AS, rather than an IGP path or static route path, the device performs a lookup on the next hop IPv6 address for the next hop gateway. If this second lookup results in an IGP path, the software considers the BGP4+ route to be valid and adds it to the IPv6 route table. Otherwise, the device performs another lookup on the next hop IPv6 address of the next hop for the next hop gateway, and so on, until one of the lookups results in an IGP route.

You must configure a static route or use an IGP to learn the route to the EBGP multihop peer.

## BGP4+ NLRIs and next hop attributes

BGP4+ introduces new attributes to handle multiprotocol extensions for BGP.

Multiprotocol BGP (MBGP) is an extension to BGP that enables BGP to carry routing information for multiple address families.

BGP4+ introduces new attributes to handle multiprotocol extensions for BGP:

- Multiprotocol reachable Network Layer Reachability Information (MP\_REACH\_NLRI): Used to carry the set of reachable destinations, together with the next hop information, to be used for forwarding to these destinations.
- Multiprotocol unreachable NLRI (MP\_UNREACH\_NLRI): Used to carry the set of unreachable destinations.

MP\_REACH\_NLRI and MP\_UNREACH\_NLRI are optional and non-transitive, so that a BGP4+ speaker that does not support the multiprotocol capabilities ignores the information carried in these attributes, and does not pass it to other BGP4+ speakers. A BGP speaker that uses multiprotocol extensions for IPv6 uses the capability advertisement procedures to determine whether the speaker can use multiprotocol extensions with a particular peer.

The next hop information carried in the MP\_REACH\_NLRI path attribute defines the network layer address of the border router that will be used as the next hop to the destinations listed in the MP\_NLRI attribute in the UPDATE message.

MP\_REACH\_NLRI and MP\_UNREACH\_NLRI carry IPv6 prefixes.

## BGP4+ route reflection

A BGP device can act as a route-reflector client or as a route reflector. You can configure a BGP peer as a route-reflector client from the device that is going to reflect the routes and act as the route reflector using the **neighbor route-reflector-client** command.

When there is more than one route reflector, they should all belong to the same cluster. By default, the value for **cluster-id** is used as the device ID. The device ID can be changed using the **cluster-id** command.

The route-reflector server reflects the routes as follows:

- Routes from the client are reflected to the client as well as to nonclient peers.
- Routes from nonclient peers are reflected only to client peers.

If route-reflector clients are connected in a full IBGP mesh, you can disable client-to-client reflection on the route reflector using the **no client-to-client-reflection** command.

A BGP device advertises only those routes that are preferred ones and are installed into the Routing Table Manager (RTM). When a route cannot be installed into the RTM because the routing table is full, the route reflector may not reflect that route. In cases where the route reflector is not placed directly in the forwarding path, you can configure the route reflector to reflect routes even though those routes are not in the RTM using the **always-propagate** command.

## BGP4+ route aggregation

A device can be configured to aggregate routes in a range of networks into a single IPv6 prefix.

By default, a device advertises individual BGP4+ routes for all the networks. The aggregation feature allows you to configure a device to aggregate routes in a range of networks into a single IPv6 prefix. For example, without aggregation, a device will individually advertise routes for networks 2001:db8:0001:0000::/64, 2001:db8:0002:0000::/64, 2001:db8:0003:0000::/64, and so on. You can configure the device to send a single, aggregate route for the networks instead so that the aggregate route would be advertised as 2001:db8::/32 to BGP4 neighbors.

## BGP4+ multipath

The BGP4+ multipath feature can be used to enable load-balancing across different paths.

BGP4+ selects only one best path for each IPv6 prefix it receives before installing it in the IP routing table. If you need load-balancing across different paths, you must enable BGP4+ multipath using the **maximum-paths** command under IPv6 address family configuration mode.

IBGP paths and EBGP paths can be exclusively selected, or a combination of IBGP and EBGP paths can be selected.

The following attributes of parallel paths must match for them to be considered for multipathing:

- Weight
- Local Preference
- Origin
- AS-Path Length
- MED



- Neighbor AS (EBGP multipath)
- AS-PATH match (for IBGP multipath)
- IGP metric to BGP next hop

## Route maps

Route maps must be applied to IPv6 unicast address prefixes in IPv6 address family configuration mode.

By default, route maps that are applied under IPv4 address family configuration mode using the **neighbor route-map** command are applied to only IPv4 unicast address prefixes. To apply route maps to IPv6 unicast address prefixes, the **neighbor route-map** command must be used in IPv6 address family configuration mode. The route maps are applied as the inbound or outbound routing policy for neighbors under the specified address family. Configuring separate route maps under each address family type simplifies managing complicated or different policies for each address family.

## BGP4+ outbound route filtering

The BGP4+ Outbound Route Filtering Capability (ORF) feature is used to minimize the number of BGP updates sent between BGP peers.

When the ORF feature is enabled, unwanted routing updates are filtered out, reducing the amount of system resources required for generating and processing routing updates. The ORF feature is enabled through the advertisement of ORF capabilities to peer routers. The locally configured BGP4+ inbound prefix filters are sent to the remote peer so that the remote peer applies the filter as an outbound filter for the neighbor.

The ORF feature can be configured with send and receive ORF capabilities. The local peer advertises the ORF capability in send mode, indicating that it will accept a prefix list from a neighbor and apply the prefix list to locally configured ORFs. The local peer exchanges the ORF capability in send mode with a remote peer for a prefix list that is configured as an inbound filter for that peer locally. The remote peer only sends the first update once it receives a ROUTEREFRESH request or BGP ORF with IMMEDIATE from the peer. The local and remote peers exchange updates to maintain the ORF on each router.

## BGP4+ confederations

A large autonomous system (AS) can be divided into multiple subautonomous systems and grouped into a single BGP4+ confederation.

Each subautonomous system must be uniquely identified within the confederation AS by a subautonomous system number. Within each subautonomous system, all the rules of internal BGP (IBGP) apply. For example, all BGP routers inside the subautonomous system must be fully meshed. Although EBGP is used between subautonomous systems, the subautonomous systems within the confederation exchange routing information like IBGP peers. Next hop, Multi Exit Discriminator (MED), and local preference information is preserved when crossing subautonomous system boundaries. To the outside world, a confederation looks like a single AS.

The AS path list is a loop-avoidance mechanism used to detect routing updates leaving one subautonomous system and attempting to re-enter the same subautonomous system. A routing update

attempting to re-enter a subautonomous system it originated from is detected because the subautonomous system sees its own subautonomous system number listed in the update's AS path.

## BGP4+ extended community

The BGP4+ extended community feature filters routes based on a regular expression specified when a route has multiple community values in it.

A BGP community is a group of destinations that share a common property. Community information identifying community members is included as a path attribute in BGP UPDATE messages. You can perform actions on a group using community and extended community attributes to trigger routing decisions. All communities of a particular type can be filtered out, or certain values can be specified for a particular type of community. You can also specify whether a particular community is transitive or non-transitive across an autonomous system (AS) boundary.

An extended community is an 8-octet value and provides a larger range for grouping or categorizing communities. BGP extended community attributes are specified in RFC 4360.

You define the extended community list using the **ip extcommunity-list** command. The extended community can then be matched or applied to the neighbor through the route map. The route map must be applied on the neighbor to which routes need to carry the extended community attributes. The "send-community" should be enabled for the neighbor configuration to start including the attributes while sending updates to the neighbor.

## BGP4+ graceful restart

BGP4+ graceful restart (GR) allows for restarts where neighboring devices participate in the restart, helping to ensure that no route and topology changes occur in the network for the duration of the restart.

The GR feature provides a routing device with the capability to inform its neighbors and peers when it is performing a restart.

When a BGP session is established, GR capability for BGP is negotiated by neighbors and peers through the BGP OPEN message. If the neighbor also advertises support for GR, GR is activated for that neighbor session. If both peers do not exchange the GR capability, the session is not GR-capable. If the BGP session is lost, the BGP peer router, known as a GR helper, marks all routes associated with the device as "stale" but continues to forward packets to these routes for a set period of time. The restarting device also continues to forward packets for the duration of the graceful restart. When the graceful restart is complete, routes are obtained from the helper so that the device is able to quickly resume full operation.

When the GR feature is configured on a device, both helper router and restarting router functionalities are supported. It is not possible to disable helper functionality explicitly.

GR is disabled by default and can be enabled in both IPv4 and IPv6 address families. When the GR timer expires, the BGP RASlog message is triggered.

## Configuring BGP4+

## Configuring BGP4+ neighbors using global IPv6 addresses

BGP4+ neighbors can be configured using global IPv6 addresses.

1. Enter the **configure terminal** command to access global configuration mode.

```
device# configure terminal
```

2. Enter the **rbridge-id** command with an RBridge ID to enter RBridge ID configuration mode.

```
device(config)# rbridge-id 122
```

3. Enter the **router bgp** command to enable BGP routing.

```
device(config-rbridge-id-122)# router bgp
```

4. Enter the **local-as** command to configure the autonomous system number (ASN) in which your device resides.

```
device(config-bgp-router)# local-as 1000
```

5. Enter the **neighbor ipv6-address remote-as** command to specify the ASN in which the remote neighbor resides.

```
device(config-bgp-router)# neighbor 2001:db8:93e8:cc00::1 remote-as 1001
```

6. Enter the **address family** command and specify the **ipv6** and **unicast** keywords to enter IPv6 address family configuration mode.

```
device(config-bgp-router)# address-family ipv6 unicast
```

7. Enter the **neighbor ipv6-address activate** command to enable the exchange of information with the neighbor.

```
device(config-bgp-ipv6u)# neighbor 2001:db8:93e8:cc00::1 activate
```

The following example configures a neighbor using a global IPv6 address.

```
device# configure terminal
device(config)# rbridge-id 122
device(config-rbridge-id-122)# router bgp
device(config-bgp-router)# local-as 1000
device(config-bgp-router)# neighbor 2001:db8:93e8:cc00::1 remote-as 1001
device(config-bgp-router)# address-family ipv6 unicast
device(config-bgp-ipv6u)# neighbor 2001:db8:93e8:cc00::1 activate
```

## Configuring BGP4+ neighbors using link-local addresses

BGP4+ neighbors can be configured using link-local addresses.

1. Enter the **configure terminal** command to access global configuration mode.

```
device# configure terminal
```

2. Enter the **rbridge-id** command with an RBridge ID to enter RBridge ID configuration mode.

```
device(config)# rbridge-id 122
```

3. Enter the **router bgp** command to enable BGP routing.

```
device(config-rbridge-id-122)# router bgp
```

4. Enter the **local-as** command to configure the autonomous system number (ASN) in which your device resides.

```
device(config-bgp-router)# local-as 1000
```

5. Enter the **neighbor ipv6-address remote-as** command to specify the ASN in which the remote neighbor resides.

```
device(config-bgp-router)# neighbor fe80:4398:ab30:45de::1 remote-as 1001
```

6. Enter the **neighbor ipv6-address update-source** command to specify an interface.

```
device(config-bgp-router)# neighbor fe80:4398:ab30:45de::1 update-source
tengigabitethernet 122/3/1
```

7. Enter the **address-family** command and specify the **ipv6** and **unicast** keywords to enter IPv6 address family configuration mode.

```
device(config-bgp-router)# address-family ipv6 unicast
```

8. Enter the **neighbor ipv6-address activate** command to enable the exchange of information with the neighbor.

```
device(config-bgp-ipv6u)# neighbor fe80:4398:ab30:45de::1 activate
```

9. Enter the **neighbor ipv6-address route-map** command and specify the **out** to apply a route map to outgoing routes.

```
device(config-bgp-ipv6u)# neighbor fe80:4398:ab30:45de::1 route-map out myroutemap
```

10. Enter the **exit** command until you return to Rbridge-ID configuration mode.

```
device(config-bgp-ipv6u)# exit
```

11. Enter the **route-map name permit** command to define the route map and enter route-map configuration mode.

```
device(config-rbridge-id-122)# route-map myroutemap permit 10
```

12. Enter the **set ipv6 next-hop** command and specify an IPv6 address to set the IPv6 address of the next hop.

```
device(config-route-map-myroutemap/permit/10)# set ipv6 next-hop 2001::10
```

The following example configures a neighbor using a link-local address and configures a route map to set up a global next hop for packets destined for the neighbor.

```
device# configure terminal
device(config)# rbridge-id 122
device(config-rbridge-id-122)# router bgp
device(config-bgp-router)# local-as 1000
device(config-bgp-router)# neighbor fe80:4398:ab30:45de::1 remote-as 1001
device(config-bgp-router)# neighbor fe80:4398:ab30:45de::1 update-source
tengigabitethernet 122/3/1
device(config-bgp-router)# address-family ipv6 unicast
device(config-bgp-ipv6u)# neighbor fe80:4398:ab30:45de::1 activate
device(config-bgp-ipv6u)# neighbor fe80:4398:ab30:45de::1 route-map out myroutemap
device(config-bgp-ipv6u)# exit
device(config-bgp-router)# exit
device(config-rbridge-id-122)# route-map myroutemap permit 10
device(config-route-map-myroutemap/permit/10)# set ipv6 next-hop 2001::10
```

## Configuring BGP4+ peer groups

A peer group can be created and neighbor IPv6 addresses can be associated with the peer group. The peer group is then activated in the IPv6 address family configuration mode.

1. Enter the **configure terminal** command to access global configuration mode.

```
device# configure terminal
```

2. Enter the **rbridge-id** command with an RBridge ID to enter RBridge ID configuration mode.

```
device(config)# rbridge-id 122
```

3. Enter the **router bgp** command to enable BGP routing.

```
device(config-rbridge-id-122)# router bgp
```

4. Enter the **local-as** command to configure the autonomous system number (ASN) in which your device resides.

```
device(config-bgp-router)# local-as 1000
```

5. Enter the **neighbor peer-group-name peer-group** command to create a peer group.

```
device(config-bgp-router)# neighbor mypeergroup1 peer-group
```

6. Enter the **neighbor peer-group-name remote-as** command to specify the ASN of the peer group.

```
device(config-bgp-router)# neighbor mypeergroup1 remote-as 11
```

7. Enter the **neighbor ipv6-address peer-group** command to associate a neighbor with the peer group.

```
device(config-bgp-router)# neighbor 2001:2018:8192::125 peer-group mypeergroup1
```

8. Enter the **neighbor ipv6-address peer-group** command to associate a neighbor with the peer group.

```
device(config-bgp-router)# neighbor 2001:2018:8192::124 peer-group mypeergroup1
```

9. Enter the **address-family** command and specify the **ipv6** and **unicast** keywords to enter IPv6 address family configuration mode.

```
device(config-bgp-router)# address-family ipv6 unicast
```

10. Enter the **neighbor peer-group-name activate** command to establish an IPv6 BGP session with the peer group.

```
device(config-bgp-ipv6u)# neighbor mypeergroup1 activate
```

The following example creates a peer group, specifying two neighbors to belong to the peer group, and activates the peer group.

```
device# configure terminal
device(config)# rbridge-id 122
device(config-rbridge-id-122)# router bgp
device(config-bgp-router)# local-as 1000
device(config-bgp-router)# neighbor mypeergroup1 peer-group
device(config-bgp-router)# neighbor mypeergroup1 remote-as 11
device(config-bgp-router)# neighbor 2001:2018:8192::125 peer-group mypeergroup1
device(config-bgp-router)# neighbor 2001:2018:8192::124 peer-group mypeergroup1
device(config-bgp-router)# address-family ipv6 unicast
device(config-bgp-ipv6u)# neighbor mypeergroup1 activate
```

## Configuring a peer group with IPv4 and IPv6 peers

A peer group that contains both IPv4 and IPv6 peers can be configured.

1. Enter the **configure terminal** command to access global configuration mode.

```
device# configure terminal
```

2. Enter the **rbridge-id** command with an RBridge ID to enter RBridge ID configuration mode.

```
device(config)# rbridge-id 122
```

3. Enter the **router bgp** command to enable BGP routing.

```
device(config-rbridge-id-122)# router bgp
```

4. Enter the **local-as** command to configure the autonomous system number (ASN) in which your device resides.

```
device(config-bgp-router)# local-as 1000
```

5. Enter the **neighbor peer-group-name peer-group** command to create a peer group.

```
device(config-bgp-router)# neighbor p1 peer-group
```

6. Enter the **neighbor peer-group-name remote-as** command to specify the ASN of the peer group.

```
device(config-bgp-router)# neighbor p1 remote-as 11
```

7. Enter the **neighbor ipv6-address peer-group** command to associate a neighbor with the peer group.

```
device(config-bgp-router)# neighbor 2001:2018:8192::124 peer-group p1
```

8. Enter the **neighbor ip address peer-group** command to associate a neighbor with the peer group.

```
device(config-bgp-router)# neighbor 10.0.0.1 peer-group p1
```

9. Enter the **address-family** command and specify the **ipv6** and **unicast** keywords to enter IPv6 address family configuration mode.

```
device(config-bgp-router)# address-family ipv6 unicast
```

10. Enter the **neighbor peer-group-name activate** command to establish an IPv6 BGP session with the peer group.

```
device(config-bgp-ipv6u)# neighbor p1 activate
```

The following example creates a peer group with both IPv6 and IPv4 peers and activates the peer group in the IPv6 address family.

```
device# configure terminal
device(config)# rbridge-id 122
device(config-rbridge-id-122)# router bgp
device(config-bgp-router)# local-as 1000
device(config-bgp-router)# neighbor p1 peer-group
device(config-bgp-router)# neighbor p1 remote-as 11
device(config-bgp-router)# neighbor 2001:2018:8192::124 peer-group p1
device(config-bgp-router)# neighbor 10.0.0.1 peer-group p1
device(config-bgp-router)# address-family ipv6 unicast
device(config-bgp-ipv6u)# neighbor p1 activate
```

## Importing routes into BGP4+

Routes can be explicitly specified for advertisement by BGP.

1. Enter the **configure terminal** command to access global configuration mode.

```
device# configure terminal
```

2. Enter the **rbridge-id** command with an RBridge ID to enter RBridge ID configuration mode.

```
device(config)# rbridge-id 122
```

3. Enter the **router bgp** command to enable BGP routing.

```
device(config-rbridge-id-122)# router bgp
```

4. Enter the **address-family** command and specify the **ipv6** and **unicast** keywords to enter IPv6 address family configuration mode.

```
device(config-bgp-router)# address-family ipv6 unicast
```

5. Enter the **network** command and specify a *network/mask* to import the specified prefix into the BGP4+ database.

```
device(config-bgp-ipv6u)# network 2001:db8::/32
```

The following example imports the 2001:db8::/32 prefix in to the BGP4+ database for advertising.

```
device# configure terminal
device(config)# rbridge-id 122
device(config-rbridge-id-122)# router bgp
device(config-bgp-router)# neighbor fe80:4398:ab30:45de::1 remote-as 1001
device(config-bgp-router)# address-family ipv6 unicast
device(config-bgp-ipv6u)# network 2001:db8::/32
```

## Advertising the default BGP4+ route

A BGP device can be configured to advertise the default IPv6 route to all BGP4+ neighbors and to install that route in the local BGP4+ route table.

1. Enter the **configure terminal** command to access global configuration mode.

```
device# configure terminal
```

2. Enter the **rbridge-id** command with an RBridge ID to enter RBridge ID configuration mode.

```
device(config)# rbridge-id 122
```

3. Enter the **router bgp** command to enable BGP routing.

```
device(config-rbridge-id-122)# router bgp
```

4. Enter the **address-family** command and specify the **ipv6** and **unicast** keywords to enter IPv6 address family configuration mode.

```
device(config-bgp-router)# address-family ipv6 unicast
```

5. Enter the **default-information-originate** command to advertise the default IPv6 route to all BGP4+ neighbors and to install that route in the local BGP4+ route table.

```
device(config-bgp-ipv6u)# default-information-originate
```

The following example enables a BGP4+ device to advertise the default IPv6 route to all BGP4+ neighbors and to install that route in the local BGP4+ route table.

```
device# configure terminal
device(config)# rbridge-id 122
device(config-rbridge-id-122)# router bgp
device(config-bgp-router)# address-family ipv6 unicast
device(config-bgp-ipv6u)# default-information-originate
```

## Advertising the default BGP4+ route to a specific neighbor

A BGP device can be configured to advertise the default IPv6 route to a specific neighbor.

1. Enter the **configure terminal** command to access global configuration mode.

```
device# configure terminal
```

2. Enter the **rbridge-id** command with an RBridge ID to enter RBridge ID configuration mode.

```
device(config)# rbridge-id 122
```

3. Enter the **router bgp** command to enable BGP routing.

```
device(config-rbridge-id-122)# router bgp
```

4. Enter the **local-as** command to configure the autonomous system number (ASN) in which your device resides.

```
device(config-bgp-router)# local-as 1000
```

5. Enter the **address-family** command and specify the **ipv6** and **unicast** keywords to enter IPv6 address family configuration mode.

```
device(config-bgp-router)# address-family ipv6 unicast
```

6. Enter the **neighbor default-originate** command and specify an IPv6 address to enable the BGP4+ device to advertise the default IPv6 route to a specific neighbor.

```
device(config-bgp-ipv6u)# neighbor 2001:db8:93e8:cc00::1 default-originate
```

The following example enables a BGP4+ device to advertise the default IPv6 route to a specific neighbor.

```
device# configure terminal
device(config)# rbridge-id 122
device(config-rbridge-id-122)# router bgp
device(config-bgp-router)# local-as 1000
device(config-bgp-router)# address-family ipv6 unicast
device(config-bgp-ipv6u)# neighbor 2001:db8:93e8:cc00::1 default-originate
```

## Using the IPv6 default route as a valid next hop for a BGP4+ route

In certain cases, such as when a device is acting as an edge device, it can be configured to use the default route as a valid next hop.

1. Enter the **configure terminal** command to access global configuration mode.

```
device# configure terminal
```

2. Enter the **rbridge-id** command with an RBridge ID to enter RBridge ID configuration mode.

```
device(config)# rbridge-id 122
```

3. Enter the **router bgp** command to enable BGP routing.

```
device(config-rbridge-id-122)# router bgp
```

4. Enter the **address-family** command and specify the **ipv6** and **unicast** keywords to enter IPv6 address family configuration mode.

```
device(config-bgp-router)# address-family ipv6 unicast
```

5. Enter the **next-hop-enable-default** command to configure the device to use the default route as a valid next hop.

```
device(config-bgp-ipv6u)# next-hop-enable-default
```

The following example configures a BGP4+ device to use the default route as a valid next hop.

```
device# configure terminal
device(config)# rbridge-id 122
device(config-rbridge-id-122)# router bgp
device(config-bgp-router)# address-family ipv6 unicast
device(config-bgp-ipv6u)# next-hop-enable-default
```

## Enabling next-hop recursion

Next hop recursion can be enabled so that a device can find the IGP route to the next hop gateway for a BGP4+ route.

1. Enter the **configure terminal** command to access global configuration mode.

```
device# configure terminal
```

2. Enter the **rbridge-id** command with an RBridge ID to enter RBridge ID configuration mode.

```
device(config)# rbridge-id 122
```

3. Enter the **router bgp** command to enable BGP routing.

```
device(config-rbridge-id-122)# router bgp
```



4. Enter the **address-family** command and specify the **ipv6** and **unicast** keywords to enter IPv6 address family configuration mode.

```
device(config-bgp-router)# address-family ipv6 unicast
```

5. Enter the **next-hop-recursion** command to enable recursive next hop lookups.

```
device(config-bgp-ipv6u)# next-hop-recursion
```

The following example enables recursive next hop lookups.

```
device# configure terminal
device(config)# rbridge-id 122
device(config-rbridge-id-122)# router bgp
device(config-bgp-router)# address-family ipv6 unicast
device(config-bgp-ipv6u)# next-hop-recursion
```

## Configuring a cluster ID for a route reflector

The cluster ID can be changed if there is more than one route reflector, so that all route reflectors belong to the same cluster.

1. Enter the **configure terminal** command to access global configuration mode.

```
device# configure terminal
```

2. Enter the **rbridge-id** command with an RBridge ID to enter RBridge ID configuration mode.

```
device(config)# rbridge-id 122
```

3. Enter the **router bgp** command to enable BGP routing.

```
device(config-rbridge-id-122)# router bgp
```

4. Enter the **local-as** command to configure the autonomous system number (ASN) in which your device resides.

```
device(config-bgp-router)# local-as 1000
```

5. Enter the **cluster-id** command and specify a value to change the cluster ID of a device from the default device ID.

```
device(config-bgp-router)# cluster-id 321
```

The following example changes the cluster ID of a device from the default device ID to 321.

```
device# configure terminal
device(config)# rbridge-id 122
device(config-rbridge-id-122)# router bgp
device(config-bgp-router)# cluster-id 321
```

## Configuring a route reflector client

A BGP peer can be configured as a route reflector client.

1. Enter the **configure terminal** command to access global configuration mode.

```
device# configure terminal
```

2. Enter the **rbridge-id** command with an RBridge ID to enter RBridge ID configuration mode.

```
device(config)# rbridge-id 122
```

3. Enter the **router bgp** command to enable BGP routing.

```
device(config-rbridge-id-122)# router bgp
```

4. Enter the **local-as** command to configure the autonomous system number (ASN) in which your device resides.

```
device(config-bgp-router)# local-as 1000
```

5. Enter the **address-family** command and specify the **ipv6** and **unicast** keywords to enter IPv6 address family configuration mode.

```
device(config-bgp-router)# address-family ipv6 unicast
```

6. Enter the **neighbor ipv6-address route-reflector-client** command to configure a specified neighbor to be a route reflector client.

```
device(config-bgp-ipv6u)# neighbor 2001:db8:e0ff:783a::4 route-reflector-client
```

The following example configures a neighbor with the IPv6 address 2001:db8:e0ff:783a:4 to be a route reflector client.

```
device# configure terminal
device(config)# rbridge-id 122
device(config-rbridge-id-122)# router bgp
device(config-bgp-router)# local-as 1000
device(config-bgp-router)# address-family ipv6 unicast
device(config-bgp-ipv6u)# neighbor 2001:db8:e0ff:783a::4 route-reflector-client
```

## Aggregating routes advertised to BGP neighbors

A device can be configured to aggregate routes in a range of networks into a single IPv6 prefix.

1. Enter the **configure terminal** command to access global configuration mode.

```
device# configure terminal
```

2. Enter the **rbridge-id** command with an RBridge ID to enter RBridge ID configuration mode.

```
device(config)# rbridge-id 122
```

3. Enter the **router bgp** command to enable BGP routing.

```
device(config-rbridge-id-122)# router bgp
```

4. Enter the **address-family** command and specify the **ipv6** and **unicast** keywords to enter IPv6 address family configuration mode.

```
device(config-bgp-router)# address-family ipv6 unicast
```

5. Enter the **aggregate-address** command to aggregate the routes from a range of networks into a single network prefix.

```
device(config-bgp-ipv6u)# aggregate-address 2001:db8::/32
```

The following example enables a BGP4+ device to advertise the default route and send the default route to a specified neighbor.

```
device# configure terminal
device(config)# rbridge-id 122
device(config-rbridge-id-122)# router bgp
device(config-bgp-router)# address-family ipv6 unicast
device(config-bgp-ipv6u)# aggregate-address 2001:db8::/32
```

## Enabling load-balancing across different paths

The BGP4+ multipath feature can be configured, enabling load-balancing across different paths.

1. Enter the **configure terminal** command to access global configuration mode.

```
device# configure terminal
```

2. Enter the **rbridge-id** command with an RBridge ID to enter RBridge ID configuration mode.

```
device(config)# rbridge-id 122
```

3. Enter the **router bgp** command to enable BGP routing.

```
device(config-rbridge-id-122)# router bgp
```

4. Enter the **address-family** command and specify the **ipv6** and **unicast** keywords to enter IPv6 address family configuration mode.

```
device(config-bgp-router)# address-family ipv6 unicast
```

5. Do one of the following:

- Enter the **maximum-paths** command and specify a value to set the maximum number of BGP4+ shared paths.
- Enter the **maximum-paths** command using the **use-load-sharing** keyword to set the maximum number of BGP4+ shared paths to that of the value already configured using the **ip load-sharing** command.

```
device(config-bgp-ipv6u)# maximum-paths 8
```

or

```
device(config-bgp-ipv6u)# maximum-paths use-load-sharing
```

The following example sets the maximum number of BGP4+ shared paths to 8.

```
device# configure terminal
device(config)# rbridge-id 122
device(config-rbridge-id-122)# router bgp
device(config-bgp-router)# address-family ipv6 unicast
device(config-bgp-ipv6u)# maximum-paths 8
```

The following example sets the maximum number of BGP4+ shared paths to that of the value already configured using the **ip load-sharing** command.

```
device# configure terminal
device(config)# rbridge-id 122
device(config-rbridge-id-122)# router bgp
device(config-bgp-router)# address-family ipv6 unicast
device(config-bgp-ipv6u)# maximum-paths use-load-sharing
```

## Configuring a route map for BGP4+ prefixes

Route maps can be applied to IPv6 unicast address prefixes either as the inbound or outbound routing policy for neighbors under the specified address family.

1. Enter the **configure terminal** command to access global configuration mode.

```
device# configure terminal
```

2. Enter the **ipv6 prefix-list** command and enter a name to configure an IPv6 prefix list.

```
device(config)# ipv6 prefix-list myprefixlist seq 10 permit 2001:db8::/32
```

The prefix list name, sequence number, and permits packets are specified.

3. Enter the **rbridge-id** command with an RBridge ID to enter RBridge ID configuration mode.

```
device(config)# rbridge-id 122
```

4. Enter the **route-map name permit** command to define the route map and enter route map configuration mode.

```
device(config-rbridge-id-122)# route-map myroutemap permit 10
```

5. Enter the **match ipv6 address** command and specify the name of a prefix list.

```
device(config-route-map-myroutemap/permit/10)# match ipv6 address prefix-list myprefixlist
```

6. Enter the **exit** command to return to RBridge ID configuration mode.

```
device(config-route-map-myroutemap/permit/10)# exit
```

7. Enter the **router bgp** command to enable BGP routing.

```
device(config-rbridge-id-122)# router bgp
```

8. Enter the **local-as** command to configure the autonomous system number (ASN) in which your device resides.

```
device(config-bgp-router)# local-as 1000
```

9. Enter the **neighbor ipv6-address remote-as** command to specify the ASN in which the remote neighbor resides.

```
device(config-bgp-router)# neighbor fe80:4398:ab30:45de::1 remote-as 1001
```

10. Enter the **address-family** command and specify the **ipv6** and **unicast** keywords to enter IPv6 address family configuration mode.

```
device(config-bgp-router)# address-family ipv6 unicast
```

11. Enter the **neighbor ipv6-address activate** command to enable the exchange of information with the neighbor.

```
device(config-bgp-ipv6u)# neighbor fe80:4398:ab30:45de::1 activate
```

12. Enter the **neighbor ipv6-address route-map** command and specify the **out** keyword to apply a route map to outgoing routes.

```
device(config-bgp-ipv6u)# neighbor fe80:4398:ab30:45de::1 route-map out myroutemap
```

The following example applies a route map, "myroutemap", as the outbound routing policy for a neighbor.

```
device# configure terminal
device(config)# ipv6 prefix-list myprefixlist seq 10 permit 2001:db8::/32
device(config)# rbridge-id 122
device(config-rbridge-id-122)# route-map myroutemap permit 10
device(config-route-map-myroutemap/permit/10)# match ipv6 address prefix-list myprefixlist
device(config-route-map-myroutemap/permit/10)# exit
device(config-rbridge-id-122)# router bgp
device(config-bgp-router)# local-as 1000
device(config-bgp-router)# neighbor fe80:4398:ab30:45de::1 remote-as 1001
device(config-bgp-router)# address-family ipv6 unicast
device(config-bgp-ipv6u)# neighbor fe80:4398:ab30:45de::1 activate
device(config-bgp-ipv6u)# neighbor fe80:4398:ab30:45de::1 route-map out myroutemap
```

## Redistributing prefixes into BGP4+

Various routes can be redistributed into BGP.

1. Enter the **configure terminal** command to access global configuration mode.

```
device# configure terminal
```

2. Enter the **rbridge-id** command with an RBridge ID to enter RBridge ID configuration mode.

```
device(config)# rbridge-id 122
```

3. Enter the **router bgp** command to enable BGP routing.

```
device(config-rbridge-id-122)# router bgp
```

4. Enter the **address-family unicast** command and specify the **ipv6** and **unicast** keywords to enter IPv6 address family configuration mode.

```
device(config-bgp-router)# address-family ipv6 unicast
```

5. Enter the **redistribute** command using the **ospf** and **external1** keywords to redistribute IPv6 OSPF external type 1 routes.

```
device(config-bgp-ipv6u)# redistribute ospf match external1
```

The following example redistributes OSPF external type 1 routes into BGP4+.

```
device# configure terminal
device(config)# rbridge-id 122
device(config-rbridge-id-122)# router bgp
device(config-bgp-router)# address-family ipv6 unicast
device(config-bgp-ipv6u)# redistribute ospf match external1
```

## Configuring BGP4+ outbound route filtering

The BGP4+ Outbound Route Filtering (ORF) prefix list capability can be configured in receive mode, send mode, or both send and receive modes, minimizing the number of BGP updates exchanged between BGP peers.

1. Enter the **configure terminal** command to access global configuration mode.

```
device# configure terminal
```

2. Enter the **rbridge-id** command with an RBridge ID to enter RBridge ID configuration mode.

```
device(config)# rbridge-id 122
```

3. Enter the **router bgp** command to enable BGP routing.

```
device(config-rbridge-id-122)# router bgp
```

4. Enter the **address-family** command and specify the **ipv6** and **unicast** keywords to enter IPv6 address family configuration mode.

```
device(config-bgp-router)# address-family ipv6 unicast
```

5. Enter the **neighbor ipv6-address activate** command to add a neighbor.

```
device(config-bgp-ipv6u)# neighbor 2001:db8:e0ff:783a::4 activate
```

6. Enter the **neighbor ipv6-address prefix-list** command and specify the **in** keyword to filter the incoming route updates from a specified BGP neighbor.

```
device(config-bgp-ipv6u)# neighbor 2001:db8:e0ff:783a::4 prefix-list myprefixlist
in
```

7. Do one of the following:

- Enter the **neighbor capability orf prefixlist** command and specify the **send** keyword to advertise ORF send capabilities.

```
device(config-bgp-ipv6u)# neighbor 2001:db8:e0ff:783a::4 capability orf
prefixlist send
```

- Enter the **neighbor capability orf prefixlist** command and specify the **receive** keyword to advertise ORF receive capabilities.

```
device(config-bgp-ipv6u)# neighbor 2001:db8:e0ff:783a::4 capability orf
prefixlist receive
```

- Enter the **neighbor capability orf prefixlist** command to configure ORF capability in both send and receive modes.

```
device(config-bgp-ipv6u)# neighbor 2001:db8:e0ff:783a::4 capability orf
prefixlist
```

The following example configures ORF in receive mode.

```
device# configure terminal
device(config)# rbridge-id 122
device(config-rbridge-id-122)# router bgp
device(config-bgp-router)# address-family ipv6 unicast
device(config-bgp-ipv6u)# neighbor 2001:db8:e0ff:783a::4 activate
device(config-bgp-ipv6u)# neighbor 2001:db8:e0ff:783a::4 capability orf prefixlist
receive
```

The following example configures ORF in send mode.

```
device# configure terminal
device(config)# rbridge-id 122
device(config-rbridge-id-122)# router bgp
device(config-bgp-router)# address-family ipv6 unicast
device(config-bgp-ipv6u)# neighbor 2001:db8:e0ff:783a::4 activate
device(config-bgp-ipv6u)# neighbor 2001:db8:e0ff:783a::4 prefix-list myprefixlist in
device(config-bgp-ipv6u)# neighbor 2001:db8:e0ff:783a::4 capability orf prefixlist
send
```

The following example configures ORF in both send and receive modes.

```
device# configure terminal
device(config)# rbridge-id 122
device(config-rbridge-id-122)# router bgp
device(config-bgp-router)# address-family ipv6 unicast
device(config-bgp-ipv6u)# neighbor 2001:db8:e0ff:783a::4 activate
device(config-bgp-ipv6u)# neighbor 2001:db8:e0ff:783a::4 prefix-list myprefixlist in
device(config-bgp-ipv6u)# neighbor 2001:db8:e0ff:783a::4 capability orf prefixlist
```

## Configuring BGP4+ confederations

BGP4+ confederations, composed of multiple subautonomous systems, can be created.

1. Enter the **configure terminal** command to access global configuration mode.

```
device# configure terminal
```

2. Enter the **rbridge-id** command with an RBridge ID to enter RBridge ID configuration mode.

```
device(config)# rbridge-id 122
```

3. Enter the **router bgp** command to enable BGP routing.

```
device(config-rbridge-id-122)# router bgp
```

4. Enter the **local-as** command to configure the autonomous system number (ASN) in which your device resides.

```
device(config-bgp-router)# local-as 65520
```

5. Enter the **confederation identifier** command and specify an ASN to configure a BGP confederation identifier.

```
device(config-bgp-router)# confederation identifier 100
```

6. Enter the **confederation peers** command and specify as many ASNs as needed to list all BGP peers that will belong to the confederation.

```
device(config-bgp-router)# confederation peers 65520 65521 65522
```

The following example creates a confederation with the confederation ID “100” and adds three subautonomous systems to the confederation.

```
device# configure terminal
device(config)# rbridge-id 122
device(config-rbridge-id-122)# router bgp
device(config-bgp-router)# local-as 65520
device(config-bgp-router)# confederation identifier 100
device(config-bgp-router)# confederation peers 65520 65521 65522
```

## Defining BGP4+ extended communities

In order to apply a BGP4+ extended community filter, a BGP4+ extended community filter must be defined.

1. Enter the **configure terminal** command to access global configuration mode.

```
device# configure terminal
```

2. Enter the **rbridge-id** command with an RBridge ID to enter RBridge ID configuration mode.

```
device(config)# rbridge-id 122
```

3. Enter the **ip extcommunity-list** command and specify a number to set a BGP extended community filter.

```
device(config-rbridge-id-122)# ip extcommunity-list 1 permit soo 123:2
```

4. Enter the **route-map name** command to create and define a route map and enter route-map configuration mode.

```
device(config-rbridge-id-122)# route-map extComRmap permit 10
Permits a matching pattern.
```

5. Enter the **match extcommunity** command and specify an extended community list number.

```
device(config-route-map-extComRmap/permit/10)# match extcommunity 1
```

6. Enter the **exit** command to return to Rbridge-ID configuration mode.

```
device(config-route-map-extComRmap/permit/10)# exit
```

7. Enter the **route-mapname** command to define a route map and enter route-map configuration mode.

```
device(config-rbridge-id-122)# route-map sendExtComRmap permit 10
Permits a matching pattern.
```

8. Enter the **set extcommunity** command and specify the **rt extcommunity value** keyword to specify the route target (RT) extended community attribute.

```
device(config-route-map-sendExtComRmap/permit/10)# set extcommunity rt 3:3
```

9. Enter the **set extcommunity** command and specify the **soo extcommunity value** keyword to the site of origin (SOO) extended community attribute.

```
device(config-route-map-sendExtComRmap/permit/10)# set extcommunity soo 2:2
```

The following example configures an extended community ACL called “extended”, defines a route map, and permits and sets a matching pattern.

```
device# configure terminal
device(config)# rbridge-id 122
device(config-rbridge-id-122)# ip extcommunity-list 1 permit soo 123:2
device(config-rbridge-id-122)# route-map extComRmap permit 10
device(config-route-map-extComRmap/permit/10)# match extcommunity 1
device(config-route-map-extComRmap/permit/10)# exit
device(config-rbridge-id-122)# route-map sendExtComRmap permit 10
device(config-route-map-sendExtComRmap/permit/10)# set extcommunity rt 3:3
device(config-route-map-sendExtComRmap/permit/10)# set extcommunity soo 2:2
```

## Applying a BGP4+ extended community filter

A BGP4+ extended community filter can be applied .

1. Enter the **configure terminal** command to access global configuration mode.

```
device# configure terminal
```

2. Enter the **rbridge-id** command with an RBridge ID to enter RBridge ID configuration mode.

```
device(config)# rbridge-id 122
```

3. Enter the **ip extcommunity-list** command and specify a number to set a BGP extended community filter.

```
device(config-rbridge-id-122)# ip extcommunity-list 1 permit rt 123:2
```

4. Enter the **router bgp** command to enable BGP routing.

```
device(config-rbridge-id-122)# router bgp
```

5. Enter the **local-as** command to configure the autonomous system number (ASN) in which your device resides.

```
device(config-bgp-router)# local-as 1000
```

6. Enter the **neighbor ipv6-address remote-as** command to specify the ASN in which the remote neighbor resides.

```
device(config-bgp-router)# neighbor fe80:4398:ab30:45de::1 remote-as 1001
```

7. Enter the **address-family** command and specify the **ipv6** and **unicast** keywords to enter IPv6 address family configuration mode.

```
device(config-bgp-router)# address-family ipv6 unicast
```

8. Enter the **neighbor ipv6-address activate** command to enable the exchange of information with the neighbor.

```
device(config-bgp-ipv6u)# neighbor fe80:4398:ab30:45de::1 activate
```

9. Enter the **neighbor ipv6-address route-map** command and specify the **in** keyword to apply a route map to incoming routes.

```
device(config-bgp-ipv6u)# neighbor fe80:4398:ab30:45de::1 route-map in extComRmap
```

10. Enter the **neighbor ipv6-address route-map** command and specify the **out** keyword to apply a route map to outgoing routes.

```
device(config-bgp-ipv6u)# neighbor fe80:4398:ab30:45de::1 route-map out
sendExtComRmap
```

11. Enter the **neighbor ipv6-address send-community** command and specify the **both** keyword to enable the sending of standard and extended attributes in updates to the specified BGP neighbor.

```
device(config-bgp-ipv6u)# neighbor fe80:4398:ab30:45de::1 send-community both
```



The following example applies a BGP4+ extended community filter.

```
device# configure terminal
device(config)# rbridge-id 122
device(config-rbridge-id-122)# ip extcommunity-list 1 permit rt 123:2
device(config-rbridge-id-122)# router bgp
device(config-bgp-router)# local-as 1000
device(config-bgp-router)# neighbor fe80:4398:ab30:45de::1 remote-as 1001
device(config-bgp-router)# address-family ipv6 unicast
device(config-bgp-ipv6u)# neighbor fe80:4398:ab30:45de::1 activate
device(config-bgp-ipv6u)# neighbor fe80:4398:ab30:45de::1 route-map in extComRmap
device(config-bgp-ipv6u)# neighbor fe80:4398:ab30:45de::1 route-map out
sendExtComRmap
device(config-bgp-ipv6u)# neighbor fe80:4398:ab30:45de::1 send-community both
```

## Configuring BGP4+ graceful restart

The graceful restart feature can be configured on a routing device, providing it with the capability to inform its neighbors and peers when it is performing a restart.

1. Enter the **configure terminal** command to access global configuration mode.

```
device# configure terminal
```

2. Enter the **rbridge-id** command with an RBridge ID to enter RBridge ID configuration mode.

```
device(config)# rbridge-id 122
```

3. Enter the **router bgp** command to enable BGP routing.

```
device(config-rbridge-id-122)# router bgp
```

4. Enter the **local-as** command to configure the autonomous system number (ASN) in which your device resides.

```
device(config-bgp-router)# local-as 1000
```

5. Enter the **neighbor ipv6-address remote-as** command to specify the autonomous system ASN in which the remote neighbor resides.

```
device(config-bgp-router)# neighbor 1000::1 remote-as 2
```

6. Enter the **address-family** command and specify the **ipv6** and **unicast** keywords to enter IPv6 address family configuration mode.

```
device(config-bgp-router)# address-family ipv6 unicast
```

7. Enter the **neighbor ipv6-address activate** command to add a neighbor.

```
device(config-bgp-ipv6u)# neighbor 1000::1 activate
```

8. Enter the **graceful-restart** command to enable the graceful restart feature.

```
device(config-bgp-ipv6u)# graceful-restart
```

9. Do any of the following:

- Enter the **graceful-restart** command using the **purge-time** keyword to overwrite the default purge-time value.

```
device(config-bgp-ipv6u)# graceful-restart purge-time 300
```

- Enter the **graceful-restart** command using the **restart-time** keyword to overwrite the default restart-time advertised to graceful restart-capable neighbors.

```
device(config-bgp-ipv6u)# graceful-restart restart-time 180
```

- Enter the **graceful-restart** command using the **stale-routes-time** keyword to overwrite the default amount of time that a helper device will wait for an EOR message from a peer.

```
device(config-bgp-ipv6u)# graceful-restart stale-routes-time 100
```

The following example enables the graceful restart feature.

```
device# configure terminal
device(config)# rbridge-id 122
device(config-rbridge-id-122)# router bgp
device(config-bgp-router)# local-as 1
device(config-bgp-router)# neighbor 1000::1 remote-as 2
device(config-bgp-router)# address-family ipv6 unicast
device(config-bgp-ipv6u)# neighbor 1000::1 activate
device(config-bgp-ipv6u)# graceful-restart
```

The following example enables the graceful restart feature and sets the purge time to 300 seconds, overwriting the default value.

```
device# configure terminal
device(config)# rbridge-id 122
device(config-rbridge-id-122)# router bgp
device(config-bgp-router)# local-as 1
device(config-bgp-router)# neighbor 1000::1 remote-as 2
device(config-bgp-router)# address-family ipv6 unicast
device(config-bgp-ipv6u)# neighbor 1000::1 activate
device(config-bgp-ipv6u)# graceful-restart purge-time 300
```

The following example enables the graceful restart feature and sets the restart time to 180 seconds, overwriting the default value.

```
device# configure terminal
device(config)# rbridge-id 122
device(config-rbridge-id-122)# router bgp
device(config-bgp-router)# local-as 1
device(config-bgp-router)# neighbor 1000::1 remote-as 2
device(config-bgp-router)# address-family ipv6 unicast
device(config-bgp-ipv6u)# neighbor 1000::1 activate
device(config-bgp-ipv6u)# graceful-restart restart-time 180
```

The following example enables the graceful restart feature and sets the stale-routes time to 100 seconds, overwriting the default value.

```
device# configure terminal
device(config)# rbridge-id 122
device(config-rbridge-id-122)# router bgp
device(config-bgp-router)# local-as 1
device(config-bgp-router)# neighbor 1000::1 remote-as 2
device(config-bgp-router)# address-family ipv6 unicast
device(config-bgp-ipv6u)# neighbor 1000::1 activate
device(config-bgp-ipv6u)# graceful-restart stale-routes-time 100
```

Use the **clear ipv6 bgp neighbor** command with the **all** parameter for the changes to the graceful restart parameters to take effect immediately.

## Disabling the BGP AS\_PATH check function

A device can be configured so that the AS\_PATH check function for routes learned from a specific location is disabled, and routes that contain the recipient BGP speaker's AS number are not rejected.

1. Enter the **configure terminal** command to access global configuration mode.

```
device# configure terminal
```

2. Enter the **rbridge-id** command with an RBridge ID to enter RBridge ID configuration mode.

```
device(config)# rbridge-id 122
```

3. Enter the **router bgp** command to enable BGP routing.

```
device(config-rbridge-id-122)# router bgp
```

4. Enter the **address-family** command and specify the **ipv6** and **unicast** keywords to enter IPv6 address family configuration mode.

```
device(config-bgp-router)# address-family ipv6 unicast
```

5. Enter the **neighbor ipv6-address allows-in** command and specify a **number** to disable the BGP AS\_PATH check function, and specify the number of times that the AS path of a received route may contain the recipient BGP speaker's AS number and still be accepted.

```
device(config-bgp-ipv6u)# neighbor 2001:db8:e0ff:783a::4 allows-in 3
```

This example specifies that the AS path of a received route may contain the recipient BGP speaker's AS number three times and still be accepted.

```
device# configure terminal
device(config)# rbridge-id 122
device(config-rbridge-id-122)# router bgp
device(config-bgp-router)# address-family ipv6 unicast
device(config-bgp-ipv6u)# neighbor 2001:db8:e0ff:783a::4 allows-in 3
```

## Displaying BGP4+ statistics

Various **show ipv6 bgp** commands verify information about BGP4+ configurations.

1. Enter the **show ipv6 bgp summary** command.

```
device# show ipv6 bgp summary

BGP4 Summary
Router ID: 122.122.122.122   Local AS Number: 122
Confederation Identifier: not configured
Confederation Peers:
Cluster ID: 122
Maximum Number of IP ECMP Paths Supported for Load Sharing: 1
Number of Neighbors Configured: 20, UP: 15
Number of Routes Installed: 219, Uses 20805 bytes
Number of Routes Advertising to All Neighbors: 2802 (440 entries), Uses 26400
bytes
Number of Attribute Entries Installed: 31, Uses 2852 bytes
Neighbor Address  AS#      State      Time      Rt:Accepted  Filtered  Sent
ToSend
2001:54:54::54    122      ESTAB      0h19m58s  0           0         146      0
2001:55:55::55    122      ESTAB      0h19m54s  1           0         146      0
2001:122:53::53   6000     ESTAB      0h22m39s  50          0         147      0
2001:122:534:2::534
                    534      ESTAB      0h 3m20s  10          0         137      0
2001:125:125::125 122      CONN      0h11m33s  0           0         0        -
```

This example output gives summarized BGP4+ information.

2. Enter the **show ipv6 bgp attribute-entries** command.

```
device# show ipv6 bgp attribute-entries

Total number of BGP Attribute Entries: 2
```

```

1      Next Hop  : 2001::1                                MED      :
1      Origin:IGP
      Originator:0.0.0.0                                Cluster List:None
      Aggregator:AS Number :0                          Router-ID:0.0.0.0      Atomic:None
      Local Pref:1                                       Communities:Internet
      AS Path   : (length 0)
      Address: 0x1205c75c Hash:268 (0x01000000)
      Links: 0x00000000, 0x00000000
      Reference Counts: 2:0:0, Magic: 1
2      Next Hop  : ::                                     MED      :
1      Origin:IGP
      Originator:0.0.0.0                                Cluster List:None
      Aggregator:AS Number :0                          Router-ID:0.0.0.0      Atomic:None
      Local Pref:100                                    Communities:Internet
      AS Path   : (length 0)
      AsPathLen: 0 AsNum: 0, SegmentNum: 0, Neighboring As: 0, Source As 0
      Address: 0x1205c7cc Hash:365 (0x01000000)
      Links: 0x00000000, 0x00000000
      Reference Counts: 1:0:1, Magic: 2

```

This example shows information about two route-attribute entries that are stored in device memory.

3. Enter the **show ipv6 bgp peer-group** command.

```

device# show ipv6 bgp peer-group

1 BGP peer-group is P1, Remote AS: 1
Address family : IPV4 Unicast
activate
Address family : IPV4 Multicast
no activate
Address family : IPV6 Unicast
activate
Address family : IPV6 Multicast
no activate
Address family : VPNV4 Unicast
no activate
Address family : L2VPN VPLS
no activate
Members:
IP Address: 2001::1
IP Address: 2001:0:0:1::1
IP Address: 10.1.0.1

```

This example shows output for a peer group called "P1".

4. Enter the **show ipv6 bgp routes** command.

```

device# show ipv6 bgp routes
Total number of BGP Routes: 6
Status A:AGGREGATE B:BEST b:NOT-INSTALLED-BEST C:CONFED E:EBGP D:DAMPED
E:EBGP H:HISTORY I:IBGP L:LOCAL M:MULTIPATH m:NOT-INSTALLED-MULTIPATH
S:SUPPRESSED F:FILTERED s:STALE
Prefix      Next Hop      MED      LocPrf      Weight Status
1      57:7000:3:22:abc:1::/128  2001:700:122:57::57
      AS_PATH: 7000 322
2      57:7000:3:22:abc:1:0:2/128  2001:700:122:57::57
      AS_PATH: 7000 322
3      57:7000:3:22:abc:1:0:4/128  2001:700:122:57::57
      AS_PATH: 7000 322
4      57:7000:3:22:abc:1:0:6/128  2001:700:122:57::57
      AS_PATH: 7000 322
5      57:7000:3:22:abc:1:0:8/128  2001:700:122:57::57
      AS_PATH: 7000 322
6      57:7000:3:22:abc:1:0:a/128  2001:700:122:57::57
      AS_PATH: 7000 322

```

This example shows general BGP4+ route information.

5. Enter the **show ipv6 bgp routes** command, using the **summary** keyword.

```

device# show ipv6 bgp routes summary

Total number of BGP routes (NLRIs) Installed      : 558
Distinct BGP destination networks                 : 428
Filtered bgp routes for soft reconfig              : 0

```

```

Routes originated by this router           : 19
Routes selected as BEST routes            : 417
BEST routes not installed in IP forwarding table : 0
Unreachable routes (no IGP route for NEXTHOP) : 22
IBGP routes selected as best routes       : 102
EBGP routes selected as best routes       : 296

```

This example shows summarized BGP4+ route information.

6. Enter the **show ipv6 bgp routes** command, using the **local** keyword.

```

device# show ipv6 bgp routes local
Status A:AGGREGATE B:BEST b:NOT-INSTALLED-BEST C:CONFED EBGP D:DAMPED
       E:EBGP H:HISTORY I:IBGP L:LOCAL M:MULTIPATH m:NOT-INSTALLED-MULTIPATH
       S:SUPPRESSED F:FILTERED s:STALE
Prefix      Next Hop      MED      LocPrf      Weight Status
-----
1  131::1/128      ::          1         100         32768  BL
   AS_PATH:
2  2001::107:6133:2007:1::/112  2001:2007::201
                                   107         100         32768  BL
   AS_PATH:
3  2001::107:6133:2007:2::/112  2001:2007::202
                                   107         100         32768  BL
   AS_PATH:
4  2001::107:6133:2007:3::/112  2001:2007::203
                                   107         100         32768  BL
   AS_PATH:
5  2001::107:6133:2007:4::/112  2001:2007::204
                                   107         100         32768  BL
   AS_PATH:
6  2001::107:6133:2007:5::/112  2001:2007::205
                                   107         100         32768  BL
   AS_PATH:
7  2001::107:6133:2007:6::/112  2001:2007::206
                                   107         100         32768  BL

```

This example shows information about local routes.

## Displaying BGP4+ neighbor statistics

Various **show ipv6 bgp neighbor** commands verify information about BGP4+ neighbor configurations.

1. Enter the **show ipv6 bgp neighbors** command.

```

device# show ipv6 bgp neighbors
Total number of BGP Neighbors: 2
IP Address: 2001::1, AS: 2 (EBGP), RouterID: 192.0.0.1, VRF: default-vrf
State: ESTABLISHED, Time: 0h0m27s, KeepAliveTime: 30, HoldTime: 90
KeepAliveTimer Expire in 3 seconds, HoldTimer Expire in 62 seconds
Minimal Route Advertisement Interval: 0 seconds
Messages: Open Update KeepAlive Notification Refresh-Req
Sent : 5 2 7 3 0
Received: 5 4 11 1 0
Last Update Time: NLRI Withdraw NLRI Withdraw
Tx: 0h0m23s --- Rx: 0h0m27s ---
Last Connection Reset Reason:Rcv Notification
Notification Sent: Cease/CEASE Message
Notification Received: Cease/CEASE Message
Neighbor NLRI Negotiation:
Peer Negotiated IPV6 unicast capability
Peer configured for IPV6 unicast Routes
Neighbor ipv6 MPLS Label Capability Negotiation:
Neighbor AS4 Capability Negotiation:
Outbound Policy Group:
ID: 2, Use Count: 2
Update running at: 0.0.0.0/0
Last update time was 104 sec ago
Byte Sent: 158, Received: 0
Local host: 2001::2, Local Port: 8168
Remote host: 2001::1, Remote Port: 179

```

This example output gives summarized information about BGP4+ neighbors.

2. Enter the **show ipv6 bgp neighbors advertised-routes** command.

```

device# show ipv6 bgp neighbor 2001::db8::10 advertised-routes
There are 7 routes advertised to neighbor 2001::db8::10
Status A:AGGREGATE B:BEST b:NOT-INSTALLED-BEST E:EBGP I:IBGP L:LOCAL

```

	Prefix	Next Hop	MED	LocPrf	Weight	Status
1	fd80:122:122:122:101:101:0:122/128	2001:122:122::122	0	100	101	BL
	AS_PATH:					
2	fd80:122:122:122:103:103:0:122/128	2001:122:122::122	0	100	103	BL
	AS_PATH:					
3	fd80:122:122:122:105:105:0:122/128	2001:122:122::122	0	100	105	BL
	AS_PATH:					
4	131::1/128	2001:122:122::122	1	100	32768	BL
	AS_PATH:					
5	2001:122:131:125:131:1::/96	2001:3002::732	1	100	0	BE
	AS_PATH: 65530					
6	2001:abcd:1234:1234:1:2:1:0/112	2001:3002::733	1	100	0	BE
	AS_PATH: 65530					
7	2001:abcd:1234:1234:1:2:2:0/112	2001:3002::733	1	100	0	BE

This example shows information about all the routes the BGP4+ networking device advertised to the neighbor.

3. Enter the **show ipv6 bgp neighbors last-packet-with-error** command.

```
device# show ipv6 bgp neighbor last-packet-with-error
Total number of BGP Neighbors: 67
1 IP Address: 153::2
Last error:
BGP4: 0 bytes hex dump of packet that contains error
```

This example shows information about the last packet that contained an error from any of a device's neighbors.

4. Enter the **show ipv6 bgp neighbors received-routes** command.

```
device# show ipv6 bgp neighbor 2001:db8::10 received-routes
There are 4 received routes from neighbor 2001:db8::10
Searching for matching routes, use ^C to quit...
Status A:AGGREGATE B:BEST b:NOT-INSTALLED-BEST C:CONFED_EBGP D:DAMPED
E:EBGP H:HISTORY I:IBGP L:LOCAL M:MULTIPATH S:SUPPRESSED F:FILTERED
Prefix Next Hop Metric LocPrf Weight Status
1 2001:db8:2002::/64 2001:db8::10 0 100 0 BE
AS_PATH: 400
2 2001:db8:2003::/64 2001:db8::10 1 100 0 BE
AS_PATH: 400
3 2001:db8:2004::/64 2001:db8::10 1 100 0 BE
AS_PATH: 400
4 2001:db8:2005::/64 2001:db8::10 1 100 0 BE
AS_PATH: 400
```

This example lists all route information received in route updates from BGP4+ neighbors of the device since the soft-reconfiguration feature was enabled.

5. Enter the **show ipv6 bgp neighbors rib-out-routes** command.

```
device# show ipv6 bgp neighbors 2001:db8::10 rib-out-routes
There are 150 RIB out routes for neighbor 2001:db8::10
Status A:AGGREGATE B:BEST b:NOT-INSTALLED-BEST E:EBGP I:IBGP L:LOCAL
Prefix Next Hop MED LocPrf Weight Status
1 fd80:122:122:122:101:101:0:122/128 :: 0 100 101 BL
AS_PATH:
2 fd80:122:122:122:103:103:0:122/128 :: 0 100 103 BL
AS_PATH:
3 fd80:122:122:122:105:105:0:122/128 :: 0 100 105 BL
AS_PATH:
4 131::1/128 :: 1 100 32768 BL
AS_PATH:
5 2001:122:131:125:131:1::/96 2001:3002::732 1 100 0 BE
AS_PATH: 65530
6 2001:abcd:1234:1234:1:2:1:0/112 2001:3002::733 1 100 0 BE
AS_PATH: 65530
7 2001:abcd:1234:1234:1:2:2:0/112 2001:3002::733 1 100 0 BE
AS_PATH: 65530
```

This example shows information about BGP4+ outbound RIB routes.

## Clearing BGP4+ dampened paths

BGP4+ suppressed routes can be reactivated using a CLI command.

The **show ipv6 bgp dampened-paths** command is entered to verify that there are BGP4+ dampened routes. The **clear ipv6 bgp dampening** command is entered to reactivate all suppressed BGP4+ routes. The **show ipv6 bgp dampened-paths** command is re-entered to verify that the suppressed BGP4+ routes have been reactivated.

1. Enter the **exit** command until you return to Privileged EXEC mode.

```
device(config)# exit
```

2. Enter the **show ipv6 bgp dampened-paths** command to display all BGP4+ dampened routes.

```
device# show ipv6 bgp dampened-paths
```

Path	Network	From		Flaps	Since	Reuse
*d 1002 1000	2001:db8:8::/45	2001:db8:1::1	1	0 :1 :14	0 :2 :20	100
*d 1002 1000	2001:db8:1::/48	2001:db8:1::1	1	0 :1 :14	0 :2 :20	100
*d 1002 1000	2001:db8:4::/46	2001:db8:1::1	1	0 :1 :14	0 :2 :20	100
*d 1002 1000	2001:db8:2::/47	2001:db8:1::1	1	0 :1 :14	0 :2 :20	100
*d 100 1002 1000	2001:db8:0:8000::/49	2001:db8:1::1	1	0 :1 :14	0 :2 :20	
*d	2001:db8:17::/64	2001:db8:1::1	1	0 :1 :18	0 :2 :20	100

3. Enter the **clear ipv6 bgp dampening** command to reactivate all suppressed BGP4+ routes.

```
device# clear ipv6 bgp dampening
```

4. Enter the **show ipv6 bgp dampened-paths** command to verify that there are no BGP4+ dampened routes.

```
device# show ipv6 bgp dampened-paths
device#
```

The following example reactivates all suppressed BGP4+ routes and verifies that there are no suppressed routes.

```
device(config-bgp-router)# exit
device(config-rbridge-id-122)# exit
device(config)# exit
device# show ipv6 bgp dampened-paths
device# clear ipv6 bgp dampening
device# show ipv6 bgp dampened-paths
```

# VRRP

---

- VRRPv2 Overview..... 152
- Enabling a master VRRP device..... 157
- Enabling a backup VRRP device..... 158
- Enabling a VRRP-E device..... 159
- VRRP multigroup clusters..... 160
- Track ports and track priority with VRRP and VRRP-E..... 163
- VRRP backup preemption..... 165
- VRRP-E load-balancing using short-path forwarding..... 166
- Clearing VRRPv2 statistics..... 169
- Displaying VRRPv2 information..... 170

## VRRPv2 Overview

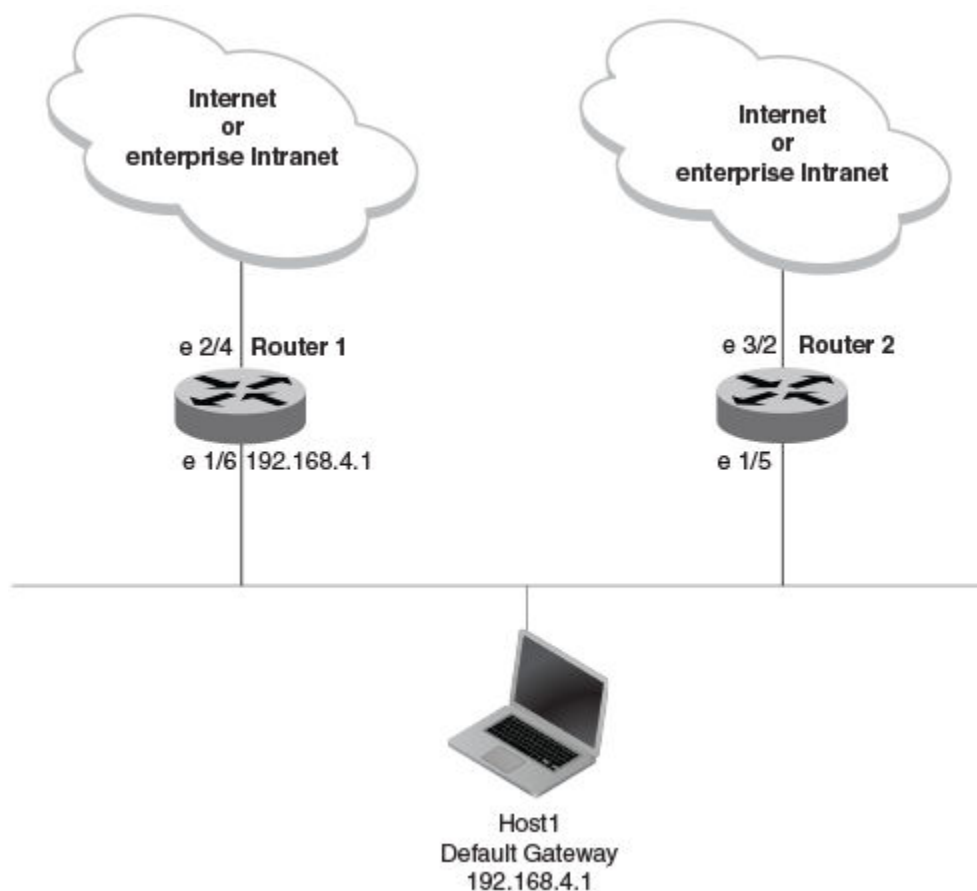
Virtual Router Redundancy Protocol (VRRP) is an election protocol that provides redundancy to routers within a Local Area Network (LAN).

VRRP was designed to eliminate a single point of failure in a static default-route environment by dynamically assigning virtual IP routers to participating hosts. A virtual router is a collection of physical routers where the interfaces must belong to the same IP subnet. A virtual router ID is assigned to each virtual router, but there is no restriction against reusing a virtual router ID (VRID) with a different address mapping on different LANs

Before examining more details about how VRRP works, it is useful to see why VRRP was developed to solve the single point of failure issue.

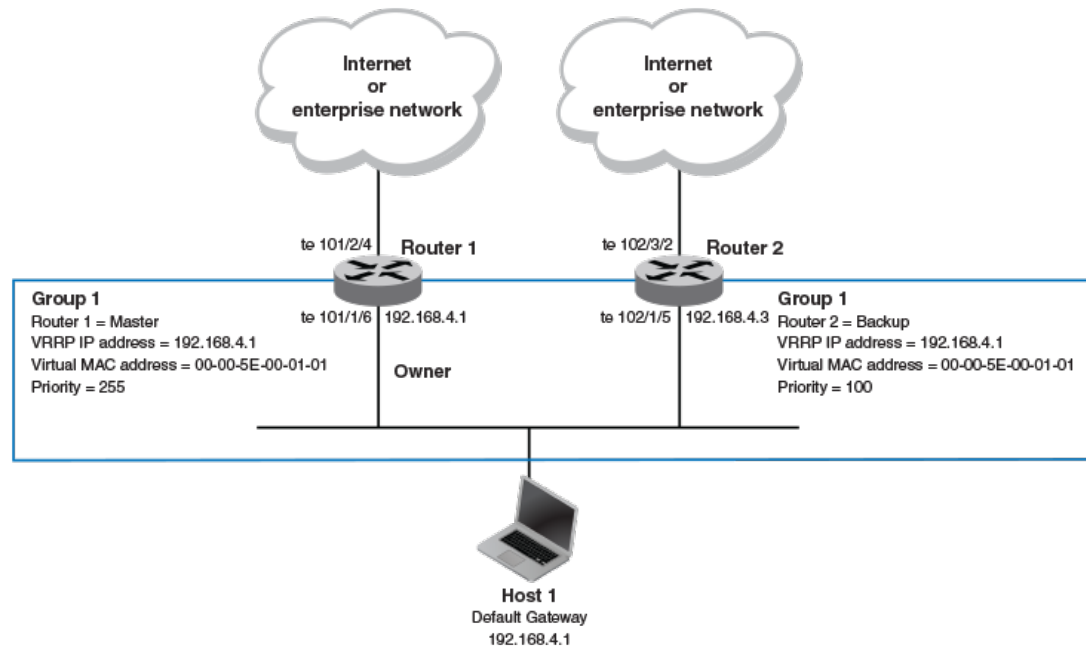


**FIGURE 16** Router 1 is the Host1 default gateway but is a single point of failure



To connect to the Internet or an internal intranet Host1, in the diagram above, uses the IP address of 192.168.4.1 on Router1 as its default gateway. If this interface goes down, Host1 is cut off from the rest of the network. Router1 is a single point of failure for Host1 to access other networks. In small networks, the administrative burden of configuring Router2 as the new default gateway is not an issue, but in larger networks reconfiguring default gateways is impractical. Configuring a VRRP virtual router on Router1 and Router2 to provide a redundant path for the hosts. VRRP allows you to provide alternate router paths for a host without changing the IP address or MAC address by which the host knows its gateway.

To illustrate how VRRP works, the figure below shows the same network but a VRRP virtual router is configured on the two physical routers, Router 1 and Router 2. This virtual router provides redundant network access for Host1. If Router1 were to fail, Router2 would provide the default gateway out of the subnet.

**FIGURE 17** Devices configured as VRRP virtual routers for redundant network access for Host1

The box represents a VRRP virtual router. When you configure a virtual router, one of the configuration parameters is a group number (also known as a virtual router ID), which can be a number from 1 through 255. The virtual router is identified with a group and within the VRRP group, there is one physical device that forwards packets for the virtual router and this is called a master VRRP device. The VRRP master device may be a Layer 3 switch or a router.

In VRRP, one of the physical IP addresses is configured as the IP address of the virtual router, the virtual IP address. The device on which the virtual IP address is assigned becomes the VRRP owner and this device responds to packets addressed to any of the IP addresses in the virtual router group. The owner device becomes the master VRRP device by default and is assigned the highest priority. Backup devices are configured as members of the virtual router group and, in if the master device goes offline, one fo the backup devices assumes the role of the master device.

**NOTE**

VRRP operation is independent of BGP4 and OSPF protocols. Their operation is unaffected when VRRP is enabled on the same interface as BGP4 or OSPF.

## VRRP Terminology

Defines key terms that you must understand before implementing VRRP in your network.

The following are common VRRP-related terms. They are in logical order, not alphabetic order:

### *Virtual router*

A collection of physical routers that can use the VRRP protocol to provide redundancy to routers within a LAN.

***Virtual router group***

A group of physical routers that are assigned to the same virtual router.

***Virtual router address***

The virtual router IP address must belong to the same subnet as a real IP address configured on the VRRP interface, and can be the same as a real IP addresses configured on the VRRP interface. The virtual router whose virtual IP address is the same as a real IP address is the IP address owner and the default master.

***Owner***

The owner is the physical router whose real interface IP address is the IP address that you assign to the virtual router. The owner responds to packets addressed to any of the IP addresses in the corresponding virtual router. The owner, by default, is the master and has the highest priority (255).

***Master***

The physical router that responds to packets addressed to any of the IP addresses in the corresponding virtual router. For VRRP, if the physical router whose real interface IP address is the IP address of the virtual router, then this physical router is always the master.

***Backup***

Routers that belong to a virtual router, but are not the master. Then, if the master becomes unavailable, the backup router with the highest priority (a configurable value) becomes the new master. By default, routers are given a priority of 100.

**VRRP-Ev2 overview**

VRRP extended (VRRP-E) is an extended version of the VRRP protocol. VRRP-E is designed to avoid the limitations in the standards-based VRRP.

To create VRRP-E, Brocade has implemented the following differences from the RFC 3768 that describes VRRPv2 to provide extended functionality and ease of configuration:

- VRRP-E does not include the concept of an owner device and a master VRRP-E is determined by the priority configured on the device.
- While the VRRP-E virtual router IP address must belong in the same subnet as a real IP address assigned to a physical interface of the device on which VRRP-E is configured, it must not be the same as any of the actual IP addresses on any interface.
- Configuring VRRP-E uses the same task steps for all devices; no differences between master and backup device configuration. The device configured with the highest priority assumes the master role.

VRRP-E is not supported on non-Brocade devices and does not interoperate with VRRP sessions on Brocade devices.

**VRRPv2 limitations on Brocade VDX devices**

The implementation of VRRPv2 varies across the VDX products.

Virtual routers must be configured in a Virtual Cluster Switching (VCS) environment.

Only IPv4 support is provided in VRRPv2. VRRPv3 supports both IPv4 and IPv6.

Supported ports:

- For VRRP—fortygigabitethernet, tengigabitethernet, gigabitethernet, and ve
- For VRRP-E—ve ports only

System Resource	VDX 87xx	VDX 6740, 6740T, 6740T-1GT, 6940-36Q
Max # of VRRP and VRRP-E sessions	1024	255

The maximum number of virtual IP addresses per virtual router session is 16 for VRRP, and one for VRRP-E.

## VRRP hold timer

Hold timer support delays the preemption of a master VRRP device by a high-priority backup device.

A hold timer is used when a VRRP-enabled device that was previously a master device failed, but is now back up. This restored device now has a higher priority than the current VRRP master device and VRRP normally triggers an immediate switchover. In this situation, it is possible that not all the software components on the backup device have converged yet. The hold timer can enforce a waiting period before the higher-priority backup device assumes the role of master VRRP device again. The timer must be set to a number greater than 0 seconds for this functionality to take effect.

Hold timer functionality is supported in both version 2 and version 3 of VRRP and VRRP-E.

## VRRP interval timers

Timers for the intervals between hello messages between devices running VRRP can be configured.

### *hello intervals*

Hello messages are sent from the master VRRP device to the backup devices. The purpose of the hello messages is to that the master device is still online. If the backup devices stop receiving the hello messages for a period of time, as defined by the dead interval, the backup devices assume the master device is offline. When the master device is offline, the backup device with the highest priority assumes the role of the master device.

### *backup hello message state and interval*

By default, backup devices do not send hello messages to advertise themselves to the master device. Hello messages from backup devices can be activated and the messages are sent at 60 second intervals, by default. The interval between the backup hello messages can be modified.

## ARP and VRRP control packets

Control packets for ARP and VRRP are handled differently by VRRP and VRRP-E.

### *Source MAC addresses in VRRP control packets*

- VRRP—The virtual MAC address is the source.
- VRRP-E—The physical MAC address is the source.

**VRRP control packets**

- VRRP—control packets are IP protocol type 112 (reserved for VRRP), and are sent to VRRP multicast address 224.0.0.18.
- VRRP-E—control packets are UDP packets destined to port 8888, and are sent to the all-router multicast address 224.0.0.2.

**Gratuitous ARP**

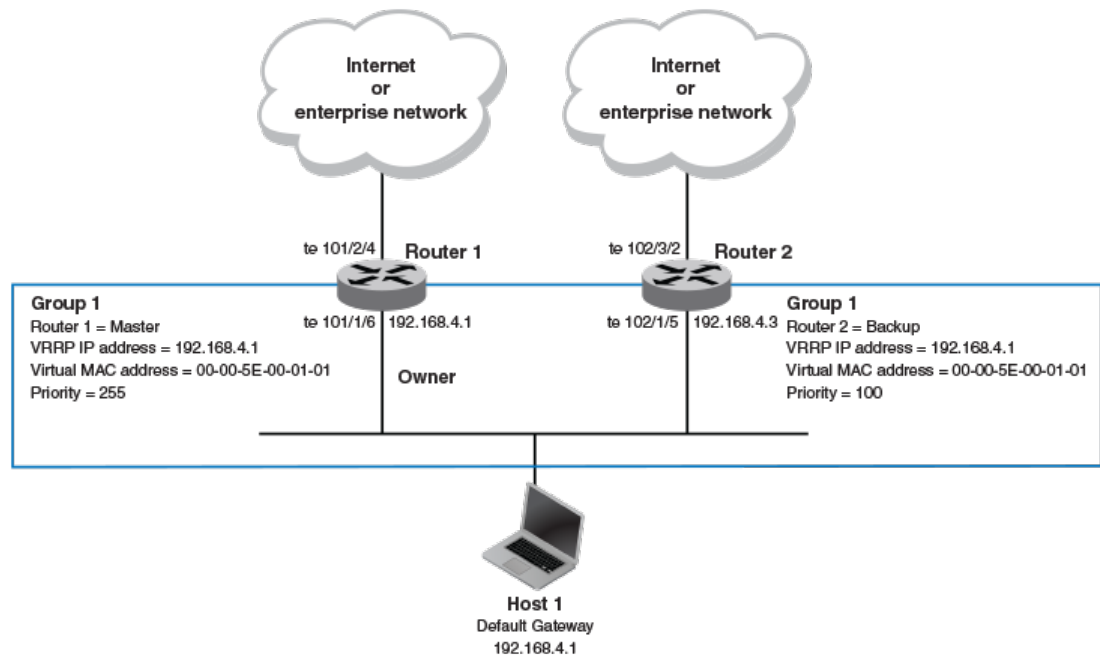
When a VRRP device (either master or backup) sends an ARP request or a reply packet, the MAC address of the sender is the MAC address of the router interface. One exception is if the owner sends an ARP request or a reply packet, in which case the MAC address of the sender is the virtual MAC address. Only the master answers an ARP request for the virtual router IP address. Any backup router that receives this request forwards the request to the master.

- VRRP—A control message is sent only once when the VRRP device assumes the role of the master VRRP device.
- VRRP-E—A control message is sent every two seconds by the VRRP-E master device because VRRP-E control packets do not use the virtual MAC address.

## Enabling a master VRRP device

This task is performed on the device that is designated as the master VRRP device. For example, Router 1 is the master VRRP device in the diagram below.

**FIGURE 18** Basic VRRP topology



1. On the device designated as the master VRRP device, from privileged EXEC mode, enter configuration mode by issuing the **configure** command.

```
device# configure
```

2. Enter the **rbridge-id** command, using the RBridge ID (which has an asterisk next to it when you run a **do show vcs** command).

```
device(config)# rbridge-id 101
```

3. Globally enable the VRRP protocols.

```
device(config-rbridge-id-101)# protocol vrrp
```

4. Configure the tengigabitethernet interface link for Router 1.

```
device(config-rbridge-id-101)# interface tengigabitethernet 101/1/6
```

5. Configure the IP address of the interface.

```
device(conf-if-te-101/1/6)# ip address 192.168.4.1/24
```

6. Assign Router 1 to a group called Group 1.

```
device(conf-if-te-101/1/6)# vrrp-group 1
```

---

**NOTE**

You can assign a group number in the range of 1 through 255.

---

7. Assign a virtual router IP address.

```
device(config-vrrp-group-1)# virtual-ip 192.168.4.1
```

---

**NOTE**

For VRRP, the physical router whose IP address is the same as the virtual router group IP address becomes the owner and master.

---

The following example configures a VRRP master device.

```
device# configure
device(config)# rbridge-id 101
device(config-rbridge-id-101)# protocol vrrp
device(config-rbridge-id-101)# interface tengigabitethernet 101/1/6
device(conf-if-te-101/1/6)# ip address 192.168.4.1/24
device(conf-if-te-101/1/6)# vrrp-group 1
device(config-vrrp-group-1)# virtual-ip 192.168.4.1
```

## Enabling a backup VRRP device

This task is performed on a device that is to be designated as a backup VRRP device. For example, Router 2 in [Figure 18](#) on page 157 is assigned as a backup device. Repeat this task for all devices that are to be designated as backup devices.

1. On the device designated as a backup VRRP device, from privileged EXEC mode, enter configuration mode by issuing the **configure** command.

```
device# configure
```

2. Enter the **rbridge-id** command, using the RBridge ID (which has an asterisk next to it when you run a **do show vcs** command).

```
device(config)# rbridge-id 102
```

3. Globally enable the VRRP protocols.

```
device(config-rbridge-id-102)# protocol vrrp
```

4. Configure the tengigabitethernet interface for Router 2.

```
device(config-rbridge-id-102)# interface tengigabitethernet 102/1/5
```

5. Configure the IP address of interface:

```
device(conf-if-te-102/1/5)# ip address 192.168.4.3/24
```

---

#### NOTE

This router will become the backup router to Router 1.

---

6. Assign Router 2 to the same VRRP group as Router 1.

```
device(conf-if-te-102/1/5)# vrrp-group 1
```

7. To assign Group 1 a virtual IP address, use the same virtual IP addresses you used for Router 1.

```
device(config-vrrp-group-1)# virtual-ip 192.168.4.1
```

The following example configures a backup VRRP device.

```
device# configure
device(config)# rbridge-id 101
device(config-rbridge-id-101)# protocol vrrp
device(config-rbridge-id-101)# interface tengigabitethernet 102/1/5
device(conf-if-te-101/1/5)# ip address 192.168.4.3/24
device(conf-if-te-101/1/5)# vrrp-group 1
device(config-vrrp-group-1)# virtual-ip 192.168.4.1
```

## Enabling a VRRP-E device

This task is performed on all devices that are designated as VRRP extended (VRRP-E) devices. While VRRP-E does not have owner devices, there is still a master device and backup devices with the master device determined by the device with the highest priority.

1. From privileged EXEC mode, enter configuration mode by issuing the **configure** command.

```
device# configure
```

2. Enter the **rbridge-id** command, using the RBridge ID (which has an asterisk next to it when you run a **do show vcs** command).

```
device(config)# rbridge-id 101
```

3. Globally enable the VRRP-E protocol.

- Enter the **protocol vrrp** command on Brocade VDX 8770 devices.
- Enter the **protocol vrrp-extended** command on Brocade VDX 6740 devices.

```
device(config-rbridge-id-101)# protocol vrrp
```

or

```
device(config-rbridge-id-101)# protocol vrrp-extended
```

4. Configure the virtual ethernet (ve) interface link for the VRRP-E device.

```
device(config-rbridge-id-101)# interface ve 10
```

Only ve interfaces are supported by VRRP-E.

5. Configure the IP address of the interface.

```
device(conf-ve-10)# ip address 192.168.4.1/24
```

6. Enter the **priority** command with a number to assign a priority.

```
device(conf-ve-10)# priority 110
```

The VRRP-E device with the highest priority number becomes the master device.

7. Assign the device to a group called Group 1.

```
device(conf-ve-10)# vrrp-extended-group 1
```

---

#### NOTE

You can assign a group number in the range of 1 through 255.

---

8. Assign a virtual router IP address.

```
device(config-vrrp-group-1)# virtual-ip 192.168.4.100
```

---

#### NOTE

For VRRP-E, the virtual router group IP address must not be the same as a real IP address configured on the interface.

---

#### Router 1

#### Router 2

The following example configures a master VRRP-E device for group 1.

```
device# configure
device(config)# rbridge-id 101
device(config-rbridge-id-101)# protocol vrrp-extended
device(config-rbridge-id-101)# interface ve 10
device(conf-ve-10)# ip address 192.168.4.1/24
device(conf-ve-10)# priority 110
device(conf-ve-10)# vrrp-extended-group 1
device(config-vrrp-group-1)# virtual-ip 192.168.4.100
```

The following example configures a backup VRRP-E device for group 1. In the first configuration of VRRP-E for Router 1 the priority is set to 110, higher than the priority for Router 2 at 80. Router 1 assumes the role of the master VRRP-E device.

```
device# configure
device(config)# rbridge-id 101
device(config-rbridge-id-101)# protocol vrrp-extended
device(config-rbridge-id-101)# interface ve 10
device(conf-ve-10)# ip address 192.168.4.3/24
device(conf-ve-10)# priority 80
device(conf-ve-10)# vrrp-extended-group 1
device(config-vrrp-group-1)# virtual-ip 192.168.4.100
```

## VRRP multigroup clusters

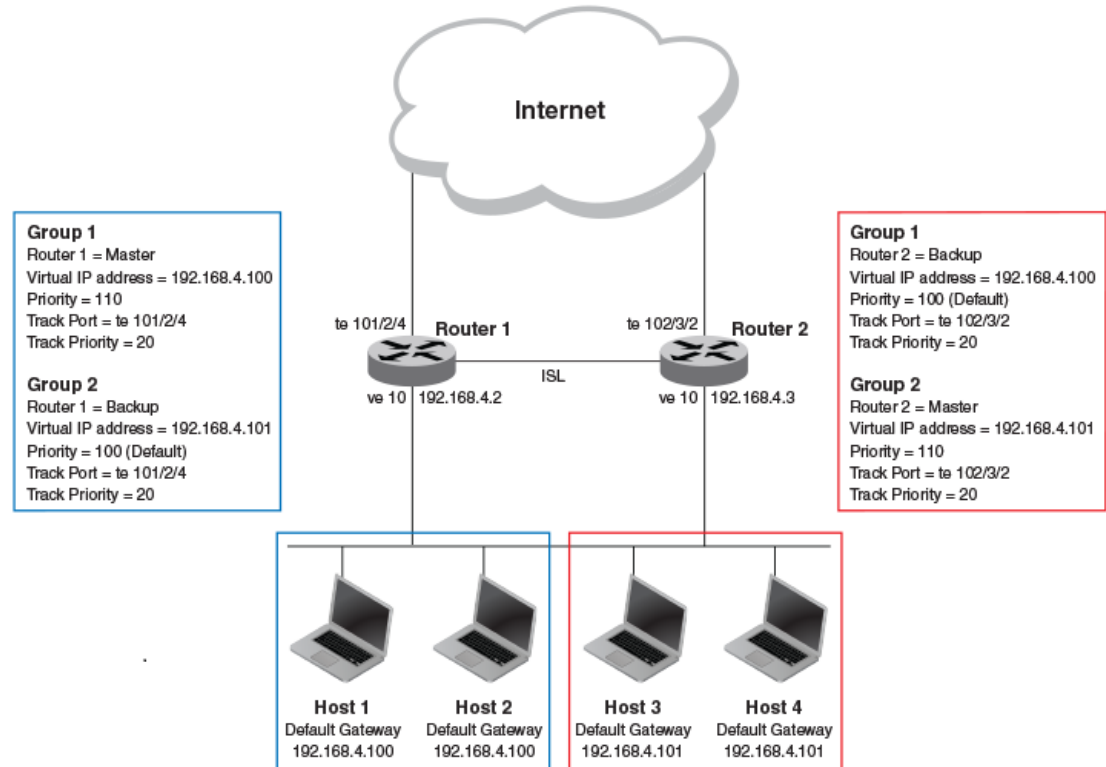
Multigroup clusters allow redundancy for host devices and are supported by both VRRP and VRRP-E version 2 and version 3.

The figure below depicts a commonly employed virtual router topology. This topology introduces redundancy by configuring two virtual router groups — the first group has Router 1 as the master and



Router 2 as the backup, and the second group has Router 2 as the master and Router 1 as the backup. This type of configuration is sometimes called *Multigroup VRRP*.

**FIGURE 19** Two routers configured for dual redundant network access for the host



In this example, Router 1 and Router 2 use VRRP-E to load share as well as provide redundancy to the hosts. The load sharing is accomplished by creating two VRRP-E groups, each with its own virtual IP addresses. Half of the clients point to Group 1's virtual IP address as their default gateway, and the other half point to Group 2's virtual IP address as their default gateway. This enables some of the outbound Internet traffic to go through Router 1 and the rest to go through Router 2.

Router 1 is the master for Group 1 (master priority = 110) and Router 2 is the backup for Group 1 (backup priority = 100). Router 1 and Router 2 both track the uplinks to the Internet. If an uplink failure occurs on Router 1, its backup priority is decremented by 20 (track-port priority = 20) to 90, so that all traffic destined to the Internet is sent through Router 2 instead.

Similarly, Router 2 is the master for Group 2 (master priority = 110) and Router 1 is the backup for Group 2 (backup priority = 100). Router 1 and Router 2 are both tracking the uplinks to the Internet. If an uplink failure occurs on Router 2, its backup priority is decremented by 20 (track-port priority = 20) to 90, so that all traffic destined to the Internet is sent through Router 1 instead.

## Configuring multigroup VRRP routing

Configuring VRRP multigroup clusters provides access redundancy to the host devices.

To implement the configuration of VRRP multigroup clusters as shown in [Figure 19](#) on page 161, configure one VRRP-E router to act as a master in the first virtual router group and as a backup in the second virtual group. Then configure the second VRRP-E router to act as a backup in the first virtual group and as a master in the second virtual group.

This example is for VRRP-E. There are minor syntax differences for VRRP, which you can determine by consulting the appropriate command reference. This example is for a VCS fabric cluster mode environment. The task steps below are configured on Router 1 and there are three configuration examples at the end of the task showing how to configure Router 1 as a backup and Router 2 as a master and a backup VRRP-E device.

1. Enter the **rbridge-id** command in global configuration mode, using the RBridge ID (which has an asterisk next to it when you run a **do show vcs** command).

```
device(config)# rbridge-id 101
```

2. Configure the VRRP-E protocol globally.

```
device(config-rbridge-id-101)# protocol vrrp-extended
```

3. Configure the virtual Ethernet (ve) interface link for Router 1.

```
device(config-rbridge-id-101)# interface ve 10
```

---

#### NOTE

You first would need to create **interface vlan 10** in global configuration mode.

---

4. Configure the IP address of the ve link for Router 1.

```
device(conf-Ve-10)# ip address 192.168.4.2/24
```

5. To assign Router 1 to a VRRP-E group called Group 1, enter the command:

```
device(conf-Ve-10)# vrrp-extended-group 1
```

6. Configure the tengigabitethernet port 101/2/4 as the tracking port for the interface ve 10, with a track priority of 20.

```
device(config-vrrp-extended-group-1)# track te 101/2/4 priority 20
```

7. Configure an IP address for the virtual router.

```
device(config-vrrp-extended-group-1)# virtual-ip 192.168.4.100
```

---

#### NOTE

(For VRRP-E only) The address you enter with the **virtual-ip** command cannot be the same as a real IP address configured on the interface.

---

8. To configure Router 1 as the master, set the priority to a value higher than the default (which is 100).

```
device(config-vrrp-group-1)# priority 110
```

#### Router 1 as backup

The following example configures Router 1 as a backup device for VRRP-E group 2 by configuring a priority (100) that is a lower value than the priority set for Router 2 in VRRP-E group 2.

```
device(config)# rbridge-id 101
device(config-rbridge-id-101)# int ve 10
device(conf-Ve-10)# ip address 192.168.4.2/24
device(conf-Ve-10)# vrrp-extended-group 2
device(config-vrrp-extended-group-1)# track te 101/2/4 priority 20
device(config-vrrp-extended-group-1)# virtual-ip 192.168.4.101
device(config-vrrp-group-1)# priority 100
```

**Router 2 as master**

The following example configures Router 2 as the master device for VRRP-E group 2 by configuring a priority (110) that is a higher value than the priority set for Router 1 in VRRP-E group 2.

```
device(config)# rbridge-id 102
device(config-rbridge-id-102)# protocol vrrp
device(config-rbridge-id-102)# int ve 10
device(conf-Ve-10)# ip address 192.168.4.3/24
device(conf-Ve-10)# vrrp-extended-group 2
device(config-vrrp-extended-group-2)# track te 101/2/4 priority 20
device(config-vrrp-extended-group-2)# virtual-ip 192.168.4.101
device(config-vrrp-group-1)# priority 110
```

**Router 2 as backup**

The following example configures Router 2 as a backup device for VRRP-E group 1 by configuring a priority (100) that is a lower value than the priority set for Router 1 in VRRP-E group 1.

```
device(config)# rbridge-id 102
device(config-rbridge-id-102)# protocol vrrp
device(config-rbridge-id-102)# int ve 10
device(conf-Ve-10)# ip address 192.168.4.3/24
device(conf-Ve-10)# vrrp-extended-group 1
device(config-vrrp-extended-group-1)# track te 101/2/4 priority 20
device(config-vrrp-extended-group-1)# virtual-ip 192.168.4.100
device(config-vrrp-group-1)# priority 100
```

## Track ports and track priority with VRRP and VRRP-E

Port tracking allows interfaces not configured for VRRP or VRRP-E to be monitored for link state changes that can result in dynamic changes to the VRRP device priority.

A tracked port allows you to monitor the state of the interfaces on the other end of a route path. A tracked interface also allows the virtual router to lower its priority if the exit path interface goes down, allowing another virtual router in the same VRRP (or VRRP-E) group to take over. When a tracked interface returns to an up state, the configured track priority is added to the current virtual router priority value. The following conditions and limitations exist for tracked ports:

- Track priorities must be lower than VRRP or VRRP-E priorities.
- The dynamic change of router priority can trigger master device switchover if preemption is enabled. However, if the router is an owner, the master device switchover will not occur.
- The maximum number of interfaces that can be tracked for a virtual router is 16.
- Port tracking is allowed for physical interfaces and port-channels.

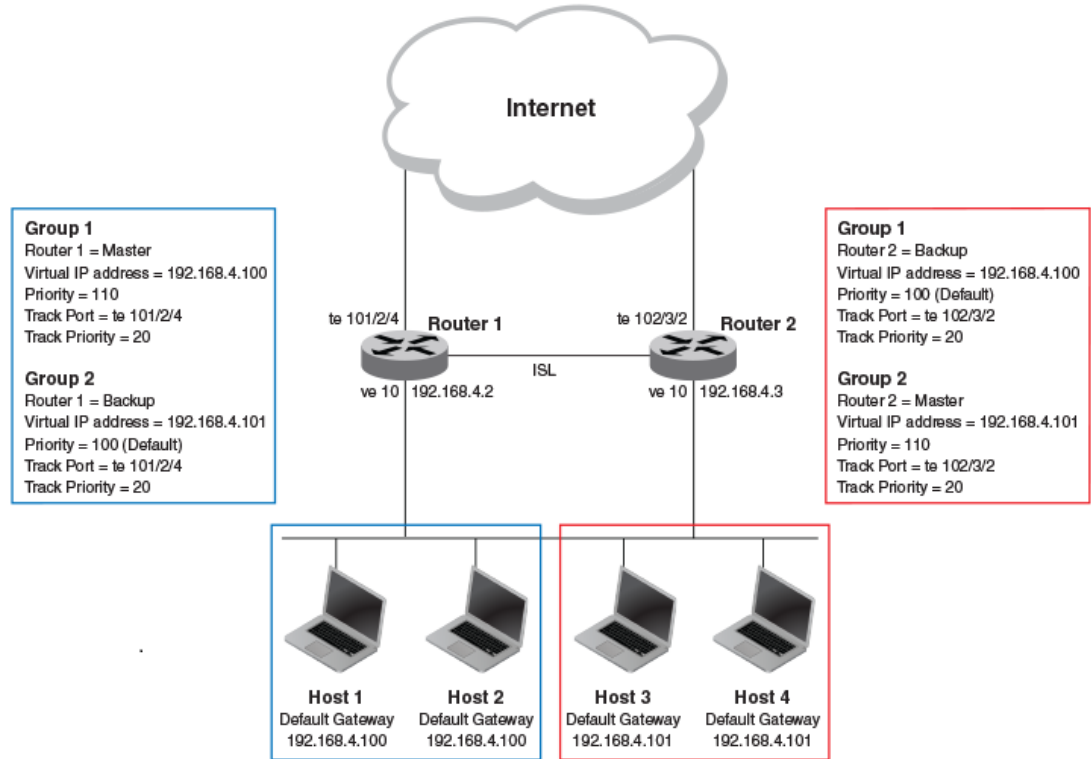
### Tracking ports and setting VRRP priority

Configuring port tracking on an exit path interface and setting a priority on a VRRP device enables VRRP to monitor the interface. If the interface goes down, the device priority is lowered and another backup device with a higher priority assumes the role of master.

In the following task steps, interface tengigabitethernet 101/2/4 on Router 1 (shown in the diagram below) is configured to be tracked, and if the interface fails, the VRRP priority of Router 1 is lowered by

a value of 20. Router 1 is the master VRRP device for group 1 and a lower priority triggers a backup device with a higher priority, Router 2, to become the new master for Group 1.

**FIGURE 20** Multigroup VRRP routing topology



1. On the device on which the tracked interface exists, enter the **rbridge-id** command in global configuration mode, using the RBridge ID (which has an asterisk next to it when you run a do show vcs command).  

```
device(config)# rbridge-id 101
```
2. Enter the **protocol vrrp** command to configure the VRRP protocol globally.  

```
device(config-rbridge-id-101)# protocol vrrp
```
3. Enter interface configuration mode and run the following command:  

```
device(config-rbridge-id-101)# int ve 10
```
4. Run the following command to enter group configuration mode.  

```
device(conf-Ve-10)# vrrp-group 1
```
5. Enter the **track** command to set the track port and priority:  

```
device(config-vrrp-group-1)# track te 101/2/4 priority 20
```

The following example shows how to configure interface tengigabitethernet 101/2/4 on Router 2 to be tracked, and if the interface fails, the VRRP priority of Router 2 is lowered by a value of 40. Router 2 is the master VRRP device for group 2 and a lower priority triggers a backup device, Router 1, to become the new master for group 2.

```
device(config)# rbridge-id 102
device(config-rbridge-id-102)# protocol vrrp
device(config-rbridge-id-102)# int ve 10
device(conf-Ve-10)# vrrp-group 2
device(config-vrrp-group-1)# track te 102/3/2 priority 40
```

## VRRP backup preemption

Preemption of a backup VRRP device acting as a master device is allowed when another backup device has a higher priority.

By default, preemption is enabled for VRRP. In VRRP, preemption allows a backup device with the highest priority to become the master device when the master (also the owner) device goes offline. If another backup device is added with a higher priority, it will assume the role of the master VRRP device. In some larger networks there may be a number of backup devices with varying levels of priority and preemption can cause network flapping. To prevent the flapping, disable preemption.

---

### NOTE

If preemption is disabled for VRRP, the owner device is not affected because the owner device always preempts the active master. When the owner device is online, the owner device assumes the role of the master device regardless of the setting for the preempt parameter.

---

In VRRP-E, preemption is disabled by default. In situations where a new backup device is to be added with a higher priority, preemption can be enabled. There are no owner devices in VRRP-E to automatically preempt a master device.

## Enabling VRRP backup preemption

Allowing a backup VRRP device that is acting as the master to be preempted by another backup device with a higher priority value.

A VRRP or VRRP-E session must be enabled.

1. On the device designated as a backup VRRP device, from privileged EXEC mode, enter configuration mode by issuing the **configure** command.

```
device# configure
```

2. Enter the **rbridge-id** command, using the RBridge ID (which has an asterisk next to it when you run a **do show vcs** command).

```
device(config)# rbridge-id 102
```

3. Globally enable the VRRP protocols.

```
device(config-rbridge-id-102)# protocol vrrp
```

4. Configure the tengigabitethernet interface for the device.

```
device(config-rbridge-id-102)# interface tengigabitethernet 102/1/5
```

5. Configure the IP address of the interface:

```
device(conf-if-te-102/1/5)# ip address 192.168.4.3/24
```

---

### NOTE

This router is a backup router.

---

6. Assign the device to VRRP group 1.

```
device(conf-if-te-102/1/5)# vrrp-group 1
```

7. Enter the **preempt-mode** command to configure backup preemption.

```
device(conf-vrrp-group-1)# preempt-mode
```

If a backup device has a higher priority than the current master device, the backup device will assume the role of the VRRP master device after preemption is enabled.

The following example enables preemption on a backup VRRP device.

```
device# configure
device(config)# rbridge-id 101
device(config-rbridge-id-101)# protocol vrrp
device(config-rbridge-id-101)# interface tengigabitethernet 102/1/5
device(conf-if-te-101/1/5)# ip address 192.168.4.3/24
device(conf-if-te-101/1/5)# vrrp-group 1
device(config-vrrp-group-1)# preempt-mode
```

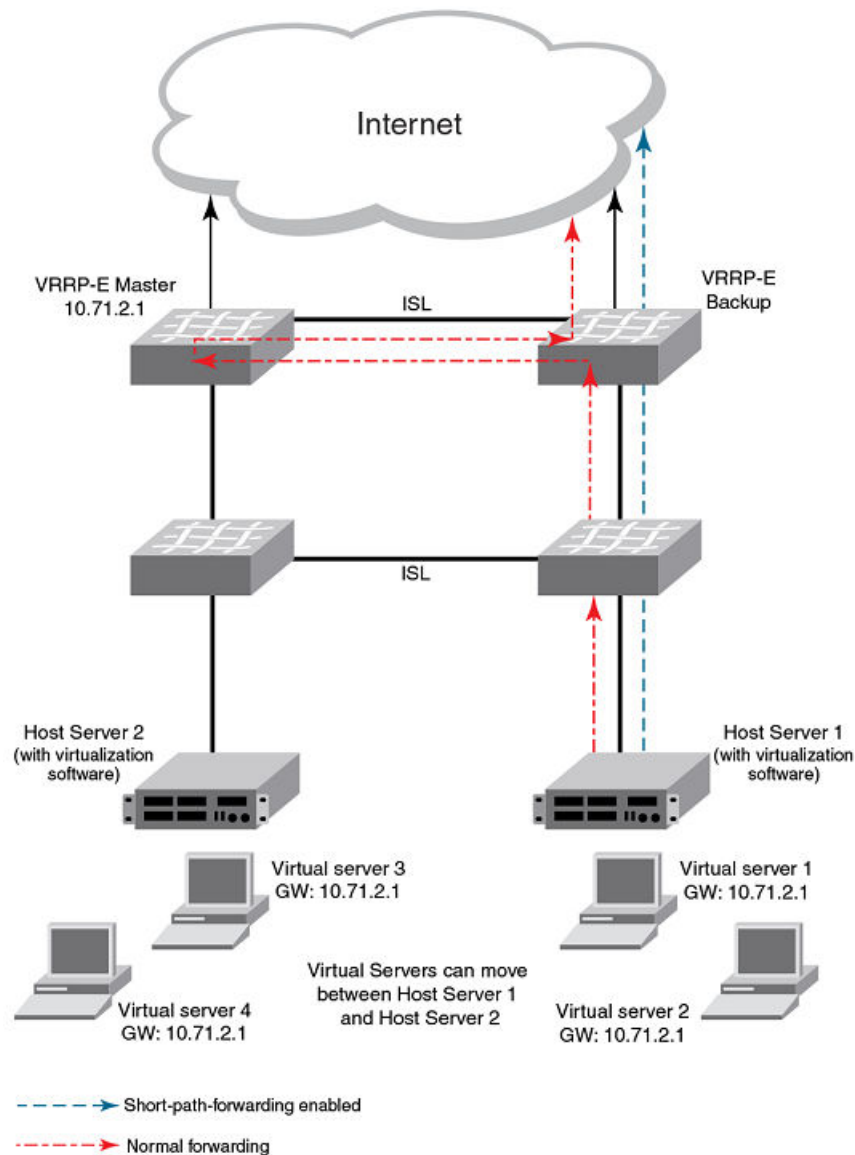
## VRRP-E load-balancing using short-path forwarding

The VRRP-E extension for Server Virtualization feature allows Brocade devices to bypass the VRRP-E master router and directly forward packets to their destination through interfaces on the VRRP-E backup router. This is called *short-path forwarding*. A backup router participates in a VRRP-E session only when short-path forwarding is enabled.

VRRP-E active-active load-balancing is available in VCS mode and uses flow-hashing techniques to determine the path. All nodes in the VCS are aware of all VRRP-E sessions and the participating RBridges in each session.

### Packet routing with short-path forwarding to balance traffic load

When short-path forwarding is enabled, traffic load-balancing is performed because both master and backup devices can be used to forward packets.

**FIGURE 21** Short-path forwarding

If you enable short-path forwarding in both master and backup VRRP-E devices, packets sent by Host Server 1 (in the above figure) and destined for the Internet cloud through the device on which a VRRP backup interface exists can be routed directly to the VRRP backup device (blue dotted line) instead of being switched to the master router and then back (red dotted-dash line).

In the above figure, load-balancing is achieved using short-path forwarding by dynamically moving the virtual servers between Host Server 1 and Host Server 2.

## Short-path forwarding with revert priority

Revert priority is used to dynamically enable or disable VRRP-E short-path forwarding.

If short-path forwarding is configured with revert priority on a backup router, the revert priority represents a threshold for the current priority of the VRRP-E session. When the backup device priority

is higher than the configured revert priority, the backup router is able to perform short-path forwarding. If the backup priority is lower than the revert priority, short-path forwarding is disabled.

Revert priority is supported on both version 2 and version 3 of VRRP-E.

## Configuring VRRP-E load-balancing in VCS mode

VRRP-E traffic can be load-balanced using short-path forwarding on the backup devices. Short-path forwarding is only supported in VCS mode.

Before configuring VRRP-E load-balancing, VRRP-E must be configured on all devices in the VRRP-E session.

1. Use the **configure** command to enter global configuration mode.

```
device# configure
```

2. Enter the **rbridge-id** command with an associated RBridge ID to enter RBridge configuration mode for a specific ID.

```
device(config)# rbridge-id 122
```

3. To globally enable VRRP-E, enter the **protocol vrrp-extended** command.

```
device(config-rbridge-id-122)# protocol vrrp-extended
```

4. Enter the **interface ve** command with an associated VLAN number.

```
device(config-rbridge-id-122)# interface ve 2019
```

In this example, virtual Ethernet (ve) configuration mode is entered and the interface is assigned with a VLAN number of 2019.

5. Enter an IP address for the interface using the **ip address** command.

```
device(config-ve-2019)# ip address 192.168.4.1/24
```

6. Enter the **vrrp-extended-group** command with a number to assign a VRRP-E group to the device.

```
device(config-ve-2019)# vrrp-extended-group 19
```

In this example, VRRP-E group configuration mode is entered.

7. Enter the **short-path-forwarding** command with a **revert-priority** value to configure the backup VRRP-E as an alternate path with a specified priority.

```
device(config-vrrp-extended-group-19)# short-path-forwarding revert-priority 50
```

When the backup device priority is higher than the configured **revert-priority** value, the backup router is able to perform short-path forwarding. If the backup priority is lower than the revert priority, short-path forwarding is disabled.

In the following example, short-path forwarding is configured on a backup VRRP-Ev3 device and a revert priority threshold is configured. If the backup device priority falls below this threshold, short-path forwarding is disabled.

```
device# configure
device(config)# rbridge-id 122
device(config-rbridge-id-122)# protocol vrrp-extended
device(config-rbridge-id-122)# interface ve 2019
device(config-ve-2019)# ip address 192.168.4.1/24
device(config-ve-2019)# vrrp-extended-group 19
device(config-vrrp-extended-group-19)# short-path-forwarding revert-priority 50
```



## Clearing VRRPv2 statistics

VRRPv2 session counters can be cleared using a CLI command.

Ensure that VRRPv2 or VRRP-Ev2 is configured and enabled in your network.

An excerpt of the **show vrrp** output is shown before and after **clear vrrp statistics** is entered.

1. Enter the **exit** command to return to global configuration mode.
2. Enter the **show vrrp** command with a virtual-group ID.

```
device# show vrrp 1
=====Rbridge-id:125=====
Total number of VRRP session(s)   : 2
VRID 1
  Interface: Ve 10;  Ifindex: 1207959562
  Mode: VRRP
  Admin Status: Enabled
  Description :
  Address family: IPv4
  Version: 2
.
.
.
Statistics:
  Advertisements: Rx: 0, Tx: 60
  Neighbor Advertisements: Tx: 30
```

3. Enter the **clear vrrp statistics** command.

```
device# clear vrrp statistics
```

4. Enter the **show vrrp** command with a virtual-group ID.

```
device# show vrrp 1
=====Rbridge-id:125=====
Total number of VRRP session(s)   : 2
VRID 1
  Interface: Ve 10;  Ifindex: 1207959562
  Mode: VRRP
  Admin Status: Enabled
  Description :
  Address family: IPv4
  Version: 2
.
.
.
Statistics:
  Advertisements: Rx: 0, Tx: 6
  Neighbor Advertisements: Tx: 3
```

In this show output for a specified device Rbridge ID after the **clear** command has been entered, you can see that the statistical counters have been reset. Although some of the counters are showing numbers because VRRP traffic is still flowing, the numbers are much lower than in the initial **show** command output.

## Displaying VRRPv2 information

Using various show commands to display statistical and summary information about VRRP and VRRP-E configurations.

Before displaying VRRP information, VRRPv2 must be configured and enabled in your VRRP or VRRP-E network to generate traffic.

1. Use the **exit** command to return to global configuration mode.
2. Enter the **show vrrp** command with a virtual-group ID.

```
device# show vrrp 1

=====Rbridge-id:2=====

Total number of VRRP session(s)   : 1

VRID 1
  Interface: Ve 10;  Ifindex: 1207959562
  Mode: VRRP
  Admin Status: Enabled
  Description :
  Address family: IPv4
  Version: 2
  Authentication type: No Authentication
  State: Initialize
  Session Master IP Address:
  Virtual IP(s): 192.168.4.1
  Configured Priority: unset (default: 100); Current Priority: 100
  Advertisement interval: 1 sec (default: 1 sec)
  Preempt mode: ENABLE (default: ENABLE)
  Hold time: 0 sec (default: 0 sec)
  Trackport:
    Port(s)                Priority  Port Status
    =====                =====  =====
  Statistics:
    Advertisements: Rx: 60, Tx: 6
    Gratuitous ARP: Tx: 2
```

This example output shows that one IPv4 VRRP session is configured.

3. Enter the **show vrrp summary** command.

```
device# show vrrp summary

=====Rbridge-id:2=====

Total number of VRRP session(s)   : 1
Master session count   : 1
Backup session count   : 0
Init session count     : 0

VRID  Session  Interface      Admin    Current  State  Short-path  Revert
SPF                                     State    Priority          Forwarding  Priority

Reverted
====  =====  =====      =====  =====  =====  =====  =====
=====

1      VRRP      Ve 100         Enabled   110      Master
```

This example displays information about VRRP sessions.

4. Enter the **show vrrp interface** command with interface ve 10 options and detailed output.

```
device# show vrrp int ve 10 detail

=====Rbridge-id:2=====

Total number of VRRP session(s)   : 1

VRID 1
  Interface: Ve 10;  Ifindex: 1207959562
  Mode: VRRP
  Admin Status: Enabled
```

```

Description :
Address family: IPv4
Version: 2
Authentication type: No Authentication
State: Initialize
Session Master IP Address:
Virtual IP(s): 192.168.4.1
Virtual MAC Address: 0000.5e00.0101
Configured Priority: 110 (default: 100); Current Priority: unset
Advertisement interval: 1 sec (default: 1 sec)
Preempt mode: ENABLE (default: ENABLE)
Hold time: 0 sec (default: 0 sec)
Master Down interval: 4 sec
Trackport:
  Port(s)                Priority  Port Status
  =====                =====  =====

```

```

Global Statistics:
=====
Checksum Error : 0
Version Error  : 0
VRID Invalid   : 0

```

```

Session Statistics:
=====
Advertisements           : Rx: 60, Tx: 6
Gratuitous ARP           : Tx: 2
Session becoming master  : 0
Advts with wrong interval : 0
Prio Zero pkts           : Rx: 0, Tx: 0
Invalid Pkts Rvcd        : 0
Bad Virtual-IP Pkts      : 0
Invalid Authentication type : 0
Invalid TTL Value        : 0
Invalid Packet Length    : 0

```

# VRRPv3

---

• VRRPv3 overview.....	172
• Enabling IPv6 VRRPv3.....	173
• Enabling IPv4 VRRPv3.....	174
• Enabling IPv6 VRRP-Ev3.....	175
• Track ports and track priority with VRRP and VRRP-E.....	176
• VRRP hold timer.....	178
• VRRP-E load-balancing using short-path forwarding.....	179
• VRRP-Ev3 sub-second failover.....	182
• VRRPv3 router advertisement suppression.....	183
• Alternate VRRPv2 checksum for VRRPv3 IPv4 sessions.....	184
• Displaying VRRPv3 statistics.....	185
• Clearing VRRPv3 statistics.....	187

## VRRPv3 overview

VRRP version 3 (VRRPv3) introduces IPv6 address support to both the standard VRRP and the VRRP enhanced (VRRP-E) protocols.

Virtual Router Redundancy Protocol (VRRP) is designed to eliminate the single point of failure inherent in the static default routed environment by providing redundancy to Layer 3 devices within a local area network (LAN). VRRP uses an election protocol to dynamically assign the default gateway for a host to one of a group of VRRP routers on a LAN. Alternate gateway router paths can be allocated without changing the IP address or MAC address by which the host device knows its gateway.

VRRPv3 implements support for IPv6 addresses for networks using IPv6 and also supports IPv4 addresses for dual-stack networks configured with VRRP or VRRP-E. VRRPv3 is compliant with RFC 5798. The benefit of implementing VRRPv3 is the faster switchover to backup devices than can be achieved using standard IPv6 Neighbor Discovery mechanisms. With VRRPv3, a backup router can become a master router in a few seconds with less overhead traffic and no interaction with the hosts.

When VRRPv3 is configured, the master device that owns the virtual IP address and a master device that does not own the virtual IP address, can both respond to ICMP echo requests (ping) and accept Telnet and other management traffic sent to the virtual IP address. In VRRPv2, only a master device on which the virtual IP address is the address of an interface on the master device can respond to ping and other management traffic.

The following are other IPv6 VRRPv3 functionality details:

- VRRPv2 functionality is supported by VRRPv3 except for VRRP authentication.
- Two VRRP and VRRP-E sessions cannot share the same group ID on the same interface.

## VRRPv3 functionality differences on Brocade VDX devices

The implementation of VRRPv3 varies across the VDX products.

VRRPv3 functionality on the VDX 8770 platforms.

- VRRP and VRRP-E configurations can coexist on the same interface.

VRRPv3 functionality on the VDX 6740 platforms.

- VRRP and VRRP-E configurations cannot coexist on the same interface.

## VRRPv3 performance and scalability metrics for Network OS devices

The following table defines VRRPv3 system resource metrics by Network OS device.

**TABLE 2** System resource metrics for VRRPv3

System resource	VDX 87xx	VDX 67xx
Max # of VRRP and VRRP-E sessions with advertisement interval of 1 second	1024	255
Max # of VRRP and VRRP-E sessions with advertisement interval of 500 milliseconds	500	100
Max # of VRRP and VRRP-E sessions with advertisement interval of 200 milliseconds	200	50
VRRP sessions per interface	16	8
Max # of VRRP devices	8	8

## Enabling IPv6 VRRPv3

IPv6 VRRPv3 is enabled on a device when a virtual IPv6 address is assigned to a VRRPv3 group.

Before assigning a virtual IPv6 address to a VRRPv3 group, you must configure IPv6 VRRP version 3 on a virtual Ethernet interface and assign a VRRPv3 group to the device. The VRRPv3 session is enabled using a virtual IPv6 address. The device must be a router or another device that supports Layer 3 routing.

Perform this task on all devices that are to run VRRPv3. The device to which the virtual IP address belongs determines the initial master device status with all the other devices acting as backups.

1. Enter the **configure** command to access global configuration mode.

```
device# configure
```

2. Enter the **rbridge-id** command with an RBridge ID to enter RBridge ID configuration mode.

```
device(config)# rbridge-id 125
```

3. To globally enable VRRPv3, enter the **ipv6 protocol vrrp** command.

```
device(config-rbridge-id-125)# ipv6 protocol vrrp
```

4. Enter the **interface ve** command with an associated VLAN number.

```
device(config-rbridge-id-125)# interface ve 2018
```

In this example, virtual Ethernet (ve) interface configuration mode is entered and the interface is assigned with a VLAN number of 2018.

5. Enter an IPv6 address for the interface using the **ipv6 address** command.

```
device(config-ve-2018)# ipv6 address 2001:2018:8192::125/64
```

6. Enter the **ipv6 vrrp-group** command with a number to assign a VRRPv3 group to the device.

```
device(config-ve-2018)# ipv6 vrrp-group 18
```

In this example, VRRP group configuration mode is entered.

7. Enter the **virtual-ip** command to assign a link-local virtual IPv6 address to a VRRPv3 group.

```
device(config-vrrp-group-18)# virtual-ip fe80::2018:1
```

In this example, the link-local IPv6 address of the virtual router is assigned to VRRPv3 group 18. The first virtual IP address entered enables the VRRPv3 session.

---

#### NOTE

A link-local IPv6 address is valid only for a single network link. If the virtual IP address can be reached from outside the local network, a global IPv6 address must be configured as a virtual IP address. At least one link-local address is also required.

---

8. Enter the **virtual-ip** command to assign a virtual IPv6 address to a VRRPv3 group.

```
device(config-vrrp-group-18)# virtual-ip 2001:2018:8192::1
```

In this example, the IPv6 address of the virtual router is assigned to VRRPv3 group 18.

The following example shows how to enable a VRRPv3 session by assigning virtual IP addresses to a VRRPv3 virtual group.

```
device# configure
device(config)# rbridge-id 125
device(config-rbridge-id-125)# ipv6 protocol vrrp
device(config-rbridge-id-125)# interface ve 2018
device(config-ve-2018)# ipv6 address 2001:2018:8192::122/64
device(config-ve-2018)# ipv6 vrrp-group 18
device(config-vrrp-group-18)# virtual-ip fe80::2018:1
device(config-vrrp-group-18)# virtual-ip 2001:2018:8192::1
```

## Enabling IPv4 VRRPv3

IPv4 VRRPv3 is enabled on a device when a virtual IP address is assigned to a VRRPv3 group.

VRRPv3 supports IPv4 sessions as well as IPv6 sessions. To configure a VRRPv3 session for IPv4 assign a virtual router group with the **v3** option to the device. The device must be a router or another device that supports Layer 3 routing.

Perform this task on all devices that are to run IPv4 VRRPv3. The device to which the virtual IP address belongs determines the initial master device status with all the other devices acting as backups.

1. Enter the **configure** command to access global configuration mode.

```
device# configure
```

2. Enter the **rbridge-id** command with an RBridge ID to enter RBridge ID configuration mode.

```
device(config)# rbridge-id 101
```

3. To globally enable VRRP, enter the **protocol vrrp** command.

```
device(config-rbridge-id-101)# protocol vrrp
```

4. Enter the **interface tengigabitethernet** command with an associated RBridge ID and slot/port number.

```
device(config-rbridge-id-125)# interface tengigabitethernet 101/1/6
```

In this example, tengigabitethernet (te) interface configuration mode is entered and the interface is assigned with an associated RBridge ID and slot/port number of 101/1/6.

5. Enter an IPv4 address for the interface using the **ip address** command.

```
device(config-if-te-101/1/6)# ip address 192.168.5.2/24
```

6. Enter the **vrrp-group** command with a number to assign a virtual router group to the device and a version to configure VRRPv3.

```
device(config-if-te-101/1/6)# vrrp-group 10 version 3
```

In this example, a VRRPv3 group is assigned and VRRP group configuration mode is entered.

7. Enter the **advertisement-interval** command with a number in milliseconds to configure the interval at which the master VRRP router advertises its existence to the backup routers.

```
device(config-vrrp-group-10)# advertisement-interval 2000
```

In this example, the interval is expressed as 2000 milliseconds because VRRPv3 uses milliseconds instead of seconds for the advertisement interval.

8. Enter the **virtual-ip** command to assign a virtual IP address to a VRRPv3 group.

```
device(config-vrrp-group-10)# virtual-ip 192.168.5.2
```

In this example, the IPv4 address of the virtual router is assigned to VRRPv3 group 10. This virtual IP address belongs to this device and this device will assume the role of the master device.

The following example shows how to enable an IPv4 VRRPv3 session by assigning virtual IP addresses to a VRRPv3 virtual group.

```
device# configure
device(config)# rbridge-id 101
device(config-rbridge-id-101)# protocol vrrp
device(config-rbridge-id-101)# interface tengigabitethernet 101/1/6
device(config-if-te-101/1/6)# ip address 192.168.5.2/24
device(config-if-te-101/1/6)# vrrp-group 10 version 3
device(config-vrrp-group-10)# advertisement-interval 2000
device(config-vrrp-group-10)# virtual-ip 192.168.5.2
```

## Enabling IPv6 VRRP-Ev3

IPv6 VRRP-Ev3 is enabled on a device when a virtual IPv6 address is assigned to a VRRP-Ev3 group.

1. Enter the **configure** command to access the global configuration mode.

```
device# configure
```

2. Enter the **rbridge-id** command with an RBridge ID to enter RBridge ID configuration mode.

```
device(config)# rbridge-id 122
```

- To globally enable VRRP-Ev3, enter the **ipv6 protocol vrrp-extended** command.

```
device(config-rbridge-id-122)# ipv6 protocol vrrp-extended
```

- Enter the **interface ve** command with an associated VLAN number.

```
device(config-rbridge-id-122)# interface ve 2019
```

In this example, virtual Ethernet (ve) configuration mode is entered and the interface is assigned with a VLAN number of 2019.

- Enter an IPv6 address for the interface using the **ipv6 address** command.

```
device(config-ve-2019)# ipv6 address 2001:2019:8192::122/64
```

- Enter the **ipv6 vrrp-extended-group** command with a number to assign a VRRP-E group to the device.

```
device(config-ve-2019)# ipv6 vrrp-extended-group 19
```

In this example, VRRP-Ev3 group configuration mode is entered.

- Enter the **virtual-ip** command to assign a link-local virtual IPv6 address to a VRRPv3 group.

```
device(config-vrrp-extended-group-19)# virtual-ip fe80::2019:1
```

In this example, the IPv6 address of the virtual router is assigned to VRRP-Ev3 group 19 and the VRRP-Ev3 session is enabled.

---

#### NOTE

A maximum of two virtual IPv6 addresses can be configured on VRRP-Ev3 group. For VRRPv3, Brocade recommends using two IPv6 addresses; one link local address and one global address.

---

- Enter the **virtual-ip** command to assign a virtual IPv6 address to a VRRPv3 group.

```
device(config-vrrp-extended-group-19)# virtual-ip 2001:2019:8192::1
```

In this example, a global IPv6 address is configured for the virtual router.

The following example shows how to enable a VRRP-E-v3 session by assigning a virtual IP address to an extended VRRP-E-v3 virtual group.

```
device# configure
device(config)# rbridge-id 122
device(config-rbridge-id-122)# ipv6 protocol vrrp-extended
device(config-rbridge-id-122)# interface ve 2019
device(config-ve-2019)# ipv6 address 2001:2019:8192::122/64
device(config-ve-2019)# ipv6 vrrp-extended-group 19
device(config-vrrp-extended-group-19)# virtual-ip fe80::2019:1
device(config-vrrp-extended-group-19)# virtual-ip 2001:2019:8192::1
```

After enabling a VRRP-Ev3 session, you may need to configure some optional parameters such as short-path forwarding for load-balancing or tracking an interface.

## Track ports and track priority with VRRP and VRRP-E

Port tracking allows interfaces not configured for VRRP or VRRP-E to be monitored for link state changes that can result in dynamic changes to the VRRP device priority.

A tracked port allows you to monitor the state of the interfaces on the other end of a route path. A tracked interface also allows the virtual router to lower its priority if the exit path interface goes down, allowing another virtual router in the same VRRP (or VRRP-E) group to take over. When a tracked interface returns to an up state, the configured track priority is added to the current virtual router priority value. The following conditions and limitations exist for tracked ports:



- Track priorities must be lower than VRRP or VRRP-E priorities.
- The dynamic change of router priority can trigger master device switchover if preemption is enabled. However, if the router is an owner, the master device switchover will not occur.
- The maximum number of interfaces that can be tracked for a virtual router is 16.
- Port tracking is allowed for physical interfaces and port-channels.

## Port tracking using IPv6 VRRPv3

The tracking of the link status of an interface not configured for VRRP or VRRP-E can be configured with a priority that can result in dynamic changes to the VRRP device priority.

1. Enter the **configure** command to access global configuration mode.

```
device# configure
```

2. Enter the **rbridge-id** command with an RBridge ID to enter RBridge ID configuration mode.

```
device(config)# rbridge-id 125
```

3. To globally enable VRRPv3, enter the **ipv6 protocol vrrp** command.

```
device(config-rbridge-id-125)# ipv6 protocol vrrp
```

4. Enter the **interface ve** command with an associated VLAN number.

```
device(config-rbridge-id-125)# interface ve 2018
```

In this example, virtual Ethernet (ve) interface configuration mode is entered and the interface is assigned with a VLAN number of 2018.

5. Enter an IPv6 address for the interface using the **ipv6 address** command.

```
device(config-ve-2018)# ipv6 address 2001:2018:8192::125/64
```

6. Enter the **ipv6 vrrp-group** command with a number to assign a VRRPv3 group to the device.

```
device(config-ve-2018)# ipv6 vrrp-group 18
```

In this example, VRRP group configuration mode is entered.

7. Enter the **virtual-ip** command to assign a link-local virtual IPv6 address to a VRRPv3 group.

```
device(config-vrrp-group-18)# virtual-ip fe80::2018:1
```

In this example, the link-local IPv6 address of the virtual router is assigned to VRRPv3 group 18. The first virtual IP address entered enables the VRRPv3 session.

---

### NOTE

A link-local IPv6 address is valid only for a single network link, another IPv6 address must be configured as a virtual IP address for routing purposes.

---

8. Enter the **virtual-ip** command to assign a virtual IPv6 address to a VRRPv3 group.

```
device(config-vrrp-group-18)# virtual-ip 2001:2018:8192::1
```

In this example, the IPv6 address of the virtual router is assigned to VRRPv3 group 18.

9. Enter the **track** command with an interface and a priority to enable the tracking of ports that are not configured as VRRP interfaces.

```
device(config-vrrp-group-18)# track tengigabitethernet 3/0/5 priority 15
```

10. Enter the **enable** command to enable the tracking of ports that are not configured as VRRP interfaces.

```
device(config-vrrp-group-18)# enable
```

11. Enter the **no preempt-mode** command to disable preemption.

```
device(config-vrrp-group-18)# no preempt-mode
```

Preemption can be disabled when you do not want to preempt an existing master with a higher priority device.

- Enter the **priority** command to configure the priority of the virtual router. In VRRPv3, the virtual router with the highest priority becomes the master VRRPv3 device.

```
device(config-vrrp-group-18)# priority 120
```

The following example shows how to configure an IPv6 VRRPv3 session and enable the tracking of a 10 GbE interface.

```
device# configure
device(config)# rbridge-id 125
device(config-rbridge-id-125)# ipv6 protocol vrrp
device(config-rbridge-id-125)# interface ve 2018
device(config-ve-2018)# ipv6 address 2001:2018:8192::122/64
device(config-ve-2018)# ipv6 vrrp-group 18
device(config-vrrp-group-18)# virtual-ip fe80::2018:1
device(config-vrrp-group-18)# virtual-ip 2001:2018:8192::1
device(config-vrrp-group-18)# track tengigabitethernet 3/0/5 priority 15
device(config-vrrp-group-18)# enable
device(config-vrrp-group-18)# no preempt-mode
device(config-vrrp-group-18)# priority 120
```

## VRRP hold timer

Hold timer support delays the preemption of a master VRRP device by a high-priority backup device.

A hold timer is used when a VRRP-enabled device that was previously a master device failed, but is now back up. This restored device now has a higher priority than the current VRRP master device and VRRP normally triggers an immediate switchover. In this situation, it is possible that not all the software components on the backup device have converged yet. The hold timer can enforce a waiting period before the higher-priority backup device assumes the role of master VRRP device again. The timer must be set to a number greater than 0 seconds for this functionality to take effect.

Hold timer functionality is supported in both version 2 and version 3 of VRRP and VRRP-E.

### Configuring VRRP hold timer support

A hold timer can be configured on a VRRP-enabled interface to set an interval, in seconds, before a backup device becomes the master VRRP device.

To configure a hold timer, VRRP must be enabled on the device.

- Enter the **configure** command to access global configuration mode.

```
device# configure
```

- Enter the **rbridge-id** command with an RBridge ID to enter RBridge ID configuration mode.

```
device(config)# rbridge-id 125
```

- Enter the **interface ve** command with an associated vlan number.

```
device(config-rbridge-id-125)# interface ve 2018
```

In this example, virtual Ethernet (ve) interface configuration mode is entered and the interface is assigned with a VLAN number of 2018.

- Enter the **ipv6 vrrp-group** command with a number to assign a VRRPv3 group to the device.

```
device(config-ve-2018)# ipv6 vrrp-group 18
```

In this example, VRRP group configuration mode is entered.

5. Enter the **description** command to enter text that describes the virtual router group.

```
device(config-vrrp-group-18)# description Product Marketing group
```

6. Enter the **advertisement-interval** command with a number representing milliseconds.

```
device(config-vrrp-group-18)# advertisement-interval 3000
```

---

#### NOTE

In VRRPv3, the advertisement-interval is in milliseconds.

---

7. Enter the **hold-time** command with a number representing seconds.

```
device(config-vrrp-group-18)# hold-time 5
```

The following example configures and enables a VRRPv3 session and adds a VRRP group description. A hold time of 5 seconds is configured.

```
device# configure
device(config)# rbridge-id 125
device(config-rbridge-id-125)# ipv6 protocol vrrp-extended
device(config-rbridge-id-125)# interface ve 2018
device(config-ve-2018)# ipv6 address 2001:2018:8192::122/64
device(config-ve-2018)# ipv6 vrrp-group 18
device(config-vrrp-group-18)# virtual-ip fe80::2018:1
device(config-vrrp-group-18)# virtual-ip 2001:2018:8192::1
device(config-vrrp-group-18)# description Product Marketing group
device(config-vrrp-group-18)# advertisement-interval 3000
device(config-vrrp-group-18)# hold-time 5
```

## VRRP-E load-balancing using short-path forwarding

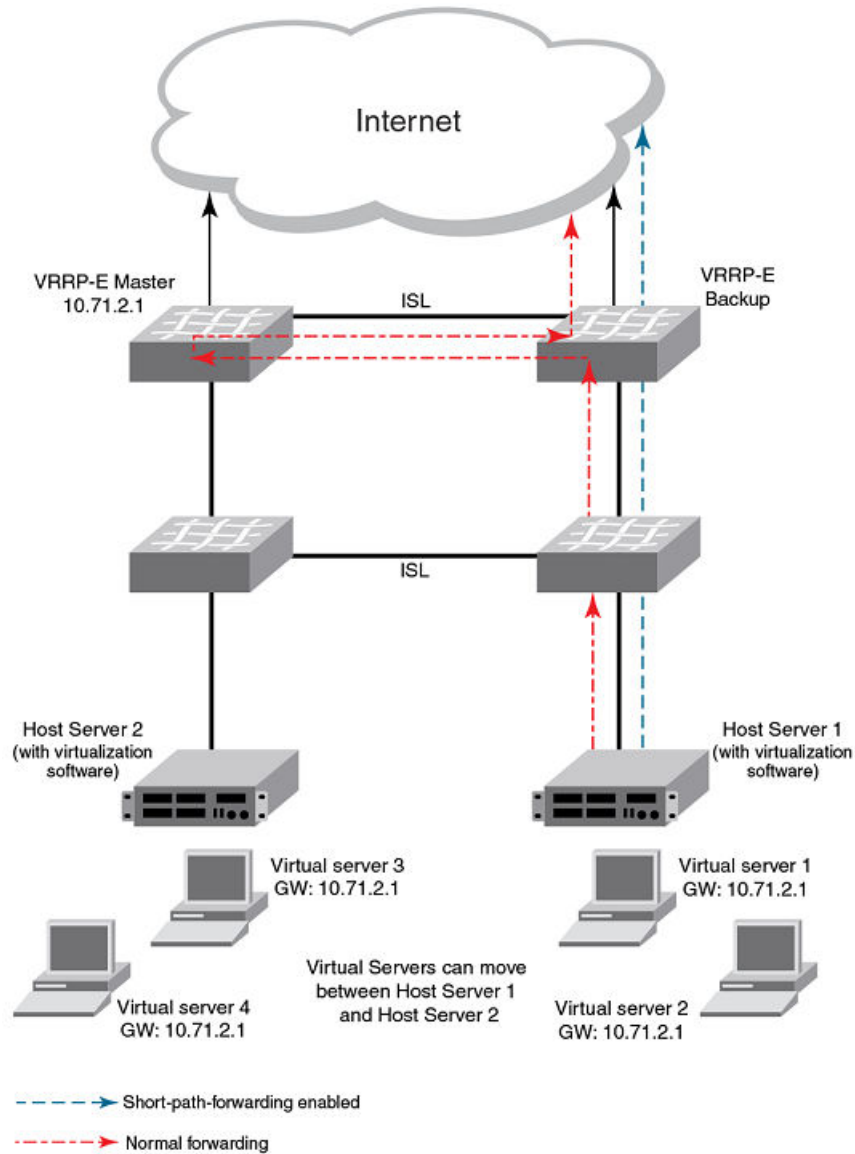
The VRRP-E extension for Server Virtualization feature allows Brocade devices to bypass the VRRP-E master router and directly forward packets to their destination through interfaces on the VRRP-E backup router. This is called *short-path forwarding*. A backup router participates in a VRRP-E session only when short-path forwarding is enabled.

VRRP-E active-active load-balancing is available in VCS mode and uses flow-hashing techniques to determine the path. All nodes in the VCS are aware of all VRRP-E sessions and the participating RBriges in each session.

### Packet routing with short-path forwarding to balance traffic load

When short-path forwarding is enabled, traffic load-balancing is performed because both master and backup devices can be used to forward packets.

**FIGURE 22** Short-path forwarding



If you enable short-path forwarding in both master and backup VRRP-E devices, packets sent by Host Server 1 (in the above figure) and destined for the Internet cloud through the device on which a VRRP backup interface exists can be routed directly to the VRRP backup device (blue dotted line) instead of being switched to the master router and then back (red dotted-dash line).

In the above figure, load-balancing is achieved using short-path forwarding by dynamically moving the virtual servers between Host Server 1 and Host Server 2.

## Short-path forwarding with revert priority

Revert priority is used to dynamically enable or disable VRRP-E short-path forwarding.

If short-path forwarding is configured with revert priority on a backup router, the revert priority represents a threshold for the current priority of the VRRP-E session. When the backup device priority

is higher than the configured revert priority, the backup router is able to perform short-path forwarding. If the backup priority is lower than the revert priority, short-path forwarding is disabled.

Revert priority is supported on both version 2 and version 3 of VRRP-E.

## Configuring VRRP-Ev3 load-balancing in VCS mode

VRRP-Ev3 traffic can be load-balanced using short-path forwarding on the backup devices. Short-path forwarding is only supported in VCS mode.

Before configuring VRRP-Ev3 load-balancing, VRRP-Ev3 must be configured on all devices in the VRRP-Ev3 session.

1. Use the **configure** command to enter global configuration mode.

```
device# configure
```

2. Enter the **rbridge-id** command with an associated RBridge ID to enter RBridge configuration mode for a specific ID.

```
device(config)# rbridge-id 122
```

3. To globally enable VRRP-Ev3, enter the **ipv6 protocol vrrp-extended** command.

```
device(config-rbridge-id-122)# ipv6 protocol vrrp-extended
```

4. Enter the **interface ve** command with an associated VLAN number.

```
device(config-rbridge-id-122)# interface ve 2019
```

In this example, virtual Ethernet (ve) configuration mode is entered and the interface is assigned with a VLAN number of 2019.

5. Enter an IPv6 address for the interface using the **ipv6 address** command.

```
device(config-ve-2019)# ipv6 address 2001:2019:8192::122/64
```

6. Enter the **ipv6 vrrp-extended-group** command with a number to assign a VRRP-E group to the device.

```
device(config-ve-2019)# ipv6 vrrp-extended-group 19
```

In this example, VRRP-Ev3 group configuration mode is entered.

7. Enter the **short-path-forwarding** command with a **revert-priority** value to configure the backup VRRP-E as an alternate path with a specified priority.

```
device(config-vrrp-extended-group-19)# short-path-forwarding revert-priority 50
```

When the backup device priority is higher than the configured **revert-priority** value, the backup router is able to perform short-path forwarding. If the backup priority is lower than the revert priority, short-path forwarding is disabled.

In the following example, short-path forwarding is configured on a backup VRRP-Ev3 device and a revert priority threshold is configured. If the backup device priority falls below this threshold, short-path forwarding is disabled.

```
device# configure
device(config)# rbridge-id 122
device(config-rbridge-id-122)# ipv6 protocol vrrp-extended
device(config-rbridge-id-122)# interface ve 2019
device(config-ve-2019)# ipv6 address 2001:2019:8192::122/64
device(config-ve-2019)# ipv6 vrrp-extended-group 19
device(config-vrrp-extended-group-19)# short-path-forwarding revert-priority 50
```

## VRRP-Ev3 sub-second failover

VRRP-Ev3 introduces a scale time factor to the advertisement interval that results in sub-second failover times.

In VRRP version 2, an advertisement interval can be set to decrease the time period between advertisements to allow for shorter or longer convergence times. In VRRPv3, a new CLI command is introduced to allow scaling of the advertisement interval timer. When a scaling value is configured, the existing advertisement interval timer value is divided by the scaling value. For example, if the advertisement interval is set to 1 second and the scaling value is set to 10, the new advertisement interval is 100 milliseconds. Using the timer scaling, VRRP-Ev3 sub-second convergence is possible if a master fails.

For each VRRP-Ev3 session, the same advertisement interval and scale value should be used. There are some limits on the number of VRRP sessions configured with advertisement intervals of one second or less, for details see the VRRPv3 Performance and Scalability Metrics section.

---

### NOTE

Brocade MLX devices only support a scaling factor of 10. For interoperability with MLX devices, use an advertisement interval scale factor of 10.

---

## Configuring sub-second failover using VRRP-Ev3

Configuring a scale factor making the interval between VRRP advertisements to be set in milliseconds allows a sub-second convergence time if a master VRRP device fails.

The configuring sub-second failover using VRRP-Ev3 task is only supported by VRRP-Ev3.

---

### NOTE

Increased timing sensitivity as a result of this configuration could cause protocol flapping during periods of network congestion.

---

1. Enter the **configure** command to access global configuration mode.

```
device# configure
```

2. Enter the **rbridge-id** command with an RBridge ID to enter RBridge ID configuration mode.

```
device(config)# rbridge-id 122
```

3. To globally enable VRRP-Ev3, enter the **ipv6 protocol vrrp-extended** command.

```
device(config-rbridge-id-122)# ipv6 protocol vrrp-extended
```

4. Enter the **interface ve** command with an associated VLAN number.

```
device(config-rbridge-id-122)# interface ve 2019
```

In this example, virtual Ethernet (ve) configuration mode is entered and the interface is assigned with a VLAN number of 2019.

5. Enter an IPv6 address for the interface using the **ipv6 address** command.

```
device(config-ve-2019)# ipv6 address 2001:2019:8192::122/64
```

6. Enter the **ipv6 vrrp-extended-group** command with a number to assign a VRRP-E group to the device.

```
device(config-ve-2018)# ipv6 vrrp-extended-group 19
```

In this example, VRRP-Ev3 group configuration mode is entered.

7. Enter the **advertisement-interval** command with a value to set the time period in seconds between VRRP advertisements.

```
device(config-vrrp-extended-group-19)# advertisement-interval 1
```

8. Enter the **advertisement-interval-scale** command with a value of 1, 2, 5, or 10. The VRRP advertisement interval is divided by this number to set the time period in milliseconds between VRRP advertisements.

```
device(config-vrrp-extended-group-19)# advertisement-interval-scale 10
```

In this example, the scale number of 10 divided into the advertisement interval of 1 sets the interval between advertisements to 100 milliseconds. If a master VRRP-E device fails, the convergence time to a backup VRRP-E device may be in less than half a second.

The following example demonstrates how to configure a VRRP advertisement interval of 100 milliseconds for an IPv6 VRRP-Ev3 group.

```
device# configure
device(config)# rbridge-id 122
device(config-rbridge-id-122)# ipv6 protocol vrrp-extended
device(config-rbridge-id-122)# interface ve 2019
device(config-ve-2019)# ipv6 address 2001:2019:8192::122/64
device(config-ve-2019)# ipv6 vrrp-extended-group 19
device(config-vrrp-extended-group-19)# advertisement-interval 1
device(config-vrrp-extended-group-19)# advertisement-interval-scale 10
```

## VRRPv3 router advertisement suppression

VRRPv3 introduces the ability to suppress router advertisements (RAs).

Router advertisements are sent by the VRRP master device and contain the link-local virtual IP address and the virtual MAC address. For network security reasons, if you do not want the MAC addresses of interfaces to be viewed, you can disable RA messages. Disabling RA does not remove the auto-configured addresses being sent by VRRP updates, but the RA messages are dropped by the router interface. There are two other situations where you may want to disable RA messages:

- If an interface is currently the VRRP master but the virtual IP address is not the address of this interface, the device should not send RA messages for the interface IP address.
- If the interface is in a backup state, the device should not send RA messages for the interface IP address.

### Disabling VRRPv3 router advertisements

The ability to suppress VRRPv3 master device interface router advertisements is introduced.

Suppressing interface router advertisements from the master VRRPv3 device may be performed for network security concerns because the RA messages include the MAC addresses of interfaces. In this task, VRRP-Ev3 is configured globally and RA messages are suppressed for the virtual ethernet (VE) 2109 interface.

---

#### NOTE

To configure this task for VRRPv3, use the **ipv6 protocol vrrp** command.

---

1. Enter the **configure** command to access global configuration mode.

```
device# configure
```

2. Enter the **rbridge-id** command with an RBridge ID to enter RBridge ID configuration mode.

```
device(config)# rbridge-id 122
```

3. To globally enable VRRP-Ev3, enter the **ipv6 protocol vrrp-extended** command.

```
device(config-rbridge-id-122)# ipv6 protocol vrrp-extended
```

4. Enter the **interface ve** command with an associated VLAN number.

```
device(config-rbridge-id-122)# interface ve 2019
```

In this example, virtual Ethernet (ve) configuration mode is entered and the interface is assigned with a VLAN number of 2019.

5. Enter the **ipv6 vrrp-suppress-interface-ra** command to suppress interface RA messages for the ve 2019 interface.

```
device(config-ve-2019)# ipv6 vrrp-suppress-interface-ra
```

The following example shows how to disable VRRPv3 RA messages from interface configuration mode for a VRRP-Ev3 session.

```
device# configure
device(config)# rbridge-id 122
device(config-rbridge-id-122)# ipv6 protocol vrrp-extended
device(config-rbridge-id-122)# interface ve 2019
device(config-ve-2019)# ipv6 vrrp-suppress-interface-ra
```

## Alternate VRRPv2 checksum for VRRPv3 IPv4 sessions

If VRRPv3 is configured on a Brocade device in a network with third-party peering devices using VRRPv2-style checksum calculations for IPv4 VRRPv3 sessions, a VRRPv2-style checksum must be configured for VRRPv3 IPv4 sessions on a Brocade device.

VRRPv3 introduced a new checksum method for both IPv4 and IPv6 sessions and this version 3 checksum computation is enabled by default. To accommodate third-party devices that still use a VRRPv2-style checksum for IPv4 VRRPv3 sessions, a command-line interface (CLI) command is available for configuration on a Brocade device. The new checksum method is disabled by default and only applicable to IPv4 VRRPv3 sessions. If configured for VRRPv2 sessions, the VRRPv2-style checksum CLI is accepted, but it has no effect.

### Enabling the v2 checksum computation method in a VRRPv3 IPv4 session

Enabling the alternate VRRPv2-style checksum in a VRRPv3 IPv4 session for compatibility with third-party network devices.

VRRPv3 uses the v3 checksum computation method by default for both IPv4 and IPv6 sessions on Brocade devices. Third-party devices may only have a VRRPv2-style checksum computation available for a VRRPv3 IPv4 session. The **use-v2-checksum** command is entered in interface configuration mode.



1. Enter the **configure terminal** command to enter global configuration mode.

```
device# configure terminal
```

2. Enter the **rbridge-id** command with an RBridge ID to enter RBridge ID configuration mode.

```
device(config)# rbridge-id 125
```

3. To enable VRRP globally enter the **protocol vrrp** command.

```
device(config-rbridge-id-125)# protocol vrrp
```

4. Enter the **interface ve** command with an associated VLAN number.

```
device(config-rbridge-id-125)# interface ve 2018
```

5. To assign an IPv4 VRRPv3 group to the device use the **vrrp-group** command with a group number and version 3.

```
device(config-ve-2018)# vrrp-group 10 version 3
```

6. To enable v2 checksum computation method in an IPv4 VRRPv3 session, use the **use-v2-checksum** command in the VRRP group configuration mode.

```
device(config-vrrp-group-10)# use-v2-checksum
```

The following example shows the v2 checksum computation method enabled for an VRRPv3 IPv4 session on a Brocade device.

```
device# configure terminal
device(config)# rbridge-id 125
device(config-rbridge-id-125)# protocol vrrp
device(config-rbridge-id-125)# interface ve 2018
device(config-ve-2018)# vrrp-group 10 version 3
device(config-vrrp-group-10)# use-v2-checksum
```

## Displaying VRRPv3 statistics

Various show commands can display statistical information about IPv6 VRRP and IPv6 VRRP-E configurations.

Before displaying statistics, VRRPv3 must be configured and enabled in your VRRP or VRRP-E network to generate traffic.

1. Use the **exit** command to return to global configuration mode.
2. Enter the **show ipv6 vrrp** command.

```
device# show ipv6 vrrp
=====Rbridge-id:122=====
Total number of VRRP session(s)      : 1
VRID 19
Interface: Ve 2019; Ifindex: 1207961571
Mode: VRRPE
Admin Status: Enabled
Description :
Address family: IPv6
Version: 3
Authentication type: No Authentication
State: Backup
Session Master IP Address: fe80::205:33ff:fe79:fble
Virtual IP(s): 2001:2019:8192::1
Configured Priority: unset (default: 100); Current Priority: 100
Advertisement interval: 1 sec (default: 1 sec)
Preempt mode: DISABLE (default: DISABLED)
```

```

Advertise-backup: ENABLE (default: DISABLED)
Backup Advertisement interval: 60 sec (default: 60 sec)
Short-path-forwarding: Enabled
Revert Priority: unset; SPF reverted: No
Hold time: 0 sec (default: 0 sec)
Trackport:
  Port(s)                Priority  Port Status
  =====                =====  =====
Statistics:
  Advertisements: Rx: 102992, Tx: 1716
  Neighbor Advertisements: Tx: 0

```

This example output shows that one IPv6 VRRP-E session is configured.

### 3. Enter the **show ipv6 vrrp summary** command.

```

device# show ipv6 vrrp summary

=====Rbridge-id:122=====

Total number of VRRP session(s)   : 2
Master session count   : 1
Backup session count   : 1
Init session count    : 0

VRID  Session  Interface  Admin  Current  State  Short-path  Revert  SPF
Reverted
=====  =====  =====  =====  =====  =====  =====  =====  =====
18    VRRPE     Ve 2018   Enabled 254      Master  Enabled    unset
No
19    VRRPE     Ve 2019   Enabled 100      Backup  Enabled    unset    No

```

This example shows summary output for the two IPv6 VRRP-E sessions that are configured for virtual routers 18 and 19.

### 4. Enter the **show ipv6 vrrp 19 detail** command.

```

device# show ipv6 vrrp 19 detail

=====Rbridge-id:122=====

Total number of VRRP session(s)   : 1

VRID 19
Interface: Ve 2019; Ifindex: 1207961571
Mode: VRRPE
Admin Status: Enabled
Description :
Address family: IPv6
Version: 3
Authentication type: No Authentication
State: Backup
Session Master IP Address: fe80::205:33ff:fe79:fb1e
Virtual IP(s): 2001:2019:8192::1
Virtual MAC Address: 02e0.5200.2513
Configured Priority: unset (default: 100); Current Priority: 100
Advertisement interval: 1 sec (default: 1 sec)
Preempt mode: DISABLE (default: DISABLED)
Advertise-backup: ENABLE (default: DISABLED)
Backup Advertisement interval: 60 sec (default: 60 sec)
Short-path-forwarding: Enabled
Revert-Priority: unset; SPF Reverted: No
Hold time: 0 sec (default: 0 sec)
Master Down interval: 4 sec
Trackport:
  Port(s)                Priority  Port Status
  =====                =====  =====

Global Statistics:
=====
Checksum Error : 0
Version Error  : 0
VRID Invalid   : 0

Session Statistics:
=====
Advertisements : Rx: 103259, Tx: 1721

```

```

Neighbor Advertisements          : Tx: 0
Session becoming master         : 0
Advts with wrong interval       : 0
Prio Zero pkts                  : Rx: 0, Tx: 0
Invalid Pkts Rvcd               : 0
Bad Virtual-IP Pkts            : 0
Invalid Authenticon type       : 0
Invalid TTL Value              : 0
Invalid Packet Length          : 0
VRRPE backup advt sent         : 1721
VRRPE backup advt recvd        : 0

```

This example shows detailed output for the IPv6 VRRP-E session for virtual router 19.

## Clearing VRRPv3 statistics

VRRPv3 session counters can be cleared by means of a CLI command.

Ensure that VRRPv3 or VRRP-Ev3 is configured and enabled in your network.

An excerpt of the **show ipv6 vrrp statistics** output is shown before and after **clear ipv6 vrrp statistics** is entered.

1. Enter the **exit** command to return to global configuration mode.
2. Enter the **show ipv6 vrrp detail** as in the following example.

```

device# show ipv6 vrrp detail
=====
Rbridge-id:14
=====
Total number of VRRP session(s)   : 1

VRID 11
  Interface: Ve 100; Ifindex: 1207959652
  Mode: VRRPE
  Admin Status: Enabled
  Description :
  Address family: IPv6
  Version: 3
  Authentication type: No Authentication
  State: Master
  Session Master IP Address: Local
  Backup Router(s): fe80::205:33ff:fe65:9d44
  Virtual IP(s): fe80::1
  Virtual MAC Address: 02e0.5200.250b
  Configured Priority: unset (default: 100); Current Priority: 100
  Advertisement interval: 1 sec (default: 1 sec)
  Preempt mode: ENABLE (default: DISABLED)
  Advertise-backup: ENABLE (default: DISABLED)
  Backup Advertisement interval: 60 sec (default: 60 sec)
  Short-path-forwarding: Enabled
  Revert-Priority: unset; SPF Reverted: No
  Hold time: 0 sec (default: 0 sec)
  Master Down interval: 4 sec
  Trackport:
    Port(s)                Priority  Port Status
    =====
Global Statistics:
=====
  Checksum Error : 0
  Version Error  : 0
  VRID Invalid   : 0

Session Statistics:
=====
  Advertisements          : Rx: 211, Tx: 5111
  Neighbor Advertisements : Tx: 2556

```

```

Session becoming master      : 1
Advts with wrong interval   : 0
Prio Zero pkts              : Rx: 0, Tx: 0
Invalid Pkts Rvcd           : 0
Bad Virtual-IP Pkts         : 0
Invalid Authentication type  : 0
Invalid TTL Value           : 0
Invalid Packet Length       : 0
VRRPE backup advt sent     : 3
VRRPE backup advt recvd    : 84

```

3. Enter the **clear ipv6 vrrp statistics** command.

```
device# clear ipv6 vrrp statistics
```

4. Enter the **show ipv6 vrrp detail** command to confirm the changes.

```
device# show ipv6 vrrp detail
```

```

=====
=
Rbridge-id:14
=====
=
Total number of VRRP session(s)   : 1

VRID 11
  Interface: Ve 100;  Ifindex: 1207959652
  Mode: VRRPE
  Admin Status: Enabled
  Description :
  Address family: IPv6
  Version: 3
  Authentication type: No Authentication
  State: Master
  Session Master IP Address: Local
  Backup Router(s): fe80::205:33ff:fe65:9d44
  Virtual IP(s): fe80::1
  Virtual MAC Address: 02e0.5200.250b
  Configured Priority: unset (default: 100); Current Priority: 100
  Advertisement interval: 1 sec (default: 1 sec)
  Preempt mode: ENABLE (default: DISABLED)
  Advertise-backup: ENABLE (default: DISABLED)
  Backup Advertisement interval: 60 sec (default: 60 sec)
  Short-path-forwarding: Enabled
  Revert-Priority: unset; SPF Reverted: No
  Hold time: 0 sec (default: 0 sec)
  Master Down interval: 4 sec
  Trackport:
    Port(s)                Priority  Port Status
    =====
Global Statistics:
=====
Checksum Error : 0
Version Error  : 0
VRID Invalid   : 0

Session Statistics:
=====
Advertisements           : Rx: 0, Tx: 3
Neighbor Advertisements  :           : Tx: 1
Session becoming master  : 0
Advts with wrong interval : 0
Prio Zero pkts          : Rx: 0, Tx: 0
Invalid Pkts Rvcd       : 0
Bad Virtual-IP Pkts     : 0
Invalid Authentication type : 0
Invalid TTL Value       : 0
Invalid Packet Length   : 0
VRRPE backup advt sent  : 0
VRRPE backup advt recvd : 0

```

In this show output you can see that the statistical counters have been reset. Although some of the counters show numbers because VRRP traffic is still flowing, the numbers are much lower than in the initial **show** command output.

# Configuring Virtual Routing and Forwarding

---

- [VRF overview.....](#) 189
- [Configuring VRF .....](#) 190
- [Inter-VRF route leaking.....](#) 192
- [Understanding and using the management VRF.....](#) 198

## VRF overview

VRF (Virtual Routing and Forwarding) is a technology that controls information flow within a network by isolating the traffic by partitioning the network into different logical VRF domains. This allows a single router or switch to have multiple containers of routing tables or Forwarding Information Bases (FIB) inside it, with one routing table for each VRF instance. This permits a VRF-capable router to function as a group of multiple virtual routers on the same physical router. VRF, in conjunction with virtual private network (VPN) solutions, guarantees privacy of information and isolation of traffic within a logical VRF domain.

A typical implementation of a Virtual Routing and Forwarding instance (referred to as a VRF) are designed to support Border Gateway Protocol (BGP) or Multiprotocol Label Switching (MPLS) VPNs, whereas implementations of VRF-Lite (also referred to as Multi-VRF) typically are much simpler with reduced scalability. The two VRF flavors have a lot in common but differ in the interconnect schemes, routing protocols used over the interconnect, and also in VRF classification mechanisms.

VRF is supported on the Brocade VDX 8770 and VDX 6740 series platforms. The VDX 8770 supports 128 VRF instances and the VDX 6740 supports 32 VRF instances per physical switch.

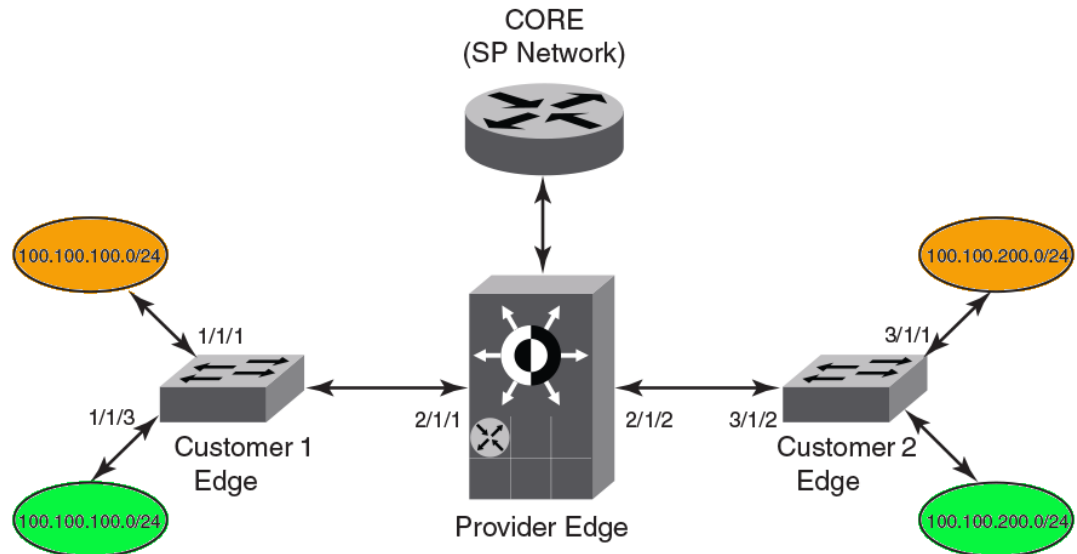
Brocade Network OS 4.0.0 and later supports the VRF-Lite implementation. Unless otherwise noted, all references to VRF in this document also apply to VRF-Lite.

## VRF topology

This diagram illustrates a typical VRF topology with a single VCS comprising Customer 1 Edge, Provider Edge, and Customer 2 Edge routers.

The orange and green ovals indicate two VPNs supporting two different customer sites. Both of them have overlapping IP subnets; 100.100.100.0/24 and 100.100.200.0/24.

FIGURE 23 VRF topology



## Configuring VRF

### NOTE

The following configuration gives an example of a typical VRF-Lite use case and is not meant to give an ideal configuration.

The examples in this section are based on the [VRF topology](#) on page 189 and use the OSPF routing protocol.

Refer to the *Network OS Command Reference* for detailed information on VRF commands.

The following example enables routing and configures VRF on the "orange" edge router. If you want to match the VRF topology diagram, you can repeat the steps here to configure the "green" edge router.

1. Enter RBridge ID configuration mode.

```
switch(config)# rbridge-id 1
```

2. Set up the VRF instance.

- a) Enter VRF configuration mode and specify "orange" as the VRF name.

```
switch(config-rbridge-id-1)# vrf orange
```

- b) Enable IP address-family support for VRF routing.

The **address-family unicast** command supports both IPv4 and IPv6. This example is based on IPv4. Refer to the *Network OS Command Reference* for information on IPv6 support.

```
switch(config-vrf-orange)# address-family ipv4 unicast
```

- c) Specify the maximum number of routes to be used.

```
switch(vrf-ipv4-unicast)# max-route 3600
```

3. Enable the OSPF routing protocol for the instance in VRF configuration mode, and assign it to area 10.

**NOTE**

All OSPF commands that are present under OSPF router configuration mode are applicable to the new OSPF VRF router configuration mode for a non-default VRF instance, the same as for the default VRF instance.

```
switch(vrf-ipv4-unicast)# router ospf vrf orange
switch(config-router-ospf-vrf-orange)# area 10
switch(vrf-ipv4-unicast)# exit
switch(config-vrf-orange)# exit
```

4. Bind the interface to the VRF instance.

**NOTE**

After a VRF instance is enabled on an interface, all Layer 3 configurations on the interface are removed, and you will need to configure them again, as shown in steps 4 and 5.

```
switch(config)# rbridge-id 1
switch(config-rbridge-id-1)# interface ve 128
switch(config-Ve-128)# vrf forwarding orange
```

5. Configure the static routes.  
switch(vrf-ipv4-unicast)# ip route 10.31.1.0/30 10.30.2.1
6. Configure static ARP for the interface.  
switch(vrf-ipv4-unicast)# arp 10.2.2.3 0000.0011.0022 int ve 128
7. Confirm the VRF configuration with the **show vrf** command (using **do** in this configuration mode).

```
switch(vrf-ipv4-unicast)# do show vrf
Total number of VRFs configured: 4
VrfName          VrfId  V4-Ucast  V6-Ucast
Red              3      Enabled   -
default-vrf     1      Enabled   Enabled
mgmt-vrf        0      Enabled   Enabled
re              2      Enabled   -
```

## Enabling VRRP for VRF

To enable the Virtual Router Redundancy Protocol (VRRP) or VRRP-Extended (VRRP-E) for a Virtual Routing and Forwarding (VRF) region, an interface should be assigned to a VRF before enabling the VRRP or VRRP-E protocol. The VRRP protocol is enabled or disabled globally on the switch under RBridge ID configuration mode; it cannot be enabled or disabled on a specific VRF instance.

For more information about the VRRP protocol on Brocade switches, see the Configuring VRRPv2 chapter.

1. Enter RBridge ID configuration mode.  
switch(config)# rbridge-id 1
2. Set the protocol to VRRP.  
switch(config-rbridge-id-1)# protocol vrrp
3. Select the interface.  
switch(config-rbridge-id-1)# interface ve 128
4. Add the interface to the VRF.  
switch(config-Ve-128)# vrf forwarding orange
5. Configure an IP address for the interface.  
switch(config-Ve-128)# ip address 172.128.20.10/24
6. Enable the VRRP or VRRP-E protocol for the interface. (In this example, VRRP-E.)  
switch(config-Ve-128)# vrrp-extended 10
7. Set the virtual IP address.  
switch(config-Ve-128)# virtual-ip 172.128.20.1

## Inter-VRF route leaking

Virtual Routing and Forwarding (VRF) is a technology that provides you with the ability to have multiple virtual routers on a single physical router or switch. VRFs operate without knowledge of one another unless they are imported or exported into one another using Inter-VRF Route Leaking. Inter-VRF route leaking allows leaking of route prefixes from one VRF instance to another VRF instance on the same physical router, which eliminates the need for external routing. This is useful in cases where multiple VRFs share the same path to reach an external domain, while maintaining their internal routing information limited to their own VRF. This feature enables a data center to consolidate multiple VRF services onto a single server.

Both static and dynamic route leaking are supported. Each routed interface (whether virtual or physical) can belong to only one VRF.

Static route leaking provides a mechanism to leak manually configured route entries from a source VRF to a destination VRF.

Dynamic route leaking provides a mechanism to leak routes learned from routing protocols such as BGP and OSPF from a source VRF to a destination VRF. Routes can be leaked by configuring a route map and associating this route map with a source VRF. The match criteria defined in the route map consists of specific route prefixes that exist in the source VRF.

For more information on VRF functionality, refer to [VRF overview](#) on page 189.

### Dynamic route leak restrictions

- Exporting of route maps is not supported.
- Match criteria in a route map must be provided with prefix lists; other match criteria is ignored.
- Connected routers are not leaked.
- Routes in management-vrf with next-hop as eth0 or management interface are not leaked.

### Inter-VRF route conflicts

VRF Route Leaking is a feature which should only be deployed by an advanced user, as route leak configuration in source VRFs may collide with route/interface definitions in target VRFs. This may lead to unpredictable behavior in packet forwarding.

Some of the ways that leaked route conflicts can occur are the following:

- Static route conflict
- Dynamic route conflict
- Connected route conflict

A static route conflict may happen when the same prefix is reachable by two different nexthops in the target VRF. The forwarding behavior would be different based on which command occurred later. This following example presents a static route conflict for 10.1.2.0/24.

```
switch(config)# vrf red
switch(config)# ip route 10.1.2.0/24 next-hop-vrf green 10.1.1.1
switch(config)# vrf green
switch(config)# ip route 10.1.2.0/24 18.1.1.1
```

A dynamic route conflict can occur when dynamic routing protocols advertise different routes to the same prefix in the target VRF.

A connected route conflict is illustrated by the following example:

```
switch(config)# vrf red
switch(config)# ip route 10.1.2.0/24 next-hop-vrf green 10.1.1.1
switch(config)# interface Te 1/2/1
```



```
switch(config)# vrf forwarding green
switch(config)# ip address 10.1.2.1/24
```

**NOTE**

You will need to be aware of such possible conflicts before deploying the route leak feature, as currently there is no error checking for these problems. A good rule is to make sure that definitions are globally unique and route collisions do not exist.

**Displaying Inter-VRF route leaking**

The show command for the IP routing table (**show ip route**) displays a '+' sign next to the route type for the leaked routes in a VRF.

The following example shows the static route using the next-hop VRF option for route leaking:

```
switch# show ip route
Total number of IP routes: 3
Type Codes - B:BGP D:Connected I:ISIS O:OSPF R:RIP S:Static; Cost - Dist/Metric
BGP Codes - i:iBGP e:eBGP
ISIS Codes - L1:Level-1 L2:Level-2
OSPF Codes - i:Inter Area 1:External Type 1 2:External Type 2 s:Sham Link
  Destination      Gateway          Port      Cost    Type    Uptime
1  0.0.0.0/0        10.24.64.1      mgmt 1    1/1     S       8m24s
2  1.1.1.0/24       10.1.1.10       Ve 10     1/1     S+      3m11s
3  10.24.64.0/20    DIRECT          mgmt 1    0/0     D       8m28s
```

Notice the '+' sign next to the Type entry for route entry 2.

You can also determine the leaked route for a specific VRF, as part of the (**show ip route**) command, as illustrated in the following example:

```
switch# show ip route vrf vrf1
Total number of IP routes: 2
Type Codes - B:BGP D:Connected I:ISIS O:OSPF R:RIP S:Static; Cost - Dist/Metric
BGP Codes - i:iBGP e:eBGP
ISIS Codes - L1:Level-1 L2:Level-2
OSPF Codes - i:Inter Area 1:External Type 1 2:External Type 2 s:Sham Link
  Destination      Gateway          Port      Cost    Type    Uptime
1  0.0.0.0/0        192.168.64.1    mgmt 1    1/1     S       8m24s
2  10.11.11.0/24    192.168.21.2    Ve 12     1/1     S+      3m11s
```

Notice the '+' sign next to the Type entry for route entry 2.

**Configuring Static Inter-VRF route leaking**

Static Inter-VRF route leaking is a feature which should only be deployed by an advanced user.

Use the following procedure to set up Inter-VRF route leaking. Refer to the [Example of Static Inter-VRF leaking](#) on page 194 for an illustration.

1. Set the switch to global configuration mode.
2. Configure the VRF instances you want to be the leaker (source VRF) and where the route is being leaked to (destination VRF).
3. Specify the interface for the source VRF and map it to the source VRF.
4. Enter the IP address/mask to be used for this VRF instance.
5. Specify the interface you want to be the destination VRF and map it to the destination VRF.
6. Specify the IP address/mask to receive the leak.
7. Change the config mode to source VRF address family context.

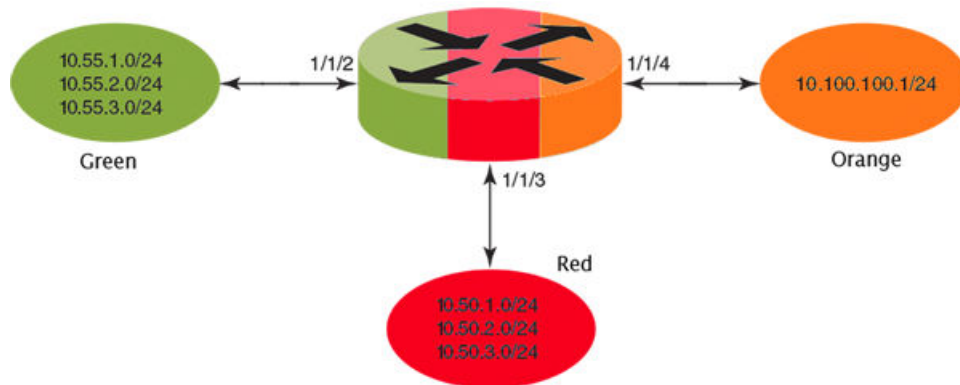
8. Configure the route to be leaked, specifying the route prefix, the next-hop-VRF name as destination VRF and the next hop to the destination VRF.
9. Optional: For bidirectional IVRF leaking, repeat these steps, reversing the source and destination addresses.

### ***Example of Static Inter-VRF leaking***

In this example, one of the static routes in the "Red" VRF (10.50.2.0/24) is being allowed to communicate with one in the "Green" VRF (10.55.2.0/24).

The center icon represents a Brocade VDX router. The red, green and orange ovals represent virtual partitions (VRFs) in that same router. The Destination VRF is where the route is being leaked to ("Green"), and the Source VRF is where the route is being leaked from ("Red").

**FIGURE 24** Static Inter-VRF leaking



1. Configure VRF "Green".
 

```
switch(config)# rbridge-id 1
switch(conf-rbridge-id-1)# vrf Green
switch(conf-vrf-Green)# address-family ipv4 unicast
```
2. Configure VRF "Red".
 

```
switch(config)# rbridge-id 1
switch(conf-rbridge-id-1)# vrf Red
switch(conf-vrf-Red)# address-family ipv4 unicast
```
3. Configure interface in the destination VRF "Green" (using the IP address and subnet mask).
 

```
switch(config)# interface ten 1/1/2
switch(conf-te-1/1/2)# vrf forwarding Green
switch(conf-te-1/1/2)# ip address 10.55.1.2/24
```
4. Configure interface in the source VRF "Red" (using the IP address and subnet mask).
 

```
switch(config)# interface ten 1/1/3
switch(conf-te-1/1/3)# vrf forwarding Red
switch(conf-te-1/1/3)# ip address 10.50.1.2/24
```
5. Navigate to the source VRF address family context for configuring static route leak.
 

```
switch(config)# rbridge-id 1
switch(conf-rbridge-id-1)# vrf mgmt-vrf
switch(conf-vrf-Red)# address-family ipv4 unicast max-route 400
```
6. Configure the route leak for a network (using the IP address and subnet mask), by mentioning the destination next-hop VRF name and the next hop in the destination VRF.
 

```
switch(vrf-ipv4)# ip route 10.55.2.0/24 next-hop-vrf Green 10.55.1.1
```
7. Configure a route leak for the default VRF for a network (using the IP address and subnet mask), by mentioning the destination next-hop VRF name and the default-vrf in the destination VRF.
 

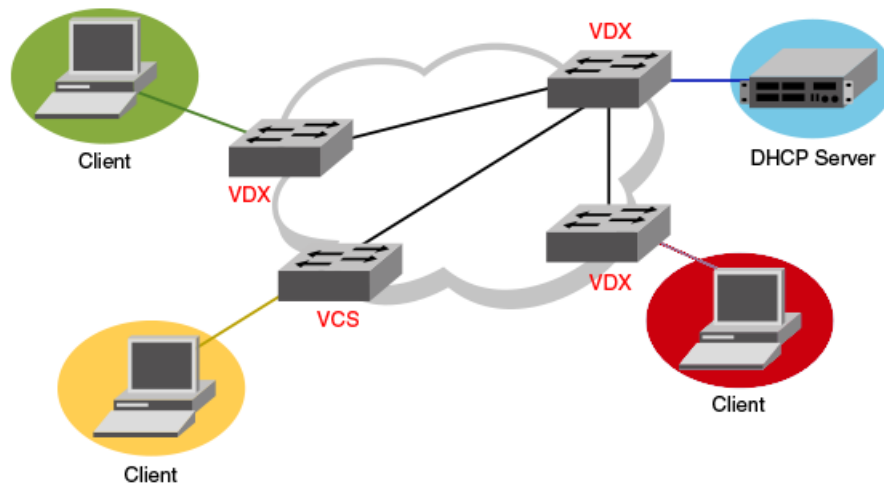
```
switch(vrf-ipv4)# ip route 20.0.0.0/24 next-hop-vrf default-vrf 10.1.1.1
```
8. For bidirectional route leak traffic, configure a route leak from VRF "Green" to VRF "Red".

### ***Inter-VRF route leaking and DHCP relay***

In a DHCP relay setting, route leaking is controlled through a single DHCP server (which may be on a different VRF); this permits multiple VRFs to communicate with that server, something that would normally be not permitted. DHCP Relay deployments in a data center can use Inter-VRF route leaking to achieve server consolidation; this permits clients in multiple VRFs to communicate with a single DHCP server in a different VRF (normally this is not permitted as VRFs provide route/traffic isolation).

The illustration below shows four VRFs, with three of them connecting to the fourth for DHCP services. For more information on working with DHCP IP Relay, refer to [Configuring IP DHCP Relay](#) on page 204.

**FIGURE 25** Inter-VRF route leak example for connecting clients to a DHCP server in a different VRF.



The following example shows setting up Inter-VRF route leaking and DHCP between the red VRF and the blue VRF.

#### **NOTE**

Inter-VRF supports both IPv4 and IPv6 protocol. Use the **ip address** and **ip route** commands for IPv4 protocol and **ipv6 address** and **ipv6 route** commands for IPv6 protocol. Refer to the *Network OS Command Reference*.

#### 1. Set up the VRF forwarding.

```
switch(config)# interface ve 100
switch(conf-ve-100)# no shutdown
switch(conf-ve-100)# vrf forwarding red
  <- interface is in vrf "red" ->
switch(conf-ve-100)# ip address 10.1.1.1/24
switch(conf-ve-100)# ip dhcp relay address 20.1.1.2 use-vrf blue
  <- server is in vrf "blue" ->
```

#### 2. Configure the leaked route on vrf red.

```
switch(config) rbridge-id 1
switch(conf-rbridge-id-1)# vrf red
switch(conf-vrf-red)# address-family ipv4 max-route
switch(vrf-ipv4)#ip route 20.1.1.2/32 next-hop-vrf blue 20.2.1.2
```

## Configuring Dynamic Inter-VRF route leaking

Dynamic Inter-VRF route leaking is a feature which should only be deployed by an advanced user.

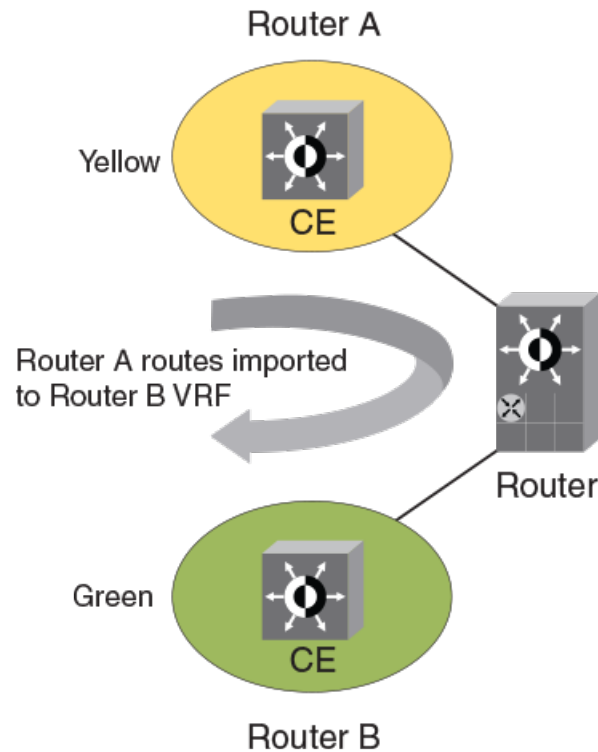
Use the following procedure to set up dynamic Inter-VRF route leaking. Refer to the [Example of Dynamic Inter-VRF route leaking](#) on page 196 for an illustration.

1. Set the switch to global configuration mode.
2. Configure the VRF instances you want to be the leaker (source VRF) and where the route is being leaked to (destination VRF).
3. Specify the interface for the source VRF and map it to the source VRF.
4. Enter the IP address/mask to use for this VRF instance.
5. Specify the interface you want to be the destination VRF and map it to the destination VRF.
6. Specify the IP address/mask to receive the leak.
7. Configure the route map and associated prefix-list.
8. Change the configuration mode to destination VRF address family context. (IPv4 and IPv6 are supported.)
9. Configure the import command, specifying the source VRF and route map to be leaked.

### *Example of Dynamic Inter-VRF route leaking*

In this example, a route map called "import-map" has match criteria specified as prefixes that can be learned via routing protocols such as OSPF or BGP.

The figure below depicts a typical dynamic route leak scenario. VRFs "Yellow" and "Green" are virtual partitions in the same router. The Destination VRF is where the route is being leaked to ("Green"), and the Source VRF is where the route is being leaked from ("Yellow"). In this example, IPv4 is used.

**FIGURE 26** Dynamic Inter-VRF route leaking


1. Configure VRF "Green".
 

```
switch(config)# rbridge-id 1
switch(conf-rbridge-id-1)# vrf Green
switch(conf-vrf-Green)# address-family ipv4 unicast
```
2. Configure VRF "Yellow".
 

```
switch(config)# rbridge-id 1
switch(conf-rbridge-id-1)# vrf Yellow
switch(conf-vrf-Yellow)# address-family ipv4 unicast
```
3. Configure import-prefix.
 

```
switch(config)# rbridge-id 1
switch(config-rbridge-id-1)# ip prefix-list import-prefix permit 10.2.3.0/24
switch(config-rbridge-id-1)# ip prefix-list import-prefix permit 10.1.2.0/24
```
4. Configure route-map.
 

```
switch(config-rbridge-id-1)# route-map import-map permit 10
switch(config-route-map-import-map/permit/10)# match ip address prefix-list import-prefix
```
5. Import the desired route map after first navigating to destination VRF.
 

```
switch(config)# rbridge-id 1
switch(conf-rbridge-id-1)# vrf Green
switch(conf-vrf-Green)# address-family ipv4 unicast
switch(config-ipv4-unicast)# ip import routes Yellow map import-map
```

### ***Commands for Dynamic Inter-VRF route leaking***

Commands you can use to import dynamic routes for Inter-VRF leaking are included in the following table and described in detail in the *Network OS Command Reference*.

**TABLE 3** Dynamic Inter-VRF route leaking commands

Command	Description	Mode
<b>ip import routes</b> <i>vrf_name</i> <b>map</b> <i>rmap_name</i>	Leaks IPv4 routes from a specified VRF to the default VRF, based on match criteria defined in the specified route-map.	RBridge configuration
<b>ip import routes</b> <i>vrf_name</i> <b>map</b> <i>rmap_name</i>	Leaks IPv4 routes from one VRF to another VRF, based on match criteria defined in the specified route-map.	VRF address family configuration
<b>ipv6 import routes</b> <i>vrf_name</i> <b>map</b> <i>rmap_name</i>	Leaks IPv6 routes from a specified VRF to the default VRF, based on match criteria defined in the specified route-map.	RBridge configuration
<b>ipv6 import routes</b> <i>vrf_name</i> <b>map</b> <i>rmap_name</i>	Leaks IPv6 routes from one VRF to another VRF, based on match criteria defined in the specified route-map.	VRF address family configuration
<b>show ip route import</b>	Displays the IPv4 routes imported to a specified VRF.	Privileged EXEC
<b>show ipv6 route import</b>	Displays the IPv6 routes imported to a specified VRF.	Privileged EXEC

## Understanding and using the management VRF

Prior to Network OS release 5.0.0, routers were managed through the default VRF. Any port that was part of the default VRF could be used for management.

### ATTENTION

Beginning with release 5.0.0, support is provided for the management VRF. The default VRF and other user-configured (nondefault) VRFs can no longer be used for router management. This feature is allowed only on management VRF ports.

The management VRF is a dedicated, secure VRF instance that allows users to manage the router inband on switched virtual interfaces (SVIs) and physical interfaces. The name of this VRF instance is "mgmt-vrf;" this instance cannot be deleted.

A management port is any port that is part of the management VRF. By default, the out-of-band (OOB) management port (the eth0 interface) is part of the management VRF. The OOB port cannot be removed from the management VRF. In addition, Layer 3 virtual and physical ports (also known as front-end or in-band ports) can be part of the management VRF. In-band ports can be moved, by means of the CLI, into and out of the management VRF.

Note the following conditions for the management VRF:

- The management VRF does not support Layer 3 protocols. As a result, dynamic routes are not supported.
- DHCP addresses are preferred over static IP addresses on the management interface. If DHCP is disabled, then the static IP address is reconfigured on the eth0 interface.
- For DHCP gateways, the static gateway (route) has precedence over a dynamic gateway (submitted by DHCP).
- The Virtual Cluster Switching (VCS) virtual IP interface must be in the same subnet as the management IP address (eth0:2).
- The chassis IP address is mapped to the active management module (MM) alias interface eth0:1. The active, standby, and chassis IP addresses must be in the same subnet.

- When the MM IP address is deleted, the IP address on eth0 is also deleted.
- As with other VRFs, the management VRF supports overlapping networks.
- Telnet and ssh daemons are not started on default-vrf. This causes in-band management to fail when a switch is upgraded to software version that supports management VRF.

The following matrix summarizes the functionality that is supported and unsupported with the management VRF for the Brocade VDX 6740 series and VDX 8770 series. Note the functionality that is available only through the management VRF. **Y** (Yes) indicates supported; **N** (No) indicates unsupported.

**TABLE 4** Supported and unsupported functionality with the management VRF

VRF type	IP services	Operational/ debug	IPv4/IPv6 addressing, autoconfig	ARP	DHCP relay	DHCP client	Unicast protocols	Multicast protocols	Static routes
	Telnet, SSH, SCP, FTP, SNMP, NetConf	FWDL, supportsave	addressing, autoconfig				OSPF, BGP, VRRP, VRRP-E	IGMP, PIM	
<b>Management</b>									
OOB port	<b>Y</b>	<b>Y</b>	<b>Y</b>	<b>Y</b> (dynamic only)	<b>N</b>	<b>Y</b>	<b>N</b>	<b>N</b>	<b>Y</b>
In-band port	<b>Y</b>	<b>N</b>	<b>Y</b>	<b>Y</b>	<b>N</b>	<b>N</b>	<b>N</b>	<b>N</b>	<b>Y</b>
<b>Default</b>									
Front-end port	<b>N</b>	<b>N</b>	<b>Y</b>	<b>Y</b>	<b>Y</b>	<b>N</b>	<b>Y</b>	<b>Y</b>	<b>Y</b>
<b>Nondefault</b>									
Front-end port	<b>N</b>	<b>N</b>	<b>Y</b>	<b>Y</b>	<b>Y</b>	<b>N</b>	<b>Y</b>	<b>Y</b>	<b>Y</b>

## Configuring management VRFs

This section provides examples of configuring a management VRF interface and configuring routes on the interface, and disabling a management VRF that has been previously configured on a virtual Ethernet (VE) interface. The management VRF is enabled by means of the **vrf forwarding mgmt-vrf** command, and is disabled by means of the **no** form of that command. You can also configure IPv4 routing by means of the **vrf mgmt-vrf** command in RBridge ID configuration mode.

### Enabling a management VRF on an Ethernet interface

The following enables the management VRF on an Ethernet interface and assigns the interface to a subnet.

```
switch(config)# int te 3/0/2
switch(conf-if-te-3/0/2)# vrf forwarding mgmt-vrf
switch(conf-if-te-3/0/2)# ip addr 10.1.1.1/24
```

### Disabling a management VRF on a VE interface

The following disables a management VRF previously configured on a VE interface.

```
switch(config)# int ve 100
switch(conf-Ve-100)# no vrf forwarding
```

### Configuring IPv4 routing for a management VRF on an RBridge interface

#### Adding default routes to a management VRF (IPv4 or IPv6)

The following configures an IPv4 route subnet for the management VRF, enters address family IPv4 configuration mode, and assigns the management VRF to an Ethernet interface.

```
switch(config)# rbridge-id 3
switch(confif-rbridge-id-3)# vrf mgmt-vrf
switch(config-vrf-mgmt-vrf)# address-family ipv4 unicast
switch(vrf-ipv4)# ip route 10.1.1.0/32 te 3/0/10
```

The following adds a default IPv4 route to a management VRF.

```
switch(config)# rbridge-id 122
switch(config-rbridge-id-122)# vrf mgmt-vrf
switch(config-vrf-mgmt-vrf)# address-family ipv4 unicast
switch(vrf-ipv4-unicast)# ip route 0.0.0.0/0 10.20.232.1
```

The following adds a default IPv6 route to a management VRF.

```
switch(config)# rbridge-id 122
switch(config-rbridge-id-122)# vrf mgmt-vrf
switch(config-vrf-mgmt-vrf)# address-family ipv6 unicast
switch(vrf-ipv4-unicast)# ipv6 route ::/0 2620:100:0:fa09::1
```

You can confirm the above by using the **show running-config rbridge-id vrf** command, as in the following example. You must enter **mgmt-vrf** manually.

```
sw0# show running-config rbridge-id 122 vrf mgmt-vrf
rbridge-id 122
vrf mgmt-vrf
  address-family ipv4 unicast
    ip route 0.0.0.0/0 10.20.232.1
  !
  address-family ipv6 unicast
    ipv6 route ::/0 2620:100:0:fa09::1
```

## Managing management VRFs

The **show vrf** command indicates the state (A = active) of the management and default VRFs:

```
switch# show vrf

Total number of VRFs configured: 4
VrfName      VrfId  V4-Ucast  V6-Ucast
Red          3      Enabled   -
default-vrf 1      Enabled   Enabled
mgmt-vrf    0      Enabled   Enabled
re          2      Enabled   -
```



The **show ip interface** command (with the **do** keyword on an Ethernet interface) indicates that the VRF on this interface is a management VRF:

```
switch(conf-if-te-3/0/10)# do show ip int te 3/0/10

TenGigabitEthernet 3/0/10 is up protocol is up
Primary Internet Address is 10.1.1.1/24 broadcast is 10.1.1.255
IP MTU is 1500
Proxy Arp is Enabled
ICMP unreachable are always sent
ICMP mask replies are never sent
IP fast switching is enabled
Vrf : mgmt-vrf
```

The **show arp vrf mgmt-vrf** command (with the **do** keyword on an Ethernet interface) shows the IP and MAC addresses, the related VE interface, and the status of MAC address resolution:

```
switch(conf-if-te-2/0/9)# do show arp vrf mgmt-vrf

Entries in VRF mgmt-vrf : 1
Address          Mac-address      Interface MacResolved Age          Type
-----
10.1.1.10        0010.9400.0001  Ve 100    yes          00:00:03  Dynamic
```

The **show ip route vrf mgmt-vrf** command indicates which networks are part of the management VRF ("mgmt 1"):

```
switch# show ip route vrf mgmt-vrf

Total number of IP routes: 5
Type Codes - B:BGP D:Connected I:ISIS O:OSPF R:RIP S:Static; Cost - Dist/Metric
BGP Codes - i:iBGP e:eBGP
ISIS Codes - L1:Level-1 L2:Level-2
OSPF Codes - i:Inter Area l:External Type 1 2:External Type 2 s:Sham Link

      Destination          Gateway          Port          Cost          Type Uptime
-----
2    0.0.0.0/0              10.24.80.1      mgmt 1        0/0            D     17m9s
3    10.24.80.0/20          DIRECT          mgmt 1        0/0            D     15m41s
4    10.24.82.75/32         DIRECT          mgmt 1        0/0            D     15m41s
5    30.1.1.0/24             DIRECT          Te 3/0/10    0/0            D      0m11
```

# Configuring IP DHCP Relay

---

- DHCP protocol..... 202
- IP DHCP Relay function..... 202
- Brocade IP DHCP relay overview..... 203
- Configuring IP DHCP Relay..... 204
- Displaying IP DHCP relay addresses for an interface..... 206
- Displaying IP DHCP Relay addresses on specific switches..... 207
- Displaying IP DHCP Relay statistics..... 208
- Clearing IP DHCP Relay statistics..... 209
- VRF support..... 210
- High Availability support..... 211

## DHCP protocol

Dynamic Host Configuration Protocol (DHCP) is an IP network protocol that provides network configuration data, such as IP addresses, default routes, DNS server addresses, access control, QoS policies, and security policies stored in DHCP server databases to DHCP clients upon request.

You can enable DHCP service on VDX switches so that they can automatically obtain an Ethernet IP address, prefix length, and default gateway address from the DHCP server. Refer to the “Configuring an IPv4 address with DHCP” section of the *Network OS Administration Guide* for more information.

## IP DHCP Relay function

DHCP relays are an important feature for large networks as they allow communication between DHCP servers and clients located on different subnets.

In small networks with only one IP subnet, DHCP clients can communicate directly with DHCP servers. Clients located on a different subnet than the DHCP server cannot communicate with that server without obtaining an IP address with appropriate routing information.

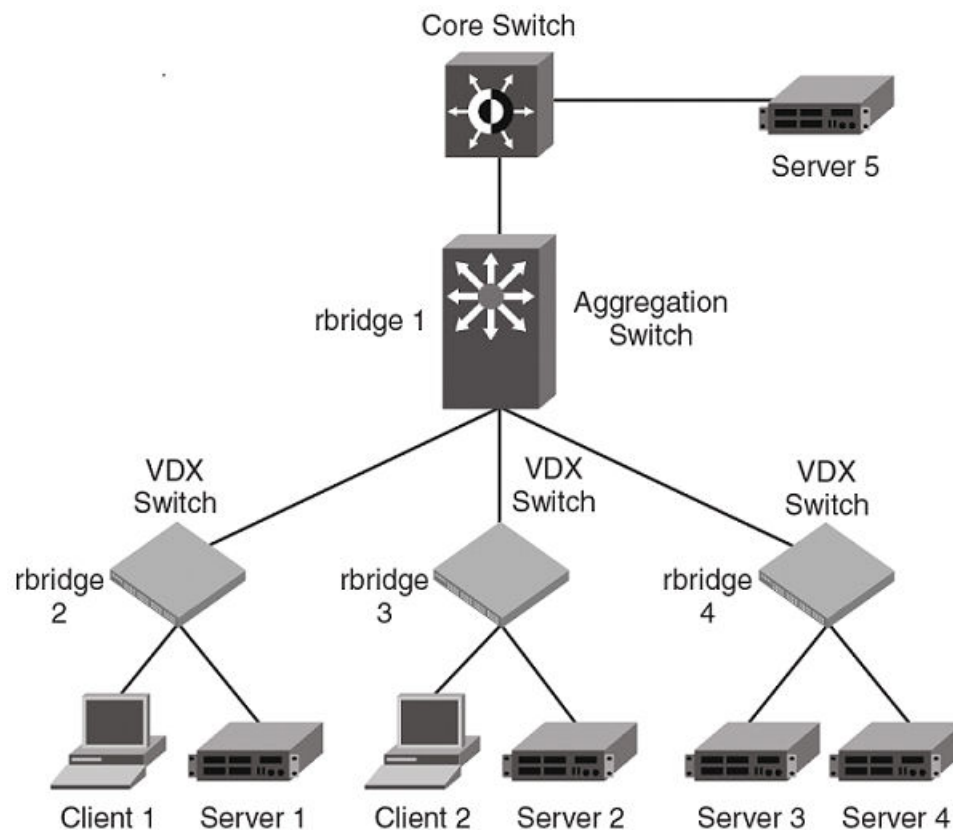
By installing a DHCP relay agent on different subnets in a large network, broadcast DHCP packets can be forwarded from a DHCP client to locate a DHCP server on a remote subnet. The relay agent's IP address is stored in the gateway IP address (GIADDR) field of the DHCP packet. The DHCP server uses the GIADDR field to find the subnet where the relay agent received the broadcast, and then assigns IP addresses to that subnet. The DHCP server replies to the client with a unicast message to the GIADDR address and the relay agent will forward the response to the local network.

## Brocade IP DHCP relay overview

The Brocade IP DHCP relay feature allows forwarding of requests and replies between DHCP servers and clients connected to the switch when these servers and clients are not on the same subnet.

You can configure the Brocade IP DHCP relay feature on any Layer 3 interface to forward requests and replies between DHCP servers and clients connected to the switch when these servers and clients are not on the same subnet. An Layer 3 interface could be the switch front-end Ethernet interface (VE port) or physical interface. The following figure shows an example of a VCS cluster configuration with DHCP servers and clients located on different subnets.

**FIGURE 27** VCS cluster with clients and servers



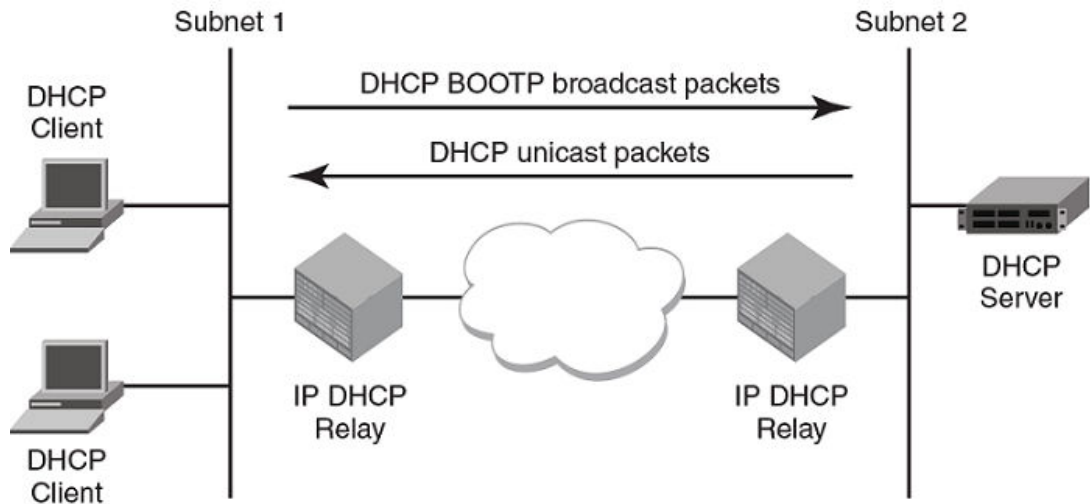
The previous figure illustrates a VCS cluster with clients and servers passing data between different subnets. Note the following examples of configurations supported and not supported by the IP DHCP Relay feature.

Supported configuration examples:

- Local DHCP server. DHCP Client 1 and Server 1 are on the same RBridge, but on different subnets. This configuration supports the IP DHCP Relay feature.
- Remote DHCP server. Client 1 and Server 2 are on different rbridges, but on different subnets. This configuration supports the IP DHCP Relay feature.
- DHCP server across a WAN. Client 1 and Server 5 are on different subnets across the WAN.
- DHCP server is in a different Virtual Routing and Forwarding (VRF) instance. Client 1 and Server 2 are in different VRFs.

The only unsupported configuration is a Network DHCP server. Client 1 is on a different subnet than Server 3 and Server 4, which are on the same subnet.

The Brocade DHCP Relay agent forwards DHCP BOOTP broadcast packets from the DHCP clients to the appropriate server and processes broadcast or unicast packets from the server to forward to the DHCP client. BOOTP is a network protocol used to obtain an IP address from a DHCP server. Refer to the following figure.



## Supported platforms

The IP DHCP Relay feature is supported on specific Brocade VDX platforms.

The IP DHCP Relay feature is supported on the following Brocade platforms:

- VDX 6740, VDX 6740T, and VDX 6740T-1G
- VDX 8770-4 and VDX 8770-8

## Configuring IP DHCP Relay

Configure the IP DHCP Relay agent on any Layer 3 interface using the IP address of the DHCP server where client requests are to be forwarded. Layer 3 interfaces can be a virtual Ethernet (VE) or a physical 1, 10, or 40 Gigabit Ethernet interface.

Configure the IP DHCP Relay agent using the **ip dhcp relay address** command followed by the IP address of the DHCP server. Use the **use-vrf vrf-name** parameter if the DHCP Server and client interface are on different Virtual Forwarding and Routing (VRF) instances.

The following are considerations and limitations when configuring the IP DHCP Relay agent:

- You can configure up to four DHCP server IP addresses per interface. When multiple addresses are configured, the relay agent relays the packets to all server addresses.
- The DHCP server and clients it communicates with can be attached to different VRF instances. When clients and the DHCP server are on different VRFs, use the **use-vrf vrf-name** option with the

**ip dhcp relay address** command, where *vrf-name* is the VRF where the DHCP server is located. For more information on VRF support for the IP DHCP Relay, refer to [VRF support](#) on page 210.

Perform the following steps to configure an IP DHCP Relay:

1. In privileged EXEC mode, enter the **configure terminal** command to enter the global configuration mode.
2. Enter the **interface** command followed by the interface ID to enter the interface configuration mode for the Ve or physical interface where you want to configure the IP DHCP Relay.
3. Enter the **ip dhcp relay address ip-addr use-vrf vrf-name** command where *ip-addr* is the IP address of the DHCP server. Use the **use-vrf vrf-name** option if the DHCP server is on a different VRF instance than the interface where the client is connected.
4. To remove the IP DHCP Relay address enter the **no ip dhcp relay address ip-addr use-vrf vrf-name** command.

The following is an example of configuring two IP DHCP Relay addresses on a physical 1 GbE interface in slot 2, port 4 on RBridge ID 1.

---

#### NOTE

In this example, the local DHCP server IP address is 10.1.1.2.

---

```
switch# config
Entering configuration mode terminal

switch(config)# rbridge-id 1
switch(config-rbridge-id-1)# int Ve 101
switch(config-Ve-101)# ip dhcp relay address 100.1.1.2
switch(config-Ve-101)# ip dhcp relay address 12.3.4.6
switch(config-Ve-101)# ip dhcp relay address 10.1.1.2
```

The following is an example of configuring two IP DHCP Relay addresses on virtual Ethernet interface 102.

---

#### NOTE

In this example, the IP address 3.1.1.255 is the local subnet broadcast address. The relay agent relays the DHCP packets to the directed broadcast address and all addresses for DHCP servers configured on the interface.

---

```
switch# config
Entering configuration mode terminal

switch(config)# rbridge-id 2
switch(config-rbridge-id-2)# int Ve 102
switch(config-Ve-102)# ip dhcp relay address 200.1.1.2
switch(config-Ve-102)# ip dhcp relay address 10.1.1.255
```

To remove an IP DHCP Relay address use the **no** option in the **ip dhcp relay address ip-addr** command as in the following example:

```
switch(config-if)# no ip dhcp relay address 200.1.1.2
```

**Example: DHCP server and client interface on different VRFs**

If the DHCP server is on a different VRF than the interface where the client is connected, use the **use-vrf vrf-name** option in the **ip dhcp relay address ip-addr** command.

---

**NOTE**

If the **use-vrf vrf-name** option is not used, it is assumed that the DHCP server and client interface are on the same VRF.

---

```
switch# config
Entering configuration mode terminal

switch(config)# rbridge-id 2
switch(config-rbridge-id-2)# int Ve 103
switch(config-Ve-103)# ip dhcp relay address 10.1.2.255 use-vrf blue
```

To remove an IP DHCP Relay address use the **no** option in the **ip dhcp relay address ip-addr use-vrf vrf-name** command as in the following example:

```
switch(config-ve-103)# no ip dhcp relay address 10.1.2.255 use-vrf blue
```

## Displaying IP DHCP relay addresses for an interface

You can display IP DHCP relay addresses configured on a specific interfaces of a local switch, specific RBridge, or all RBridge IDs in a logical chassis cluster.

To display the IP DHCP relay addresses configured for a switch interface, use the **show ip dhcp relay address interface** command followed by the interface ID to display IP DHCP relay addresses configured on a specific interface.

1. Access a switch where an IP DHCP relay has been configured on an interface.
2. In privileged EXEC mode, enter the **show ip dhcp relay address interface** command followed by the interface ID.

**Example: Displaying addresses for local switch interfaces**

The following is an example for a 10 GbE interface of a local switch.

```
sw0# show ip dhcp relay address interface te 1/0/24

RBridge Id:      1
-----
Interface      Relay Address      VRF Name
-----
Te 1/0/24      10.3.4.5           Blue
Te 1/0/24      10.5.1.1           Blue
```

**Example: Displaying addresses for a specific interface**

The following is an example for a VE interface on a specific switch (RBridge ID 1).

```
sw0# show ip dhcp rel add int ve 300 rbridge-id 1

RBridge Id:      1
-----
Interface      Relay Address      VRF Name
-----
Ve 300         10.0.1.2           default-vrf
```

**Example: Displaying addresses for specific interfaces on range of switches**

The following is an example for displaying addresses on for a specific VE interface on a range of switches (specified by RBridge IDs) in a logical chassis cluster.

**NOTE**

You can specify a list of RBridge IDs separated by commas, or a range separated by a dash (for example, 1-2). No spaces are allowed in the range string. The range does not need to be contiguous (for example, 1-2,5). You can also specify **all** for all RBridge IDs in the logical chassis cluster.

```
sw0# show ip dhcp rel add int ve
300 rbridge-id 1,3

          RBridge Id:    1
          -----
Interface  Relay Address      VRF Name
-----
Ve 300    10.0.1.2                default-vrf
Ve 300    10.0.0.5                default-vrf

          RBridge Id:    3
          -----
Interface  Relay Address      VRF Name
-----
Ve 300    20.0.1.2                blue
Ve 300    30.1.1.5                green
Ve 300    40.2.1.1                default-vrf
```

## Displaying IP DHCP Relay addresses on specific switches

Use the **show ip dhcp relay address rbridge\_id** command to display all IP DHCP Relay addresses configured on specific switches (specified by RBridge IDs) in a logical chassis cluster. You can use the **all** keyword to display configured addresses on all RBridge IDs in a cluster.

1. Access a switch where an IP DHCP Relay has been configured.
2. In privileged EXEC mode, enter the **show ip dhcp relay address rbridge-id rbridge-id** command.

**Example: Displaying addresses on local RBridge**

The following is an example of displaying addresses configured on interfaces of a local switch. Notice that the RBridge ID is not needed in the command.

```
switch# show ip dhcp relay address

          RBridge Id:    2
          -----
Interface  Relay Address      VRF Name
-----
Te 2/2/1   10.1.1.1            Blue
Te 2/4/2   20.1.1.1            Blue
Te 2/5/4   30.1.1.1            Default-vrf
Te 2/6/6   40.1.1.1            Green
```

**Example: Displaying addresses on specific RBridge**

The following is an example of displaying addresses configured on interfaces on a specific RBridge.

```
switch# show ip dhcp relay address rbridge-id 2

                RBridge Id: 2
                -----
Interface      Relay Address      VRF Name
-----
Te 1/0/24     2.3.4.5             default-vrf
Ve 300        10.0.1.2            default-vrf
```

**Example: Displaying addresses on all RBridges in cluster**

The following is an example of displaying addresses configured on interfaces on all RBridge IDs in a logical chassis cluster.

```
switch# show ip dhcp relay address rbridge-id all

                RBridge Id: 2
                -----
Interface      Relay Address      VRF Name
-----
Te 1/0/24     2.3.4.5             default-vrf
Ve 300        10.0.1.2            default-vrf

                RBridge Id: 3
                -----
Interface      Relay Address      VRF Name
-----
Ve 300        10.0.0.5            default-vrf
```

## Displaying IP DHCP Relay statistics

Display information about the DHCP Relay function, such as the DHCP Server IP address configured on the switch and the number of various DHCP packets received by the interface configured for IP DHCP Relay.

Use the **show ip dhcp relay statistics** command to display the following information about the IP DHCP Relay function:

- DHCP Server IP Address configured in the switch.
- Number of DHCP DISCOVERY, OFFER, REQUEST, ACK, NAK, DECLINE, INFORM, and RELEASE packets received.
- Number of DHCP client packets received (on port 67) and relayed by the Relay Agent.
- Number of DHCP server packets received (on port 68) and relayed by the Relay Agent.

---

**NOTE**

You can specify a list of RBridge IDs separated by commas, or a range separated by a dash (for example, 1-2). No spaces are allowed in the range string. The range does not need to be contiguous (for example, 1-2,5). You can also specify "all" for all RBridge IDs in the logical chassis cluster.

---

1. Access a switch where an IP DHCP Relay has been configured on an interface.
2. In privileged EXEC mode, enter **show ip dhcp relay statistics**. Optionally, you can specify specific RBridge IDs if you only want to view the statistics for those RBridges.



### Displaying statistics on a local switch

The following is an example of displaying statistics on a local switch.

```
sw0# show ip dhcp relay statistics

DHCP Relay Statistics - RBridge Id: 3
-----
Address  Disc.  Offer  Req.  Ack  Nak  Decline  Release  Inform
-----
10.1.0.1  400    100    2972  2968  0     0         0         0
20.2.0.1  400    100    2979  2975  0     0         0         0
30.3.0.1  400    100    3003  2998  0     0         0         0
40.4.0.1  400    100    3026  3018  0     0         0         0

Client Packets: 12780
Server Packets: 12359
```

### Displaying statistics for specific switches

The following is an example of displaying statistics for a cluster with RBridge 1 and RBridge 3.

```
sw0# show ip dhcp relay statistics rbridge-id 1,3

DHCP Relay Statistics - RBridge Id: 1
-----
Address  Disc.  Offer  Req.  Ack  Nak  Decline  Release  Inform
-----
2.3.4.5  300    100    1211  1201  0     0         0         0
10.0.1.2  300    100    1211  1207  0     0         0         0

Client Packets: 2701
Server Packets: 2932

DHCP Relay Statistics - RBridge Id: 3
-----
Address  Disc.  Offer  Req.  Ack  Nak  Decline  Release  Inform
-----
10.0.0.5  0      0      0     0     0     0         0         0
10.0.1.2  0      0      0     0     0     0         0         0

Client Packets: 0
Server Packets: 0
```

## Clearing IP DHCP Relay statistics

Use the **clear ip dhcp relay statistics** command to clear all IP DHCP Relay statistics for specific relay IP addresses, for addresses on specific RBridge IDs, or all addresses for RBridge IDs in a logical chassis cluster.

For command parameters you can specify the IP DHCP Relay address and RBridge IDs. You can specify a list of RBridge IDs separated by commas, or a range separated by a dash (for example, 1-2). No spaces are allowed in the range string. The range does not need to be contiguous (for example, 1-2,5). You can also specify "all" for all RBridge IDs in the logical chassis cluster.

1. Access a switch where an IP DHCP Relay has been configured on an interface.
2. In privileged EXEC mode, issue the **clear ip dhcp relay statistics ip-address ip-address rbridge-id rbridge-id**.

The following command clears statistics for IP DHCP Relay address 10.1.0.1 configured on RBridges 1, 3, and 5.

```
clear ip dhcp relay statistics ip-address 10.1.0.1 rbridge-id 1,3,5
```

The following command clears statistics for all IP DHCP Relay addresses on RBridges 1, 3, and 5.

```
clear ip dhcp relay statistics rbridge-id 1,3,5
```

## VRF support

Virtual Routing and Forwarding (VRF) is a technology that controls information flow within a network by partitioning the network into different logical VRF domains to isolate traffic. This allows a single router or switch to have multiple containers of routing tables or Forwarding Information Bases (FIBs), with one routing table for each VRF instance. This permits a VRF-capable router to function as a group of multiple virtual routers on the same physical router.

Inter-VRF route leaking allows leaking of specific route prefixes from one VRF instance to another on the same physical router, which eliminates the need for external routing. In a DHCP setting, route leaking is controlled through a single DHCP server (which may be on a different VRF). This permits multiple VRFs to communicate with that server.

The IP DHCP Relay is supported in configurations where the DHCP server is on the same or different VRFs than the interface through which the client is connected. When the DHCP server and client are on different VRFs, this is called inter-VRF deployment. For inter-VRF deployment, use the `use-vrf vrf-name` option with the `ip dhcp relay address` command, where `vrf-name` is the VRF where the DHCP server is located.

For more information on VRFs, refer to [Configuring Virtual Routing and Forwarding](#) on page 189.

### Supported VRF configuration examples

Following are examples of VRF configurations that are supported for IP DHCP Relay:

- Client interface and DHCP server are on same VRF. As an example:
  - VE interface 100 in VRF "red"
  - IP address of interface - 3.1.1.1/24
  - IP DHCP Relay address (20.1.1.2) in VRF "red"
- Client interface and DHCP servers are on different VRFs. As an example:
  - VE interface 100 in default VRF
  - IP address of interface - 3.1.1.1/24
  - IP DHCP Relay address (100.1.1.2) in VRF "blue"
  - IP DHCP Relay address (1.2.3.4.6) in VRF "red"

A maximum of 128 of these inter-VRF IP DHCP Relay address configurations is allowed per node. A VRF route leak configuration is required for these configurations. In the preceding example, a VRF route leak configuration is required on the default VRF as follows:

- ip route 100.1.1.2/32 next-hop-vrf blue 100.1.1.2
- ip route 12.3.4.6/32 next-hop-vrf red 14.3.4.6

### VRF configuration examples to avoid

The following examples of VRF configurations are not recommended for IP DHCP Relay.

- The same IP DHCP Relay address configured on different VRFs. As an example:

- VE interface 100 in default VRF
- IP address of interface - 3.1.1.1/24
- IP DHCP Relay address (30.1.1.2) in VRF "blue"
- IP DHCP Relay address (30.1.1.2) in VRF "red"
- The same IP DHCP Relay address configured on two interfaces with the same address, and both interfaces are on different VRFs. As an example:
  - **VE interface 100 in default VRF**
  - IP address of interface - 3.1.1.1/24
  - IP DHCP Relay address (20.1.1.2) in VRF "blue"
  - **VE interface 200 in VRF "blue"**
  - IP address of interface - 3.1.1.1/24
  - IP DHCP Relay address (20.1.1.2) in VRF "blue"

## High Availability support

IP DHCP relay address configurations are maintained when control is switched from the active to the standby management module (MM) in the Brocade VDX 8770-4 and Brocade VDX 8770-8 chassis.

Two management modules (MMs) provide redundancy on the Brocade VDX 8770-4 and Brocade VDX 8770-8 chassis. These modules host the distributed Network OS that provides overall management for the chassis. If the active module becomes unavailable, the standby module automatically takes over management of the system and becomes the active MM. For more information, refer to the "Configuring High Availability" section of the *Network OS Administration Guide*.

IP DHCP relay address configurations are maintained on the new active MM and the MM will continue to relay DHCP packets between DHCP clients and servers. IP DHCP relay statistics will not be maintained, however.

## Configuring IP DHCPv6 Relay

---

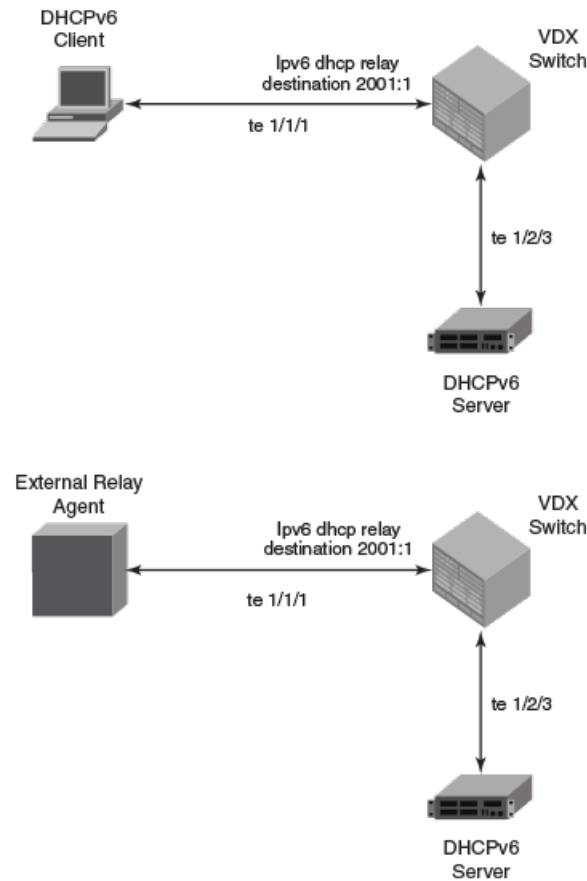
- DHCPv6 relay agent..... 212
- DHCPv6 multicast addresses and UDP ports.....213
- DHCPv6 address assignment..... 214
- DHCPv6 message format..... 215
- DHCPv6 relay provisioning..... 216
- Configuring IPv6 DHCP Relay..... 217
- Displaying DHCPv6 Relay addresses on a specific switch.....218
- Displaying DHCPv6 Relay addresses for an interface.....219
- Displaying IPv6 DHCP Relay statistics..... 220
- Clearing IP DHCPv6 Relay statistics..... 221

### DHCPv6 relay agent

A DHCPv6 relay agent, which may reside on the client's link, is used to relay messages between the client and the server when they are not on the same IPv6 link.

The DHCPv6 relay agent operation is transparent to the client. A DHCPv6 client locates a DHCPv6 server using a reserved, link-scoped multicast address. For direct communication between the DHCPv6 client and the DHCPv6 server, both the client and the server must be attached to the same link. However, in some situations where ease of management, economy, or scalability is a concern, it is desirable to allow a DHCPv6 client to send a message to a DHCPv6 server that is not connected to the same link.

The first figure depicts the relay agent functionality when the relay agent receives DHCP packets from a client on the same link. The second figure depicts the relay agent functionality when the relay agent receives DHCP packets from another relay agent on the same link.

**FIGURE 28** DHCPv6 relay functionality

## DHCPv6 multicast addresses and UDP ports

The relay agent uses specific multicast addresses and UDP ports for the DHCPv6 functionality.

### Multicast addresses

All\_DHCP\_Relay\_Agents\_and\_Servers (FF02::1:2) is a link-scoped multicast address used by the client to communicate with neighboring (for example, on-link) relay agents and servers. All servers and relay agents are members of this multicast group.

All\_DHCP\_Servers (FF05::1:3) is a site-scoped multicast address used by the relay agent to communicate with servers, either because the relay agent wants to send messages to all servers or because it does not know the unicast addresses of the servers. To use this address a relay agent must have an address of sufficient scope to be reachable by the servers. All servers within the site are members of this multicast group.

### UDP ports

The relay agent listens on UDP ports 546 and 547 for packets sent by clients and servers. The relayed packets use the source port 547.

## DHCPv6 address assignment

The DHCPv6 relay agent informs hosts to use one of the following address assignment methods.

### Basic DHCPv6 relay assignment

The DHCPv6 Relay agent relays the DHCP messages from clients and other relay agents to a list of destination addresses, which includes unicast IPv6 addresses, the All\_DHCP\_Servers multicast address, or other user-defined IPv6 multicast group address, on the same VRF as the interface on which the client resides or on a different VRF.

### Stateful DHCPv6

DHCPv6 can be used separately, or in addition to stateless address auto-configuration (SLAAC) to obtain configuration parameters. With stateful DHCPv6, the router can signal the attached clients to use DHCPv6 to acquire an IPv6 address by setting the "O" and "M" bits in the Router Advertisement (RA) message.

The following commands set these bits to support stateful DHCPv6:

**ipv6 nd managed-config-flag** - When set, clients use DHCPv6 for address configuration.

**ipv6 nd other-config-flag** - When set, hosts use DHCPv6 to obtain other (non-address) information when set. Relay forwarding supports these flags.

### Stateless DHCPv6

In stateless DHCPv6, a device uses stateless address auto-configuration (SLAAC) to assign one or more IPv6 addresses to an interface, while it utilizes DHCPv6 to receive additional parameters, such as DNS or NTP server addresses, that may not be available through SLAAC. This is accomplished by setting the "O" bit in the relay agent, using the following CLI:

**ipv6 nd other-config-flag** - When set, hosts use DHCPv6 to obtain other (non-address) information.

### DHCPv6 prefix delegation

The DHCPv6 relay agent relays all the DHCPv6 messages (which may or may not contain the DHCPv6 options) that are to be relayed across the DHCPv6 client and the server. The relay agent will not access or extract the information present in the prefix delegation option.

### Relay chaining

DHCPv6 messages can be relayed through multiple relay agents. The Relay-Reply message from the server will be relayed back to the client in the same path it took to reach the server.

### Relay-message option

The DHCPv6 relay agent includes the relay message option in all the RELAY-FORW messages.

## Remote-ID option

The DHCPv6 relay agent supports the Remote-ID option (option code 37). No user configuration is necessary for this method. The DHCPv6 unique identifier (DUID) of relay agent is used as the remote ID.

## Interface-ID option

The DHCPv6 relay agent supports the Interface-ID option to identify the interface on which the client message was received. No user configuration is necessary for this method.

# DHCPv6 message format

The DHCPv6 message format varies from the DHCPv4 message format. This section describes the events that occur when a DHCPv6 client sends a Solicit message to locate DHCPv6 servers.

- Solicit (1) - A DHCPv6 client sends a Solicit message to locate DHCPv6 servers.
- Advertise (2) - A server sends an Advertise message to indicate that it is available for DHCP service, in response to a Solicit message received from a client.
- Request (3) - A client sends a Request message to request configuration parameters, including IP addresses or delegated prefixes, from a specific server.
- Confirm (4) - A client sends a Confirm message to any available server to determine whether the addresses it was assigned are still appropriate to the link to which the client is connected. This could happen when the client detects either a link-layer connectivity change or if it is powered on and one or more leases are still valid. The confirm message confirms whether the client is still on the same link or whether it has been moved. The actual lease(s) are not validated; just the prefix portion of the addresses or delegated prefixes.
- Renew (5) - A client sends a Confirm message to any available server to determine whether the addresses it was assigned are still appropriate to the link to which the client is connected. This could happen when the client detects either a link-layer connectivity change or if it is powered on and one or more leases are still valid. The confirm message confirms whether the client is still on the same link or whether it has been moved. The actual lease(s) are not validated; just the prefix portion of the addresses or delegated prefixes.
- Rebind (6) - A client sends a Rebind message to any available server to extend the lifetimes on the addresses assigned to the client and to update other configuration parameters; this message is sent after a client receives no response to a Renew message.
- Reply (7) - A server sends a Reply message containing assigned addresses and configuration parameters in response to a Solicit, Request, Renew, Rebind message received from a client. A server sends a Reply message containing configuration parameters in response to an Information-request message. A server sends a Reply message in response to a Confirm message confirming or denying that the addresses assigned to the client are appropriate to the link to which the client is connected. A server sends a Reply message to acknowledge receipt of a Release or Decline message.
- Release (8) - A client sends a Release message to the server that assigned addresses to the client to indicate that the client will no longer use one or more of the assigned addresses.
- Decline (9) - A client sends a Decline message to a server to indicate that the client has determined that one or more addresses assigned by the server are already in use on the link to which the client is connected.
- Reconfigure (10) - A server sends a Reconfigure message to a client to inform the client that the server has new or updated configuration parameters, and that the client needs to initiate a Renew/Reply or Information-request/Reply transaction with the server in order to receive the updated information.

- Information-request (11) - A client sends an Information-request message to a server to request configuration parameters without the assignment of any IP addresses to the client.
- Relay-forward (12) - A relay agent sends a Relay-forward message to relay messages to servers, either directly or through another relay agent. The received message, either a client message or a Relay-forward message from another relay agent, is encapsulated in an option in the Relay-forward message.
- Relay-reply - A server sends a Relay-reply message to a relay agent containing a message that the relay agent delivers to a client. The Relay-reply message may be relayed by other relay agents for delivery to the destination.

**NOTE**

The **show ipv6 dhcp relay statistics** command does not display the show packet count in the statistics for DHCPv6 Advertise and Re-configure messages, as it is sent from the DHCPv6 server to DHCPv6 client directly, not through the relay server.

The table lists the DHCPv4 and DHCPv6 message types:

**TABLE 5** DHCPv4 message versus DHCPv6 message

DHCPv6 message type	DHCPv4 message type
Solicit (1)	DHCPDISCOVER
Advertise (2)	DHCPOFFER
Request (3), Renew (5), Rebind (6)	DHCPREQUEST
Reply (7)	DHCPPACK/DHCPNAK
Release (8)	DHCPRELEASE
Information-Request (11)	DHCPINFORM
Decline (9)	DHCPDECLINE
Confirm (4)	None
Reconfigure (10)	DHCPFORCERENEW
Relay-Forward(12), Relay-Reply (13)	None

## DHCPv6 relay provisioning

Use the scalability numbers in the following table to create and apply the IPv6 DHCP relay configuration on Layer 3 interfaces.

The table lists the scalability numbers for Brocade VDX 8770 and Brocade VDX 6740:

**TABLE 6** Scalability numbers

DHCP configuration	Brocade VDX 8770 (per device)	Brocade VDX 6740 (per device)
Total Number of DHCPv4 server addresses ( <b>ip dhcp relay address</b> )	4000	2000
DHCPv4 server addresses per Interface ( <b>ip dhcp relay address</b> )	16	16



**TABLE 6** Scalability numbers (Continued)

Total number of DHCPv6 server addresses ( <b>ipv6 dhcp relay address</b> )	4000	2000
DHCPv6 server addresses per interface ( <b>ipv6 dhcp relay address</b> )	16	16
Number of inter-VRF client-server configurations for v4 or v6 relay (maximum size of the HSL database for each address family)	128	128
Maximum number of client packets (burst rate-limit ) - client bindings per second	256 packets per second	1000 packets per second

## Configuring IPv6 DHCP Relay

Configure the IPv6 DHCP Relay agent on any Layer 3 (L3) interface using the IP address of the DHCP server where client requests are to be forwarded. L3 interfaces can be a virtual Ethernet (VE) or a physical 1, 10, or 40 GbE interface.

Configure the IPv6 DHCP Relay agent using the **ipv6 dhcp relay address** command followed by the IP address of the DHCP server. Use the **use-vrf vrf-name** parameter if the DHCP server and client interface are on different Virtual Forwarding and Routing (VRF) instances. You can configure up to 16 relay destination addresses per interface.

The following are the considerations when configuring IPv6 DHCP Relay:

- If the relay address is a link local address or a multicast address, an outgoing interface must be configured for IPv6 relay to function.
- In instances where the server address is relayed to a different VRF compared to client connected interface VRF, in addition to the relay address you must also specify the user-vrf, otherwise IPv6 relay may not function correctly.
- IPv6 route leaking is required for IPv6 reachability.
- Use the following commands in addition to the **ipv6 dhcp relay address** command on the layer 3 interface level so that client goes to the BOUND state.

For example, a windows device used as a DHCPv6 client looks for these M and O flags in their received router advertisements before initialization.

```
device (config)# int te 47/8/10
```

```
device (conf-if-te-47/8/10)# ipv6 nd managed-config-flag (When set, clients use the DHCPv6 protocol for address configuration)
```

```
device (conf-if-te-47/8/10)# ipv6 nd other-config-flag (When set, hosts use DHCPv6 to obtain 'other' non-address information)
```

Perform the following steps to configure an IPv6 DHCP Relay:

1. In privileged EXEC mode, issue the **configure terminal** command to enter the global configuration mode.
2. Enter the **interface** command followed by the interface ID to enter the interface configuration mode for the Ethernet or physical interface where you want to configure the IP DHCP Relay.

3. Enter the **ipv6 dhcp relay address ip-addr use-vrf vrf-name** command where *ip-addr* is the IP address of the DHCP server. Use the **use-vrf vrf-name** option if the DHCP server is on a different VRF instance than the interface where the client is connected.
4. To remove the IP DHCP Relay address enter the **no ipv6 dhcp relay address ip-addr use-vrf vrf-name** command.

```
(config)# int ve 100
switch(config-Ve-100)# ipv6 dhcp relay address 2001::1122:AABB:CCDD:3344 use-vrf blue
(config)# int TenGiga 2/3/1
switch(config-if)# ipv6 dhcp relay address fe80::224:38ff:febb:e3c0 interface
tengigabitethernet 2/5
```

## Displaying DHCPv6 Relay addresses on a specific switch

Use the **show ipv6 dhcp relay address rbridge\_id** command to display all IP DHCP Relay addresses configured on specific switches (specified by RBridge IDs) in a logical chassis cluster. You can use the **all** parameter to display configured addresses on all RBridge IDs in a cluster.

1. Access a switch where an IP DHCPv6 Relay has been configured.
2. In privileged EXEC mode, execute the **show ipv6 dhcp relay address rbridge-id rbridge-id** command.

### Example: Displaying addresses on a local RBridge

The following is an example of displaying addresses configured on interfaces of a local switch. Notice that the RBridge ID is not needed in the command.

```
switch# show ipv6 dhcp relay address

                               RBridge Id: 2
                               -----
Interface   Relay Address           VRF Name
Outgoing Interface
-----
-----
Te 2/2/1
4001::101
                               Blue
Te 2/4/2    fe80::8                          Blue
Ve 200      5001:1234:1234:2101:1234:1234:3103:1234 default-vrf
3/0/3
```

---

### NOTE

You can specify a list of RBridge IDs separated by commas, or a range separated by a dash (for example, 1-2). No spaces are allowed in the range string. The range does not need to be contiguous (for example, 1-2,5). You can also specify **all** for all RBridge IDs in the logical chassis cluster.

---

**Example: Displaying addresses on a specific RBridge**

The following is an example of displaying addresses configured on interfaces on a specific RBridge.

```
switch# show ipv6 dhcp relay address rbridge-id 2
```

RBridge Id: 2			
Interface	Relay Address	VRF Name	Outgoing Interface
Te 1/0/24	4001::102	default-vrf	
Ve 300	fe80::9	default-vrf	

**Example: Displaying addresses on all RBridges in a cluster**

The following is an example of displaying addresses configured on interfaces on all RBridge IDs in a logical chassis cluster.

```
switch# show ipv6 dhcp relay address rbridge-id all
```

RBridge Id: 2			
Interface	Relay Address	VRF Name	Outgoing Interface
Te 1/0/24	4001::103	default-vrf	
Ve 300	fe80::9	default-vrf	

RBridge Id: 3		
Interface	Relay Address	VRF Name
Ve 300	5001:1234:1234:2101:1234:1234:3103:1234	default-vrf

## Displaying DHCPv6 Relay addresses for an interface

You can display IPv6 DHCP Relay addresses configured on a specific interfaces of a local switch, specific RBridge, or all RBridge IDs in a logical chassis cluster.

To display the IPv6 DHCP Relay addresses configured for a switch interface, use the **show ipv6 dhcp relay address interface** command followed by the specific interface to display IP DHCP Relay addresses configured on a specific interface.

1. Access a switch where an IP DHCP Relay has been configured on an interface.
2. In privileged EXEC mode, execute the **show ip dhcp relay address interface** command followed by the interface ID.

**Example: Displaying addresses for local switch interfaces**

The following is an example for a 10GbE interface of a local switch.

```
sw0# show ipv6 dhcp relay address interface Te 3/0/21
```

Rbridge Id: 3			
Interface	Relay Address	VRF Name	Outgoing
Te 3/0/21	4001::101	default-vrf	
Te 3/0/21	fe80::8	blue	
ve 100			

**Example: Displaying addresses for a specific interface**

The following is an example for a Virtual Ethernet interface on a specific switch (RBridge ID 1).

```
sw0# show ipv6 dhcp rel add int ve 300 rbridge-id 1
```

Interface	Relay Address	VRF Name	Outgoing Interface
Ve 300	fe80::8	default-vrf	

**Example: Displaying addresses for specific interfaces on range of switches**

The following is an example for displaying addresses on for a specific Virtual Ethernet interface on a range of switches (specified by RBridge IDs) in a logical chassis cluster.

**NOTE**

You can specify a list of RBridge IDs separated by commas, or a range separated by a dash (for example, 1-2). No spaces are allowed in the range string. The range does not need to be contiguous (for example, 1-2,5). You can also specify "all" for all RBridge IDs in the logical chassis cluster.

```
sw0# show ipv6 dhcp rel add int ve 300 rbridge-id 1,3
```

Interface	Relay Address	VRF Name	Outgoing Interface
Ve 300	4001::101	default-vrf	
Ve 300	4001::102	default-vrf	

```
sw0# show ipv6 dhcp rel add int ve 300 rbridge-id 3
```

Interface	Relay Address	VRF Name	Outgoing
Ve 300	2001::1122:AABB:CCDD:3344	blue	
Ve 300	fe80::224:38ff:febb:e3c0	green	
Ve 300	2001::1122:AABB:CCDD:3355	default-vrf	

## Displaying IPv6 DHCP Relay statistics

Display information about the DHCP Relay function, such as the DHCP Server IP address configured on the switch and the number of various DHCP packets received by the interface configured for IP DHCP Relay.

Use the **show ipv6 dhcp relay statistics** command to display the following information about the IPv6 DHCP Relay function:

- Number of SOLICIT, REQUEST, CONFIRM, RENEW, REBIND, RELEASE, DECLINE, INFORMATION-REQUEST, RELAY-FORWARD, RELAY-REPLY packets received.
- Number of RELAY-FORWARD and REPLY packets sent and packets dropped.

**NOTE**

You can specify a list of RBridge IDs separated by commas, or a range separated by a dash (for example, 1-2). No spaces are allowed in the range string. The range does not need to be contiguous (for example, 1-2,5). You can also specify "all" for all RBridge IDs in the logical chassis cluster.

1. Access a switch where an IPv6 DHCP Relay has been configured on an interface.
2. In privileged EXEC mode, enter **show ipv6 dhcp relay statistics**. Optionally, you can specify specific RBridge IDs if you only want to view the statistics for those RBridges.

**Displaying statistics on a local switch**

The following is an example of displaying statistics on a local switch.

```
device# show ipv6 dhcp relay statistics
                                     Rbridge Id: 10
Packets dropped : 0
  Error : 0
Packets received : 60
  SOLICIT : 6
  REQUEST : 6
  CONFIRM : 0
  RENEW : 2
  REBIND : 0
  RELEASE : 6
  DECLINE : 0
  INFORMATION-REQUEST : 0
  RELAY-FORWARD : 0
  RELAY-REPLY : 40
Packets sent : 60
  RELAY-FORWARD : 20
  REPLY : 40
```

**Displaying statistics for specific switches**

The following is an example of displaying statistics on RBridge 10.

```
device# show ipv6 dhcp relay statistics rbridge-id 10
                                     Rbridge Id: 10
Packets dropped : 0
  Error : 0
Packets received : 60
  SOLICIT : 6
  REQUEST : 6
  CONFIRM : 0
  RENEW : 2
  REBIND : 0
  RELEASE : 6
  DECLINE : 0
  INFORMATION-REQUEST : 0
  RELAY-FORWARD : 0
  RELAY-REPLY : 40
Packets sent : 60
  RELAY-FORWARD : 20
  REPLY : 40
```

## Clearing IP DHCPv6 Relay statistics

Use the **clear ip dhcpv6 relay statistics** command to clear all IPv6 DHCP Relay statistics for specific relay IP addresses, for addresses on specific RBridge IDs, or all addresses for RBridge IDs in a logical chassis cluster.

1. Access a switch where an IPv6 DHCP Relay has been configured on an interface.
2. In privileged EXEC mode, issue the **clear ipv6 dhcp relay statistics ip-address *ip-address* rbridge-id *rbridge-id***.

The following command clears statistics for IPv6 DHCP Relay address 10.1.0.1 configured on RBridges 1, 3, and 5.

```
clear ipv6 dhcp relay statistics ip-address 10.1.0.1 rbridge-id 1,3,5
```

# Configuring Dual-Stack Support

---

- [Understanding dual-stack support.....](#) 223
- [Configuring IPv6 addressing and connectivity.....](#) 225
- [Configuring IPv6 Neighbor Discovery.....](#) 232
- [Configuring MLD snooping.....](#) 238
- [Monitoring and managing IPv6 networks.....](#) 245

## Understanding dual-stack support

It is not expected that practical IPv6 implementations will be made without consideration for existing IPv4 networks. Making a transition to IPv6 networks without significant challenges or service disruptions is an incremental, step-by-step process. Interoperability testing must focus, where applicable, on such areas as firewalls, voice service, wireless service, and application-layer interfaces between popular applications and implementation of the IPv6 protocol stack. Care must be taken to test server-side and client-side interoperability not only in pure IPv6 configurations, but also mixed IPv4 and IPv6 configurations, across multiple topologies and vendor platforms.

---

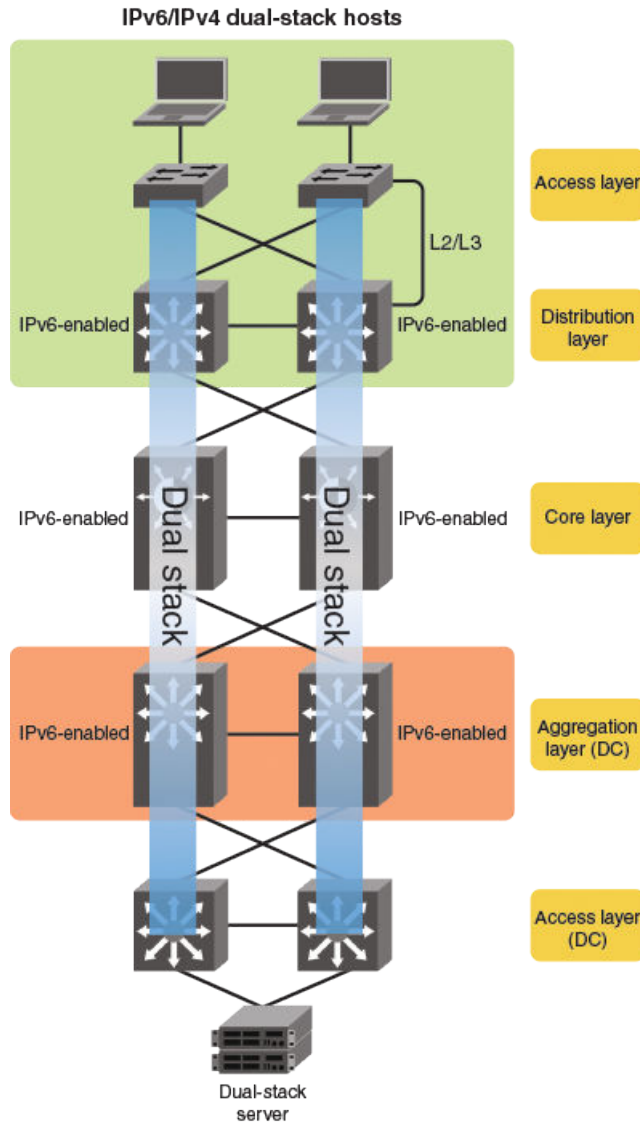
### NOTE

Support for IPv6 is provided on the Brocade VDX 6740 series and the VDX 8770 series. IPv6 functionality is enabled by default.

---

In a data-center network design, depending on the functionality required, switches at both the access layer (if there are no service appliances, such as firewalls, load balancers, and so on at the aggregation layer) and the aggregation layer (if there are appliances hanging off aggregations switches) require IPv6 routing and IPv6/IPv4 termination, as summarized below.

**FIGURE 29** IPv6 dual-stack network



**TABLE 7** Switch requirements to support dual-stack implementations at the access and aggregation layers

Access layer	Aggregation layer
Access switches must provide IPv6/IPv4 termination boundary and IPv6 among switches in east-west and north-south directions.	Aggregation switches must support the following: <ul style="list-style-type: none"> <li>• Policy-Based Routing (PBR)</li> <li>• IPv6-based routing</li> <li>• IPv6/IPv4 termination (if services are based on IPv4)</li> </ul>
Peer aggregation-layer switches must support IPv6-based routing.	

This document does not attempt to provide a detailed discussion of the well-known IPv6 protocol. For details, refer to the following RFCs for the appropriate technology areas.



**TABLE 8** IPv6 RFCs

Technology	RFC	Description	
IPv6 core	6434	IPv6 Node Requirements (a listing of all major RFCs related to IPv6)	
	2460	IPv6 Specification	
	4861/5942	IPv6 Neighbor Discovery	
	2462	IPv6 Stateless Address Auto-Configuration	
	4443	ICMPv6 (replaces RFC 2463)	
	4291	IPv6 Addressing Architecture	
	3587	IPv6 Global Unicast Address Format	
	2375	IPv6 Multicast Address Assignments	
	2464	Transmission of IPv6 over Ethernet Networks	
	2711	IPv6 Router Alert Option	
	3596	DNS Support	
	IPv6 routing	2740	OSPFv3 for IPv6
		2545	Use of BGP-MP Extensions for IPv6
IPv6 multicast	2710	Multicast Listener Discovery (MLD) for IPv6	
	3810	Multicast Listener Discovery Version 2 for IPv6	
	4604	IGMPv3 and MLDv2 for SSM	
	4607	Source-Specific Multicast for IP	
	4601	PIM-SM	
IPv6 transitioning	2893	Transition Mechanisms for IPv6 Hosts and Routers	
	3056	Connection of IPv6 Domains via IPv4 Clouds	
Network management	3176	sFlow	
	5798	VRRP Version 3 for IPv4 and IPv6	

## Configuring IPv6 addressing and connectivity

This section presents a variety of tasks related to the basic addressing, connectivity, and routing functions of IPv6.

### Understanding IPv6 addresses and prefixes

To forward IPv6 traffic on an interface, the interface must have an IPv6 address. IPv6 is enabled globally by default. By default, an IPv6 address is not configured on an interface. When you configure a global IPv6 address, you must decide on one of the following in the low-order 64 bits:

- A manually configured interface ID
- An automatically computed EUI-64 interface ID

If you assign a link-local IPv6 address to the interface, the address is automatically computed for the interface. If preferred, you can override the automatically configured link-local address with an address that you manually configure.

Configuring a global IPv6 address on an interface does the following:

- Automatically configures an interface ID (a link-local address), if specified
- Enables IPv6 on that interface

Additionally, the configured interface automatically joins the following required multicast groups for that link:

- Solicited-node multicast group FF02:0:0:0:1:FF00::/104 for each unicast address assigned to the interface
- All-nodes link-local multicast group FF02::1
- All-routers link-local multicast group FF02::2

The IPv6 Neighbor Discovery feature sends messages to these multicast groups.

The representation of IPv6 address prefixes is similar to that for IPv4 address prefixes written in Classless Inter-Domain Routing (CIDR) notation. An IPv6 address prefix is represented as *ipv6-prefix/prefix-length*, where *ipv6-prefix* is an IPv6 address in any of the notations listed in RFC 4291, and *prefix-length* is a decimal value specifying how many of the left-most contiguous bits of the address comprise the prefix.

For example, the following are legal representations of the 60-bit prefix 20010DB80000CD3 (hexadecimal):

- 2001:0DB8:0000:CD30:0000:0000:0000:0000/60
- 2001:0DB8::CD30:0:0:0:0/60
- 2001:0DB8:0:CD30::/60

Brocade Network OS supports IPv6 prefixes through the **ipv6 address** command and its various options. You must specify the *ipv6-address* parameter in hexadecimal by using 16-bit values between colons as documented in RFC 4291. You must specify the *prefix-length* parameter as a decimal value. A slash mark (/) must follow the *ipv6-address* parameter and precede the *prefix-length* parameter.

Note the following options:

- The **eui-64** keyword configures the global address with an EUI-64 interface ID in the low-order 64 bits. The interface ID is automatically constructed in IEEE EUI-64 format by using the MAC address of the interface. If you do not specify the **eui-64** keyword, you must manually configure the 64-bit interface ID as well as the 64-bit network prefix.
- The optional **secondary** keyword specifies the address as a secondary address.
- The optional **anycast** keyword configures an anycast address for a set of interfaces that belong to different nodes

## Configuring a global IPv6 address with a manually configured interface ID

To configure a global IPv6 address for an interface, including a manually configured interface ID, do the following.

1. In global configuration mode, select an interface.  

```
switch(config)# interface te 3/1/1
```
2. Enter the **ipv6 address** *ipv6-prefix/prefix-length* command in interface subtype configuration mode, as in the following example.  

```
switch(config-if-te-3/1/1)# ipv6 address 2001:200:12d:1300:240:d0ff:fe48:4672/64
```
3. Optionally, you can use the **secondary** keyword with this command to configure one or more secondary addresses, with the following restrictions:
  - You can configure a maximum of 256 secondary addresses.
  - You cannot configure a secondary address on an interface without first configuring a primary address.
  - You cannot delete the primary address (by means of the **no ipv6 address** command) without first deleting all secondary addresses.
  - Secondary addresses are not supported on loopback or management interfaces.

## Configuring a global IPv6 address with an automatically computed EUI-64 interface ID

To configure a global IPv6 address with an automatically computed EUI-64 interface ID in the low-order 64 bits, do the following.

1. In global configuration mode, select an interface.  

```
switch(config)# interface te 3/1/1
```
2. Enter the **ipv6 address** *ipv6-prefix/prefix-length eui-64* command in interface subtype configuration mode, as in the following example.  

```
switch(config-if-te-3/1/1)# ipv6 address 2001:db8:12d:1300::/64 eui-64
```

---

### NOTE

The **eui-64** keyword configures the global address with an EUI-64 interface ID in the low-order 64 bits. The interface ID is automatically constructed in IEEE EUI-64 format by means of the interface's MAC address.

---

3. Optionally, you can use the **secondary** keyword with this command to configure one or more secondary addresses, with the following restrictions:
  - You can configure a maximum of 256 secondary addresses.
  - You cannot configure a secondary address on an interface without first configuring a primary address.
  - You cannot delete the primary address (by means of the **no ipv6 address** command) without first deleting all secondary addresses.
  - Secondary addresses are not supported on loopback or management interfaces.

## Configuring a link-local IPv6 address

To configure a link-local IPv6 address without configuring a global or site-local address for the interface, do the following.

1. In global configuration mode, select an interface.

```
switch(config)# interface te 3/1/1
```

2. Enable IPv6 on the interface. You can configure an automatically computed address (by using the **ipv6 address use-link-local-only** command), or an explicit address (by using the **ipv6 address link-local** command). The latter command overrides the automatically computed address.

- The following configures an automatically computed address:

```
switch(config-if-te-3/1/1)# ipv6 address use-link-local-only
```

- The following configures an explicit address:

```
switch(config-if-te-3/1/1)# ipv6 address fe80::240:d0ff:fe48:4672 link-local
```

---

### NOTE

When configuring VLANs that share a common tagged interface with a virtual Ethernet (VE) interface, it is recommended that you override the automatically computed link-local address with a manually configured unique address for the interface. If the interface uses the automatically computed address, which in the case of VE interfaces is derived from a global MAC address, all VE interfaces will have the same MAC address.

---

## Configuring an IPv6 anycast address

In IPv6, an anycast address is an address for a set of interfaces that belong to different nodes. Sending a packet to an anycast address results in the delivery of the packet to the closest interface that has an anycast address. An anycast address looks similar to a unicast address, because it is allocated from the unicast address space. If you assign an IPv6 unicast address to multiple interfaces, it is an anycast address. On the device, you configure an interface assigned an anycast address to recognize the address as an anycast address.

---

### NOTE

Duplicate address detection (DAD) is not supported for anycast addresses.

---

To configure an anycast address on an interface, do the following.

1. In global configuration mode, select an interface.

```
switch(config)# interface te 3/1/1
```

2. Enter the **ipv6 address ipv6-prefix/prefix-length anycast** command in interface subtype configuration mode, as in the following example.

```
switch(config-if-te-3/1/1)# ipv6 address 2002::6/64 anycast
```

## Configuring IPv4 and IPv6 protocol stacks

If a device is deployed as an endpoint for an IPv6 over IPv4 tunnel, you must configure the device to support IPv4 and IPv6 protocol stacks. Each interface that sends and receives IPv4 and IPv6 traffic must be configured with an IPv4 address and an IPv6 address.

Do the following to configure an interface to support both IPv4 and IPv6 protocol stacks.

1. Select an interface to support dual stacks.  

```
switch(config)# interface te 3/1/1
```
2. Assign an IPv4 address and mask to the interface.  

```
switch(config-if-te-3/1/1)# ip address 192.168.1.1 255.255.255.0
```
3. Assign an IPv6 address with an automatically computed EUI-64 interface ID.  

```
switch(config-if-te-3/1/1)# ipv6 address 2001:200:12d:1300::/64 eui-64
```

## Configuring an IPv6 address family

You can enable IPv6 address-family support for VRF unicast routing, by means of the **address-family ipv6 unicast** command. This allows you to do the following:

- Configure IPv6 static routes in the specified VRF
- Configure IPv6 static neighbors in the specified VRF
- Configure any per-VRF routing-protocol options

Do the following to configure an IPv6 address family.

1. In RBridge ID configuration mode, create a VRF instance.  

```
switch(config-rbridge-id-1)# vrf red
```
2. In VRF configuration mode, enable IPv6 address-family unicast support.  

```
switch(config-vrf-red)# address-family ipv6 unicast
```
3. Specify an interface.  

```
switch(config)# int te 1/0/10
```
4. In interface subtype configuration mode, enable VRF forwarding and specify an IPv6 address and prefix length.  

```
switch(conf-if-te-1/0/10)# vrf forwarding red
switch(conf-if-te-1/0/10)# ipv6 address 1111::1111/64
```

If IPv6 address-family unicast support is not enabled, an error is returned as in the following example.

```
switch(conf-if-te-1/0/10)# rb 1
switch(config-rbridge-id-1)# vrf blue
switch(config-vrf-blue)# int te 1/0/10
switch(conf-if-te-1/0/10)# vrf forwarding blue
switch(conf-if-te-1/0/10)# ipv6 address 1111::2222/64
%% Error: VRF Address Family not configured
```

## Configuring static IPv6 routes

You can configure a static IPv6 route, including an administrative distance, to be redistributed into a routing protocol, but you cannot redistribute routes learned by a routing protocol into the static IPv6 routing table.

You must first enable IPv6 on at least one interface in RBridge ID configuration mode by configuring an IPv6 address or explicitly enabling IPv6 on that interface. Static routes are VRF-specific; they implicitly use the default VRF unless a nondefault VRF is configured (as in the last of the following examples).

The following tasks illustrate a variety of static IPv6 route configurations.

To configure a static IPv6 route with a destination and next-hop gateway address as a global unicast interface, perform the following task in global configuration mode.

1. Enter RBridge ID configuration mode.

```
switch(config)# rbridge-id 54
```

2. Configure a static IPv6 route with a destination and next-hop gateway address as a global unicast interface.

```
switch(rbridge-id-54)# ipv6 route 3ffe:abcd::/64 2001::0011:1234
```

To configure a static IPv6 route with a destination and next-hop gateway address as a global unicast interface with a metric of 10 and an administrative distance of 110, perform the following task in global configuration mode.

1. Enter RBridge ID configuration mode.

```
switch(config)# rbridge-id 54
```

2. Configure a static IPv6 route with a destination and next-hop gateway address as a global unicast interface with a metric of 10 and an administrative distance of 110.

```
switch(rbridge-id-54)# ipv6 route 3ffe:abcd::/64 2001::0011:1234 10 distance 110
```

---

#### NOTE

The value specified for *metric* is used by the Layer 3 switch to compare this route to other static routes in the IPv6 static route table that have the same destination. The metric applies only to routes that the Layer 3 switch has already placed in the IPv6 static route table. Two or more routes to the same destination with the same metric will load share (as in ECMP load sharing). Values range from 1 through 16 with a default of 1.

The value specified by **distance** is used by the Layer 3 switch to compare this route with routes from other route sources that have the same destination. By default, static routes take precedence over routes learned by routing protocols. To choose a dynamic route over a static route, configure the static route with a higher administrative distance than the dynamic route. The range for *number* is from 1 through 255, with a default of 1.

To configure a static IPv6 route with a destination global unicast address and next-hop gateway address on a ten-gigabit Ethernet interface, perform the following task in global configuration mode.

1. Enter RBridge ID configuration mode.

```
switch(config)# rbridge-id 54
```

2. Configure a static IPv6 route with a destination global unicast address and next-hop gateway address.

```
switch(rbridge-id-54)# ipv6 route 2001:db8::0/32 2001:db8:0:ee44::1
```

To configure a static IPv6 route with a destination and next-hop gateway address as a link-local address on an Ethernet interface, perform the following task in global configuration mode.

1. Enter RBridge ID configuration mode.

```
switch(config)# rbridge-id 54
```

2. Configure a static IPv6 route with a destination and next-hop gateway address as a link-local address on an Ethernet interface.

```
switch(rbridge-id-54)# ipv6 route 3001:1234::/64 fe80::1234
```

To configure a static IPv6 route with a destination and next-hop gateway address and cause packets to those addresses to be dropped by shunting them to the "null0" interface, perform the following task in global configuration mode.

1. Enter RBridge ID configuration mode.

```
switch(config)# rbridge-id 54
```

2. Configure a static IPv6 route with a destination and next-hop gateway address and cause packets to those addresses to be dropped by shunting them to the "null0" interface.

```
switch(rbridge-id-54)# ipv6 route 2fe0:1234:5678::/64 null 0
```

---

**NOTE**

This is called "black-holing." It is recommended that this option be used to block undesirable traffic or traffic generated in DoS attacks. Traffic is routed dynamically to a "dead" interface. It can also be directed to a host so that information can be collected for investigation.

---

To configure a static route and next-hop gateway on a virtual Ethernet interface, perform the following task in global configuration mode.

1. Enter RBridge ID configuration mode.

```
switch(config)# rbridge-id 54
```

2. Configure a static route and next-hop gateway on a virtual Ethernet interface.

```
switch(rbridge-id-54)# ipv6 route 2fe0:1234:5678::/64 ve 500
```

To configure a static route in a nondefault VRF, perform the following task in global configuration mode.

1. Enter RBridge ID configuration mode.

```
switch(config)# rbridge-id 54
```

2. Create a nondefault VRF instance, by using the **vrf** command.

```
switch(rbridge-id-54)# vrf network_70
```

3. Enter IPv6 address-family configuration mode, by using the **address-family ipv6 unicast** command.

```
switch(config-vrf-network_70)# address-family ipv6 unicast
```

4. Configure a static route.

```
switch(vrf-ipv6-unicast)# ipv6 route 2000:1000::/64 3100:1000::1245
```

---

**NOTE**

All other static route configurations, either IPv6 or IPv4, are valid under address-family configuration mode for nondefault VRFs.

---

For details of the **show** and **clear** commands for IPv6 routes, refer to [Monitoring and managing IPv6 networks](#) on page 245.

## Changing the IPv6 MTU

The IPv6 MTU is the maximum length in bytes of an IPv6 packet that can be transmitted on a particular interface. If an IPv6 packet is longer than the defined MTU, the originating host breaks the packet into fragments that are shorter than that MTU. Per RFC 2460, the minimum IPv6 MTU for any interface is 1280 bytes; the default maximum is 1500 bytes. You can change the MTU both at the interface level and globally.

---

**NOTE**

If the size of a jumbo frame received on a port is equal to the maximum frame size and this value is greater than the IPv4/IPv6 MTU of the outgoing port, the jumbo frame is forwarded to the CPU.

---

An IPv6 interface can obtain an IPv6 MTU value from any of the following sources:

- Default IPv6 MTU setting
- Global IPv6 MTU setting
- Interface IPv6 MTU setting

An interface determines the actual MTU value as follows:

- If an IPv6 interface MTU value is configured, the configured value is used.
- If an IPv6 interface value is not configured and N IPv6 global MTU value is configured, the configured global value is used.
- If neither an IPv6 interface value nor an IPv6 global MTU value is configured, the default IPv6 MTU value of 1500 is used.

You can specify between [1284 - (*default-max-frame-size*) - 18]. If a nondefault value is configured for an interface, router advertisements include an MTU option. The minimum value you can configure is 1298 \* (IP6\_MIN\_MTU + 18 for Ethernet ports).

To change the IPv6 MTU on an interface, use the **ipv6 mtu** command as in the following example.

```
switch(config)# int te 3/0/1
switch(config-if-te-3/0/1)# ipv6 mtu 1280
```

---

### ATTENTION

To route packets larger than 2500 bytes (the default for an Ethernet interface), you must also use the **mtu** command to set the same MTU value on the interface as that set by the **ipv6 mtu** command. Otherwise packets will be dropped. The range for the **mtu** command is from 1522 through 9219 bytes.

---

## Configuring IPv6 Neighbor Discovery

The Neighbor Discovery feature for IPv6 uses ICMPv6 messages to do the following:

- Determine the link-layer address of a neighbor on the same link
- Verify that a neighbor is reachable

An IPv6 host is required to listen for and recognize the following addresses, which identify this host:

- Link-local address
- Assigned unicast address
- Loopback address
- All-nodes multicast address
- Solicited-node multicast address
- Multicast address to all other groups to which it belongs

You can adjust the following IPv6 Neighbor Discovery features:

- Neighbor Solicitation (NS) messages for duplicate address detection (DAD)
- Router Advertisement (RA) messages:
  - The interval between RA messages
  - A lifetime value that indicates a router is advertised as a default router (for use by all nodes on a given link)
  - Prefixes advertised in RA messages
  - Flags for host stateful autoconfiguration
- The time that an IPv6 node considers a remote node to be reachable (for use by all nodes on a given link)
- NS interval for reachability

Neighbor Discovery configurations are executed at the interface level, by means of a series of **ipv6 nd** commands.



## Neighbor Solicitation and Neighbor Advertisement messages

Neighbor Solicitation (NS) and Neighbor Advertisement (NA) messages enable a node to determine the link-layer address of another node (neighbor) on the same link. [This function is similar to the function provided by the Address Resolution Protocol (ARP) in IPv4.] For example, node 1 on a link wants to determine the link-layer address of node 2 on the same link. To do so, node 1, the source node, multicasts a NS message. The NS message, which has a value of 135 in the Type field of the ICMP packet header, contains the following information:

- **Source address:** IPv6 address of node 1 interface that sends the message

---

### NOTE

The source address is unspecified for DAD.

- **Destination address:** Solicited-node multicast address (FF02:0:0:0:1:FF00::/104) that corresponds the IPv6 address of node 2

---

### NOTE

For unicast NS traffic, the destination address is the IPv6 address of the destination. For non-unicast NS traffic, the destination address is the solicited-node's multicast address.

- Link-layer address of node 1
- A query for the link-layer address of node 2

After receiving the NS message from node 1, node 2 replies by sending an NA message, which has a value of 136 in the Type field of the ICMP packet header. The NS message contains the following information:

- **Source address:** IPv6 address of the node 2 interface that sends the message

---

### NOTE

For solicited advertisements, this is the source address of an invoking NS. Alternatively, if the source address of the NS is the unspecified address, this is the all-nodes multicast address.

- **Destination address:** IPv6 address of node 1
- Link-layer address of node 2

After node 1 receives the NA message from node 2, nodes 1 and 2 can now exchange packets on the link.

After the link-layer address of node 2 is determined, node 1 can send NS messages to node 2 to verify that it is reachable. Also, nodes 1, 2, or any other node on the same link can send a NA message to the all-nodes multicast address (FF02::1) if there is a change in their link-layer address.

## Router Advertisement and Router Solicitation messages

Router Advertisement (RA) and Router Solicitation (RS) messages enable a node on a link to discover the routers on the same link.

RA messages are sent periodically by a router to provide the following information to hosts:

- Router information such as link-layer address and lifetime of the prefix
- IPv6 prefixes for address autoconfiguration
- Network information such as MTU and hop limit
- Additional information such as reachable time, retransmission time for neighbor solicitations

Each configured interface on a link periodically sends out an RA message, which has a value of 134 in the Type field of the ICMP packet header, to the all-nodes link-local multicast address (FF02::1).

A configured interface can also send a RA message in response to an RS message from a node on the same link. This message is sent to the unicast IPv6 address of the node that sent the RS message.

At system startup, a host on a link sends an RS message to the all-routers multicast address (FF02::2). Sending an RS message, which has a value of 133 in the Type field of the ICMP packet header, immediately enables the host to configure its IPv6 address automatically, instead of having to wait for the next periodic RA message.

Because a host at system startup typically does not have a unicast IPv6 address, the source address in the RS message is usually the unspecified IPv6 address (::). If the host has a unicast IPv6 address, the source address is the unicast IPv6 address of the host interface that sends the RS message.

You can configure a variety of RA message parameters at the interface level.

## Neighbor Redirect messages

After forwarding a packet, by default a router can send a Neighbor Redirect (NR) message to a host to inform it of a "better" first-hop router. The host receiving the NR message will then readdress the packet to the better router.

A device sends an NR message only for unicast packets, only to the originating node, and to be processed by the node.

An NR message has a value of 137 in the Type field of the ICMP packet header.

## Duplicate address detection (DAD)

IPv4 nodes use ARP Request messages and a method called *gratuitous ARP* to detect a duplicate unicast IPv4 address on the local link. Similarly, IPv6 nodes use Neighbor Solicitation messages to detect the use of duplicate addresses on the local link in a process known as *duplicate address detection (DAD)*, as described in RFC 4862.

With IPv4 gratuitous ARP, the Source Protocol Address and Target Protocol Address fields in the ARP Request message header are set to the IPv4 address for which duplication is being detected. In IPv6 DAD, the Target Address field in the Neighbor Solicitation (NS) message is set to the IPv6 address for which duplication is being detected. DAD differs from address resolution in the following ways:

- In the DAD NS message, the Source Address field in the IPv6 header is set to the unspecified address (::). The address being queried for duplication cannot be used until it is determined that there are no duplicates.
- In the Neighbor Advertisement (NA) reply to a DAD NS message, the Destination Address in the IPv6 header is set to the link-local all-nodes multicast address (FF02::1). The Solicited flag in the NA message is set to 0. Because the sender of the DAD NS message is not using the desired IP address, it cannot receive unicast NA messages. Therefore, the NA message is multicast.
- Upon receipt of the multicast NA message with the Target Address field set to the IP address for which duplication is being detected, the node disables the use of the duplicate IP address on the interface. If the node does not receive an NA message that defends the use of the address, it initializes the address on the interface.

An IPv6 node does not perform DAD for anycast addresses. Anycast addresses are not unique to a node. Network OS does not perform DAD for IPv6 addresses configured on loopback interfaces.

Although the stateless autoconfiguration feature assigns the 64-bit interface ID portion of an IPv6 address by using the MAC address of the host's NIC, duplicate MAC addresses can occur. Therefore,

the DAD feature verifies that a unicast IPv6 address is unique before it is assigned to a host interface by the stateless autoconfiguration feature. DAD verifies that a unicast IPv6 address is unique.

If DAD identifies a duplicate unicast IPv6 address, the address is not used. If the duplicate address is the link-local address of the host interface, the interface stops processing IPv6 packets.

## Setting Neighbor Solicitation parameters for DAD

Although the stateless autoconfiguration feature assigns the 64-bit interface ID portion of an IPv6 address by using the MAC address of the host's NIC, duplicate MAC addresses can occur. Therefore, the duplicate address detection (DAD) feature verifies that a unicast IPv6 address is unique before it is assigned to a host interface by the stateless autoconfiguration feature. DAD verifies that a unicast IPv6 address is unique.

If DAD identifies a duplicate unicast IPv6 address, the address is not used. If the duplicate address is the link-local address of the host interface, the interface stops processing IPv6 packets.

You can configure the following Neighbor Solicitation (NS) message parameters that affect DAD while it verifies that a tentative unicast IPv6 address is unique:

- The number of consecutive NS messages that DAD sends on an interface. By default, DAD sends two NS messages without any follow-up messages.
- The interval in seconds at which DAD sends a NS message on an interface. By default, DAD sends an NS message every 1 second.

---

### NOTE

For the interval at which DAD sends an NS message on an interface, the router uses seconds as the unit of measure instead of milliseconds.

---

For example, to change the number of NS messages sent on Ethernet interface 3/1/1 to 3 and the interval between the transmission of the two messages to 4 seconds, do the following

1. In global configuration mode, select an interface.  

```
switch(config)# interface te 3/1/1
```
2. Enter the **ipv6 nd dad attempt *number*** command to set the number of solicitation messages sent on the interface.  

```
switch(config-if-te-3/1/1)# ipv6 nd dad attempt 3
```

---

### NOTE

To disable DAD on an interface, set the number of attempts to 0.

---

3. Enter the **ipv6 nd dad time *seconds*** command to set the interval between the messages.  

```
switch(config-if-te-3/1/1)# ipv6 nd dad time 4
```

---

### NOTE

It is recommended that you do not specify intervals that are very short in normal IPv6 operation. When a nondefault interval value is configured, that interval is both advertised and used by the router itself.

---

## Configuring IPv6 static neighbor entries

In some cases a neighbor cannot be reached by means of Neighbor Discovery. To resolve this you can add a static entry to the ND cache, causing a neighbor to be reachable at all times. (A static IPv6 ND entry is like a static IPv4 ARP entry.)

For example, use the **ipv6 neighbor** command in interface subtype configuration mode to add a static entry for a neighbor with IPv6 address 2001:db8:2678::2 and link-layer address 0000.002b.8641, reachable through interface te 3/0/1.

```
switch(config-if-te-3/0/1)# ipv6 neighbor 2001:db8:2678::2 0000.002b.8641
```

## Setting IPv6 Router Advertisement parameters

You can adjust the following parameters for Router Advertisement (RA) messages:

- The interval (in seconds) at which an interface sends RA messages. By default, an interface sends an RA message randomly, every 200 to 600 seconds.
- The "router lifetime" value, which is included in RA messages sent from a particular interface. The value (in seconds) indicates whether the router is advertised as a default router on this interface. If you set the value of this parameter to 0, the router is not advertised as a default router on an interface. If you set this parameter to a value that is not 0, the router is advertised as a default router on this interface. By default, the router lifetime value included in router advertisement messages sent from an interface is 1800 seconds.

---

### NOTE

When adjusting these parameter settings, it is recommended that you set the interval between router advertisement transmission to be less than or equal to the router lifetime value if the router is advertised as a default router.

---

For example, to adjust the interval of router advertisements to specify the range matching the configuration and the router lifetime value to 1900 seconds on an interface, enter the following commands.

1. In global configuration mode, select an interface.  

```
switch(config)# interface te 3/1/1
```
2. Enter the **ipv6 nd ra-interval** command to set a maximum interval range and minimum interval at which RA messages are sent.  

```
switch(config-if-te-3/1/1)# ipv6 nd ra-interval 1200 min 400
```
3. Enter the **ipv6 nd ra-lifetime** *number* command to set the RA message lifetime.  

```
switch(config-if-te-3/1/1)# ipv6 nd ra-lifetime 1900
```
4. Enter the **ipv6 nd hoplimit** command to specify a nondefault hop limit.  

```
switch(config-if-te-3/1/1)# ipv6 nd hoplimit 32
```
5. Enter the **ipv6 nd mtu** command to specify a nondefault MTU.  

```
switch(config-if-te-3/1/1)# ipv6 nd mtu 2400
```

## Controlling prefixes advertised in IPv6 Router Advertisement messages

By default, Router Advertisement (RA) messages include prefixes configured as addresses on interfaces by means of the **ipv6 address** command. You can use the **ipv6 nd prefix** command to control exactly which prefixes are included in RA messages. The prefix is associated with a valid, preferred lifetime. For a prefix derived from the global address, the lifetime value is infinite (0xFFFFFFFF).

RA messages also use the following parameters:

- **Valid lifetime -- (Mandatory)** The time interval (in seconds) in which the specified prefix is advertised as valid. The default is 2592000 seconds (30 days). When the timer expires, the prefix is no longer considered to be valid.
- **Preferred lifetime -- (Mandatory)** The time interval (in seconds) in which the specified prefix is advertised as preferred. The default is 604800 seconds (7 days). When the timer expires, the prefix is no longer considered to be preferred.
- **Onlink flag -- (Optional)** If this flag is set, the specified prefix is assigned to the link upon which it is advertised. Nodes sending traffic to addresses that contain the specified prefix consider the destination to be reachable on the local link.
- **Autoconfiguration flag -- (Optional)** If this flag is set, the stateless autoconfiguration feature can use the specified prefix in the automatic configuration of 128-bit IPv6 addresses for hosts on the local link.

The following illustrates the execution of the **ipv6 nd prefix** command.

1. In global configuration mode, select an interface.  

```
switch(config)# interface te 3/1/1
```
2. Enter the **ipv6 nd prefix** command and specify a prefix and prefix length.  

```
switch(config-if-te-3/1/1)# ipv6 nd prefix 2ffe:1111::/64
```

---

### NOTE

Valid and preferred lifetimes are default values, which are 2592000 and 604800, respectively.

---

## Setting flags in IPv6 Router Advertisement messages

An IPv6 Router Advertisement (RA) message can include the following flags:

- **Managed Address Configuration --** This flag indicates to hosts on a local link whether they should use the stateful autoconfiguration feature to get IPv6 addresses for their interfaces. If the flag is set, the hosts use stateful autoconfiguration to get addresses as well as non-IPv6-address information. If the flag is not set, the hosts do not use stateful autoconfiguration to get addresses, and whether the hosts can get information that is not address-related from stateful autoconfiguration is determined by the setting of the Other Stateful Configuration flag.
- **Other Stateful Configuration --** This flag indicates to hosts on a local link whether they can autoconfigure information that is not address-related. If the flag is set, the hosts can use stateful autoconfiguration to get non-IPv6-address information.

---

### NOTE

When determining whether hosts can use stateful autoconfiguration to get non-IPv6-address information, use a Managed Address Configuration flag to override an unset Other Stateful Configuration flag. In this situation, the hosts can obtain non-IPv6-address information. However, if the

Managed Address Configuration flag is not set and the Other Stateful Configuration flag is set, then the setting of the Other Stateful Configuration flag is used.

---

By default, the Managed Address Configuration and Other Stateful Configuration flags are not set in RA messages. For example, to set these flags in router advertisement messages sent from an interface, enter the following commands.

1. In global configuration mode, select an interface.  

```
switch(config)# interface te 3/1/1
```
2. Enter the **ipv6 nd managed-config-flag** command to enable hosts on a local link to use stateful autoconfiguration to get addresses as well as non-IPv6-address information.  

```
switch(config-if-te-3/1/1)# ipv6 nd managed-config-flag
```
3. Enter the **ipv6 nd other-config-flag** command to enable hosts on a local link to use stateful autoconfiguration non-IPv6-address information.  

```
switch(config-if-te-3/1/1)# ipv6 nd other-config-flag
```

## Configuring MLD snooping

A Layer 2 switch forwards all multicast control packets and data received on all the member ports of a VLAN interface. This approach, though simple, is not bandwidth efficient, because only a subset of member ports may be connected to devices interested in receiving those multicast packets. In the worst-case scenario the data are forwarded to all port members of a VLAN with a large number of member ports, even if only a single VLAN member is interested in receiving the data. Such scenarios can lead to loss of throughput for a switch when it receives high-rate multicast data traffic.

Multicast Listener Discovery (MLD) snooping is a multicast-constraining mechanism that runs on Layer 2/Layer3 devices to manage and control IPv6 multicast groups. MLD snooping provides functionality for IPv6 that is similar to IGMP snooping for IPv4, by sending IPv6 multicast traffic only to interested listeners. By listening to and analyzing MLD messages, a Layer 2 device running MLD snooping establishes mappings between ports and multicast MAC addresses or multicast IP addresses, and forwards multicast data accordingly. Multicast routers in a network are found by means of either static configuration, dynamic learning, or PIM hello-based mrouter detection.

---

### NOTE

This release supports the IPv6 version of MLDv1 snooping for devices in both logical chassis and fabric cluster modes.

---

In any given subnet, one multicast router is elected to act as an MLD querier. The MLD querier sends out the following types of queries to hosts:

- **General query:** Querier asks whether any host is listening to any group.
- **Group-specific query:** Querier asks whether any host is listening to a specific multicast group. This query is sent in response to a host leaving the multicast group and allows the router to determine quickly whether any remaining hosts are interested in the group.

Hosts that are multicast listeners send the following kinds of messages:

- **Report message:** Indicates that the host wants to join a particular multicast group.
- **Done message:** Indicates that the host wants to leave a particular multicast group.

MLD traffic is forwarded as follows:

- MLD general queries received on a multicast-router interface are forwarded to all other interfaces in the VLAN.
- MLD group-specific queries received on a multicast-router interface are forwarded to only those interfaces in the VLAN that are members of the group.
- MLD report or done messages received on a host interface are forwarded to multicast-router interfaces in the same VLAN, but not to other host interfaces in the VLAN.
- Proxy MLD membership reports received with a null source IP address are accepted, to support report suppression.
- All unrecognized MLD packets are flooded to all (STP) unblocked member ports of the VLAN, to ensure that no data traffic is black-holed.

Data forwarding rules ensure that the multicast traffic received at the switch is forwarded to all interested downstream port members. Forwarding rules can be based on either Layer 3 multicast destination IP group address or Layer 2 destination MAC address.

- If a switch is already in a learned multicast group, multicast packets are forwarded only to those host interfaces in the VLAN that are members of the multicast group and to all multicast-router interfaces in the VLAN.
- If a switch is not in a learned multicast group, multicast packets for a group that has no current members are flooded to all member ports of the VLAN, as well as to all multicast-router interfaces in the VLAN. This behavior depends on whether the restrict-unknown-multicast feature, available only for multicast profiles, is enabled or not. (The default behavior is to flood packets on all ports. Refer to [Restricting unknown multicast](#) on page 35.) When it is enabled, multicast packets for a group that has no current members are forwarded to all multicast-router interfaces in the VLAN.

---

#### NOTE

For this release, Brocade VDX devices use Layer 2 multicast destination-MAC-address-based forwarding.

---

MLD snooping supports the following scale numbers:

**TABLE 9** MLD snooping scale numbers

Parameter	Maximum
Number of IPv6 multicast snooping flows	4000
Number of VLANs	256
Groups learning rate	512/sec

The remainder of this section presents the tasks related to MLD configuration that are supported in this release.

## Enabling and disabling MLD snooping globally

---

#### NOTE

The global and interface (VLAN) configurations of IPv6 MLDv1 Layer 2 snooping are independent of each other. However, MLD snooping must first be enabled globally for it to be enabled on a VLAN. (By default, snooping is disabled on VLANs.) If MLD snooping is disabled globally, the VLAN-level snooping configurations are retained in the running configuration but their functionality is disabled.

---

Do the following to enable and disable MLD snooping globally, respectively.

1. Enable MLD snooping globally.  
`switch(config)# ipv6 mld snooping enable`
2. Disable MLD snooping globally.  
`switch(config)# no ipv6 mld snooping enable`

## Enabling and disabling MLD snooping at the interface level

---

### NOTE

The global and interface (VLAN) configurations of IPv6 MLDv1 Layer 2 snooping are independent of each other. However, MLD snooping must first be enabled globally for it to be enabled on a VLAN. (By default, snooping is disabled on VLANs.) If MLD snooping is disabled globally, the VLAN-level snooping configurations are retained in the running configuration but their functionality is disabled.

---

Do the following to enable and disable MLD snooping on a VLAN, respectively.

1. Enable MLD snooping on a VLAN.  
`switch(config)# int vlan 2000`  
`switch(config-Vlan-2000)# ipv6 mld snooping enable`
2. Disable MLD snooping on a VLAN.  
`switch(config)# int vlan 2000`  
`switch(config-Vlan-2000)# no ipv6 mld snooping enable`

## Enabling and disabling MLD querier functionality on a VLAN

To enable this functionality, use the **ipv6 mld snooping querier enable** command on a VLAN interface, as in the following example:

```
switch(config-Vlan-2000)# ipv6 mld snooping querier enable
```

To disable this functionality, use the **no ipv6 mld snooping querier enable** command on a VLAN interface, as in the following example:

```
switch(config-Vlan-2000)# no ipv6 mld snooping querier enable
```

## Configuring and unconfiguring an MLD static group on a VLAN

To enable this functionality, use the **ipv6 mld static-group** command on a VLAN interface, then select a multicast address to be joined, as well as a physical interface, as in the following example:

```
switch(config-Vlan-2000)# ipv6 mld static-group ff1e::1 int te 54/0/1
```

To disable this functionality, use the **no ipv6 mld static-group** command on a VLAN interface, as in the following example:

```
switch(config-Vlan-2000)# no ipv6 mld static-group ff1e::1 int te 54/0/1
```



## Enabling and disabling MLD fast-leave on a VLAN

MLD fast-leave allows a group entry to be removed immediately from the receiver as soon as a done message is received, as long as the receiver is the only one on the segment that is subscribed to a group. This minimizes the leave latency of group memberships on an interface, as the device does not send group-specific queries. As a result, the group entry is removed from the multicast forwarding table as soon as a group done (leave) message is received.

---

### NOTE

Use this command only if there is one receiver behind the interface for a given group.

---

Use the **ipv6 mld snooping fast-leave** command on a VLAN interface to enable this feature, as in the following example.

```
switch(config-Vlan-2000)# ipv6 mld snooping fast-leave
```

Use the **no ipv6 mld snooping fast-leave** command on a VLAN interface to disable this feature, as in the following example.

```
switch(config-Vlan-2000)# no ipv6 mld snooping fast-leave
```

## Configuring the MLD query interval

You can configure the frequency at which MLD host query messages are sent. Larger values cause queries to be sent less often.

To set the MLD query interval, use the **ipv6 mld query-interval** command on a VLAN interface, as in the following example:

```
switch(config-Vlan-2000)# ipv6 mld query-interval 1200
```

---

### NOTE

The value set by this command must be greater than the query maximum response time, set by the **ipv6 mld query-max-response-time** command. Refer to the *Network OS Command Reference* for all ranges and defaults for the commands in this section.

---

To restore the default value, use the **no ipv6 mld query-interval** command on a VLAN interface, as in the following example:

```
switch(config-Vlan-2000)# no ipv6 mld query-interval
```

## Configuring the MLD last-member query interval

You can set the frequency at which MLD last-member query messages are sent. This is the interval for the response to a query sent after a host leave message is received from the last known active host on the subnet. The group is deleted if no reports are received in this interval. This interval adjusts the speed at which messages are transmitted on the subnet. Smaller values detect the loss of a group member faster.

---

### NOTE

If this interval is not configured explicitly, the value is taken from the robustness variable.

---

To set the MLD last-member query interval, use the **ipv6 mld last-member-query-interval** command on a VLAN interface, as in the following example:

```
switch(config-Vlan-2000)# ipv6 mld last-member-query-interval 1500
```

To restore the default value, use the **no ipv6 mld last-member-query-interval** command on a VLAN interface, as in the following example:

```
switch(config-Vlan-2000)# no ipv6 mld last-member-query-interval
```

## Configuring the MLD last-member query count

You can set the number of times that an MLD query is sent in response to a host leave message. This is the number of times, separated by the last-member query-response interval (configured by the **ipv6 mld last-member-query-interval** command), that an MLD query is sent in response to a host leave message from the last known active host on the subnet.

---

### NOTE

If this interval is not configured explicitly, the value is taken from the robustness variable.

---

To change the MLD last-member query count from the default, use the **ipv6 mld last-member query count** command on a VLAN interface, as in the following example:

```
switch(config-Vlan-2000)# ipv6 mld last-member-query-count 3
```

To restore the default value, use the **no ipv6 mld last-member-query-count** command on a VLAN interface, as in the following example:

```
switch(config-Vlan-2000)# no ipv6 mld last-member-query-count
```

## Configuring the MLD query maximum response time

You can configure the maximum response time for IPv6 MLDv1 snooping MLD queries for a specific VLAN interface, as in the following example:

```
switch(config)# int vlan 2000
switch(config Vlan-2000)# ipv6 mld query-max-response-time 15
```

---

### NOTE

Larger values spread out host responses over a longer time. The value set by this command must be less than the general query interval, set by the **ipv6 mld query-interval** command.

---

To restore the default value, use the **no ipv6 mld query-max-response-time** command on a VLAN interface, as in the following example:

```
switch(config-Vlan-2000)# no ipv6 mld query-max-response-time
```

## Configuring the MLD snooping robustness variable

To change the default robustness variable on a VLAN, use the **ipv6 mld snooping robustness-variable** command, as in the following example:

```
switch(config-Vlan-2000)# ipv6 mld snooping robustness-variable 7
```

To restore the default value, use the **no ipv6 mld robustness-variable** command on a VLAN interface, as in the following example:

```
switch(config-Vlan-2000)# no ipv6 mld robustness-variable
```

## Configuring the MLD startup query count

Do the following to change the startup-query interval on a VLAN, as in the following example.

```
switch(config-Vlan-2000)# ipv6 mld startup-query-count 2
```

To restore the default value, use the **no ipv6 mld startup-query-count** command on a VLAN interface, as in the following example:

```
switch(config-Vlan-2000)# no ipv6 mld startup-query-count
```

## Configuring the MLD startup query interval

Do the following to change the startup-query interval on a VLAN, as in the following example.

```
switch(config-Vlan-2000)# ipv6 mld startup-query-interval 2
```

To restore the default value, use the **no ipv6 mld startup-query-interval** command on a VLAN interface, as in the following example:

```
switch(config-Vlan-2000)# no ipv6 mld startup-query-interval
```

## Configuring a VLAN port member to be a multicast router port

To configure a VLAN port member to be a multicast router (mrouter) port., use the **ipv6 mld snooping mrouter interface** command on a VLAN interface, as in the following example:

```
switch(config-Vlan-2000)# ipv6 mld snooping mrouter interface te 54/0/1
```

To disable the VLAN port member from being an mrouter port., use the **ipv6 mld snooping mrouter interface** command on a VLAN interface, as in the following example:

```
switch(config-Vlan-2000)# no ipv6 mld snooping mrouter interface te 54/0/1
```

## Managing the flooding of multicast data traffic

To deactivate the flooding of unregistered multicast data traffic, use the **ipv6 mld snooping restrict-unknown-multicast** command on a VLAN interface, as in the following example:

```
switch(config-Vlan-2000)# ipv6 mld snooping restrict-unknown-multicast
```

To reactivate the flooding of unregistered multicast data traffic, use the **no ipv6 mld snooping restrict-unknown-multicast** command on a VLAN interface, as in the following example:

```
switch(config-Vlan-2000)# no ipv6 mld snooping restrict-unknown-multicast
```

## Monitoring and managing MLD snooping

You can monitor MLD snooping by using a variety of **show** commands. In addition, you can clear the data for MLD groups and statistics by using **clear** commands. A **debug** command is also available. For command details, refer to the *Network OS Command Reference*.

The following table lists the available **show** commands for MLD snooping.

**TABLE 10** MLD snooping show commands

Command	Description
<b>show ipv6 mld groups</b>	Displays information about IPv6 MLDv1 groups.
<b>show ipv6 mld interface vlan</b>	Displays IPv6 MLD information for a VLAN.
<b>show ipv6 mld snooping</b>	Displays IPv6 MLD snooping details.
<b>show ipv6 mld statistics</b>	Displays IPv6 MLDv1 statistics.

The following table lists the available **clear** and **debug** commands.

**TABLE 11** MLD snooping clear and debug commands

Command	Description
<b>clear ipv6 mld groups</b>	Clears IPv6 MLDv1 group cache entries.
<b>clear ipv6 mld statistics</b>	Clears IPv6 MLDv1 snooping statistics.
<b>debug ipv6 mld</b>	Displays information related to IPv6 MLD, with a variety of options.

## Monitoring and managing IPv6 networks

You can monitor and manage IPv6 networks by using a variety of **show** and **clear** commands. For command details, refer to the *NOS Command Reference*.

The following table lists the available **show** commands for IPv6 networks.

**TABLE 12** IPv6 show commands

Command	Description
<b>show ipv6 counters interface</b>	Displays the counters on an IPv6 interface.
<b>show ipv6 interface</b>	Displays details of IPv6 interfaces.
<b>show ipv6 nd interface</b>	Displays information about the IPv6 Neighbor Discovery configuration on an interface
<b>show ipv6 route</b>	Displays information about IPv6 routes.
<b>show ipv6 static route</b>	Displays information about IPv6 static routes.

The following table lists the available **clear** commands for IPv6 networks.

**TABLE 13** IPv6 clear commands

Command	Description
<b>clear ipv6 counters</b>	Clears IPv6 counters on all interfaces or on a specified interface.
<b>clear ipv6 neighbor</b>	Clears the IPv6 Neighbor Discovery cache on an interface.
<b>clear ipv6 route</b>	Clears IPv6 routes on an interface.

In addition, you can restrict the flooding of IPv6 multicast data traffic if a multicast group is not learned and instead forward that traffic explicitly to multicast router (mrouter) ports. Those ports are learned either by means of MLD queries or PIMv6 hello-based mrouter detection (both of which are supported by default). This feature is available for multicast profiles only.

To restrict this flooding, use the following command in global configuration mode:

**ipv6 mld snooping restrict-unknown-multicast**