



# AP-6521 Series Access Point

## Installation Guide



MOTOROLA SOLUTIONS and the Stylized M Logo are registered in the US Patent & Trademark Office. © Motorola Solutions, Inc. 2011. All rights reserved.

# Table of Contents

<b>1.0 Introduction</b>	<b>1</b>
1.1 Document Conventions	2
1.2 Warnings	2
1.3 Site Preparation	3
1.4 Package Contents	3
1.5 Features	3
<b>2.0 Hardware Installation</b>	<b>4</b>
2.1 Installation Instructions	4
2.2 Precautions	4
2.3 Access Point Placement	5
2.4 Wall Mount Installation	9
2.5 Suspended Ceiling T-Bar Installation	11
2.6 Above the Ceiling (Plenum) Installation	13
2.7 LED Indicator	15
<b>3.0 Defining a Basic Configuration</b>	<b>17</b>
3.1 Using the Initial Setup Wizard	17
<b>4.0 Specifications</b>	<b>38</b>
4.1 Electrical Characteristics	38
4.2 Physical Characteristics	38
4.3 Radio Characteristics	39

<b>5.0 Regulatory Information</b> .....	<b>40</b>
<b>6.0 Motorola's Enterprise Mobility Support Center</b> .....	<b>50</b>

# 1 Introduction

AP-6521 Series access points are components of Motorola Solutions Wireless Controller System. An AP-6521 links wireless 802.11a/b/g/n devices to the controller, enabling the growth of your wireless network with a cost-effective alternative to standard access points. The AP-6521 Series access point is an enterprise class 802.11n access point, installed in minutes anywhere a CAT-5e (or better) cable is located.

An AP-6521 Series access point utilizes a setup wizard to define its operational mode as either a Dependent mode AP, Standalone AP or Virtual Controller AP.

AP-6521 Series access points ship with a single dual-band radio supporting the 802.11a/b/g/n radio bands. For more information on available SKUs, refer to the following:

<b>Part Number</b>	<b>Description</b>
AP-6521-60010-US	802.11a/b/g/n single radio, integrated antenna, high power, United States model
AP-6521-60020-US	802.11a/b/g/n single radio, external antenna, high power, United States model
AP-6521-60010-WR	802.11a/b/g/n single radio, integrated antenna, high power, World Wide model
AP-6521-60020-WR	802.11a/b/g/n single radio, external antenna, high power, World Wide model

The AP-6521 series Access Point is approved under MODEL: NCAP-500.

Motorola Solutions recommends the access point receive power and transfer data through the same CAT-5e (or better) Ethernet cable using a Motorola Solutions Power Injector. The Power Injector (Part No. AP-PSBIAS-2P2-AFR) is an 802.3af PoE injector. For information, see "**Power Injector System**" on page 7.

A separate power supply (Part No. PWRS-147376-01R) is also available if you do not wish to use a Power Injector. This standard power supply just supplies power to the access point's power connector and does not converge power and Ethernet within a single cable connection.

## 1.1 Document Conventions

The following graphical alerts are used in this guide to indicate notable situations:



**NOTE** Tips, hints, or special requirements that you should take note of.

---



**CAUTION** Care is required. Disregarding a caution can result in data loss or equipment malfunction.

---



**WARNING!** Indicates a condition or procedure that could result in personal injury or equipment damage.

---

## 1.2 Warnings

- Read all installation instructions and site survey reports, and verify correct equipment installation before connecting the access point.
- Verify any device connected to this unit is properly wired and grounded.
- Verify there is adequate ventilation around the device, and ambient temperatures meet equipment operation specifications.

## 1.3 Site Preparation

- Consult your site survey and network analysis to determine specific equipment placement, power drops etc.
- Assign installation responsibility to the appropriate personnel.
- Identify and document where all installed components are located.
- Ensure adequate, dust-free ventilation to all installed equipment.
- Prepare Ethernet port connections.
- Verify cabling is within the maximum 100 meter allowable length.

## 1.4 Package Contents

The access point ships with the following:

- One AP-6521 Series access point
- Installation Guide (*This Guide*)
- Rubber Wall Mount Spacers (4)
- LED light pipe and badge
- Wall mount screw and anchor kit

## 1.5 Features

- One RJ-45 console connector
- One RJ-45 Ethernet connector
- LED Indicators
- Safety wire tie point
- Wall mount slots
- Clips for suspended T-Bar mounting
- DC power connector

An AP-6521 Series access point has one RJ-45 connector supporting an 10/100/1000 Ethernet port connection and requires 802.3af compliant power from an external source.

The access point contains runtime firmware which enables the unit to boot after either a power up or a watchdog reset. The runtime firmware on the access point can be updated via the Ethernet interface.

## 2 Hardware Installation

### 2.1 Installation Instructions

An AP-6521 Series access point can attach to a wall, mount under a suspended T-Bar or mount above a ceiling. Selecting a mounting option based on the physical environment of the coverage area. Do not mount the access point in a location that has not been approved in a site survey.

To prepare for an installation, perform the following:

1. Verify the contents of the box includes the intended access point and accessory hardware.
2. Review site survey and network analysis reports to determine the location and mounting position for the access point.
3. Connect a CAT-5e or better Ethernet cable to a PoE compatible device and run the cable to the installation site. Ensure there is sufficient cable slack to perform the installation steps.
4. Determine whether the access point is powered using a Power Injector system, combining data and power to the access point's GE1/PoE port or will be powered from a conventional power adapter providing power only to the access point's DC-48V connector.

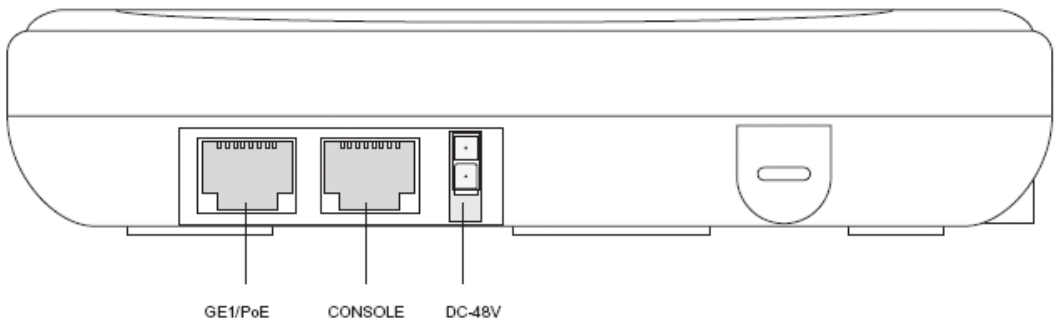

### 2.2 Precautions

Before installing an access point:

- Verify the intended deployment location is not prone to moisture or dust.
- Verify the environment has a continuous temperature range between 0° C to 40° C.



## 2.3 Access Point Placement

For optimal performance, install the access point away from transformers, heavy-duty motors, fluorescent lights, microwave ovens, refrigerators and other industrial equipment. Signal loss can occur when metal, concrete, walls or floors block transmission. Install the access point in an open area or add access points as needed to improve coverage.

Antenna coverage is analogous to lighting. Users might find an area lit from far away to be not bright enough. An area lit sharply might minimize coverage and create *dark areas*. Uniform antenna placement in an area (like even placement of a light bulb) provides even, efficient coverage.

Place the access point using the following guidelines:

- Install the access point at an ideal height of 10 feet from the ground.
- Orient the access point antennas vertically for best reception.
- Point the access point antennas downward if attaching to the ceiling (external antenna models only).

To maximize the access point's radio coverage area, Motorola Solutions recommends conducting a site survey to define and document radio interference obstacles before installing the access point.

### 2.3.1 Antenna Options

Motorola Solutions supports two antenna suites for the single radio, dual-band AP-6521 Series access point. One antenna suite supporting the 2.4 GHz band, and another antenna suite supporting the 5 GHz band. Select an antenna best suited to the intended operational environment of your access point.

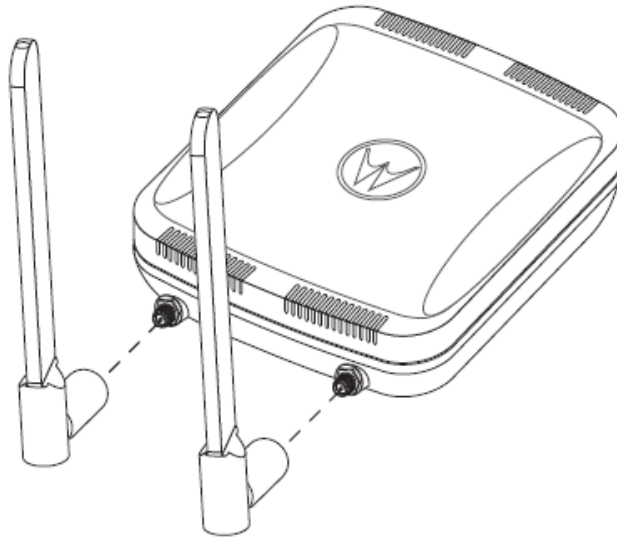

The 2.4 GHz antenna suite includes the following models:

<b><i>Part Number</i></b>	<b><i>Antenna Type</i></b>	<b><i>Approximate Gain (dBi)</i></b>
ML-2452-APA2-01	Dipole	3
ML-2452-HPA5-036	Dipole	2.9
ML-2499-HPA3-01R	Dipole	4.6
ML-2499-APA2-01R	Dipole	2
ML-2452-APA2GA1-01	Dipole	2
ML-2452-PNA5-01R	Panel	4.5
ML-2452-PTA3M3-36	Patch	5
ML-2499-SD3-01R	Patch	4.8
Internal Antenna	PIFA	2.4

The 5 GHz antenna suite includes the following models:

<b>Part Number</b>	<b>Antenna Type</b>	<b>Approximate Gain (dBi)</b>
ML-2452-APA2-01	Dipole	5
ML-2452-HPA5-036	Dipole	4.9
ML-5299-APA1-01R	Dipole	2
ML-5299-HPA1-01R	Dipole	5
ML-2452-APA2GA1-01	Dipole	1
ML-2452-PNA5-01R	Panel	5
ML-2452-PTA3M3-36	Patch	3
ML-5299-PTA1-0R	Patch	5
Internal Antenna	PIFA	5.3

For a more exhaustive overview of the antennas and associated components supported by the Motorola Solutions access point family, refer to the *Enterprise Wireless LAN Antenna Specification Guide* available at <http://support.symbol.com/support/product/manuals.do>.

### **2.3.2 Power Injector System**

The access point can receive power via an Ethernet cable connected to the GE1/PoE port.

When users purchase a WLAN solution, they often need to place access points in obscure locations. In the past, a dedicated power source was required for each access point in addition to the Ethernet infrastructure. This often required an electrical contractor to install power drops at each access point location. The Power Injector merges power and Ethernet into one cable, reducing the burden of installation and allowing optimal access point placement in respect to the intended coverage area.

The Power Injector (Part No. AP-PSBIAS-2P2-AFR) is an 802.3af PoE injector. The access point can only use a Power Injector when connecting to the access point's GE1/PoE port. The Power Injector is separately ordered and not shipped with the access point. A separate Power Injector is required for each access point comprising the network.

The Power Injector has no On/Off power switch. The Injector receives power and is ready for device connection and operation as soon as AC power is applied. Refer to the guide shipped with the Power Injector for a description of the device's LEDs. The Power Injector can be installed free standing, on an even horizontal surface or wall mounted using the Power Injector's wall mounting key holes.

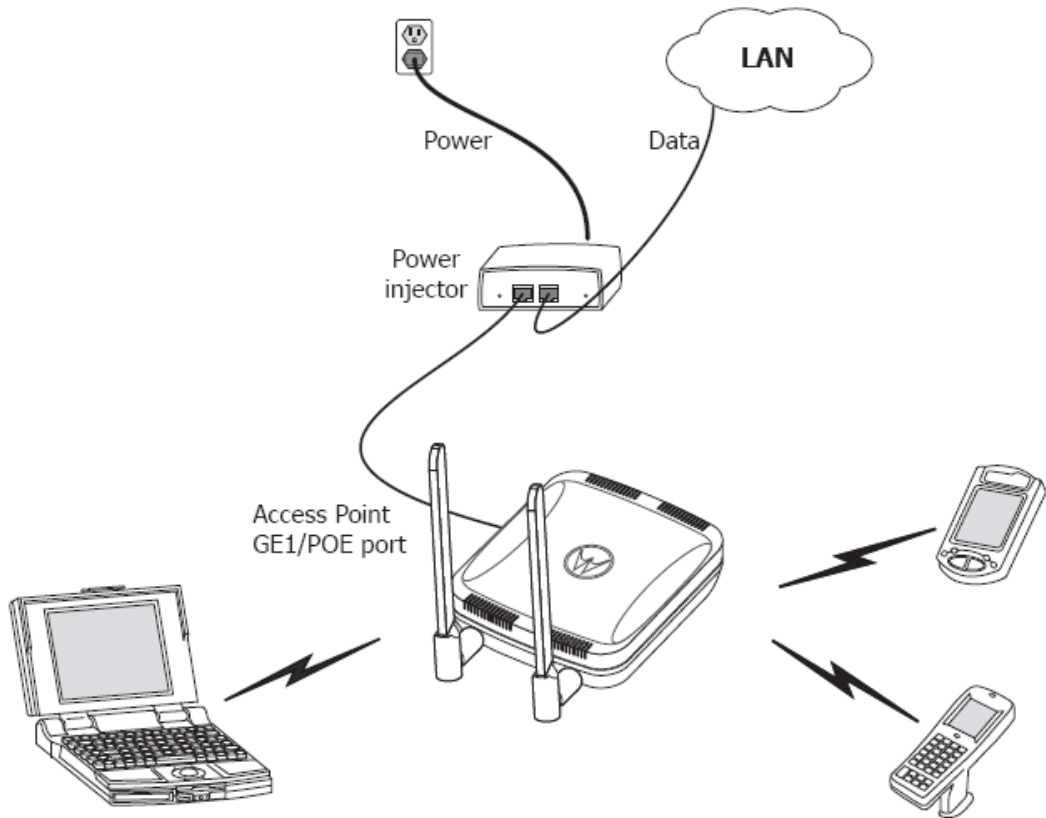

The following guidelines should be adhered to before cabling the Power Injector to an Ethernet source and an access point:

- Do not block or cover airflow to the Power Injector.
- Keep the Power Injector away from excessive heat, humidity, vibration and dust.
- The Power Injector isn't a repeater, and does not amplify the Ethernet signal. For optimal performance, ensure the Power Injector is placed as close as possible to the Ethernet switch. This allows the access point to be deployed away from power drops.
- Ensure the cable length from the Ethernet source (host) to the Power Injector and access point does not exceed 100 meters (333 ft).



**CAUTION** To avoid problematic performance and restarts, disable PoE from a wired controller port connected to an access point if mid-span *power sourcing equipment* (PSE) is used between the two, regardless of the manufacturer.

---



---



**CAUTION** Ensure AC power is supplied to the Power Injector using an AC cable with an appropriate ground connection approved for the country of operation.

---



---



**NOTE** If not using the Power Injector to power the access point, the only other approved power solution is the standard power supply (Part Number PWRS-147376-01R). The standard power supply does not converge data and power in one cable, and requires a separate data Ethernet connection in addition to a power connection. This product is intended to be supplied by a listed power adapter marked "Class 2" or "L.P.S" (or "Limited Power Source") and rated from 48Vdc, 0.27A minimum.

---

## 2.4 Wall Mount Installation

To support wall mount installations, the access point is fastened directly to a flat wall surface. The wall should be of gypsum board, plaster, wood or concrete in composition.



**CAUTION** An access point should be wall mounted to concrete or plaster-wall-board (dry wall) only. Do not wall mount the access point to combustible surfaces.

---



---

To install the access point to a wall:

1. Orient the access point by either its width or length.
2. Mark the mounting surface at the target screw insertion points.
3. At each point, drill a hole in the wall, insert an anchor, screw into the anchor the wall mounting screw and stop when there is 1mm between the screw head and the wall.

If pre-drilling a hole, the recommended hole size is 2.8mm (0.11in.) if the screws are going directly into the wall and 6mm (0.23in.) if wall anchors are being used.

4. If required, install and attach a security cable to the access point lock port.

5. Attach the antennas to their correct connectors.

For information on available antennas, see “**Antenna Options**” on page 5.

6. Place the large center opening of each of the mount slots over the screw heads.
7. Slide the access point down along the mounting surface to hang the mount slots on the screw heads
8. Cable the access point using either the Power Injector solution or an approved line cord and power supply.



**CAUTION** Do not connect to the power source until the cabling of the access point is complete. Ensure PoE is not connected to the access point's console connector or risk rendering the console connector permanently inoperable.

---

---

For Motorola Power Injector installations:

- a. Connect a RJ-45 CAT5e (or CAT6) Ethernet cable between the network data supply (host) and the Power Injector **Data In** connector.
- b. Connect a RJ-45 CAT5e (or CAT6) Ethernet cable between the Power Injector **Data & Power Out** connector and the access point GE1/PoE port.
- c. Ensure the cable length from the Ethernet source (host) to the Power Injector and access point does not exceed 100 meters (333 ft). The Power Injector has no On/Off power switch. The Power Injector receives power as soon as AC power is applied. For more information on using the Power Injector, see “**LED Indicator**” on page 15.

For power adapter (Part Number PWRS-147376-01R) and line cord installations:

- a. Connect a RJ-45 CAT5e (or CAT6) Ethernet cable between the network data supply (host) and the access point's GE1/PoE.
  - b. Verify the power adapter is correctly rated according the country of operation.
  - c. Connect the power supply line cord to the power adapter.
  - d. Attach the power adapter cable to the DC-48V power connector on the access point.
  - e. Attach the power supply line cord to a power supply.
9. Verify the behavior of the access point LEDs. For more information, see “**LED Indicator**” on page 15.
  10. The access point is ready to configure. For information on basic access point device configuration, see “**Defining a Basic Configuration**” on page 17.

## 2.5 Suspended Ceiling T-Bar Installation

A suspended ceiling mount requires holding the access point up against the T-bar of a suspended ceiling grid and twisting the access point chassis onto the T-bar.

To install the access point on a ceiling T-bar:

1. If desired, install and attach a security cable to the access point lock port.
2. If using an external antenna model, attach the antennas to their correct connectors.
3. For more information on the antenna options available to the access point, see “**Antenna Options**” on page 11.
4. Cable the access point using either the Power Injector solution or an approved line cord and power supply.



**CAUTION** Do not connect to the power source until the cabling of the access point is complete. Ensure PoE is not connected to the access point's console connector or risk rendering the console connector permanently inoperable.

---



---

For Power Injector installations:

- a. Connect a RJ-45 CAT5e (or CAT6) Ethernet cable between the network data supply (host) and the Power Injector **Data In** connector.
- b. Connect a RJ-45 CAT5e (or CAT6) Ethernet cable between the Power Injector **Data & Power Out** connector and the access point's GE1/PoE port.
- c. Ensure the cable length from the Ethernet source (host) to the Power Injector and access point does not exceed 100 meters (333 ft). The Power Injector has no On/Off power switch. The Power Injector receives power as soon as AC power is applied. For more information on using the Power Injector, see “**Power Injector System**” on page 7.

For power adapter (Part Number PWRS-147376-01R) and line cord installations:

- a. Connect a RJ-45 Ethernet cable between the network data supply (host) and the access point's GE1/PoE port.
- b. Verify the power adapter is correctly rated according the country of operation.
- c. Connect the power supply line cord to the power adapter.
- d. Attach the power adapter cable to the DC-48V power connector on the access point.
- e. Attach the power supply line cord to a power supply.

5. Verify the behavior of the access point LEDs. For more information, see "**LED Indicator**" on page 15.
6. Align the bottom of the ceiling T-bar with the back of the access point.
7. Orient the access point chassis by its length and the length of the ceiling T-bar.
8. Rotate the access point chassis 45 degrees clockwise.
9. Push the back of the access point chassis on to the bottom of the ceiling T-bar.

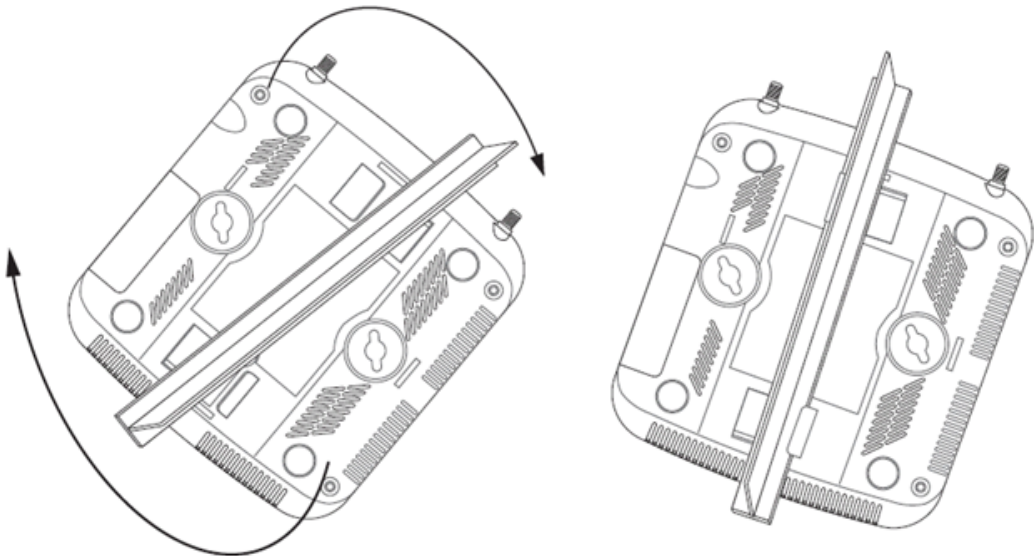

10. Rotate the access point chassis 45 degrees counter-clockwise. The clips click as they fasten to the T-bar.
11. Verify the behavior of the access point LEDs. For more information, see "**LED Indicator**" on page 15.
12. The access point is ready to configure. For information on basic access point device configuration, see "**Defining a Basic Configuration**" on page 17.



## 2.6 Above the Ceiling (Plenum) Installation

An above the ceiling installation requires placing the access point above a suspended ceiling and installing the provided light pipe under the ceiling tile for viewing the status LED of the unit. An above the ceiling deployment enables installations compliant with drop ceilings, suspended ceilings and industry standard tiles from .625 to .75 inches thick.



**NOTE** The access point is Plenum rated to UL2043 and NEC1999 to support above the ceiling installations. To ensure UL compliance and proper access point operation within the Air Handling Plenum, the access point must be installed with the bottom surface of the unit in contact with the un-finished surface of the ceiling tile. Placing the product on the ceiling tile will facilitate the positioning of the light pipe. Placement of the product in the Air Handling Plenum off of, or away from, the unfinished surface of the ceiling tile is not UL approved and certification of UL2043 compliance would be void in that case.



**CAUTION** Motorola Solutions does not recommend mounting the access point directly to suspended ceiling tile with a thickness less than 12.7mm (0.5in.) or a suspended ceiling tile with an unsupported span greater than 660mm (26in.).

The mounting hardware required to install the access point above a ceiling consists of:

- Light pipe
- Badge for light pipe
- Decal for badge

To install the access point above a ceiling:

1. If possible, remove the adjacent ceiling tile from its frame and place it aside.
2. If required, install and attach a security cable to the access point's lock port.
3. Mark a point on the finished side of the tile where the light pipe is to be located.
4. Create a light pipe path hole in the target position on the ceiling tile.
5. Use a drill to make a hole in the tile the approximate size of the access point LED light pipe.



**CAUTION** Motorola Solutions recommends care be taken not to damage the finished surface of the ceiling tile when creating the light pipe hole and installing the light pipe.

6. Remove the light pipe's rubber stopper (from the access point) before installing the light pipe.
7. Connect the light pipe to the bottom of the access point. Align the tabs and rotate approximately 90 degrees. Do not over tighten.
8. Fit the light pipe into hole in the tile from its unfinished side.
9. Place the decal on the back of the badge and slide the badge onto the light pipe from the finished side of the tile.
10. Attach the antennas to their correct connectors.

For information on the antennas available to the access point, see "**Antenna Options**" on page 5.

11. Align the ceiling tile into its former ceiling space.
13. Cable the access point using either the Power Injector solution or an approved line cord and power supply.



**CAUTION** Do not connect to the power source until the cabling of the access point is complete. Ensure PoE is not connected to the access point's console connector or risk rendering the console connector permanently inoperable.

---

---

For Power Injector installations:

- a. Connect a RJ-45 CAT5e (or CAT6) Ethernet cable between the network data supply (host) and the Power Injector **Data In** connector.
- b. Connect a RJ-45 CAT5e (or CAT6) Ethernet cable between the Power Injector **Data & Power Out** connector and the access point's GE1/PoE port.
- c. Ensure the cable length from the Ethernet source (host) to the Power Injector and access point does not exceed 100 meters (333 ft). The Power Injector has no On/Off power switch. The Power Injector receives power as soon as AC power is applied. For more information on using the Power Injector, see "**Power Injector System**" on page 7.

For power adapter (Part Number PWRS-147376-01R) and line cord installations:

- a. Connect a RJ-45 Ethernet cable between the network data supply (host) and the access point's GE1/PoE port.
- b. Verify the power adapter is correctly rated according the country of operation.
- c. Connect the power supply line cord to the power adapter.
- d. Attach the power adapter cable to the DC-48V power connector on the access point.
- e. Attach the power supply line cord to a power supply.

12. Verify the behavior of the access point LED light pipe. For more information, see “**LED Indicator**” on page 15.
13. Place the ceiling tile back in its frame and verify it is secure.
14. The access point is ready to configure. For information on basic access point device configuration, see “**Using the Initial Setup Wizard**” on page 17.

## 2.7 LED Indicator

An AP-6521 Series access point has a single LED activity indicator on the front of the unit.

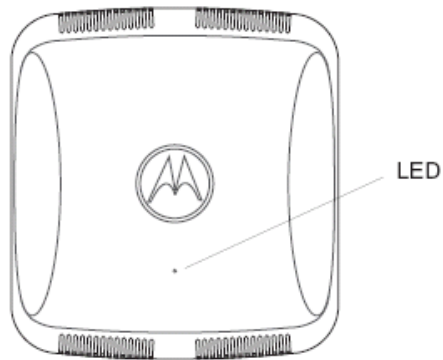

Front

The LED provides a status display indicating error conditions, transmission, and network activity for the 5 GHz 802.11a/n (amber) radio or the 2.4 GHz 802.11b/g/n (green) radio.

<b>Task</b>	<b>5 GHz Activity LED (Amber)</b>	<b>2.4 GHz Activity LED (Green)</b>
<i>Unadopted</i>	Off	Blinking 5 times per second
<i>Normal Operation</i>	<ul style="list-style-type: none"> <li>• If this radio band is enabled: Blink at 5 second interval</li> <li>• If this radio band is disabled: Off</li> <li>• If there is activity on this band: Blink at a 1Hz</li> </ul>	<ul style="list-style-type: none"> <li>• If this radio band is enabled: Blink at 5 second interval</li> <li>• If this radio band is disabled: Off</li> <li>• If there is activity on this band: Blink at a 1Hz</li> </ul>
<i>Firmware Update</i>	On	Off
<i>Locate AP Mode</i>	Blink at 5Hz	Blink at 5Hz

## 3 Defining a Basic Configuration

An AP-6521 Series access point can utilize an initial setup wizard to streamline the process of initially accessing the wireless network. The wizard defines the access point's operational mode, deployment location, basic security, network and WLAN settings.

### 3.1 Using the Initial Setup Wizard

Once the AP-6521 is installed and powered on, complete the following steps to get the access point up and running and access management functions:

1. The access point's IP address is optimally provided using DHCP. A zero config IP address can also be derived if DHCP resources are unavailable. Using zero config, the last two octets in the IP address are the decimal equivalent of the last two bytes in the access point's hardcoded MAC address.

For example:

MAC address - 00:C0:23:00:F0:0A

Zero-config IP address - 169.254.240.10

To derive the access point's IP address using its MAC address:

- a. Open the Windows calculator by selecting *Start > All Programs > Accessories > Calculator*. This menu path may vary slightly depending on your version of Windows.
  - b. With the Calculator displayed, select *View > Scientific*. Select the **Hex** radio button.
  - c. Enter a hex byte of the access point's MAC address. For example, F0.
  - d. Select the **Dec** radio button. The calculator converts F0 into 240. Repeat this process for the last access point MAC address octet.
2. Point the Web browser to the access point's IP address. The following login screen displays:

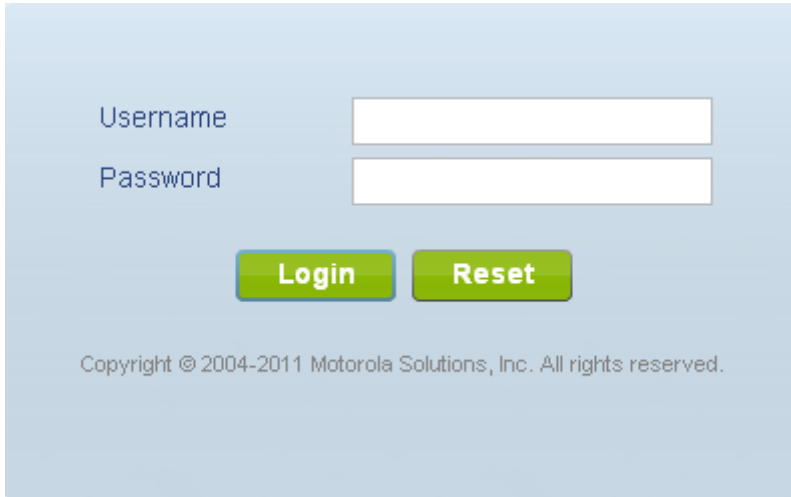

Username

Password

**Login** **Reset**

Copyright © 2004-2011 Motorola Solutions, Inc. All rights reserved.

3. Enter the default username ***admin*** in the **Username** field.
4. Enter the default password ***motorola*** in the **Password** field.
5. Click the **Login** button to load the management interface.



**NOTE** When logging in for the first time, you're prompted to change the password to enhance device security in subsequent logins.



**NOTE** If you get disconnected when running the wizard, you can connect again with the access point's actual IP address (once obtained) and resume the wizard.

---

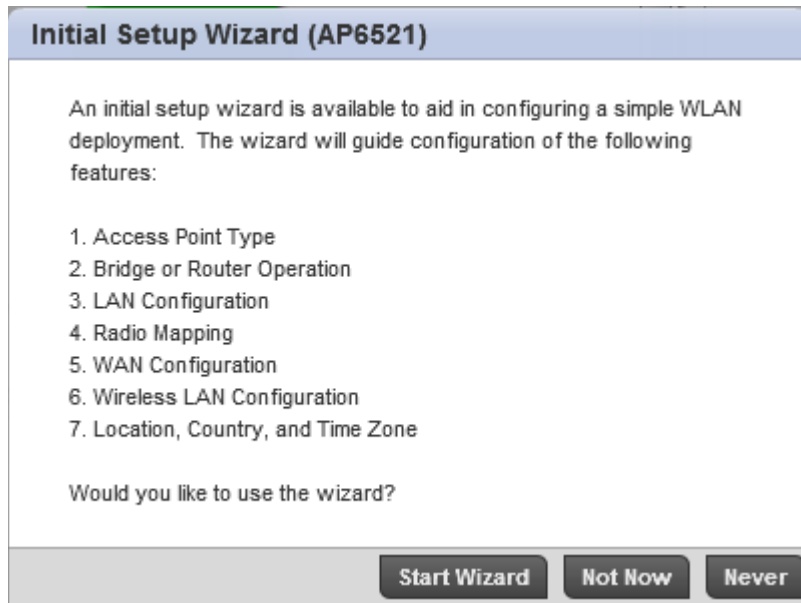

6. If this is the first time the management interface has been accessed, a dialogue displays to start the wizard. Select **Start Wizard** to run the initial setup wizard.

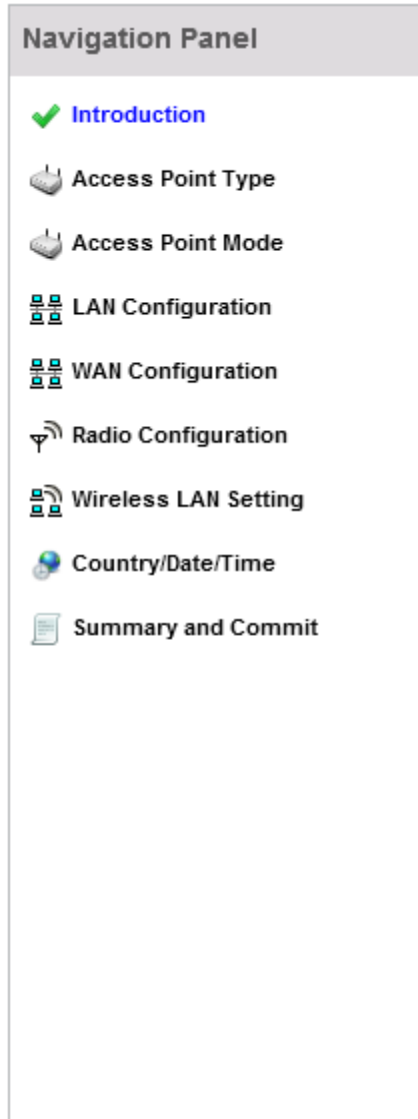

The first page of the Initial AP Setup Wizard displays the *Navigation Panel* and *Introduction* for the configuration activities comprising the access point's initial setup

A green checkmark to the left of an item in the Navigation Panel defines the listed task as having its minimum required configuration parameters set correctly. A red X defines the task as still requiring at least one parameter be defined correctly.



The Introduction screen displays a list of the basic configuration activities supported by the Initial Setup Wizard.

### Function Highlight

---

1. Access Point Types: Virtual Controller AP or Standalone AP
2. Access Point Mode: Bridge or Router Operation
3. LAN Configuration
4. Radio Configuration
5. WAN Configuration
6. Wireless LAN Configuration
7. Location, Country Code, Time Zone, Date and Time
8. Summary and Save/Commit

7. Select **Save/Commit** within each page to save the updates made to that page's configuration. Select **Next** to proceed to the next page listed in the Navigation Panel. Select **Back** to revert to the previous screen in the Navigation Panel without saving your updates.



**NOTE** While you can navigate to any page in the navigation panel, you cannot complete the Initial AP Setup Wizard until each task in the Navigation Panel has a green checkmark.

---

8. Select **Next**. The Initial AP Setup Wizard displays the **Access Point Type** screen to define the access point's Standalone versus Virtual Controller AP functionality and the way the access point is adopted to a controller.

### Access Point Type Selection

---

- Virtual Controller AP - When multiple access points are deployed, a single access point can function as a Virtual Controller AP and manage other access points. The Virtual Controller AP can adopt and configure other access points of the same model in a 24-cell (maximum) deployment.
- Standalone AP - Select this option to deploy this access point as an autonomous "fat" access point. A standalone AP isn't managed by a Virtual Controller AP, or adopted by a controller.
- Adopted to Controller - Select this option when you want the AP to adopt to a controller. The AP will discover L2 connected controllers automatically. It will also try to discover controllers over L3 using DHCP or DNS discovery mechanism. For this, no further configuration is required on the AP. Please see the System Reference Guide for details on how to setup your DHCP or DNS server to enable this. If the AP is not on the same L2 segment as the controller and your network is not setup for DHCP or DNS based discover, you can specify the controller IP manually below.

---

Back

Next

Save/Commit

9. Select an **Access Point Type** from the following options:
- *Virtual Controller AP* - When more than one access point is deployed, a single access point can function as a Virtual Controller AP. Up to 24 access points can be connected to, and managed by, a single Virtual Controller AP of the same AP-6521 model.
  - *Standalone AP* - Select this option to deploy this access point as an autonomous fat access point. A Standalone AP isn't managed by a Virtual Controller AP, or adopted by a RFS series controller.



**NOTE** If designating the access point as a Standalone AP, Motorola Solutions recommends the access point's UI be used exclusively to define its device configuration, and not the CLI. The CLI provides the ability to define more than one profile and the UI does not. Consequently, the two interfaces cannot be used collectively to manage profiles without an administrator encountering problems.

- *Adopted to Controller* - Select this option when deploying the access point as a controller managed (Dependent mode) access point. Selecting this option closes the Initial AP Setup Wizard. An adopted access point obtains its configuration from a profile stored on its managing controller. Any manual configuration changes are overwritten by the controller upon reboot.

Select the *Automatic controller discovery* option to enable the access point to be discovered and adopted using layer 2 settings. If preferring layer 3 adoption, select the *Static Controller Configuration* option, and define the addresses of the preferred controllers. If using the static method, you'll also need to define whether the access point receives an IP address using DHCP or if IP resources are provided statically.

#### Adoption Settings

Automatic controller discovery (L2, DHCP or DNS based)

Static Controller Configuration

Controller 1 \* 172.168.0.20

Controller 2

#### AP IP Address

Use DHCP  Static IP Address/Subnet

\* 192.168.0.1 / 24

Default Gateway

\* 192.168.0.1

10. Select **Next**. The Initial AP Setup Wizard displays the **Access Point Mode** screen to define the access point's routing or bridging mode functionality.

## Access Point Mode Selection

- Router Mode - the access point routes traffic between the wireless network and the Internet or corporate network (WAN).

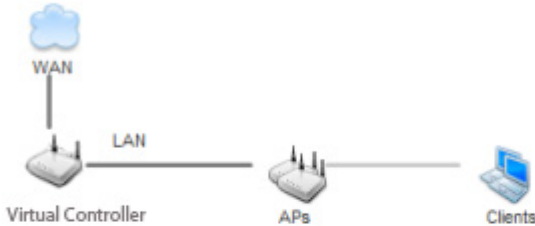

- Bridge Mode - In Bridge Mode, the access point depends on an external router for routing LAN and WAN traffic. Routing is generally used on one device, whereas bridging is typically used in a larger density network. Thus, select Bridge Mode when deploying this access point with numerous peer APs supporting clients on both the 2.4 and 5GHz radio bands.

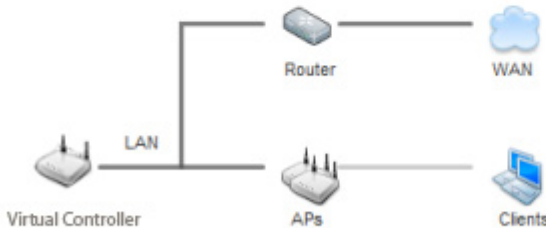

Back

Next

Save/Comm

11. Select an **Access Point Mode** from the available options.

- *Router Mode* - In Router Mode, the access point routes traffic between the local network (LAN) and the Internet or external network (WAN). Router mode is recommended in a deployment supported by just a single access point.
- *Bridge Mode* - In Bridge Mode, the AP depends on an external router for routing LAN and WAN traffic. Routing is generally used on one device, whereas bridging is typically used in a larger network. Thus, select Bridge Mode when deploying this access point with numerous peer APs supporting clients on both the 2.4 and 5GHz radio bands.

12. Select **Next**. The Initial AP Setup Wizard displays the **LAN Configuration** screen to set the access point's LAN interface configuration.



## LAN Configuration

Please configure interface settings for LAN (VLAN 1) which will be used by wireless clients

Use DHCP [What is this?](#)

Static IP Address/Subnet [What is this?](#) \* 10 . 0 . 0 . 5 / 24

### DHCP Server

Use on-board DHCP server to assign IP addresses to wireless clients

Range 192 . 168 . 0 . 100 -- 192 . 168 . 0 . 200

Default Gateway 192 . 168 . 0 . 1

### Domain Name Server (DNS)

DNS Forwarding

Primary DNS . . .

Secondary DNS . . .

Back

Next

Save/Comm

13. Set the following DHCP and Static IP Address/Subnet information for the LAN interface:
  - *Use DHCP* - Select the checkbox to enable an automatic network address configuration using the access point's DHCP server. An AP-6521 access point does not have an onboard DHCP server and an external DHCP server must be utilized.
  - *Static IP Address/Subnet* - Enter an IP Address and a subnet for the access point's LAN interface. If Use DHCP is selected, this field is not available. When selecting this option, define the following *DHCP Server* and *Domain Name Server (DNS)* resources, as those fields will become enabled on the bottom portion of the screen.
    - *Use on-board DHCP server to assign IP addresses to wireless clients* - Select the checkbox to enable the access point's DHCP server to provide IP and DNS information to clients on the LAN interface.
    - *Range* - Enter a starting and ending IP Address range for client assignments on the access point's LAN interface. Avoid assigning IP addresses from x.x.x.1 - x.x.x.10 and x.x.x.255, as they are often reserved for standard network services. This is a required parameter.
    - *Default Gateway* - Define a default gateway address for use with the default gateway. This is a required parameter.
  - *DNS Forwarding* - Select this option to allow a DNS server to translate domain names into IP addresses. If this option is not selected, a primary and secondary DNS resource must be specified. DNS forwarding is useful when a request for a domain name is made but the DNS server, responsible for converting the name into its corresponding IP address, cannot locate the matching IP address.
    - *Primary DNS* - Enter an IP Address for the main Domain Name Server providing DNS services for the access point's LAN interface.
    - *Secondary DNS* - Enter an IP Address for the backup Domain Name Server providing DNS services for the access point's LAN interface
14. Select **Next**. The Initial AP Setup Wizard displays the **WAN Configuration** screen to set the access point's WAN interface configuration.

## WAN Configuration

Please configure interface settings for WAN port

Use DHCP [What is this?](#)

Static IP Address/Subnet  [What is this?](#)

Default Gateway

The port connected to the WAN  GE1 Port [What is this?](#)

GE2 Port [What is this?](#)

Enable NAT on the WAN Interface [What is this?](#)

Back

Next

Save/Comm

15. Set the following DHCP and Static IP Address/Subnet information for the WAN interface:
  - *Use DHCP* - Select the checkbox to enable an automatic network address configuration using the access point's DHCP server.
  - *Static IP Address/Subnet* - Enter an IP Address/Subnet and gateway for the access point's WAN interface. These are required fields

- *The port connected to the WAN* - Select the port used as the physical access point connection to the external network. This ports available differ depending on the access point model deployed. Access point models with a single port have this option fixed.
  - *Enable NAT on the WAN Interface* - Select the checkbox to allow traffic to pass between the access point's WAN and LAN interfaces.
16. Select **Next**. The Initial AP Setup Wizard displays the **Radio Configuration** screen to define support for the 2.4GHz radio band, 5GHz radio band or to set the radio's functionality as a dedicated sensor. An AP-6521 is supports a single dual-band radio.



**NOTE** The **ADSP Sensor Support** field displays at the bottom of the screen only if a radio has been dedicated as a sensor.

---



 **Radio 1**

Configure as a Data Radio [What is this?](#)

Radio Frequency Band  2.4GHz  5.0GHz

Power Level  (1 – 23) Channel Mode   Constantly Monitor

Configure as a Sensor Radio [What is this?](#)

Disable the Radio Radio 1 will be disabled. Please make sure this is what you want to do.

[Back](#)[Next](#)[Save/Comm](#)

17. Set the following parameters for the radio:

- *Configure as a Date Radio* - Select this option to dedicate this radio for WLAN client support in either the selected 2.4 or 5GHz radio band.

- *Radio Frequency Band* - Select either the 2.4GHz or 5.0GHz radio band to use with the radio when selected as a Data Radio. The selected band is used for WLAN client support. Considers selecting one radio for 2.4GHz and another for 5GHz support (if using a dual or three radio model) when supporting clients in both the 802.11bg and 802.11n bands.
- *Power Level* - Use the spinner control to select a 1 - 23 dBm minimum power level to assign to this radio in selected 2.4 or 5.0 GHz band. 1 dBm is the default setting.
- *Channel Mode* - Select either *Random*, *Best* or *Static*. Select **Random** for use with a 802.11a/n radio. To comply with *Dynamic Frequency Selection* (DFS) requirements in the European Union, the 802.11a/n radio uses a randomly selected channel each time the access point is powered on.  
Select **Best** to enable the access point to scan non-overlapping channels and listen for beacons from other access points. After the channels are scanned, it will select the channel with the fewest access points. In the case of multiple access points on the same channel, it will select the channel with the lowest average power level.  
When **Constantly Monitor** is selected, the access point will continuously scan the network for excessive noise and sources of interference. Select **Static** to assign the access point a permanent channel and scan for noise and interference only when initialized.
- *Configure as a Sensor Radio* - Select this option to dedicate the radio to sensor support exclusively. When functioning as a sensor, the radio scans in sensor mode across all channels within the 2.4 and 5.0GHz bands to identify potential threats within the access point managed network. If dedicating a radio as a sensor resource, a primary and secondary ADSP server must be specified as an ADSP management resource.



**NOTE** If configuring an AP-6521 model access point as a sensor, the access point will require a reboot before its sensor functionality is invoked. The reboot can take place at the completion of the Initial AP Setup Wizard.

---

- *Disable the Radio* - Select this option to disable this radio, thus prohibiting it from either providing WLAN or sensor support. Verify this course action with your network administrator before rendering the radio offline.
18. Select **Next**. The Initial AP Setup Wizard displays the **Wireless LAN Setting** screen to define network address and security settings for two WLAN configurations available to the access point as part of the Initial AP Setup Wizard. Once the access point has an initial configuration defined, numerous additional WLAN configurations can be set.

---

WLAN 1 WLAN 2

---

 **WLAN 1 Configuration**

SSID  [What is this?](#)

WLAN Type

- No Authentication and No Encryption [What is this?](#)
- Captive Portal Authentication and No Encryption [What is this?](#)
- PSK authentication, WPA2 encryption [What is this?](#)
- EAP Authentication and WPA2 Encryption [What is this?](#)

---

|||

---

Back Next Save/Comm

19. Set the following parameters for each of the two WLAN configurations available as part of this Initial AP Setup Wizard:
  - *SSID* - Enter or modify the *Services Set Identification* (SSID) associated with the WLAN. The WLAN name is auto-generated using the SSID until changed by the user. The maximum number of characters is 32. Do not use <> | " & \ ? , This is a required parameter for each WLAN.

- *WLAN Type* - Set the data protection scheme used by clients and access points within the WLAN. The following options are available:
  - *No Authentication and no Encryption* - Select this option to provide no security between the access point and connected clients on this WLAN.
  - *Captive Portal Authentication and No Encryption* - Select this option to use a Web page (either internally or externally hosted) to authenticate users before access is granted to the network. If using this option, define whether a local or external RADIUS authentication resource is used.
  - *PSK Authentication and WPA2 Encryption* - Select the option to implement a pre-shared key that must be correctly shared between the access point and requesting clients using this WLAN. If using this option, specify a WPA key in either ASCII (8-63 characters) or HEX (64 characters) format.
  - *EAP Authentication and WPA2 Encryption* - Select this option to authenticate clients within this WLAN through the exchange and verification of certificates. If using this option, define whether a local or external RADIUS authentication resource is used.
- *WPA Key* - If a WPA key is required (PSK Authentication and WPA2 Encryption), enter an alphanumeric string of 8 to 63 ASCII characters or 64 HEX characters as the primary string both transmitting and receiving authenticators must share. The alphanumeric string allows character spaces. This passphrase saves the administrator from entering the 256-bit key each time keys are generated.
- *RADIUS Server* - If the WLAN type requires a RADIUS server to validate user credentials, designate whether the access point is using an **External RADIUS Server** resource or the access point's own **Onboard RADIUS Server**. If using an external RADIUS server resource, provide the IP address of the external server and the shared secret used to authenticate the request.



**NOTE** If using the access point's onboard RADIUS server, an additional **RADIUS Server Configuration** screen displays within the Navigation Panel on the left-hand side of the screen. Use this screen to create user accounts validated when the access point authenticates client connection requests to the onboard RADIUS server.

---

20. Select **Next**. The Initial AP Setup Wizard displays the **RADIUS Server Configuration** screen if the access point's onboard RADIUS server is required to validate user requests. If an onboard RADIUS server is not required, the Initial AP Setup Wizard displays the **Country/Date/Time** screen to set device deployment, administrative contact and system time information.

Some WLANs require authentication using the on-board RADIUS server. User accounts must be added for a should be authorized by the server.

Username	Description

#### Add On-Board RADIUS Server Users

Username \*

Password \*

Confirm Password \*

Description



21. Refer to the *Username*, *Password*, *Description* and *Actions* columns to review credentials of existing RADIUS Server user accounts. Add new accounts or edit the properties of existing accounts as updates are required.

22. Refer to the **Add On-Board RADIUS Server Users** field to set the following parameters for a user account:
  - *Username* - If adding a new user account, create a username up to X characters in length. The username cannot be revised if modifying the user configuration. This is a required parameter.
  - *Password* - Provide (or modify) a password between X - X characters in length entered each time a requesting client attempts access to the AP managed network using the access point's onboard RADIUS server. This is a required parameter.
  - *Confirm Password* - Re-enter (or modify) the password as a means of confirming the password. This is a required parameter.
  - *Description* - Optionally provide a description of the user account as means of further differentiating it from others.
23. When completed, select **Add User** to commit a new user, **Modify User** to commit a modified user or **Reset** to clear the screen without updating the configuration. Selecting Reset clears the field of all entered user account information.
24. Select **Next**. The Initial AP Setup Wizard displays the **Country/Date/Time** screen to set device deployment, administrative contact and system time information. The system time can either be set manually or be supplied by a dedicated *Network Time Protocol* (NTP) resource.

### Country and Time Zone

Location

Contact

Country \*

Time Zone \*

### System Date and Time

08/15/2011  1 : 0  AM  PM

### Network Time Protocol (NTP)

NTP Server Address

(An external NTP server to provide system date and time)



25. Refer to the **Country and Time Zone** field to set the following device deployment information:

- *Location* - Define the location of the access point. The Location parameter acts as a reminder of where the AP can be located within the Motorola Solutions managed wireless network.

- *Contact* - Specify the contact information for the administrator. The credentials provided should accurately reflect the individual responding to service queries.
  - *Country* - Select the Country where the access point is deployed. The access point prompts for the correct country code on the first login. A warning message also displays stating an incorrect country setting may result in illegal radio operation. Selecting the correct country is central to legal operation. Each country has its own regulatory restrictions concerning electromagnetic emissions and the maximum RF signal strength that can be transmitted. This is a required parameter.
  - *Time Zone* - Set the time zone where the access point is deployed. This is a required parameter. The setting should be complimentary with the selected deployment country.
26. If an NTP resource is unavailable, set the **System Date and Time** (calendar date, time and AM/PM designation).
  27. Optionally enter the IP address of a server used to provide system time to the access point. Once the IP address is entered, the **Network Time Protocol (NTP)** functionality is engaged automatically for synchronization with the NTP resource.
  28. If an NTP resource is unavailable, set the **System Date and Time** (calendar date, time and AM/PM designation).
  29. Optionally enter the IP address of a server used to provide system time to the access point. Once the IP address is entered, the **Network Time Protocol (NTP)** functionality is engaged automatically for synchronization with the NTP resource.
  30. Select **Next**. The Initial AP Setup Wizard displays the **Summary and Commit** screen to summarize the screens (pages) and settings updated using the Initial AP Setup Wizard.

There's no user intervention or additional settings required within this screen. Its an additional means of validating the configuration before its deployed. However, if a screen displays settings not intended as part of the initial configuration, the screen can be selected from within the Navigation Panel and its settings modified accordingly.



 **Access Point Type Page**

---

Access Point Type    Virtual Controller AP

 **Access Point Mode Page**

---

Access Point Mode    Router Mode

 **LAN Configuration Page**

---

LAN Configuration Type    Static IP Address/Subnet

Static IP Address/Subnet    10.0.0.5/24

 **WAN Configuration Page**

---

WAN Configuration Type    Use DHCP

Port to External    GE1 Port

 **Radio Configuration Page**

---

Radio 1    Configure as a Data Radio

Radio1 Frequency Band    Configure 2.4GHz

Power Level    1

Channel Mode    Static

Constantly Monitor    1

 **WLAN Configuration Page**

---

Back

Next

Save/Com

31. If the configuration displays as intended, select the **Save/Commit** button to implement these settings to the access point's configuration. If additional changes are warranted based on the summary, either select the target page from the Navigational Panel, or use the **Back** and **Next** buttons to scroll to the target screen.

## 4 Specifications

### 4.1 Electrical Characteristics

An AP-6521 Series access point has the following electrical characteristics:

<i>Max DC Power Consumption</i>	12.95W (270mA@48V)
---------------------------------	--------------------

### 4.2 Physical Characteristics

An AP-6521 Series access points has the following physical characteristics:

<i>Dimensions</i>	6.0 (Length) x 5.5 (Width) x 1.63 (Tall) - Inches 152.4 (Length) x 139.7 (Width) x 41.1 (Tall) - Millimeters
<i>Housing</i>	Plastic
<i>Weight</i>	0.60 lbs/0.272 kg
<i>Operating Temperature</i>	32°F to 104°F/0°C to 40°C
<i>Storage Temperature</i>	-40°F to 158°F/-40°C to 70°C
<i>Operating Humidity</i>	5 to 95% Relative Humidity non-condensing
<i>Storage Humidity</i>	85% Relative Humidity non-condensing
<i>Operating Altitude (max)</i>	8,000 ft @ 28°C
<i>Storage Altitude (max)</i>	30,000 ft @ 12°C
<i>Electrostatic Discharge</i>	+/-15kV Air and +/-8kV Contact @ 50% Relative Humidity

### 4.3 Radio Characteristics

An AP-6521 Series access points has the following radio characteristics:

<b>Radio Characteristic</b>	<b>AP-6521 High Power</b>
<i>Operating Channel (2.4 GHz)</i>	Channel 1 to 13 (2412 to 2472 MHz)
<i>Operating Channel 5.2 GHz)</i>	Channels 36 to 48; channels 149 - 165
<i>802.11a Data Rates</i>	6, 9, 12, 18, 24, 36, 48, 54 Mbps
<i>802.11b Data Rates</i>	1, 2, 5.5, 11 Mbps
<i>802.11g Data Rates</i>	6, 9, 12, 18, 24, 36, 48, 54 Mbps
<i>802.11n Data Rates</i>	MCS0 to MCS15 at both HT20 and HT40 modes
<i>Max Transmit Power (2.4GHz)</i>	27 dBm
<i>Max Transmit Power (5.2 GHz)</i>	22 dBm
<i>Transmit Power Adjustment</i>	1 dB

## 5 Regulatory Information

### 5.1 Regulatory Overview

This device is approved under the Motorola Solutions brand.

This guide applies to Part Numbers AP-6521-60010-US, AP-6521-60020-US, AP-6521-60010-WR and AP-6521-60020-WR. AP-6521 Series access points are approved under MODEL: NCAP-500.

All Motorola Solutions devices are designed to be compliant with rules and regulations in locations they are sold and will be labeled as required.

Any changes or modifications to Motorola Solutions equipment, not expressly approved by Motorola Solutions, could void the user's authority to operate the equipment.

Motorola Solutions Access Points must be professionally installed and configured so that the Radio Frequency Output Power will not exceed the maximum allowable limit for the country of operation.

Antennas: Use only the supplied or an approved replacement antenna. Unauthorized antennas, modifications, or attachments could cause damage and may violate regulations. Use of an unapproved antenna is illegal under FCC regulations subjecting the end user to fines and equipment seizure.

### 5.2 Wireless Device Country Approvals

Regulatory markings, subject to certification, are applied to the device signifying the radio(s) is/are approved for use in the following countries: United States, Canada, Japan, China, S. Korea, Australia, and Europe.

Please refer to the *Declaration of Conformity* (DoC) for details of other country markings. This is available at

<http://www.motorola.com/Business/US-EN/Document+Library/Declaration+of+Conformity>

**Note:** For 2.4GHz or 5GHz Products: Europe includes, Austria, Belgium, Bulgaria, Czech Republic, Cyprus, Denmark, Estonia, Finland, France, Germany, Greece, Hungary, Iceland, Ireland, Italy, Latvia, Liechtenstein, Lithuania, Luxembourg, Malta, Netherlands, Norway, Poland, Portugal, Romania, Slovak Republic, Slovenia, Spain, Sweden, Switzerland and the United Kingdom.



Operation of the device without regulatory approval is illegal.

### **5.2.1 Country Selection – Note for AP & Wireless Controller**

Select only the country in which you are using the device. Any other selection will make the operation of this device illegal. The US version of the Access Point will only have US listed in the country selection table. The US version will be sold / used in the US protectorates: American Samoa, Guam, Puerto Rico, US Virgin Islands.

### **5.2.2 Frequency of Operation – FCC and IC**

#### **5 GHz Only**

The use on UNII (Unlicensed National Information Infrastructure) Band 1 5150-5250 MHz and Band 3 5470 - 5725 MHz is restricted to indoor use only, any other use will make the operation of this device illegal.

Devices using the 5470 – 5725 MHz band shall not be capable of transmitting in the band 5600 - 5650 MHz in the US, this “Notched” band has been disabled in the US version of the Access Point.

#### **2.4 GHz Only**

The available channels for 802.11 b/g operation in the US are Channels 1 to 11. The range of channels is limited by firmware.

## **5.3 Health and Safety Recommendations**



### **5.3.1 Warnings for the use of Wireless Devices**

Please observe all warning notices with regard to the usage of wireless devices

### **5.3.2 Potentially Hazardous Atmospheres – Fixed Installations**

You are reminded of the need to observe restrictions on the use of radio devices in fuel depots, chemical plants etc. and areas where the air contains chemicals or particles (such as grain, dust, or metal powders).



### **5.3.3 Safety in Hospitals**

Wireless devices transmit radio frequency energy and may affect medical electrical equipment. When installed adjacent to other equipment, it is advised to verify that the adjacent equipment is not adversely affected.

### **Pacemakers**

Pacemaker manufacturers recommended that a minimum of 15cm (6 inches) be maintained between a handheld wireless device and a pacemaker to avoid potential interference with the pacemaker. These recommendations are consistent with independent research and recommendations by Wireless Technology Research.

Persons with Pacemakers:

- Should ALWAYS keep the device more than 15cm (6 inches) from their pacemaker when turned ON.
- Should not carry the device in a breast pocket.
- Should use the ear furthest from the pacemaker to minimize the potential for interference.
- If you have any reason to suspect that interference is taking place, turn OFF your device.

### **Other Medical Devices**

Please consult your physician or the manufacturer of the medical device, to determine if the operation of your wireless product may interfere with the medical device.

## **5.4 RF Exposure Guidelines**

### **5.4.1 Safety Information**

#### **Reducing RF Exposure—Use Properly**

Only operate the device in accordance with the instructions supplied.

## **5.5 International**

The device complies with internationally recognized standards covering human exposure to electromagnetic fields from radio devices. For information on “International” human exposure to electromagnetic fields refer to the Motorola Solutions *Declaration of Conformity* (DoC) at <http://www.motorola.com/Business/US-EN/Document+Library/Declaration+of+Conformity>

## **5.6 EU**

### **Remote and Standalone Antenna Configurations**

To comply with EU RF exposure requirements, antennas that are mounted externally at remote locations or operating near users at stand-alone desktop of similar configurations must operate with a minimum separation distance of 20 cm from all persons.

## 5.7 US and Canada

### ***Co-located statement***

To comply with FCC RF exposure compliance requirements, the antennas used with this transmitter must not be co-located, or operating in conjunction, with any other transmitter/antenna except those already approved in this filling.

### ***Remote and Standalone Antenna Configurations***

To comply with FCC RF exposure requirements, antennas that are mounted externally at remote locations or operating near users at stand-alone desktop of similar configurations must operate with a minimum separation distance of 20 cm from all persons.

## 5.8 Power Supply

This device is powered from either a model PWRS-147376-01R 48 volt power supply or a 802.3af compliant power source which is UL approved and certified by the appropriate agencies.

## 5.9 Radio Frequency Interference Requirements—FCC



This equipment has been tested and found to comply with the limits for a Class B digital device, pursuant to Part 15 of the FCC rules. These limits are designed to provide reasonable protection against harmful interference in a residential installation. This equipment generates, uses and can radiate radio frequency energy and, if not installed and used in accordance with the instructions, may cause harmful interference to radio communications. However there is no guarantee that interference will not occur in a particular installation. If this equipment does cause harmful interference to radio or television reception, which can be determined by turning the equipment off and on, the user is encouraged to try to correct the interference by one or more of the following measures:

- Increase the separation between the equipment and receiver
- Connect the equipment into an outlet on a circuit different from that to which the receiver is connected
- Consult the dealer or an experienced radio/TV technician for help

### ***Radio Transmitters (Part 15)***

This device complies with Part 15 of the FCC Rules. Operation is subject to the following two conditions: (1) this device may not cause harmful interference, and (2) this device must accept any interference received, including interference that may cause undesired operation.

Restricted Band 5.60 – 5.65 GHz

## 5.10 Radio Frequency Interference Requirements – Canada

This Class B digital apparatus complies with Canadian ICES-003.

Cet appareil numérique de la classe B est conforme à la norme NMB-003 du Canada.

### 5.10.1 Radio Transmitters

For RLAN Devices:

The use of 5 GHz RLAN's, for use in Canada, have the following restrictions:

- Restricted Band 5.60 – 5.65 GHz

This device complies with RSS 210 of Industry & Science Canada. Operation is subject to the following two conditions: (1) this device may not cause harmful interference and (2) this device must accept any interference received, including interference that may cause undesired operation.

Label Marking: The Term "IC:" before the radio certification only signifies that Industry Canada technical specifications were met.

## 5.11 CE Marking and European Economic Area (EEA)



The use of 2.4 GHz RLAN's, for use through the EEA, have the following restrictions:

- Maximum radiated transmit power of 100 mW EIRP in the frequency range 2.400 -2.4835 GHz.
- France, outside usage is restricted to 2.4 – 2.454 GHz.
- Italy requires a user license for outside usage.

## 5.12 Statement of Compliance

Motorola Solutions hereby, declares that this device is in compliance with the essential requirements and other relevant provisions of Directive 1999/5/EC. A Declaration of Conformity may be obtained from <http://www.motorola.com/Business/US-EN/Document+Library/Declaration+of+Conformity>.



## 5.13 Waste Electrical and Electronic Equipment (WEEE)



**English:** For EU Customers: All products at the end of their life must be returned to for recycling. For information on how to return product, please go to: [http://www.symbol.com/environmental\\_compliance](http://www.symbol.com/environmental_compliance).

**Čeština:** Pro zákazníky z EU: Všechny produkty je nutné po skončení jejich životnosti vrátit společnosti Symbol k recyklaci. Informace o způsobu vrácení produktu najdete na webové stránce: [http://www.symbol.com/environmental\\_compliance](http://www.symbol.com/environmental_compliance).

**Dansk:** Til kunder i EU: Alle produkter skal returneres til Symbol til recirkulering, når de er udtjent. Læs oplysningerne om returnering af produkter på: [http://www.symbol.com/environmental\\_compliance](http://www.symbol.com/environmental_compliance).

**Deutsch:** Für Kunden innerhalb der EU: Alle Produkte müssen am Ende ihrer Lebensdauer zum Recycling an Symbol zurückgesandt werden. Informationen zur Rücksendung von Produkten finden Sie unter [http://www.symbol.com/environmental\\_compliance](http://www.symbol.com/environmental_compliance).

**Eesti:** EL klientidele: kõik tooted tuleb nende eluea lõppedes tagastada taaskasutamise eesmärgil Symbol'ile. Lisainformatsiooni saamiseks toote tagastamise kohta külastage palun aadressi: [http://www.symbol.com/environmental\\_compliance](http://www.symbol.com/environmental_compliance).

**Español:** Para clientes en la Unión Europea: todos los productos deberán entregarse a Symbol al final de su ciclo de vida para que sean reciclados. Si desea más información sobre cómo devolver un producto, visite: [http://www.symbol.com/environmental\\_compliance](http://www.symbol.com/environmental_compliance).

**Ελληνικά:** Για πελάτες στην Ε.Ε.: Όλα τα προϊόντα, στο τέλος της διάρκειας ζωής τους, πρέπει να επιστρέφονται στην Symbol για ανακύκλωση. Για περισσότερες πληροφορίες σχετικά με την επιστροφή ενός προϊόντος, επισκεφθείτε τη διεύθυνση [http://www.symbol.com/environmental\\_compliance](http://www.symbol.com/environmental_compliance) στο Διαδίκτυο.

**Français :** Clients de l'Union Européenne : Tous les produits en fin de cycle de vie doivent être retournés à Symbol pour recyclage. Pour de plus amples informations sur le retour de produits, consultez : [http://www.symbol.com/environmental\\_compliance](http://www.symbol.com/environmental_compliance).

**Italiano:** per i clienti dell'UE: tutti i prodotti che sono giunti al termine del rispettivo ciclo di vita devono essere restituiti a Symbol al fine di consentirne il riciclaggio. Per informazioni sulle modalità di restituzione, visitare il seguente sito Web: [http://www.symbol.com/environmental\\_compliance](http://www.symbol.com/environmental_compliance).

**Latviešu:** ES klientiem: visi produkti pēc to kalpošanas mūža beigām ir jānogādā atpakaļ Symbol otrreizējai pārstrādei. Lai iegūtu informāciju par produktu nogādāšanu Symbol, lūdzu, skatiet: [http://www.symbol.com/environmental\\_compliance](http://www.symbol.com/environmental_compliance).

**Lietuvių:** ES vartotojams: visi gaminiai, pasibaigus jų eksploatacijos laikui, turi būti grąžinti utilizuoti į kompaniją „Symbol“. Daugiau informacijos, kaip grąžinti gaminį, rasite: [http://www.symbol.com/environmental\\_compliance](http://www.symbol.com/environmental_compliance).

**Magyar:** Az EU-ban vásárlóknak: Minden tönkrement termékét a Symbol vállalathoz kell eljuttatni újrahasznosítás céljából. A termék visszajuttatásának módjával kapcsolatos tudnivalóért látogasson el a [http://www.symbol.com/environmental\\_compliance](http://www.symbol.com/environmental_compliance) weboldalra

**Malti:** Għal klijenti fl-UE: il-prodotti kollha li jkunu waslu fl-aħħar tal-hajja ta' l-użu tagħhom, iridu jiġu rritornati għand Symbol għar-riċiklaġġ. Għal aktar tagħrif dwar kif għandek tirritorna l-prodott, jekk jogħġbok żur: [http://www.symbol.com/environmental\\_compliance](http://www.symbol.com/environmental_compliance).

**Nederlands:** Voor klanten in de EU: alle producten dienen aan het einde van hun levensduur naar Symbol te worden teruggezonden voor recycling. Raadpleeg [http://www.symbol.com/environmental\\_compliance](http://www.symbol.com/environmental_compliance) voor meer informatie over het terugzenden van producten.

**Polski:** Klienci z obszaru Unii Europejskiej: Produkty wycofane z eksploatacji należy zwrócić do firmy Symbol w celu ich utylizacji. Informacje na temat zwrotu produktów znajdują się na stronie internetowej [http://www.symbol.com/environmental\\_compliance](http://www.symbol.com/environmental_compliance).

**Português:** Para clientes da UE: todos os produtos no fim de vida devem ser devolvidos à Symbol para reciclagem. Para obter informações sobre como devolver o produto, visite: [http://www.symbol.com/environmental\\_compliance](http://www.symbol.com/environmental_compliance).

**Slovenski:** Za kupce v EU: vsi izdelki se morajo po poteku življenjske dobe vrniti podjetju Symbol za reciklažo. Za informacije o vračilu izdelka obiščite: [http://www.symbol.com/environmental\\_compliance](http://www.symbol.com/environmental_compliance).

**Slovenščina:** Pre zákazníkov z krajín EU: Všetky výrobky musia byť po uplynutí doby ich životnosti vrátené spoločnosti Symbol na recykláciu. Bližšie informácie o vrátení výrobkov nájdete na: [http://www.symbol.com/environmental\\_compliance](http://www.symbol.com/environmental_compliance).

**Suomi:** Asiakkaat Euroopan unionin alueella: Kaikki tuotteet on palautettava kierrätettäväksi Symbol-yhtiöön, kun tuotetta ei enää käytetä. Lisätietoja tuotteiden palauttamisesta on osoitteessa [http://www.symbol.com/environmental\\_compliance](http://www.symbol.com/environmental_compliance).

## 5.14 TURKISH WEEE Statement of Compliance

EEE Yönetmeliğine Uygundur

## 5.15 Japan (VCCI) - Voluntary Control Council for Interference Class B ITE

この装置は、情報処理装置等電波障害自主規制協議会（VCCI）の基準に基づくクラスB情報技術装置です。この装置は、家庭環境で使用することを目的としていますが、この装置がラジオやテレビジョン受信機に近接して使用されると、受信障害を引き起こすことがあります。取扱説明書に従って正しい取り扱いをして下さい。

This is a Class B product based on the standard of the Voluntary Control Council for Interference from Information Technology Equipment (VCCI). If this is used near a radio or television receiver in a domestic environment, it may cause radio interference. Install and use the equipment according to the instruction manual.

## 5.16 Korea Warning Statement for Class B ITE

기종별	사용자안내문
B급 기기 (가정용 방송통신기기)	이 기기는 가정용 (B급) 으로 전자파적합등록을 한 기기로서 주로 가정에서 사용하는 것을 목적으로 하며, 모든 지역에서 사용할 수 있습니다.
Class B (Broadcasting Communication Device for Home Use)	This device obtained EMC registration mainly for home use (Class B) and may be used in all areas.

## 5.17 Other Countries

### 5.17.1 Australia

Use of 5 GHz RLAN's in Australia is restricted in the following band 5.50 – 5.65 GHz.

### 5.17.2 Brazil

Regulatory declarations for - BRAZIL

Note: The certification mark applied to the AP-6521x is for Restrict Radiation Equipment. This equipment operates on a secondary basis and does not have the right for protection against harmful interference from other users including same equipment types. Also this equipment must not cause interference to systems operating on primary basis.

For more information consult the website <http://www.anatel.gov.br>

Declarações Regulamentares para - Brasil

Nota: "A marca de certificação se aplica ao Transceptor, modelo AP-6521x. Este equipamento opera em caráter secundário, isto é, não tem direito a proteção contra interferência prejudicial, mesmo de estações do mesmo tipo, e não pode causar interferência a sistemas operando em caráter primário."

Para maiores informações sobre ANATEL consulte o site: <http://www.anatel.gov.br>

### 5.17.3 Chile

"Este equipo cumple con la Resolución No 403 de 2008, de la Subsecretaria de telecomunicaciones, relativa a radiaciones electromagnéticas."

"This device complies with the Resolution Not 403 of 2008, of the Undersecretary of telecommunications, relating to electromagnetic radiation."

### 5.17.4 Mexico

Restrict Frequency Range to: 2.450 – 2.4835 GHz.

### 5.17.5 Taiwan

NOTICE!

According to: Administrative Regulations on Low Power Radio Waves Radiated Devices

Article 12

Without permission granted by the DGT, any company, enterprise, or user is not allowed to change frequency, enhance transmitting power or alter original characteristic as well as performance to an approved low power radio-frequency devices.

Article 14

The low power radio-frequency devices shall not influence aircraft security and interfere legal communications; If found, the user shall cease operating immediately until no interference is achieved.

The said legal communications means radio communications is operated in compliance with the Telecommunications Act.

The low power radio-frequency devices must be susceptible with the interference from legal communications or ISM radio wave radiated devices.

#### 臺灣

低功率電波輻射性電機管理辦法

#### 第十二條

經型式認證合格之低功率射頻電機，非經許可，公司、商號或使用者均不得擅自變更頻率、加大功率或變更原設計之特性及功能。

#### 第十四條

低功率射頻電機之使用不得影響飛航安全及干擾合法通信；經發現有干擾現象時，應立即停用，並改善至無干擾時方得繼續使用。

前項合法通信，指依電信規定作業之無線電通信。

低功率射頻電機須忍受合法通信或工業、科學及醫療用電波輻射性電機設備之干擾。

Wireless device operate in the frequency band of 5.25-5.35 GHz, limited for Indoor use only.

在 5.25–5.35 赫頻帶內操作之無線資訊傳輸設備，限於室內使用。

### **5.17.6 Korea**

For radio equipment using 2400~2483.5MHz or 5725~5825MHz, the following expressions should be displayed:

1. "This radio equipment can be interfered with during operation."

당해 무선설비는 운용 중 전파혼신 가능성이 있음

2. "This radio equipment cannot provide a service relevant to human life safety, as it can be crossed" through the user manual, etc.

당해 무선설비 는전파혼 신 가능성이 있으므로 인명안전과 관련된 서비스는 할 수 없습니다

## **6 Motorola Solutions Enterprise Mobility Support Center**

If you have a problem with your equipment, contact Enterprise Mobility support for your region. Contact information is available by visiting <http://supportcentral.motorola.com> and after selecting your region, click on the appropriate link under Support for Business.

When contacting Enterprise Mobility support, please provide the following information:

- *Serial number of the unit*
- *Model number or product name*
- *Software type and version number*

Motorola Solutions responds to calls by email, telephone or fax within the time limits set forth in support agreements. If you purchased your Enterprise Mobility business product from a Motorola Solutions business partner, contact that business partner for support.

### **6.1 Customer Support Web Sites**

Motorola Solutions's Support Central Web site, located at <http://supportcentral.motorola.com> provides information and online assistance including developer tools, software downloads, product manuals and online repair requests.

### **6.2 Manuals**

<http://support.symbol.com/support/product/manuals.do>



**MOTOROLA SOLUTIONS INC.**  
**1303 E. ALGONQUIN ROAD**  
**SCHAUMBURG, IL 60196**  
**<http://www.motorolasolutions.com>**



**72-155456-01 Revision A**  
**August 2011**