



Configuring Security on VSP Operating System Software

Release 6.0
NN47227-601
Issue 07.02
November 2016

Notice

While reasonable efforts have been made to ensure that the information in this document is complete and accurate at the time of printing, Avaya assumes no liability for any errors. Avaya reserves the right to make changes and corrections to the information in this document without the obligation to notify any person or organization of such changes.

Documentation disclaimer

"Documentation" means information published in varying mediums which may include product information, operating instructions and performance specifications that are generally made available to users of products. Documentation does not include marketing materials. Avaya shall not be responsible for any modifications, additions, or deletions to the original published version of Documentation unless such modifications, additions, or deletions were performed by or on the express behalf of Avaya. End User agrees to indemnify and hold harmless Avaya, Avaya's agents, servants and employees against all claims, lawsuits, demands and judgments arising out of, or in connection with, subsequent modifications, additions or deletions to this documentation, to the extent made by End User.

Link disclaimer

Avaya is not responsible for the contents or reliability of any linked websites referenced within this site or Documentation provided by Avaya. Avaya is not responsible for the accuracy of any information, statement or content provided on these sites and does not necessarily endorse the products, services, or information described or offered within them. Avaya does not guarantee that these links will work all the time and has no control over the availability of the linked pages.

Warranty

Avaya provides a limited warranty on Avaya hardware and software. Refer to your sales agreement to establish the terms of the limited warranty. In addition, Avaya's standard warranty language, as well as information regarding support for this product while under warranty is available to Avaya customers and other parties through the Avaya Support website: <https://support.avaya.com/helpcenter/getGenericDetails?detailId=C20091120112456651010> under the link "Warranty & Product Lifecycle" or such successor site as designated by Avaya. Please note that if You acquired the product(s) from an authorized Avaya Channel Partner outside of the United States and Canada, the warranty is provided to You by said Avaya Channel Partner and not by Avaya.

"Hosted Service" means an Avaya hosted service subscription that You acquire from either Avaya or an authorized Avaya Channel Partner (as applicable) and which is described further in Hosted SAS or other service description documentation regarding the applicable hosted service. If You purchase a Hosted Service subscription, the foregoing limited warranty may not apply but You may be entitled to support services in connection with the Hosted Service as described further in your service description documents for the applicable Hosted Service. Contact Avaya or Avaya Channel Partner (as applicable) for more information.

Hosted Service

THE FOLLOWING APPLIES ONLY IF YOU PURCHASE AN AVAYA HOSTED SERVICE SUBSCRIPTION FROM AVAYA OR AN AVAYA CHANNEL PARTNER (AS APPLICABLE), THE TERMS OF USE FOR HOSTED SERVICES ARE AVAILABLE ON THE AVAYA WEBSITE, [HTTPS://SUPPORT.AVAYA.COM/LICENSEINFO](https://support.avaya.com/LICENSEINFO) UNDER THE LINK "Avaya Terms of Use for Hosted Services" OR SUCH SUCCESSOR SITE AS DESIGNATED BY AVAYA, AND ARE APPLICABLE TO ANYONE WHO ACCESSES OR USES THE HOSTED SERVICE. BY ACCESSING OR USING THE HOSTED SERVICE, OR AUTHORIZING OTHERS TO DO SO, YOU, ON BEHALF OF YOURSELF AND THE ENTITY FOR WHOM YOU ARE DOING SO (HEREINAFTER REFERRED TO INTERCHANGEABLY AS "YOU" AND "END USER"), AGREE TO THE TERMS OF USE. IF YOU ARE ACCEPTING THE TERMS OF USE ON BEHALF A COMPANY OR OTHER LEGAL ENTITY, YOU REPRESENT THAT YOU HAVE THE AUTHORITY TO BIND SUCH ENTITY TO THESE TERMS OF USE. IF YOU DO NOT HAVE SUCH AUTHORITY, OR

IF YOU DO NOT WISH TO ACCEPT THESE TERMS OF USE, YOU MUST NOT ACCESS OR USE THE HOSTED SERVICE OR AUTHORIZE ANYONE TO ACCESS OR USE THE HOSTED SERVICE.

Licenses

THE SOFTWARE LICENSE TERMS AVAILABLE ON THE AVAYA WEBSITE, [HTTPS://SUPPORT.AVAYA.COM/LICENSEINFO](https://support.avaya.com/LICENSEINFO), UNDER THE LINK "AVAYA SOFTWARE LICENSE TERMS (Avaya Products)" OR SUCH SUCCESSOR SITE AS DESIGNATED BY AVAYA, ARE APPLICABLE TO ANYONE WHO DOWNLOADS, USES AND/OR INSTALLS AVAYA SOFTWARE, PURCHASED FROM AVAYA INC., ANY AVAYA AFFILIATE, OR AN AVAYA CHANNEL PARTNER (AS APPLICABLE) UNDER A COMMERCIAL AGREEMENT WITH AVAYA OR AN AVAYA CHANNEL PARTNER. UNLESS OTHERWISE AGREED TO BY AVAYA IN WRITING, AVAYA DOES NOT EXTEND THIS LICENSE IF THE SOFTWARE WAS OBTAINED FROM ANYONE OTHER THAN AVAYA, AN AVAYA AFFILIATE OR AN AVAYA CHANNEL PARTNER; AVAYA RESERVES THE RIGHT TO TAKE LEGAL ACTION AGAINST YOU AND ANYONE ELSE USING OR SELLING THE SOFTWARE WITHOUT A LICENSE. BY INSTALLING, DOWNLOADING OR USING THE SOFTWARE, OR AUTHORIZING OTHERS TO DO SO, YOU, ON BEHALF OF YOURSELF AND THE ENTITY FOR WHOM YOU ARE INSTALLING, DOWNLOADING OR USING THE SOFTWARE (HEREINAFTER REFERRED TO INTERCHANGEABLY AS "YOU" AND "END USER"), AGREE TO THESE TERMS AND CONDITIONS AND CREATE A BINDING CONTRACT BETWEEN YOU AND AVAYA INC. OR THE APPLICABLE AVAYA AFFILIATE ("AVAYA").

Avaya grants You a license within the scope of the license types described below, with the exception of Heritage Nortel Software, for which the scope of the license is detailed below. Where the order documentation does not expressly identify a license type, the applicable license will be a Designated System License. The applicable number of licenses and units of capacity for which the license is granted will be one (1), unless a different number of licenses or units of capacity is specified in the documentation or other materials available to You. "Software" means computer programs in object code, provided by Avaya or an Avaya Channel Partner, whether as stand-alone products, pre-installed on hardware products, and any upgrades, updates, patches, bug fixes, or modified versions thereto. "Designated Processor" means a single stand-alone computing device. "Server" means a Designated Processor that hosts a software application to be accessed by multiple users. "Instance" means a single copy of the Software executing at a particular time: (i) on one physical machine; or (ii) on one deployed software virtual machine ("VM") or similar deployment.

Licence types

Designated System(s) License (DS). End User may install and use each copy or an Instance of the Software only on a number of Designated Processors up to the number indicated in the order. Avaya may require the Designated Processor(s) to be identified in the order by type, serial number, feature key, Instance, location or other specific designation, or to be provided by End User to Avaya through electronic means established by Avaya specifically for this purpose.

Heritage Nortel Software

"Heritage Nortel Software" means the software that was acquired by Avaya as part of its purchase of the Nortel Enterprise Solutions Business in December 2009. The Heritage Nortel Software is the software contained within the list of Heritage Nortel Products located at <https://support.avaya.com/LicenseInfo> under the link "Heritage Nortel Products" or such successor site as designated by Avaya. For Heritage Nortel Software, Avaya grants Customer a license to use Heritage Nortel Software provided hereunder solely to the extent of the authorized activation or authorized usage level, solely for the purpose specified in the Documentation, and solely as embedded in, for execution on, or for communication with Avaya equipment. Charges for Heritage Nortel Software may be based on extent of activation or use authorized as specified in an order or invoice.

Copyright

Except where expressly stated otherwise, no use should be made of materials on this site, the Documentation, Software, Hosted Service, or hardware provided by Avaya. All content on this site, the

documentation, Hosted Service, and the product provided by Avaya including the selection, arrangement and design of the content is owned either by Avaya or its licensors and is protected by copyright and other intellectual property laws including the sui generis rights relating to the protection of databases. You may not modify, copy, reproduce, republish, upload, post, transmit or distribute in any way any content, in whole or in part, including any code and software unless expressly authorized by Avaya. Unauthorized reproduction, transmission, dissemination, storage, and or use without the express written consent of Avaya can be a criminal, as well as a civil offense under the applicable law.

Virtualization

The following applies if the product is deployed on a virtual machine. Each product has its own ordering code and license types. Note that each Instance of a product must be separately licensed and ordered. For example, if the end user customer or Avaya Channel Partner would like to install two Instances of the same type of products, then two products of that type must be ordered.

Third Party Components

"Third Party Components" mean certain software programs or portions thereof included in the Software or Hosted Service may contain software (including open source software) distributed under third party agreements ("Third Party Components"), which contain terms regarding the rights to use certain portions of the Software ("Third Party Terms"). As required, information regarding distributed Linux OS source code (for those products that have distributed Linux OS source code) and identifying the copyright holders of the Third Party Components and the Third Party Terms that apply is available in the products, Documentation or on Avaya's website at: <https://support.avaya.com/Copyright> or such successor site as designated by Avaya. The open source software license terms provided as Third Party Terms are consistent with the license rights granted in these Software License Terms, and may contain additional rights benefiting You, such as modification and distribution of the open source software. The Third Party Terms shall take precedence over these Software License Terms, solely with respect to the applicable Third Party Components to the extent that these Software License Terms impose greater restrictions on You than the applicable Third Party Terms.

The following applies only if the H.264 (AVC) codec is distributed with the product. THIS PRODUCT IS LICENSED UNDER THE AVC PATENT PORTFOLIO LICENSE FOR THE PERSONAL USE OF A CONSUMER OR OTHER USES IN WHICH IT DOES NOT RECEIVE REMUNERATION TO (i) ENCODE VIDEO IN COMPLIANCE WITH THE AVC STANDARD ("AVC VIDEO") AND/OR (ii) DECODE AVC VIDEO THAT WAS ENCODED BY A CONSUMER ENGAGED IN A PERSONAL ACTIVITY AND/OR WAS OBTAINED FROM A VIDEO PROVIDER LICENSED TO PROVIDE AVC VIDEO. NO LICENSE IS GRANTED OR SHALL BE IMPLIED FOR ANY OTHER USE. ADDITIONAL INFORMATION MAY BE OBTAINED FROM MPEG LA, L.L.C. SEE [HTTP://WWW.MPEGLA.COM](http://www.mpegla.com).

Service Provider

THE FOLLOWING APPLIES TO AVAYA CHANNEL PARTNER'S HOSTING OF AVAYA PRODUCTS OR SERVICES. THE PRODUCT OR HOSTED SERVICE MAY USE THIRD PARTY COMPONENTS SUBJECT TO THIRD PARTY TERMS AND REQUIRE A SERVICE PROVIDER TO BE INDEPENDENTLY LICENSED DIRECTLY FROM THE THIRD PARTY SUPPLIER. AN AVAYA CHANNEL PARTNER'S HOSTING OF AVAYA PRODUCTS MUST BE AUTHORIZED IN WRITING BY AVAYA AND IF THOSE HOSTED PRODUCTS USE OR EMBED CERTAIN THIRD PARTY SOFTWARE, INCLUDING BUT NOT LIMITED TO MICROSOFT SOFTWARE OR CODECS, THE AVAYA CHANNEL PARTNER IS REQUIRED TO INDEPENDENTLY OBTAIN ANY APPLICABLE LICENSE AGREEMENTS, AT THE AVAYA CHANNEL PARTNER'S EXPENSE, DIRECTLY FROM THE APPLICABLE THIRD PARTY SUPPLIER.

WITH RESPECT TO CODECS, IF THE AVAYA CHANNEL PARTNER IS HOSTING ANY PRODUCTS THAT USE OR EMBED THE G.729 CODEC, H.264 CODEC, OR H.265 CODEC, THE AVAYA CHANNEL PARTNER ACKNOWLEDGES AND AGREES THE AVAYA CHANNEL PARTNER IS RESPONSIBLE FOR ANY AND ALL RELATED FEES AND/OR ROYALTIES. THE G.729 CODEC IS LICENSED BY SIPRO LAB TELECOM INC. SEE

WWW.SIPRO.COM/CONTACT.HTML. THE H.264 (AVC) CODEC IS LICENSED UNDER THE AVC PATENT PORTFOLIO LICENSE FOR THE PERSONAL USE OF A CONSUMER OR OTHER USES IN WHICH IT DOES NOT RECEIVE REMUNERATION TO: (I) ENCODE VIDEO IN COMPLIANCE WITH THE AVC STANDARD ("AVC VIDEO") AND/OR (II) DECODE AVC VIDEO THAT WAS ENCODED BY A CONSUMER ENGAGED IN A PERSONAL ACTIVITY AND/OR WAS OBTAINED FROM A VIDEO PROVIDER LICENSED TO PROVIDE AVC VIDEO. NO LICENSE IS GRANTED OR SHALL BE IMPLIED FOR ANY OTHER USE. ADDITIONAL INFORMATION FOR H.264 (AVC) AND H.265 (HEVC) CODECS MAY BE OBTAINED FROM MPEG LA, L.L.C. SEE [HTTP://WWW.MPEGLA.COM](http://WWW.MPEGLA.COM).

Compliance with Laws

You acknowledge and agree that it is Your responsibility for complying with any applicable laws and regulations, including, but not limited to laws and regulations related to call recording, data privacy, intellectual property, trade secret, fraud, and music performance rights, in the country or territory where the Avaya product is used.

Preventing Toll Fraud

"Toll Fraud" is the unauthorized use of your telecommunications system by an unauthorized party (for example, a person who is not a corporate employee, agent, subcontractor, or is not working on your company's behalf). Be aware that there can be a risk of Toll Fraud associated with your system and that, if Toll Fraud occurs, it can result in substantial additional charges for your telecommunications services.

Avaya Toll Fraud intervention

If You suspect that You are being victimized by Toll Fraud and You need technical assistance or support, call Technical Service Center Toll Fraud Intervention Hotline at +1-800-643-2353 for the United States and Canada. For additional support telephone numbers, see the Avaya Support website: <https://support.avaya.com> or such successor site as designated by Avaya.

Security Vulnerabilities

Information about Avaya's security support policies can be found in the Security Policies and Support section of <https://support.avaya.com/security>.

Suspected Avaya product security vulnerabilities are handled per the Avaya Product Security Support Flow (<https://support.avaya.com/css/P8/documents/100161515>).

Downloading Documentation

For the most current versions of Documentation, see the Avaya Support website: <https://support.avaya.com>, or such successor site as designated by Avaya.

Contact Avaya Support

See the Avaya Support website: <https://support.avaya.com> for product or Hosted Service notices and articles, or to report a problem with your Avaya product or Hosted Service. For a list of support telephone numbers and contact addresses, go to the Avaya Support website: <https://support.avaya.com> (or such successor site as designated by Avaya), scroll to the bottom of the page, and select Contact Avaya Support.

Trademarks

The trademarks, logos and service marks ("Marks") displayed in this site, the Documentation, Hosted Service(s), and product(s) provided by Avaya are the registered or unregistered Marks of Avaya, its affiliates, its licensors, its suppliers, or other third parties. Users are not permitted to use such Marks without prior written consent from Avaya or such third party which may own the Mark. Nothing contained in this site, the Documentation, Hosted Service(s) and product(s) should be construed as granting, by implication, estoppel, or otherwise, any license or right in and to the Marks without the express written permission of Avaya or the applicable third party.

Avaya is a registered trademark of Avaya Inc.

All non-Avaya trademarks are the property of their respective owners. Linux® is the registered trademark of Linus Torvalds in the U.S. and other countries.

Contents

Chapter 1: Introduction	10
Purpose	10
Chapter 2: New in this document	11
Release 6.0.....	11
Chapter 3: Security	13
Security overview.....	13
Security modes.....	14
hsecure mode.....	15
CLI passwords.....	16
Port Lock feature.....	17
Access policies for services.....	17
User-based policy support.....	17
Denial-of-service attack prevention.....	18
Configuration considerations.....	19
Interoperability configuration.....	20
Unicast Reverse Path Forwarding (uRPF).....	20
Security configuration using CLI.....	21
Enabling hsecure.....	21
Changing an invalid-length password.....	23
Changing passwords.....	24
Configuring directed broadcast.....	26
Preventing certain types of DOS attacks.....	27
Configuring port lock.....	28
Unicast Reverse Path Forwarding configuration using CLI.....	29
Security configuration using Enterprise Device Manager.....	40
Enabling port lock.....	40
Locking a port.....	40
Changing passwords.....	41
Configuring directed broadcast on a VLAN.....	43
Unicast Reverse Path Forwarding configuration using EDM.....	44
Viewing ASG global configuration.....	46
Viewing active ASG accounts.....	46
Chapter 4: First Hop Security	48
IPv6 First Hop Security.....	48
What is IPv6?.....	48
IPv6 security concerns.....	48
First Hop Security.....	49
Capturing and verifying FHS specific packets against the configured policies.....	55
Limitations.....	56

Guidelines for FHS configuration.....	56
DHCP snooping and Neighbor Discovery inspection.....	60
IPv6 FHS configuration using CLI.....	62
FHS configuration.....	62
DHCPv6-guard policy configuration.....	67
RA-guard configuration.....	72
IPv6 DHCP snooping configuration.....	78
IPv6 Neighbor Discovery inspection configuration.....	82
IPv6 FHS configuration using EDM.....	85
Configuring FHS Globals.....	86
IPv6 access list configuration.....	86
MAC access list configuration.....	88
DHCPv6-guard policy configuration.....	90
RA-guard policy configuration.....	93
Port policy mapping configuration.....	97
Configuring IPv6 DHCP snooping and ND inspection.....	99
First Hop Security example scenario.....	102
FHS deployment scenario.....	102
Creating FHS IPv6 ACL.....	103
Creating an FHS MAC ACL.....	104
Creating a DHCPv6-guard policy for the router.....	104
Creating an RA-guard policy for the router.....	105
Attaching FHS policies to the interfaces.....	105
IPv6 DHCP Snooping and ND Inspection configuration example.....	106
Chapter 5: Extensible Authentication Protocol over LAN.....	107
EAPoL fundamentals.....	107
EAPoL terminology.....	107
EAPoL configuration.....	108
EAPoL system requirements.....	112
EAPoL dynamic VLAN assignment.....	112
Traffic forwarding on EAPoL enabled port.....	116
RADIUS-assigned VLAN.....	117
Non-EAP host.....	120
Non-EAP client.....	121
EAPoL configuration using CLI.....	122
Globally enabling EAPoL on the device.....	123
Configuring EAPoL on an interface.....	123
Configuring EAPoL on a port.....	124
Configuring an EAPoL-enabled RADIUS server.....	126
Configuring the switch for EAPoL and RADIUS.....	128
Changing the authentication status of a port.....	129
Deleting an EAPoL-enabled RADIUS server.....	130
Displaying the current EAPoL-based security status.....	131

Configuring the format of the RADIUS password attribute when authenticating non-EAP MAC addresses using RADIUS.....	133
Enabling RADIUS authentication of non-EAPoL hosts on EAPoL enabled ports.....	134
Configuring the maximum MAC clients.....	134
Clearing Non-EAPoL session.....	135
EAPoL configuration using Enterprise Device Manager.....	135
Globally configuring EAPoL on the server.....	136
Configuring EAPoL on a port.....	137
Showing the Port Access Entity Port table.....	139
Showing EAPoL Authentication.....	140
Viewing Multihost status information.....	141
Viewing EAPoL session statistics.....	142
Viewing non-EAPoL MAC information.....	142
Chapter 6: IPsec.....	144
IPsec fundamentals.....	144
Authentication header.....	146
Encapsulating security payload.....	147
IPsec modes.....	147
Security association.....	148
Security policy.....	148
IPsec limitations.....	149
IPsec configuration using CLI.....	149
Creating an IPsec policy.....	149
Enabling an IPsec policy.....	150
Creating an IPsec security association.....	151
Configuring an IPsec security association.....	152
Configuring an IPsec policy.....	155
Linking the IPsec security association to an IPsec policy.....	157
Enabling IPsec on an interface.....	158
Linking an IPsec policy to an interface.....	159
Enabling IPsec on a management interface.....	160
Linking an IPsec policy to a management interface.....	161
Displaying IPsec information on an interface.....	162
Displaying configured IPsec policies.....	164
Displaying IPsec security association information.....	166
IPsec configuration using EDM.....	168
Creating an IPsec policy.....	168
Creating an IPsec security association.....	170
Linking the IPsec security association to an IPsec policy.....	172
Enabling IPsec on an interface.....	173
Linking an IPsec policy to an interface.....	174
IPsec configuration examples.....	175
IPsec configuration example.....	175

IPsec with ICMPv6 configuration example.....	176
OSPFv3 IPsec configuration example.....	178
OSPFv3 virtual link IPsec configuration example.....	185
IPsec configuration of TCP.....	188
Chapter 7: MACsec.....	191
MACsec fundamentals.....	191
MACsec keys.....	192
MACsec security modes.....	193
Connectivity associations and secure channels.....	194
MACsec 2AN and 4AN mode.....	194
MACsec components.....	194
MACsec operation.....	197
MACsec performance.....	198
MACsec configuration using CLI.....	198
Configuring a connectivity association.....	198
Updating the connectivity association key (CAK).....	200
Configuring MACsec encryption on a port.....	202
Configuring the confidentiality offset on a port.....	202
Viewing the MACsec connectivity association details.....	204
Viewing MACsec status.....	205
MACsec configuration using EDM.....	207
Configuring connectivity associations.....	207
Associating a port with a connectivity association.....	208
Chapter 8: RADIUS.....	210
RADIUS fundamentals.....	210
RADIUS configuration using CLI.....	213
Configuring RADIUS attributes.....	214
Configuring RADIUS profile.....	217
Enabling RADIUS authentication.....	217
Enabling the source IP flag for the RADIUS server.....	218
Enabling RADIUS accounting.....	218
Enabling RADIUS-SNMP accounting.....	219
Configuring RADIUS accounting interim request.....	221
Configuring RADIUS authentication and RADIUS accounting attributes.....	222
Adding a RADIUS server.....	224
Modifying RADIUS server settings.....	226
Showing RADIUS information.....	228
Displaying RADIUS server information.....	228
Showing RADIUS SNMP configurations.....	229
RADIUS configuration using Enterprise Device Manager.....	229
Enabling RADIUS authentication.....	230
Enabling RADIUS accounting.....	231
Disabling RADIUS accounting.....	232

Enabling RADIUS accounting interim request.....	233
Configuring the source IP option for the RADIUS server.....	234
Adding a RADIUS server.....	236
Reauthenticating the RADIUS SNMP server session.....	237
Configuring RADIUS SNMP.....	238
Modifying a RADIUS configuration.....	239
Deleting a RADIUS configuration.....	240
Chapter 9: Simple Network Management Protocol (SNMP)	242
SNMPv3.....	242
SNMP community strings.....	247
SNMPv3 support for VRF.....	249
SNMP configuration using CLI.....	249
Downloading the software.....	250
Configuring SNMP settings.....	251
Creating a user.....	254
Creating a new user group.....	255
Creating a new entry for the MIB in the view table.....	257
Creating a community.....	258
Adding a user to a group.....	259
Blocking SNMP.....	260
Displaying SNMP system information.....	261
SNMP configuration using Enterprise Device Manager.....	261
Creating a user.....	262
Creating a new group membership.....	264
Creating access for a group.....	265
Creating access policies for SNMP groups.....	266
Assigning MIB view access for an object.....	267
Creating a community.....	268
Viewing all contexts for an SNMP entity.....	269
Chapter 10: TACACS+	270
TACACS+ fundamentals.....	270
TACACS+ Operation.....	271
TACACS+ Architecture.....	272
Authentication, authorization, and accounting	272
Privilege level changes at runtime.....	276
TACACS+ and RADIUS differences.....	280
TACACS+ feature limitations.....	281
TACACS+ configuration using CLI	282
Enabling TACACS+.....	282
Adding a TACACS+ server.....	282
Configuring TACACS+ authentication.....	288
Configuring TACACS+ accounting.....	289
Configuring command authorization with TACACS+.....	290

Changing privilege levels at runtime.....	291
TACACS+ configuration using EDM.....	293
Configuring TACACS+ globally.....	293
Adding a TACACS+ server.....	295
Modifying a TACACS+ configuration.....	298
TACACS+ configuration examples.....	299
TACACS+ configuration on the switch.....	299
Identity Engine Ignition Server TACACS+ configuration example.....	300
Chapter 11: Resources.....	305
Support.....	305
Documentation.....	305
Training.....	305
Viewing Avaya Mentor videos.....	305
Searching a documentation collection.....	306
Subscribing to e-notifications.....	307
Glossary.....	310

Chapter 1: Introduction

Purpose

This document provides information on features in VSP Operating System Software (VOSS). VOSS runs on the following product families:

- Avaya Virtual Services Platform 4000 Series
- Avaya Virtual Services Platform 7200 Series
- Avaya Virtual Services Platform 8000 Series

This security documentation provides conceptual information and procedures that you can use to administer and configure the security features for the VOSS switches.

The security function includes tasks related to product security such as the management and protection of resources from unauthorized or detrimental access and use. This document includes information that supports the configuration and ongoing management of the following:

- communications
- data security
- user security
- access

Examples and network illustrations in this document may illustrate only one of the supported platforms. Unless otherwise noted, the concept illustrated applies to all supported platforms.

Chapter 2: New in this document

The following sections detail what is new in *Configuring Security*.

Important:

The features in this document might not apply to all hardware platforms. For more information about feature support, see *Release Notes*.

Release 6.0

Inclusion of VSP 4000

VOSS 6.0 updates this document to include the VSP 4000 Series. This document is now the single *Configuring Security* document for all VOSS platforms.

IPsec for the Out-of-band management port

This release adds IPsec support for IPv6 traffic on the out-of-band management interface.

Note:

This enhancement does not apply to VSP 4000.

For more information, see the following procedures:

- CLI:
 - [Enabling IPsec on a management interface](#) on page 160
 - [Linking an IPsec policy to a management interface](#) on page 161
 - [Displaying IPsec information on an interface](#) on page 162
- EDM:
 - [Enabling IPsec on an interface](#) on page 173
 - [Linking an IPsec policy to an interface](#) on page 174

MACsec enhancements

MACsec updates in this release enable enhanced security where multiple Secure Association (SA) Keys are internally derived from the configured Connectivity Association Key (CAK), to secure communication on the link. These SA Keys are periodically refreshed to ensure that the same key is not used for an extended period of time. From a provisioning perspective, the administrator still configures a single shared CAK on the two ends of the MACsec enabled link. This CAK is now used to internally derive multiple SA Keys. In order to differentiate the transmit and receive SA keys used

between two ends of a MACsec enabled link, one additional parameter has been added (`key-parity <even|odd>`). MACsec links should always be provisioned as odd/even pair.

For more information, see:

- [MACsec 2AN and 4AN mode](#) on page 194
- [Configuring a connectivity association](#) on page 198
- [Configuring connectivity associations](#) on page 207
- [Associating a port with a connectivity association](#) on page 208

Resources

Information about related resources is moved to the last chapter in this document.

Chapter 3: Security

This section provides conceptual content to help you configure and customize the security services on the switch.

Security overview

Security is a critical attribute of networking devices. Security features are split into two main areas:

- Control path—protects the access to the device from a management perspective.
- Data path—protects the network from malicious users by controlling access authorization to the network resources (such as servers and stations). This protection is primarily accomplished by using filters or access lists.

You can protect the control path using the following mechanism:

- logon and passwords
- access policies to specify the network and address that can use a service or daemon
- secure protocols, such as Secure Shell (SSH), Secure Copy (SCP), and the Simple Network Management Protocol version 3 (SNMPv3)
- the Message Digest 5 Algorithm (MD5) to protect routing updates, Open Shortest Path First (OSPF), and Border Gateway Protocol (BGP)

You can protect the data path using the following mechanism

- Media Access Control (MAC) address filtering
- Layer 3 filtering, such as Internet Protocol (IP) and User Datagram Protocol (UDP)/Transmission Control Protocol (TCP) filtering
- routing policies to prevent users from accessing restricted areas of the network
- mechanisms to prevent denial-of-service (DOS) attacks

Security modes

The switch support three security modes:

- Enhanced secure
- Hsecure
- SSH secure

Enable SSH secure mode to allow only SSH to be used and disable all other protocols which include Telnet, rlogin, FTP, SNMP, TFTP, HTTP, and HTTPS. Enabling this mode disables Telnet, rlogin, FTP, SNMP, TFTP, HTTP, and HTTPS by setting the boot flags for these protocols to off. You can over-ride the configuration and enable required protocols individually for run-time use. The administrator must enable required protocols individually for run-time use again following a reboot even if you save the configuration. This is because the SSH secure mode enable takes precedence at the time of reboot and the other protocols will be disabled even though the configuration file has them set to enabled.

*** Note:**

Disabling SSH secure mode will not automatically enable the OA&M protocols that were disabled. The boot flags for the required protocols will have to be individually set to enabled.

The following table lists the differences between enhanced secure mode and hsecure mode.

Table 1: Enhanced secure mode versus hsecure mode

Feature	Enhanced secure	Hsecure
Authentication	Role-based: <ul style="list-style-type: none"> • admin • privilege • operator • security • auditor 	Access-level based: <ul style="list-style-type: none"> • rwa • rw • ro • l3 • l2 • l1
Password length	Minimum of 8 characters with the exception of the Admin, which requires a minimum of 15 characters	10 characters, minimum
Password rules	1 or 2 upper case, lower case, numeric and special characters	Minimum of 2 upper case, 2 lower case, 2 numeric and 2 special characters
Password expiration	Per-user minimum change interval is enforced, which is programmed by the Administrator	Global expiration, configured by the Admin

Table continues...

Feature	Enhanced secure	Hsecure
Password-unique	Previous passwords and common passwords between users are prevented	The same
Password renewal	Automatic password renewal is enforced	The same
Audit logs	Audit logs are encrypted, and authorized users are able to view, modify, and delete.	Standard operation
SNMPv3	Password rules apply to SNMPv3 Auth&Priv. SNMPv3 is required (V1/V2 disabled)	SNMPv1 and SNMPv2 can be enabled.
EDM	Site Admin to enable or disable	Disabled
Telnet and FTP	Site Admin to enable or disable	The same
DOS attack Prevention	Not available	Prevents DOS attacks by filtering IP addresses and IP address ranges.

For information on Enhanced secure mode and SSH, see *Administering*.

hsecure mode

The switch supports a flag called high secure (hsecure). hsecure introduces the following behaviors for passwords:

- 10-character enforcement
- aging time
- limitation of failed logon attempts
- protection mechanism to filter certain IP addresses

After you enable the hsecure flag, the software enforces the 10-character rule for all passwords. This password must contain a minimum of two uppercase characters, two lowercase characters, two numbers, and two special characters.

After you enable hsecure, the system requires you to save the configuration file and reboot the system for hsecure to take effect. If the existing password does not meet the minimum requirements for hsecure, the system prompts you to change the password during the first login.

The default username is rwa and the default password is rwa. In hsecure, the system prompts you to change these during first login because they do not meet the minimum requirements for hsecure.

When you enable hsecure, the system disables Simple Network Management Protocol (SNMP) v1, SNMPv2 and SNMPv3. If you want to use SNMP, you must re-enable SNMP, using the command `no boot config flag block-snmp`.

Aging enforcement

After you enable the `hsecure` flag, you can configure a duration after which you must change your password. You configure the duration by using the `aging` parameter.

For SNMP and File Transfer Protocol (FTP), after a password expires, access is denied. Before you access the system, you must change a community string to a new string consisting of more than eight characters.

Important:

Consider the following after you enable the `hsecure` flag:

- You cannot enable the Web server for Enterprise Device Manager (EDM) access.
- You cannot enable the Secure Shell (SSH) password authentication.

For more information, see *Administering*.

Filtering mechanism

Incorrect IP source addresses as network or broadcast addresses are filtered at the virtual router interface. Source addresses 192.168.168.0 and 192.168.168.255 are discarded.

This change is valid for all IP subnets, not only for /24.

You can filter addresses only if you enable the `hsecure` mode.

CLI passwords

The switch ships with default passwords assigned for access to Command Line Interface (CLI) through a console or management session. If you have `read/write/all` access authority, and you are using SNMPv3, you can change passwords that are in an encrypted format. If you are using Enterprise Device Manager (EDM), you can also specify the number of available Telnet sessions and `rlogin` sessions.

Important:

The default passwords are documented and well known. Change the default passwords and community strings immediately after you first log on.

If you enable enhanced secure mode with the `boot config flags enhancedsecure-mode` command, you enable different access levels, along with stronger password complexity, length, and minimum change intervals. For more information on system access fundamentals and configuration, see *Administering*.

Port Lock feature

You can use the Port Lock feature to administratively lock a port or ports to prevent other users from changing port parameters or modifying port action. You cannot modify locked ports until the ports are first unlocked.

Access policies for services

You can control access to the switch by creating an access policy. An access policy specifies the hosts or networks that can access the device through various services, such as Telnet, SNMP, Trivial File Transfer Protocol (TFTP), File Transfer Protocol (FTP), Hypertext Transfer Protocol (HTTP), Remote Shell (RSH), and remote login (rlogin). You can enable or disable access services by setting flags from CLI.

You can define network stations that can explicitly access the switch or stations that cannot access it. For each service you can also specify the level of access, such as read-only or read-write-all.

Important:

A third-party security scan shows the switch service ports open and in the listen state. No connections are accepted on these ports unless you enable the particular daemon. The switch does not dynamically start and stop the daemons at runtime and needs to keep them running from system startup.

For more information about configuring access policies, see *Administering*.

User-based policy support

You can set up a user-based policy (UBP) system by using Enterprise Policy Manager (EPM), a RADIUS server.

EPM is an application designed to manage the traffic prioritization and network access security for business applications. It provides centralized control of advanced packet classification and the ability to priority mark, police, meter, or block traffic.

EPM 5.0 supports UBPs, which allow security administrators to establish and enforce roles and conditions for each user for all access ports in the network. The UBP feature in EPM works in conjunction with Extensible Access Protocol (EAP) technology to enhance the security of the network. Users log on to the networks and are authenticated as the network connection is established.

The UBP feature works as an extension to the Roles feature in EPM. In a UBP environment, role objects are linked directly to specific users (as RADIUS attributes), as opposed to being linked

simply to device interfaces. The role object then links the users to specific policies that control the user's access to the network.

When the RADIUS server successfully authenticates a user, the device sends an EAP session start event to the EPM policy server. The policy server then sends user-based policy configuration information for the new user roles to the interface, based on the role attribute that was assigned to that user on the RADIUS server.

Denial-of-service attack prevention

Hsecure

The switch supports a configurable flag, called high secure (hsecure). High secure mode introduces a protection mechanism to filter certain IP addresses, and two restrictions on passwords: 10-character enforcement and aging time.

If the device starts in hsecure mode with default factory settings, and no previously configured password, the system will prompt you to change the password. The new password must follow the rules mandated by high secure mode. After you enable hsecure and restart the system, if you have an invalid-length password you must change the password.

If you enable hsecure for the first time and the password file does not exist, then the device creates a normal default username (rwa) and password (rwa). In this case, the password does not meet the minimum requirements for hsecure and as a result the system prompts you to change the password.

The following information describes hsecure mode operations:

- When you enable the hsecure flag, after a certain duration you are asked to change your password. If not configured, the aging parameter defaults to 90 days.
- For SNMP and FTP, access is denied when a password expires. You must change the community strings to a new string made up of more than eight characters before accessing the system.
- You cannot enable the Web server at any time.
- You cannot enable the SSH password-authentication feature at any time.
-

Hsecure is disabled by default. When you enable hsecure, the desired behavior applies to all ports.

For more information, see [Preventing certain types of DOS attacks](#) on page 27.

Prioritization of control traffic

The switch uses a sophisticated prioritization scheme to schedule control packets on physical ports. This scheme involves two levels with both hardware and software queues to guarantee proper handling of control packets regardless of the switch load. In turn, this scheme guarantees the stability of the network. Prioritization also guarantees that applications that use many broadcasts are handled with lower priority.

You cannot view, configure, or modify control-traffic queues.

Directed broadcast suppression

You can enable or disable forwarding for directed broadcast traffic on an IP-interface basis. A directed broadcast is a frame sent to the subnet broadcast address on a remote IP subnet. By disabling or suppressing directed broadcasts on an interface, you cause all frames sent to the subnet broadcast address for a local router interface to be dropped. Directed broadcast suppression protects hosts from possible DoS attacks.

To prevent the flooding of other networks with DoS attacks, such as the Smurf attack, the switch is protected by directed broadcast suppression. This feature is enabled by default. It is recommended not to disable it.

For more information, see [Configuring directed broadcast](#) on page 26.

ARP request threshold recommendations

The Address Resolution Protocol (ARP) request threshold defines the maximum number of outstanding unresolved ARP requests. The default value for this function is 500 ARP requests. To avoid excessive amounts of subnet scanning that a virus can cause, it is recommended that you change the ARP request threshold to a value between 100 and 50. This configuration protects the CPU from causing excessive ARP requests, protects the network, and lessens the spread of the virus to other PCs. The following list provides further recommended ARP threshold values:

- Default: 500
- Severe conditions: 50
- Continuous scanning conditions: 100
- Moderate: 200
- Relaxed: 500

For more information about how to configure the ARP threshold, see *Configuring IPv4 Routing*.

Multicast Learning Limitation

The Multicast Learning Limitation feature protects the CPU from multicast data packet bursts generated by malicious applications. If more than a certain number of multicast streams enter the CPU through a port during a sampling interval, the port is shut down until the user or administrator takes the appropriate action.

For more information, see *Configuring IP Multicast Routing Protocols*.

Configuration considerations

Use the information in this section to understand the limitations of some security functions such as BSAC RADIUS servers and Layer 2 protocols before you attempt to configure security.

Single profile enhancement for BSAC RADIUS servers

Before enabling Remote Access Dial-In User Services (RADIUS) accounting on the device, you must configure at least one RADIUS server.

The switch software supports Microsoft Radius Servers (NPS Windows 2008, Windows 2003 IAS Server), BaySecure Access Control (BSAC), Merit Network servers and Linux based servers. To

use these servers, you must first obtain the software for the server. You must also make changes to one or more configuration files for these servers.

Single Profile is a feature that is specific to BSAC RADIUS servers. In a BSAC RADIUS server, when you create a client profile, you can specify all the returnable attributes. When you use the same profile for different products (Avaya Virtual Services Platform 8000 Series and Baystack 450, for example) you specify all the returnable attributes in the single profile.

Attribute format for a third-party RADIUS server

If you use a third-party RADIUS server and need to modify the dictionary files, you must add a vendor-specific attribute (attribute #26) and use 1584 as vendor code for all the devices and then send back access-priority vendor-assigned attribute number 192 with a decimal value of 1 to 6, depending upon whether you want read only to read-write-all.

RADIUS on management ports

The management port supports the RADIUS protocol. When RADIUS packets are sent out of the management port, the SRC-IP address is properly entered in the RADIUS header.

For more information about the supported RADIUS servers, see the documentation of the RADIUS server.

SNMP cloned user considerations

If the user from which you are cloning has authentication, you can choose for the new user to either have the same authentication protocol as the user from which it was cloned, or no authentication. If you choose authentication for the new user, you must provide a password for that user. If you want a new user to have authentication, you must indicate that at the time you create the new user. You can assign a privacy protocol only to a user that has authentication.

If the user from which you are cloning has no authentication, then the new user has no authentication.

Interoperability configuration

The switch is compatible with RADIUS servers.

You can search the InSite Knowledge Base on the Avaya Support site at www.avaya.com/support. Use the Advanced Search option to narrow your search to specific categories (products) and document types.

Unicast Reverse Path Forwarding (uRPF)

The Unicast Reverse Path Forwarding (uRPF) feature prevents packet forwarding for incoming unicast IP packets that have incorrect or forged (spoofed) IP addresses. The uRPF feature checks that the traffic received on an interface comes from a valid IP address, thereby preventing address spoofing. On a reverse path check, if the source IP address of the received packet at the interface is

not reachable using the FIB, the system drops the packet as the packet may have originated from a misconfigured or a malicious source.

You can configure uRPF for each IP interface or VLAN. When uRPF is enabled on an interface, the switch checks all routing packets that come through that interface. It ensures that the source address and source interface appear in the routing table, and that it matches the interface, on which the packet was received.

You can use one of two modes for uRPF:

- **Strict mode:** In strict mode, uRPF checks whether the source IP address of the incoming packet exists in the FIB. If the incoming interface is not the best reverse path, the packet check fails and uRPF drops the packet. If the routing engine finds the source IP entry, uRPF further checks if the source IP interface matches the incoming interface of the packet. If they match, the system forwards the packet as usual, otherwise, the system discards the packet.

*** Note:**

The number of packets dropped due to uRPF check on the ingress interface gets incremented along with other general dropped statistics under the `IN-DISCARD` column in the output of the command `show interfaces gigabitEthernet error <collision|verbose> {slot/port[-slot/port] [,...]}`.

- **Loose mode:** In loose mode, uRPF checks whether the source IP address of the incoming packet exists in the FIB. The packet is dropped only if the source address is not reachable via any interface on that router.

uRPF can be enabled independently for IPv4 and IPv6. However, on a given interface, if uRPF is enabled for both IPv4 and IPv6, the `urpf-mode` can be either `strict-mode` or `loose-mode` for both IPv4 and IPv6. That means we cannot have IPv4 `urpf-mode` configured differently than that of IPv6.

*** Note:**

uRPF check cannot detect spoofed source IP address if the source IP address belongs to a known subnet.

Security configuration using CLI

Configure security information used on the control and data paths to protect the network from uncontrolled access to network resources.

For more information about how to configure passwords and access policies, see *Administering*.

Enabling hsecure

The `hsecure` flag is disabled by default. When you enable it, the software enforces the 10 character rule for all passwords.

About this task

When you upgrade from a previous release, if the password does not have at least 10 characters, you receive a prompt to change your password to the mandatory 10-character length.

If you enable hsecure for the first time and the password file does not exist, then the device creates a normal default username (*rwa*) and password (*rwa*). In this case, the password does not meet the minimum requirements for hsecure and as a result the system prompts you to change the password.

Procedure

1. Enter Global Configuration mode:

```
enable
configure terminal
```

2. Enable or disable hsecure mode:

```
boot config flags hsecure
```

The following warning messages appear:

```
Warning: For security purposes, all unsecure services - TFTP, FTP, Rlogin, Telnet,
SNMP are disabled. Individually enable the required services.
Warning: Please save boot configuration and reboot the switch for this to take
effect.
```

3. Save the configuration and restart the device for the change to take effect.

Example

```
Switch:1> enable
```

```
Switch:1# configure terminal
```

Enable hsecure mode:

```
Switch:1(config)# boot config flags hsecure
```

```
Warning: For security purposes, all unsecure services - TFTP, FTP,
Rlogin, Telnet, SNMP are disabled. Individually enable the required
services. Warning: Please save boot configuration and reboot the switch
for this to take effect.
```

Save the configuration:

```
Switch:1(config)# save config
```

Restart the switch:

```
Switch:1(config)# reset
```

```
Are you sure you want to reset the switch (y/n)? y
```

Changing an invalid-length password

Before you begin

Important:

When you enable `hsecure`, passwords must contain a minimum of 10 characters or numbers with a maximum of 20. The password must contain a minimum of: two uppercase characters, two lowercase characters, two numbers, and two special characters.

About this task

After you enable `hsecure` and restart the system, change your password if you have an invalid-length password.

Procedure

1. At the CLI prompt, log on to the system.
2. Enter the password.

When you have an invalid-length password, the following message appears:

```
Your password is valid but less than mandatory 10 characters.  
Please change the password to continue.
```

3. When prompted, enter the new password.
4. When prompted, reenter the new password.

Example

Log on to the switch:

```
Login: rwa
```

Enter the password:

```
Password: ***
```

```
Your password is valid but less than mandatory 10 characters. Please  
chnage the password to continue.
```

Enter the new password:

```
Enter the new password: *****
```

Re-enter the new password:

```
Re-enter the new password: *****
```

```
Password successfully changed.
```

Changing passwords

Configure new passwords for each access level, or change the logon or password for the different access levels of the switch. After you receive the switch, use default passwords to initially access CLI. If you use Simple Network Management Protocol version 3 (SNMPv3), you can change encrypted passwords.

Before you begin

- You must use an account with read-write-all privileges to change passwords. For security, the switch saves passwords to a hidden file.

About this task

If you enable the hsecure flag, after the aging time expires, the system prompts you to change your password. If you do not configure the aging time, the default is 90 days.

Procedure

1. Enter Global Configuration mode:

```
enable
configure terminal
```

2. Change a password:

```
cli password WORD<1-20> {layer1|layer2|layer3|read-only|read-write|
read-write-all}
```

3. Enter the old password.
4. Enter the new password.
5. Enter the new password a second time.

6. Configure password options:

```
password access-level WORD<2-8>
password aging-time day <1-365>
password default-lockout-time <60-65000>
password lockout WORD<0-46> [time <60-65000>]
password min-passwd-len <10-20>
password password-history <3-32>
```

Example

```
Switch:1>enable
```

```
Switch:1#configure terminal
```

Change a password:

```
Switch:1(config)#password smith read-write-all
```

Enter the old password:

```
Switch:1 (config) #*****
```

Enter the new password:

```
Switch:1 (config) #*****
```

Enter the new password a second time:

```
Switch:1 (config) #*****
```

Set password to an access level of read-write-all and the expiration period for the password to 60 days:

```
Switch:1 (config) #access-level rwa aging-time 60
```

Variable definitions

Use the data in the following table to use the `cli password` command.

Table 2: Variable definitions

Variable	Value
layer1 layer2 layer3 read-only read-write read-write-all	Changes the password for the specific access level.
WORD<1–20>	Specifies the user logon name.

Use the data in the following table to use the `password` command.

Table 3: Variable definitions

Variable	Value
access level WORD<2–8>	Permits or blocks this access level. The available access level values are as follows: <ul style="list-style-type: none"> • l1 • l2 • l3 • ro • rw • rwa
aging-time day <1-365>	Configures the expiration period for passwords in days, from 1–365. The default is 90 days.
default-lockout-time <60-65000>	Changes the default lockout time after three invalid attempts. Configures the lockout time, in seconds, and is in the 60–65000 range. The default is 60 seconds.

Table continues...

Variable	Value
	To configure this option to the default value, use the default operator with the command.
lockout <i>WORD</i> <0–46> time <60-65000>	Configures the host lockout time. <ul style="list-style-type: none"> <i>WORD</i><0–46> is the host IP address in the format a.b.c.d. <60-65000> is the lockout-out time, in seconds, in the 60–65000 range. The default is 60 seconds.
min-passwd-len <10-20>	Configures the minimum length for passwords in high-secure mode. The default is 10 characters. To configure this option to the default value, use the default operator with the command.
password-history <3-32>	Specifies the number of previous passwords the switch stores. You cannot reuse a password that is stored in the password history. The default is 3. To configure this option to the default value, use the default operator with the command.

Configuring directed broadcast

A directed broadcast is a frame sent to the subnet broadcast address on a remote IP subnet. When you disable (or suppress) directed broadcasts on an interface, all frames sent to the subnet broadcast address for a local router interface are dropped. Disabling directed broadcasts protects hosts from possible denial-of-service (DOS) attacks. By default, this feature is enabled on the device.

Procedure

1. Enter VLAN Interface Configuration mode:

```
enable
configure terminal
interface vlan <1-4059>
```
2. Configure the switch to forward directed broadcasts for a VLAN:

```
ip directed-broadcast enable
```

Example

```
Switch:1>enable
Switch:1#configure terminal
Switch:1(config)#interface vlan 2
Switch:1(config-if)#ip directed-broadcast enable
```

Variable definitions

Use the data in the following table to use the `ip directed-broadcast` command.

Table 4: Variable definitions

Variable	Value
enable	Enables the device to forward directed broadcast frames to the specified VLAN. The default setting for this feature is enabled.

Preventing certain types of DOS attacks

Protect the switch against IP packets with illegal IP addresses such as loopback addresses or a source IP address of ones, or Class D or Class E addresses from being routed. The switch supports high-secure configurable flag.

About this task

! Important:

After you enable this flag, the desired behavior (not routing source packets with an IP address of 255.255.255.255) applies to all ports that belong to the same port.

! Important:

The setting to enable hsecure only takes effect for packets going to the CP; not to datapath traffic.

Procedure

1. Enter GigabitEthernet Interface Configuration mode:

```
enable
configure terminal
interface GigabitEthernet {slot/port[/sub-port] [-slot/port[/sub-port]] [, ...]}
```

* Note:

If your platform supports channelization and the port is channelized, you must also specify the sub-port in the format slot/port/sub-port.

2. Enable high-secure mode:

```
high-secure [port {slot/port[/sub-port] [-slot/port[/sub-port]] [, ...]] enable
```

Example

```
Switch:1> enable
Switch:1# configure terminal
```

```
Switch:1(config)# interface GigabitEthernet 1/16
Switch:1(config-if)# high-secure enable
```

Variable definitions

Use the data in the following table to use the **high-secure** command.

Variable	Value
port {slot/port[/sub-port] [-slot/port[/sub-port]][,...]}	Specifies the port on which you want to enable high-secure mode. Identifies the slot and port in one of the following formats: a single slot and port (slot/port), a range of slots and ports (slot/port-slot/port), or a series of slots and ports (slot/port,slot/port,slot/port). If your platform supports channelization and the port is channelized, you must also specify the sub-port in the format slot/port/sub-port.
enable	Enables the high-secure feature that blocks packets with illegal IP addresses. This flag is disabled by default. Use the no operator to remove this configuration. To configure this option to the default value, use the default operator with the command.

Configuring port lock

Configure port lock to administratively lock a port or ports to prevent other users from changing port parameters or modifying port action. You cannot modify a locked port until you unlock the port.

Procedure

1. Enter Global Configuration mode:

```
enable
configure terminal
```

2. Enable port lock globally:

```
portlock enable
```

3. Enter GigabitEthernet Interface Configuration mode:

```
interface gigabitethernet {slot/port[/sub-port] [-slot/port[/sub-
port]][,...]}
```

4. Lock a port:

```
lock [port {slot/port[/sub-port] [-slot/port[/sub-port]][,...]]
enable
```

Example

```
Switch:1> enable
Switch:1# configure terminal
```

Log on to GigabitEthernet Interface Configuration mode:

```
Switch:1(config)# interface GigabitEthernet 1/1
```

Lock port 1/1:

```
Switch:1(config-if)# lock port 1/1 enable
```

Unlock port 1/1:

```
Switch:1(config-if)# no lock port 1/1 enable
```

Variable definitions

Use the data in the following table to use the **interface gigabitethernet** command.

Variable	Value
{slot/port[/sub-port][/-slot/port[/sub-port]][,...]}	Identifies the slot and port in one of the following formats: a single slot and port (slot/port), a range of slots and ports (slot/port-slot/port), or a series of slots and ports (slot/port,slot/port,slot/port). If your platform supports channelization and the port is channelized, you must also specify the sub-port in the format slot/port/sub-port.

Use the data in the following table to use the **lock port** command.

Variable	Value
{slot/port[/sub-port][/-slot/port[/sub-port]][,...]}	Specifies the port you want to lock. Identifies the slot and port in one of the following formats: a single slot and port (slot/port), a range of slots and ports (slot/port-slot/port), or a series of slots and ports (slot/port,slot/port,slot/port). If your platform supports channelization and the port is channelized, you must also specify the sub-port in the format slot/port/sub-port. The default is disabled.

Unicast Reverse Path Forwarding configuration using CLI

This section provides CLI procedures for Unicast Reverse Path Forwarding configuration.

Enabling urpf-mode boot flag

To configure Unicast Reverse Path Forwarding on a port or VLAN, you are required to enable the urpf-mode boot flag. If you try to configure uRPF on an interface, that is, enable or change the urpf operating mode with the urpf-mode boot flag disabled, a consistency check error message is displayed: `Unicast Reverse Path Forwarding configuration is not supported when urpf-mode boot flag is disabled.`

About this task

Use the following procedure to enable the urpf-mode boot flag. By default, urpf-mode is disabled.

Procedure

1. Enter Global Configuration mode:

```
enable
configure terminal
```

2. Enable the urpf-mode boot flag:

```
boot config flags urpf-mode
```

*** Note:**

3. When you get the following prompt to reboot the switch, enter `y` to reboot.

```
The new setting requires a reboot to take effect!
The configuration will be saved and rebooted.
Are you sure you want to re-boot the switch (y/n)?
```

*** Note:**

If you enter `n`, the following message is displayed: Warning: Please save the configuration and reboot the switch for this configuration to take effect.

4. Check the status of the urpf-mode boot flag:

```
show boot config flags
```

Example

Enable the urpf-mode boot flag:

```
Switch:1> enable
Switch:1# configure terminal
Switch:1(config)# boot config flags urpf-mode
The new setting requires a reboot to take effect!
The configuration will be saved and rebooted.
Are you sure you want to re-boot the switch (y/n)? y
```

View the status of the urpf-boot flag:

```
Switch:1> enable
Switch:1# configure terminal
Switch:1(config)# show boot config flags

flags block-snmp false
flags debug-config false
flags debugmode false
flags factorydefaults false
flags flow-control-mode false
flags ftpd true
flags hsecure false
flags ipv6-mode true
flags logging true
flags reboot true
```

```

flags rlogind false
flags spanning-tree-mode mstp
flags spbm-config-mode true
flags sshd false
flags telnetd true
flags tftpd false
flags trace-logging false
flags urpf-mode true
flags verify-config true
flags vrf-scaling false

```

Configuring unicast reverse path forwarding on a port

About this task

You can use the Unicast Reverse Path Forwarding (uRPF) feature to reduce the problems that are caused by the introduction of malformed or forged (spoofed) IP source addresses into a network. When you enable uRPF, the switch performs a check to determine if the source IP address of the packet is verifiable. If the address is not verifiable, the system drops the packet.

uRPF runs in two modes:

- strict mode
- loose mode (exist-only mode)

Before you begin

- You must enable the urpf-mode boot flag. See [Enabling urpf-mode boot flag](#) on page 29.

* Note:

When you try to configure uRPF on an interface, that is, enable or change the urpf operating mode with the urpf-mode boot flag disabled, a consistency check error message is displayed: Unicast Reverse Path Forwarding configuration is not supported when urpf-mode boot flag is disabled.

- You must log on to the GigabitEthernet Interface Configuration mode in ACLI.

Procedure

1. Enter GigabitEthernet Interface Configuration mode:

```

enable

configure terminal

interface GigabitEthernet {slot/port[/sub-port] [-slot/port[/sub-
port]][,...]}

```

* Note:

If your platform supports channelization and the port is channelized, you must also specify the sub-port in the format slot/port/sub-port.

2. Set or change the urpf operating mode on a port:

For IPv4, enter: `ip rvs-path-chk mode {strict|exist-only}`

For IPv6, enter: `ipv6 rvs-path-chk mode {strict|exist-only}`

*** Note:**

3. Verify the configuration on the port:

For IPv4, enter: `show ip interface gigabitethernet`

For IPv6, enter: `show ipv6 interface gigabitethernet`

Example

Example for IPv4:

```
Switch:1> enable
Switch:1# configure terminal
Switch:1(config)# interface GigabitEthernet 4/16
```

Check whether the source IP address of the incoming packet exists in the FIB table:

```
Switch:1(config-if)# ip rvs-path-chk mode strict
```

Verify the configuration on the port:

```
Switch:1(config-if)# show ip interface gigabitethernet

=====
====
                                     Brouter Port Ip
=====
====
PORT VRF      IP_ADDRESS      NET_MASK      BROADCAST REASM   ADVERTISE DIRECT  RPC    RPCMODE
NUM  NAME
-----
1/1  Glob~  10.133.136.71  255.255.255.0 ones      1500   disable  disable disable exist-
only
1/10 spbo~  15.0.3.1      255.255.255.0 ones      1500   disable  disable disable exist-
only

PORT  VRF
NUM   NAME
-----
1/1   GlobalRouter
1/10  spboip
```

Example for IPv6:

```
Switch:1> enable
Switch:1# configure terminal
Switch:1(config)# interface GigabitEthernet 4/16
```

Check whether the source IP address of the incoming packet exists in the FIB table:

```
Switch:1(config-if)# ipv6 rvs-path-chk mode strict
```

Verify the configuration on the port:

```
Switch:1(config-if)# show ipv6 interface gigabitethernet

=====
=====
                                     Port Ipv6 Interface
=====
=====
IFINDX BRROUTER PHYSICAL  ADMIN OPER  TYPE MTU HOP REACHABLE RETRANSMIT MCAST  IPSEC RPC
RPCMODE
INDX          ADDRESS  STATE STATE          LMT TIME      TIME      STATUS
```

```

-----
-----
=====
Port Ipv6 Address
=====
IPV6 ADDRESS                                BROUTER      TYPE        ORIGIN      STATUS
-----
0 out of 4 Total Num of Interface Entries displayed.
0 out of 7 Total Num of Address Entries displayed.

```

Variable definitions

Use the data in the following table to use the `ip rvs-path-chk mode` and `ipv6 rvs-path-chk mode` commands.

Variable	Value
<code>mode{strict exist-only}</code>	Specifies the mode for Unicast Reverse Path Forwarding (uRPF). In strict mode, uRPF checks whether the source IP address of the incoming packet exists in the FIB. If the incoming interface is not the best reverse path, the packet check fails and uRPF drops the packet. In exist-only mode, uRPF checks whether the source IP address of the incoming packet exists in the FIB. The packet is dropped only if the source address is not reachable via any interface on that router.

Configuring unicast reverse path forwarding on a VLAN

About this task

Use the Unicast Reverse Path Forwarding (uRPF) feature to reduce the problems that are caused by the introduction of malformed or forged (spoofed) IP source addresses into a network. When you enable uRPF, the switch performs a check to determine if the source IP address of the packet is verifiable. If the address is not verifiable, the system drops the packet.

uRPF runs in two modes:

- strict mode
- loose mode (exist-only mode)

Before you begin

- You must enable the `urpf-mode boot` flag.

Note:

When you try to configure uRPF on an interface, that is, enable or change the `urpf` operating mode with the `urpf-mode boot` flag disabled, a consistency check error message is displayed: `Unicast Reverse Path Forwarding configuration is not supported when urpf-mode boot flag is disabled.`

- You must log on to the VLAN Interface Configuration mode in CLI.

! Important:

You must assign a valid IP address to the selected port.

Procedure

1. Enter VLAN Interface Configuration mode:

```
enable
configure terminal
interface vlan <1-4059>
```

2. Set or change the urpf operating mode on a VLAN:

For IPv4, enter: `ip rvs-path-chk mode {strict|exist-only}`

For IPv6, enter: `ipv6 rvs-path-chk mode {strict|exist-only}`

3. Verify the configuration on the VLAN:

For IPv4, enter: `show interfaces vlan ip`

For IPv6, enter: `show ipv6 interface vlan`

Example**Example for IPv4:**

```
Switch:1> enable
Switch:1# configure terminal
Switch:1(config)# interface vlan 2
```

Check whether the source IP address of the incoming packet exists in the FIB table:

```
Switch:1(config-if)# ip rvs-path-chk mode exist-only
```

Verify the configuration on the VLAN:

```
Switch:1(config-if)# show interfaces vlan ip
```

```
=====
=====
=====
=====
=====
```

Vlan Ip								
VLAN ID	VRF NAME	IP RMON ADDRESS	NET MASK	BCASTADDR FORMAT	REASM MAXSIZE	ADVERTISE WHEN_DOWN	DIRECTED BROADCAST	RPC
1050	Globa~	100.1.1.1	255.255.255.0	ones	1500	disable	disable	disable
exist-only		disable						
1102	Globa~	11.0.2.1	255.255.255.0	ones	1500	disable	disable	disable
exist-only		disable						
1133	iir3	11.3.3.1	255.255.255.0	ones	1500	disable	disable	disable
exist-only		disable						
1500	spboip	15.0.0.1	255.255.255.0	ones	1500	disable	disable	disable
exist-only		disable						
1590	spboip	15.9.0.1	255.255.255.0	ones	1500	disable	disable	disable
exist-only		disable						
4057	Globa~	4.0.57.1	255.255.255.0	ones	1500	disable	disable	disable
exist-only		disable						

```
-----
```

All 16 out of 16 Total Num of Vlan Ip Entries displayed

```
VLAN VRF
ID   NAME
-----
1050 GlobalRouter
1102 GlobalRouter
1133 iir3
1500 spboip
1590 spboip
4057 GlobalRouter
```

All 16 out of 16 Total Num of Vlan Ip Entries displayed

Example for IPv6:

```
Switch:1> enable
Switch:1# configure terminal
Switch:1(config)# interface vlan 2
```

Check whether the source IP address of the incoming packet exists in the FIB table:

```
Switch:1(config-if)# ipv6 rvs-path-chk mode exist-only
```

Verify the configuration on the VLAN:

```
Switch:1(config-if)# show ipv6 interface vlan
```

```
=====
=====
Vlan Ipv6 Interface
=====
=====
IFINDX VLAN PHYSICAL      ADMIN  OPER  TYPE  MTU  HOP  REACHABLE  RETRANSMIT
MCAST  IPSEC   RPC      RPCMODE
INDX    ADDRESS STATE   STATE          LMT  TIME      TIME      STATUS
=====
3170   1122  2c:f4:c5:dc:b4:89 enable  up    ETHER 1500 64  30000      1000
disable disable disable existonly
3174   1126  2c:f4:c5:dc:b4:8b enable  up    ETHER 1500 64  30000      1000
disable disable disable existonly
3185   1137  2c:f4:c5:dc:b4:90 enable  up    ETHER 1500 64  30000      1000
disable disable disable existonly
=====
```

```
=====
Vlan Ipv6 Address
=====
=====
IPV6 ADDRESS          VLAN-ID      TYPE      ORIGIN      STATUS
=====
1122:0:0:0:0:0:0:1    V-1122      UNICAST  MANUAL      PREFERRED
fe80:0:0:0:2ef4:c5ff:fedc:b489 V-1122      UNICAST  LINKLAYER  PREFERRED
1126:0:0:0:0:0:0:1    V-1126      UNICAST  MANUAL      PREFERRED
fe80:0:0:0:2ef4:c5ff:fedc:b48b V-1126      UNICAST  LINKLAYER  PREFERRED
1137:0:0:0:0:0:0:1    V-1137      UNICAST  MANUAL      PREFERRED
fe80:0:0:0:2ef4:c5ff:fedc:b490 V-1137      UNICAST  LINKLAYER  PREFERRED
=====
```

3 out of 4 Total Num of Interface Entries displayed.

6 out of 7 Total Num of Address Entries displayed.

Variable definitions

Use the data in the following table to use the `ip rvs-path-chk` mode and `ipv6 rvs-path-chk` mode commands.

Variable	Value
<code>mode{strict exist-only}</code>	Specifies the mode for Unicast Reverse Path Forwarding (uRPF). In strict mode, uRPF checks whether the source IP address of the incoming packet exists in the FIB. If the incoming interface is not the best reverse path, the packet check fails and uRPF drops the packet. In exist-only mode, uRPF checks whether the source IP address of the incoming packet exists in the FIB. The packet is dropped only if the source address is not reachable via any interface on that router.

Viewing unicast reverse path forwarding configuration on a port

About this task

Use the following procedure to view the status of the uRPF configuration on a port.

Before you begin

- You must enable the `urpf-mode` boot flag.

*** Note:**

When you try to configure uRPF on an interface, that is, enable or change the `urpf` operating mode with the `urpf-mode` boot flag disabled, a consistency check error message is displayed: `Unicast Reverse Path Forwarding configuration is not supported when urpf-mode boot flag is disabled.`

- You must log on to the GigabitEthernet Interface Configuration mode in CLI.
- You must configure unicast reverse path forwarding on a port.

Procedure

- Enter GigabitEthernet Interface Configuration mode:

```
enable
configure terminal
interface GigabitEthernet {slot/port[/sub-port] [-slot/port[/sub-port]][,...]}
```

*** Note:**

If your platform supports channelization and the port is channelized, you must also specify the sub-port in the format `slot/port/sub-port`.

- Verify the configuration on the port:

For IPv4, enter: `show ip interface gigabitethernet`

For IPv6, enter: show ipv6 interface gigabitethernet

Example

Example for IPv4:

```
Switch:1> enable
Switch:1# configure terminal
Switch:1(config)# interface GigabitEthernet 4/16
```

Verify the configuration on the port:

```
Switch:1(config-if)# show ip interface gigabitethernet

=====
====
                                     Brouter Port Ip
=====
====
PORT  VRF      IP_ADDRESS      NET_MASK      BROADCAST  REASM  ADVERTISE  DIRECT  RPC  RPCMODE
NUM  NAME
-----
1/1  Glob~  10.133.136.71  255.255.255.0  ones       1500   disable    disable  disable  exist-
only
1/10 spbo~  15.0.3.1       255.255.255.0  ones       1500   disable    disable  disable  exist-
only

PORT  VRF
NUM  NAME
-----
1/1  GlobalRouter
1/10 spboip
```

Example for IPv6:

```
Switch:1> enable
Switch:1# configure terminal
Switch:1(config)# interface GigabitEthernet 4/16
```

Verify the configuration on the port:

```
Switch:1(config-if)# show ipv6 interface gigabitethernet

=====
=====
                                     Port Ipv6 Interface
=====
=====
IFINDX BRROUTER PHYSICAL  ADMIN OPER  TYPE MTU HOP REACHABLE  RETRANSMIT MCAST  IPSEC RPC
RPCMODE
INDX          ADDRESS      STATE STATE      LMT TIME      TIME      STATUS
-----
-----

=====
                                     Port Ipv6 Address
=====
=====
IPV6 ADDRESS                                     BROUTER  TYPE  ORIGIN  STATUS
-----

0 out of 4 Total Num of Interface Entries displayed.
0 out of 7 Total Num of Address Entries displayed.
```

Viewing unicast reverse path forwarding configuration on a VLAN

About this task

Use the following procedure to view the status of the uRPF configuration on a VLAN.

Before you begin

- You must enable the urpf-mode boot flag.

*** Note:**

When you try to configure uRPF on an interface, that is, enable or change the urpf operating mode with the urpf-mode boot flag disabled, a consistency check error message is displayed: Unicast Reverse Path Forwarding configuration is not supported when urpf-mode boot flag is disabled.

- You must log on to the VLAN Interface Configuration mode in CLI.

! Important:

You must assign a valid IP address to the selected port.

- You must configure unicast reverse path forwarding on a VLAN.

Procedure

- Enter VLAN Interface Configuration mode:

```
enable
configure terminal
interface vlan <1-4059>
```

- Verify the configuration on the VLAN:

For IPv4, enter: show interfaces vlan ip

For IPv6, enter: show ipv6 interface vlan

Example

Example for IPv4:

```
Switch:1> enable
Switch:1# configure terminal
Switch:1(config)# interface vlan 2
```

Verify the configuration on the VLAN:

```
Switch:1(config-if)# show interfaces vlan ip
```

```
=====
=====
=====
```

Vlan		Ip						
VLAN	VRF	IP	NET	BCASTADDR	REASM	ADVERTISE	DIRECTED	RPC
ID	NAME	ADDRESS	MASK	FORMAT	MAXSIZE	WHEN_DOWN	BROADCAST	
1050	Globa~	100.1.1.1	255.255.255.0	ones	1500	disable	disable	disable
	exist-only	disable						
1102	Globa~	11.0.2.1	255.255.255.0	ones	1500	disable	disable	disable
	exist-only	disable						

```
=====
=====
```

```

1133 iir3 11.3.3.1 255.255.255.0 ones 1500 disable disable disable
exist-only disable
1500 spboip 15.0.0.1 255.255.255.0 ones 1500 disable disable disable
exist-only disable
1590 spboip 15.9.0.1 255.255.255.0 ones 1500 disable disable disable
exist-only disable
4057 Globa~ 4.0.57.1 255.255.255.0 ones 1500 disable disable disable
exist-only disable

```

All 16 out of 16 Total Num of Vlan Ip Entries displayed

```

VLAN VRF
ID NAME
-----

```

```

1050 GlobalRouter
1102 GlobalRouter
1133 iir3
1500 spboip
1590 spboip
4057 GlobalRouter

```

All 16 out of 16 Total Num of Vlan Ip Entries displayed

Example for IPv6:

```

Switch:1> enable
Switch:1# configure terminal
Switch:1(config)# interface vlan 2

```

Verify the configuration on the VLAN:

```

Switch:1(config-if)# show ipv6 interface vlan

```

```

=====
Vlan Ipv6 Interface
=====
IFINDX VLAN PHYSICAL ADMIN OPER TYPE MTU HOP REACHABLE RETRANSMIT MCAST
IPSEC RPC RPCMODE STATE STATE LMT TIME TIME STATUS
INDX ADDRESS STATE STATE
-----
3170 1122 2c:f4:c5:dc:b4:89 enable up ETHER 1500 64 30000 1000 disable
disable disable existonly
3174 1126 2c:f4:c5:dc:b4:8b enable up ETHER 1500 64 30000 1000 disable
disable disable existonly
3185 1137 2c:f4:c5:dc:b4:90 enable up ETHER 1500 64 30000 1000 disable
disable disable existonly
=====
Vlan Ipv6 Address
=====
IPV6 ADDRESS VLAN-ID TYPE ORIGIN STATUS
-----
1122:0:0:0:0:0:0:1 V-1122 UNICAST MANUAL PREFERRED
fe80:0:0:0:2ef4:c5ff:fedc:b489 V-1122 UNICAST LINKLAYER PREFERRED
1126:0:0:0:0:0:0:1 V-1126 UNICAST MANUAL PREFERRED
fe80:0:0:0:2ef4:c5ff:fedc:b48b V-1126 UNICAST LINKLAYER PREFERRED
1137:0:0:0:0:0:0:1 V-1137 UNICAST MANUAL PREFERRED
fe80:0:0:0:2ef4:c5ff:fedc:b490 V-1137 UNICAST LINKLAYER PREFERRED
3 out of 4 Total Num of Interface Entries displayed.
6 out of 7 Total Num of Address Entries displayed.

```

Security configuration using Enterprise Device Manager

Configure security information used on the control and data paths to protect the network from uncontrolled access to network resources.

For more information about how to configure passwords and access policies, see *Administering*.

Enabling port lock

About this task

Use the port lock feature to administratively lock a port or ports to prevent other users from changing port parameters or modifying port action. You cannot modify locked ports until you first unlock the port.

Procedure

1. In the navigation tree, open the following folders: **Configuration > Security > Control Path**.
2. Click **General**.
3. Click the **Port Lock** tab.
4. To enable port lock, select the **Enable** check box.
5. Click **Apply**.

Port Lock field descriptions

Use the data in the following table to use the **Port Lock** tab.

Name	Description
Enable	Activates the port lock feature. Clear this check box to unlock ports. The default is disabled.
LockedPorts	Lists the locked ports. Click the ellipsis (...) button to select the ports you want to lock or unlock.

Locking a port

Before you begin

- You must enable port lock before you lock or unlock a port.

About this task

Use the port lock feature to administratively lock a port or ports to prevent other users from changing port parameters or modifying port action. You cannot modify locked ports until you first unlock the port.

Procedure

1. In the navigation tree, open the following folders: **Configuration > Security > Control Path**.
2. Click **General**.
3. Click the **Port Lock** tab.
4. In the **LockedPorts** box, click the ellipsis (...) button.
5. Click the desired port or ports.
6. Click **Ok**.
7. In the Port Lock tab, click **Apply**.

Port Lock field descriptions

Use the data in the following table to use the **Port Lock** tab.

Name	Description
Enable	Activates the port lock feature. Clear this check box to unlock ports. The default is disabled.
LockedPorts	Lists the locked ports. Click the ellipsis (...) button to select the ports you want to lock or unlock.

Changing passwords

About this task

Configure new passwords for each access level, or change the logon or password for the different access levels of the system to prevent unauthorized access. After you receive the switch, use default passwords to initially access CLI. If you use Simple Network Management Protocol version 3 (SNMPv3), you can change passwords in encrypted format.

Procedure

1. In the navigation tree, open the following folders: **Configuration > Security > Control Path**.
2. Click **General**.
3. Click the **CLI** tab.
4. Specify the username and password for the appropriate access level.
5. Click **Apply**.

CLI field descriptions

Use the data in the following table to use the **CLI** tab.

Name	Description
RWAUserName	Specifies the user name for the read-write-all CLI account.
RWAPassword	Specifies the password for the read-write-all CLI account.
RWEnable	Activates the read-write access level.
RWUserName	Specifies the user name for the read-write CLI account.
RWPassword	Specifies the password for the read-write CLI account.
RWL3Enable	Activates the read-write Layer 3 access level.
RWL3UserName	Specifies the user name for the Layer 3 read-write CLI account.
RWL3Password	Specifies the password for the Layer 3 read-write CLI account.
RWL2Enable	Activates the read-write Layer 2 access level.
RWL2UserName	Specifies the user name for the Layer 2 read-write CLI account.
RWL2Password	Specifies the password for the Layer 2 read-write CLI account.
RWL1Enable	Activates the read-write Layer 1 access level.
RWL1UserName	Specifies the user name for the Layer 1 read-write CLI account.
RWL1Password	Specifies the password for the Layer 1 read-write CLI account.
ROEnable	Activates the read/only CLI account level.
ROUserName	Specifies the user name for the read-only CLI account.
ROPassword	Specifies the password for the read-only CLI account.
MaxTelnetSessions	Indicates the maximum number of concurrent Telnet sessions (0–8). The default is 8.
MaxRloginSessions	Indicates the maximum number of concurrent Rlogin sessions (0–8). The default is 8.
Timeout	Indicates the number of seconds of inactivity for a Telnet or Rlogin session before automatic timeout and disconnect (30–65535 seconds). The default is 900.
NumAccessViolations	Indicates the number of CLI access violations detected by the system. This field is a read-only field.

Configuring directed broadcast on a VLAN

Configure directed broadcast on a VLAN to enable or disable directed broadcast traffic forwarding for an IP interface.

Procedure

1. In the navigation pane, expand the **Configuration > VLAN** folders.
2. Click **VLANs**.
3. Select the **Basic** tab.
4. Select a VLAN.
5. Click **IP**.
6. Click the **Direct Broadcast** tab.
7. Select **DirectBroadcastEnable**.

Important:

Configure multiple VLANs or IPs in the same subnet but in different systems simultaneously.

8. Click **Apply**.

Direct Broadcast field descriptions

Use the data in the following table to use the **Direct Broadcast** tab.

Name	Description
DirectBroadcastEnable	<p>Specifies that an Isolated Routing Port (IRP) can forward directed broadcast traffic. A directed broadcast is a frame sent to the subnet broadcast address on a remote IP subnet. By disabling or suppressing directed broadcast on an interface, all frames sent to the subnet broadcast address for a local router interface are dropped. Disabling this function protects a host from possible denial of service (DoS) attacks.</p> <p>With the feature enabled, the Control Processor (CP) does not receive a copy of the directed broadcast. As a result, the system does not respond to a subnet broadcast ping sent from a remote subnet.</p> <p>The default is disabled.</p>

Unicast Reverse Path Forwarding configuration using EDM

This section provides EDM procedures for Unicast Reverse Path Forwarding configuration.

Configuring reverse path checking on a port

Before you begin

- The system supports reverse path checking only on ports that have a valid IP address.

About this task

Configure reverse path checking on a port to determine if a packet IP address is verifiable. Use reverse path checking to reduce the problems that are caused by the introduction of malformed or forged (spoofed) IP source addresses into a network. After you enable reverse path checking, the switch performs a reverse path check to determine if the packet IP address is verifiable. If the address is not verifiable, the system discards the packet.

Reverse path checking operates in one of two modes:

- exist-only mode
- strict mode

Procedure

1. In the Device Physical View tab, select a port.
2. In the navigation tree, open the following folders: **Configuration > Edit > Port**.
3. Click **IP**.
4. Click the **Reverse Path Checking** tab.
5. Select the **Enable** check box to enable reverse path checking.
6. Select **exist-only** or **strict**.
7. Click **Apply**.

Reverse Path Checking field descriptions

Use the data in the following table to use the **Reverse Path Checking** tab.

Name	Description
Enable	Enables reverse path checking on the selected port. The default is disabled.
Mode	Specifies the mode for reverse path checking. The modes are <ul style="list-style-type: none"> • exist-only—reverse path checking checks whether the incoming packet source IP address exists in the routing table. If reverse path checking finds the source IP entry, the packet is forwarded; otherwise the packet is discarded. • strict—reverse path checking checks whether the incoming packet source IP address exists in routing table. If reverse

Table continues...

Name	Description
	<p>path checking does not find the source IP entry, the packet is dropped; otherwise, reverse path checking further checks if the source IP interface matches the incoming interface of the packet. If they match, the packet is forwarded; otherwise the packet is discarded.</p> <p>The default is exist-only.</p>

Configuring reverse path checking on a VLAN

Before you begin

- Before you can configure reverse path checking on a VLAN, you must assign a valid IP address to the selected VLAN.

About this task

Configure reverse path checking on a VLAN to determine if a packet IP address is verifiable. Use reverse path checking to reduce the problems that are caused by the introduction of malformed or forged (spoofed) IP source addresses into a network. After you enable reverse path checking, the switch performs a reverse path check to determine if the packet IP address is verifiable. If the address is not verifiable, the system discards the packet.

Reverse path checking operates in one of two modes:

- exist-only mode
- strict mode

Procedure

1. In the navigation tree, open the following folders: **Configuration > VLAN**.
2. Click **VLANs**.
3. Click the VLAN on which you want to configure reverse path checking.
4. In the toolbar, click **IP**.
5. Click the **Reverse Path Checking** tab.
6. Select the **Enable** box to enable reverse path checking.
7. Select **exist-only** or **strict**.
8. Click **Apply**.

Reverse Path Checking field descriptions

Use the data in the following table to use the **Reverse Path Checking** tab.

Name	Description
Enable	Enables reverse path checking on the selected VLAN.

Table continues...

Name	Description
Mode	<p>Specifies the mode for reverse path checking. The modes are</p> <ul style="list-style-type: none"> • exist-only—reverse path checking checks whether the incoming packet source IP address exists in the routing table. If reverse path checking finds the source IP entry, the packet is forwarded; otherwise, the packet is discarded. • strict—reverse path checking checks whether the incoming packet source IP address exists in routing table. If reverse path checking does not find the source IP entry, then the packet is dropped. Otherwise, reverse path checking further checks if the source IP interface matches the incoming interface of the packet. If they match, then the packet is forwarded. Otherwise, the packet is discarded. <p>The default is exist-only.</p>

Viewing ASG global configuration

About this task

Use this procedure to display the ASG global configuration.

Procedure

1. In the navigation pane, expand the following folders: **Configuration > Security > Control Path > ASG**
2. Click the **Globals** tab.

Field descriptions

Use the data in the following table to use the **ASG > Globals** tab.

Name	Description
EnableStatus	Specifies whether ASG is enabled or disabled. The value 1 indicates that ASG is enabled on the device.
AFID	Specifies the unique authentication file identification number.
Product	Specifies the device on which ASG is enabled.
DateAndTime	Specifies the date and time of configuration.
Release	Specifies the software release in which ASG is configured.

Viewing active ASG accounts

About this task

Use this procedure to display the accounts associated with ASG on the device.

Procedure

1. In the navigation tree, expand the following folders: **Configuration > Security > Control Path > ASG**
2. Click the **Accounts** tab.

Field descriptions

Use the data in the following table to use the **ASG > Accounts** tab.

Name	Description
AccessLevel	Specifies the authentication access level for each account.
Username	Specifies the user name corresponding to each account.

Chapter 4: First Hop Security

IPv6 First Hop Security

This chapter describes the IPv6 security concerns and attempts to mitigate them using First Hop Security (FHS).

What is IPv6?

Internet Protocol version 6 (IPv6) is the latest version of the Internet Protocol (IP).

IPv6 is expected to coexist with and eventually replace IPv4. IPv6 provides a larger address space to support future Internet growth. IPv6 is increasingly deployed in enterprise, university, and government networks. The success of the IPv6 deployment depends on the network security and quality of service (QoS) that it offers when compared to Internet Protocol version 4 (IPv4).

For more information about IPv6 basics, see *Configuring IPv6 Routing*.

IPv6 security concerns

The enhancements in IPv6 provide better security in certain areas, but some of these areas are still open to exploitation by attackers. This section identifies the IPv6 FHS concerns associated with Dynamic Host Configuration Protocol version 6 (DHCPv6).

DHCPv6

DHCPv6 (RFC 3315) describes how a host can acquire an IPv6 address and other configuration options from a server that is available on its local link. DHCPv6 is described as a stateful protocol. In other words, DHCPv6 can operate in a stateless fashion where it provides configuration information to nodes and does not perform address assignments (RFC 3736). In addition, it can operate in a stateful manner, where it assigns IPv6 addresses and configuration information to hosts that request it.

As in IPv4 DHCP, DHCPv6 is susceptible to rogue server attacks. In other words, if DHCPv6 is used to provide IPv6 addresses to the hosts, an attacker that managed to insert a rogue DHCPv6 server in the link can potentially assign addresses and configuration options to the link hosts. In turn, the attacker can deploy man-in-the-middle, traffic interception, or blackhole traffic, similar to those in the stateless address autoconfiguration scenario. Therefore, it is important to use DHCP protections for both IPv4 and IPv6.

First Hop Security

First Hop Security improves local network security by employing a number of mitigation techniques. This section describes the base set functionality which provides protection from a wide host of rogue or mis-configured users, and this can be extended with additional features for different deployment scenarios. For example, see the following topology.

Sample topology

In the following topology, Layer 2 switch SW-1 is connected to another Layer 2 switch SW-2. SW-2 is connected to three hosts and SW-1 is connected to two hosts.

In this network, if FHS is enabled only on SW-1, then it can only save the nodes which are directly connected to it. To protect the good node connected to SW-2, the FHS must be enabled on SW-2.

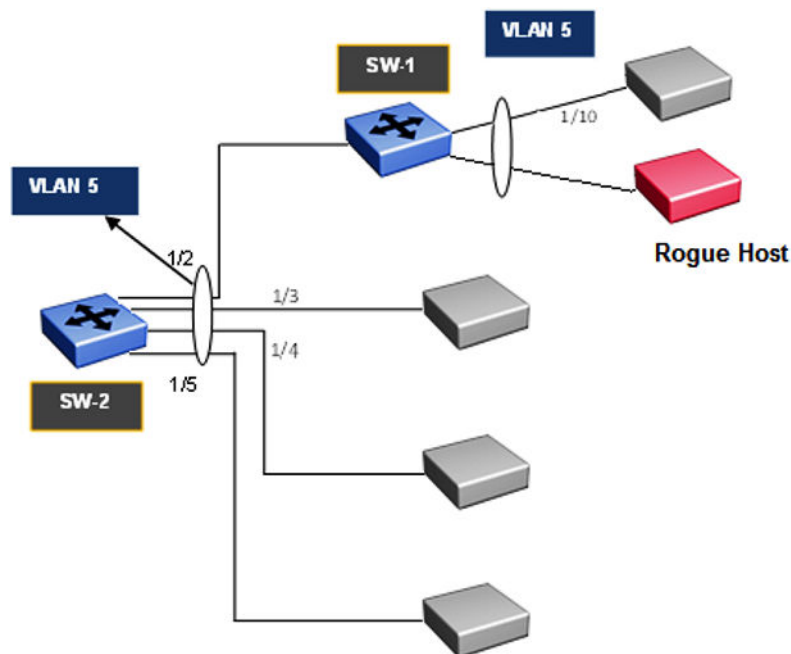

Figure 1: First Hop Security topology

First Hop Security contains the majority of the RIPE 554 mandatory requirements for Layer 2 switches. This includes the following:

- DHCPv6-guard or DHCPv6 filtering
- RA-guard or Router Advertisement filtering

DHCPv6-guard

DHCPv6-Guard is a type of security for IPv6 deployments in an enterprise environment, it provides Layer 2 security to DHCPv6 clients by protecting them against rogue DHCPv6 servers. The basic concept of DHCPv6-Guard is that a Layer 2 device filters DHCPv6 messages meant to DHCPv6 clients, based on a number of different criteria. The basic filtering criterion is, the DHCPv6 server

generated packets which are received on non-server ports or from an untrusted server will be dropped by the Layer 2 device.

Various levels of granularity are provided. Following are the policies that are supported:

- Port based filtering using device role (server or client)
- Server or relay agent IPv6 address based filtering
- Advertising IPv6 prefix based filtering
- DHCPv6 packet filtering based on Server Preference checks

The following are DHCPv6 topology samples:

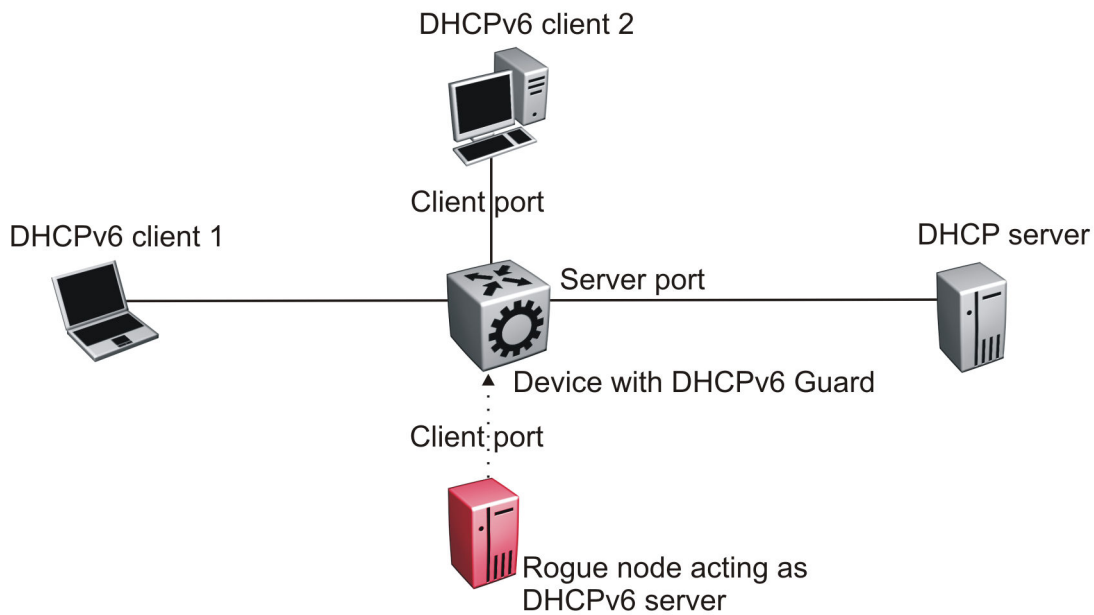

Figure 2: DHCPv6 Topology 1

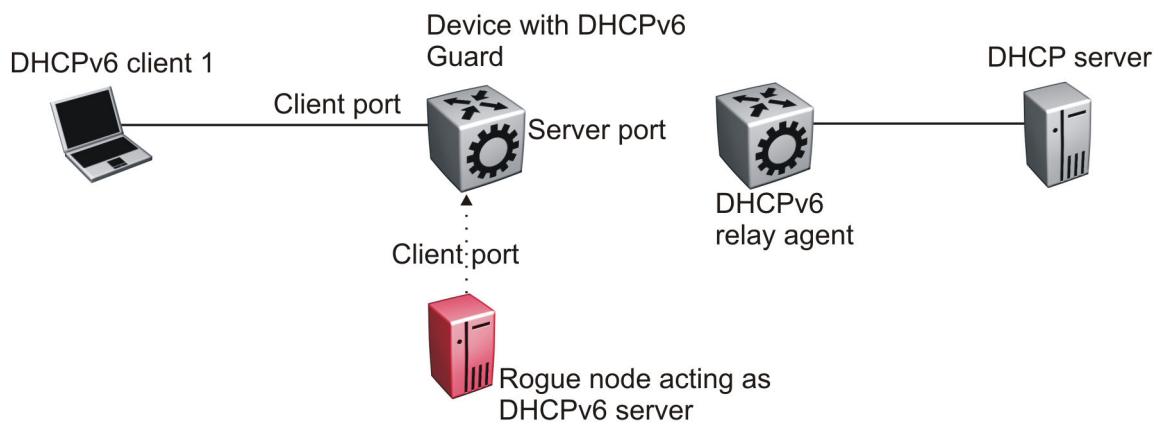

Figure 3: DHCPv6 Topology 2

DHCPv6–guard policies configuration

You can configure DHCPv6-guard policies using CLI, SNMP and EDM. The following policies are supported for DHCPv6–guard.

Port-based filtering using device-role

Port-based filtering using device-role is an interface-level configuration. Only a DHCPv6 server or relay agent can send a DHCPv6 advertisement or reply. By configuring the device-role attached to the port (whether it is a client or server), the rogue server generating DHCPv6 advertisement or reply packets can be blocked if these packets are received on a port configured as a client. Device-role can be applied only on port, and not on MLT, SMLT, or VLAN. If you configure device-role on an MLT, SMLT, or VLAN, you must configure same device-role on all the MLT, SMLT, or VLAN member ports.

In DHCPv6 Guard Topology 1, only DHCPv6 server packets (that is, advertisement, reply) received on a port configured as a Server Port accept the packets and process them for security validation and forwarding. The Client port drops the packets if it receives packets generated from a DHCPv6 rogue server.

Server or relay agent IPv6 address based filtering

Server or relay agent IPv6 address-based filtering enables the verification of the advertised DHCPv6 server and relay address in messages with the configured authorized server access list. In DHCPv6-guard Topology 1 and Topology 2, you can configure the access list to accept DHCPv6 server packets from a specific Source IPv6 address such as a DHCPv6 server or DHCPv6 relay IPv6 address.

Advertising IPv6 prefix-based filtering

Advertising IPv6 prefix-based filtering enables verification of the advertised prefixes in DHCPv6 reply messages with the configured authorized prefix list.

Server preference-based filtering

Server preference-based filtering enables verification by checking if the advertised preference (in preference option) is greater than or less than the specified limit.

RA-guard

IPv6 hosts can configure themselves automatically when connected to a routed IPv6 network through ICMPv6 router discovery messages. When the host is connected to the network for the first time, it sends a link-local router solicitation multicast request for its configuration parameters. If the host is configured correctly, routers respond to the request with a Router Advertisement (RA) packet. The RA packet contains network-layer configuration parameters.

In addition to filtering RAs, RA-guard introduces the concept of router authorization proxy. Instead of each node on the link analyzing RAs and making an individual decision, a legitimate “node-in-the-middle” performs the analysis on behalf of all other nodes on the link.

Stateless and statefull RA-guards are available. The switch supports only the stateless RA-guard function.

Stateless RA-guard examines incoming RAs and decides whether to forward or block them based on the information found in the message or in the Layer 2 device configuration. The following list identifies the typical information available in the received frames that are used for RA validation:

- Port on which the frame is received
- Source IPv6 address
- Prefix list which RA carries
- Link-Layer address of the sender

After the Layer 2 device successfully validates the RA packet content against the configuration, the RA is forwarded to its destination, whether unicast or multicast. If the validation fails, the RA is dropped at the Layer 2 device.

RA-guard policies description

This section describes the RA-guard policies. The following policies are supported for RA-guard:

- Port-based filtering using device role (host or router)
- Source IPv6 based filtering
- Advertised IPv6 prefix-based filtering
- Source MAC address-based filtering
- RA packet for managed address configuration flag validation
- RA packet for hop count limit validation
- RA packet for Router Preference validation

Port-based filtering using device-role

This configuration is an interface-level configuration. According to Neighbor Discovery (ND) RFC 4861, only the IPv6 router can generate the RA packets. By configuring the device-role attached to the port whether it is a host or router, the rogue host which is generating RA packets can be blocked. Device-role can be applied only on a port, and not on an MLT, SMLT, or VLAN. If you configure device-role on an MLT, SMLT, or VLAN, you must configure the same device-role on all the MLT, SMLT, or VLAN member ports.

In the following topology, the switch is connected to a Layer 3 router and three hosts. Because the router is directly connected to port 1/2, the device-role of the port 1/2 is configured in Router mode. The other hosts are connected to ports 1/3, 1/4, and 1/5, and the device-role of ports 1/3, 1/4, and 1/5 are configured in Host Mode.

The host connected to the port 1/4 is a rogue host and if it is trying to send RA packets, then the switch drops those RA packets received on the interface 1/4 as the device-role of this port is Host Mode.

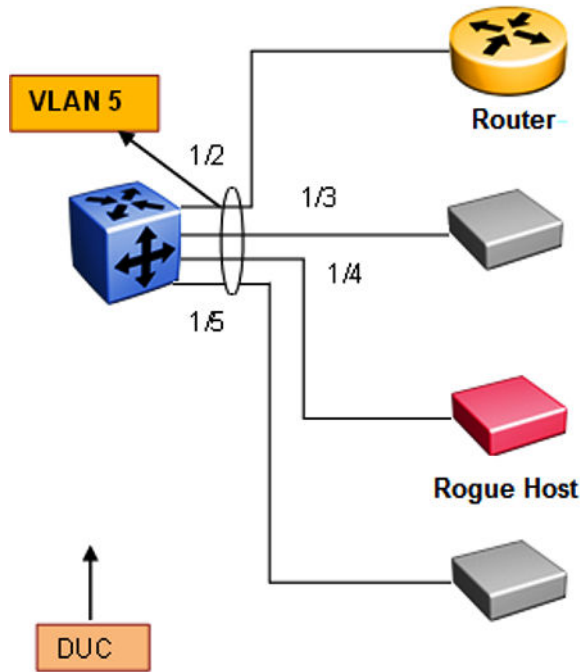

Figure 4: RA-guard Topology1

IPv6 source address based filtering

An IPv6 source address based filtering policy enables the source IPv6 address verification of the RA packets against the configured RA source IPv6 list.

The following figure shows the RA packet format. RA-guard policy verifies the IPv6 source address (SrcIP) in the IPv6 Header against the configured RA source IPv6 list.



Figure 5: IPv6 ICMP RA data packet online

Advertised IPv6 prefix-based filtering

Advertised IPv6 prefix-based filtering enables verification of the advertised prefixes in inspected messages against the configured RA prefix list.

The following figure illustrates the IPv6 ICMP RA data packet outline. This RA-guard policy verifies the RA (Prefix Information) in ICMPv6 data against the configured RA prefix list.



Figure 6: IPv6 ICMP RA data packet outline

Source MAC address-based filtering

Source MAC address-based filtering enables the source MAC address of the RA packets verification against the configured authorized MAC list.

The following figure illustrates the IPv6 Ethernet packet. This RA-guard policy verifies the received RA packets source MAC address against the configured authorized MAC access list.

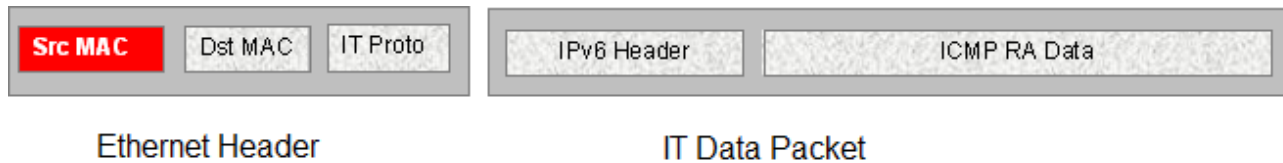

Figure 7: IPv6 Ethernet packet

RA packet for managed address configuration flag validation

In the RA packets, there is an “M” flag (managed address configuration flag) that can be configured to indicate that the address assignments are available through DHCPv6. This means that DHCPv6 takes care of the interface address assignment in that LAN segment. If a filtering policy is enabled, then all the RA packets without an “M” flag are dropped. By default, this validation is not performed.

The following figure illustrates IPv6 ICMP RA data packet outline for managed address configuration.



Figure 8: IPv6 ICMP RA data packet outline

RA packet for hop count limit validation

RA packet for hop count limit validation policy verifies the advertised RA message if the hop count limit is within the configured hop count limit. If the received hop count limit is not within the configured limit, then those RA packets are dropped.

The following figure illustrates IPv6 ICMP RA data packet outline for hop count limit validation.



Figure 9: IPv6 ICMP RA data packet outline

RA packet for router preference validation

The RA packet contains the Router Preference as part of the flags field. This can be high, medium, or low. This filtering policy option verifies if the advertised default router preference parameter value is lower than or equal to a specified limit.

The following figure illustrates IPv6 ICMP RA data packet outline for router preference validation.

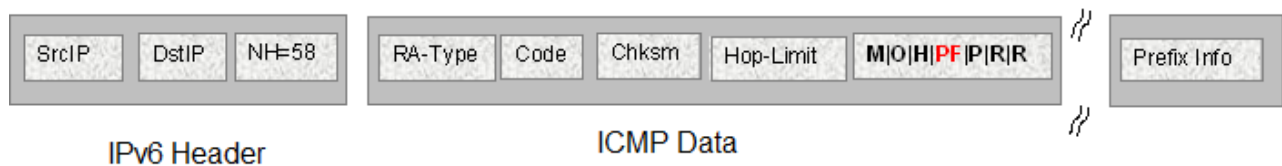

Figure 10: IPv6 ICMP RA data packet outline for router preference validation

Capturing and verifying FHS specific packets against the configured policies

First Hop Security filters can be installed only if FHS is enabled globally. The DHCPv6-guard or RA-guard filters are created as a part of First Hop Security filter with port bit mask "0".

The following list identifies the high-level tasks to capture DHCPv6 packets received on a physical port:

1. Enable FHS globally.
2. Enable DHCPv6-guard or RA-guard globally.
3. Create DHCPv6-guard or RA-guard policy.
4. Configure RA-guard or DHCPv6-guard device role on the port.
5. Attach DHCPv6-guard and/or RA-guard policy to a physical port if needed.

On configuring RA-guard or DHCPv6-guard device role on the port, the appropriate port bitmask for that port will be updated in the data path filter.

The RA or DHCPv6 sever initiated packets received on trusted ports (router or server ports) will be sent to the local CPU for further validations. If these packets pass the RA-guard and DHCPv6-guard validation, they will be forwarded towards the intended host or DHCPv6 client; if not, they will be dropped by the switch.

Limitations

The following limitations exist in First Hop Security:

- Fragmented RA and DHCPv6 server initiated packets are dropped on the FHS enabled switch.
- DHCPv6-guard and RA-guard do not work on devices connected on shared media or on tunneled interfaces.
- DHCPv6-guard or RA-guard policies are not VLAN or MLT based.
- FHS is not supported on the Out Of Band (OOB) port on the switch.
- Packets received on FHS ports with more than one extension header, and if they are destined to link-local unicast or link-scope multicast address, are dropped as they cannot be classified as RA or DHCPv6 reply packets.
- The FHS functionality can be bypassed at the first hop switch, if the malicious packets are destined to global address, and have more than one extension header.
- If the FHS rules and IPv6 filters match for a packet, the IPv6 filter has precedence.
- In a Layer 2 VSN, packets are not filtered based on FHS rules. Enable FHS on the required UNI ports to protect the connected devices from FHS attacks.

Guidelines for FHS configuration

Some of the FHS configurations need details on how they work and how they should be used. Following are the details:

1. FHS IPv6 Access lists are generic access/prefix lists which can be applied on IPv6 source address or the prefixes advertised in RA or DHCPv6 messages. If you filter on the basis of a particular IPv6 source address, you must configure the access list entry with complete source address with prefix-length value of 128. If you allow a group of source addresses within a prefix range, you must configure the IPv6 ACL entry with an appropriate prefix length and attach this IPv6 ACL to the appropriate match parameters in RA or DHCPv6 guard policies.

If you filter a particular prefix, you must configure an IPv6 access list entry with appropriate prefix and prefix-lengths. To filter based on prefix, prefix-lengths should be less than 128. Following is an example of IPv6 access list entry:

```
ipv6 fhs ipv6-access-list match_src_allow  
fe80:0:0:0:0:ff:fe00:113/128 mode allow
```

*** Note:**

- a. If no IPv6 ACL is attached to an RA or DHCPv6 guard policy as a source ACL, then IPv6 source address in the incoming RA packets or packets from DHCP server will not be validated, and such packets will not be dropped due to source address validations.

- b. If no IPv6 ACL is attached to an RA or DHCP guard policy as a prefix ACL, then prefix information in incoming RA packets or packets from DHCP server will not be validated and these packets will not be dropped due to prefix validations.
 - c. The FHS access or prefix lists are different from “IPv6 prefix lists”. For FHS, the switch maintains a separate list (cannot reuse IPv6 prefix lists) as IPv6 prefix lists do not have any action associated with them, whereas FHS has an action associated with each ACL entry.
2. When an IPv6 ACL is attached to an RA or DHCPv6 guard policy and the address or prefix in the incoming RA or DHCPv6 server packets received on port to which this RA or DHCPv6 guard policy is attached does not match any of the entries in that IPv6 ACL, the packet will be dropped by default. If you want to change this behavior to default (allow, for IPv6 ACLs), you can add an entry that matches all the packets and set the action as allow. To do this, use the following command:

```
ipv6 fhs ipv6-access-list no_match_src_def_allow 0:0:0:0:0:0:0:0/0
mode allow
```
 3. IPv6 ACL entries with conflicting prefixes within an IPv6 ACLs are not allowed, and such configuration will fail with appropriate error message. Conflicting entries can be present in two or more different IPv6 ACLs.
 4. The entries within an IPv6 ACL will be sorted in increasing order of IPv6 prefixes. If there are two entries with same prefix address within an ACL, then such entries will be ordered with increasing value of their prefix-lengths.
 5. MAC ACL entries are ordered in the increasing order of MAC addresses within a MAC ACL. If none of the entries in the MAC ACL match the source MAC address of RA packet, then the packet will be dropped by default. If no MAC ACL is attached to an RA guard policy, then the source MAC address of RA packets is not validated.
 6. When matching for a prefix using IPv6 ACL entry, if you advertise a prefix with matching prefix but prefix-length lesser than configured prefix-length, then the packet has to be considered as no match and prefix matching process has to continue with remaining IPv6 ACL entries in that ACL.

The rationale behind this functionality is to avoid wrong configuration of access side devices. This functionality safeguards the devices in an access network if a wrongly configured IPv6 prefix is advertised or a malicious user is sending invalid (wrong) prefixes. For example, consider the following scenario:

Configure the prefix in ACL entry (without ge and le values): `ipv6 fhs ipv6-access-list ipv6_acl_entry_1 2000:0123:4567:89ab::/64 mode allow`

Advertise the prefix in RA packet: `2001:0123:4567:89ab::/48`

This advertised prefix matches the configured IPv6 ACL entry and without this prefix-length check functionality, the packet is allowed to pass through. But, actually it is configuring all access devices in that network with wrong IPv6 configurations in different IPv6 network (`2001:0123:4567::/48`)

With prefix-length check functionality (explained above), this configuration is not allowed as advertised prefix length is not equal to configured prefix length. So, the wrong configurations of access devices is avoided.

7. Importance of “ge” and “le” parameters in an IPv6 ACL entry:

A user can optionally configure “ge” (greater than or equal to) and “le” (lesser than or equal to) parameters while configuring an IPv6 ACL entry. If the prefix advertised in a packet matches the configured prefix in an IPv6 ACL entry, and “ge” and “le” values are configured (not default) for that IPv6 ACL entry:

- The packet will be allowed to go through only if the prefix-length in the packet is within the range of configured “ge” and “le” values.
- If prefix lengths in the packet are not within the configured range of “ge” and “le” values (non-default values), then the packets would be considered as no match for that IPv6 ACL entry and search for matching IPv6 ACL entry continues within that IPv6 ACL.
- If no ge and le values are configured, those values by default are set to configured prefix length in that IPv6 ACL entry.
- ge and le values are allowed only if they are greater than configured prefix.
- When both are configured (not default values), ge value should always be smaller than le value.

These configurations provide more control over the advertised prefixes in RA or DHCPv6 packets.

8. As “ge” and “le” values are valid only for advertised prefixes, they will not be applied to IPv6 addresses, which are not prefixes. For such addresses, prefix match is considered as match for that IPv6 ACL entry and the corresponding action of that ACL entry is applied on that packet. “ge” and “le” configurations are irrelevant for the following:

- IPv6 source address in RA packet
- IPv6 source address in packets from DHCPv6 server (like DHCPv6 advertise, DHCPv6 reply)
- IPv6 address (temporary or non-temporary) advertised in packets from DHCPv6 server. For example, IPv6 addresses advertised in IANA option of DHCPv6 reply packets

9. Order of packet validations:

In RA or DHCPv6 packets received at the CP for FHS processing, the following order of processing is carried out:

- a. Packet parsing
- b. Checking for presence of IPv6 fragment header
- c. Checking if packets are RA packets or DHCPv6 packets from server (Advertise, Reply, Reconfigure, Relay-Reply)
- d. Basic validations:
 - Non-Link-Local source IPv6 address (only for RA packets)

- L4 length validations
 - Checksum validations
- e. If an RA or DHCPv6 guard policy is attached to a port:
- MAC ACL validations (if configured) (Only for RA packets)
 - IPv6 source address ACL validation (if configured)
 - IPv6 prefix ACL validations (if configured)
 - Other packet parameter validations like:
 - Managed config flag (RA)
 - ICMP hop limit (RA)
 - Router preference (RA)
 - Server preference (DHCPv6)

If any of these validations fail or if action associated with a match ACL entry indicates to DROP (or default drop if ACL is attached to corresponding policy but packet does not match any ACL entry in that ACL), then the packets are dropped and corresponding statistics are updated. If all these pass or actions related to all matched ACL entries are PERMIT, then the packet is allowed to go through.

10. Longest prefix match: If a packet matches multiple entries in an ACL, then the action associated with an entry with longest prefix match would be applied on the packet.
11. If a port is configured as untrusted (“host” as device role for RA guard or “client” as device role for DHCPv6 guard), all the FHS trusted traffic (RA packets for RA guard or packets from DHCPv6 server for DHCPv6 guard) are dropped in data path itself. Also for such drops, statistics are not incremented.

If a port is neither configured as trusted nor untrusted, then the FHS traffic (RA packets or DHCPv6 packets from DHCPv6 server) is switched as if FHS is not present.

12. Creation of FHS port policy mappings:

Until, and unless, any of the FHS parameters are configured on a port, port policy mappings are not created and thus with no port to policy mapping configured, no entries appear while listing port policy mappings using the command `show ipv6 fhs port-policy`.

13. If a RA guard or DHCPv6 guard policy is attached to any of the ports, deletion of such policy is not allowed. In the contrary, to delete an RA guard or DHCPv6 guard policy, those policies need to be detached from all the ports in the switch. However, modification of an RA guard or DHCPv6 guard policy is allowed even if it is attached to ports.
14. If a MAC or IPv6 ACL is attached to an RA guard or DHCPv6 guard policy, you cannot delete the ACL itself. You can delete the entries from this policy even if it is attached to any policy. At least one entry needs to exist in a MAC or IPv6 ACL; you cannot delete the last entry in that ACL if that ACL is attached to any RA guard or DHCPv6 guard policy. You must detach that ACL from all the policies to delete that ACL. However, you can update the entries in that ACL even if it is attached to a policy.

If a port is configured as trusted (“Server” port for DHCPv6 guard and “Router” port for RA guard), then only one can attach a DHCPv6 guard or RA guard policy to that port. In the

contrary, if any policy is attached to a port, the port role cannot be changed from trusted (“Server” port for DHCPv6 guard and “Router” port for RA guard) to other role (“Client” port for DHCPv6 guard, “Host” port for RA guard or “None” for both) until that policy is not detached from port.

DHCP snooping and Neighbor Discovery inspection

This device supports DHCP snooping and Neighbor Discovery (ND) inspection for IPv6.

Security is critically important in an access network because various devices can connect to an access network that may not be administratively controlled by a single administrator. Stateless Address Autoconfiguration (SLAAC) and Duplicate Address Detection (DAD) mechanisms used by IPv6 are more vulnerable to attacks from a malicious user. If any person, intentionally or unintentionally, configures an IPv6 address on the device interface wrongly and advertises that IPv6 address as one’s own address during DAD mechanism initiated by other device, DAD initiated devices cannot assign this address. If a malicious user replies to all the DAD IPv6 addresses as own address, none of the devices in the access network can assign any IPv6 addresses to their interfaces. Thus, DoS attacks can be easily carried out by the malicious user making the entire network unfunctional. In another kind of attack, a malicious user can try to poison the neighbor cache of a host by sending ND packets with bogus MAC address which is learnt by other hosts into their neighbor table. Due to the infiltration of the bogus MAC address in the host’s neighbor table, the packets destined to its neighbor is sent to the bogus MAC address and is eventually dropped or received by an unintended host.

In general, these kinds of attacks are carried out by sending different Neighbor Discovery (ND) packets – either through solicited ND packet exchanges or as a result of unsolicited ND packet exchanges triggered due to an event like the expiry of ND timers. These packets carry interface IPv6 address information and link-layer address information. Other devices use this information to build their neighbor table for forwarding traffic to or through the malicious device. As part of ND inspection mechanism, ND (specifically, NS, NA, and redirect) packets from only trusted hosts are allowed to pass through and the packets from un-trusted hosts are dropped in the switch itself. Other network devices can safely use ND mechanisms for correctly assigning IPv6 address to their interfaces resulting in a smooth traffic flow.

For validating the ND packets, the switch must first learn the trusted information by various mechanisms and store the information in a binding table. If the switch receives ND packets on an untrusted port, the packets are validated against entries in the binding table. If the ND packets pass the validation, the packets are forwarded. If the packets fail the validation, they are dropped in the switch itself. This process avoids invalid NA packets from propagating beyond the access switch.

IPv6 DHCP (DHCPv6) snooping and ND inspection feature protects the network from the following types of attacks:

- **User misconfigurations:** Host assigns an address which should not be used by the recipient device. ND inspection blocks this address in the access switch because binding entry does not exist for that address for that host.
- **DAD spoofing:** Malicious user claims that the address is taken even if it is not.
- **NUD spoofing:** Malicious host responds to NUD NS packets indicating that the address is still reachable via that host even if that neighbor is actually not reachable.

- **ND cache poisoning:** Malicious user sends different (invalid) link-layer addresses for a target IPv6 address causing other hosts in the network to program bogus MAC for a given IPv6 neighbor, as a result of which, the traffic gets black-holed or misused by malicious host.

Trust bindings

A switch enabled with the Neighbor Discovery inspection feature allows NA packets through, if the packets are from a trusted host. To allow or deny Neighbor Advertisement (NA) packets, trust bindings must be established using following methods:

- Configuring the port connected to a device (or host) as trusted.
- Building a Snooping Binding Table (SBT) which contains entries from trusted devices (or hosts) only. This SBT table is used for validating NA packets.

This method of trust binding involves 2 processes:

IPv6 address learning (snooping) process

In this process an IPv6 address is learnt through a trusted means and a SBT table is built. The switch supports SBT entry learning by:

- Statically configuring the entries
- Dynamically learning by snooping DHCPv6 packets

NA packet validation (inspection) process

This process uses the SBT entries which are populated as part of IPv6 address learning process to validate the incoming NA packets.

Once the trust bindings are built, the information gathered using trust binding is used to validate the ND packets. If the ND packets cannot be validated using this information, they are considered as packets received from an un-trusted host and are dropped in the switch itself.

Limitations

In addition to the FHS limitations, IPv6 DHCP snooping and ND inspection feature has the following limitations:

- Link-local address validation is not supported under ND inspection. Thus, an FHS enabled switch is vulnerable to attackers who try to attack with link-local addresses.
- DHCPv6 snooping is not supported for DHCPv6 packets with authentication header.
- As a 10-second timer is used to cleanup expired SBT entries, the expired SBT entries may remain in the SBT table for up to 10 seconds after they expire.
- If a FHS-enabled switch gets rebooted, all the dynamically-learned binding entries get flushed and those entries need to be re-learned for ND inspection to pass. However, when the switch is rebooted, DHCPv6 clients connected to it do not re-initiate DHCPv6 learning, due to which, the switch cannot learn these assigned IPv6 addresses. As a result, ND inspection fails for these addresses. To overcome this problem either DHCPv6 client must learn the IPv6 address again through DHCPv6 mechanisms or the administrator must add static entries for these addresses.
- SBT entries learned through DHCPv6 are not removed from the DHCPv6 table on DHCP clients that release these addresses. The administrator must manually remove these entries once the addresses are released.
- A dynamic SBT entry is learned only using the DHCPv6 mechanism. For other modes of address configuration on the host, a relevant SBT entry must be configured on the FHS switch so that ND packets from such host are not blocked due to ND inspection processing.

IPv6 FHS configuration using CLI

This section describes how to configure IPv6 First Hop Security (FHS) and protect the network by mitigating the various types of attacks.

*** Note:**

FHS does not solve all cases of denial of services like blocking flooding of the IPv6 messages.

FHS configuration

Configure IPv6 FHS features to enable IPv6 link security and management over the Layer 2 links.

Enabling or disabling FHS globally

About this task

You must enable First Hop Security globally for RA-guard or DHCPv6-guard to be operational.

Enabling FHS globally installs the required filters for FHS. Disabling FHS, uninstalls these filters. By default, FHS is disabled.

Procedure

1. Enter Global Configuration mode:

```
enable
configure terminal
```

2. Enable First Hop Security globally:

```
ipv6 fhs enable
```

3. Disable First Hop Security globally:

```
no ipv6 fhs enable
```

OR

```
default ipv6 fhs enable
```

Managing the FHS IPv6 access list

About this task

You can create an FHS IPv6 access list or add IPv6 prefixes to an existing IPv6 access list.

Procedure

1. Enter Global Configuration mode:

```
enable
configure terminal
```

2. Create an FHS IPv6 access list or add IPv6 prefixes to an existing IPv6 access list:

```
ipv6 fhs ipv6-access-list [WORD<1-64>] [WORD<0-46>] [ge<0-128>] [le
<0-128>] [mode <allow | deny>]
```

3. Delete an FHS IPv6 access list or delete a particular IPv6 prefix from the IPv6 access list:

```
no ipv6 fhs ipv6-access-list [WORD<1-64>] [WORD<0-46>]
```

4. Set the ge/le values and mode of the FHS IPv6 access list to default value:

```
default ipv6 fhs ipv6-access-list [WORD<1-64>] [WORD<0-46>] [ge|le|
mode]
```

Example

```
Switch>enable
Switch#config t
Enter configuration commands, one per line. End with CNTL/Z.
Switch(config)#ipv6 fhs ipv6-access-list ipv6_acl_1 fe80::221:2fff:fe31:5376/64
Switch(config)#
```

Variable definitions

Use the data in the following table to use the `ipv6 fhs ipv6-access-list` command.

Variable	Description
<i>WORD<1-64></i>	Specifies the IPv6 access list name.
<i>WORD<0-46></i>	Specifies the IPv6 address or the prefix length to be added to the IPv6 access list.
<i>ge <0 -128></i>	<p>Specifies the minimum value of prefix length advertised in prefix information of RA or DHCPv6 packets.</p> <p>By default, the value is equal to the configured prefix length.</p> <p>* Note:</p> <p>If you manually configure the value, ensure that it is greater than the configured prefix length. Also ensure, the ge value is always less than the le value.</p>
<i>le <0 -128></i>	<p>Specifies the maximum value of prefix length advertised in prefix information of RA or DHCPv6 packets.</p> <p>By default, the value is equal to the configured prefix length.</p> <p>* Note:</p> <p>If you manually configure the value, ensure that it is greater than the configured prefix length.</p>
<i>mode <allow deny></i>	<p>Specifies the access mode.</p> <p>By default, the value is allow.</p>

Displaying FHS IPv6 access list information

About this task

Displays the current FHS IPv6 access list information.

Procedure

1. Enter Privileged EXEC mode:
enable
2. Display the current FHS IPv6 access list information:
show ipv6 fhs ipv6-access-list [WORD<1-64>]

Example

```
Switch:1# show ipv6 fhs ipv6-access-list
=====
                        IPv6 FHS Access List Table Info
=====
ACC-LIST-NAME          IPV6-PREFIX                MASK-RANGE
                        MASK FROM TO      MODE
-----
v6_acl1                1:0:0:0:0:0:1            64 64 64    Allow
v6_acl2                1:0:0:0:0:0:1            64 64 64    Allow
-----
All 2 out of 2 Total Num of ipv6 access list entries displayed
```

Job aid

The following table shows the field descriptions for the **show ipv6 fhs ipv6-access-list** command.

Field	Description
Access list name	Indicates the IPv6 access list name.
ipv6_prefix	Indicates the IPv6 prefix added to the IPv6 access list.
mask_len	Indicates prefix mask length added to the IPv6 access list.
mask_range_from	Indicates the IPv6 range start mask length.
mask_range_to	Indicates the IPv6 range end mask length.
mode	Indicates the access mode.

Managing the FHS MAC access list

About this task

You can create an FHS MAC access list or add MAC addresses to an existing MAC access list.

Procedure

1. Enter Global Configuration mode:
enable
configure terminal
2. Create an FHS MAC access list or add MAC addresses to an existing MAC access list:

```
ipv6 fhs mac-access-list WORD<1-64> <0x00:0x00:0x00:0x00:0x00:0x00>
[mode <allow | deny>]
```

3. Delete an FHS MAC access list or delete a particular MAC address from the MAC access list:

```
no ipv6 fhs mac-access-list WORD<1-64>
<0x00:0x00:0x00:0x00:0x00:0x00>
```

4. Set the MAC ACL mode to its default value:

```
default ipv6 fhs mac-access-list WORD<1-64>
<0x00:0x00:0x00:0x00:0x00:0x00> [mode]
```

Variable definitions

Use the data in the following table to use the `ipv6 fhs mac-access-list` command.

Variable	Description
<code>WORD<1-64></code>	Specifies the MAC access list name.
<code><0x00:0x00:0x00:0x00:0x00:0x00></code>	Specifies the MAC address to be added or deleted.
<code>mode <allow deny></code>	Specifies the access mode. By default, the value is Allow

Displaying FHS MAC access list information

About this task

Displays the current FHS MAC access list information.

Procedure

1. Enter Privileged EXEC mode:

```
enable
```
2. Display the current FHS MAC access list information:

```
show ipv6 fhs mac-access-list [WORD<1-64>]
```

Example

```
Switch#show ipv6 fhs mac-access-list
=====
IPv6 FHS Mac Access List Table Info
=====
ACC-LIST-NAME      MAC-ADDRESS      ACL-MODE
-----
List2              10:20:30:40:50:60    Allow
                   00:11:22:33:44:55    Deny
-----
All 1 out of 1 Total Num of MAC access list entries displayed
=====
```

Job aid

The following table shows the field descriptions for the `show ipv6 fhs mac-access-list` command.

Field	Description
ACC-LIST-NAME	Indicates the MAC access list name.
MAC-ADDRESS	Indicates the MAC address.
ACL-MODE	Indicates the ACL mode.

Displaying current FHS configuration

About this task

Displays the current FHS configuration.

Procedure

1. Enter Privileged EXEC mode:

```
enable
```

2. Display the current FHS configuration:

```
show ipv6 fhs port-policy {slot/port[/sub-port] [-slot/port[/sub-port]] [,...]}
```

Example

```
Switch:1#show ipv6 fhs port-policy
=====
                        IPv6 FHS Port Policy Info
=====
PORT  DHCPG-DEVICE-ROLE  DHCPG-POLICY          RAG-DEVICE-ROLE  RAG-POLICY
-----
1/1   Server             dhcp_poll             Router           ra_poll
-----
All 1 out of 1 Total Num of fhs port policy entries displayed
```

Job aid

The following table shows the field descriptions for the `show ipv6 fhs port-policy` command.

Field	Description
PORT	Indicates the port number.
DHCPV6G-POLICY	Indicates the DHCPv6 policy name.
RA-POLICY	Indicates the RA-guard policy name.

DHCPv6-guard policy configuration

DHCPv6-guard policy blocks DHCPv6 reply and advertisement messages that originate from unauthorized DHCPv6 servers and relay agents that forward DHCPv6 packets from servers to clients.

Enabling or disabling DHCPv6-guard globally

About this task

Enabling DHCPv6-guard globally installs filters on the configured interfaces. By default, DHCPv6-guard is disabled.

Procedure

1. Enter Global Configuration mode:
`enable`
`configure terminal`
2. Enable FHS globally:
`ipv6 fhs enable`
3. Enable DHCPv6-guard globally:
`ipv6 dhcp-guard enable`
4. Disable DHCPv6-guard globally:
`no ipv6 dhcp-guard enable`
5. Set DHCPv6-guard to its default value:
`default ipv6 dhcp-guard enable`

Managing the DHCP Guard policy

About this task

Configure or modify the DHCP-guard policy.

Procedure

1. Enter Global Configuration mode:
`enable`
`configure terminal`
2. Create a DHCP guard policy:
`ipv6 dhcp-guard policy WORD<1-64>`
3. Delete a DHCP guard policy:
`no ipv6 dhcp-guard policy WORD<1-64>`

*** Note:**

You cannot delete a policy that is already attached to a port.

Variable definitions

Use the data in the following table to use the `ipv6 dhcp-guard policy` command.

Variable	Description
<code>WORD<1-64></code>	Specifies the created or deleted DHCPv6-guard policy name.

Attaching a DHCPv6-Guard policy to a port**About this task**

Applies a DHCP-guard policy to a specific interface.

Procedure

1. Enter Interface Configuration mode:

```
enable
configure terminal
interface GigabitEthernet {slot/port[/sub-port] [-slot/port[/sub-port]] [, ...]} or interface vlan <1-4059>
```

*** Note:**

If your platform supports channelization and the port is channelized, you must also specify the sub-port in the format slot/port/sub-port.

2. Apply a DHCP guard policy.

```
ipv6 fhs dhcp-guard attach-policy WORD<1-64>
```

3. Detach a DHCP guard policy from an interface.

```
no ipv6 fhs dhcp-guard attach-policy
```

OR

```
default ipv6 dhcp-guard attach-policy
```

4. Enable device role verification attached to the port. By default, router is selected.

```
ipv6 fhs dhcp-guard device-role {client|server} attach-policy
WORD<1-64>
```

*** Note:**

A DHCPv6-guard policy can be attached to a port only if the device-role configured on that port is 'server'.

Variable definitions

Use the data in the following table to use the `ipv6 fhs dhcp-guard attach-policy` and `ipv6 fhs dhcp-guard device-role` command.

Variable	Description
<code>WORD<1-64></code>	Specify the name of the DHCP guard policy to be attached or detached.
<code>{client server}</code>	Sets the DHCP-guard device role as client or server.

Configuring DHCP Guard in dhcp-guard mode

About this task

Configures DHCP guard under dhcp-guard mode.

Procedure

1. Enter DHCP-guard Configuration mode.

```
enable
configure terminal
ipv6 fhs dhcp-guard policy WORD<1-64>
```
2. Specify IPv6 access list to verify IPv6 source address of DHCPv6 packets..

```
match server access-list <ipv6-access-list-name>
```
3. Remove DHCP guard filtering for the sender's IPv6 addresses.

```
no match server access-list
```

OR

```
default match server access-list
```
4. Specify IPv6 prefix list to verify advertised prefixes.

```
match reply prefix-list <ipv6-prefix-list-name>
```
5. Remove DHCP guard filtering for advertised prefixes.

```
no match reply prefix-list
```

OR

```
default match reply prefix-list
```
6. Specify the minimum limit for verification of the advertised preference.

```
preference min-limit <0-255>
```
7. Set the minimum limit for verification of the advertised preference to its default value.

```
default preference min-limit
```
8. Specify the maximum limit for verification of the advertised preference.

```
preference max-limit <0-255>
```

- Set the maximum limit for verification of the advertised preference to its default value.

```
default preference max-limit
```

Variable definitions

Use the data in the following table to use the `dhcp-guard` configuration mode commands.

Variable	Description
match server access-list <ipv6-access-list-name>	<p>Enables verification of the sender's IPv6 address in inspected messages from the configured authorized device source access list specified.</p> <p>Note:</p> <p>If the access-list is not attached, the IPv6 source address in DHCPv6 packet is not validated.</p> <p>If the list is attached and it does not match any entries in IPv6 access list, the switch drops the DHCPv6 packet. If you wish to change this behavior, add an entry with IPv6 prefix "0::0/0" with the Allow option, which changes the default drop to default Allow.</p>
{ no default } match server access-list	Removes the sender's IPv6 address based DHCPv6-guard filtering.
match reply prefix-list <ipv6-prefix-list-name>	<p>Enables verification of the advertised prefixes in DHCPv6 reply messages from the configured authorized prefix list. If prefix-list is not configured, this check is bypassed.</p> <p>Note:</p> <p>If the access-list is not attached, the inspection does not occur.</p> <p>If the list is attached and advertised IPv6 address does not match any IPv6 prefixes in the list, the switch drops the DHCPv6 packet. If you wish to change this behavior, add an IPv6 access list entry with prefix 0::0/0 with the Allow option, which changes the default drop to default Allow.</p>
{ no default } match reply prefix-list	Removes the advertised prefix-based DHCP-guard filtering.
preference min-limit<0-255>	<p>Enables validation of advertised preference (in preference option) to check if it is greater than the specified limit. If preference is not specified, this field in the packet is not validated.</p> <p>While changing the preference limit, ensure the maximum limit is greater than the minimum limit.</p>
default preference min-limit	<p>Sets the specified limit to its default value.</p> <p>By default, the value is 0.</p>
preference max-limit<0-255>	Enables validation of advertised preference (in preference option) to check if it is less than the specified limit. If preference is not specified, this field in the packet is not validated.

Table continues...

Variable	Description
	<p> Note:</p> <p>The preference value in the packet is not validated if both minimum and maximum values are zero.</p>
default preference max-limit	<p>Sets the specified limit to its default value.</p> <p>By default, the value is 0.</p>

Displaying DHCPv6-guard policy

About this task

Displays DHCPv6-guard policy information for all the configured DHCPv6-guard policies or a particular policy.

Procedure

1. Log on to the switch to enter User EXEC mode.
2. Display DHCPv6-guard policy information:

```
show ipv6 fhs dhcp-guard policy WORD<1-64>
```

Example

```
Switch:1# show ipv6 fhs dhcp-guard policy
```

```
=====
                                     IPv6 DHCP Guard Policy Info
=====
POLICY-NAME          SERVER-ACC-LIST      REPLY-PREF-LIST     MIN-RTR-PREF  MAX-RTR-PREF
-----
dhcp_pol1            v6_acl1             v6_acl2              0              0
-----
```

```
All 1 out of 1 Total Num of dhcp-guard stats entries displayed
```

Variable definitions

Use the data in the following table to use the `show ipv6 dhcp-guard policy` command.

Variable	Description
<code>WORD<1-64></code>	<p>Displays DHCPv6-guard policy information for all the configured DHCPv6-guard policies.</p> <p>Policy name is an optional parameter. If policy name is provided, only the DHCPv6-guard policy of the specified policy-name is displayed.</p>

Job aid

The following table shows the field descriptions for the `show ipv6 dhcp-guard policy` command.

Field	Description
POLICY-NAME	Indicates the DHCPv6-guard policy name.
SERVER-ACC-LIST	Indicates if the received DHCPv6-server packet source IPv6 addresss matches the configured IPv6 access list.
REPLY-PREF-LIST	Indicates if the advertised prefix in received DHCPv6 server packet matches the configured IPv6 access list.
MIN-RTR-PREF	Indicates the advertised router preference minimum limit.
MAX-RTR-PREF	Indicates the advertised router preference maximum limit.

RA-guard configuration

IPv6 RA-guard provides support to the administrator to block or reject unwanted RA-guard messages that arrive at the network switch platform. The routers use Router Advertisements (RAs) to announce themselves on the link. The RA-guard feature analyzes these RAs and filters out bogus RAs sent by unauthorized routers. The RA-guard feature compares configuration information on the Layer 2 device with the information found in the received RA frame. After the Layer 2 device validates the content of the RA packet against the configuration, it forwards the RA to its destination. If the RA packet validation fails, the RA is dropped.

Enabling or disabling RA-guard globally

About this task

Enables the RA-guard globally. By default, RA-guard is disabled.

Procedure

1. Enter Global Configuration mode:

```
enable
configure terminal
```
2. Enable FHS globally:

```
ipv6 fhs enable
```
3. Enable RA-guard globally:

```
ipv6 fhs ra-guard enable
```
4. Disable RA-guard globally:

```
no ipv6 fhs ra-guard enable
```
5. Set the RA-guard to its default value:

```
default ipv6 fhs ra-guard enable
```

Managing the RA-guard policy

About this task

Configure or modify RA-guard policy. This command also enables the RA-guard configuration mode.

Procedure

1. Enter Global Configuration mode:

```
enable
configure terminal
```

2. Create the RA-guard policy:

```
ipv6 fhs ra-guard policy WORD<1-64>
```

3. Delete the RA-guard policy:

```
no ipv6 fhs ra-guard policy WORD<1-64>
```

* Note:

You cannot delete a policy that is attached to a port.

Variable definitions

Use the data in the following table to use the `ipv6 fhs ra-guard policy` command.

Variable	Description
<code>WORD<1-64></code>	Specifies the name of the RA-guard policy to be created or deleted. This is a mandatory parameter in this command.

Configuring RA-guard on an interface

About this task

Attaches or detaches a RA-guard policy on the specific interface.

Procedure

1. Enter GigabitEthernet Interface Configuration mode:

```
enable
configure terminal
interface GigabitEthernet {slot/port[/sub-port] [-slot/port[/sub-port]][,...]}
```

* Note:

If your platform supports channelization and the port is channelized, you must also specify the sub-port in the format slot/port/sub-port.

2. Apply a RA-guard policy.

```
ipv6 fhs ra-guard attach-policy WORD<1-64>
```

*** Note:**

RA-guard device-role on the port has to be configured as 'router' before attaching any RA-guard policy to the port. If device-role on the port is not 'router', this command will fail with an appropriate error message.

3. Detach a RA-guard policy from an interface.

```
no ipv6 fhs ra-guard attach-policy
```

OR

```
default ipv6 fhs ra-guard attach-policy
```

4. Enable device role verification attached to the port.

```
ipv6 fhs ra-guard device-role {router|host} attach-policy WORD<1-64>
```

*** Note:**

A DHCPv6-guard policy can be attached to a port only if the device-role configured on that port is 'server'.

Variable definitions

Use the data in the following table to use the `ipv6 fhs ra-guard attach-policy` and `ipv6 fhs ra-guard device-role` command.

Variable	Description
<code>WORD<1-64></code>	Specifies the name of the RA-guard policy to be attached or detached.
<code>{host router}</code>	Sets the RA-guard device role as host or router.

Configuring RA-guard in ra-guard mode

About this task

Configures RA-guard under the ra-guard mode.

Procedure

1. Enter RA-guard Configuration mode.

```
enable
```

```
configure terminal
```

```
ipv6 fhs ra-guard policy WORD<1-64>
```

2. Configure the filter to match the IPv6 prefixes advertised in RA packets.

```
match ra-prefix-list WORD<1-64>
```

3. Remove RA-guard filtering for the advertised prefixes.

```
no match ra-prefix-list
```

OR

```
default match ra-prefix-list
```

4. Configure the filter to match the source MAC address of RA packets.

```
match ra-macaddr-list WORD<1-64>
```

5. Remove the source MAC address-based RA-guard filtering.

```
no match ra-macaddr-list
```

OR

```
default match ra-macaddr-list
```

6. Configure the filter to match source IPv6 address of RA packets.

```
match ra-srcaddr-list WORD<1-64>
```

7. Remove the source IPv6 address based RA-guard filtering.

```
no match ra-srcaddr-list
```

OR

```
default match ra-srcaddr-list
```

8. Enable managed address configuration flag verification in the advertised RA packet.

```
managed-config-flag <none | on | off>
```

9. Enable advertised hop count limit verification.

```
hop-limit {maximum | minimum} <0-255>
```

10. Enable the advertised default router-preference parameter value verification.

```
router-preference maximum {none | high | low | medium}
```

Variable definitions

Use the data in the following table to configure RA guard policy.

Variable	Description
match ra-prefix-list WORD<1-64>	<p>Verifies the advertised prefixes in RA packets against the configured authorized prefix list.</p> <p> Note:</p> <p>RA packet's sender IPv6 address is not validated if no IPv6 source access list is attached to the RA guard policy.</p>

Table continues...

Variable	Description
	<p>If the list is attached and if RA packet's sender IPv6 address does not match any entry in that IPv6 prefix list, then the RA packet is dropped. To change this behavior, add a entry with ipv6 prefix "0::0/0" with Allow option. The default value changes from Drop to Allow.</p>
{no default} match ra-prefix-list	<p>Removes the advertised prefix-based RA-guard filtering</p>
match ra-macaddr-list <i>WORD</i> <1–64>	<p>Verifies sender's source MAC address against the configured mac-access-list.</p> <p>* Note:</p> <p>Advertised prefixes in RA packet are not validated if no IPv6 prefix list is attached to the RA guard policy.</p> <p>If the list is attached and if it does not match any MAC in the list, then the RA packet is dropped.</p>
{no default} match ra-macaddr-list	<p>Removes the source MAC address-based RA-guard filtering for the specified MAC address access list names.</p>
match ra-srcaddr-list <i>WORD</i> <1–64>	<p>Verifies sender's source IPV6 address against the configured list.</p> <p>* Note:</p> <p>Inspection is not done if the access-list is not attached.</p> <p>If the list is attached and if it does not match any IPv6 in the list, then the RA packet is dropped. To change the behavior, add a dummy IPv6 "0:0:0:0:0" to the list with Allow option. The default value changes from Drop to Allow.</p>
{no default} match ra-srcaddr-list	<p>Removes the source IPv6 address-based RA-guard filtering for the specified IPv6 address access list names.</p>
managed-config-flag <none on off>	<p>Verifies managed address configuration flag in the advertised RA packet.</p> <p>By default, the value is none and check is bypassed.</p>
hop-limit {maximum minimum} <0–255>	<p>Verifies the advertised hop count limit. The limit value range is from 0 to 255.</p> <p>While changing the minimum or maximum value, ensure the maximum value is greater than the minimum value.</p>

Table continues...

Variable	Description
	By default, the minimum and maximum limit are 0. In this case, the hop-limit check is bypassed.
router-preference maximum {none high low medium}	Verifies if the advertised default router-preference parameter value is lower than or equal to a specified limit. By default, the value is none and the check is bypassed.

Displaying RA-guard configuration

About this task

Display configured RA-guard policy information.

Procedure

1. Log on to the switch to enter User EXEC mode.
2. Display configured RA-guard policy information:

```
show ipv6 fhs ra-guard policy WORD<1-64>
```

Example

```
Switch:1# show ipv6 fhs ra-guard policy
=====
                                     IPv6 Ra Guard Policy Info
=====
HOP  MAX-HOP  MANAGED                                     MIN-
POLICY-NAME  RA-SRC-ADDR-LIST  RA-MAC-ADDR-LIST  RA-PREFIX-LIST  LIMIT  LIMIT  CON-
FLAG  PREF
-----
Ra_guard_poll  None          None          ac11          0      0
None          None
-----
All 1 out of 1 Total Num of ra-guard policy entries displayed
```

Variable definitions

Use the data in the following table to use the **show ipv6 fhs ra-guard policy** command.

Variable	Description
WORD<1-64>	Displays the RA-guard policy for the specified policy-name. By default, all the configured RA-guard policies are displayed.

Job aid

The following table shows the field descriptions for the **show ipv6 fhs ra-guard policy** command.

Field	Description
POL-NAME	Indicates the RA-guard policy name.
DEVICE-ROLE	Indicates if the device role is router or host.
IPv6-ACC-LIST	Indicates the IPv6 access list against which the incoming RA packet's source IPv6 address has to be validated.
MAC-ACC-LIST	Indicates the MAC access list against which the incoming RA packet's source MAC address has to be validated.
PREFIX-LIST	Specifies the IPv6 prefix list against which advertised prefix information in incoming RA packets source need to be validated.
MIN HOP-LIMIT	Indicates the advertised hop count minimum limit.
MAX HOP-LIMIT	Indicates the advertised hop count maximum limit.
MANAGED CONF-FLAG	Indicates the managed address configuration flag status in the advertised RA packet.
RTR-PREF	Indicates the advertised default router preference value.

IPv6 DHCP snooping configuration

This section describes how to configure IPv6 DHCP snooping on the switch and protect the network by mitigating the various types of attacks.

Important:

Configure DHCPv6 guard before enabling IPv6 DHCP snooping. DHCPv6 guard classifies the ports as trusted or un-trusted and extracts DHCPv6 reply packets received on trusted ports to the control path. For more information on how to configure DHCPv6 guard, see [DHCPv6-guard policy configuration](#) on page 67.

Creating a static Security Binding Table entry

Use this procedure to enable learning Security Binding Table (SBT) entries on all the VLANs where IPv6 DHCP snooping is configured.

About this task

Use this procedure to create a static SBT entry.

Procedure

1. Enter Global Configuration mode:

```
enable
configure terminal
```

2. Add a static SBT entry:

```
ipv6 fhs snooping static-binding ipv6-address WORD<0-46> vlan
<1-4059> mac-address 0x00:0x00:0x00 port {slot/port[/sub-port]}
```

* Note:

To delete an SBT entry, use the command `no ipv6 fhs snooping static-binding`.

Example

Add a static SBT entry.

```
Switch:1> enable
Switch:1# configure terminal
Switch:1(config)#ipv6 fhs snooping static-binding ipv6-address 0123:4567:89ab:cdef:
0123:4567:89ab:cdef vlan 1000 mac-address 00:11:22:33:44:55 port 1/2
```

Variable definitions

Use the data in the following table to use the `ipv6 fhs snooping static-binding ipv6-address` command.

Variable	Value
mac-address 0x00:0x00:0x00	Specifies the MAC address of the binding entry.
port {slot/port[/sub-port]}	Identifies a single slot and port. If your platform supports channelization and the port is channelized, you must also specify the sub-port in the format slot/port/sub-port.
vlan <1-4059>	Specifies the VLAN ID in the range of 1 to 4059. By default, VLAN IDs 1 to 4059 are configurable and the system reserves VLAN IDs 4060 to 4094 for internal use. If you enable VRF scaling and SPBM mode, the system also reserves VLAN IDs 3500 to 3999. VLAN ID 1 is the default VLAN and you cannot create or delete VLAN ID 1.
WORD<0-46>	Specifies the IPv6 address for the binding entry.

Clearing a dynamic SBT entry

About this task

Use this procedure to clear all or a particular dynamic SBT entry.

Procedure

1. Enter Privileged EXEC mode:

```
enable
```

2. Clear a dynamic SBT entry:

```
clear ipv6 fhs snooping [vlan <1-4059>][ipv6-address WORD<0-46>]
```

Example

Clear a dynamic SBT entry on a VLAN.

```
Switch:1> enable
Switch:1>clear ipv6 fhs snooping vlan 1000 ipv6-address 0123:4567:89ab:cdef:
0123:4567:89ab:cdef
```

Variable definitions

Use the data in the following table to use the `clear ipv6 fhs snooping` command.

Variable	Value
ipv6-address <i>WORD</i> <0-46>	Specifies the IPv6 address for the binding entry to clear. You cannot specify an address without first specifying the VLAN.
vlan <1-4059>	Specifies the VLAN ID in the range of 1 to 4059. By default, VLAN IDs 1 to 4059 are configurable and the system reserves VLAN IDs 4060 to 4094 for internal use. If you enable VRF scaling and SPBM mode, the system also reserves VLAN IDs 3500 to 3999. VLAN ID 1 is the default VLAN and you cannot create or delete VLAN ID 1. If you do not specify a VLAN, the command clears all entries.

Enabling IPv6 DHCP snooping on a VLAN

Before you begin

Enable IPv6 DHCP guard for IPv6 DHCP snooping to work.

About this task

Use this procedure to configure IPv6 DHCP snooping on a VLAN.

Procedure

1. Enter VLAN Interface Configuration mode:

```
enable
configure terminal
interface vlan <1-4059>
```

2. Configure IPv6 DHCP snooping on the VLAN:

```
ipv6 fhs snooping dhcp enable
```

Viewing IPv6 DHCP snooping and ND inspection status on a VLAN

About this task

Use this procedure to view IPv6 DHCP snooping and ND inspection status on a VLAN.

Procedure

1. Enter Privileged EXEC mode:
enable
2. View the IPv6 DHCP snooping and ND inspection status on a VLAN:
show ipv6 fhs status vlan [<1-4059>]

Example

View the status for all VLANs.

```
Switch:1#show ipv6 fhs status vlan
=====
                        IPv6 FHS VLAN Information
=====
VLAN-ID                DHCP-SNOOPING-STATUS      ND-INSPECTION-STATUS
-----
1                       Disabled                  Disabled
3                       Disabled                  Disabled
4                       Disabled                  Disabled
22                      Disabled                  Disabled
=====
All 4 out of 4 Total Num of FHS VLAN entries displayed
```

Variable definitions

Use the data in the following table to use the **show ipv6 fhs status vlan** command.

Variable	Value
<1-4059>	Specifies the VLAN ID in the range of 1 to 4059. By default, VLAN IDs 1 to 4059 are configurable and the system reserves VLAN IDs 4060 to 4094 for internal use. If you enable VRF scaling and SPBM mode, the system also reserves VLAN IDs 3500 to 3999. VLAN ID 1 is the default VLAN and you cannot create or delete VLAN ID 1. If you do not specify a VLAN ID, the command output includes all VLANs.

Viewing SBT entries**About this task**

Use this procedure to view SBT entries.

Procedure

1. Enter Privileged EXEC mode:
enable
2. View all SBT entries:

```
show ipv6 fhs snooping binding
```

3. View the SBT entries by type:

```
show ipv6 fhs snooping binding type {dynamic | static}
```

4. View the SBT entries by VLAN:

```
show ipv6 fhs snooping binding vlan <1-4059>[ipv6-address  
WORD<0-46>]
```

Variable definitions

Use the data in the following table to use the `show ipv6 fhs snooping binding` command.

Variable	Value
ipv6-address WORD<0-46>	Specifies the IPv6 address for the binding entry.
type {dynamic static}	Shows only dynamic binding entries or static binding entries.
vlan <1-4059>	Specifies the VLAN ID in the range of 1 to 4059. By default, VLAN IDs 1 to 4059 are configurable and the system reserves VLAN IDs 4060 to 4094 for internal use. If you enable VRF scaling and SPBM mode, the system also reserves VLAN IDs 3500 to 3999. VLAN ID 1 is the default VLAN and you cannot create or delete VLAN ID 1.

IPv6 Neighbor Discovery inspection configuration

This section describes how to configure ND inspection on the switch and protect the network by mitigating the various types of attacks.

! Important:

Enable FHS globally before enabling ND inspection.

Enabling ND inspection globally

Before you begin

Enable FHS globally for ND inspection to work.

About this task

Use this procedure to enable Neighbor Discovery (ND) inspection globally.

Procedure

1. Enter Global Configuration mode:

```
enable  
configure terminal
```

2. Enable ND inspection globally:

```
ipv6 fhs nd-inspection enable
```

Clearing Neighbor Discovery inspection statistics

About this task

Use this procedure to clear the Neighbor Discovery inspection statistics.

Procedure

1. Enter Privileged EXEC mode:

```
enable
```

2. Clear the Neighbor Discovery inspection statistics:

```
clear ipv6 fhs statistics nd-inspection [{slot/port[/sub-port]} [-slot/port[/sub-port]] [,...]]
```

* Note:

Alternatively, you can use the command `clear ipv6 fhs statistics all` to clear the ND inspection statistics along with RA guard statistics and DHCP guard statistics.

Variable definitions

Use the data in the following table to use the `clear ipv6 fhs statistics nd-inspection` command.

Variable	Value
{slot/port[/sub-port]}[-slot/port[/sub-port]][,...]	Identifies the slot and port in one of the following formats: a single slot and port (slot/port), a range of slots and ports (slot/port-slot/port), or a series of slots and ports (slot/port,slot/port,slot/port). If your platform supports channelization and the port is channelized, you must also specify the sub-port in the format slot/port/sub-port.

Enabling Neighbor Discovery inspection on a VLAN

Before you begin

Enable FHS globally for ND inspection to work.

About this task

Use this procedure to enable Neighbor Discovery inspection on a VLAN.

Procedure

1. Enter VLAN Interface Configuration mode:

```
enable
```

```
configure terminal
```

```
interface vlan <1-4059>
```

2. Enable Neighbor Discovery inspection on the VLAN:

```
ipv6 fhs nd-inspection enable
```

Enabling Neighbor Discovery inspection on a port

Before you begin

Enable FHS globally for ND inspection to work.

About this task

Use this procedure to enable Neighbor Discovery inspection on a port

Procedure

1. Enter GigabitEthernet Interface Configuration mode:

```
enable
```

```
configure terminal
```

```
interface GigabitEthernet {slot/port[/sub-port] [-slot/port[/sub-port]] [,...]}
```

* Note:

If your platform supports channelization and the port is channelized, you must also specify the sub-port in the format slot/port/sub-port.

2. Enable Neighbor Discovery inspection on the port:

```
ipv6 fhs nd-inspection enable
```

Viewing Neighbor Discovery inspection status globally

About this task

Use this procedure to view the Neighbor Discovery inspection status globally

Procedure

1. Enter Privileged EXEC mode:

```
enable
```

2. Display the ND inspection status globally:

```
show ipv6 fhs status
```

Viewing Neighbor Discovery inspection status on a port

About this task

Use this procedure to view Neighbor Discovery inspection status on a port.

Procedure

1. Enter Privileged EXEC mode:
`enable`
2. Display port-wise ND inspection status:
`show ipv6 fhs port-policy`

Viewing Neighbor Discovery inspection statistics on a port**About this task**

Use this procedure to view the Neighbor Discovery inspection statistics on a port or set of ports.

Procedure

1. Enter Privileged EXEC mode:
`enable`
2. Display ND inspection statistics on a port or a set of ports:
`show ipv6 fhs statistics nd-inspection {slot/port[/sub-port] [-slot/port[/sub-port]] [,...]}`

Variable definitions

Use the data in the following table to use the `show ipv6 fhs statistics nd-inspection` command.

Variable	Value
{slot/port[/sub-port] [-slot/port[/sub-port]] [,...]}	Identifies the slot and port in one of the following formats: a single slot and port (slot/port), a range of slots and ports (slot/port-slot/port), or a series of slots and ports (slot/port,slot/port,slot/port). If your platform supports channelization and the port is channelized, you must also specify the sub-port in the format slot/port/sub-port.

IPv6 FHS configuration using EDM

This chapter describes how to configure IPv6 First Hop Security (FHS) on the switch and protect the network by mitigating the various types of attacks using Enterprise Device Manager (EDM).

*** Note:**

FHS does not solve all cases of denial of services like blocking flooding of the IPv6 messages.

Configuring FHS Globals

About this task

Use this procedure to enable FHS to enable DHCPv6-guard, RA-guard, and ND-inspection globally, and to configure the lifetime for these policies.

Procedure

1. From the navigation pane, expand the following folders: **Configuration > IPv6**.
2. Click **FHS**.
3. Click the **Globals** tab.
4. Select FHS global options.
5. Click **Apply** to save the changes.
6. **(Optional)** Click **Refresh** to update the results.

Globals field descriptions

Use the data in the following table to use the Globals tab.

Name	Description
Admin	Enables or disables the FHS policy.
RAGuardAdmin	Enables or disables the RA-guard policy.
DHCPv6GuardAdmin	Enables or disables the DHCPv6-guard policy.
NdInspectAdmin	Enables or disables Neighbor Discovery inspection.

IPv6 access list configuration

An IPv6 access list is created to verify the sender's IPv6 address in the inspected messages. You can create, view, or delete an IPv6 access list.

Creating IPv6 access list

About this task

Use this procedure to create an FHS IPv6 access list or add IPv6 prefixes to the existing IPv6 access list.

Procedure

1. In the navigation pane, expand the following folders: **Configuration—> IPv6**.
2. Click **FHS**.
3. Click the **IPv6 Access List** tab.

4. Click **Insert**.
5. Configure the parameters for the IPv6 access list.
6. Click **Insert**.

IPv6 Access List field descriptions

Use the data in the following table to use the IPv6 Access List tab.

Name	Description
Name	Specify the IPv6 access list name to create the IPv6 access list.
Prefix	Specify the IPv6 prefix for adding it to the IPv6 access list.
PrefixMaskLen	Specify the prefix length for adding it to the IPv6 access list. The value range is from 0 to 128. By default, the value is 0.
MaskLenFrom	Specify the start mask length for providing the IPv6 range. The value range is from 0 to 128. By default, the value is set to the configured prefix length of the IPv6 access list entry.
MaskLenTo	Specify the end mask length for providing the IPv6 range. The value range is from 0 to 128. By default, the value is set to the configured prefix length of the IPv6 access list entry.
AccessType	Select the access type to allow or deny the entry. By default, the access type is allow.

Note:

- **MaskLenFrom** and **MaskLenTo** must always be greater than or equal to the configured **PrefixMaskLen** for this IPv6 access list entry
- The **MaskLenFrom** value must always be less than or equal to the **MaskLenTo** value.

Viewing IPv6 access list

About this task

Use this procedure to display the IPv6 access list.

Procedure

1. In the navigation pane, expand the following folders: **Configuration**—> **IPv6**.
2. Click **FHS**.
3. Click the **IPv6 Access List** tab.

IPv6 Access List field descriptions

Use the data in the following table to use the IPv6 Access List tab.

Name	Description
Name	Specify the IPv6 access list name to create the IPv6 access list.
Prefix	Specify the IPv6 prefix for adding it to the IPv6 access list.
PrefixMaskLen	Specify the prefix length for adding it to the IPv6 access list. The value range is from 0 to 128. By default, the value is 0.
MaskLenFrom	Specify the start mask length for providing the IPv6 range. The value range is from 0 to 128. By default, the value is set to the configured prefix length of the IPv6 access list entry.
MaskLenTo	Specify the end mask length for providing the IPv6 range. The value range is from 0 to 128. By default, the value is set to the configured prefix length of the IPv6 access list entry.
AccessType	Select the access type to allow or deny the entry. By default, the access type is allow.

*** Note:**

- **MaskLenFrom** and **MaskLenTo** must always be greater than or equal to the configured **PrefixMaskLen** for this IPv6 access list entry
- The **MaskLenFrom** value must always be less than or equal to the **MaskLenTo** value.

Deleting the IPv6 access list

About this task

Use this procedure to delete the created IPv6 access list.

Procedure

1. In the navigation pane, expand the following folders: **Configuration**—> **IPv6**.
2. Click **FHS**.
3. Click the **IPv6 Access List** tab.
4. Select a row from the IPv6 access list to delete.
5. Click **Delete**.

MAC access list configuration

A MAC access list is created to verify the sender's MAC address in the RA packet. You can view, create or delete a MAC access list.

Creating MAC access list

About this task

Use this procedure to create a MAC access list or add a MAC address to the existing MAC access list.

Procedure

1. In the navigation pane, expand the following folders: **Configuration > IPv6**.
2. Click **FHS**.
3. Click the **MAC Access List** tab.
4. Click **Insert**.
5. Configure the parameters for the MAC access list.
6. Click **Insert**.

MAC Access List field descriptions

Use the data in the following table to use the MAC Access List tab.

Name	Description
Name	Specify a name to create a MAC access list.
Mac	Specify the MAC address to add to the MAC access list, in (xx:xx:xx:xx:xx:xx) format.
AccessType	Specify allow or deny. By default, the access type is allow.

Viewing a MAC access list

About this task

Use this procedure to display a configured MAC access list.

Procedure

1. In the navigation pane, expand the following folders: **Configuration > IPv6**.
2. Click **FHS**.
3. Click the **MAC Access List** tab.

MAC Access List field descriptions

Use the data in the following table to use the MAC Access List tab.

Name	Description
Name	Specify a name to create a MAC access list.
Mac	Specify the MAC address to add to the MAC access list, in (xx:xx:xx:xx:xx:xx) format.

Table continues...

Name	Description
AccessType	Specify allow or deny. By default, the access type is allow.

Deleting a MAC access list

About this task

Use this procedure to delete the created MAC access list.

Procedure

1. In the navigation pane, expand the following folders: **Configuration > IPv6**.
2. Click **FHS**.
3. Click the **MAC Access List** tab.
4. Select a row from the MAC access list to delete.
5. Click **Delete**.

DHCPv6-guard policy configuration

Configure the DHCPv6-guard policy to block DHCPv6 reply and advertisement messages that originate from unauthorized DHCPv6 servers and relay agents that forward DHCPv6 packets from servers to clients. You can view, create or delete a DHCPv6-guard policy.

Creating DHCPv6-guard policy

About this task



Use this procedure to create the DHCPv6-guard policy to block DHCPv6 reply and advertisement messages that originate from unauthorized DHCPv6 servers and relay agents.

Procedure

1. In the navigation pane, expand the following folders: **Configuration > IPv6**.
2. Click **FHS**.
3. Click the **DHCPv6 Guard Policy** tab.
4. Click **Insert**.
5. Configure the parameters for the DHCPv6-guard policy.
6. Click **Insert**.
7. **(Optional)** Click **Refresh** to update the results.

DHCPv6 Guard Policy field descriptions

Use the data in the following table to use the DHCPv6 Guard Policy tab.

Name	Description
PolicyName	Specifies the policy name to create or modify DHCPv6-guard policy.
ServerAccessListName	<p>Enables verification of the sender IPv6 address in the DHCPv6 reply or advertisement packets against attached IPv6 server access list.</p> <p> Note:</p> <p>If the access-list is not attached, the source IPv6 address is not validated. If the list is attached and it does not match with any entries in attached IPv6 access list, the switch drops the DHCPv6 packet. To change this behavior, add an entry in the IPv6 access list with prefix 0::0/0 with access type as allow, which changes the drop by default to allow by default.</p>
ReplyPrefixListName	<p>Enables verification of the advertised prefixes in DHCPv6 reply messages against the attached prefix list. If not configured, this check is bypassed.</p> <p> Note:</p> <p>If the access-list is not attached, the advertised address/prefix is not validated. If the list is attached and it does not match with any entries in attached IPv6 access list, the switch drops the DHCPv6 packet. To change this behavior, an entry in the IPv6 access list with prefix 0::0/0 with access type as allow, which changes the drop by default to allow by default.</p>
PrefLimitMin	<p>Enables verification if the advertised preference (in reference option) is greater than the specified limit. If not specified, this check does not occur.</p> <p>The value range is from 0 to 255.</p>
PrefixLimitMax	<p>Enables verification if the advertised preference (in preference option) is less than the specified limit. If not specified, this check does not occur.</p> <p>The value range is from 0 to 255.</p> <p> Note:</p> <p>If both the maximum and minimum limit is 0, this preference check is ignored.</p>

Viewing a DHCPv6-guard policy

About this task

Use this procedure to display configured DHCPv6-guard policies.

Procedure

1. In the navigation pane, expand the following folders: **Configuration > IPv6**.
2. Click **FHS**.
3. Click the **DHCPv6 Guard Policy** tab.

DHCPv6 Guard Policy field descriptions

Use the data in the following table to use the DHCPv6 Guard Policy tab.



Name	Description
PolicyName	Specifies the policy name to create or modify DHCPv6-guard policy.
ServerAccessListName	<p>Enables verification of the sender IPv6 address in the DHCPv6 reply or advertisement packets against attached IPv6 server access list.</p> <p> Note:</p> <p>If the access-list is not attached, the source IPv6 address is not validated. If the list is attached and it does not match with any entries in attached IPv6 access list, the switch drops the DHCPv6 packet. To change this behavior, add an entry in the IPv6 access list with prefix 0::0/0 with access type as allow, which changes the drop by default to allow by default.</p>
ReplyPrefixListName	<p>Enables verification of the advertised prefixes in DHCPv6 reply messages against the attached prefix list. If not configured, this check is bypassed.</p> <p> Note:</p> <p>If the access-list is not attached, the advertised address/prefix is not validated. If the list is attached and it does not match with any entries in attached IPv6 access list, the switch drops the DHCPv6 packet. To change this behavior, an entry in the IPv6 access list with prefix 0::0/0 with access type as allow, which changes the drop by default to allow by default.</p>
PrefLimitMin	<p>Enables verification if the advertised preference (in reference option) is greater than the specified limit. If not specified, this check does not occur.</p> <p>The value range is from 0 to 255.</p>
PrefixLimitMax	<p>Enables verification if the advertised preference (in preference option) is less than the specified limit. If not specified, this check does not occur.</p>

Table continues...

Name	Description
	<p>The value range is from 0 to 255.</p> <p> Note:</p> <p>If both the maximum and minimum limit is 0, this preference check is ignored.</p>

Deleting a DHCPv6-guard policy

About this task

Use this procedure to delete the created DHCPv6-guard policy.

Note:

If this policy is already attached to an interface, then this policy cannot be deleted.

Procedure

1. In the navigation pane, expand the following folders: **Configuration > IPv6**.
2. Click **FHS**.
3. Click the **DHCPv6 Guard Policy** tab.
4. Select a row from DHCPv6 Guard policies to delete.
5. Click **Delete**.

RA-guard policy configuration

Configure RA-guard to block or reject unwanted or rogue RA messages that arrive at the network device platform. You can view, create or delete RA-guard policy.

Creating RA-guard policy

About this task

Use this procedure to create a RA-guard policy to block or reject unwanted or rogue RA messages that arrive at the network device platform.

Procedure

1. In the navigation pane, expand the following folders: **Configuration > IPv6**.
2. Click **FHS**.
3. Click the **RA Guard Policy** tab.
4. Click **Insert**.
5. Configure the parameters for the RA-guard policy.
6. Click **Insert**.
7. **(Optional)** Click **Refresh** to update the results.

RA Guard Policy field descriptions

Use the data in the following table to use the RA Guard Policy tab.

Name	Description
PolicyName	Specify the name of the RA-guard policy to be created or modified.
Ipv6AccessListName	<p>Specify the IPv6 access list name to verify the sender IPv6 address in the RA packets against the attached IPv6 access list.</p> <p>* Note:</p> <p>The source address in the RA packet is not validated if the access-list is not attached.</p> <p>If the list is attached and the IPv6 source address in RA packet does not match any IPv6-prefix in the list, then the RA packet is dropped. To change this behavior, add an entry in the IPv6 access list with prefix 0::0/0 with access type as allow. The default value changes from drop to allow.</p>
Ipv6PrefixListName	<p>Specify the IPv6 prefix list name to verify the advertised prefixes in the RA packet against the attached IPv6 prefix list.</p> <p>* Note:</p> <p>Advertised prefixes are not validated if the access-list is not attached.</p> <p>If the list is attached and the advertised prefix in the RA packet does not match any IPv6-prefix in the list, then the RA packet is dropped. To change this behavior, add an entry in the IPv6 access list with prefix 0::0/0 with access type as allow. The default value changes from drop to allow.</p>
MacListName	<p>Specify the MAC list name to verify the sender source MAC address against the attached MAC access list.</p> <p>* Note:</p> <p>The source MAC address in the RA packet is not validated if the access-list is not attached.</p> <p>If the list is attached and the source MAC address in the RA packet does not match any MAC address in the list, then the RA packet is dropped.</p>

Table continues...

Name	Description
ManagedConfigFlag	Select the managed configuration flag to verify managed address configuration in the advertised RA packet. By default, none is selected and managed configuration flag validation is skipped.
RouterPrefMax	Select the router preference maximum to verify the if the advertised default router preference parameter value is lower than or equal to a specified limit. By default, none is selected and router preference validation is skipped.
HopLimitMin	Specify the minimum hop limit to verify the advertised hop count limit. The value range is from 0 to 255 By default, minimum hop limit is 0.
HopLimitMax	Specify the maximum hop limit to verify the advertised hop count limit. The value range is from 0 to 255 By default, the maximum hop limit is 0 and If both HopLimitMin and HopLimitMax are set to 0, then the hop limit parameter in the RA packet is not validated.

Viewing RA-guard policy

About this task

Use this procedure to display configured RA-guard policies.

Procedure

1. In the navigation pane, expand the following folders: **Configuration > IPv6**.
2. Click **FHS**.
3. Click the **RA Guard Policy** tab.

RA Guard Policy field descriptions

Use the data in the following table to use the RA Guard Policy tab.

Name	Description
PolicyName	Specify the name of the RA-guard policy to be created or modified.
Ipv6AccessListName	Specify the IPv6 access list name to verify the sender IPv6 address in the RA packets against the attached IPv6 access list.

Table continues...

Name	Description
	<p>* Note:</p> <p>The source address in the RA packet is not validated if the access-list is not attached.</p> <p>If the list is attached and the IPv6 source address in RA packet does not match any IPv6-prefix in the list, then the RA packet is dropped. To change this behavior, add an entry in the IPv6 access list with prefix 0::0/0 with access type as allow. The default value changes from drop to allow.</p>
Ipv6PrefixListName	<p>Specify the IPv6 prefix list name to verify the advertised prefixes in the RA packet against the attached IPv6 prefix list.</p> <p>* Note:</p> <p>Advertised prefixes are not validated if the access-list is not attached.</p> <p>If the list is attached and the advertised prefix in the RA packet does not match any IPv6-prefix in the list, then the RA packet is dropped. To change this behavior, add an entry in the IPv6 access list with prefix 0::0/0 with access type as allow. The default value changes from drop to allow.</p>
MacListName	<p>Specify the MAC list name to verify the sender source MAC address against the attached MAC access list.</p> <p>* Note:</p> <p>The source MAC address in the RA packet is not validated if the access-list is not attached.</p> <p>If the list is attached and the source MAC address in the RA packet does not match any MAC address in the list, then the RA packet is dropped.</p>
ManagedConfigFlag	<p>Select the managed configuration flag to verify managed address configuration in the advertised RA packet.</p> <p>By default, none is selected and managed configuration flag validation is skipped.</p>
RouterPrefMax	<p>Select the router preference maximum to verify the if the advertised default router preference parameter value is lower than or equal to a specified limit.</p>

Table continues...

Name	Description
	By default, none is selected and router preference validation is skipped.
HopLimitMin	Specify the minimum hop limit to verify the advertised hop count limit. The value range is from 0 to 255 By default, minimum hop limit is 0.
HopLimitMax	Specify the maximum hop limit to verify the advertised hop count limit. The value range is from 0 to 255 By default, the maximum hop limit is 0 and If both HopLimitMin and HopLimitMax are set to 0, then the hop limit parameter in the RA packet is not validated.

Deleting a RA-guard policy

About this task

Use this procedure to delete the created RA-guard policy.

Note:

If this policy is already attached to an interface, then you cannot delete this policy.

Procedure

1. In the navigation pane, expand the following folders: **Configuration > IPv6**.
2. Click **FHS**.
3. Click the **RA Guard Policy** tab.
4. Select a row from RA Guard policies to delete.
5. Click **Delete**.

Port policy mapping configuration

This configuration allows you to map the port with DHCPv6-guard or RA-guard policy. You can view, create or delete the mappings.

Creating port to policy mapping

About this task

Use this procedure to map a port to a RA-guard or DHCPv6-guard policy, DHCPv6-guard or RA-guard statistics.

Procedure

1. In the navigation pane, expand the following folders: **Configuration > IPv6**.

2. Click **FHS**.
3. Click the **Port Policy Mapping** tab.
4. Click **Insert**.
5. Configure the parameters for the port policy mapping.
6. Click **Insert**.
7. **(Optional)** Click **Refresh** to update the results.

Port Policy Mapping field descriptions

Use the data in the following table to use the Insert Port Policy Mapping dialog box.

Name	Description
IfIndex	Specify the port.
DHCPv6GuardPolicyName	Enter an already-created DHCPv6-guard policy name to map it with the port.
RAGuardPolicyName	Enter an already-created RA-guard policy name to map it with the port.
Dhcpv6gDeviceRole	Select server or client configuration. The default is server.
RagDeviceRole	Select host or router configuration. The default is router.

Viewing port policy mapping

About this task

Use this procedure to display port policy mapping information.

Procedure

1. In the navigation pane, expand the following folders: **Configuration > IPv6**.
2. Click **FHS**.
3. Click the **Port Policy Mapping** tab.

Port Policy Mapping field descriptions

Use the data in the following table to use the Port Policy Mapping tab.

Name	Description
IfIndex	Identifies the port.
Dhcpv6gDeviceRole	Specifies the DHCPv6-guard device-role of the received port. If the device role is client and if it receives DHCPv6 reply then those packets should be dropped.

Table continues...

Name	Description
DHCPv6GuardPolicyName	Specifies the DHCPv6-guard policy name associated with the port.
TotalDHCPv6PktRcv	Shows the total number of DHCPv6 packets received on the DHCPv6-guard enabled interface.
TotalDHCPv6PktDropped	Shows the total number of DHCPv6 packets dropped due to DHCPv6-guard filtering.
RagDeviceRole	Specifies the RA-guard device-role.
RAGuardPolicyName	Specifies the RA-guard policy name associated with the port.
TotalRAPktRcv	Shows the total number of RA packets received on the RA-guard enabled interface.
TotalRAPktDropped	Shows the total number of RA packets dropped due to RA-guard filtering.
ClearDHCPGuardStats	Clears, if true, the DHCPv6-guard statistics for the port.
ClearRAGuardStats	Clears, if true, the RA-guard statistics for the port.
ClearNDInspectStats	Clears, if true, the ND-inspection statistics for the port.

Deleting port policy mapping

About this task

Use this procedure to delete the created port policy mapping.

Procedure

1. In the navigation pane, expand the following folders: **Configuration > IPv6**.
2. Click **FHS**.
3. Click the **Port Policy Mapping** tab.
4. Select a row from Port Policy Mapping to delete.
5. Click **Delete**.
6. Click **Apply**.

Configuring IPv6 DHCP snooping and ND inspection

This section describes how to configure IPv6 DHCP snooping and ND inspection on the switch and protect the network by mitigating the various types of attacks.

Configuring FHS Globals

About this task

Use this procedure to enable FHS to enable DHCPv6-guard, RA-guard, and ND-inspection globally, and to configure the lifetime for these policies.

Procedure

1. From the navigation pane, expand the following folders: **Configuration > IPv6**.
2. Click **FHS**.
3. Click the **Globals** tab.
4. Select FHS global options.
5. Click **Apply** to save the changes.
6. **(Optional)** Click **Refresh** to update the results.

Globals field descriptions

Use the data in the following table to use the Globals tab.

Name	Description
Admin	Enables or disables the FHS policy.
RAGuardAdmin	Enables or disables the RA-guard policy.
DHCPv6GuardAdmin	Enables or disables the DHCPv6-guard policy.
NdInspectAdmin	Enables or disables Neighbor Discovery inspection.

SBT configuration

This configuration allows you to build a snooping binding table (SBT) which contains entries from only trusted devices or hosts. This SBT table is used to validate Neighbor Discovery (ND) packets. You can view, create, or delete the entries in the SBT.

Creating an SBT entry

About this task

Use this procedure to create an SBT entry.

Procedure

1. In the navigation pane, expand the following folders: **Configuration > IPv6**.
2. Click **FHS**.
3. Click the **Snoop Binding** tab.
4. Click **Insert**.
5. Configure the parameters for the snoop binding.
6. Click **Insert**.
7. **(Optional)** Click **Refresh** to update the results.

Snoop Binding field descriptions

Use the data in the following table to use the Snoop Binding tab.

Name	Description
VlanId	Specify the VLAN to which the snooped entry belongs.
Ipv6Address	Enter the IPv6 address assigned to the IPv6 host.
MacAddress	Enter the MAC address of the snooped entry.
InterfaceIndex	Specify the interface on which the entry is learnt.
EntryType	Indicates the type of entry - static (1) or dynamic (2).
EntrySource	Indicates the method entry was learnt from - static (1) or dhcp (2).
ValidTime	Indicates the valid time for the snooped entry.
TimeToExpiry	Indicates the time to expiry of the snooped entry.

Viewing SBT entries**About this task**

Use this procedure to display a configured SBT table.

Procedure

1. In the navigation pane, expand the following folders: **Configuration > IPv6**.
2. Click **FHS**.
3. Click the **Snoop Binding** tab.

Snoop Binding field descriptions

Use the data in the following table to use the Snoop Binding tab.

Name	Description
VlanId	Specify the VLAN to which the snooped entry belongs.
Ipv6Address	Enter the IPv6 address assigned to the IPv6 host.
MacAddress	Enter the MAC address of the snooped entry.
InterfaceIndex	Specify the interface on which the entry is learnt.
EntryType	Indicates the type of entry - static (1) or dynamic (2).
EntrySource	Indicates the method entry was learnt from - static (1) or dhcp (2).
ValidTime	Indicates the valid time for the snooped entry.
TimeToExpiry	Indicates the time to expiry of the snooped entry.

Deleting an SBT entry

About this task

Use this procedure to delete an entry from the SBT table.

Procedure

1. In the navigation pane, expand the following folders: **Configuration > IPv6**.
2. Click **FHS**.
3. Click the **Snoop Binding** tab.
4. Select a row from the list to delete.
5. Click **Delete**.

First Hop Security example scenario

This section provides a configuration example for the overall deployment of the First Hop Security (FHS) feature.

FHS deployment scenario

In the following example, the Layer 2 switch “SW-1” is connected to another Layer 2 switch “SW-2”, two hosts and a DHCP server. Switch “SW-2” is connected to two other hosts and a router. Out of the two hosts connected to SW-2, one is a malicious host, which can generate bogus RA packets to advertise route prefix, and can also generate bogus DHCP reply packets to configure wrong IPv6 address or wrong default gateway. By doing this, it tries denial-of-service or Man-in-the-Middle attacks. These attacks must be prevented as it affects all the nodes present in the Layer 2 network and FHS can be effective in preventing these attacks.

These attacks can spread over the entire Layer 2 network and thus can affect the hosts connected to SW-2 as well as the hosts connected to SW-1. If you enable FHS only on SW-2, then it could only save the nodes which are directly connected to it. To prevent the good node connected to SW-1 from these attacks, the SW-1 switch also should be FHS enabled.

The following figure shows the FHS deployment scenario topology.

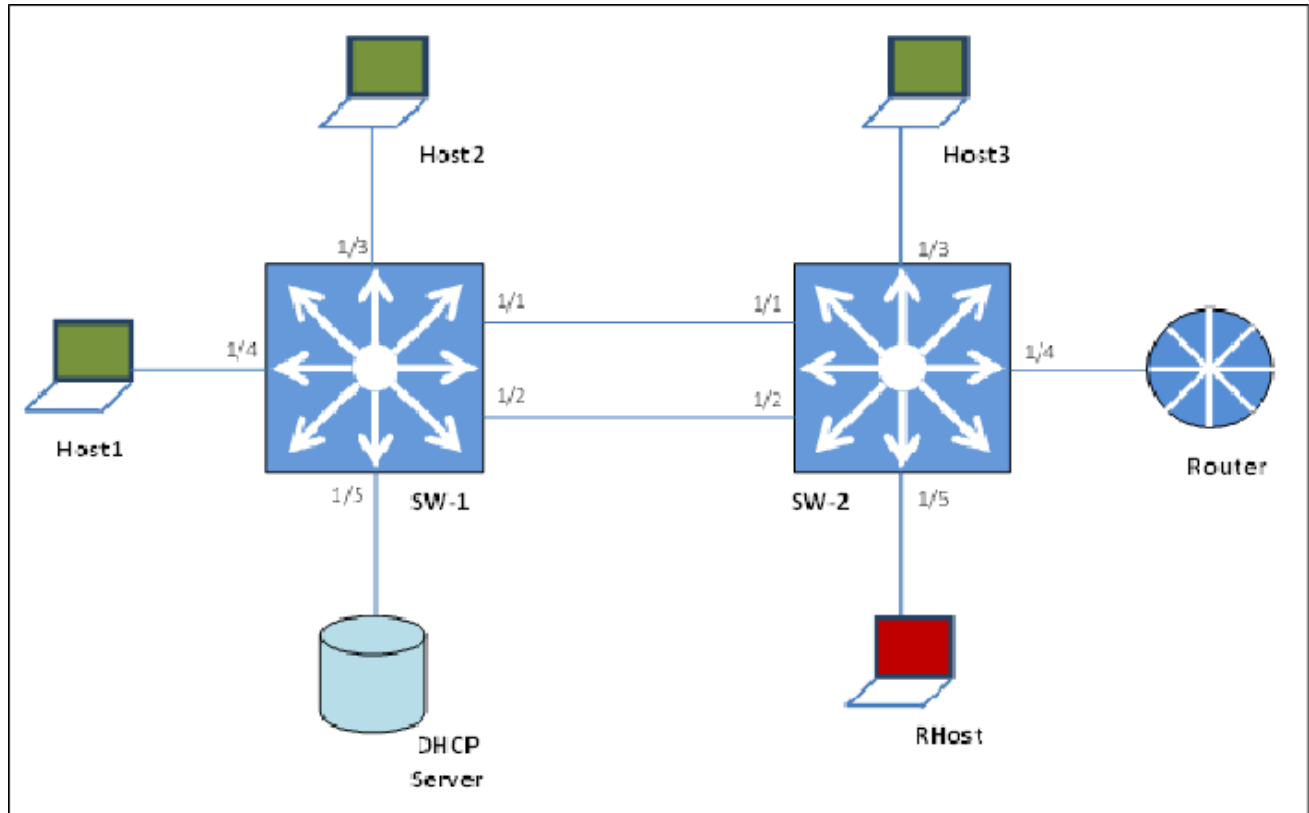

Figure 11: FHS deployment topology

By default, all the ports are trusted, until you configure DHCP-guard or RA-guard policies.

See the following procedures to configure FHS RA-guard and DHCPv6-guard for the preceding topology.

Creating FHS IPv6 ACL

About this task

Filter IPv6 traffic by creating IPv6 Access Control Lists (ACLs) and applying them to the interfaces similar to the way that you create and apply IPv4 named ACLs.

Procedure

1. Enter Global Configuration mode:

```
enable
```

```
configure terminal
```

2. Create an IP ACL name (ipv6_acl_1) to match the source IPv6 address of the router connected to the interface.

```
ipv6 fhs ipv6-access-list ipv6_acl_1  
fe80:0:0:0:cef9:54ff:feb4:9481/128 mode allow
```

3. Create an IP ACL name (ipv6_acl_1) to match the source IPv6 address of the DHCPv6-server connected to the interface.

```
ipv6 fhs ipv6-access-list ipv6_acl_1  
fe80:0:0:0:cef9:54ff:feb4:9481/128 mode allow
```

Next steps

Create a First Hop Security MAC ACL.

Creating an FHS MAC ACL

About this task

Filter the IPv6 traffic by creating a MAC access list with the ACL mode.

Procedure

1. Enter Global Configuration mode:

```
enable  
  
configure terminal
```

2. Create a MAC ACL name (rtr_smac) to match the source MAC of the router connected to the interface 1/2.

```
ipv6 fhs mac-access-list mac_acl_1 00:11:22:33:44:66 mode allow
```

Creating a DHCPv6-guard policy for the router

About this task

Create a DHCPv6-guard policy to provide Layer 2 security to DHCPv6 clients by protecting them against rogue DHCPv6 servers.

Procedure

1. Enter Global Configuration mode:

```
enable  
  
configure terminal
```

2. Enter DHCP Guard mode with the DHCP-guard policy name (dhcpv6g_pol_1). The DHCP-guard policy for the interface is connected to a router.

```
ipv6 fhs dhcp-guard policy dhcpv6g_pol_1
```

3. Configure the source IPv6 access list to allow only a DHCPv6 server replies that originate from the IPv6 address `fe80:0:0:0:cef9:54ff:feb4:9481/128` and check the preceding IPv6 ACL configuration for `ipv6_acl_1` list.

```
match server access-list ipv6_acl_1
```

4. Verify the prefixes sent in the DHCPv6 server reply message so that the `ipv6_acl_2` IPv6 ACL configuration allows only the prefix `1000::1/64`.

```
match reply prefix-list ipv6_acl_1
```

Creating an RA-guard policy for the router

About this task

Create an `rag_pol_1` RA-guard policy for the router and configure the source IPv6 access list to allow only the RA packets that originate from the source IPv6 address `fe80:0:0:0:cef9:54ff:feb4:9481/128`. This configuration verifies the prefixes sent in the RA packets.

Procedure

1. Enter Global Configuration mode:

```
enable
```

```
configure terminal
```

2. Enter the RA Guard mode and configure RA-guard policy (`rag_pol_1`) for the interface connected to a router.

```
ipv6 fhs ra-guard policy rag_pol_1
```

3. Configure the source IPv6 access list to allow only RA packets originating from the source IPv6 address `fe80:0:0:0:cef9:54ff:feb4:9481/128`.

```
match ipv6 ra-srcaddr-list ipv6_acl_1
```

4. Verify the prefixes sent in the RA packets so that the `rtr_pip` IPv6 ACL configuration allows only the prefix `60::0/64`.

```
match reply ra-prefix-list ipv6_acl_1
```

Attaching FHS policies to the interfaces

About this task

Attach the FHS policies to the interfaces.

Procedure

1. Enter Global Configuration mode:

```
enable
```

```
configure terminal
```

2. Configure DHCP-guard and RA-guard policies on the interface (1/2) that connects to the router.

```
interface ethernet 1/2  
ipv6 dhcp-guard attach-policy dhcpv6g_pol_1  
ipv6 ra-guard attach-policy rag_pol_1
```

IPv6 DHCP Snooping and ND Inspection configuration example

This section shows examples of IPv6 DHCP snooping and ND inspection configuration.

Enable DHCPv6 guard, ND inspection, and First Hop Security.

```
ipv6 fhs dhcp-guard enable  
ipv6 fhs nd-inspection enable  
ipv6 fhs enable
```

Create VLAN 1000 and add port members.

```
vlan create 1000 type port-mstprstp 0  
vlan members add 1000 1/1-1/10
```

Enable DHCPv6 snooping and ND inspection on VLAN 1000.

```
interface vlan 1000  
ipv6 fhs snooping dhcp enable  
ipv6 fhs nd-inspection enable  
exit
```

Add static SBT entry.

```
ipv6 fhs snooping static-binding ipv6-address 2001::0001:02ff:fe03:0405 vlan 1000 mac-  
address 00:01:02:03:04:05 port 1/5
```

Set the DHCPv6 guard device-role on port 1/1 of the device on which DHCP guard is configured.

```
interface gigabitEthernet 1/1  
ipv6 fhs dhcp-guard device-role server  
exit
```

Enable ND inspection on ports 1/2 through 1/10.

```
interface gigabitEthernet 1/2-1/10  
ipv6 fhs nd-inspection enable  
exit
```

View the status.

```
show ipv6 fhs port-policy  
show ipv6 fhs status  
show ipv6 fhs status vlan  
show ipv6 fhs snooping binding
```

Chapter 5: Extensible Authentication Protocol over LAN

The following sections describe Extensible Authentication Protocol over LAN (EAPoL) and its configuration.

EAPoL fundamentals

Extensible Authentication Protocol over LAN (EAPoL) is a port-based network access control protocol. EAPoL provides security by preventing users from accessing network resources before they are authenticated. The EAPoL authentication feature prevents users from accessing a network to assume a valid identity and access confidential material or launch denial-of-service attacks.

You can use EAPoL to set up network access control on internal LANs and to exchange authentication information between an end station or server that connects to a switch and an authentication server (such as a RADIUS server). This security feature extends the benefits of remote authentication to internal LAN clients. For example, if a new client PC fails the authentication process, EAPoL prevents the new client PC from accessing the network.

*** Note:**

The switch supports multiple host multiple authentication (MHMA). Multiple hosts/supplicants are supported on a single EAPoL enabled port.

EAPoL terminology

This section lists some components and terms used with EAPoL-based security.

- Supplicant—a device, such as a PC, that applies for access to the network.
- Authenticator—software on a switch that authorizes or rejects a Supplicant attached to the other end of a LAN segment.
 - Port Access Entity (PAE)—software that controls each port on the device. The PAE, which resides on the switch, supports the Authenticator functionality.
 - Controlled Port—any port on the device with EAPoL enabled.
- Authentication Server—a RADIUS server that provides AAA services to the authenticator.

EAPOL configuration

EAPoL configuration considerations

This section lists EAPoL configuration considerations.

- You must configure at least one EAPoL RADIUS server and shared secret fields.
- You cannot configure EAPoL on ports that are currently configured for the following:
 - Shared segments
 - MultiLink Trunking
- Change the authentication status to auto for each port that you want to control. The *auto* setting automatically authenticates the port according to the results of the RADIUS server. The default authentication setting for each port is *authorized*.
- When multiple clients are authenticated on the same port, the priority of the latest incoming client is applied on the port, and this priority is retained until all the clients log out on that port.

Configuration process

The Authenticator facilitates the authentication exchanges that occur between the Supplicant and the Authentication Server. The Authenticator PORT ACCESS ENTITY (PAE) encapsulates the EAPoL message into a RADIUS packet, and then sends the packet to the Authentication Server.

The Authenticator manages the access to controlled port. At system initialization, or when a Supplicant initially connects to one of the controlled ports on the device, the system blocks data traffic of the Supplicant until gets authenticated. After the Authentication Server notifies the Authenticator PAE about the success or failure of the authentication, the Authenticator decides whether to permit/deny the traffic of client on controlled port.

NonEAPoL frames transmit according to the following rules:

- If authentication succeeds, the client blocked from accessing is allowed to the controlled port, which means the system allows all the incoming and outgoing traffic from that client through the port.
- If authentication fails, client is blocked from accessing, which means both incoming and outgoing traffic is not allowed to client.

The following figure illustrates how the switch, configured with EAPoL, reacts to a new network connection.

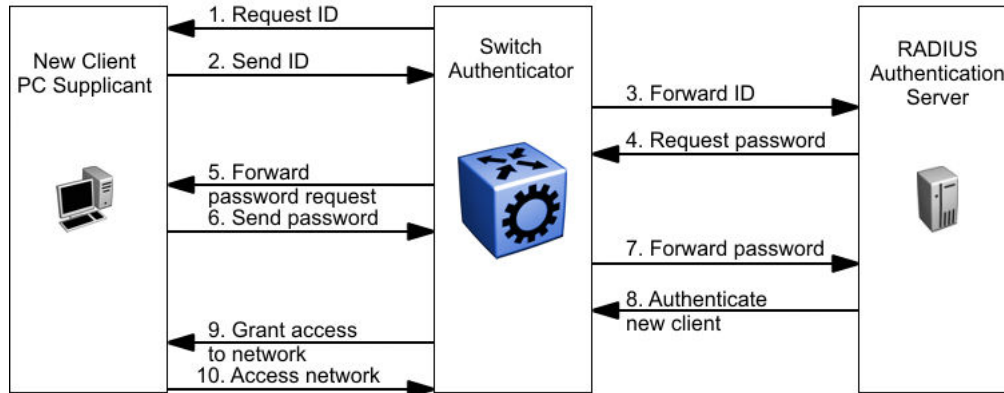

Figure 12: EAPoL configuration example

In the preceding figure, the switch uses the following steps to authenticate a new client:

1. The switch detects a new connection on one of its EAPoL-enabled ports and requests a user ID from the new client PC.
2. The new client sends its user ID to the switch.
3. The switch uses RADIUS to forward the user ID to the RADIUS server.
4. The RADIUS server responds with a request for the password of the user.
5. The switch forwards the request from the RADIUS server to the new client.
6. The new client sends an encrypted password to the switch, within the EAPoL packet.
7. The switch forwards the EAPoL packet to the RADIUS server.
8. The RADIUS server authenticates the password.
9. The switch grants the new client access to the network.
10. The new client accesses the network.

If the RADIUS server cannot authenticate the new client, it denies the new client access to the network.

The following figure shows the Ethernet frames and the corresponding codes for EAPoL as specified by 802.1x.

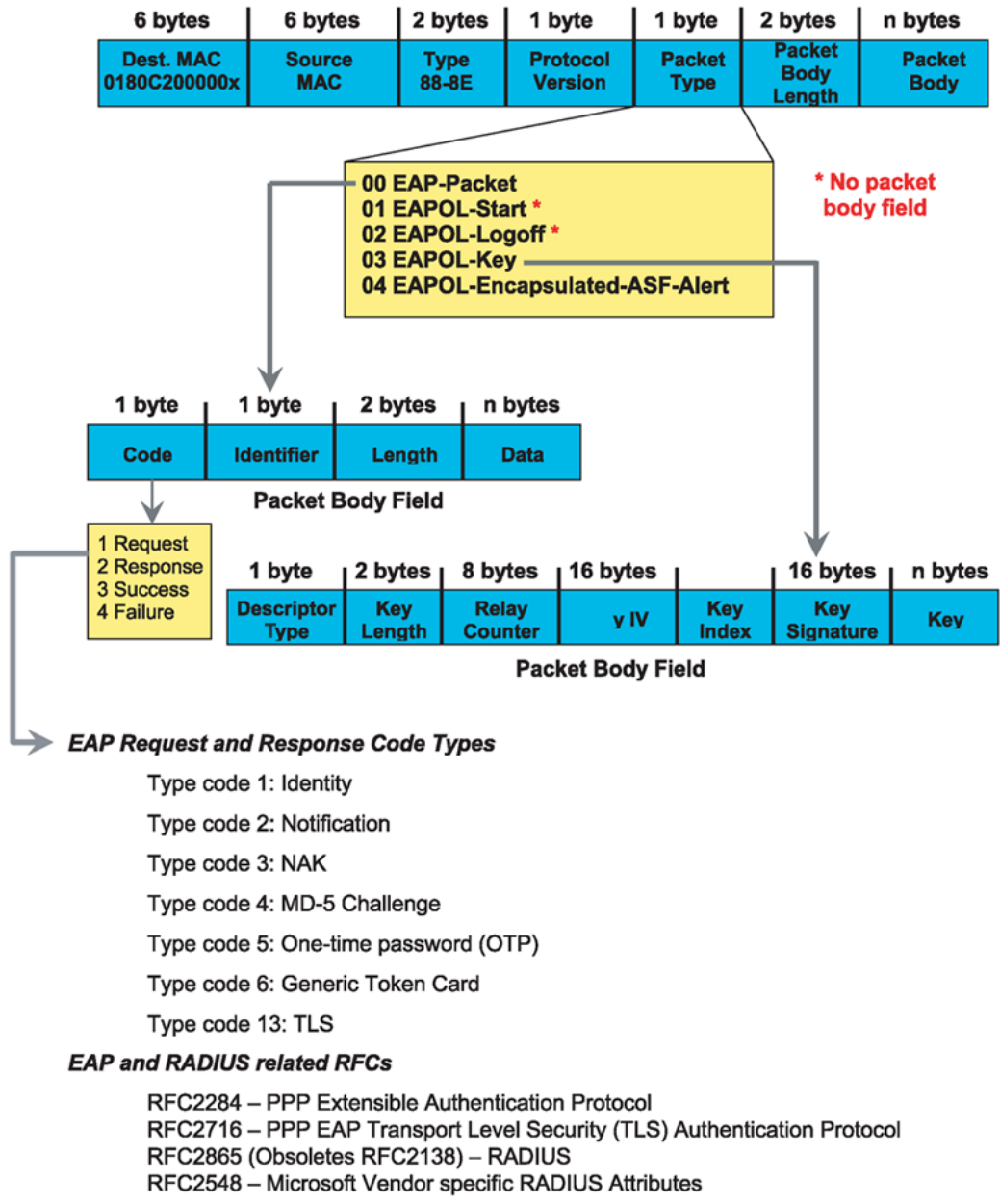

Figure 13: 802.1x Ethernet frame

The following figure shows the flow diagram for EAPoL on a switch.

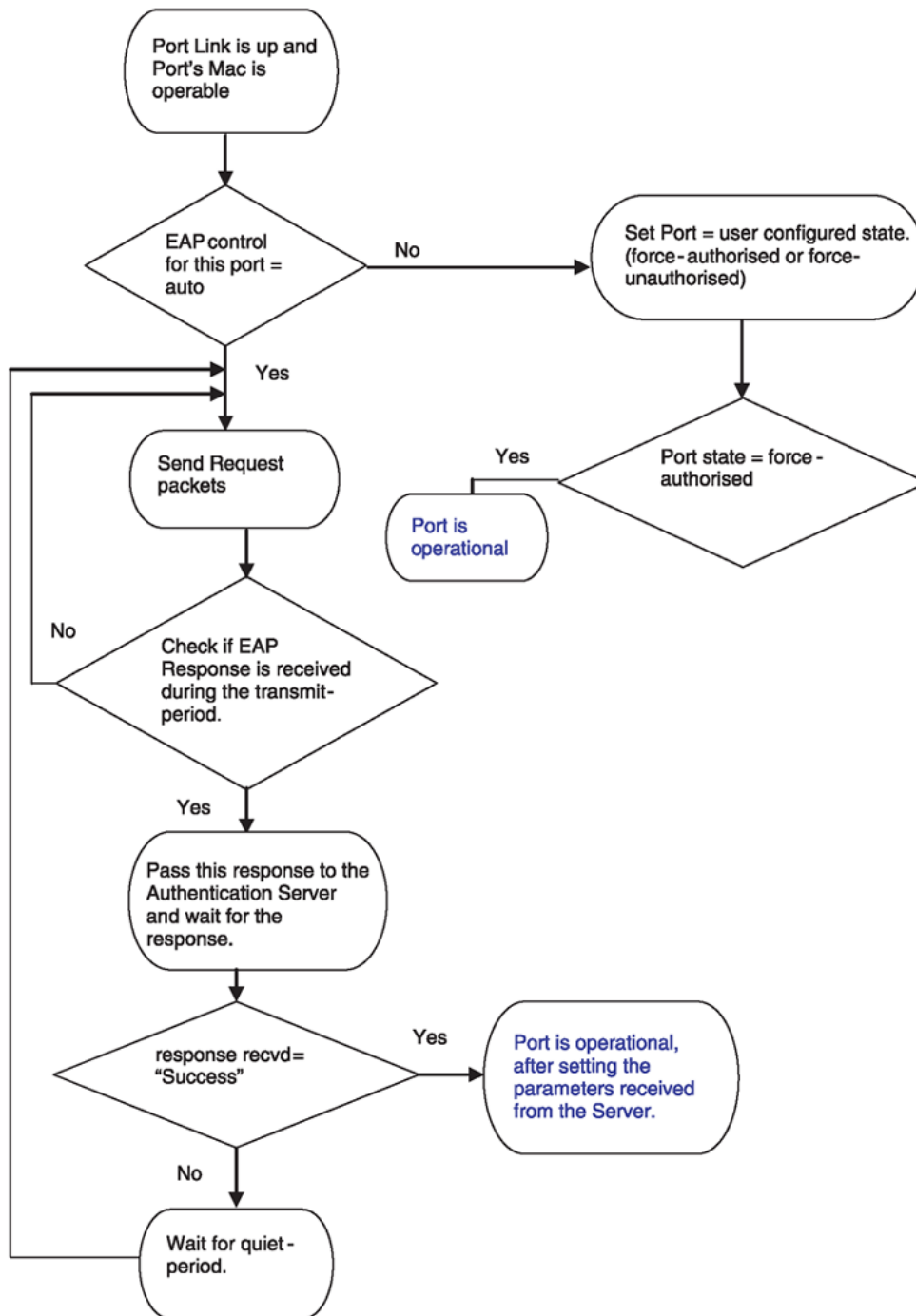

Figure 14: EAPoL flow diagram

EAPOL system requirements

The following are the minimum system requirements for EAPoL:

- RADIUS server
- Client software that supports EAPoL

You must specify the RADIUS server that supports EAP as the primary RADIUS server for the switch. You must configure your switch for VLANs and EAPoL security.

If you configure EAPoL on a port, the following limitations apply:

- You cannot enable EAPoL on ports that belong to an MLT group.
- You cannot enable tagging on EAPoL enabled ports.

*** Note:**

This includes Switched UNI ports because Switched UNI requires that the port be tagged.

- You cannot add EAPoL-enabled ports to an MLT group.
- You cannot configure EAPoL on MLT/LACP interfaces.
- You cannot add EAPoL-enabled ports to an MLT/LACP group.
- You cannot enable VLACP on EAPoL enabled ports.
- You cannot make VLAN changes on EAPoL enabled ports other than RADIUS VLAN assignment.
- You cannot enable MACsec on EAPoL enabled ports.
- You cannot enable EAPoL on NNI interfaces.
- You cannot egress mirror an EAPoL PDU.
- Do not use EAPoL with a brouter port.
- Ping to and from services between nodes over the NNI will work even when it contains only EAPoL enabled ports with no authenticated clients on it.
- MHMA-MV is not supported on untagged ports. Only MHMA-SV is supported on untagged ports.

EAPoL dynamic VLAN assignment

If you configure a RADIUS server to send a VLAN ID in the Access-Accept response, the EAPoL feature dynamically changes the VLAN configuration of the port by adding the port to the specified VLAN.

EAPoL dynamic VLAN assignment affects the following VLAN configuration values:

- Port membership
- Port priority

When you disable EAPoL on a port that was previously authorized, VLAN configuration values for that port are restored directly from the nonvolatile random access memory (NVRAM) of the device.

The following exception applies to dynamic VLAN assignments:

- The dynamic VLAN configuration values assigned by EAPoL are not stored in the switch NVRAM.

You can set up your Authentication Server (RADIUS server) for EAPoL dynamic VLAN assignments. You can use the Authentication Server to configure user-specific settings for VLAN memberships and port priority.

When you log on to a system that is configured for EAPoL authentication, the Authentication Server recognizes your user ID and notifies the device to assign preconfigured (user-specific) VLAN membership and port priorities to the device. The configuration settings are based on configuration parameters that were customized for your user ID and previously stored on the Authentication Server.

*** Note:**

Static entries like IGMP, ARP, FDB configured on a port of an VLAN interface, will not be retained if the port is assigned a same VLAN by the RADIUS server and the client authenticated on the port gets disconnected or unauthenticated.

Multiple Host with Multiple Authentication (MHMA)

For an EAP-enabled port configured for Multiple Host with Multiple Authentication (MHMA), a finite number of EAP users or devices with unique MAC addresses are allowed on the port.

Each user must complete EAP authentication before the port allows traffic from the corresponding MAC address. Only traffic from the authorized hosts is allowed on that port.

RADIUS-assigned VLAN values are allowed in the MHMA mode.

MHMA support is available for an EAP-enabled port.

The following are some of the concepts associated with MHMA:

- Logical and physical ports

Each unique port and MAC address combination is treated as a logical port. MAX_MAC defines the maximum number of MAC addresses that can perform EAP authentication on a port. Each logical port is treated as if it is in the SHSA mode.

- Indexing for MIBs

Logical ports are indexed by a port and source MAC address (src-mac) combination. Enterprise-specific MIBs are defined for state machine-related MIB information for individual MACs.

- Transmitting EAPOL packets

Only unicast packets are sent to a specific port so that the packets reach the correct destination.

- Receiving EAPOL packets

The EAPOL packets are directed to the correct logical port for state machine action.

- Traffic on an authorized port

Only a set of authorized MAC addresses is allowed access to a port.

MHMA support for EAP clients contains the following features:

- After the first successful authentication, only EAPoL packets and data from the authenticated MAC addresses are allowed on a particular port.
- Only a predefined number of authenticated MAC users are allowed on a port.
- RADIUS VLAN assignment is enabled for ports in MHMA mode. Upon successful RADIUS authentication, the port gets a VLAN value in a RADIUS attribute with EAP success. The port is added and the PVID is set to the first such VLAN value from the RADIUS server.
- Configuration of timer parameters is for each physical port, not for each user session. However, the timers are used by the individual sessions on the port.
- Reauthenticate causes all sessions on the port to re-authenticate when enabled.
- Re-authentication timers are used to determine when a MAC is disconnected so as to enable another MAC to log on to the port.
- Configuration settings are saved across resets.

MHMA operates on two modes:

- Multiple Host Multiple Authentication- Single VLAN (MHMA-SV)

In MHMA-SV mode, the port is untagged and only one VLAN can be assigned to the EAPoL enabled port. VLAN is configured by the administrator or dynamically assigned by the RADIUS server. The last assigned VLAN is applied on the port. EAP and Non-EAP operate in this mode.

- Multiple Host Multiple Authentication- Multiple VLAN (MHMA-MV)

In MHMA-MV mode, the port is tagged by the administrator. The Administrator can configure any number of VLANs on the port before enabling EAPoL on the port. All the authenticated EAP, Non-EAP hosts are allowed in the VLAN. After authentication when the RADIUS assigned VLANs are added to the port without removing any existing VLANs on the port.

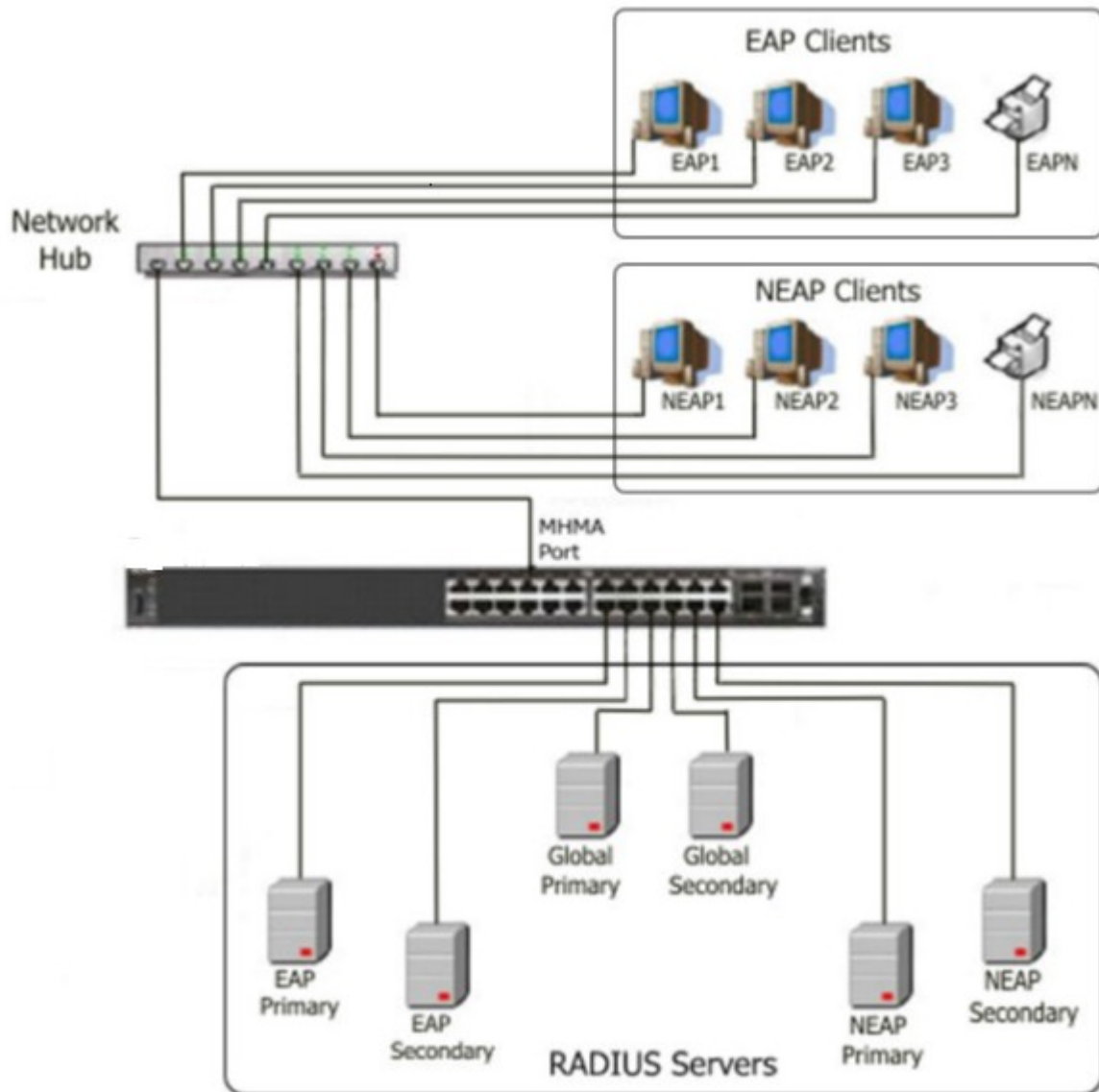

Figure 15: MHMA

Multiple Host Multiple VLAN (MHMV):

With the MHMV feature, you can assign multiple authenticated devices to different VLANs on the same EAP-enabled port using device MAC addresses. Using RADIUS VLAN attributes, different clients can access different VLANs. This separates traffic for different MAC clients.

*** Note:**

MHMV is supported only on EAP-enabled ports which has MAX_MAC configured more than one and tagging configured.

VLAN Assignment in MHMA-SV mode

- EAPoL enabled port should be untagged.
- MHMA authenticated hosts are added to the port-based VLAN by default.
- You can configure VLAN on the port by sending VLAN information in RADIUS Access-Accept packet after successful authentication (Dynamic VLAN support). The last successful authenticated host VLAN information is configured on the port. This is called RADIUS assigned VLANs in MHMA-SV mode.
- Only one VLAN can exist on the port.
- When the RADIUS server dynamically assigns a new VLAN, the existing VLAN is deleted. The port is configured with the new VLAN.
- The last assigned VLAN by the RADIUS server is maintained on the port until all authenticated clients are disconnected.

VLAN Assignment in MHMA-MV mode

- EAPoL enabled port should be tagged.
- Before enabling EAPoL, you can configure any number of VLAN on the port.
- Authenticated MAC clients are allowed in the network. If the data traffic is untagged, then it is forwarded to the port default VLAN.
- If the data traffic is tagged and if VLAN is configured on the port, then the traffic is forwarded to the VLAN associated with the tag.
- If the data traffic is tagged and the VLAN in the tag is not configured on the port, then the traffic is dropped.
- If Radius assigns VLAN to the authenticated MAC client, then the VLAN is added to the port without deleting the existing VLANs on the port.
- IN MHMA-MV mode, MAC-Based VLANs are used to support traffic separation between different authenticated MAC clients.
- MAC based VLAN traffic separation applies only to Untagged traffic.

Traffic forwarding on EAPoL enabled port

The following table summarizes how tagged and untagged traffic is forwarded on EAPoL enabled port after successful authentication.

Port-tagging	Untagged (MHMA-SV)	Untagged	Untagged	Tagged	Tagged	Tagged
EAPoL client authentication or	Authenticated	Authenticated RAV assigned	Authentication failure	Authenticated No RAV assigned	Authenticated RAV assigned	Authentication failure

Table continues...

Port-tagging	Untagged (MHMA-SV)	Untagged	Untagged	Tagged	Tagged	Tagged
authorization status	No RAV assigned					
Ingress untagged traffic	Classified into port default VLAN	Classified into RAV	Drop	Classified into port default VLAN	Classified into RAV	Drop
Ingress tagged with RAV	Drop	Drop	Drop	If configured, then classified into the TAG on the packet	Classified into RAV	Drop
Ingress tagged (not RAV), VLAN not configured on the port	Drop	Drop	Drop	Drop	Drop	Drop
Ingress tagged (not RAV), VLAN configured on the port	Drop	Drop	Drop	Classified into TAG VLAN since VLAN is configured on the port	Classified into TAG VLAN since VLAN is configured on the port	Drop
Egress traffic (RAV or configured VLANs on port)	Untagged traffic sent out of port	Untagged traffic sent out of port	Drop till the first MAC client is authenticated	Untagged traffic sent out of port	Untagged traffic sent out of port	Drop till the first MAC client is authenticated

RADIUS-assigned VLAN

RADIUS-assigned VLAN use in MHMA mode

RADIUS-assigned VLAN use in the MHMA mode gives you greater flexibility and a more centralized assignment. This allows the RADIUS server to dynamically assign VLANs to a port.

If different VLAN is not configured for each supplicant on the RADIUS server, all the supplicants will be assigned to the same VLAN assigned by the RADIUS server.

RADIUS return attributes supported for EAPoL

The switch uses the RADIUS tunnel attributes to place a port into a particular VLAN to support dynamic VLAN switching based on authentication.

The RADIUS server indicates the desired VLAN by including the tunnel attribute within the Access-Accept message. RADIUS uses the following tunnel attributes:

- Tunnel-Type = VLAN (13)
- Tunnel-Medium-Type = 802
- Tunnel-Private-Group-ID = VLAN ID

The VLAN ID is 12 bits, uses a value from <1-4059>, and is encoded as a string.

In addition, you can set up the RADIUS server to send a vendor-specific attribute to configure port priority. You can assign the switch Supplicant port a QoS value from 0 to 6.

The following figure shows the RADIUS vendor-specific frame format.

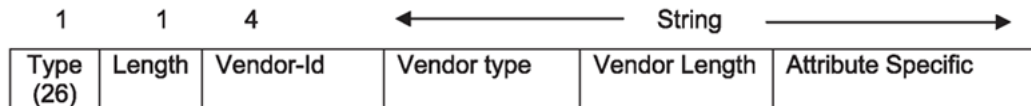

Figure 16: RADIUS vendor-specific frame format

The following list provides the switch Port Priority frame format:

- vendor specific type = 26
- length = 12
- vendor-id = 1584
- string = vendor type = 1 + vendor length = 6 + attribute specific = priority

The following figure shows the port priority frame format.



Figure 17: Port priority frame format

RADIUS configuration prerequisites for EAPoL

Connect the RADIUS server to a force-authorized port. This ensures that the port is always available and not tied to whether or not the device is EAPoL-enabled. To set up the Authentication Server, set the following Return List attributes for all user configurations (for more information, see your Authentication Server documentation):

- VLAN membership attributes
 - Tunnel-Type: value 13, Tunnel-Type-VLAN
 - Tunnel-Medium-Type: value 6, Tunnel-Medium-Type-802
 - Tunnel-Private-Group-ID: ASCII value 1 to 4059 (this value identifies the specified VLAN)

- Port priority (vendor-specific) attributes
 - Vendor ID: value 1584, Bay Networks Vendor ID
 - Attribute Number: value 1, Port Priority
 - Attribute Value: value 0 (zero) to 6 (this value indicates the port priority value assigned to the specified user)

! Important:

You need to configure these attributes only if you require Dynamic VLAN membership or Dynamic Port priority.

RADIUS accounting for EAPoL

The switch provides the ability to account EAPoL sessions using the RADIUS accounting protocol. A user session is defined as the interval between the instance at which a user is successfully authenticated (port moves to authorized state) and the instance at which the port moves out of the authorized state.

The following table summarizes the accounting events and information logged.

Table 5: Summary of accounting events and information logged

Event	Radius attributes	Description
User is authenticated by EAPoL	Acct-Status-Type	Start
	Nas-IP-Address	IP address to represent the switch
	Nas-Port	Port number on which the user is EAPoL authorized
	Acct-Session-ID	Unique string representing the session
	User-Name	EAPoL user name
User logs off	Acct-Status-Type	Stop
	Nas-IP-Address	IP address to represent the switch
	Nas-Port	Port number on which the user is EAPoL unauthorized
	Acct-Session-ID	Unique string representing the session
	User-Name	EAPoL user name
	Acct-Input-Octets	Number of octets input to the port during the session
	Acct-Output-Octets	Number of octets output to the port during the session
	Acct-Terminate-Cause	Reason for terminating user session. For more information about the mapping of 802.1x session termination cause to RADIUS

Table continues...

Event	Radius attributes	Description
		accounting attribute, see the following table.
	Acct-Session-Time	Session interval

The following table describes the mapping of the causes of 802.1x session terminations to the corresponding RADIUS accounting attributes.

Table 6: 802.1x session termination mapping

IEEE 802.1Xdot1xAuthSessionTerminateCause Value	RADIUSAcct-Terminate-Cause Value
supplicantLogoff(1)	User Request (1)
portFailure(2)	Lost Carrier (2)
supplicantRestart(3)	Supplicant Restart (19)
reauthFailed(4)	Reauthentication Failure (20)
authControlForceUnauth(5)	Admin Reset (6)
portReInit(6)	Port Reinitialized (21)
portAdminDisabled(7)	Port Administratively Disabled (22)
notTerminatedYet(999)	—

Non-EAP host

Non-EAP hosts on EAP-enabled ports

For an EAPOL-enabled port configured for non-EAPOL host support, devices with MAC addresses getting authenticated are allowed access to the port.

The switch allows the following types of non-EAPOL users:

- Non-EAPOL hosts whose MAC addresses are authenticated by RADIUS.

Support for non-EAPOL hosts on EAPOL-enabled ports is primarily intended to accommodate printers and other passive devices sharing a hub with EAPOL clients.

Support for non-EAPOL hosts on EAPOL-enabled ports includes the following features:

- Authenticated non-EAPOL clients are hosts that satisfy one of the following criteria:
 - Host MAC address is authenticated by RADIUS.
- Non-EAPOL hosts are allowed even if no authenticated EAPOL hosts exist on the port.
- When a new host is seen on the port, non-EAPOL authentication is performed as follows:
 - The switch generates a <username, password> pair, which it forwards to the network RADIUS server for authentication.

Non-EAPOL MAC RADIUS authentication

For RADIUS authentication of a non-EAPOL host MAC address, the switch generates a <username, password> pair as follows:

- The username is the non-EAPOL MAC address in string format.
- The password is a string that combines the switch IP address, MAC address, port number and user-configurable key string. If padding option is enabled, the system will specify a dot(.) for every missing parameter. IP address is represented by three decimal characters per octet.

! Important:

Follow these Global Configuration examples to select a password format that combines one or more of these three elements:

- Padding enabled , password = 010010011253..05. (when the switch IP address and port are used).
- Padding enabled, password = 010010011253... (when only the switch IP address is used).
- No padding (default option). Password = 000011220001 (when only the user's MAC address is used).

The following example illustrates the <username, password> pair format with no padding enabled and using the IP address, MAC address, and key-string as the password.

```
switch IP address = 10.10.11.253
non-EAP host MAC address = 00 C0 C1 C2 C3 C4
port = 25
Key-String = abcdef
```

- username = 00C0C1C2C3C4
- password = 010010011253.00C0C1C2C3C4.25.abcdef

Use the command **show eapol system** to verify the formatting.

```
Switch:1(config)#show eapol system
```

```
=====
                        Eapol System
=====
                        eap : enabled
non-eap-pwd-fmt       : ip-addr.mac-address.abcdef
non-eap-pwd-fmt key  : abcdef
non-eap-pwd-fmt padding : disabled
```

Non-EAP client

Non-EAP client re-authentication

The Non-EAP (NEAP) client re-authentication feature supports the re-authentication of non-EAP clients at defined intervals.

When you enable NEAP client re-authentication, an authenticated NEAP client is only removed from the authenticated client list if you remove the client account from the RADIUS server, or if you clear the NEAP authenticated client from the switch.

If an authenticated NEAP client does not generate traffic on the network, the system removes the MAC address for that client from the MAC address table when MAC ages out. Although the client MAC address does not appear in the MAC Address table, the client can appear as an authenticated client.

If you enable NEAP client re-authentication and the RADIUS server that the switch connects to becomes unavailable, the system clears all authenticated NEAP and removes those clients from the switch NEAP client list.

You cannot authenticate one NEAP client on more than one switch port simultaneously. If you connect NEAP clients to a switch port through a hub, those clients are authenticated on that switch port. If you disconnect a NEAP client from the hub and connect it directly to another switch port, the client is authenticated on the new port and its authentication is removed from the port to which the hub is connected.

MAC move for authenticated Non-EAP clients

When you move a Non-EAP client that is authenticated on a specific port, to another port on which EAPoL or Non-EAP is enabled, MAC move of the client to the new port does not automatically happen. This is as designed.

As a workaround, do *one* of the following:

- Clear the non-EAP session on the port that the client is first authenticated on, before you move the client to another port.
- Create a VLAN on the switch with the same VLAN ID as that dynamically assigned by the RADIUS server during client authentication. Use the command `vlan create <2-4059> type port-mstprstp <0-63>`. Ensure that the new port is a member of this VLAN.

EAPoL configuration using CLI

EAPoL uses RADIUS protocol for EAPoL-authorized logons. RADIUS supports IPv4 and IPv6 addresses, with no difference in functionality or configuration.

Before configuring your device, you must configure at least one EAPoL RADIUS server and shared secret fields.

You cannot configure EAPoL on ports that are currently configured for:

- Shared segments
- MultiLink Trunking (MLT)

Change the status of each port that you want to be controlled to auto. The auto setting automatically authenticates the port according to the results of the RADIUS server. The default authentication setting for each port is authorized.

You can connect only a single client on each port configured for EAPoL. If you attempt to add additional clients on the EAPoL authorized port, then the system denies access to the new client and displays a warning message.

Globally enabling EAPoL on the device

Enable EAPoL globally on the switch before you enable it on a port or interface.

Procedure

1. Enter Global Configuration mode:

```
enable
configure terminal
```

2. Globally configure EAPoL:

```
eapol enable
```

Example

```
Switch:1> enable
Switch:1# configure terminal
Switch:1(config)# eapol enable
```

Configuring EAPoL on an interface

Configure EAPoL on an interface.

Before you begin

- EAPoL must be globally enabled.

About this task

When you configure a port with the EAP status of auto (Authorization depends on result of EAP authentication), only one supplicant is allowed on this port. Multiple EAP supplicants are not allowed on the same physical switch port.

Procedure

1. Enter GigabitEthernet Interface Configuration mode:

```
enable
configure terminal
interface GigabitEthernet {slot/port[/sub-port] [-slot/port[/sub-
port]][, ...]}
```

Note:

If your platform supports channelization and the port is channelized, you must also specify the sub-port in the format slot/port/sub-port.

2. Enable EAPoL on an interface:

```
eapol status {authorized|auto}
```

3. Disable EAPoL on on interface:

```
no eapol status
```

Example

Enable EAPoL on an interface:

```
Switch:1>enable
Switch:1#configure terminal
Switch:1(config)#interface GigabitEthernet 1/2
Switch:1(config-if)# eapol status auto
```

Disable EAPoL on an interface:

```
Switch:1>enable
Switch:1#configure terminal
Switch:1(config)#interface GigabitEthernet 1/2
Switch:1(config-if)# no eapol status
```

Variable definitions

Use the data in the following table to use the `eapol status` command.

Variable	Value
authorized	Specifies that the port is always authorized. The default value is authorized.
auto	Specifies that port authorization depends on the results of the EAPoL authentication by the RADIUS server. The default value is authorized.

Configuring EAPoL on a port

Configure EAPoL on a specific port when you do not want to apply EAPoL to all of the switch ports.

Procedure

1. Enter GigabitEthernet Interface Configuration mode:

```
enable

configure terminal

interface GigabitEthernet {slot/port[/sub-port] [-slot/port[/sub-port]] [, ...]}
```

*** Note:**

If your platform supports channelization and the port is channelized, you must also specify the sub-port in the format slot/port/sub-port.

2. Configure the maximum EAP requests sent to the supplicant before timing out the session:

```
eapol port {slot/port[/sub-port] [-slot/port[/sub-port]] [, ...]} max-request <1-10>
```

3. Configure the time interval between authentication failure and the start of a new authentication:

```
eapol port {slot/port[/sub-port] [-slot/port[/sub-port]] [, ...]}
quiet-interval <1-65535>
```

4. Enable reauthentication:

```
eapol port {slot/port[/sub-port] [-slot/port[/sub-port]] [, ...]} re-
authentication enable
```

5. Configure the time interval between successive authentications:

```
eapol port {slot/port[/sub-port] [-slot/port[/sub-port]] [, ...]} re-
authentication-period <1-65535>
```

*** Note:**

The EAPoL re-authentication period value is between 1-65535. Older release supports up to 2147483647. To maintain backward compatibility the CLI value is between 1–2147483647. Trying to configure above 65535 results in an error.

6. Configure the EAP authentication status:

```
eapol port {slot/port[/sub-port] [-slot/port[/sub-port]] [, ...]}
status {authorized|auto}
```

Example

Configure the maximum EAP requests sent to the supplicant before timing out the session:

*** Note:**

Slot and port information can differ depending on hardware platform. See your hardware documentation for specific hardware information.

```
Switch:1>enable
Switch:1#configure terminal
Switch:1(config)#interface GigabitEthernet 1/2
Switch:1(config-if)#eapol max-request 10
Switch:1(config-if)#eapol port 1/2 quiet-interval 500
```

Variable definitions

Use the data in the following table to use the `eapol port` command.

Variable	Value
{slot/port[/sub-port] [-slot/port[/sub-port]] [, ...]}	Specifies the port or list of ports used by EAPoL. Identifies the slot and port in one of the following formats: a single slot and port (slot/port), a range of slots and ports (slot/port-slot/port), or a series of slots and ports (slot/port,slot/port,slot/port). If your platform supports channelization and the port is channelized, you must also specify the sub-port in the format slot/port/sub-port.

Table continues...

Variable	Value
max-request <1-10>	Specifies the maximum EAP requests sent to the supplicant before timing out the session. The default is 2.
quiet-interval <1-65535>	Specifies the time interval in seconds between the authentication failure and start of a new authentication. The default is 60.
re-authentication enable	Enables reauthentication of an existing supplicant at a specified time interval.
re-authentication-period <1-65535>	Specifies the time interval in seconds between successive reauthentications. The default is 3600 (1 hour).  Note: The EAPoL re-authentication period value is between 1–65535. Older release supports up to 2147483647. To maintain backward compatibility the CLI value is between 1–2147483647. Trying to configure above 65535 results in an error.
status {authorized auto}	Specifies the desired EAP authentication status for this port.

Configuring an EAPoL-enabled RADIUS server

The switch uses RADIUS servers for authentication and accounting services. Use the no form to delete a RADIUS server.

Before you begin

- You must enable EAPoL globally.

About this task

The RADIUS server uses the secret key to validate users.

RADIUS supports IPv4 and IPv6 addresses, with no difference in functionality or configuration.

Procedure

- Enter Global Configuration mode:

```
enable
configure terminal
```

- Add an EAPoL-enabled RADIUS server:

```
radius server host WORD <0-46> used-by eapol acct-enable
radius server host WORD <0-46> used-by eapol acct-port <1-65536>
radius server host WORD <0-46> used-by eapol enable
radius server host WORD <0-46> used-by eapol key WORD<0-20>
radius server host WORD <0-46> used-by eapol port <1-65536>
```

```
radius server host WORD <0-46> used-by eapol priority <1-10>
radius server host WORD <0-46> used-by eapol retry <0-6>
radius server host WORD <0-46> used-by eapol source-ip WORD <0-46>
radius server host WORD <0-46> used-by eapol timeout <1-20>
```

By default, the switch uses RADIUS UDP port 1812 for authentication, and port 1813 for accounting. You can change the port numbers or other RADIUS server options.

Example

```
Switch:1> enable
```

```
Switch:1# configure terminal
```

Add an EAPoL RADIUS server:

```
Switch:1(config)# radius server host fe80:0:0:0:21b:4fff:fe5e:73fd key
radiustest used-by eapol
```

Variable definitions

Use the data in the following table to configure an EAPoL-enabled RADIUS server with the **radius server host** command.

Variable	Value
host <i>WORD</i> <0-46>	Specifies the IP address of the selected server. RADIUS supports IPv4 and IPv6 addresses, with no difference in functionality or configuration.
<i>WORD</i> <0-20>	Specifies the secret key, which is a string of up to 20 characters.

Use the data in the following table to use optional arguments of the **radius server host** command.

Variable	Value
port <1-65535>	Specifies the port ID number.
priority <1-10>	Specifies the priority number. The lowest number is the highest priority.
retry <0-6>	Specifies the retry count of the account.
timeout <1-10>	Specifies the timeout of the server. The default is 30.
enable	Enables the functions used by the RADIUS server host.
acct-port <1-65536>	Specifies the port account.
acct-enable	Enables the account.
source-ip <i>WORD</i> <0-46>	Specifies the IP source. RADIUS supports IPv4 and IPv6 addresses, with no difference in functionality or configuration.

Configuring the switch for EAPoL and RADIUS

Perform the following procedure to configure the switch for EAPoL and RADIUS.

About this task

You must configure the switch, through which user-based-policy (UBP) users connect to communicate with the RADIUS server to exchange EAPoL authentication information, as well as user role information. You must specify the IP address of the RADIUS server, as well as the shared secret (a password that authenticates the device with the RADIUS server as an EAPoL access point). You must enable EAPoL globally on each device, and you must configure EAPoL authentication on each device port, through which EAPoL/UBP users connect.

RADIUS supports IPv4 and IPv6 addresses, with no difference in functionality or configuration.

For more information about EPM and UBP, see the user documentation for your Enterprise Policy Manager (EPM) application.

Procedure

1. Enter Global Configuration mode:

```
enable
configure terminal
```

2. Create a RADIUS server that is used by EAPoL:

```
radius server host WORD <0-46> key WORD<0-20> used-by eapol
```

3. Log on to the Interface Configuration mode:

```
interface vlan <1-4059>
```

4. Enable the device to communicate through EAPoL:

```
eapol enable
```

5. Exit from VLAN interface mode:

```
exit
```

6. Enter Interface Configuration mode:

```
interface GigabitEthernet {slot/port[/sub-port] [-slot/port[/sub-
port]][,...]}
```

7. Enable device ports for EAPoL authentication:

```
eapol port {slot/port[/sub-port] [-slot/port[/sub-port]][,...]}
status auto
```

8. Enable periodic supplicant re-authenticating:

```
eapol port {slot/port[/sub-port] [-slot/port[/sub-port]][,...]} re-
authentication enable
```

9. Save your changes:

```
save config
```

Example

```
Switch:1> enable
```

```
Switch:1# configure terminal
```

Create a RADIUS server that is used by EAPoL:

```
Switch:1(config)# radius server host fe90:0:0:0:21b:4eee:fe5e:75fd key
radiustest used-by eapol
```

```
Switch:1(config)# interface vlan 2
```

Enable the device to communicate through EAPoL:

```
Switch:1(config-if)# eapol enable
```

Save your changes:

```
Switch:1(config-if)# save config
```

Variable definitions

Use the data in the following table to use the `radius server host WORD<0-46> usedby eapol` command.

Variable	Value
host <i>WORD<0-46></i>	Specifies the IP address of the selected server. This address tells the device where to find the RADIUS server, from which it obtains EAPoL authentication and user role information. RADIUS supports IPv4 and IPv6 addresses, with no difference in functionality or configuration.
key <i>WORD<0-20></i>	Specifies the shared secret key that you use for RADIUS authentication. The shared secret is held in common by the RADIUS server and all EAPoL-enabled devices in your network. It authenticates each device with the RADIUS server as an EAPoL access point. When you configure your RADIUS server, you must configure the same shared secret value as you specify here.

Changing the authentication status of a port

The switch authorizes ports by default, which means that the ports are always authorized and are not authenticated by the RADIUS server.

You can also make the ports controlled so that they are dependent on being authorized by the Radius Server when you globally enable EAPoL (auto).

Procedure

1. Enter GigabitEthernet Interface Configuration mode:

```
enable

configure terminal

interface GigabitEthernet {slot/port[/sub-port] [-slot/port[/sub-
port]] [,...]}
```

*** Note:**

If your platform supports channelization and the port is channelized, you must also specify the sub-port in the format slot/port/sub-port.

2. Configure the authorization status of a port:

```
eapol status {authorized|auto}
```

Example

```
Switch:1> enable
Switch:1# configure terminal
Switch:1(config)# interface GigabitEthernet 3/1
Configure the authorization status of a port:
Switch:1(config-if)# eapol status auto
```

Variable definitions

Use the data in the following table to use the **eapol status** command.

Variable	Value
authorized	Specifies that the port is always authorized. The default value is authorized.
auto	Specifies that port authorization depends on the results of the EAPoL authentication by the RADIUS server. The default value is authorized.

Deleting an EAPoL-enabled RADIUS server

Delete an EAPoL-enabled RADIUS server if you want to remove the server.

About this task

RADIUS supports IPv4 and IPv6 addresses, with no difference in functionality or configuration.

Procedure

1. Enter Global Configuration mode:

```
enable
configure terminal
```
2. Delete an EAPoL-enabled RADIUS server:

```
no radius server host WORD<0-46> used-by eapol
```

Example

```
Switch:1> enable
```

```
Switch:1# configure terminal
```

```
Switch:1(config)# no radius server host fe79:0:0:0:21d:4fdf:fe5e:73fd
used-by eapol
```

Variable definitions

Use the data in the following table to use the **radius server host WORD<0-46> usedby eapol** command.

Variable	Value
host WORD<0-46>	<p>Specifies the IP address of the selected server.</p> <p>This address tells the device where to find the RADIUS server, from which it obtains EAPoL authentication and user role information.</p> <p>RADIUS supports IPv4 and IPv6 addresses, with no difference in functionality or configuration.</p>
key WORD<0-20>	<p>Specifies the shared secret key that you use for RADIUS authentication. The shared secret is held in common by the RADIUS server and all EAPoL-enabled devices in your network. It authenticates each device with the RADIUS server as an EAPoL access point. When you configure your RADIUS server, you must configure the same shared secret value as you specify here.</p>

Displaying the current EAPoL-based security status

Use the following procedure to display the status of the EAPoL-based security.

Procedure

1. Enter Privileged EXEC mode:

```
enable
```

2. Display the current EAPoL-based security status:

```
show eapol auth-stats interface [gigabitEthernet {slot/port[/sub-
port]} [-slot/port[/sub-port]] [,...]]
```

```
show eapol multihost non-eap-mac status [vlan <1-4059>] [{slot/
port[/sub-port]} [-slot/port[/sub-port]] [,...]]
```

```
show eapol port {interface [gigabitEthernet {slot/port[/sub-port]} [-
slot/port[/sub-port]] [,...]] | {slot/port[/sub-port]} [-slot/port[/
sub-port]] [,...]]
```

```
show eapol session-stats interface [gigabitEthernet {slot/port[/sub-
port]} [-slot/port[/sub-port]] [,...]]

show eapol status interface [vlan <1-4059>] [gigabitEthernet {slot/
port[/sub-port]} [-slot/port[/sub-port]] [,...]]

show eapol system
```

Example

```
Switch:#enable
Switch:1#show eapol system
=====
                        Eapol System
=====
                        eap : disabled
                        Eapol Version : 3
                        non-eap-pwd-fmt : ip-addr.mac-addr.port-number
                        non-eap-pwd-fmt key :
                        non-eap-pwd-fmt padding : disabled
=====
```

Variable definitions

Use the data in the following table to use the **show eapol** command.

Variable	Value
auth-stats [gigabitEthernet {slot/port[/sub-port]} [-slot/port[/sub-port]] [,...]]	Displays the authentication statistics interface. * Note: auth-stats [gigabitEthernet {slot/port[/sub-port]} [-slot/port[/sub-port]] [,...]] is useful only for EAP supplicants. The command output changes only when the EAP supplicant tries to access the network.
multihost non-eap-mac status [vlan <1-4059>] [{slot/port[/sub-port]} [-slot/port[/sub-port]] [,...]]	Displays EAPoL multihost configuration.
port {interface [gigabitEthernet {slot/port[/sub-port]} [-slot/port[/sub-port]] [,...]] {slot/port[/sub-port]} [-slot/port[/sub-port]] [,...]]	Specifies the ports to display. If no port is entered, all ports are displayed.
session-stats interface [gigabitEthernet {slot/port[/sub-port]} [-slot/port[/sub-port]] [,...]]	Displays the authentication session statistics interface.
status interface [vlan <1-4059>] [gigabitEthernet {slot/port[/sub-port]} [-slot/port[/sub-port]] [,...]]	Displays the port EAP operation statistics.
system	Displays EAPoL settings.

Configuring the format of the RADIUS password attribute when authenticating non-EAP MAC addresses using RADIUS

Use the following procedure to configure the format of the RADIUS password when authenticating non-EAP MAC addresses using RADIUS.

Procedure

1. Enter Global Configuration mode:

```
enable
configure terminal
```

2. Configure the RADIUS password format:

```
eapol multihost non-eap-pwd-fmt {[ip-addr] [key WORD<1-32>] [mac-addr] [padding] [port-number]}
```

Variable definitions

Use the data in the following table to use the `eapol multihost non-eap-pwd-fmt` command.

Variable	Value
ip-addr	Management ip-address of the switch.
key WORD<1-32>	Key value used for non-eap password format.
mac-addr	Mac-Address of the client.
padding	Includes a dot in the RADIUS password for every missing parameter.
port-number	Index of the port on which MAC is received.

* Note:

To derive the port number for an interface, use the command `show interfaces gigabit [{slot/port[/sub-port] [-slot/port[/sub-port]][,...]]` .

If you configure interface 1/6 on the product, to derive the port-number for this interface, use the command `show interfaces gigabitEthernet 1/6`. From this command, you can ascertain that port number used in the NEAP password is 197.

```
Switch:1(config)# show interfaces gigabitEthernet 1/6
```

```
=====
                                     Port Interface
=====
```

PORT NUM	INDEX	DESCRIPTION	LINK TRAP	PORT LOCK	MTU	PHYSICAL ADDRESS	STATUS ADMIN OPERATE	
1/6	197	1000BaseTX	true	false	1950	f8:15:47:e1:dd:05	up	up

Enabling RADIUS authentication of non-EAPoL hosts on EAPoL enabled ports

For RADIUS authentication of non-EAPoL hosts on EAPoL-enabled ports, you must enable EAPoL globally on the switch and then enable non-EAPoL hosts on the local interface.

Procedure

1. Enter GigabitEthernet Interface Configuration mode:

```
enable
configure terminal
interface GigabitEthernet {slot/port[/sub-port] [-slot/port[/sub-port]][, ...]}
```

*** Note:**

If your platform supports channelization and the port is channelized, you must also specify the sub-port in the format slot/port/sub-port.

2. Enable RADIUS authentication of non-EAPoL hosts on the local interface:

```
eapol multihost radius-non-eap-enable
```

Configuring the maximum MAC clients

Use this procedure to configure the maximum EAP and NEAP MAC clients supported on a port.

Procedure

1. Enter Interface Configuration mode:

```
enable
configure terminal
interface GigabitEthernet {slot/port[/sub-port] [-slot/port[/sub-port]][, ...]} or interface vlan <1-4059>
```

*** Note:**

If your platform supports channelization and the port is channelized, you must also specify the sub-port in the format slot/port/sub-port.

2. Set the maximum limit of allowed EAP and NEAP MAC clients supported on the port:

```
eapol multihost mac-max <1-32>
```

Example

```
Switch:1> enable
Switch:1# configure terminal
```

```
Switch:1(config)# interface GigabitEthernet 1/16
Switch:1(config-if)# eapol multihost mac-max <1-32>
```

Variable definitions

Use the data in the following table to use the `eapol multihost mac-max` command.

Variable	Value
mac-max <1-32>	Specifies the maximum number of EAP and NEAP MAC addresses allowed on the port. The maximum limit is 32 MAC addresses.

Clearing Non-EAPoL session

Use this procedure to clear the Non-EAPoL session that is learnt on the switch.

Procedure

1. Enter Global Configuration mode:

```
enable
configure terminal
```

2. Clear the Non-EAPoL session:

```
clear eapol non-eap [<0x00:0x00:0x00:0x00:0x00:0x00>] [{slot/port[/sub-port]
[-slot/port[/sub-port]][,...]}
<0x00:0x00:0x00:0x00:0x00:0x00>]
```

Example

```
Switch:1> enable
Switch:1# configure terminal
Switch:1(config)# clear 1/16 00:1b:63:84:45:e6
```

Variable definitions

Use the data in the following table to use the `clear eapol non-eap` command.

Variable	Value
{slot/port[/sub-port] [-slot/port[/sub-port]][,...]}	Specifies the port list on which the Non-EAP MAC is learnt.
0x00:0x00:0x00:0x00:0x00:0x00	Specifies the MAC-Address on the Non-EAP session.

EAPoL configuration using Enterprise Device Manager

EAPoL uses RADIUS protocol for EAPoL-authorized logons. RADIUS supports IPv4 and IPv6 addresses with no difference in functionality or configuration in all but the following case. When

adding a RADIUS server in Enterprise Device Manager (EDM) or modifying a RADIUS configuration in EDM, you must specify if the address type is an IPv4 or an IPv6 address.

Before you begin

- Before configuring your device, you must configure at least one EAPoL RADIUS server and shared secret fields.
- You cannot configure EAPoL on ports that are currently configured for:
 - Shared segments
 - MultiLink Trunking (MLT)
- Change the status of each port that you want to be controlled to auto. For more information on changing the status, see [Configuring EAPoL on a port](#) on page 137. The auto setting automatically authenticates the port according to the results of the RADIUS server. The default authentication setting for each port is force-authorized.
- You can connect only a single client on each port configured for EAPoL. If you attempt to add additional clients on the EAPoL authorized port, the client traffic will be blocked from the switch till mac-ageing occurs for that client.

Globally configuring EAPoL on the server

About this task

Globally enable or disable EAPoL on the server. By default, EAPoL is disabled. This feature sets all controlled ports on the server as EAPoL-enabled.

Procedure

1. In the navigation tree, expand the following folders: **Configuration > Security > Data Path**.
2. Click **802.1x - EAPOL**.
3. Click the **Global** tab.
4. From the AccessControl options, select **enable**.
5. **(Optional)** Select the appropriate **NonEapRadiusPwdAttrFmt** check boxes to configure the format of the RADIUS password when authenticating non-EAP MAC addresses using RADIUS.
6. **(Optional)** Enter the key string in the **NonNonEapRadiusPwdAttkeystring** field.
7. Click **Apply**.

Global field descriptions

Use the data in the following table to use the **Global** tab.

Name	Description
EapolVersion	Displays the Eapol version on the switch.

Table continues...

Name	Description
AccessControl	Enables system authentication control. EAPoL is enabled by default.
NonEapRadiusPwdAttrFmt	Specifies the password attribute format for non EAPoL RADIUS authentication. <ul style="list-style-type: none"> • ipAdd: Specifies IP address. • macAddr: Specifies MAC address. • portNumber: Specifies port number • padding: Specifies padding.
NonEapRadiusPwdAttrKeyString	Specifies the attribute key string for non EAPoL RADIUS password. The range is 0– 32 characters.

Configuring EAPoL on a port

About this task

Configure EAPoL or change the authentication status on one or more ports.

Ports are force-authorized by default. Force-authorized ports are always authorized and are not authenticated by the RADIUS server. You can change this setting so that the ports are always unauthorized.

Procedure

1. In the Device Physical View tab, select the port you need to configure.
2. In the navigation tree, expand the following folders: **Configuration > Edit > Port**.
3. Click **General**.
4. Click the **EAPoL** tab.
5. **(Optional)** Select the **PortInitialize** check box to initialize EAPoL authentication on this port.
6. **(Optional)** Select the **AllowNonEapHost** check box to allow hosts that do not participate in 802.1X authentication to get network access.
7. Select the **Status** option as **auto** or **forceAuthorized**.
8. Select the **ReAuthEnabled** field.
9. In the **QuietPeriod** field, type the time interval.
10. In the **ReauthPeriod** field, type the time between reauthentication.
11. In the **RetryMax** field, type the number of times.
12. Click **Apply**.

EAPoL field descriptions

Use the data in the following table to use the **EAPoL** tab.

Name	Description
PortInitialize	Initializes EAPoL authentication on this port. After the port initializes, this field reverts to its default, which is disabled.
PortCapabilities	<p>Displays the capabilities of the Port Access Entity (PAE) associated with the port. This parameter indicates whether Authenticator functionality, supplicant functionality, both, or neither, is supported by the PAE of the port.</p> <p>The following capabilities are supported by the PAE of the port:</p> <ul style="list-style-type: none"> • supplImplemented: A Port Access Controller Protocol (PACP) Extensible Authentication Protocol (EAP) supplicant functions are implemented. • authImplemented: A Port Access Controller Protocol (PACP) Extensible Authentication Protocol (EAP) authenticator functions are implemented. • mkalImplemented: The KaY MKA functions are implemented in this. • macsecImplemented: The MACsec functions in the Controlled Port are implemented in this PAE. • announcementsImplemented: The EAPOL announcement can be sent. • listenerImplemented: This PAE can receive EAPOL announcement. • virtualPortsImplemented: Virtual Port functions are implemented.
PortVirtualPortsEnable	Displays the status of the Virtual Ports function for the real port as True or False.
PortCurrentVirtualPorts	Displays the current number of virtual ports running in the port
PortAuthenticatorEnable	Displays the status of the Authenticator function in the Port Access Entity (PAE) as True or False.
PortSupplicantEnable	Displays the Supplicant function in the Port Access Entity (PAE) as True or False.
AllowNonEapHost	Enables the system to allow hosts that do not participate in 802.1X authentication to get network access. The default is disabled.
Status	<p>Configures the authentication status for this port. The default is forceAuthorized.</p> <ul style="list-style-type: none"> • auto: enables the EAPoL authentication process by sending the EAPoL request messages to the RADIUS server. • forceAuthorized: disables the EAPoL authentication and puts the port into force-full authorized mode.

Table continues...

Name	Description
Authenticator configuration	Displays the current Authenticator Port Access Entity (PAE) state. The states are: <ul style="list-style-type: none"> • authenticate • authenticated • Failed
ReAuthEnabled	Reauthenticates an existing supplicant at the time interval specified in ReAuthPeriod. The default is disabled.
QuietPeriod	Configures the time interval (in seconds) between authentication failure and the start of a new authentication. The allowed range is 1–65535; the default is 60.
ReAuthPeriod	Reauthenticates an existing supplicant at the time interval specified in ReAuthPeriod. Specifies the time interval in seconds between successive reauthentications. The allowed range is 1–2147483647; the default is 3600 (1 hour)
RetryMax	Specifies the maximum Extensible Authentication Protocol (EAP) requests sent to the supplicant before timing out the session. The default is 2.
RetryCount	Specifies the maximum number of retries attempted.

Showing the Port Access Entity Port table

About this task

Use the Port Access Entity (PAE) Port Table to display system-level information for each port the PAE supports. An entry appears in this table for each port of this system.

Procedure

1. In the navigation tree, expand the following folders: **Configuration > Security > Data Path**.
2. Click **802.1x - EAPOL**.
3. Click the **EAP Security** tab.

EAP Security field descriptions

Use the data in the following table to use the **EAP Security** tab.

Name	Description
PortNumber	Indicates the port number associated with this port.

Table continues...

Name	Description
PortInitialize	Indicates the initialization control for this port. Configure this attribute true to initialize the port. The attribute value reverts to false when initialization is complete.
PortCapabilities	Indicates the PAE functionality that this port supports and that can be managed through this MIB. <ul style="list-style-type: none"> • dot1xPaePortAuthCapable(0)—Authenticator functions are supported. • dot1xPaePortSuppCapable(1)—Supplicant functions are supported.
PortVirtualPortsEnable	Displays the status of the Virtual Ports function for the real port as True or False.
PortCurrentVirtualPorts	Displays the current number of virtual ports running in the port
PortAuthenticatorEnable	Displays the status of the Authenticator function in the Port Access Entity (PAE) as True or False.
PortSupplicantEnable	Displays the Supplicant function in the Port Access Entity (PAE) as True or False.
AllowNonEapHost	Displays the status if the system is enabled to allow hosts that do not participate in 802.1X authentication to get network access.
Status	Displays the authentication status for this port. The default is forceAuthorized.

Showing EAPoL Authentication

About this task

Use the Authenticator Configuration table to display configuration objects for the Authenticator PAE associated with each port.

Procedure

1. In the navigation pane, expand the following folders: **Configuration > Security > Data Path**.
2. Click **802.1x - EAPOL**.
3. Click the **Authentication** tab.

Authentication field descriptions

Use the data in the following table to use the **Authentication** tab.

Name	Description
PortNumber	Indicates the number associated with this port.

Table continues...

Name	Description
Authenticate	Indicates the status of the Port Access Entity (PAE) authenticator requesting authentication.
Authenticated	Indicates the current authentication status of the Port Access Entity (PAE) authenticator.
Failed	Indicates the authentication status for failed or terminated state .
ReAuthEnabled	Indicates the re-authentication status of an existing supplicant at the time interval specified in ReAuthPeriod.
QuietPeriod	Indicates the time interval (in seconds) between authentication failure and the start of a new authentication. The allowed range is 1–65535; the default is 60.
ReAuthPeriod	Indicates the time interval in seconds between successive re-authentications. The allowed range is 1–2147483647; the default is 3600 (1 hour)
RetryMax	Indicates the maximum Extensible Authentication Protocol (EAP) requests sent to the supplicant before timing out the session. The default is 2
RetryCount	Indicates the count of the number of authentication attempts.

Viewing Multihost status information

Use the following procedure to display multiple host status for a port.

Procedure

1. In the navigation pane, expand the **Configuration --> Security --> Data Path** folders.
2. Click **802.1x–EAPOL**.
3. Click the **MultiHost Status** tab.

MultiHost status field descriptions

The following table describes values on the **MultiHost Status** tab.

Name	Description
PortNumber	Indicates the port number associated with this port.
ClientMACAddr	Indicates the MAC address of the client.
PaeState	Indicates the current state of the authenticator PAE state machine.
VlanId	Indicates the VLAN assigned to the client.

Viewing EAPoL session statistics

Use the following procedure to display multiple host session information for a port.

Procedure

1. In the navigation pane, expand the **Configuration --> Security --> Data Path** folders.
2. Click **802.1x-EAPOL**.
3. Click the **MultiHost Session** tab.

MultiHost session field descriptions

The following table describes values on the **MultiHost Session** tab.

Name	Description
StatsPortNumber	Indicates the port number associated with this port.
StatsClientMACAddr	Indicates the MAC address of the client.
Id	Indicates the unique identifier for the session.
AuthenticMethod	Indicates the authentication method used to establish the session.
Time	Indicates the elapsed time of the session.
TerminateCause	Indicates the cause of the session termination.
UserName	Indicates the user name that represents the identity of the supplicant PAE.

Viewing non-EAPoL MAC information

Use this procedure to view non-EAPoL client MAC information on a port.

Procedure

1. In the navigation pane, expand the **Configuration --> Security --> Data Path** folders.
2. Click **802.1x-EAPOL**.
3. Click the **NEAP Radius** tab.

NEAP Radius field descriptions

The following table describes values on the **NEAP Radius** tab.

Name	Description
MacPort	Indicates the port number associated with this port.
MacAddr	Indicates the MAC address of the client.

Table continues...

Name	Description
MacStatus	Indicates the authentication status of the non EAP host that is authenticated using the RADIUS server.
VlanId	Indicates the VLAN assigned to the client.

Chapter 6: IPsec

The following sections describe Internet Protocol Security (IPsec) and its configuration.

IPsec fundamentals

Internet Protocol Security (IPsec) ensures the authenticity, integrity, and confidentiality of data at the network layer of the Open System Interconnection (OSI) stack.

The IPsec feature is a set of security protocols and cryptographic algorithms that protect communication in a network. Use IPsec in scenarios where you need to encrypt packets between two hosts, or two routers, or a router and a host.

IPsec adds support for OSPF virtual link for the security protection of the communication between the end points. You can also use IPsec with OSPFv3 on a brouter port or VLAN interface, for example, if you want to encrypt OSPFv3 control traffic on a broadcast network. You can also use IPsec with ICMPv6.

The following figure displays the movement of traffic using IPsec.

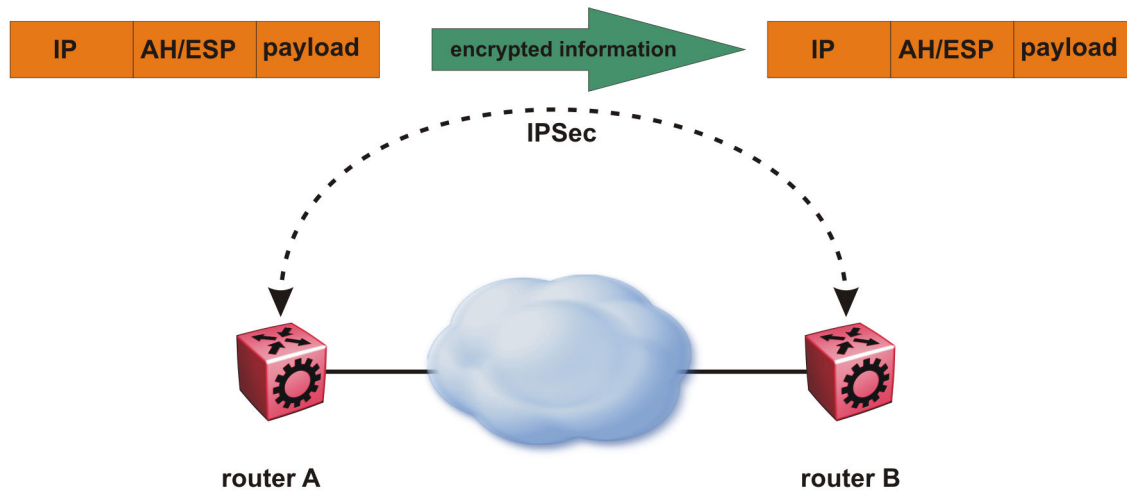

Figure 18: Internet Protocol Security (IPsec)

The IPsec feature uses security ciphers and encryption algorithms like AES, DES, and 3DES to ensure confidentiality of data, and keyed MAC for authenticity of data. The encryption algorithms require shared keys to secure the communication. The device only supports manual keying and configuration for IPsec. The IPsec feature only supports IPv6 interfaces.

To configure IPsec, you create an IPsec policy, and then link the IPsec policy to an interface. You also link each IPsec policy to an IPsec security association. The IPsec policies define the amount of security applied to specific traffic on a specific interface. The IPsec feature supports the following security protocols:

- Encapsulating security payload (ESP)
- Authentication header (AH)

The device restricts IPsec encryption to control traffic through the CPU. The switch restricts IPsec to transport mode only. The IPsec feature processes either the ingress, the egress, or both the egress and ingress control packets to and from the CPU.

The device checks every ingress or egress packet for the IPsec base protocol, either AH or ESP. The base protocol interacts with the security policy database (SPD) and security association database (SADB) to check the level of security to apply to the packet. The device consults the SPD for both ingress and egress traffic. For egress traffic, the device consults the SPD to determine if IPsec needs to apply security considerations. For ingress traffic, the device consults the SPD to determine whether the traffic received with IPsec encapsulation complies with the policies defined in the system.

For more information on IPsec, see *Configuring IPv6 Routing and Monitoring Performance*.

Authentication header

The authentication header (AH) authenticates IP traffic and ensures you connect with who you want to connect. The authentication header can detect if data is altered in transit and protect against replay attacks. The authentication header does not encrypt traffic.

The authentication header provides a small header that precedes the payload with the use of the security parameters index (SPI) and sequence number. The authentication header provides:

- IP datagram sender authentication by HMAC or MAC
- IP datagram integrity assurance by HMAC or MAC
- Replay detection and protection by sequence number

The IPsec feature inserts the AH header after the IP header in transport mode. Transport mode with AH authenticates only the payload of the IP packet. The device only supports transport mode.

The device does not support tunnel mode. Tunnel mode authenticates the entire IP packet, including the IP header and data, to provide a secure hop between two hosts, two routers, or a router and a host.

You can apply AH alone, or in combination with the Encapsulating Security Payload (ESP).

The following figures show an original IP packet and an IP packet with an AH header.



Figure 19: Original IP packet

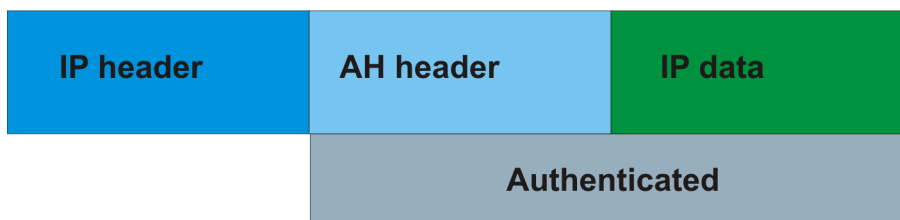

Figure 20: AH in transport mode

Encapsulating security payload

The encapsulating security payload (ESP) encrypts traffic with use of encryption algorithms, such as 3DES, AES-CBC, and AES-CTR. The security association specifies the algorithm and key used in ESP.

The encapsulating security payload can protect origin authenticity, integrity, and confidentiality of packets. ESP supports encryption-only and authentication-only configurations. The IPsec feature inserts the ESP header after the IP header and before the next layer protocol header in transport mode. Transport mode with ESP encrypts or authenticates only the payload of the IP packet. The device only supports transport mode.

The device does not support tunnel mode. Tunnel mode encrypts or authenticates the entire IP packet, including the IP header and data, to provide a secure hop between two hosts, two routers, or a router and a host.

The following figures display the original IP packet and an IP packet with ESP.



Figure 21: Original IP packet

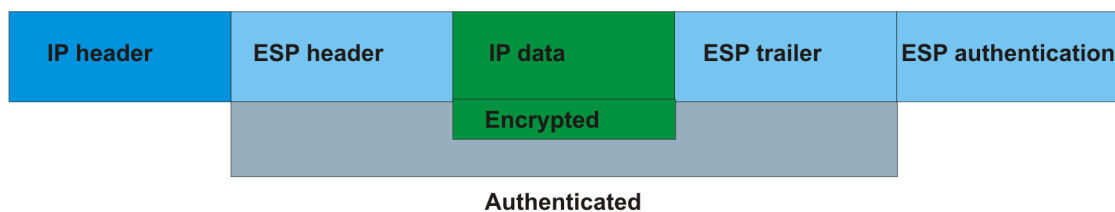

Figure 22: ESP in transport mode

IPsec modes

The IPsec feature security protocols use two different modes to protect the entire IP payload or the upper layer protocols:

- Transport mode
- Tunnel mode

The device only supports transport mode. The device uses transport mode to protect the upper layer protocols. In transport mode, IPsec adds an IPsec header between the IP header and upper layer protocol header.

This device does not support tunnel mode. Under tunnel mode IPsec protects the whole IP packet. In tunnel mode, IPsec inserts the IPsec header between another IP datagram IP header and inner IP header.

Security association

A security association (SA) is a group of algorithms and parameters used to encrypt and authenticate the flow of IP traffic in a particular direction. An SA contains the information IPsec needs to process an IP packet. IPsec identifies SAs by:

- Security Parameter Index (SPI)
- Protocol value (either AH or ESP)
- Destination address to which the SA applies

Creation of a security association

Typically SAs exist in pairs; one in each direction, either inbound or outbound.

You can create SAs manually or dynamically. After you create an SA manually, the SA has no defined lifetime and the SA exists until you manually delete the SA.

After the device creates the SA dynamically, the SA can have a lifetime value that IPsec peers negotiate through use of a key management protocol. If the device uses the key excessively unauthorized access can occur. You must define the IPsec lifetime and other configurable parameters manually.

Security associations reside in the Security Association Database (SADB), which maintains a list of active SAs. The IPsec feature uses outbound SAs to secure the outgoing traffic and inbound SAs to process the incoming traffic. The device checks every ingress or egress packet for the IPsec base protocol, either AH or ESP. The base protocol interacts with the security policy database (SPD) and security association database (SADB) to check the level of security to apply to that packet.

The IPsec feature restricts SAs to the source and destination address of the connected router.

Security policy

Use IPsec to create IPsec security policies that define the levels of security for different types of traffic. You can use IPsec security policies to create rules to filter traffic with IPsec. IPsec policies determine what IP traffic to secure. An IPsec security policy typically consists of:

- An IP filter
- Security algorithms for authentication and key exchange
- An action

Creation of a security policy

You can configure IPsec on IPv6 interfaces. First, create and configure an IPsec policy, and then add and enable the policy on an interface.

After you enable IPsec, the device encrypts all control traffic on the interface based on the policy. You have to specify individual policies to target a particular interface address or multiple addresses. By default, this implementation does not work on a subnet.

The Security Policy Database (SPD) maintains the IPsec security policies. The device checks every ingress or egress packet for the IPsec base protocol, either AH or ESP. The base protocol interacts with the security policy database (SPD) and security association database (SADB) to check the level of security to apply to that packet.

The IPsec feature only adds policies if the source address in the policy specified matches an interface IP address.

The IPsec feature restricts the policy match source address to the interface address of the router and destination IPv6 address.

IPsec limitations

This section describes the limitations associated with IPsec.

- The device only supports IPsec for IPv6 traffic, and an interface must support IPv6 to apply IPsec. No support exists for IPv4 traffic.
- The device only supports IPsec transport mode. IPsec does not support tunnel mode.
- The IPsec feature implementation is available only in software. Hardware implementation is not available. Only control packets to and from the CPU are subject to IPsec. IPsec implements IPsec policies in the software on the control path.
- The IPsec feature does not support automatic keying. No support exists for the Internet Key Exchange (IKE) protocol.
- The device does not support address ranges facility for an IPsec policy.
- No fast-path support exists for IPsec.

IPsec configuration using CLI

The following section provides procedures to configure Internet Protocol Security (IPsec).

Creating an IPsec policy

Use the following procedure to configure an IPsec policy for an IPv6 interface. An IPsec policy defines the level of security for different types of traffic.

The device only supports IPsec for IPv6 traffic, and an interface must support IPv6 to apply IPsec.

Procedure

1. Enter Global Configuration mode:

```
enable
configure terminal
```
2. Create an IPsec policy:

```
ipv6 ipsec policy WORD<1-32>
```
3. **(Optional)** Delete an IPsec policy:

```
no ipv6 ipsec policy WORD<1-32>
```

Example

Create an IPsec policy named `newpolicy`:

```
Switch:1>enable
Switch:1#configure terminal
Switch:1(config)# ipv6 ipsec policy newpolicy
```

Variable definitions

Use the data in the following table to use the `ipv6 ipsec policy` command.

Variable	Value
<code>WORD<1-32></code>	Specifies the IPsec policy name.

Enabling an IPsec policy

Use the following procedure to enable an IPsec policy. An IPsec policy defines the level of security for different types of traffic.

The device only supports IPsec for IPv6 traffic, and an interface must support IPv6 to apply IPsec.

Before you begin

- Create an IPsec policy.

About this task

The IPsec feature adds policies only if the admin status of the policy and the IPsec status on the interface are enabled.

If you disable the IPsec policy on an IPv6 interface, IPsec removes the policy-related information from the security policy database (SPD) and the security association database (SADB), but the information remains on the system. After you re-enable, the information reapplies on the IPv6 interface.

Procedure

1. Enter Global Configuration mode:

```
enable
```

```
configure terminal
```

2. Enable an IPsec policy:

```
ipv6 ipsec policy WORD<1-32> admin enable
```

3. **(Optional)** Disable an IPsec policy:

```
no ipv6 ipsec policy WORD<1-32> admin enable
```

Example

Enable an IPsec policy named `newpolicy`:

```
Switch:1>enable
Switch:1#configure terminal
Switch:1(config)#ipv6 ipsec policy newpolicy admin enable
```

Variable definitions

Use the data in the following table to use the `ipv6 ipsec policy` command.

Variable	Value
admin enable	Enables the policy.
WORD<1-32>	Specifies the IPsec policy name.

Creating an IPsec security association

Use the following procedure to create an IPsec security association. A security association (SA) is a group of algorithms and parameters used to encrypt and authenticate the flow of IP traffic in a particular direction. An SA contains the information IPsec needs to process an IP packet.

The device only supports IPsec for IPv6 traffic, and an interface must support IPv6 to apply IPsec.

About this task

You cannot delete or modify a security association if the security association links to a policy. To modify a parameter in the security association or to delete the security association, you must first unlink the security association from a policy.

Procedure

1. Enter Global Configuration mode:

```
enable
```

```
configure terminal
```

2. Create an IPsec security association:

```
ipv6 ipsec security-association WORD<1-32>
```

3. **(Optional)** Delete an IPsec security association:

```
no ipv6 ipsec security-association WORD<1-32>
```

Example

Create an IPsec security association named `newsa`:

```
Switch:1>enable
Switch:1#configure terminal
Switch:1(config)#ipv6 ipsec security-association newsa
```

Variable definitions

Use the data in the following table to use the `ipv6 ipsec security-association` command.

Variable	Value
<code>WORD<1-32></code>	Specifies the security association identifier.

Configuring an IPsec security association

Use the following procedure to configure an IPsec security association (SA). An SA is a group of algorithms and parameters used to encrypt and authenticate the flow of IP traffic in a particular direction. An SA contains the information IPsec needs to process an IP packet.

The device only supports IPsec for IPv6 traffic, and an interface must support IPv6 to apply IPsec.

Before you begin

- Create an IPsec security association to configure.

About this task

You cannot delete or modify a security association if the security association links to a policy. To modify a parameter in the security association, or to delete the security association, you must first unlink the security association from a policy. You can only unlink a security association from a policy if the policy does not link to an interface. If a policy links to an interface, you must first unlink the policy from the interface, and then unlink the policy from the security association.

Procedure

1. Enter Global Configuration mode:

```
enable
configure terminal
```

2. Configure the IPsec security association key-mode:

```
ipv6 ipsec security-association WORD<1-32> key-mode <automatic|
manual>
```

This device only supports manual mode.

3. Configure the IPsec security association mode:

```
ipv6 ipsec security-association WORD<1-32> mode <transport|tunnel>
```

This device only supports transport mode.

4. Configure the IPsec security association encapsulation protocol:

```
ipv6 ipsec security-association WORD<1-32> encap-proto <AH|ESP>
```

5. Configure the IPsec security association security parameters index:

```
ipv6 ipsec security-association WORD<1-32> spi <1-4294967295>
```

For IPsec to function, each peer must have the same SPI value configured on both peers for a particular policy.

6. Configure the IPsec security association encryption algorithm:

```
ipv6 ipsec security-association WORD<1-32> Encrpt-algo <3DES|AES-
CBC|AES-CTR|NULL> [EncrptKey WORD<1-256>][KeyLength <1-256>]
```

The encryption algorithm parameters are only accessible if you configure the encapsulation protocol to ESP.

7. Configure the IPsec security association authentication algorithm:

```
ipv6 ipsec security-association WORD<1-32> auth-algo <AES-XCBC-MAC|
MD5|NULL|SHA1> [auth-key WORD<1-256>][KeyLength <1-256>]
```

8. Configure the IPsec security association lifetime value:

```
ipv6 ipsec security-association WORD<1-32> lifetime
<Bytes<1-4294967295>|seconds<1-4294967295>
```

9. (Optional) Delete the IPsec security association:

```
no ipv6 ipsec security-association WORD<1-32>
```

Example

Configure an IPsec security association named `new_sa` to have a key-mode of `ASCII`, an SA mode of `transport`, and an encapsulation protocol of `ESP`. Configure the encryption algorithm to `3DES`, with an encryption key of `11111111111111111111111111111111`, and a keylength of `24`. Configure the authorization algorithm to `SHA1`, the authorization key to `11111111111111111111111111111111`, and key length to `20`. Configure the SPI to `1` and the lifetime in seconds to `1000`.

```
Switch:1>enable
Switch:1#configure terminal
Switch:1(config)#ipv6 ipsec security-association newsa key-mode manual
Switch:1(config)#ipv6 ipsec security-association newsa mode transport
Switch:1(config)#ipv6 ipsec security-association newsa encap-proto ESP
Switch:1(config)#ipv6 ipsec security-association newsa Encrpt-algo 3DES Encrpt-key
11111111111111111111111111111111 KeyLength 24
Switch:1(config)#ipv6 ipsec security-association newsa auth-algo SHA1 auth-key
11111111111111111111111111111111 KeyLength 20
Switch:1(config)#ipv6 ipsec security-association newsa spi 1
Switch:1(config)#ipv6 ipsec security-association newsa lifetime seconds 1000
```

Variable definitions

Use the data in the following table to use the `ipv6 ipsec security-association` command.

Variable	Value
<code>WORD<1-32></code>	Specifies the security association.

Table continues...

Variable	Value
auth-algo <AES-XCBC-MAC MD5 NULL SHA1> [auth-key WORD<1–256>] [KeyLength <1–256>]	Specifies the authorization algorithm, which includes one of the following values: <ul style="list-style-type: none"> • AES-XCBC-MAC • MD5 • NULL • SHA1 The default authentication algorithm name is MD5. The parameter auth-key specifies the authentication key. The KeyLength parameter specifies a string value of 1 to 256 characters in length. The default KeyLength is 128. The KeyLength values are as follows: 3DES is 48, AES-CBC is 32, 48, or 64, AES-CTR is 32.
encap-proto <AH ESP>	Specifies the encapsulation protocol: <ul style="list-style-type: none"> • AH—Specifies authentication header. • ESP—Specifies encapsulation security payload. If you configure the encapsulation protocol as AH, you cannot configure the encryption algorithms and other encryption related attributes. You can only access the encryption algorithm parameters if you configure the encapsulation protocol to ESP. The default value is ESP.
Encrpt-algo <3DES AES-CBC AES-CTR NULL> [EncrptKey WORD<1–256>] [KeyLength <1–256>]	Specifies the encryption algorithm value as one of the following: <ul style="list-style-type: none"> • 3DES-CBC • AES-CBC • AES-CTR • NULL—Only use the NULL parameter to debug. Do not use this parameter in any other circumstance. The default encryption algorithm is AES-CBC. You can only access the encryption algorithm parameters if you configure the encapsulation protocol to ESP. The EncrptKey specifies the encryption key. The KeyLength specifies the key length value in a string from 1 to 256 characters. The default KeyLength is 128. The KeyLength values are as

Table continues...

Variable	Value
	follows: 3DES is 48, AES-CBC is 32, 48, or 64, AES-CTR is 32.
key-mode < <i>automatic</i> <i>manual</i> >	Specifies the key-mode as one of the following: <ul style="list-style-type: none"> • automatic • manual The default is manual. This device only supports manual.
lifetime <Bytes<1-4294967295> seconds<1-4294967295>	Specifies the lifetime value in seconds or kilobytes. <p>The default lifetime value in seconds is 0, which is infinite. The default value in bytes is 0, which is infinite.</p>
mode < <i>transport</i> <i>tunnel</i> >	Specifies the mode value as one of the following: <ul style="list-style-type: none"> • transport—Transport mode encapsulates the IP payload and provides a secure connection between two end points. This device only supports transport mode. • tunnel—Tunnel mode encapsulates the entire IP packet and provides a secure tunnel. This device does not support tunnel mode. The default is transport mode.
spi<1-4294967295>	Specifies the security parameters index (SPI) value, which is a unique value. SPI is a tag IPsec adds to the IP header. The tag enables the system that receives the IP packet to determine under which security association to process the received packet. <p>For IPsec to function, each peer must have the same SPI value configured on both peers for a particular policy.</p> The default value is 0.

Configuring an IPsec policy

Use the following procedure to configure an IPsec policy. An IPsec policy defines the level of security for different types of traffic.

The device only supports IPsec for IPv6 traffic, and an interface must support IPv6 to apply IPsec.

Before you begin

- Create an IPsec policy.

About this task

You cannot delete or modify a policy if the policy links to a security association, or if the policy links to a port or VLAN interface. If you need to modify a policy you must first unlink the policy from the security association, and the port or VLAN interface.

Procedure

1. Enter Global Configuration mode:

```
enable
configure terminal
```

2. Configure the remote address:

```
ipv6 ipsec policy WORD<1-32> raddr WORD<1-32>
```

3. **(Optional)** Configure the local address:

```
ipv6 ipsec policy WORD<1-32> laddr WORD<1-32>
```

The `laddr` parameter is an optional parameter that you can configure to have multiple local addresses for each remote address.

4. Configure the protocol:

```
ipv6 ipsec policy WORD<1-32> [protocol <icmpv6|ospfv3|tcp|udp>]
[sport<1-65535|any>] [dport<1-65535|any>]
```

5. Configure the policy action:

```
ipv6 ipsec policy WORD<1-32> [action <drop|permit>]
```

Example

Configure the remote address to `2001:db8:0:0:0:0:1` and local address to `2001:db8:0:0:0:0:0:15`. configure the protocol to TCP sport 4 dport 5. Configure the policy to permit.

```
Switch:1>enable
Switch:1#configure terminal
Switch:1(config)#ipv6 ipsec policy newpolicy raddr 2001:db8:0:0:0:0:1
Switch:1(config)#ipv6 ipsec policy newpolicy laddr 2001:db8:0:0:0:0:15
Switch:1(config)#ipv6 ipsec policy newpolicy protocol tcp sport 4 dport 5
Switch:1(config)#ipv6 ipsec policy newpolicy action permit
```

Variable definitions

Use the data in the following table to use the `ipv6 ipsec policy` command.

Variable	Value
action <drop permit>	Specifies the action the policy takes. The default is permit.
laddr WORD<1-32>	Specifies the local address. The laddr parameter is optional. The laddr parameter is an optional

Table continues...

Variable	Value
	parameter that you can configure to have multiple local addresses for each remote address. The default is 0::0.
protocol <icmpv6 ospfv3 tcp udp> [sport<1–65535> any>][dport<1–65535> any>]	Specifies the protocol, as one of the following: <ul style="list-style-type: none"> • ICMPv6 • OSPFv3 • TCP • UDP sport — Specifies the source port for TCP and UDP. You can specify any to configure any port as the source port. dport — Specifies the destination port for TCP and UDP. You can specify any to configure any port as the destination port. The default protocol is TCP any.
raddr WORD<1–32>	Specifies the remote address. The default is 0::0.
WORD<1–32>	Specifies the policy name.

Linking the IPsec security association to an IPsec policy

Use the following procedure to link the security association to an IPsec policy.

The device only supports IPsec for IPv6 traffic, and an interface must support IPv6 to apply IPsec.

Before you begin

- The IPsec security association and IPsec policy must exist.

About this task

You cannot delete or modify a security association if the security association links to a policy. To modify a parameter in the security association, or to delete the security association, you must first unlink the security association from the policy. You can only unlink a security association from a policy if the policy does not link to an interface. If a policy links to an interface, you must first unlink the policy from the interface, and then unlink the policy from the security association.

Procedure

1. Enter Global Configuration mode:

```
enable
configure terminal
```
2. Link the IPsec security association to the IPsec policy:

```
ipv6 ipsec policy WORD<1-32> security-association WORD<1-32>
```

3. **(Optional)** Unlink the IPsec security association to the IPsec policy:

```
no ipv6 ipsec policy WORD<1-32> security-association WORD<1-32>
```

Example

Link the IPsec security association named `new_sa` to the IPsec policy named `newpolicy`:

```
Switch:1>enable
Switch:1#configure terminal
Switch:1(config)#ipv6 ipsec policy newpolicy security-association newsa
```

Variable definitions

Use the data in the following table to use the `ipv6 ipsec policy` command.

Variable	Value
<code>WORD<1-32></code>	Specifies the policy ID.
<code>security-association WORD<1-32></code>	Specifies the security association ID.

Enabling IPsec on an interface

Use the following procedure to enable IPsec on an interface.

The device only supports IPsec for IPv6 traffic, and an interface must support IPv6 to apply IPsec.

Procedure

1. Enter Interface Configuration mode:

```
enable

configure terminal

interface GigabitEthernet {slot/port[/sub-port] [-slot/port[/sub-port]][, ...]} or interface vlan <1-4059>
```

*** Note:**

If your platform supports channelization and the port is channelized, you must also specify the sub-port in the format `slot/port/sub-port`.

2. Enable IPsec on an interface:

```
ipv6 ipsec enable

default ipv6 ipsec enable
```

3. **(Optional)** Disable IPsec on an interface:

```
no ipv6 ipsec enable
```

Example

Enable the IPsec on VLAN 100:

```
Switch:1>enable
Switch:1#configure terminal
Switch:1(config)#interface vlan 100
Switch:1(config-if)#ipv6 ipsec enable
```

Variable definition

Use the data in the table to use the `ipv6 ipsec` command.

Variable	Value
enable	Enables IPsec on the IPv6 interface.

Linking an IPsec policy to an interface

Use the following procedure to link an IPsec policy to an interface, and configure a policy direction. By default, the direction is both.

The device only supports IPsec for IPv6 traffic, and an interface must support IPv6 to apply IPsec.

Before you begin

- You must enable IPsec on the interface first, and then you link the IPsec policy to the interface.

About this task

You cannot delete or modify an IPsec policy if the policy links to a port or VLAN interface. If you need to modify the policy, first unlink the policy from the port or VLAN interface.

Procedure

1. Enter Interface Configuration mode:

```
enable
configure terminal
interface GigabitEthernet {slot/port[/sub-port] [-slot/port[/sub-
port]][, ...]} or interface mlt <1-512>
```

*** Note:**

If your platform supports channelization and the port is channelized, you must also specify the sub-port in the format slot/port/sub-port.

2. Link the IPsec policy to an interface:

```
ipv6 ipsec policy WORD<1-32> dir <both|in|out>
```

3. **(Optional)** Unlink the IPsec policy to an interface:

```
no ipv6 ipsec policy WORD<1-32> dir <both|in|out>
```

Example

Link the IPsec policy newpolicy to the interface VLAN 100:

```
Switch:1>enable
Switch:1#configure terminal
Switch:1(config)#interface vlan 100
Switch:1(config-if)#ipv6 ipsec policy newpolicy dir both
```

Variable definitions

Use the data in the following table to use the `ipv6 ipsec policy` command.

Variable	Value
<code>WORD<1–32></code>	Specifies the policy ID.
<code>dir <both in out></code>	<p>Specifies the direction you want to protect with IPsec:</p> <ul style="list-style-type: none"> • <code>both</code>—Specifies both ingress and egress traffic. • <code>in</code>—Specifies ingress traffic. • <code>out</code>—Specifies egress traffic. <p>The default is <code>both</code>.</p>

Enabling IPsec on a management interface

Use the following procedure to enable IPsec on a management interface.

The device only supports IPsec for IPv6 traffic, and an interface must support IPv6 to apply IPsec.

By default, IPsec is disabled on the management interface.

About this task

This procedure only applies to hardware with a dedicated, physical management interface.

Procedure

1. Enter mgmtEthernet Interface Configuration mode:

```
enable
configure terminal
interface mgmtEthernet mgmt
```

2. Enable IPsec on an interface:

```
ipv6 ipsec enable
```

Example

Enable IPsec on the management interface:

```
Switch:1>enable
Switch:1#configure terminal
```

```
Switch:1(config)#interface mgmtEthernet mgmt
Switch:1(config-if)#ipv6 ipsec enable
```

Linking an IPsec policy to a management interface

Use the following procedure to link an IPsec policy to a management interface, and configure a policy direction. By default, the direction is both.

The device only supports IPsec for IPv6 traffic, and an interface must support IPv6 to apply IPsec.

About this task

This procedure only applies to hardware with a dedicated, physical management interface.

Before you begin

- You must enable IPsec on the interface first, and then you link the IPsec policy to the interface.

Procedure

1. Enter mgmtEthernet Interface Configuration mode:

```
enable
configure terminal
interface mgmtEthernet mgmt
```

2. Link the IPsec policy to an interface:

```
ipv6 ipsec policy WORD<1-32> dir <both|in|out>
```

3. **(Optional)** Unlink the IPsec policy to an interface:

```
no ipv6 ipsec policy WORD<1-32> dir <both|in|out>
```

Example

Link the IPsec policy newpolicy to the management interface:

```
Switch:1>enable
Switch:1#configure terminal
Switch:1(config)#interface mgmtEthernet mgmt
Switch:1(config-if)#ipv6 ipsec policy newpolicy dir both
```

Variable definitions

Use the data in the following table to use the `ipv6 ipsec policy` command.

Variable	Value
<code>WORD<1-32></code>	Specifies the policy ID.
<code>dir <both in out></code>	Specifies the direction you want to protect with IPsec: <ul style="list-style-type: none"> • both—Specifies both ingress and egress traffic. • in—Specifies ingress traffic.

Table continues...

Variable	Value
	<ul style="list-style-type: none"> • out—Specifies egress traffic. The default is both.

Displaying IPsec information on an interface

Use the following procedure to display IPsec information on an interface.

Procedure

1. Log on to the switch to enter User EXEC mode.
2. Display the IPsec status on an Ethernet interface:

```
show ipv6 ipsec interface gigabitethernet {slot/port[/sub-port]][-slot/port[/sub-port]][,...]
```

The command only works on an interface where you enable IPv6. If you do not enable IPv6 on the interface, the command displays an error.

3. Display the IPsec status on a VLAN interface:

```
show ipv6 ipsec interface vlan <1-4059>
```

The command only works on an interface where you enable IPv6. If you do not enable IPv6 on the interface, the command displays an error.

4. Display the IPsec status on a management interface:

```
show ipv6 ipsec interface mgmtethernet mgmt
```

Note:

This step applies to hardware that includes a physical management interface.

Example

Display IPsec status on interfaces.

```
Switch:1>enable
Switch:1#show ipv6 ipsec interface vlan 10

=====
                        VLAN Interface Policy Table
=====
Vlan Interface      Policy Name      IPsec State
-----
10                  ospfany          Enable
-----

Switch:1#show ipv6 ipsec interface port 2/3

=====
                        PORT Interface Policy Table
=====
Interface          Policy Name      IPsec State
-----
2/3                ospf1            Enable
```

Variable definitions

Use the data in the following table to use the `show ipv6 ipsec interface` command:

Variable	Value
gigabitethernet {slot/port[/sub-port][-slot/port[/sub-port]][,...]}	Identifies the slot and port in one of the following formats: a single slot and port (slot/port), a range of slots and ports (slot/port-slot/port), or a series of slots and ports (slot/port,slot/port,slot/port). If your platform supports channelization and the port is channelized, you must also specify the sub-port in the format slot/port/sub-port.
mgmtethernet mgmt	Identifies the interface as the management interface.
vlan <1-4059>	Specifies the VLAN ID in the range of 1 to 4059. By default, VLAN IDs 1 to 4059 are configurable and the system reserves VLAN IDs 4060 to 4094 for internal use. If you enable VRF scaling and SPBM mode, the system also reserves VLAN IDs 3500 to 3999. VLAN ID 1 is the default VLAN and you cannot create or delete VLAN ID 1.

Job aid

The following table describes the fields in the output for the `show ipv6 ipsec interface vlan` command.

Parameter	Description
Vlan Interface	Specifies the VLAN interface.
Policy Name	Specifies the IPsec policy that associates with the specific VLAN or VLANs.
IPsec State	Specifies whether the IPsec policy is enabled on the VLAN interface.
Direction	Specifies the policy direction.

The following table describes the fields in the output for the `show ipv6 ipsec interface gigabitethernet` command.

Parameter	Description
Interface	Specifies the interface.
Policy Name	Specifies the IPsec policy that associates with the specific port or ports.
IPsec State	Specifies whether the IPsec policy is enabled on the interface.
Direction	Specifies the policy direction.

The following table describes the fields in the output for the `show ipv6 ipsec interface mgmtethernet mgmt` command.

Parameter	Description
Vlan Interface	Specifies the VLAN interface.
Policy Name	Specifies the IPsec policy that associates with the management port.
IPsec State	Specifies whether the IPsec policy is enabled on the interface.
Direction	Specifies the policy direction.

Displaying configured IPsec policies

Use the following procedure to display IPsec policies.

Procedure

1. Log on to the switch to enter User EXEC mode.
2. Display all of the IPsec policies on the switch:

```
show ipv6 ipsec policy all
```
3. Display a specific IPsec policy based on the policy name on the interface:

```
show ipv6 ipsec policy interface WORD<1-32>
```
4. Display the IPsec policy based on the policy name:

```
show ipv6 ipsec policy name WORD<1-32>
```

Example

Display IPsec policy information:

```
Switch:1>enable
Switch:1#show ipv6 ipsec policy all
=====
IPSEC Policy Table
=====
PolicyName      : ospf1
LocalAddress: 0::0
RemoteAddress: 0::0
Protocol: ospfv3
src-port: 0
dest-port: 0
Action: Permit
Admin: Enable

Switch:1#show ipv6 ipsec policy interface ospf1
=====
IPsec Policy Interface Table
=====
POLICY NAME      InterfaceIndex      Policy State
=====
```

```
ospf1                2/3                Enable

Switch:1#show ipv6 ipsec policy name ospf1
=====
                        IPSEC Policy Table
=====
PolicyName           : ospf1
LocalAddress: 0::0
RemoteAddress: 0::0
Protocol: ospfv3
src-port: 0
dest-port: 0
Action: Permit
Admin: Enable
```

Variable definitions

Use the data in the following table to use the **show ipv6 ipsec policy** command.

Variable	Value
all	Displays all of the IPsec policies on the switch.
interface <i>WORD</i> <1–32>	Displays a specific IPsec policy based on the policy name on the interface.
name <i>WORD</i> <1–32>	Displays the IPsec policy based on the name of the policy.

Job aid

The following table describes the fields in the output for the **show ipv6 ipsec policy all** and **show ipv6 ipsec policy name** commands.

Parameter	Description
PolicyName	Specifies the IPsec policy name.
LocalAddress	Specifies the local address. The default is 0::0.
RemoteAddress	Specifies the remote address. The default is 0::0.
Protocol	Specifies the protocol.
src-port	Specifies the source port.
dest-port	Specifies the destination port.
Action	Specifies the action as either: permit or drop.
Admin	Specifies whether the policy is enabled.

The following table describes the fields in the output for the **show ipv6 ipsec policy interface** command.

Parameter	Description
POLICY NAME	Specifies the IPsec policy name.
InterfaceIndex	Specifies the interface.
Policy State	Specifies whether the policy is enabled.

Displaying IPsec security association information

Use the following procedure to display IPsec security association information.

Procedure

1. Enter Privileged EXEC mode:
enable
2. Display all IPsec security associations:
show ipv6 ipsec sa all
3. Display a specific IPsec security association:
show ipv6 ipsec sa name *WORD*<1-32>
4. Display all security associations linked to a specific policy:
show ipv6 ipsec sa-policy

Example

Display information on IPsec security association policies:

```
Switch:1>enable
Switch:1#show ipv6 ipsec sa all
=====
IPSEC Security Association Table
=====
sa-name: ospf1
key-Mode: manual
Encap protocol: ESP
SPI Value: 9
Encrypt Algorithm: 3dec-cbc
Encrypt-key: 52fb29f723b0800870dc83e3
Encrypt-key-Len: 24
Auth Algorithm: hmac-md5
Auth-key: 123456789abcdef0
Auth-key-Len: 16
Mode: transport
Lifetime-Sec: 1000
Lifetime-Byte: 20000

Switch:1#show ipv6 ipsec sa name ospf1
=====
IPSEC Security Association Table
=====
sa-name: ospf1
key-Mode: manual
Encap protocol: ESP
SPI Value: 9
Encrypt Algorithm: 3dec-cbc
Encrypt-key: 52fb29f723b0800870dc83e3
Encrypt-key-Len: 24
Auth Algorithm: hmac-md5
Auth-key: 123456789abcdef0
Auth-key-Len: 16
Mode: transport
```

```
Lifetime-Sec: 1000
Lifetime-Byte: 20000

Switch:1#show ipv6 ipsec sa-policy
```

```
=====
                          SA POLICY TABLE
=====
Policy Name      Security Association
-----
ospfl            ospfl
=====
```

Variable definitions

Use the data in the following table to use the `show ipv6 ipsec sa` command.

Variable	Value
all	Displays all security associations.
name <i>WORD</i> <1–32>	Displays a specific security association based on name.

Use the data in the following table to use the `show ipv6 ipsec` command.

Variable	Value
sa-policy	Displays all security associations linked to a specific policy.

Job aid

The following table describes the fields in the output for the `show ipv6 ipsec sa all` and `show ipv6 ipsec saname` commands.

Parameter	Description
sa-name	Specifies all of the IPsec security association names.
key-Mode	Specifies the key mode as manual or automatic. The default is automatic.
Encap protocol	Specifies the encapsulation protocol.
SPI Value	Specifies the SPI value, which is a tag added to the IP header. For IPsec to function, each peer must have the same SPI value configured on both peers for a particular policy.
Encrypt Algorithm	Specifies the encrypt algorithm as one of the following: <ul style="list-style-type: none"> • 3DES-CBC • AES-CBC • AES-CTR • NULL—Only used to debug.

Table continues...

Parameter	Description
Encrypt-key	Specifies the encrypt-key parameter for the authentication key in either: <ul style="list-style-type: none"> hex— Specifies hexadecimal. ascii—Specifies ASCII, the American Standard Code for Information Interchange character encoding scheme.
Encrypt-key-Len	Specifies the key length value in a string from 1 to 256 characters. The default KeyLength is 128.
Mode	Specifies the mode value as one of the following: <ul style="list-style-type: none"> tunnel—Tunnel mode encapsulates the entire IP packet and provides a secure tunnel. This device does not support tunnel mode. transport—Transport mode encapsulates the IP payload and provides a secure connection between two endpoints. This device only supports transport mode. The default is transport mode.
Lifetime-Sec	Specifies the lifetime value in seconds. The default is 0, which is infinite.
Lifetime-Byte	Specifies the lifetime value in bytes. The default is 0, which is infinite.

The following table describes the fields in the output for the `show ipv6 ipsec sa-policy` command.

Parameter	Description
Policy Name	Specifies the IPsec policy name.
Security Association	Specifies the security association name.

IPsec configuration using EDM

The following section provides procedures to configure Internet Protocol security (IPsec).

Creating an IPsec policy

Use the following procedure to configure an IPsec policy for an IPv6 interface. An IPsec policy defines the level of security for different types of traffic.

The device only supports IPsec for IPv6 traffic, and an interface must support IPv6 to apply IPsec.

About this task

You cannot delete or modify a policy if the policy links to a security association, or if the policy links to a port or VLAN interface. If you need to modify a policy you must first unlink the policy from the security association, and the port or VLAN interface.

Procedure

1. In the navigation pane, expand the following folders: **Configuration > IPv6**.
2. Click **IPSec**.
3. Click the **Policy** tab.
4. Click **Insert**.
5. In the **Name** field, type a policy name.
6. Complete the remaining optional configuration to customize the policy.
7. Click **Insert**.

Policy field descriptions

Use the data in the following table to use the Policy tab.

Name	Description
Name	Specifies the IPsec policy name.
DstAddress	Specifies the remote address. The default is 0::0.
SrcAddress	Specifies the local address. The local address is optional that you can configure to have multiple local addresses for each remote (destination) address. The default is 0::0.
SrcPort	Specifies the source port for TCP and UDP. Leave this field empty to configure any port as the source port. The default is value is 1.
DstPort	Specifies the destination port for TCP and UDP. Leave this field empty to configure any port as the destination port. The default value is 1.
AdminFlag	Enables or disables the policy. The default is disabled.
L4Protocol	Specifies the protocol, as one of the following: <ul style="list-style-type: none"> • TCP • UDP • ICMPv6 • OSPFv3 The default is TCP.
Action	Specifies the action the policy takes. The default is to permit the packet.

Creating an IPsec security association

Use the following procedure to create an IPsec security association. A security association (SA) is a group of algorithms and parameters used to encrypt and authenticate the flow of IP traffic in a particular direction. An SA contains the information IPsec needs to process an IP packet.

The device only supports IPsec for IPv6 traffic, and an interface must support IPv6 to apply IPsec.

About this task

You cannot delete or modify a security association if the security association links to a policy. To modify a parameter in the security association or to delete the security association, you must first unlink the security association from a policy.

You can only unlink a security association from a policy if the policy does not link to an interface. If a policy links to an interface, you must first unlink the policy from the interface, and then unlink the policy from the security association.

Procedure

1. In the navigation pane, expand the following folders: **Configuration > IPv6**.
2. Click **IPSec**.
3. Click the **Security Association** tab.
4. Click **Insert**.
5. In the **Name** field, type a name to identify the SA.
6. In the **SPI** field, type the security parameters index.

 **Note:**

For IPsec to function, each peer must have the same SPI value configured for a particular policy.

7. Complete the remaining optional configuration.
8. Click **Insert**.

Security Association field descriptions

Use the data in the following table to use the **Security Association** tab.

Name	Description
Name	Specifies the name of the security association.
Spi	Specifies the security parameters index (SPI) value, which is a unique value. SPI is a tag IPsec adds to the IP header. The tag enables the system that receives the IP packet to determine under which security association to process the received packet.

Table continues...

Name	Description
	<p>For IPsec to function, each peer must have the same SPI value configured for a particular policy.</p> <p>The default value is 0.</p>
HashAlgorithm	<p>Specifies the authorization algorithm, which includes one of the following values:</p> <ul style="list-style-type: none"> • AES-XCBC-MAC • MD5 • NULL • SHA1 <p>The default authentication algorithm name is MD5.</p>
EncryptAlgorithm	<p>specifies the encryption algorithm value as one of the following:</p> <ul style="list-style-type: none"> • 3DES-CBC • AES-CBC • AES-CTR • NULL—Only use the NULL parameter to debug. Do not use this parameter in any other circumstance. <p>The default encryption algorithm is AES-CBC. You can only access the encryption algorithm parameters if you configure the encapsulation protocol to ESP.</p>
AuthMethod	<p>Specifies the encapsulation protocol:</p> <ul style="list-style-type: none"> • ah—Specifies authentication header. • es—Specifies encapsulation security payload. <p>If you configure the encapsulation protocol as ah, you cannot configure the encryption algorithms and other encryption related attributes. You can only access the encryption algorithm parameters if you configure the encapsulation protocol to es.</p> <p>The default value is es.</p>
Mode	<p>Specifies the mode value as one of the following:</p> <ul style="list-style-type: none"> • transport—Transport mode encapsulates the IP payload and provides a secure connection between two end points. This device only supports transport mode. • tunnel—Tunnel mode encapsulates the entire IP packet and provides a secure tunnel. This device does not support tunnel mode.

Table continues...

Name	Description
	The default is transport mode.
KeyMode	Specifies the key-mode as one of the following: <ul style="list-style-type: none"> • manual • auto The default is manual.
EncryptKeyName	Specifies the encryption key.
EncryptKeyLength	Specifies the numbers of bits used in the encryption key. The key length values are as follows: <ul style="list-style-type: none"> • 3DES-CBC is 48 • AES-CBC is 32, 48, 64 • AES-CTR is 32
HashKeyName	Specifies the authentication key.
HashKeyLength	Specifies the numbers of bits used in the hash key. The key length values are as follows: <ul style="list-style-type: none"> • AES-XCBC-MAC is 32 • MD5 is 32 • SHA1 is 40
LifetimeSeconds	Specifies the lifetime value in seconds. The lifetime determines the traffic that can pass between IPsec peers using a security association before that security association expires. The default lifetime value in seconds is 0, which is infinite.
LifetimeKbytes	Specifies the lifetime value in kilobytes. The lifetime determines the traffic that can pass between IPsec peers using a security association before that security association expires. The default value in kilobytes is 0, which is infinite.

Linking the IPsec security association to an IPsec policy

Use the following procedure to link the security association to an IPsec policy.

The device only supports IPsec for IPv6 traffic, and an interface must support IPv6 to apply IPsec.

About this task

You cannot delete or modify a security association if the security association links to a policy. To modify a parameter in the security association, or to delete the security association, you must first unlink the security association from the policy. You can only unlink a security association from a

policy if the policy does not link to an interface. If a policy links to an interface, you must first unlink the policy from the interface, and then unlink the policy from the security association.

Before you begin

- The IPsec security association and IPsec policy must exist.

Procedure

1. In the navigation pane, expand the following folders: **Configuration > IPv6**.
2. Click **IPSec**.
3. Click the **Policy SA Link** tab.
4. Click **Insert**.
5. In the **PolicyName** field, type the IPsec policy name.
6. In the **SAName** field, type the security association name.
7. Click **Insert**.

Policy SA Link field descriptions

Use the data in the following table to use the **Policy SA Link** tab.

Name	Description
PolicyName	Specifies the name of the IPsec policy.
SAName	Specifies the name of the security association.

Enabling IPsec on an interface

Use the following procedure to enable IPsec on an interface.

The device only supports IPsec for IPv6 traffic, and an interface must support IPv6 to apply IPsec

Procedure

1. Enable IPsec on a VLAN:
 - a. In the navigation pane, expand the **Configuration > VLAN** folders.
 - b. Click **VLANs**.
 - c. Click the **Advanced** tab.
 - d. In the row for the VLAN, double-click the **IpssecEnable** field, and then select **enable**.
 - e. Click **Apply**.
2. Enable IPsec on a port:
 - a. In the Device Physical View, select a port.
 - b. In the navigation pane, expand the **Configuration > Edit > Port** folders.
 - c. Click **General**.

- d. Click the **Interface** tab.
 - e. For the **IpsecEnable** field, select **enable**.
 - f. Click **Apply**.
3. Enable IPsec on a management port:

*** Note:**

This step only applies to hardware with a dedicated, physical management interface.

- a. In the Device Physical View, select the management port.
- b. In the navigation pane, expand the **Configuration > Edit** folders.
- c. Click **Mgmt Port**.
- d. Click the **General** tab.
- e. For the **IpsecEnable** field, select **enable**.
- f. Click **Apply**.

Linking an IPsec policy to an interface

Use the following procedure to link an IPsec policy to an interface, and configure a policy direction. By default, the direction is both.

The device only supports IPsec for IPv6 traffic, and an interface must support IPv6 to apply IPsec.

About this task

You cannot delete or modify an IPsec policy if the policy links to a port or VLAN interface. If you need to modify the policy, first unlink the policy from the port or VLAN interface.

Before you begin

- You must enable IPsec on the interface first, and then you link the IPsec policy to the interface.

Procedure

1. In the navigation pane, expand the following folders: **Configuration > IPv6**.
2. Click **IPSec**.
3. Click the **Interface Policy** tab.
4. Click **Insert**.
5. In the **Name** field, type the name of the IPsec policy.
6. In the **Index** field, click either **Port** , **Vlan**, or **Mgmt Port**, and then select an interface.

*** Note:**

The Mgmt Port button only appears for hardware with a dedicated, physical management interface. If you click this button, EDM automatically populates the Index value.

7. Click **Okay**.
8. Complete the remaining optional configuration.
9. Click **Insert**.

Interface Policy field descriptions

Use the data in the following table to use the Interface Policy tab.

Name	Description
Name	Specifies the IPsec policy name.
IfIndex	Links a policy to either a port, VLAN, or management interface.
IfEnabled	Shows if the IPsec is enabled on the interface and if the administrative state of the policy is enabled.
IfDirection	Specifies the direction you want to protect with IPsec: <ul style="list-style-type: none"> • inbound—Specifies ingress traffic. • outbound—Specifies egress traffic. • bothDirections—Specifies both ingress and egress traffic. <p>The default is bothDirections.</p>

IPsec configuration examples

The following section provides examples to configure Internet Protocol Security (IPsec).

IPsec configuration example

Review the following information to understand IPsec configuration.

Use the following steps to configure IPsec.

1. Create and configure an IPsec policy under IPv6.
2. Enable the policy.
3. Create an IPsec security association to correspond with the IPsec policy.
4. Configure the key mode format.
5. Configure the security association.
6. Link the IPsec security association to the IPsec policy.
7. Enable the IPsec policy on the interface.
8. Link the IPsec policy with the interface.

9. Enable the IPsec on the interface that links to the IPsec policy.

For an example configuration and for more information on IPsec OSPFv3 and OSPFv3 virtual link, see *Configuring IPv6 Routing*.

Create a policy named `newpolicy` with a security association named `new_sa` on VLAN 100.

The following displays the IPv6 IPsec policy configuration:

```
ipv6 ipsec policy newpolicy raddr 2001:db8:0:0:0:0:0:1
ipv6 ipsec policy newpolicy laddr 2001:db8:0:0:0:0:0:15
ipv6 ipsec policy newpolicy protocol tcp sport 4 dport 5
ipv6 ipsec policy newpolicy action permit
```

The following example displays the IPv6 IPsec security association:

```
ipv6 ipsec security-association new_sa
ipv6 ipsec security-association new_sa key-mode manual
ipv6 ipsec security-association new_sa mode transport
ipv6 ipsec security-association new_sa encap-proto ESP
ipv6 ipsec security-association new_sa Encrpt-algo 3DES-CBC encrypt-key
11111111111111111111111111111111 KeyLength 24
ipv6 ipsec security-association new_sa auth-algo SHA1 auth-key 11111111111111111111
KeyLength 20
ipv6 ipsec security-association new_sa spi 1
ipv6 ipsec security-association new_sa lifetime seconds 1000
```

IPsec with ICMPv6 configuration example

The following displays configuration of IPsec with ICMPv6.

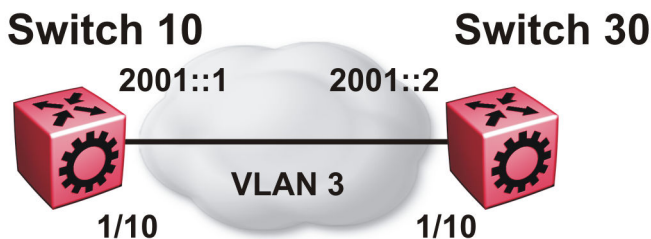

Figure 23: IPsec configuration with ICMPv6

Switch 10 security association configuration

The following example displays the configuration of the security association on Switch 10.

```
ipv6 ipsec security-association icmp
ipv6 ipsec security-association icmp encap-proto ESP
ipv6 ipsec security-association icmp mode transport
ipv6 ipsec security-association icmp spi 1
ipv6 ipsec security-association icmp auth-algo SHA1 auth-key
1234567890123456789012345678901234567890 keyLength 40
ipv6 ipsec security-association icmp Encrpt-algo AES-CBC EncrptKey
12345678901234567890123456789012 keyLength 32
ipv6 ipsec security-association icmp key-mode manual
```

```
ipv6 ipsec security-association icmp lifetime seconds 1
ipv6 ipsec security-association icmp lifetime bytes 1
```

Switch 10 policy configuration

The following example displays the configuration of the security policy on Switch 10.

```
ipv6 ipsec policy ICMP_Policy
ipv6 ipsec policy ICMP_Policy admin enable
ipv6 ipsec policy ICMP_Policy raddr 2001::2
ipv6 ipsec policy ICMP_Policy laddr 2001::1
ipv6 ipsec policy ICMP_Policy protocol icmpv6
ipv6 ipsec policy ICMP_Policy action permit
ipv6 ipsec policy ICMP_Policy security-association icmp
```

Switch 10 interface configuration

The following example displays the configuration of IPsec on slot/port 1/10.

```
interface gigabitEthernet 1/10
no shut
ipv6 interface vlan 3
ipv6 interface address 2000::1
ipv6 interface enable
ipv6 ipsec policy ICMP_Policy dir both
ipv6 ipsec enable
```

Switch 10 VLAN configuration

The following example displays the creation and configuration of VLAN 3 with IPsec.

```
interface gigabitEthernet 1/10
no shut
exit
vlan create 3 type port-mstprstp 3
vlan members add 3 1/10 portmember
interface vlan 3
ipv6 interface enable
ipv6 interface address 2000::1
ipv6 ipsec policy ICMP_Policy dir both
ipv6 ipsec enable
```

Switch 30 security association configuration

The following example displays the configuration of the security association on Switch 30.

```
ipv6 ipsec security-association icmp
ipv6 ipsec security-association icmp encap-proto ESP
ipv6 ipsec security-association icmp mode transport
ipv6 ipsec security-association icmp spi 1
ipv6 ipsec security-association icmp auth-algo SHA1 auth-key
1234567890123456789012345678901234567890 keyLength 40
ipv6 ipsec security-association icmp Encrpt-algo AES-CBC EncrptKey
12345678901234567890123456789012 keyLength 32
ipv6 ipsec security-association icmp key-mode manual
ipv6 ipsec security-association icmp lifetime seconds 1
ipv6 ipsec security-association icmp lifetime bytes 1
```

Switch 30 policy configuration

The following example displays the configuration of the security policy on Switch 30.

```
ipv6 ipsec policy ICMP_Policy
ipv6 ipsec policy ICMP_Policy admin enable
ipv6 ipsec policy ICMP_Policy raddr 2001::1
ipv6 ipsec policy ICMP_Policy laddr 2001::2
```

```

ipv6 ipsec policy ICMP_Policy action permit
ipv6 ipsec policy ICMP_Policy protocol icmpv6
ipv6 ipsec policy ICMP_Policy security-association icmp

```

Switch 30 interface configuration

The following example displays the configuration of IPsec on slot/port 1/10.

```

interface gigabitEthernet 1/10
no shut
ipv6 interface enable
ipv6 interface vlan 3
ipv6 interface address 2001::2
ipv6 ipsec policy ICMP_Policy dir both
ipv6 ipsec enable

```

Switch 30 VLAN configuration

The following example displays the creation and configuration of VLAN 3 with IPsec.

```

interface gigabitEthernet 1/10
no shut
exit
vlan create 3 type port-mstprstp 0
vlan members add 3 1/20
interface vlan 3
ipv6 interface enable
ipv6 interface address 2001::2
ipv6 ipsec policy ICMP_Policy dir both
ipv6 ipsec enable

```

OSPFv3 IPsec configuration example

The following example displays a network using IPsec used with OSPFv3.

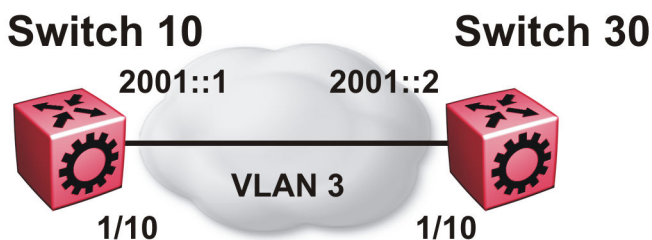

The following example displays the configuration of IPsec with OSPFv3. For OSPFv3 conceptual and procedural information, see *Configuring IPv6 Routing*.

Switch 10 security associations

The following example displays the configuration of security associations for OSPFv3 for Switch 10.

```

ipv6 ipsec security-association ospf1
ipv6 ipsec security-association ospf1 encap-proto ESP
ipv6 ipsec security-association ospf1 mode transport

```



```

ipv6 ipsec security-association ospf1 spi 1
ipv6 ipsec security-association ospf1 auth-algo MD5 auth-key
12345678901234567890123456789012 keyLength 32
ipv6 ipsec security-association ospf1 Encrpt-algo AES-CTR EncrptKey
12345678901234567890123456789012 keyLength 32
ipv6 ipsec security-association ospf1 key-mode manual
ipv6 ipsec security-association ospf1 lifetime seconds 1
ipv6 ipsec security-association ospf1 lifetime bytes 1

ipv6 ipsec security-association ospf2
ipv6 ipsec security-association ospf2 encap-proto ESP
ipv6 ipsec security-association ospf2 mode transport
ipv6 ipsec security-association ospf2 spi 2
ipv6 ipsec security-association ospf2 auth-algo MD5 auth-key
12345678901234567890123456789012 keyLength 32
ipv6 ipsec security-association ospf2 Encrpt-algo AES-CTR EncrptKey
12345678901234567890123456789012 keyLength 32
ipv6 ipsec security-association ospf2 key-mode manual
ipv6 ipsec security-association ospf2 lifetime seconds 1
ipv6 ipsec security-association ospf2 lifetime bytes 1

ipv6 ipsec security-association ospf3
ipv6 ipsec security-association ospf3 encap-proto ESP
ipv6 ipsec security-association ospf3 mode transport
ipv6 ipsec security-association ospf3 spi 3
ipv6 ipsec security-association ospf3 auth-algo MD5 auth-key
12345678901234567890123456789012 keyLength 32
ipv6 ipsec security-association ospf3 Encrpt-algo AES-CTR EncrptKey
12345678901234567890123456789012 keyLength 32
ipv6 ipsec security-association ospf3 key-mode manual
ipv6 ipsec security-association ospf3 lifetime seconds 1
ipv6 ipsec security-association ospf3 lifetime bytes 1

ipv6 ipsec security-association ospf4
ipv6 ipsec security-association ospf4 encap-proto ESP
ipv6 ipsec security-association ospf4 mode transport
ipv6 ipsec security-association ospf4 spi 4
ipv6 ipsec security-association ospf4 auth-algo MD5 auth-key
12345678901234567890123456789012 keyLength 32
ipv6 ipsec security-association ospf4 Encrpt-algo AES-CTR EncrptKey
12345678901234567890123456789012 keyLength 32
ipv6 ipsec security-association ospf4 key-mode manual
ipv6 ipsec security-association ospf4 lifetime seconds 1
ipv6 ipsec security-association ospf4 lifetime bytes 1

ipv6 ipsec security-association ospf5
ipv6 ipsec security-association ospf5 encap-proto ESP
ipv6 ipsec security-association ospf5 mode transport
ipv6 ipsec security-association ospf5 spi 5
ipv6 ipsec security-association ospf5 auth-algo MD5 auth-key
12345678901234567890123456789012 keyLength 32
ipv6 ipsec security-association ospf5 Encrpt-algo AES-CTR EncrptKey
12345678901234567890123456789012 keyLength 32
ipv6 ipsec security-association ospf5 key-mode manual
ipv6 ipsec security-association ospf5 lifetime seconds 1
ipv6 ipsec security-association ospf5 lifetime bytes 1

ipv6 ipsec security-association ospf6
ipv6 ipsec security-association ospf6 encap-proto ESP
ipv6 ipsec security-association ospf6 mode transport
ipv6 ipsec security-association ospf6 spi 6
ipv6 ipsec security-association ospf6 auth-algo MD5 auth-key
12345678901234567890123456789012 keyLength 32
ipv6 ipsec security-association ospf6 Encrpt-algo AES-CTR EncrptKey
12345678901234567890123456789012 keyLength 32

```

```

ipv6 ipsec security-association ospf6 key-mode manual
ipv6 ipsec security-association ospf6 lifetime seconds 1
ipv6 ipsec security-association ospf6 lifetime bytes 1

```

Switch 10 policy configuration

The following example displays the configuration of policies on Switch 10. The link local address is fe80:0:0:0:b2ad:aaff:fe43:100 and the remote link local address is fe80:0:0:0:b2ad:aaff:fe43:4d00. The following displays the policy with the laddr configured to the link local address and raddr configured to the remote link local address, with the direction configured as outbound.

```

ipv6 ipsec policy ospf1
ipv6 ipsec policy ospf1 admin enable
ipv6 ipsec policy ospf1 raddr fe80:0:0:0:b2ad:aaff:fe43:4d00
ipv6 ipsec policy ospf1 laddr fe80:0:0:0:b2ad:aaff:fe43:100
ipv6 ipsec policy ospf1 protocol ospfv3
ipv6 ipsec policy ospf1 action permit

```

The following example displays the configuration of policies on Switch 10. The link local address is fe80:0:0:0:b2ad:aaff:fe43:100 and the remote link local address is fe80:0:0:0:b2ad:aaff:fe43:4d00. The following displays the policy with the laddr configured to the link local address and raddr configured to the remote link local address, with the direction configured as inbound.

For a policy direction of inbound, laddr and raddr are reversed before storing to the stack. Because of this, even though the policy requires you to configure the laddr as the remote link local address, you need to configure laddr as the link local address in the configuration.

```

ipv6 ipsec policy ospf2
ipv6 ipsec policy ospf2 admin enable
ipv6 ipsec policy ospf2 raddr fe80:0:0:0:b2ad:aaff:fe43:4d00
ipv6 ipsec policy ospf2 laddr fe80:0:0:0:b2ad:aaff:fe43:100
ipv6 ipsec policy ospf2 protocol ospfv3
ipv6 ipsec policy ospf2 action permit

```

Laddr is configured to the link local and raddr is configured to ff02::05 with the direction configured as outbound.

```

ipv6 ipsec policy ospf3
ipv6 ipsec policy ospf3 admin enable
ipv6 ipsec policy ospf3 raddr ff02::05
ipv6 ipsec policy ospf3 laddr fe80:0:0:0:b2ad:aaff:fe43:100
ipv6 ipsec policy ospf3 protocol ospfv3
ipv6 ipsec policy ospf3 action permit

```

Laddr is configured to the remote link local and raddr is configured to ff02::05 with the direction configured as inbound.

```

ipv6 ipsec policy ospf4
ipv6 ipsec policy ospf4 admin enable
ipv6 ipsec policy ospf4 raddr fe80:0:0:0:b2ad:aaff:fe43:4d00
ipv6 ipsec policy ospf4 laddr ff02::05
ipv6 ipsec policy ospf4 protocol ospfv3
ipv6 ipsec policy ospf4 action permit

```

Laddr is configured to the link local and raddr is configured to ff02::06 with the direction as outbound.

```

ipv6 ipsec policy ospf5
ipv6 ipsec policy ospf5 admin enable
ipv6 ipsec policy ospf5 raddr ff02::06
ipv6 ipsec policy ospf5 fe80:0:0:0:b2ad:aaff:fe43:100
ipv6 ipsec policy ospf5 protocol ospfv3
ipv6 ipsec policy ospf5 action permit

```

Laddr is configured to the remote link local and raddr is configured to ff02::06 with the direction configured as inbound.

```
ipv6 ipsec policy ospf6
ipv6 ipsec policy ospf6 admin enable
ipv6 ipsec policy ospf6 raddr fe80:0:0:0:b2ad:aaff:fe43:4d00
ipv6 ipsec policy ospf6 laddr ff02::06
ipv6 ipsec policy ospf6 protocol ospfv3
ipv6 ipsec policy ospf6 action permit
```

Switch 10 link table configuration

The following example displays the linking of the policy with the security association on Switch 10.

```
ipv6 ipsec policy ospf1 security-association ospf1
ipv6 ipsec policy ospf2 security-association ospf2
ipv6 ipsec policy ospf3 security-association ospf3
ipv6 ipsec policy ospf4 security-association ospf4
ipv6 ipsec policy ospf5 security-association ospf5
ipv6 ipsec policy ospf6 security-association ospf6
```

Switch 10 OSPFv3 configuration

The following example displays the OSPFv3 configuration on Switch 10.

```
router ospf ipv6-enable
router ospf
ipv6 router-id 1.1.1.1
ipv6 area 0.0.0.1
```

Switch 10 interface configuration

The following example displays the interface configuration on slot/port 1/10.

```
interface gigabitEthernet 1/10
no shut
ipv6 interface vlan 3
ipv6 interface address 2000::1/64
ipv6 interface enable
ipv6 ospf area 0.0.0.1
ipv6 ospf enable
ipv6 ipsec policy ospf1 dir out
ipv6 ipsec policy ospf2 dir in
ipv6 ipsec policy ospf3 dir out
ipv6 ipsec policy ospf4 dir in
ipv6 ipsec policy ospf5 dir out
ipv6 ipsec policy ospf6 dir in
ipv6 ipsec enable
```

Switch 10 VLAN configuration

The following example displays the creation of VLAN 3 and the configuration of IPsec on VLAN 3.

```
interface gigabitEthernet 1/10
no shut
exit
vlan create 3 type port-mstprstp 3
vlan members add 3 1/10 portmember
interface vlan 3
ipv6 interface enable
ipv6 interface address 2000::1/64
ipv6 ospf area 0.0.0.1
ipv6 ospf enable
ipv6 ipsec policy ospf1 dir out
ipv6 ipsec policy ospf2 dir in
ipv6 ipsec policy ospf3 dir out
```

```

ipv6 ipsec policy ospf4 dir in
ipv6 ipsec policy ospf5 dir out
ipv6 ipsec policy ospf6 dir in
ipv6 ipsec enable

```

Switch 30 security associations

The following example displays the configuration of security associations for OSPFv3 for Switch 30.

```

ipv6 ipsec security-association ospf1 auth-algo MD5 auth-key
12345678901234567890123456789012 keyLength 32
ipv6 ipsec security-association ospf1 Encrpt-algo AES-CTR EncrptKey
12345678901234567890123456789012 keyLength 32
ipv6 ipsec security-association ospf1 key-mode manual
ipv6 ipsec security-association ospf1 lifetime seconds 1
ipv6 ipsec security-association ospf1 lifetime bytes 1

ipv6 ipsec security-association ospf2
ipv6 ipsec security-association ospf2 encap-proto ESP
ipv6 ipsec security-association ospf2 mode transport
ipv6 ipsec security-association ospf2 spi 2
ipv6 ipsec security-association ospf2 auth-algo MD5 auth-key
12345678901234567890123456789012 keyLength 32
ipv6 ipsec security-association ospf2 Encrpt-algo AES-CTR EncrptKey
12345678901234567890123456789012 keyLength 32
ipv6 ipsec security-association ospf2 key-mode manual
ipv6 ipsec security-association ospf2 lifetime seconds 1
ipv6 ipsec security-association ospf2 lifetime bytes 1

ipv6 ipsec security-association ospf3
ipv6 ipsec security-association ospf3 encap-proto ESP
ipv6 ipsec security-association ospf3 mode transport
ipv6 ipsec security-association ospf3 spi 3
ipv6 ipsec security-association ospf3 auth-algo MD5 auth-key
12345678901234567890123456789012 keyLength 32
ipv6 ipsec security-association ospf3 Encrpt-algo AES-CTR EncrptKey
12345678901234567890123456789012 keyLength 32
ipv6 ipsec security-association ospf3 key-mode manual
ipv6 ipsec security-association ospf3 lifetime seconds 1
ipv6 ipsec security-association ospf3 lifetime bytes 1

ipv6 ipsec security-association ospf4
ipv6 ipsec security-association ospf4 encap-proto ESP
ipv6 ipsec security-association ospf4 mode transport
ipv6 ipsec security-association ospf4 spi 4
ipv6 ipsec security-association ospf4 auth-algo MD5 auth-key
12345678901234567890123456789012 keyLength 32
ipv6 ipsec security-association ospf4 Encrpt-algo AES-CTR EncrptKey
12345678901234567890123456789012 keyLength 32
ipv6 ipsec security-association ospf4 key-mode manual
ipv6 ipsec security-association ospf4 lifetime seconds 1
ipv6 ipsec security-association ospf4 lifetime bytes 1

ipv6 ipsec security-association ospf5
ipv6 ipsec security-association ospf5 encap-proto ESP
ipv6 ipsec security-association ospf5 mode transport
ipv6 ipsec security-association ospf5 spi 5
ipv6 ipsec security-association ospf5 key-mode manual
ipv6 ipsec security-association ospf5 lifetime seconds 1
ipv6 ipsec security-association ospf5 lifetime bytes 1

ipv6 ipsec security-association ospf6
ipv6 ipsec security-association ospf6 encap-proto ESP
ipv6 ipsec security-association ospf6 mode transport
ipv6 ipsec security-association ospf6 spi 6

```

```

ipv6 ipsec security-association ospf6 auth-algo MD5 auth-key
12345678901234567890123456789012 keyLength 32
ipv6 ipsec security-association ospf6 Encrpt-algo AES-CTR EncrptKey
12345678901234567890123456789012 keyLength 32
ipv6 ipsec security-association ospf6 key-mode manual
ipv6 ipsec security-association ospf6 lifetime seconds 1
ipv6 ipsec security-association ospf6 lifetime bytes 1

```

Switch 30 policy configuration

In the example, the local address is fe80:0:0:0:b2ad:aaff:fe43:4d00, and the remote address is fe80:0:0:0:b2ad:aaff:fe43:100. The policy has the laddr configured to the link local address and the raddr is configured to the remote link local address with the direction configured to outbound.

```

ipv6 ipsec policy ospf1
ipv6 ipsec policy ospf1 admin enable
ipv6 ipsec policy ospf1 raddr fe80:0:0:0:b2ad:aaff:fe43:100
ipv6 ipsec policy ospf1 laddr fe80:0:0:0:b2ad:aaff:fe43:4d00
ipv6 ipsec policy ospf1 protocol ospfv3
ipv6 ipsec policy ospf1 action permit

```

Laddr is configured to the remote link local address and raddr is configured to the local link local address with the direction configured to inbound.

```

ipv6 ipsec policy ospf2
ipv6 ipsec policy ospf2 admin enable
ipv6 ipsec policy ospf2 raddr fe80:0:0:0:b2ad:aaff:fe43:100
ipv6 ipsec policy ospf2 laddr fe80:0:0:0:b2ad:aaff:fe43:4d00
ipv6 ipsec policy ospf2 protocol ospfv3
ipv6 ipsec policy ospf2 action permit

```

Laddr is configured to the link local address and raddr is configured to ff02::05 with the direction configured to outbound.

```

ipv6 ipsec policy ospf3
ipv6 ipsec policy ospf3 admin enable
ipv6 ipsec policy ospf3 raddr ff02::05
ipv6 ipsec policy ospf3 laddr fe80:0:0:0:b2ad:aaff:fe43:4d00
ipv6 ipsec policy ospf3 protocol ospfv3
ipv6 ipsec policy ospf3 action permit

```

Laddr is configured to the remote link local address and the raddr is configured to ff02::05 with the direction configured to inbound.

```

ipv6 ipsec policy ospf4
ipv6 ipsec policy ospf4 admin enable
ipv6 ipsec policy ospf4 raddr fe80:0:0:0:b2ad:aaff:fe43:100
ipv6 ipsec policy ospf4 laddr ff02::05
ipv6 ipsec policy ospf4 protocol ospfv3
ipv6 ipsec policy ospf4 action permit

```

Laddr is configured to the link local address and raddr is configured to ff02::06 with the direction configured to outbound.

```

ipv6 ipsec policy ospf5
ipv6 ipsec policy ospf5 admin enable
ipv6 ipsec policy ospf5 raddr ff02::06
ipv6 ipsec policy ospf5 laddr fe80:0:0:0:b2ad:aaff:fe43:4d00
ipv6 ipsec policy ospf5 protocol ospfv3
ipv6 ipsec policy ospf5 action permit

```

Laddr is configured to the remote link local address and raddr is configured to ff02::06 with the direction configured to inbound.

```
ipv6 ipsec policy ospf6
ipv6 ipsec policy ospf6 admin enable
ipv6 ipsec policy ospf6 raddr fe80:0:0:0:b2ad:aaff:fe43:100
ipv6 ipsec policy ospf6 laddr ff02::06
ipv6 ipsec policy ospf6 protocol ospfv3
ipv6 ipsec policy ospf6 action permit
```

Switch 30 link table configuration

The following example displays the linking of the policy with the security association on Switch 30.

```
ipv6 ipsec policy ospf1 security-association ospf1
ipv6 ipsec policy ospf2 security-association ospf2
ipv6 ipsec policy ospf3 security-association ospf4
ipv6 ipsec policy ospf4 security-association ospf3
ipv6 ipsec policy ospf5 security-association ospf5
ipv6 ipsec policy ospf6 security-association ospf6
```

Switch 30 OSPFv3 configuration

The following example displays the OSPFv3 configuration on Switch 30.

```
router ospf ipv6-enable
router ospf
ipv6 router-id 2.2.2.2
ipv6 area 0.0.0.1
```

Switch 30 interface configuration

The following example displays the interface configuration on slot/port 1/10.

```
interface gigabitEthernet 1/10
no shut
ipv6 interface vlan 3
ipv6 interface address 2001::2/64
ipv6 interface enable
ipv6 ospf area 0.0.0.1
ipv6 ospf enable
ipv6 ipsec policy ospf1 dir out
ipv6 ipsec policy ospf2 dir in
ipv6 ipsec policy ospf3 dir out
ipv6 ipsec policy ospf4 dir in
ipv6 ipsec policy ospf5 dir out
ipv6 ipsec policy ospf6 dir in
ipv6 ipsec enable
```

Switch 30 VLAN configuration

The following example displays the creation of VLAN 3 and the configuration of IPsec on VLAN 3.

```
interface gigabitEthernet 1/10
no shut
exit
minvlan create 3 type port-mstprstp 0
vlan members add 3 1/10 portmember
interface vlan 3
ipv6 interface enable
ipv6 interface address 2001::2/64
ipv6 ospf area 0.0.0.1
ipv6 ospf enable
ipv6 ipsec policy ospf1 dir out
```

```

ipv6 ipsec policy ospf2 dir in
ipv6 ipsec policy ospf3 dir out
ipv6 ipsec policy ospf4 dir in
ipv6 ipsec policy ospf5 dir out
ipv6 ipsec policy ospf6 dir in
ipv6 ipsec enable

```

OSPFv3 virtual link IPsec configuration example

The following example displays a network using IPsec with OSPFv3 virtual link.

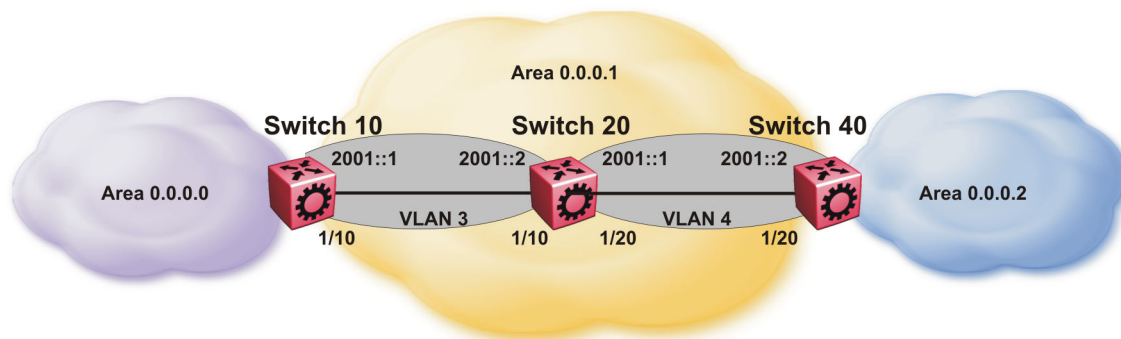

Figure 24: OSPFv3 virtual link with IPsec configuration

The following example displays the configuration of IPsec with OSPFv3 virtual link. For OSPFv3 conceptual and procedural information, see *Configuring IPv6 Routing*.

Switch 10 security association configuration

The following example displays the configuration of security associations for OSPFv3 for Switch 10.

```

ipv6 ipsec security-association ospf1
ipv6 ipsec security-association ospf1 encap-proto ESP
ipv6 ipsec security-association ospf1 mode transport
ipv6 ipsec security-association ospf1 spi 1
ipv6 ipsec security-association ospf1 auth-algo MD5 auth-key
12345678901234567890123456789012 keyLength 32
ipv6 ipsec security-association ospf1 Encrpt-algo AES-CTR EncrptKey
12345678901234567890123456789012 keyLength 32
ipv6 ipsec security-association ospf1 key-mode manual
ipv6 ipsec security-association ospf1 lifetime seconds 1
ipv6 ipsec security-association ospf1 lifetime bytes 1

```

Switch 10 OSPFv3 configuration

The following example displays the OSPFv3 configuration on Switch 10.

```

router ospf ipv6-enable
ipv6 forwarding
router ospf
ipv6 router-id 1.1.1.1
ipv6 area 0.0.0.1
ipv6 as-boundary-router
ipv6 area 0.0.0.0

```

Switch 10 virtual link and policy configuration

The following example displays the configuration of a OSPFv3 virtual link.

```
ipv6 area virtual-link 0.0.0.1 3.3.3.3
ipv6 area virtual-link 0.0.0.1 3.3.3.3 ipsec
ipv6 area virtual-link 0.0.0.1 3.3.3.3 ipsec security-association ospf1
ipv6 area virtual-link 0.0.0.1 3.3.3.3 ipsec action permit
ipv6 area virtual-link 0.0.0.1 3.3.3.3 ipsec direction both
ipv6 area virtual-link 0.0.0.1 3.3.3.3 ipsec enable
```

Switch 10 interface configuration

The following example displays the interface configuration on slot/port 1/10.

```
interface gigabitEthernet 1/10
no shut
ipv6 interface vlan 3
ipv6 interface address 2000::1/64
ipv6 interface enable
ipv6 ospf area 0.0.0.1
ipv6 ospf enable
```

Switch 10 VLAN configuration

The following example displays the creation of VLAN 3 and the configuration of IPsec on VLAN 3.

```
interface gigabitEthernet 1/10
no shut
exit
vlan create 3 type port-mstprstp 3
vlan members add 3 1/10 port-member
interface vlan 3
ipv6 interface enable
ipv6 interface address 2000::1/64
ipv6 ospf area 0.0.0.1
ipv6 ospf enable
```

Switch 20 OSPFv3 configuration

The following example displays the OSPFv3 configuration on Switch 20.

```
router ospf ipv6-enable
ipv6 forwarding
router ospf
ipv6 router-id 2.2.2.2
ipv6 area 0.0.0.1
```

Switch 20 interface configuration

The following example displays the interface configuration on slot/port 1/10 and 1/20.

```
interface gigabitEthernet 1/10
no shut
ipv6 interface vlan 3
ipv6 interface address 2000::2/64
ipv6 interface enable
ipv6 ospf area 0.0.0.1
ipv6 ospf enable

interface gigabitEthernet 1/20
no shut
ipv6 interface vlan 4
ipv6 interface address 2001::1/64
ipv6 interface enable
```



```
ipv6 ospf area 0.0.0.1
ipv6 ospf enable
```

Switch 20 VLAN configuration

The following example displays the creation of VLAN 3 and the configuration of IPsec on VLAN 3 and VLAN 4.

```
interface gigabitEthernet 1/10
no shut
exit
vlan create 3 type port-mstprstp 0
vlan members add 3 1/10 portmember
interface vlan 3
ipv6 interface enable
ipv6 interface address 2000::2/64
ipv6 ospf area 0.0.0.1
ipv6 ospf enable

interface gigabitEthernet 1/20
no shut
exit
vlan create 4 type port-mstprstp 0
vlan members add 4 1/20 portmember
interface vlan 4
ipv6 interface enable
ipv6 interface address 2001::1/64
ipv6 ospf area 0.0.0.1
ipv6 ospf enable
```

Switch 40 security association configuration

The following example displays the configuration of security associations for OSPFv3 for Switch 40.

```
ipv6 ipsec security-association ospf1
ipv6 ipsec security-association ospf1 encap-proto ESP
ipv6 ipsec security-association ospf1 mode transport
ipv6 ipsec security-association ospf1 spi 1
ipv6 ipsec security-association ospf1 auth-algo MD5 auth-key
12345678901234567890123456789012 keyLength 32
ipv6 ipsec security-association ospf1 Encrpt-algo AES-CTR EncrptKey
12345678901234567890123456789012 keyLength 32
ipv6 ipsec security-association ospf1 key-mode manual
ipv6 ipsec security-association ospf1 lifetime seconds 1
ipv6 ipsec security-association ospf1 lifetime bytes 1
```

Switch 40 OSPFv3 configuration

The following example displays the OSPFv3 configuration on Switch 40.

```
router ospf ipv6-enable
ipv6 forwarding
router ospf
ipv6 router-id 3.3.3.3
ipv6 area 0.0.0.1
ipv6 area 0.0.0.2
ipv6 as-boundary-router
```

Switch 40 OSPFv3 virtual link and policy configuration

The following example displays the configuration of a OSPFv3 virtual link.

```
ipv6 area virtual-link 0.0.0.1 1.1.1.1
ipv6 area virtual-link 0.0.0.1 1.1.1.1 ipsec
ipv6 area virtual-link 0.0.0.1 1.1.1.1 ipsec security-association ospf1
ipv6 area virtual-link 0.0.0.1 1.1.1.1 ipsec action permit
```

```
ipv6 area virtual-link 0.0.0.1 1.1.1.1 ipsec direction both
ipv6 area virtual-link 0.0.0.1 1.1.1.1 ipsec enable
```

Switch 40 interface configuration

The following example displays the interface configuration on slot/port 1/20.

```
interface gigabitEthernet 1/20
no shut
ipv6 interface vlan 4
ipv6 interface address 2001::2/64
ipv6 interface enable
ipv6 ospf area 0.0.0.1
ipv6 ospf enable
```

Switch 40 VLAN interface configuration

The following example displays the creation of VLAN 4 and the configuration of IPsec on VLAN 4.

```
interface gigabitEthernet 1/20
no shut
exit
vlan create 4 type port-mstprstp 0
vlan members add 4 1/20
interface vlan 4
ipv6 interface enable
ipv6 interface address 2001::2/64
ipv6 ospf area 0.0.0.1
ipv6 ospf enable
```

IPsec configuration of TCP

The following example displays the configuration of IPsec for TCP.

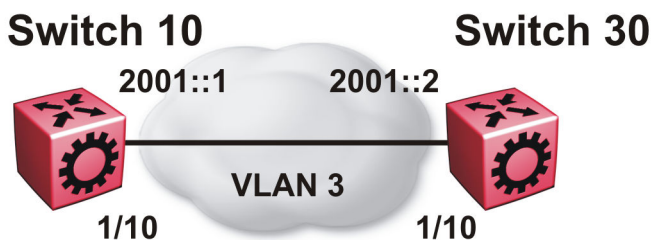

Switch 10 IPsec security association configuration

The following example displays the configuration of the IPsec security association for TCP for Switch 10.

```
ipv6 ipsec security-association tcp1
ipv6 ipsec security-association tcp1 encap-proto ESP
ipv6 ipsec security-association tcp1 mode transport
ipv6 ipsec security-association tcp1 spi 100
ipv6 ipsec security-association tcp1 auth-algo MD5 auth-key
12345678901234567890123456789012 keyLength 32
```

```

ipv6 ipsec security-association tcp1 Encrpt-algo AES-CTR EncrptKey
12345678901234567890123456789012 keyLength 32
ipv6 ipsec security-association tcp1 key-mode manual
ipv6 ipsec security-association tcp1 lifetime seconds 1
ipv6 ipsec security-association tcp1 lifetime bytes 1

```

Switch 10 IPsec policy configuration

The following example displays the configuration of the IPsec policy for TCP for Switch 10.

```

ipv6 ipsec policy tcp1
ipv6 ipsec policy tcp1 admin enable
ipv6 ipsec policy tcp1 raddr 2000::2
ipv6 ipsec policy tcp1 raddr 2000::2 laddr 2000::1
ipv6 ipsec policy tcp1 raddr 2000::2 protocol tcp sport 23 dport 23
ipv6 ipsec policy tcp1 raddr 2000::2 action permit

```

Switch 10 linking the IPsec policy with the IPsec security association

The following example displays the linking of the IPsec policy with the IPsec security association

```

ipv6 ipsec policy tcp1 security-association tcp1

```

Switch 10 interface configuration

The following examples displays the configuration of IPsec for slot/port 1/10.

```

interface gigabitEthernet 1/10
no shut
ipv6 interface vlan 3
ipv6 interface address 2000::1/64
ipv6 interface enable
ipv6 ipsec policy tcp1 dir both
ipv6 ipsec enable

```

Switch 10 VLAN configuration

The following example displays the creation and configuration of VLAN 3.

```

interface gigabitEthernet 1/10
no shut
exit
vlan create 3 type port-mstprstp 3
vlan members add 3 1/10 portmember
interface vlan 3
ipv6 interface enable
ipv6 interface address 2000::1/64
ipv6 ipsec policy tcp1 dir both
ipv6 ipsec enable

```

Switch 30 IPsec security association configuration

The following example displays the configuration of the IPsec security association for TCP for Switch 10.

```

ipv6 ipsec security-association tcp1
ipv6 ipsec security-association tcp1 encap-proto ESP
ipv6 ipsec security-association tcp1 mode transport
ipv6 ipsec security-association tcp1 spi 100
ipv6 ipsec security-association tcp1 auth-algo MD5 auth-key
12345678901234567890123456789012 keyLength 32
ipv6 ipsec security-association tcp1 Encrpt-algo AES-CTR EncrptKey
12345678901234567890123456789012 keyLength 32
ipv6 ipsec security-association tcp1 key-mode manual
ipv6 ipsec security-association tcp1 lifetime seconds 1
ipv6 ipsec security-association tcp1 lifetime bytes 1

```

Switch 30 IPsec policy configuration

The following example displays the configuration of the IPsec policy for TCP for Switch 10.

```
ipv6 ipsec policy tcpl
ipv6 ipsec policy tcpl admin enable
ipv6 ipsec policy tcpl raddr 2000::1
ipv6 ipsec policy tcpl raddr 2000::1 laddr 2000::2
ipv6 ipsec policy tcpl raddr 2000::1 protocol tcp sport 23 dport 23
ipv6 ipsec policy tcpl raddr 2000::1 action permit
```

Switch 30 linking the IPsec policy with the IPsec security association

The following example displays the linking of the IPsec policy with the IPsec security association

```
ipv6 ipsec policy tcpl security-association tcpl
```

Switch 30 interface configuration

The following examples displays the configuration of IPsec for slot/port 1/10.

```
interface gigabitEthernet 1/10
no shut
ipv6 interface vlan 3
ipv6 interface address 2000::2/64
ipv6 interface enable
ipv6 ipsec policy tcpl dir both
ipv6 ipsec enable
```

Switch 30 VLAN configuration

The following example displays the creation and configuration of VLAN 3.

```
interface gigabitEthernet 1/10
no shut
exit
vlan create 3 type port-mstprstp 3
vlan members add 3 1/10 portmember
interface vlan 3
ipv6 interface enable
ipv6 interface address 2000::2/64
ipv6 ipsec policy tcpl dir both
ipv6 ipsec enable
```

Chapter 7: MACsec

The following sections describe Media Access Control Security (MACsec) and its configuration.

*** Note:**

This feature is not supported on all hardware platforms. If you do not see commands for this feature in the command list or EDM, the feature is not supported on your hardware. For more information about feature support, see *Release Notes*.

MACsec fundamentals

MAC Security (MACsec) is based on the IEEE 802.1ae standard that allows authorized systems in a network to transmit data confidentially and to protect against data transmitted or modified by unauthorized devices.

You can use MACsec for core and enterprise edge switches to secure site-to-site connectivity between data centers, provide data security on links that run over public ground, or outside the physically secure boundaries of a site. You can use MACsec on access switches to secure host to switch connectivity, and host to switch connectivity in an environment where both trusted and untrusted hosts co-exist.

In addition to host level authentication, MACsec capable LANs provide data origin authentication, data confidentiality, and data integrity between authenticated hosts or systems. MACsec protects data from external hacking while the data passes through the public network to reach a receiver host.

MACsec enabled hosts encrypt and decrypt every frame exchanged between them using a MACsec key. The source MACsec host encrypts data frames and destination MACsec host decrypts the frames, ensuring delivery of the frame in its original condition to the recipient host. This ensures secure data communication.

You can configure MACsec encryption over any type of point-to-point Ethernet or emulated Ethernet connection, which includes:

- Dark fiber
- Conventional wavelength-division multiplexing/dense wavelength-division multiplexing (CWDM/DWDM) service
- Multiprotocol label switching (MPLS) point-to-point (ELINE)
- Provider Backbone Bridge Traffic Engineering (PBB-TE)

You can configure MACsec on a physical port or on a trunk group level, which includes: Split MultiLink Trunking (SMLT), distributed MultiLink Trunking (DMLT), or Link aggregate group (LAG).

You configure a pre-shared key on either end of the MACsec link. The pre-shared key is an interface parameter, not a switch-wide parameter.

*** Note:**

MACsec encrypts all packets. If you configure MACsec on one or more MultiLink Trunking (MLT) port members on one side, you must configure MACsec on the same port members on the other side. If you do not do this, the port can physically be up, but any overlying protocols can be down. You do not have to provision MACsec on all MLT port members, but if you configure MACsec on an MLT port member on one side, you must also provision MACsec on the corresponding MLT port on the other side.

One way to detect a mismatch of MACsec configuration is to use Virtual Link Aggregation Control Protocol (VLACP) on the links.

MACsec provides security at the data link layer or the physical layer. It provides enhancements at the MAC service sub layer for its operation and services to the upper layer.

MACsec is an interface level feature and is disabled by default.

MACsec keys

MACsec provides industry-standard security through secure point-to-point Ethernet links. The point-to-point links are secured after matching security keys.

Security keys are of two types:

- connectivity association key (CAK), which is a configured *pre-shared key*. If you enable MACsec using the static connectivity association key (CAK) security mode.

! Important:

The switch supports the configuration of a pre-shared key to enable MACsec using the static connectivity association key (CAK) security mode.

The CAK must be identical across both ends of MACsec links.

- secure association key (SAK), which is a configured *static secure association key*. If you use the static secure association key (SAK) security mode. SAKs are short-lived keys derived from the CAK or pre-configured for a particular secure channel (SC). MACsec uses a timer to refresh these keys so that the key, as well the session, is secure.

MACsec uses derived keys to encrypt or decrypt data at each end of the MACsec links.

Integrity Check Verification (ICV)

MACsec ensures data integrity using Integrity Check Verification (ICV). MACsec introduces an 8 or 16 byte SecTag after the Ethernet header, and an 8 or 16 byte calculated ICV after the Encrypted Payload. MACsec computes the ICV for the entire frame, starting from the Ethernet header, SecTag

until the Checksum. The receiving side recalculates the ICV after data decryption and verifies if the received ICV and computed ICV match. If the ICVs do not match, it indicates that data is modified, and MACsec drops the frame.

MACsec security modes

The static Connectivity Association Key (CAK) security mode is the only supported MACsec security mode on the platform, and is also the most common mode to enable MACsec.

When you use the static connectivity association key (CAK) security mode to enable MACsec, you configure a community association on both ends of the link. A pre-shared key establishes the MACsec relationship between the switches on each end of the Ethernet link. The two pre-shared security association keys (SAKs) include a connectivity association key name (CKN) and its own connectivity association key (CAK). The MACsec CKN and CAK are configured in a connectivity association and the CAK must match on both ends of the link to initially enable MACsec.

To ensure link security, the system periodically refreshes keys based on traffic volume and link speed.

To enable MACsec at the port level, you must first associate the port to the connectivity association. You complete the configuration within the connectivity association, but outside of the secure channel.

When you use the static CAK security mode, the system automatically creates two secure channels, one for inbound traffic and another for outbound traffic. You cannot configure any parameters in the automatically-created secure channels.

The CAK security mode ensures security by frequently refreshing to a new random security key, and by only sharing the security key between the two devices on the MACsec-secured point-to-point link.

MACsec provides options to encrypt user payload, or send in a clear confidential offset, to start the encryption from selectable bytes of 0, 30, and 50 after the SecTag header.

You can choose to configure the following optional features:

- **Data encryption** — If you disable encryption, MACsec forwards traffic in clear text. You can view that data that is not encrypted in the Ethernet frame that travels across the link. Even if you disable encryption the MACsec header applies to the frame and integrity checks make sure that traffic has not been tampered with.
- **Confidentiality offset** — If encryption is enabled, and an offset is not configured, all traffic in the connectivity is encrypted. The confidentiality offset provides a way to start encryption after a few bytes following the Ethernet header. The confidentiality offset facilitates traffic flow inspection and classification on intermediate devices by not encrypting the Network Layer header for IPv4 or IPv6. For instance, if you configure the offset to 30, the IPv4 header and the TCP/UDP header are not encrypted. If you configure the offset to 50, the IPv6 header and the TCP/UDP header is not encrypted.

Connectivity associations and secure channels

You configure MACsec in connectivity associations (CA). You can enable MACsec after you attach a connectivity association to an interface. To use the static CAK security mode to enable MACsec, you must create, and configure connectivity associations on both ends of the link.

A connectivity association (CA) is a logical representation of a MACsec domain within a network. Each connectivity association is associated with a connectivity association key (CAK). MACsec links are associated with a CA to establish end-to-end MACsec communication. Every MACsec enabled interface is a member of one connectivity association. Switch ports are members of a connectivity association, and can only be a member of one connectivity association.

A secure channel (SC) is a unidirectional channel that connects two endpoints of MACsec. A secure channel is a long-term relationship that persists through the sequence of secure associations.

A secure association (SA) is a short-lived relationship within an SC. MACsec identifies each security association by AN, and supported Secure association key (SAK), which is derived from the CAK. The secure association key is used on both ends of MACsec links to encrypt and decrypt the frames. SAKs are frequently refreshed for security reasons. Periodically changing SAs allows the use of fresh keys without terminating the SC relationship.

You configure connectivity associations. Secure channels and secure associations are internally created in the hardware.

MACsec 2AN and 4AN mode

MACsec 2AN mode implementations use two security associations (SA) for each secure channel (SC) and symmetric keys on both MACsec endpoints. The keys are symmetric because they are both derived from the same connectivity association key (CAK).

MACsec 4AN mode generates four Secure Associations Keys (SAK) per secure channel. It uses enhanced hashing algorithm to derive eight SAKs, and uses asymmetric keys on both ends. You can use the `macsec connectivity-association` command to configure different (asymmetric) transmit keys for each endpoint by using the `key-parity` keyword. If you do not specify a value for `key-parity`, the connectivity association is created in 2AN mode. For more information about configuring MACsec transmit keys, see [Configuring a connectivity association](#) on page 198.

MACsec components

MACsec has three major components:

- **Security entity (SecY)**

SecY is the entity that operates the MACsec protocol within the system. You configure a secure community association (CA) to meet the requirements of MACsec for connectivity between stations that attach to an individual LAN. Unidirectional secure channels (SC) support

each CA. Each SC supports secure transmission of frames through the use of symmetric key cryptography from one of the systems to all the others in the CA.

Each SecY transmits frames conveying secure MACsec service requests on a single SC, and receives frames conveying secure service indications on separate SCs, one for each of the other SecYs that participate in the secure CA.

A connectivity association (CA) is a logical representation of a MACsec domain within a network. Each connectivity association is associated with a connectivity association key (CAK). MACsec links are associated with a CA to establish end-to-end MACsec communication. Every MACsec enabled interface is a member of one connectivity association. Switch ports are members of a connectivity association, and can only be a member of one connectivity association.

A secure channel (SC) is a unidirectional channel that connects two endpoints of MACsec. A secure channel is a long-term relationship that persists through the sequence of secure associations. An SC is a unidirectional point to multipoint communication, and can persist through Secure Association Key (SAK) changes. A sequence of Secure Associations (SAs) support each SC and allow for the periodic use of fresh keys without terminating the relationship. A single secret key or a set of keys support each SA, where the cryptographic operations used to protect one frame require more than one key. An SCI identifies each SC. An SCI is comprised of a unique 48-bit universally administered MAC address, identifying the system to which the transmitting SecY belongs, concatenated with a 16-bit port number, identifying the SecY within that system.

The SCI concatenated with a two-bit AN identifies each SA. The Secure Association Identifier (SAI) created allows the receiving SecY to identify the SA, and the SAK used to decrypt and authenticate the received frame. The AN, and hence the SAI, are only unique for the SAs that can be used or recorded by participating SecYs at any instant.

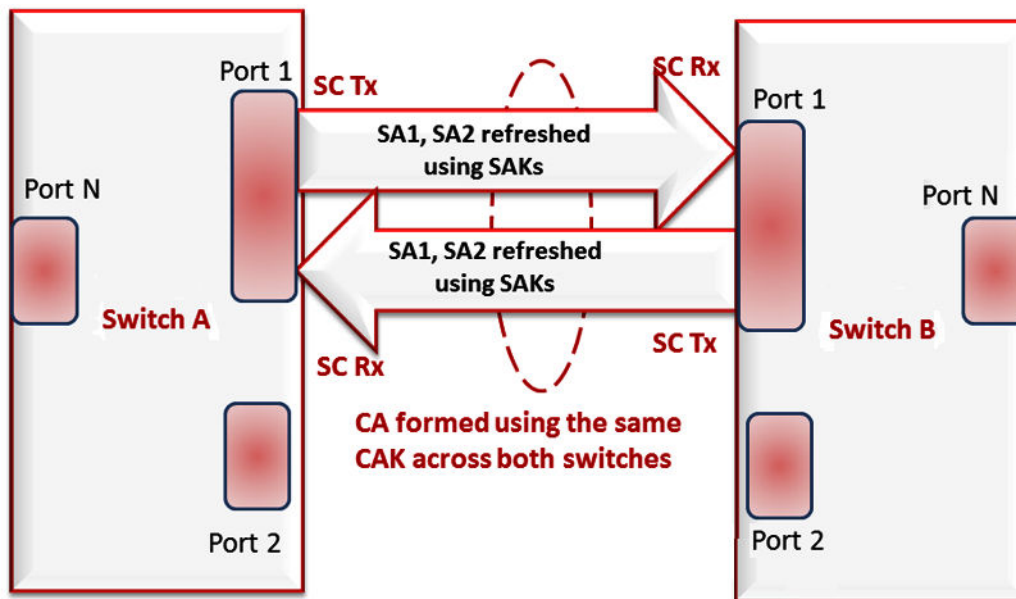

Figure 25: MACsec relationship

- Key agreement entity (KaY)

The KaY in MACsec is responsible for CAK and SAK computations, distributions and maintenance of those keys. CAK is a global key which is persistent until the CA exists. When you configure the CAK, ensure that it is identical across MACsec links. SAK are short-lived keys derived from the CAK, or pre-configured for a particular SC. MACsec uses a timer to refresh these keys so that the key, as well the session, is secure.

A separate 802.1x-2010 standard is available to automate the above key exchanges and maintenance. The keys are pre-configured.

- **Integrity check verification (ICV) or Cryptographic entity**

The Cryptographic entity provides integrity check protection and validation for frames transmitted or received through the SecY layer. The ICV is calculated for the frame SA/DA, SecTag, User Payload, and CRC. The calculated ICV is appended at the end-of-frame, recalculated at the receiver side of MACsec link and validated to see if they are equal. This is called Integrity Check Verification (ICV). The frames that pass the integrity check are further processed, while the system drops the frames that fail the integrity check.

MACsec configuration provides options to encrypt user payload or send in the clear. The option to start the encryption from N bytes after the Ethernet header also exists.

The VSP 4000 Release 4.0 supports these options.

In the following figure, CA connects switches A, B, and C by their respective SC and SAK. Station D cannot participate in the secure communication between A, B, or C as station D does not know the SAK.

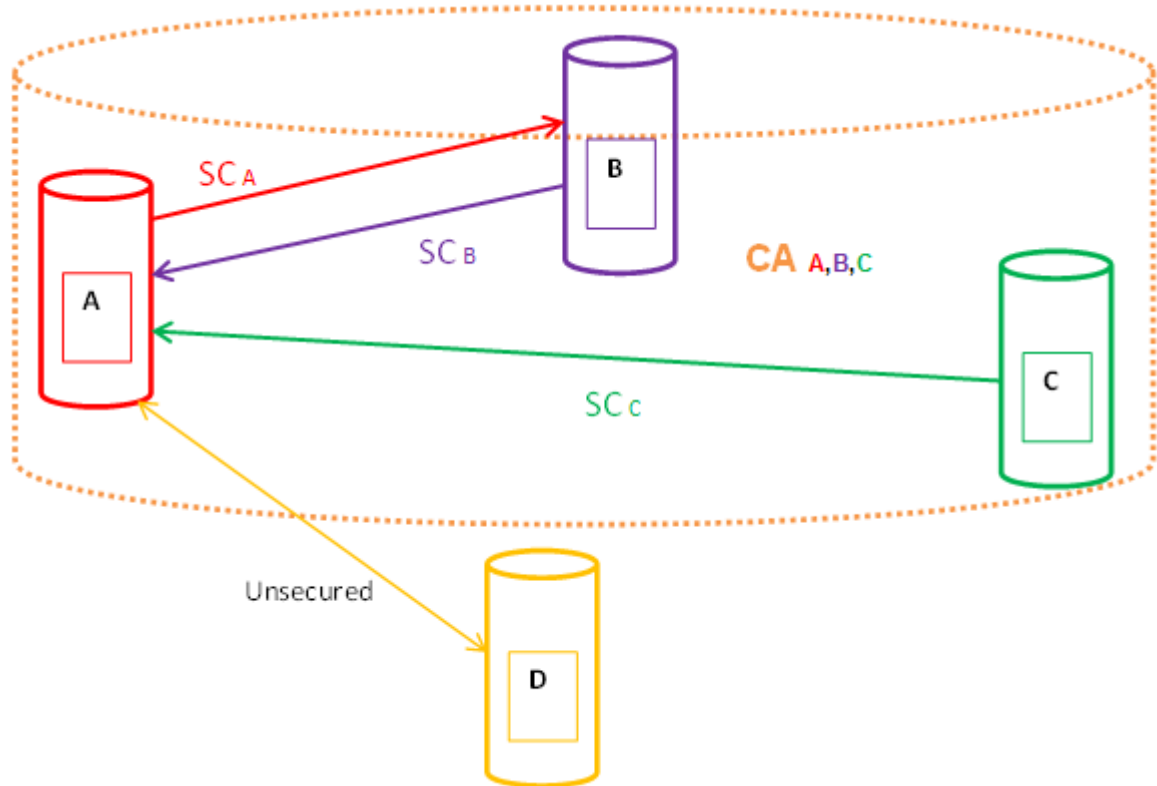

MACsec operation

As shown in the following figure, a host that connects to Switch A sends an Ethernet frame to a host that connects to Switch B. Switch A encrypts the frame, excluding the Ethernet header and optionally the 802.1Q header. Switch A also appends MACsec information like SecTag and ICV to the encrypted payload and transmits the frame using normal frame transmission. This process ensures data confidentiality.

On receiving the frame, Switch B decrypts the frame. Switch B recalculates the ICV using a MACsec key and the SecTag present in the frame. If the ICV present in the received frame matches the recalculated ICV, the switch processes the frame. If the two ICVs do not match, the switch discards the frame. This process ensures data origin authenticity and data integrity. The encryption and decryption algorithms follow the AES-GCM-128 standard.

The MACsec key between switches A and B are statically pre-configured.

* Note:

MACsec will be operational between two switches across Point-to-Point Connectivity only when the switches are either directly connected or across a network cloud that provides P2P connectivity between the two switches.

For example, in the following figure you can enable MACsec between two switches across a network cloud where P2P connectivity between the switches is provided via services such as P2P, MPLS, Layer 2 VPN (ELINE), or connectivity across Dark Fiber. However, it is important to note that MACsec will not be operational between two switches across a network cloud if the intermediate routers/switches need to inspect the VLAN tag or IP header for service classification. This is because MACsec encrypts the entire data frame including the VLAN header and as such the intermediate switches/routers will not have visibility into the same to perform service classification.

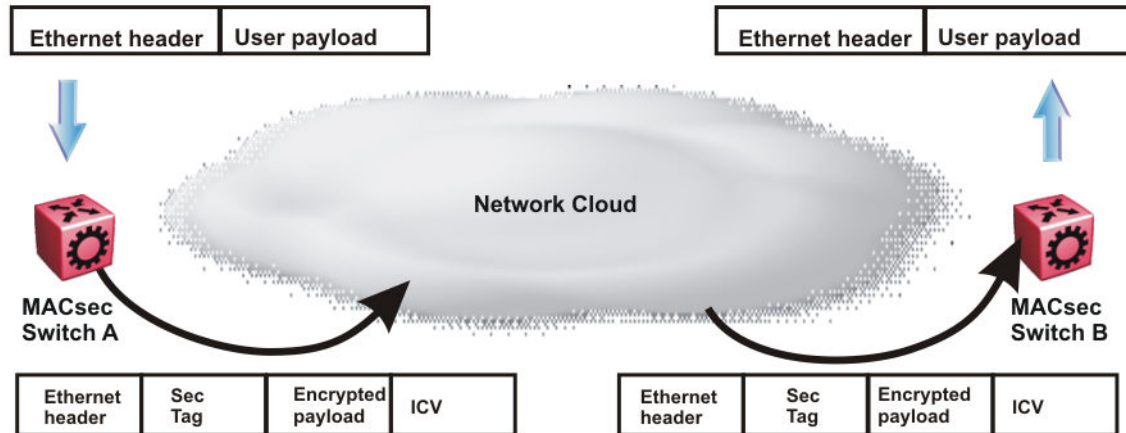

Figure 26: MACsec operation

MACsec performance

To monitor MACsec performance, view the performance statistics. For information on the supported statistics, see *Monitoring Performance*.

MACsec configuration using CLI

Configuring a connectivity association

Use the following procedure to configure a connectivity association (CA) in static CAK security mode using the CLI.

Procedure

1. Enter Global Configuration mode:
enable

```
configure terminal
```

2. Configure a CA:

```
macsec connectivity-association WORD<5-15> connectivity-association-  
key WORD<10-32> [key-parity even|odd]
```

* Note:

If you do not specify a key-parity value, the CA is created in 2AN mode.

3. Enter GigabitEthernet Interface Configuration mode:

```
enable
```

```
configure terminal
```

```
interface GigabitEthernet {slot/port[/sub-port] [-slot/port[/sub-  
port]][, ...]}
```

* Note:

If your platform supports channelization and the port is channelized, you must also specify the sub-port in the format slot/port/sub-port.

4. Associate a port with a CA:

```
macsec connectivity-association WORD<5-15>
```

5. Enable encryption on the port.

```
macsec encryption enable
```

6. Enable MACsec on the port:

```
macsec enable
```

Example

Configure a connectivity association and enable MACsec on a port:

```
Switch:1>enable  
Switch:1#configure terminal  
Switch:1(config)#macsec connectivity-association caname1 connectivity-association-key  
1029384756abcdef key-parity even  
Switch:1(config)#interface gigabitethernet 1/2  
Switch:1(config-if)#macsec connectivity-association caname1  
Switch:1(config-if)#macsec encryption enable  
Switch:1(config-if)#macsec enable
```

Variable definitions

Use the data in the following table to use the `macsec` command.

Variable	Value
connectivity-association WORD<5-15>	Specifies a connectivity-association name. It is a 5 to 15 character alphanumeric string.

Table continues...

Variable	Value
connectivity-association-key <i>WORD</i> <10–32>	Specifies the value of the connectivity-association key (CAK). A 32 character hexadecimal string is recommended.
key-parity even odd	Specifies Tx key parity using the following values: <ul style="list-style-type: none"> • even — generates even-numbered keys for Tx • odd — generates odd-numbered keys for Tx <p>* Note: If you do not specify a key-parity value, the connectivity association (CA) is created in 2AN mode.</p>

Use the data in the following table to use the **interface gigabitethernet** command.

Variable	Value
{slot/port[/sub-port][/-slot/port[/sub-port]][,...]}	Specifies the port that you want to associate with the CA. Identifies the slot and port in one of the following formats: a single slot and port (slot/port), a range of slots and ports (slot/port-slot/port), or a series of slots and ports (slot/port,slot/port,slot/port). If your platform supports channelization and the port is channelized, you must also specify the sub-port in the format slot/port/sub-port.

Updating the connectivity association key (CAK)

Use the following procedure to update the connectivity association key (CAK).

Procedure

1. Enter GigabitEthernet Interface Configuration mode:

```
enable
configure terminal
interface GigabitEthernet {slot/port[/sub-port][/-slot/port[/sub-port]][,...]}
```

*** Note:**

If your platform supports channelization and the port is channelized, you must also specify the sub-port in the format slot/port/sub-port.

2. Disable MACsec on the port:

```
no macsec enable
```

3. Update the connectivity association key (CAK):

```
macsec connectivity-association WORD<5-15> connectivity-association
key WORD<10-32> {key-parity even|odd}
```

*** Note:**

If you do not specify a key-parity value, the system defaults to 2AN mode.

4. Enable MACsec on the port:

```
macsec enable
```

Example

Update the connectivity association key (CAK):

```
Switch:1>enable
Switch:1#configure terminal
Switch:1(config)#interface gigabit 1/2
Switch:1(config-if)#no macsec enable
Switch:1(config-if)#macsec connectivity-association caname1 connectivity-association-key
1029384756abcdef key-parity even
Switch:1(config-if)#macsec enable
```

Variable definitions

Use the data in the following table to use the `macsec` command.

Variable	Value
connectivity-association WORD<5-15>	Specifies a connectivity-association name. It is a 5 to 15 character alphanumeric string.
connectivity-association-key WORD<10-32>	Specifies the value of the connectivity-association key (CAK). A 32 character hexadecimal string is recommended.

Use the data in the following table to use the `interface gigabitethernet` command.

Variable	Value
{slot/port[/sub-port][/-slot/port[/sub-port]][,...]}	<p>Specifies the port that you want to associate with the connectivity association (CA).</p> <p>Identifies the slot and port in one of the following formats: a single slot and port (slot/port), a range of slots and ports (slot/port-slot/port), or a series of slots and ports (slot/port,slot/port,slot/port). If your platform supports channelization and the port is channelized, you must also specify the sub-port in the format slot/port/sub-port.</p>

Configuring MACsec encryption on a port

Use the following procedure to enable or disable encryption on a MACsec capable port. The default is disabled.

About this task

If you disable encryption, MACsec forwards traffic in clear text. You can view that data that is not encrypted in the Ethernet frame that travels across the link. Even if you disable encryption the MACsec header applies to the frame and integrity checks make sure that traffic has not been tampered with.

Procedure

1. Enter GigabitEthernet Interface Configuration mode:

```
enable

configure terminal

interface GigabitEthernet {slot/port[/sub-port] [-slot/port[/sub-
port]][, ...]}
```

*** Note:**

If your platform supports channelization and the port is channelized, you must also specify the sub-port in the format slot/port/sub-port.

2. Enable MACsec encryption on the port:

```
macsec encryption enable
```

3. Disable MACsec encryption on the port:

```
no macsec encryption enable
```

Example

Configure MACsec encryption on a port:

```
Switch:1>enable
Switch:1#configure terminal
Switch:1(config)#interface gigabit 1/2
Switch:1(config-if)#macsec encryption enable
```

Configuring the confidentiality offset on a port

Use the following procedure to configure the confidentiality offset on a port. The default is disabled.

About this task

The confidentiality offset provides a way to start encryption after a few bytes following the Ethernet header. The confidentiality offset facilitates traffic flow inspection and classification on intermediate devices by not encrypting the Network Layer header for IPv4 or IPv6. For instance, if you configure

the offset to 30, the IPv4 header and the TCP/UDP header are not encrypted. If you configure the offset to 50, the IPv6 header and the TCP/UDP header is not encrypted.

Procedure

1. Enter GigabitEthernet Interface Configuration mode:

```
enable

configure terminal

interface GigabitEthernet {slot/port[/sub-port] [-slot/port[/sub-
port]][, ...]}
```

*** Note:**

If your platform supports channelization and the port is channelized, you must also specify the sub-port in the format slot/port/sub-port.

2. Configure confidentiality offset on the port:

```
macsec confidentiality-offset <30-50>
```

3. Disable the confidentiality offset on the port:

```
no macsec confidentiality-offset
```

Example

Configuring the confidentiality offset on the port:

```
Switch:1>enable
Switch:1#configure terminal
Switch:1(config)#interface gigabit 1/2
Switch:1(config-if)#macsec confidentiality-offset 30
```

Variable definitions

Use the data in the following table to use the `macsec confidentiality-offset` command.

Variable	Value
<30-50>	Specifies the bytes after the Ethernet header from which data encryption begins. Valid values are 30 and 50.

Use the data in the following table to use the `interface gigabitethernet` command.

Variable	Value
{slot/port[/sub-port] [-slot/port[/sub-port]][, ...]}	<p>Specifies the port that you want to associate with the connectivity association (CA).</p> <p>Identifies the slot and port in one of the following formats: a single slot and port (slot/port), a range of slots and ports (slot/port-slot/port), or a series of slots and ports (slot/port,slot/port,slot/port). If your platform supports channelization and the port is</p>

Variable	Value
	channelized, you must also specify the sub-port in the format slot/port/sub-port.

Viewing the MACsec connectivity association details

Perform this procedure to view the MACsec connectivity association (CA) details.

Procedure

1. Enter Privileged EXEC mode:

```
enable
```

2. View the MACsec CA details:

```
show macsec connectivity-association [WORD<5-15>]
```

*** Note:**

This command displays the MACsec CA details, including the MD5 hashed value of the CA key.

Example

View the MACsec connectivity association details:

*** Note:**

Slot and port information can differ depending on hardware platform. For more information about specific hardware, see your hardware documentation.

```
Switch:1>show macsec connectivity-association
=====
MACSEC Connectivity Associations Info
=====
Connectivity      Connectivity      AN_Mode /      Port
Association Name  Association Key Hash  TxKeyParity    Members
-----
ca150             ba6b005bef79e7b95f3e08181e2501ce  2AN / NA      1/49
ca151             5b41f44ecaa54f3873e781557b39230b  4AN / odd     1/49
ca152             053f26fb96b011191f2da28849f08677  4AN / Even    1/50

Switch:1#show macsec statistics 1/50 secure-channel inbound
=====
MACSEC Port Inbound Secure Channel Statistics
=====
PortId  UnusedSA  NoUsingSA  Late  NotValid  Invalid
Packets Packets   Packets   Packets Packets   Packets
-----
1/47    0         0         0     0         0

PortId  Delayed  Unchecked  Ok    Octets    Octets
Packets Packets  Packets   Pkts   Validated  Decrypted
-----
1/47    0         0         1796  0         169282
```

```
Switch:1#show macsec statistics 1/50 secure-channel outbound
```

```
=====
MACSEC Port Outbound Secure Channel Statistics
=====
```

PortId	Protected Packets	Encrypted Packets	Octets Protected	Octets Encrypted
1/47	0	2628	0	277182

Viewing MACsec status

Perform this procedure to view MACsec status.

About this task

This command displays the status for the following:

- MACsec status
- MACsec encryption status
- The associated Connectivity Association (CA) name

* Note:

If you do not specify a port number, the information on all MACsec capable interfaces is displayed.

Procedure

1. Enter Privileged EXEC mode:

```
enable
```

2. View the MACsec status:

```
show macsec status {slot/port[/sub-port] [-slot/port[/sub-port]]
[,...]}
```

3. Display all MACsec related information:

```
show macsec
```

Example

View the MACsec status:

* Note:

Slot and port information can differ depending on hardware platform. For more information about specific hardware, see your hardware documentation.

The switch does not support replay protect.

```
Switch:1>enable
Switch:1#show macsec status
=====
MACSEC Port Status
=====
PortId  MACSEC  Encryption  Replay  Replay  Encryption  CA
Status  Status  Status      Protect Protect W'dow  Offset  Name
-----
1/39    enabled enabled      disabled --      ipv4Offset(30) ca333
1/40    disabled disabled    disabled --      none          Nil
```

```
Switch:1#show macsec status 1/40
=====
MACSEC Port Status
=====
PortId  MACSEC  Encryption  Replay  Replay  Encryption  CA
Status  Status  Status      Protect Protect W'dow  Offset  Name
-----
1/40    enabled enabled      disabled --      ipv4Offset(30) ca333
```

Display all MACsec information:

```
Switch:1#show macsec
=====
MACSEC Connectivity Associations Info
=====
Connectivity  Connectivity  AN_Mode /  Port
Association Name  Association Key Hash  TxKeyParity  Members
-----
caname1          d4433e901bae92d0cc472706f66cfc18  4AN / odd
All 1 out of 1 Total Num of Macsec connectivity associates displayed
=====
MACSEC Port Status
=====
PortId  MACSEC  Encryption  Replay  Replay  Encryption  CA
Status  Status  Status      Protect Protect W'dow  Offset  Name
-----
1/1     disabled disabled    disabled --      none          Nil
1/2     disabled disabled    disabled --      none          Nil
1/3     disabled disabled    disabled --      none          Nil
1/4     disabled disabled    disabled --      none          Nil
1/5     disabled disabled    disabled --      none          Nil
1/6     disabled disabled    disabled --      none          Nil
1/7     disabled disabled    disabled --      none          Nil
1/8     disabled disabled    disabled --      none          Nil
1/9     disabled disabled    disabled --      none          Nil
1/10    disabled disabled    disabled --      none          Nil
1/11    disabled disabled    disabled --      none          Nil
```

```
--More-- (q = quit)
```

MACsec configuration using EDM

Configuring connectivity associations

Use the following procedure to configure connectivity associations (CA) using EDM.

Procedure

1. In the Device Physical View, click on the chassis.
2. In the navigation tree, expand the following folders: **Configuration > Edit**.
3. Click **Chassis**.
4. In the Chassis window, click the **MAC Security** tab.
5. Click **Insert**.
 - a. In the **AssociationName** field, type the connectivity-association name.
 - b. In the **AssociationKey** field, type the value of the connectivity-association key.
 - * **Note:**
The connectivity-association key appears as an MD5-hashed text in the MAC security table.
 - c. In the **AssociationTxKeyParity** box, select an option for Tx key parity.
 - d. Click **Insert** to save the configuration.
6. Click **Apply**.

Configuring CA field descriptions

Use the data in the following table to use the **MAC Security** tab.

Name	Description
AssociationName	Specifies a name for each connectivity association configured on the device.
AssociationKey	Specifies a pre-shared, connectivity association key associated with each connectivity association configured on the device.
AssociationTxKeyParity	Specifies Tx key parity using the following values: <ul style="list-style-type: none"> • None — key parity is not specified

Table continues...

Name	Description
	<p> Note:</p> <p>If you do not specify a key parity value, the system defaults to 2AN mode.</p> <ul style="list-style-type: none"> • Even — generates even-numbered keys • Odd — generates odd-numbered keys
AssociationPortMembers	Specifies the set of ports for which this connectivity association is associated.

Associating a port with a connectivity association

Use the following procedure to associate a port with a connectivity association (CA) using EDM. For VSP 4000, you can associate connectivity associations to device ports 1/49 and 1/50 only.

Procedure

1. In the Device Physical View, click on the port that you want to associate with the connectivity association.
2. In the navigation tree, expand the following folders: **Configuration > Edit > Port**.
3. Click **General**.
4. In the Port General window, click the **MAC Security** tab.
5. In the **CAName** field, type the connectivity-association name.
6. In the **OffsetValue** field, select the value of confidentiality offset to be achieved.
7. Select the **EncryptionEnable** checkbox to enable encryption for the frames transmitted on the port.
8. Select the **Macsec Enable** checkbox to enable MACsec on the port.
9. Click **Apply** to save the configuration.

Associating a port with CA field descriptions

Use the data in the following table to configure the **MAC security** tab.

Name	Description
CAName	Specifies the name of the connectivity association attached to the port or interface.
OffsetValue	Offsets MACsec encryption in an IPv4 TCP/UDP header or IPv6 TCP/UDP header. The confidentiality offset provides a way to start encryption after a few bytes following the Ethernet

Table continues...

Name	Description
	header. The confidentiality offset facilitates traffic flow inspection and classification on intermediate devices by not encrypting the Network Layer header for IPv4 or IPv6. For instance, if you configure the offset to 30, the IPv4 header and the TCP/UDP header are not encrypted. If you configure the offset to 50, the IPv6 header and the TCP/UDP header is not encrypted.
EncryptionEnable	Specifies the encryption status per port. Use this field to enable or disable encryption for each MACsec capable port.
Macsec Enable	Enables or disables MACsec on the port.

Chapter 8: RADIUS

The following sections describe Remote Access Dial-In User Services (RADIUS) and its configuration.

RADIUS fundamentals

Remote Access Dial-In User Services (RADIUS) is a distributed client/server system that assists in securing networks against unauthorized access, allowing a number of communication servers and clients to authenticate users identity through a central database. The database within the RADIUS server stores information about clients, users, passwords, and access privileges including the use of shared secret.

RADIUS is a fully open and standard protocol, defined by two Requests for Comments (RFC) (Authentication: RFC2865, Accounting: RFC2866). You use RADIUS authentication to get secure access to the system (console/Telnet/SSH/EDM), and RADIUS accounting to track the management sessions (CLI only).

RADIUS support for IPv6

RADIUS supports both IPv4 and IPv6 with no differences in functionality or configuration in all but the following case. When you add or update a RADIUS server in Enterprise Device Manager (EDM) you must specify if the address type is an IPv4 or an IPv6 address.

How RADIUS works

A RADIUS application has two components:

- RADIUS server
A computer equipped with server software (for example, a UNIX workstation) that is located at a central office or campus. The server has authentication and access information in a form that is compatible with the client. Typically, the database in the RADIUS server stores client information, user information, password, and access privileges, including the use of a shared secret. A network can have one server for both authentication and accounting, or one server for each service.
- RADIUS client
A device, router, or a remote access server, equipped with client software, that typically resides on the same local area network (LAN) segment as the server. The client is the network access point between the remote users and the server.

The two RADIUS processes are

- RADIUS authentication—Identifies remote users before you give them access to a central network site.
- RADIUS accounting—Performs data collection on the server during a remote user's dial-in session with the client.

Configuration of the RADIUS server and client

For more information about how to configure a RADIUS server, see the documentation that came with the server software.

The switch software supports BaySecure Access Control (BSAC) and the Merit Network servers. To use these servers, you must first obtain the software for the server you will use. Also, you must make changes to one or more configuration files for these servers.

RADIUS authentication

You can use RADIUS authentication to use a remote server to authenticate logons. The RADIUS server also provides access authority. RADIUS assists network security and authorization by managing a database of users. The device uses this database to verify user names and passwords as well as information about the type of access priority available to the user.

When the RADIUS client sends an authentication request requesting additional information such as a SecurID number, it sends it as a challenge-response. Along with the challenge-response, it sends a reply-message attribute. The reply-message is a text string, such as `Please enter the next number on your SecurID card:`. The RFC defined maximum length of each reply-message attribute is 253 characters. If you have multiple instances of reply-message attributes that together form a large message that displays to the user, the maximum length is 2000 characters.

You can use additional user names to access the device, in addition to the six existing user names of `ro`, `L1`, `L2`, `L3`, `rw`, and `rwa`. The RADIUS server authenticates the user name and assigns one of the existing access priorities to that name. Unauthenticated user names are denied access to the device. You must add user names `ro`, `L1`, `L2`, `L3`, `rw`, and `rwa` to the RADIUS server if you enable authentication. Users not added to the server are denied access.

The following list shows the user configurable options of the RADIUS feature:

- Up to 10 RADIUS servers in each device for fault tolerance (each server is assigned a priority and is contacted in that order).
- A secret key for each server to authenticate the RADIUS client
- The server UDP port
- Maximum retries allowed
- Time-out period for each attempt

Note:

If you enable enhanced secure mode with the `boot config flags enhancedsecure-mode` command, you enable different access levels, along with stronger password complexity, length, and minimum change intervals. With enhanced secure mode enabled, the switch supports the following access levels for RADIUS authentication:

- Administrator
- Privilege

- Operator
- Auditor
- Security

The switch associates each username with a certain role and appropriate authorization rights to view and configure commands. For more information on system access fundamentals and configuration, see *Administering*.

Use of RADIUS to modify user access to CLI commands

The switch provides CLI command access based on the configured access level of a user. However, you can use RADIUS to override CLI command access provided by the switch.

To override user access to CLI commands, you must configure the command-access-attribute on the switch and on the RADIUS server. (The switch uses decimal value 194 as the default for this parameter.) On the RADIUS server, you can then define the commands that the user can or cannot access.

Important:

When you enable RADIUS on the switch and configure a RADIUS server to be used by CLI or EDM, the server authenticates the connection, whether it is FTP, HTTPs, SSH, or TELNET. However, in the event that the RADIUS server is unresponsive or is unreachable, the switch falls back to the local authentication, so that you can access the switch using your local login credentials.

Regardless of the RADIUS server configuration, you must configure the user's access on the switch based on the six platform access levels.

RADIUS accounting

RADIUS accounting logs all of the activity of each remote user in a session on the centralized RADIUS accounting server.

Session-IDs for each RADIUS account generate as 12-character strings. The first four characters in the string form a random number in hexadecimal format. The last eight characters in the string indicate the number of user sessions started since the last restart, in hexadecimal format.

The Network Address Server (NAS) IP address for a session is the address of the device interface to which the remote session is connected over the network. For a console session, modem session, and sessions running on debug ports, this value is set to 0.0.0.0, as is the case with RADIUS authentication.

The following table summarizes the events and associated accounting information logged at the RADIUS accounting server.

Table 7: Accounting events and logged information

Event	Accounting information logged at server
Accounting is turned on at router	• Accounting on request: NAS IP address
Accounting is turned off at router	• Accounting off request: NAS IP address
User logs on	• Accounting start request: NAS IP address

Table continues...

Event	Accounting information logged at server
	<ul style="list-style-type: none"> • Session ID • User name
More than 40 CLI commands are executed	<ul style="list-style-type: none"> • Accounting interim request: NAS IP address • Session ID • CLI commands • User name
User logs off	<ul style="list-style-type: none"> • Accounting stop request: NAS IP address • Session ID • Session duration • User name • Number of input octets for session • Number of octets output for session • Number of packets input for session • Number of packets output for session • CLI commands

When the device communicates with the RADIUS accounting server, the following actions occur:

1. If the server sends an invalid response, the response is silently discarded and the server does not make an attempt to resend the request.
2. User-specified number of attempts are made if the server does not respond within the user-configured timeout interval. If a server does not respond to any of the retries, requests are sent to the next priority server (if configured). You can configure up to 10 RADIUS servers for redundancy.

RADIUS configuration using CLI

You can configure Remote Access Dial-In User Services (RADIUS) to secure networks against unauthorized access, and allow communication servers and clients to authenticate users identity through a central database.

The database within the RADIUS server stores client information, user information, password, and access privileges, including the use of shared secret.

RADIUS supports IPv4 and IPv6 addresses, with no difference in functionality or configuration using CLI.

RADIUS is a fully open and standard protocol, defined by RFCs (Authentication: RFC2865, accounting RFC2866). With the switch, you use RADIUS authentication to secure access to the

device (console/Telnet/SSH), and RADIUS accounting to track the management sessions for Command Line Interface (CLI) only.

RADIUS authentication allows the remote server to authenticate logons. RADIUS accounting logs all of the activity of each remote user in a session on the centralized RADIUS accounting server.

Configuring RADIUS attributes

Configure RADIUS to authenticate user identity through a central database.

Procedure

1. Enter Global Configuration mode:

```
enable
configure terminal
```

2. Configure RADIUS access priority:

```
radius access-priority-attribute <192-240>
```

3. Configure RADIUS accounting:

```
radius accounting {attribute-value <192-240>|enable|include-cli-commands}
```

4. Configure the RADIUS authentication info attribute value:

```
radius auth-info-attr-value <0-255>
```

5. Clear RADIUS statistics:

```
radius clear-stat
```

6. Configure the value of the CLI commands:

```
radius cli-commands-attribute <192-240>
```

7. Configure the value of the command access attribute:

```
radius command-access-attribute <192-240>
```

8. Configure the maximum number of servers allowed:

```
radius maxserver <1-10>
```

9. Configure the multicast address attribute:

```
radius mcast-addr-attr-value <0-255>
```

Example

```
Switch:1>enable
Switch:1#configure terminal
```

Configure RADIUS access priority:

```
Switch:1(config)#radius access-priority-attribute 192
```

Configure RADIUS accounting to include CLI commands:

```
Switch:1(config)#radius accounting include-cli-commands
```

Variable definitions

Use the data in the following table to use the **radius** command.

Variable	Value
access-priority-attribute <192-240>	Specifies the value of the access priority attribute in the range of 192 to 240. The default is 192.
accounting {attribute-value <192-240> enable include-cli-commands}	Configures the accounting attribute value, enable accounting, or configure if accounting includes CLI commands. The default is false. Use the no option to disable the accounting attribute value: no radius accounting enable .
auth-info-attr-value <0-255>	Specifies the value of the authentication information attribute in the range of 0 to 255. The default is 91.
clear-stat	Clears RADIUS statistics.
cli-cmd-count <1-40>	Specifies how many CLI commands, from 1 to 40, before the system sends a RADIUS accounting interim request. The default value is 40.
cli-commands-attribute <192-240>	Specifies the value of CLI commands attribute in the range of 192 to 240. The default is 195.
cli-profile	Enable RADIUS CLI profiling. CLI profiling grants or denies access to users being authenticated by way of the RADIUS server. You can add a set of CLI commands to the configuration on the RADIUS server, and you can specify the command-access more for these commands. The default is false.
command-access-attribute <192-240>	Specifies the value of the command access attribute in the range of 192 to 240. The default is 194.
enable	Enable RADIUS authentication globally on the switch.
maxserver <1-10>	Specific to RADIUS authentication, configures the maximum number of servers allowed for the device. The range is between 1 and 10. The default is 10.
mcast-addr-attr-value <0-255>	Specifies the value of the multicast address attribute in the range of 0 to 255. The default is 90.
server host <i>WORD</i> <0-46> key <i>WORD</i> <0-32> [used-by {cli snmp web} [acct-enable] [acct-port <1-65536>] [enable] [port <1-65536>] [priority <1-10>] [retry <0-6>] [source-ip <i>WORD</i> <0-46>] [timeout <1-60>]	<ul style="list-style-type: none"> • host <i>WORD</i><0-46> Creates a host server. <i>WORD</i><0-46> signifies an IP address. • key <i>WORD</i><0-32> Specifies a secret key in the range of 0-32 characters. • used-by {cli snmp web}

Table continues...

Variable	Value
	<p>Specifies how the server functions. Configures the server for authentication for</p> <ul style="list-style-type: none"> - cli - snmp - web <ul style="list-style-type: none"> • acct-enable Enables RADIUS accounting on this server. The system enables RADIUS accounting by default. • acct-port <1–65536> Specifies a UDP port of the RADIUS accounting server (1 to 65536). The default value is 1816. The UDP port value set for the client must match the UDP value set for the RADIUS server. • enable Enables the server. The default is true. • port <1–65536> Specifies a UDP port of the RADIUS server. The default value is 1812. • priority <1–10> Specifies the priority value for this server. The default is 10. • retry <0–6> Specifies the maximum number of authentication retries. The default is 3. • source-ip <i>WORD</i><0–46> Specifies a configured IP address as the source address when transmitting RADIUS packets. <i>WORD</i><0–46> signifies an IP address. • timeout <1–60> Specifies the number of seconds before the authentication request times out. The default is 3.
sourceip-flag	<p>Enable the source IP so the switch uses a configured source IP address. If the outgoing interface on the switch fails, a different source IP address is used — requiring that you make configuration changes to define the new RADIUS client on the RADIUS server. To simplify RADIUS server configuration, you can configure the switch to use a Circuitless IP (CLIP) address as the source IP and NAS IP address when transmitting RADIUS packets. A CLIP is not associated with a physical</p>

Table continues...

Variable	Value
	<p>interface and is always in an active and operational state. You can configure the switch with multiple CLIP interfaces.</p> <p>By default, the switch uses the IP address of the outgoing interface as the source IP, and the NAS Ip address for RADIUS packets that it transmits.</p>

Configuring RADIUS profile

Use RADIUS CLI profiling to grant or deny CLI command access to users being authenticated by way of the RADIUS server. You can add a set of CLI commands to the configuration file on the radius server, and you can specify the command-access mode for these commands. The default is false.

Procedure

1. Enter Global Configuration mode:

```
enable
configure terminal
```

2. Enable RADIUS CLI profiling:

```
radius cli-profile
```

Example

```
Switch:1> enable
Switch:1# configure terminal
Switch:1(config)# radius cli-profile
```

Enabling RADIUS authentication

About this task

Enable or disable RADIUS authentication globally on the device to allow further configuration to take place. Use the no option to disable RADIUS authentication globally. The default is false or disabled.

Procedure

1. Enter Global Configuration mode:

```
enable
configure terminal
```

2. Enable RADIUS authentication globally on the switch:

```
radius enable
```

Enabling the source IP flag for the RADIUS server

Before you begin

- To configure the CLIP as the source IP address, you must enable the global RADIUS sourceip-flag. You can then configure the source-ip address parameter while defining the RADIUS server on the switch. The source IP address must be a CLIP address, and that you can configure a different CLIP address for each RADIUS server.

Important:

Use the source IP option only for the RADIUS servers connected to the in-band network.

About this task

By default, the switch uses the IP address of the outgoing interface as the source IP, and the NAS IP address for RADIUS packets that it transmits. Enable the source IP so the switch uses a configured source IP address instead. Therefore, if the outgoing interface on the switch fails, a different source IP address is used—requiring that you make configuration changes to define the new RADIUS Client on the RADIUS server.

RADIUS supports IPv4 and IPv6 addresses, with no difference in functionality or configuration in CLI.

To simplify RADIUS Server configuration, you can configure the switch to use a Circuitless IP Address (CLIP) as the source IP and NAS IP address when transmitting RADIUS packets. A CLIP is not associated with a physical interface and is always in an active and operational state. You can configure the switch with multiple CLIP interfaces.

The default for `radius sourceip-flag` is false.

Procedure

1. Enter Global Configuration mode:

```
enable
configure terminal
```

2. Enable the RADIUS packet source IP flag:

```
radius sourceip-flag
```

Enabling RADIUS accounting

Before you begin

- You must configure a RADIUS server before you can enable RADIUS accounting.

About this task

Enable Remote Access Dial-in User Services (RADIUS) accounting to log all of the activity of each remote user in a session on the centralized RADIUS accounting server.

Procedure

1. Enter Global Configuration mode:

```
enable
configure terminal
```
2. Enable RADIUS accounting globally:

```
radius accounting enable
```
3. Include or exclude CLI commands in RADIUS accounting updates:

```
radius accounting include-cli-commands
```
4. Specify the integer value of the CLI commands attribute:

```
radius accounting attribute-value <192-240>
```

Example

```
Switch:1> enable
Switch:1# configure terminal
Switch:1(config)# radius accounting enable
Switch:1(config)# radius accounting include-cli-commands
```

Variable definitions

Use the data in the following table to use the **radius accounting** command.

Variable	Value
enable	Enable RADIUS globally.
include-cli-commands	Include CLI commands in RADIUS accounting updates.
attribute-value <192-240>	Specify the integer value of the CLI commands attribute.

Enabling RADIUS-SNMP accounting**Before you begin**

- You must configure a RADIUS server before you can enable RADIUS-SNMP accounting.

About this task

Enable Remote Access Dial-in User Services (RADIUS) Simple Network Managing Protocol (SNMP) accounting globally. Use SNMP to remotely collect management data. An SNMP agent is a software process that monitors the UDP port 161 for SNMP messages. Each SNMP message sent to the agent contains a list of management objects.

Procedure

1. Enter Global Configuration mode:

RADIUS

```
enable
```

```
configure terminal
```

2. Enable RADIUS Simple Network Management Protocol (SNMP) accounting globally:

```
radius-snmp acct-enable
```

3. Set a timer to send a stop accounting message for RADIUS Simple Network Management Protocol (SNMP):

```
radius-snmp abort-session-timer <30-65535>
```

4. Set the timer for re-authentication of the SNMP session:

```
radius-snmp re-auth-timer <30-65535>
```

5. Specify the user name for SNMP access:

```
radius-snmp user WORD <0-20>
```

Example

```
Switch:1> enable
```

```
Switch:1# configure terminal
```

```
Switch:1(config)# radius-snmp acct-enable
```

```
Switch:1(config)# radius-snmp abort-session-timer 30
```

Variable definitions

Use the data in the following table to use the `radius-snmp` command.

Table 8: Variable definitions

Variable	Value
<code>acct-enable</code>	Enables RADIUS accounting globally. You cannot enable RADIUS accounting before you configure a valid server. The system disables RADIUS accounting by default. The default is false. Use the <code>no</code> option to disable RADIUS accounting globally: <code>no radius-snmp acct-enable</code>
<code>abort-session-timer <30-65535></code>	Set the timer, in seconds, to send a stop accounting message. The default is 180.
<code>re-auth-timer <30-65535></code>	Sets timer for re-authentication of the SNMP session. The timer value ranges from 30 to 65535 seconds. The default is 180.
<code>user WORD <0-20></code>	Specifies the user name for SNMP access. <code>WORD <0-20></code> specifies the user name in a range of 0 to 20 characters. The default is <code>snmp_user</code> .

Configuring RADIUS accounting interim request

About this task

Configure RADIUS accounting interim requests to create a log whenever a user executes more than the number of CLI commands you specify.

If the packet size equals or exceeds 1.8 KB, an interim request packet is sent even if the configured limit is not reached. Therefore, the trigger to send out the interim request is either the configured value or a packet size greater than, or equal to 1.8 KB, whichever happens first.

Procedure

1. Enter Global Configuration mode:

```
enable
configure terminal
```

2. Configure RADIUS accounting interim requests:

```
radius cli-cmd-count <1-40>
```

3. Include or exclude CLI commands in RADIUS accounting:

```
radius accounting include-cli-commands
```

Important:

You must configure the `radius accounting include-cli-commands` command for accounting interim requests to function.

Example

```
Switch:1> enable
Switch:1# configure terminal
Switch:1(config)# radius cli-cmd-count 30
Switch:1(config)# radius accounting include-cli-commands
```

Variable definitions

Use the data in the following table to use the `radius cli-cmd-count` command.

Variable	Value
<1-40>	Specifies how many CLI commands, from 1 to 40, before the system sends a RADIUS accounting interim request. The default value is 40.

Configuring RADIUS authentication and RADIUS accounting attributes

About this task

Configure RADIUS authentication and RADIUS accounting attributes to determine the size of the packets received.

Procedure

1. Enter Global Configuration mode:

```
enable
configure terminal
```
2. Configure the RADIUS authentication attribute value:

```
radius command-access-attribute <192-240>
```
3. Configure the RADIUS accounting attribute value:

```
radius accounting attribute-value <192-240>
```

Example

```
Switch:1>enable
Switch:1#configure terminal
Switch:1(config)#radius command-access-attribute 192
Switch:1(config)#radius accounting attribute-value 192
```

Variable definitions

Use the data in the following table to use the `radius` command.

Variable	Value
access-priority-attribute <192-240>	Specifies the value of the access priority attribute in the range of 192 to 240. The default is 192.
accounting {attribute-value <192-240> enable include-cli-commands}	Configures the accounting attribute value, enable accounting, or configure if accounting includes CLI commands. The default is false. Use the no option to disable the accounting attribute value: <code>no radius accounting enable</code> .
auth-info-attr-value <0-255>	Specifies the value of the authentication information attribute in the range of 0 to 255. The default is 91.
clear-stat	Clears RADIUS statistics.
cli-cmd-count <1-40>	Specifies how many CLI commands, from 1 to 40, before the system sends a RADIUS accounting interim request. The default value is 40.

Table continues...

Variable	Value
cli-commands-attribute <192-240>	Specifies the value of CLI commands attribute in the range of 192 to 240. The default is 195.
cli-profile	Enable RADIUS CLI profiling. CLI profiling grants or denies access to users being authenticated by way of the RADIUS server. You can add a set of CLI commands to the configuration on the RADIUS server, and you can specify the command-access more for these commands. The default is false.
command-access-attribute <192-240>	Specifies the value of the command access attribute in the range of 192 to 240. The default is 194.
enable	Enable RADIUS authentication globally on the switch.
maxserver <1-10>	Specific to RADIUS authentication, configures the maximum number of servers allowed for the device. The range is between 1 and 10. The default is 10.
mcast-addr-attr-value <0-255>	Specifies the value of the multicast address attribute in the range of 0 to 255. The default is 90.
server host <i>WORD</i> <0-46> key <i>WORD</i> <0-32> [used-by {cli snmp web} [acct-enable] [acct-port <1-65536>] [enable] [port <1-65536>] [priority <1-10>] [retry <0-6>] [source-ip <i>WORD</i> <0-46>] [timeout <1-60>]	<ul style="list-style-type: none"> • host <i>WORD</i><0-46> Creates a host server. <i>WORD</i><0-46> signifies an IP address. • key <i>WORD</i><0-32> Specifies a secret key in the range of 0-32 characters. • used-by {<i>cli</i> <i>snmp</i> <i>web</i>} Specifies how the server functions. Configures the server for authentication for <ul style="list-style-type: none"> - cli - snmp - web • acct-enable Enables RADIUS accounting on this server. The system enables RADIUS accounting by default. • acct-port <1-65536> Specifies a UDP port of the RADIUS accounting server (1 to 65536). The default value is 1816. The UDP port value set for the client must match the UDP value set for the RADIUS server. • enable Enables the server. The default is true. • port <1-65536> Specifies a UDP port of the RADIUS server. The default value is 1812.

Table continues...

Variable	Value
	<ul style="list-style-type: none"> • priority <1–10> Specifies the priority value for this server. The default is 10. • retry <0–6> Specifies the maximum number of authentication retries. The default is 3. • source-ip WORD<0–46> Specifies a configured IP address as the source address when transmitting RADIUS packets. WORD<0–46> signifies an IP address. • timeout <1–60> Specifies the number of seconds before the authentication request times out. The default is 3.
sourceip-flag	<p>Enable the source IP so the switch uses a configured source IP address. If the outgoing interface on the switch fails, a different source IP address is used — requiring that you make configuration changes to define the new RADIUS client on the RADIUS server. To simplify RADIUS server configuration, you can configure the switch to use a Circuitless IP (CLIP) address as the source IP and NAS IP address when transmitting RADIUS packets. A CLIP is not associated with a physical interface and is always in an active and operational state. You can configure the switch with multiple CLIP interfaces.</p> <p>By default, the switch uses the IP address of the outgoing interface as the source IP, and the NAS Ip address for RADIUS packets that it transmits.</p>

Adding a RADIUS server

About this task

Add a RADIUS server to allow RADIUS service on the switch.

RADIUS supports IPv4 and IPv6 addresses, with no difference in functionality or configuration using CLI.

Procedure

1. Enter Global Configuration mode:

```
enable
```

```
configure terminal
```

2. Add a RADIUS server:

```
radius server host WORD <0-46> key WORD<0-32> [used-by {cli|snmp|
web}] [acct-enable][acct-port <1-65536>] [enable] [port <1-65536>]
[priority <1-10>][retry <0-6>] [source-ip WORD <0-46>] [timeout
<1-60>]
```

Example

```
Switch:1>enable
```

```
Switch:1#configure terminal
```

Add a RADIUS server:

```
Switch:1(config)#radius server host
4717:0000:0000:0000:0000:0000:7933:0001 key testkey1 used-by snmp port 12
retry 5 timeout 10 enable
```

Variable definitions

Use the data in the following table to use the **radius server** command.

Variable	Value
host WORD <0-46>	Creates a host server. WORD <0-46> signifies an IPv4 address in the format A.B.C.D or an IPv6 address in the format x:x:x:x:x:x. RADIUS supports IPv4 and IPv6 addresses, with no difference in functionality or configuration using CLI.
key WORD<0-32>	Specifies a secret key in the range of 0-32 characters.
used-by {cli snmp web}	Specifies how the server functions <ul style="list-style-type: none"> cli—configure the server for CLI authentication. snmp—configure the server for SNMP authentication. web—configure the server for http(s) authentication Use the no option to remove a host server: no radius server host WORD<0-46> used-by {cli snmp web} . The default is cli. The default command is: default radius server host WORD<0-46> used-by {cli snmp web}
acct-enable	Enables RADIUS accounting on this server. The system enables RADIUS accounting by default.
acct-port <1-65536>	Specifies a UDP port of the RADIUS accounting server (1 to 65536). The default value is 1816. <p>! Important:</p> The UDP port value set for the client must match the UDP value set for the RADIUS server.
enable	Enables this server. The default is true.

Table continues...

Variable	Value
port <1-65536>	Specifies a UDP port of the RADIUS server. The default value is 1812.
priority <1-10>	Specifies the priority value for this server. The default is 10.
retry <0-6>	Specifies the maximum number of authentication retries. The default is 3.
source-ip WORD <0-46>	Specifies a configured IP address as the source address when transmitting RADIUS packets. WORD <0-46> signifies an IPv4 address in the format A.B.C.D or an IPv6 address in the format x:x:x:x:x:x. RADIUS supports IPv4 and IPv6 addresses, with no difference in functionality or configuration using CLI.
timeout <1-60>	Specifies the number of seconds before the authentication request times out. The default is 3.

Modifying RADIUS server settings

About this task

Change a specified RADIUS server value without having to delete the server and recreate it again.

RADIUS supports IPv4 and IPv6 addresses, with no difference in functionality or configuration using CLI.

Procedure

1. Enter Global Configuration mode:

```
enable
configure terminal
```

2. Modify a RADIUS server:

```
radius server host WORD <0-46> [used-by {cli|eapol|snmp|web}] [key
WORD<0-20>] [port 1-65536] [priority <1-10>] [retry <0-6>] [timeout
<1-20>] [enable] [acct-port <1-65536>] [acct-enable] [source-ip WORD
<0-46>]
```

Example

```
Switch:1>enable
Switch:1#configure terminal
```

Modify a RADIUS server:

```
Switch:1(config)#radius server host
4717:0000:0000:0000:0000:0000:7933:0001 used-by snmp port 12 retry 5
timeout 10 enable
```

Variable definitions

Use the data in the following table to use the `radius server host` command.

Variable	Value
used-by {cli eapol snmp web}	<p>Specifies how the server functions</p> <ul style="list-style-type: none"> • cli—configure the server for CLI authentication. • eapol—configure the server for EAPoL authentication. • snmp—configure the server for SNMP authentication. • web—configure the server for Web authentication. <p>Use the no option to remove a host server: <code>no radius server host WORD<0-46> used-by {cli snmp web}</code>. The default is cli. The default command is: <code>default radius server host WORD<0-46> used-by {cli snmp web}</code>.</p>
host WORD <0-46>	<p>Configures a host server. WORD <0-46> signifies an IPv4 address in the format A.B.C.D or an IPv6 address in the format x:x:x:x:x:x. RADIUS supports IPv4 and IPv6 addresses, with no difference in functionality or configuration using CLI.</p>
acct-enable	<p>Enables RADIUS accounting on this server. The system enables RADIUS accounting by default.</p>
acct-port <1-65536>	<p>Configures the UDP port of the RADIUS accounting server (1 to 65536). The default value is 1813.</p> <p>! Important:</p> <p>The UDP port value set for the client must match the UDP value set for the RADIUS server.</p>
enable	<p>Enables the RADIUS server. The default is true.</p>
key WORD <0-20>	<p>Configures the secret key of the authentication client.</p>
port <1-65536>	<p>Configures the UDP port of the RADIUS authentication server (1 to 65536). The default value is 1812.</p>
priority <1-10>	<p>Configures the priority value for this server (1 to 10). The default is 10.</p>
retry <0-6>	<p>Configures the number of authentication retries the server will accept (0 to 6). The default is 3.</p>
source-ip WORD <0-46>	<p>Specifies a configured IP address as the source address when transmitting RADIUS packets. To use this option, you must have the global RADIUS sourceip-flag set to true. RADIUS supports IPv4 and IPv6 addresses, with no difference in functionality or configuration using CLI.</p>
timeout <1-20>	<p>Configures the number of seconds before the authentication request times out (1 to 20). The default is 3.</p>

Showing RADIUS information

Display the global status of RADIUS information to ensure you configured the RADIUS feature according to the needs of the network.

Procedure

1. Log on to the switch to enter User EXEC mode.
2. Display the global status of RADIUS information:

```
show radius
```

Example

```
Switch:1>show radius
      acct-attribute-value : 193
          acct-enable     : false
acct-include-cli-commands : false
access-priority-attribute : 192
      auth-info-attr-value : 91
command-access-attribute  : 194
      cli-commands-attribute : 195
          cli-cmd-count    : 40
      cli-profile-enable   : false
          enable          : false
          maxserver       : 10
mcast-addr-attr-value    : 90
      sourceip-flag      : false
```

Displaying RADIUS server information

If your system is configured with a RADIUS server you can display the RADIUS server information.

Procedure

1. Log on to the switch to enter User EXEC mode.
2. To display the RADIUS server information enter the following command:

```
show radius-server
```

* Note:

If no RADIUS server is configured, the system displays the following message:

```
no RADIUS server configured
```

Example

```
Switch:1>show radius-server
```

```
=====
                        Radius Server Entries
=====
Name                    USED          TIME EN-  ACCT EN-  SOURE
                        BY  SECRET PORT PRIO  RETRY  OUT ABLED  PORT ABLED  IP
```

```

1.1.1.1          cli ***** 1812 10 1 3 true 1813 true 0.0.0.0
1000:0:0:0:0:0:1 cli ***** 1812 10 1 3 true 1813 true 0:0:0:0:0:0:0
10.10.10.10     cli ***** 1812 10 1 3 true 1813 true 0.0.0.0
4000:0:0:0:0:0:1 cli ***** 1812 10 1 3 true 1813 true 0:0:0:0:0:0:0

```

Showing RADIUS SNMP configurations

Display current RADIUS SNMP configurations.

Procedure

1. Log on to the switch to enter User EXEC mode.
2. Display the current RADIUS server SNMP configurations:

```
show radius snmp
```

Example

```

Switch:1>show radius snmp
      abort-session-timer : 180
      acct-enable       : false
      user              : snmp_user
      enable            : false
      re-auth-timer     : 180

```

RADIUS configuration using Enterprise Device Manager

You can configure Remote Access Dial-In User Services (RADIUS) to assist in securing networks against unauthorized access, and allow communication servers and clients to authenticate the identity of users through a central database.

The database within the RADIUS server stores client information, user information, password, and access privileges, including the use of shared secret.

RADIUS supports IPv4 and IPv6 addresses with no difference in functionality or configuration in all but the following case. When adding a RADIUS server in Enterprise Device Manager (EDM) or modifying a RADIUS configuration in EDM, you must specify if the address type is an IPv4 or an IPv6 address.

RADIUS is a fully open and standard protocol, defined by RFCs (Authentication: RFC2865, accounting RFC2866). With the switch, you use RADIUS authentication to secure access to the device (console/Telnet/SSH), and RADIUS accounting to track the management sessions for Command Line Interface (CLI) only.

RADIUS authentication allows the remote server to authenticate logons. RADIUS accounting logs all of the activity of each remote user in a session on the centralized RADIUS accounting server.

Enabling RADIUS authentication

About this task

Enable RADIUS authentication globally to allow all features and functions of RADIUS to operate with the RADIUS server.

Procedure

1. In the navigation tree, open the following folders: **Configuration > Security > Control Path**.
2. Click **RADIUS**.
3. In the **RADIUS Global** tab, select the **Enable** check box.
4. In the **MaxNumberServer** field, type a value for the maximum number of servers.
5. In the **AccessPriorityAttrValue** field, type an access policy value (by default, this value is 192).
6. Configure the rest of the parameters in the RADIUS global tab.
7. Click **Apply**.

RADIUS Global field descriptions

Use the data in the following table to use the **RADIUS Global** tab.

Name	Description
Enable	Enables the RADIUS authentication feature globally.
MaxNumberServer	Specifies the maximum number of servers to be used, between 1 and 10, inclusive.
AccessPriorityAttrValue	Specific to RADIUS authentication. Specifies the vendor-specific attribute value of the access-priority attribute to match the type value set in the dictionary file on the RADIUS server. The valid values are 192 through 240. The default is 192.
AcctEnable	Enables RADIUS accounting.
AcctAttriValue	Specific to RADIUS accounting. Specifies the vendor-specific attribute value of the CLI-command attribute to match the type value set in the dictionary file on the RADIUS server. This value must be different from the access-priority attribute value configured for authentication. The valid values are 192 through 240. The default value is 193.
AcctIncludeCli	Specifies whether you want CLI commands included in RADIUS accounting requests.
ClearStat	Clears RADIUS statistics from the device.
McastAttributeValue	Specifies the value of the Mcast attribute. The valid values are 0 through 255. The default value is 90.

Table continues...

Name	Description
AuthInfoAttrValue	Specifies the value of the authentication information attribute. The valid values are 0 through 255. The default value is 91.
CommandAccessAttrValue	Specifies the value of the command access attribute. The valid values are 192 through 240. The default value is 194.
CliCommandAttrValue	Specifies the value of the CLI command attribute. The valid values are 192 through 240. The default value is 195.
AuthInvalidServerAddress	Displays the number of access responses from unknown or invalid RADIUS servers.
SourceIpFlag	Includes a configured IP address as the source address in RADIUS packets. The default is false. RADIUS supports IPv4 and IPv6 addresses with no difference in functionality or configuration.
CliCmdCount	Gives the value for the CLI command count. Specify an integer from 1 to 40. The default is 40.
CliProfEnable	Enables RADIUS CLI profiling.

Enabling RADIUS accounting

Before you begin

- You must set up a RADIUS server and add it to the configuration file of the device before you can enable RADIUS accounting on the device. Otherwise, the system displays an error message.

About this task

Enable RADIUS accounting to log all of the activity of each remote user in a session on the centralized RADIUS accounting server.

Procedure

- In the navigation tree, open the following folders: **Configuration > Security > Control Path**.
- Click **RADIUS**.
- In the **RADIUS Global** tab, select the **AcctEnable** check box.
- In the **AcctAttrValue** field, type an access policy value (by default, this value is 193).
- Click **Apply**.

RADIUS Global field descriptions

Use the data in the following table to use the **RADIUS Global** tab.

Name	Description
Enable	Enables the RADIUS authentication feature globally.

Table continues...

Name	Description
MaxNumberServer	Specifies the maximum number of servers to be used, between 1 and 10, inclusive.
AccessPriorityAttrValue	Specific to RADIUS authentication. Specifies the vendor-specific attribute value of the access-priority attribute to match the type value set in the dictionary file on the RADIUS server. The valid values are 192 through 240. The default is 192.
AcctEnable	Enables RADIUS accounting.
AcctAttriValue	Specific to RADIUS accounting. Specifies the vendor-specific attribute value of the CLI-command attribute to match the type value set in the dictionary file on the RADIUS server. This value must be different from the access-priority attribute value configured for authentication. The valid values are 192 through 240. The default value is 193.
AcctIncludeCli	Specifies whether you want CLI commands included in RADIUS accounting requests.
ClearStat	Clears RADIUS statistics from the device.
McastAttributeValue	Specifies the value of the Mcast attribute. The valid values are 0 through 255. The default value is 90.
AuthInfoAttrValue	Specifies the value of the authentication information attribute. The valid values are 0 through 255. The default value is 91.
CommandAccessAttrValue	Specifies the value of the command access attribute. The valid values are 192 through 240. The default value is 194.
CliCommandAttrValue	Specifies the value of the CLI command attribute. The valid values are 192 through 240. The default value is 195.
AuthInvalidServerAddress	Displays the number of access responses from unknown or invalid RADIUS servers.
SourceIpFlag	Includes a configured IP address as the source address in RADIUS packets. The default is false. RADIUS supports IPv4 and IPv6 addresses with no difference in functionality or configuration.
CliCmdCount	Gives the value for the CLI command count. Specify an integer from 1 to 40. The default is 40.
CliProfEnable	Enables RADIUS CLI profiling.

Disabling RADIUS accounting

Before you begin

- You cannot globally disable RADIUS accounting unless a server entry exists.

About this task

Disabling RADIUS accounting removes the accounting function from the RADIUS server.

Procedure

1. In the navigation tree, open the following folders: **Configuration > Security > Control Path**.
2. Click **RADIUS**.
3. In the **RADIUS Global** tab, disable RADIUS accounting by clearing the **AcctEnable** check box.
4. Click **Apply**.

Enabling RADIUS accounting interim request**About this task**

Enable the RADIUS accounting interim request feature to create a log whenever more than the specified number of CLI commands are executed.

Procedure

1. In the navigation tree, open the following folders: **Configuration > Security > Control Path**.
2. Click **RADIUS**.
3. In the **RADIUS Global** tab, type the number of CLI commands in the **CliCmdCount** field.
4. Click **Apply**.

RADIUS Global field descriptions

Use the data in the following table to use the **RADIUS Global** tab.

Name	Description
Enable	Enables the RADIUS authentication feature globally.
MaxNumberServer	Specifies the maximum number of servers to be used, between 1 and 10, inclusive.
AccessPriorityAttrValue	Specific to RADIUS authentication. Specifies the vendor-specific attribute value of the access-priority attribute to match the type value set in the dictionary file on the RADIUS server. The valid values are 192 through 240. The default is 192.
AcctEnable	Enables RADIUS accounting.
AcctAttriValue	Specific to RADIUS accounting. Specifies the vendor-specific attribute value of the CLI-command attribute to match the type value set in the dictionary file on the RADIUS server. This value must be different from the access-priority attribute value configured for authentication. The valid values are 192 through 240. The default value is 193.
AcctIncludeCli	Specifies whether you want CLI commands included in RADIUS accounting requests.

Table continues...

Name	Description
ClearStat	Clears RADIUS statistics from the device.
McastAttributeValue	Specifies the value of the Mcast attribute. The valid values are 0 through 255. The default value is 90.
AuthInfoAttrValue	Specifies the value of the authentication information attribute. The valid values are 0 through 255. The default value is 91.
CommandAccessAttrValue	Specifies the value of the command access attribute. The valid values are 192 through 240. The default value is 194.
CliCommandAttrValue	Specifies the value of the CLI command attribute. The valid values are 192 through 240. The default value is 195.
AuthInvalidServerAddress	Displays the number of access responses from unknown or invalid RADIUS servers.
SourceIpFlag	Includes a configured IP address as the source address in RADIUS packets. The default is false. RADIUS supports IPv4 and IPv6 addresses with no difference in functionality or configuration.
CliCmdCount	Gives the value for the CLI command count. Specify an integer from 1 to 40. The default is 40.
CliProfEnable	Enables RADIUS CLI profiling.

Configuring the source IP option for the RADIUS server

Before you begin

- To configure the CLIP as the source IP address, you must configure the global RADIUS **sourceip-flag** parameter as true. You can configure the **source-ip** address parameter while you define the RADIUS Server on the switch. The source IP address must be a CLIP address, and you can configure a different CLIP address for each RADIUS server. For more information about configuring the source IP address, see [Adding a RADIUS server](#) on page 236.

! Important:

Use the source IP option only for the RADIUS servers connected to the in-band network.

About this task

By default, the switch uses the IP address of the outgoing interface as the source IP and NAS IP address for RADIUS packets that it transmits. When you configure the RADIUS server, this IP address is used when defining the RADIUS Clients that communicate with it. Therefore, if the outgoing interface on the switch fails, a different source IP address is used—requiring that you make configuration changes to define the new RADIUS client on the RADIUS server.

To simplify RADIUS Server configuration, you can configure the switch to use a Circuitless IP Address (CLIP) as the source IP and NAS IP address when transmitting RADIUS packets. A CLIP is not associated with a physical interface and is always in an active and operational state. You can configure the switch with multiple CLIP interfaces.

RADIUS supports IPv4 and IPv6 addresses with no difference in functionality or configuration in all but the following case. When adding a RADIUS server in Enterprise Device Manager (EDM) or

modifying a RADIUS configuration in EDM, you must specify if the address type is an IPv4 or an IPv6 address.

Procedure

1. In the navigation tree, open the following folders: **Configuration > Security > Control Path**.
2. Click **RADIUS**.
3. In the **RADIUS Global** tab, select the **SourceIpFlag** check box.
4. Click **Apply**.

RADIUS Global field descriptions

Use the data in the following table to use the **RADIUS Global** tab.

Name	Description
Enable	Enables the RADIUS authentication feature globally.
MaxNumberServer	Specifies the maximum number of servers to be used, between 1 and 10, inclusive.
AccessPriorityAttrValue	Specific to RADIUS authentication. Specifies the vendor-specific attribute value of the access-priority attribute to match the type value set in the dictionary file on the RADIUS server. The valid values are 192 through 240. The default is 192.
AcctEnable	Enables RADIUS accounting.
AcctAttriValue	Specific to RADIUS accounting. Specifies the vendor-specific attribute value of the CLI-command attribute to match the type value set in the dictionary file on the RADIUS server. This value must be different from the access-priority attribute value configured for authentication. The valid values are 192 through 240. The default value is 193.
AcctIncludeCli	Specifies whether you want CLI commands included in RADIUS accounting requests.
ClearStat	Clears RADIUS statistics from the device.
McastAttributeValue	Specifies the value of the Mcast attribute. The valid values are 0 through 255. The default value is 90.
AuthInfoAttrValue	Specifies the value of the authentication information attribute. The valid values are 0 through 255. The default value is 91.
CommandAccessAttrValue	Specifies the value of the command access attribute. The valid values are 192 through 240. The default value is 194.
CliCommandAttrValue	Specifies the value of the CLI command attribute. The valid values are 192 through 240. The default value is 195.
AuthInvalidServerAddress	Displays the number of access responses from unknown or invalid RADIUS servers.

Table continues...

Name	Description
SourcelpFlag	Includes a configured IP address as the source address in RADIUS packets. The default is false. RADIUS supports IPv4 and IPv6 addresses with no difference in functionality or configuration.
CliCmdCount	Gives the value for the CLI command count. Specify an integer from 1 to 40. The default is 40.
CliProfEnable	Enables RADIUS CLI profiling.

Adding a RADIUS server

About this task

Add a RADIUS server to allow RADIUS service on the switch.

Remote Dial-In User Services (RADIUS) supports both IPv4 and IPv6 addresses, with no differences in functionality or configuration in all but the following case. When adding a RADIUS server or updating a RADIUS server in Enterprise Device Manager (EDM) you must specify if the address type is an IPv4 or an IPv6 address.

Procedure

1. In the navigation tree, open the following folders: **Configuration > Security > Control Path**.
2. Click **RADIUS**.
3. Click the **RADIUS Servers** tab.
4. Click **Insert**.
5. In the **AddressType** box, select IPv4 or IPv6.
6. In the **Address** box, type the IP address of the RADIUS server that you want to add.
7. In the **UsedBy** box, select an option for the user logon.
8. In the **SecretKey** box, type a secret key.
9. In the **SourcelpAddr** box, type the IP address to use as the source address in RADIUS packets.
10. Click **Insert**.

RADIUS Servers field descriptions

Use the data in the following table to use the **RADIUS Servers** tab.

Name	Description
AddressType	Specifies either an IPv4 or an IPv6 address. RADIUS supports IPv4 and IPv6 addresses.
Address	Specifies the IP address of the RADIUS server. RADIUS supports IPv4 and IPv6 addresses.

Table continues...

Name	Description
UsedBy	Specifies the user logon. <ul style="list-style-type: none"> cli: for cli logon eap: for EAPoL authentication snmp: for snmp logon web: for HTTP(s) access authentication The default is cli.
Priority	Specifies the priority of each server, or the order of servers to send authentication (1 to 10). The default is 10.
TimeOut	Specifies the time interval in seconds before the client retransmits the packet (1 to 20).
Enable	Enables or disables authentication on the server. The default is true.
MaxRetries	Specifies the maximum number of retransmissions allowed (1 to 6). The default is 1.
UdpPort	Specifies the UDP port that the client uses to send requests to the server (1 to 65536). The default value is 1812. The UDP port value set for the client must match the UDP value set for the RADIUS server.
SecretKey	Specifies the RADIUS server secret key, which is the password used by the client to be validated by the server.
AcctEnable	Enables or disable RADIUS accounting. The default is true.
AcctUdpPort	Specifies the UDP port of the RADIUS accounting server (1 to 65536). The default value is 1813. The UDP port value set for the client must match the UDP value set for the RADIUS server.
SourceIpAddr	Specifies the IP address to use as the source address in RADIUS packets. To use this option, you must set the global RADIUS SourceIpFlag to true. RADIUS supports IPv4 and IPv6 addresses.

Reauthenticating the RADIUS SNMP server session

About this task

Specify the number of challenges that you want the RADIUS SNMP server to send to authenticate a given session.

Procedure

1. In the navigation tree, open the following folders: **Configuration > Security > Control Path**.
2. Click **RADIUS**.
3. Click the **RADIUS SNMP** tab.

The RADIUS SNMP tab appears.

4. Select the **Enable** check box.
5. In the **ReauthenticateTimer** field, enter a value to specify the interval between RADIUS SNMP server reauthentications.

The timer for reauthentication of the RADIUS SNMP server session is enabled.

! Important:

To abort the RADIUS SNMP server session, enter a value for the `AbortSessionTimer`, and then click **Enable**.

6. Select the **AcctEnable** check box if desired.
7. Click **Apply**.

RADIUS SNMP field descriptions

Use the data in the following table to use the **RADIUS SNMP** tab.

Name	Description
Enable	Enables or disables timer authentication on the server. The default is true.
AbortSessionTimer	Specifies the allowable time, in seconds, before aborting the RADIUS SNMP server session (30 to 65535). The default is 180.
ReAuthenticateTimer	Specifies the time, in seconds, between reauthentications of the RADIUS SNMP server (30 to 65535). The default is 180.
AcctEnable	Enables or disables the RADIUS SNMP session timer.
UserName	Specifies the user name for the RADIUS SNMP accounting.

Configuring RADIUS SNMP

About this task

Configure RADIUS SNMP parameters for authentication and session times.

Procedure

1. In the navigation tree, open the following folders: **Configuration > Security > Control Path**.
2. Click **RADIUS**.
3. Select the **RADIUS SNMP** tab.
4. Select the **Enable** check box to enable RADIUS SNMP.
5. In the **AbortSessionTimer** field, enter the period after which the session expires in seconds.
6. In the **ReAuthenticateTimer** field, enter the period of time the system waits before reauthenticating in seconds.
7. Select the **AcctEnable** check box to enable RADIUS accounting for SNMP.

8. In the **UserName** field, type the RADIUS SNMP user name.
9. Click **Apply**.

RADIUS SNMP field descriptions

Use the data in the following table to use the **RADIUS SNMP** tab.

Name	Description
Enable	Enables or disables timer authentication on the server. The default is true.
AbortSessionTimer	Specifies the allowable time, in seconds, before aborting the RADIUS SNMP server session (30 to 65535). The default is 180.
ReAuthenticateTimer	Specifies the time, in seconds, between reauthentications of the RADIUS SNMP server (30 to 65535). The default is 180.
AcctEnable	Enables or disables the RADIUS SNMP session timer.
UserName	Specifies the user name for the RADIUS SNMP accounting.

Modifying a RADIUS configuration

About this task

Use this procedure to modify an existing RADIUS configuration or single function such as retransmissions and RADIUS accounting.

RADIUS supports IPv4 and IPv6 addresses with no difference in functionality or configuration in all except the following case. When modifying a RADIUS configuration in Enterprise Device Manager (EDM), you must specify if the address type is an IPv4 or an IPv6 address.

Procedure

1. In the navigation tree, open the following folders: **Configuration > Security > Control Path**.
2. Click **RADIUS**.
3. Click the **RADIUS Servers** tab.
4. In the row and field to modify, type the information or use the lists to make a selection.
Access the lists by double-clicking in a field.
5. When you are done with modifying the RADIUS configuration, click **Apply**.

RADIUS Servers field descriptions

Use the data in the following table to use the **RADIUS Servers** tab.

Name	Description
AddressType	Specifies either an IPv4 or an IPv6 address. RADIUS supports IPv4 and IPv6 addresses.
Address	Specifies the IP address of the RADIUS server. RADIUS supports IPv4 and IPv6 addresses.

Table continues...

Name	Description
UsedBy	Specifies the user logon. <ul style="list-style-type: none"> cli: for cli logon eap: for EAPoL authentication snmp: for snmp logon web: for HTTP(s) access authentication The default is cli.
Priority	Specifies the priority of each server, or the order of servers to send authentication (1 to 10). The default is 10.
TimeOut	Specifies the time interval in seconds before the client retransmits the packet (1 to 20).
Enable	Enables or disables authentication on the server. The default is true.
MaxRetries	Specifies the maximum number of retransmissions allowed (1 to 6). The default is 1.
UdpPort	Specifies the UDP port that the client uses to send requests to the server (1 to 65536). The default value is 1812. The UDP port value set for the client must match the UDP value set for the RADIUS server.
SecretKey	Specifies the RADIUS server secret key, which is the password used by the client to be validated by the server.
AcctEnable	Enables or disable RADIUS accounting. The default is true.
AcctUdpPort	Specifies the UDP port of the RADIUS accounting server (1 to 65536). The default value is 1813. The UDP port value set for the client must match the UDP value set for the RADIUS server.
SourceIpAddr	Specifies the IP address to use as the source address in RADIUS packets. To use this option, you must set the global RADIUS SourceIpFlag to true. RADIUS supports IPv4 and IPv6 addresses.

Deleting a RADIUS configuration

About this task

Delete an existing RADIUS configuration.

Procedure

1. In the navigation tree, open the following folders: **Configuration > Security > Control Path**.
2. Click **RADIUS**.
3. Click the **RADIUS Servers** tab.
4. Identify the configuration to delete by clicking anywhere in the row.

5. Click **Delete**.

Chapter 9: Simple Network Management Protocol (SNMP)

You can use the Simple Network Management Protocol (SNMP) to remotely collect management data and configure devices.

An SNMP agent is a software process that monitors the UDP port 161 for SNMP messages. Each SNMP message sent to the agent contains a list of management objects to retrieve or modify.

SNMPv3

The SNMP version 3 (v3) is the third version of the Internet Standard Management Framework and is derived from and builds upon both the original Internet Standard Management Framework SNMP version 1 (v1) and the second Internet Standard Management Framework SNMP version 2 (v2).

The SNMPv3 is not a stand-alone replacement for SNMPv1 or SNMPv2. The SNMPv3 defines security capabilities you must use in conjunction with SNMPv2 (preferred) or SNMPv1. The following figure shows how SNMPv3 specifies a user-based security model (USM) that uses a payload of either an SNMPv1 or an SNMPv2 Protocol Data Unit (PDU).

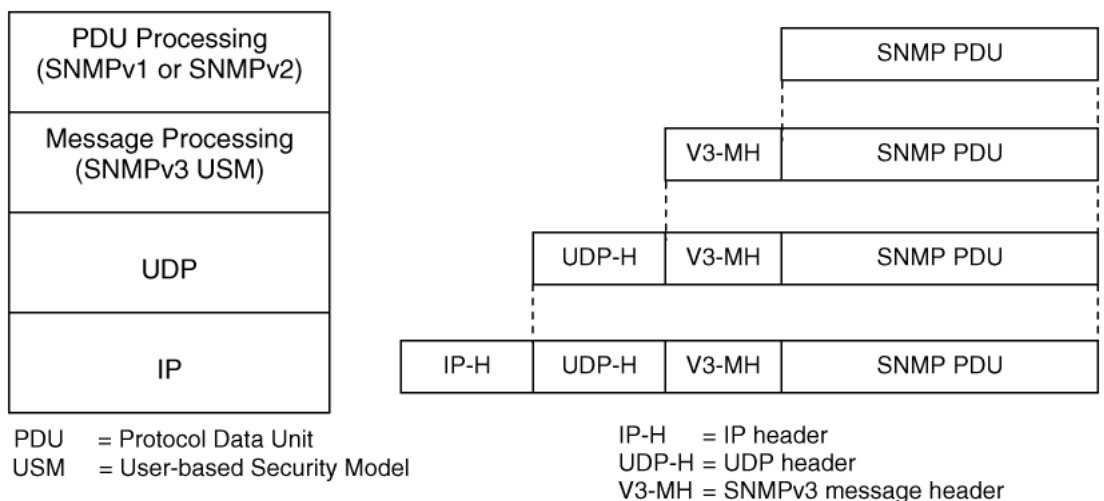

Figure 27: SNMPv3 USM

SNMPv3 is an SNMP framework that supplements SNMPv2 by supporting the following:

- New SNMP message formats
- Security for messages
- Access control
- Remote configuration of SNMP parameters

The recipient of a message can use authentication within the USM to verify the message sender and to detect if the message is altered. According to RFC2574, if you use authentication, the USM checks the entire message for integrity.

An SNMP entity is an implementation of this architecture. Each SNMP entity consists of an SNMP engine and one or more associated applications.

SNMP engine

An SNMP engine provides services for sending and receiving messages, authenticating and encrypting messages, and controlling access to managed objects. A one-to-one association exists between an SNMP engine and the SNMP entity, which contains the SNMP engine.

EngineID

Within an administrative domain, an EngineID is the unique identifier of an SNMP engine. Because there is a one-to-one association between SNMP engines and SNMP entities, the ID also uniquely and unambiguously identifies the SNMP entity within that administrative domain. The system generates an EngineID during the startup process. The SNMP engine contains a:

- [Dispatcher](#) on page 243.
- [Message processing subsystem](#) on page 243.
- [Security subsystem](#) on page 243.
- [Access control subsystem](#) on page 244.

Dispatcher

The dispatcher is part of an SNMP engine. You can use the dispatcher for concurrent support of multiple versions of SNMP messages in the SNMP engine through the following ways:

- To send and receive SNMP messages to and from the network.
- To determine the SNMP message version and interact with the corresponding message processing model.
- To provide an abstract interface to SNMP applications for delivery of a PDU to an application.
- To provide an abstract interface for SNMP applications to send a PDU to a remote SNMP entity.

Message processing subsystem

The message processing subsystem prepares messages for sending and extracts data from received messages. The subsystem can contain multiple message processing models.

Security subsystem

The security subsystem provides the following features:

- Authentication

- Privacy
- Security

Authentication

You can use authentication within the SNMPv3 to verify the message sender and whether the message is altered. If you use authentication, the integrity of the message is verified. The supported SNMPv3 authentication protocols are HMAC-MD5 and HMAC-SHA-96. By default, the switch uses HMAC-SHA1-96 with 160-bit key length.

Privacy

SNMPv3 is an encryption protocol for privacy. Only the data portion of a message is encrypted; the header and the security parameters are not. The privacy protocol that SNMPv3 supports is CBC-DES Symmetric Encryption Protocol and Advanced Encryption Standard (AES).

Security

The SNMPv3 security protects against:

- Modification of information—protects against altering information in transit.
- Masquerade—protects against an unauthorized entity assuming the identity of an authorized entity.
- Message stream modification—protects against delaying or replaying messages.
- Disclosure—protects against eavesdropping.

The SNMPv3 security also offers:

- Discovery procedure—finds the EngineID of an SNMP entity for a given transport address or transport endpoint address.
- Time synchronization procedure—facilitates authenticated communication between entities

The SNMPv3 does not protect against the following:

- Denial-of-service—prevention of exchanges between manager and agent.
- Traffic analysis—general pattern of traffic between managers and agents.

Access control subsystem

SNMPv3 provides a group option for access policies.

The access policy feature in the switch determines the access level for the users connecting to the device with different services like File Transfer Protocol (FTP), Trivial FTP (TFTP), Telnet, and rlogin. The system access policy feature is based on the user access levels and network address. This feature covers services, such as TFTP, HTTP, SSH, rlogin, and SNMP. However, with the SNMPv3 engine, the community names do not map to an access level. The View-based Access Control Model (VACM) determines the access privileges.

Use the configuration feature to specify groups for the SNMP access policy. You can use the access policy services to cover SNMP. Because the access restriction is based on groups defined through the VACM, the synchronization is made using the SNMPv3 VACM configuration. The administrator uses this feature to create SNMP users (USM community) and associate them to groups. You can configure the access policy for each group and network.

The following are feature specifications for the group options:

- After you enable SNMP service, this policy covers all users associated with the groups configured under the access policy. The access privileges are based on access allow or deny. If you select

allow, the VACM configuration determines the management information base (MIB)-views for access.

- The SNMP service is disabled by default for all access policies.
- The access level configured under `access-policy policy <id>` does not affect SNMP service. The VACM configuration determines the SNMP access rights.

User-based security model

In a USM system, the security model uses a defined set of user identities for any authorized user on a particular SNMP engine. A user with authority on one SNMP engine must also have authorization on all SNMP engines with which the original SNMP engine communicates.

The USM provides the following levels of communication:

- NoAuthNoPriv—communication without authentication and privacy.
- AuthNoPriv—communication with authentication and without privacy.
- AuthPriv—communication with authentication and privacy.

The following figure shows the relationship between USM and VACM.

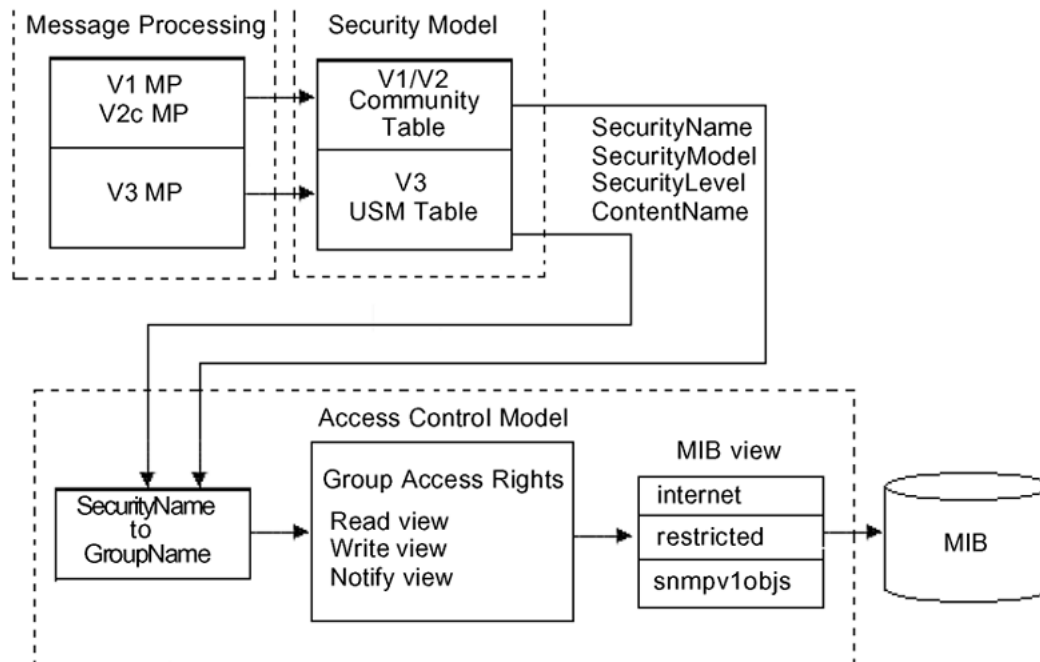

Figure 28: USM association with VACM

View-based Access Control

View-based Access Control Model (VACM) provides group access, group security levels, and context based on a predefined subset of MIB objects. These MIB objects define a set of managed objects and instances.

VACM is the standard access control mechanism for SNMPv3, and it provides:

- Authorization service to control access to MIB objects at the PDU level.

- Alternative access control subsystems.

The access is based on principal, security level, MIB context, object instance, and type of access requested (read or write). You can use the VACM MIB to define the policy and control remote management.

SNMPv3 encryption

A user-based security port for SNMPv3 is defined as a security subsystem within an SNMP engine. The switch USM uses HMAC-MD5-96 and HMAC-SHA-96 as the authentication protocols, and CBC-DES as the privacy protocol. Use USM to use other protocols instead of, or concurrently with, these protocols. CFB128-AES-128, an AES-based Symmetric Encryption Protocol, is an alternative privacy protocol for the USM.

The AES standard is the current encryption standard, Federal Information Processing Standard 140-2 (FIPS 140-2), intended to be used by the U.S. Government organizations to protect sensitive information. The AES standard is also becoming a global standard for commercial software and hardware that uses encryption or other security features.

The AES-based symmetric encryption protocol

This symmetric encryption protocol provides support for data confidentiality. The system encrypts the designated portion of the SNMP message and includes it as part of the transmitted message.

The USM specifies that the scoped PDU is the portion of the message that requires encryption. An SNMP engine that can legitimately originate messages on behalf of the appropriate user shares a secret value, in combination with a timeliness value and a 64-bit integer, used to create the (localized) encryption/decryption key and the initialization vector.

The AES encryption key and Initialization Vector

The AES encryption key uses the first 128 bits of the localized key. The 128-bit Initialization Vector (IV) is the combination of the authoritative SNMP engine 32-bit snmpEngineBoot, the SNMP engine 32-bit snmpEngineTime, and a local 64-bit integer. The system initializes the 64-bit integer to a pseudo-random value at startup time.

Data encryption

The switch handles data encryption in the following manner:

1. The system treats data as a sequence of octets.
2. The system divides the plaintext into 128-bit blocks.
The first input block is the IV, and the forward cipher operation is applied to the IV to produce the first output block.
3. The system produces the first cipher text block by executing an exclusive-OR function on the first plaintext block with the first output block.
4. The system uses the cipher text block as the input block for the subsequent forward cipher operation.
5. The system repeats the forward cipher operation with the successive input blocks until it produces a cipher text segment from every plaintext segment.
6. The system produces the last cipher text block by executing an exclusive-OR function on the last plaintext segment of r bits (r is less than or equal to 128) with the segment of the r most significant bits of the last output block.

Data decryption

The switch handles data decryption in the following manner:

1. In CFB decryption, the IV is the first input block, the system uses the first cipher text for the second input block, the second cipher text for the third input block, and this continues until the system runs out of blocks to decrypt.
2. The system applies the forward cipher function to each input block to produce the output blocks.
3. The system passes the output blocks through an exclusive-OR function with the corresponding cipher text blocks to recover the plaintext blocks.
4. The system sends the last cipher text block (whose size r is less than or equal to 128) through an exclusive-OR function with the segment of the r most significant bits of the last output block to recover the last plaintext block of r bits.

Trap notifications

You configure traps by creating SNMPv3 trap notifications, creating a target address to which you want to send the notifications, and specifying target parameters. For more information about how to configure trap notifications, see *Troubleshooting*.

SNMP community strings

For security reasons for SNMPv1 and SNMPv2, the SNMP agent validates each request from an SNMP manager before responding to the request by verifying that the manager belongs to a valid SNMP community. An SNMP community is a logical relationship between an SNMP agent and one or more SNMP managers (the manager software implements the protocols used to exchange data with SNMP agents). You define communities locally at the agent level.

The agent establishes one community for each combination of authentication and access control characteristics that you choose. You assign each community a unique name (community string), and all members of a community have the same access privileges, either read-only or read-write:

- Read-only: members can view configuration and performance information.
- Read-write: members can view configuration and performance information, and change the configuration.

By defining a community, an agent limits access to its MIB to a selected set of management stations. By using more than one community, the agent can provide different levels of MIB access to different management stations.

SNMP community strings are used when a user logs on to the device over SNMP, for example, using an SNMP-based management software. You set the SNMP community strings using CLI . If you have read/write/all access authority, you can modify the SNMP community strings for access to the device through Enterprise Device Manager (EDM).

You are provided with community strings for SNMPv1 and SNMPv2. If you want to use SNMPv3 only, you must disable SNMPv1 and SNMPv2 access by deleting the default community string entries and create the SNMPv3 user and group. [SNMPv3](#) on page 242.

 **Note:**

If you enable enhanced secure mode, the switch does not support the default SNMPv1 and default SNMPv2 community strings, and default SNMPv3 user name. The individual in the administrator access level role can configure a non-default value for the community strings, and the switch can continue to support SNMPv1 and SNMPv2. The individual in the administrator access level role can also configure a non-default value for the SNMPv3 user name and the switch can continue to support SNMPv3.

If you disable enhanced secure mode, the SNMPv1 and SNMPv2 support for community strings remains the same, and the default SNMPv3 user name remains the same. Enhanced secure mode is disabled by default.

For more information on enhanced secure mode, see *Administering*.

The following table lists the default community strings for SNMPv1 and SNMPv2.

VRF	Default community string	Access
GlobalRouter VRF	public	Read access
	private	Write access
ManagementRouter VRF	public:512	Read access
	private:512	Write access

Community strings are encrypted using the AES encryption algorithm. Community strings do not appear on the device and are not stored in the configuration file.

 **Caution:**

Security risk

For security reasons, it is recommended that you set the community strings to values other than the factory defaults.

The switch handles community string encryption in the following manner:

- When the device starts up, community strings are restored from the hidden file.
- When the SNMP community strings are modified, the modifications are updated to the hidden file.
- Stale snmp-server community entries for different VRFs appear after reboot with no VRFs . On an node with any valid config file saved with more than the default vrf0 , snmp_community entries for that VRF are created and maintained in a separate txt file, snmp_comm.txt, on every boot. The node reads this file and updates the snmp communities available on the node. As a result for a boot with config having no VRFs, you may still see snmp_community entries for VRFs other than the globalRouter vrf0.

Hsecure with SNMP

If you enable hsecure, the system disables SNMPv1, SNMPv2 and SNMPv3. If you want to use SNMP, you must use the command `no boot config flag block-snmp` to re-enable SNMP.

SNMPv3 support for VRF

Use Virtual Router Forwarding (VRF) to offer networking capabilities and traffic isolation to customers that operate over the same node (switch). Each virtual router emulates the behavior of a dedicated hardware router and is treated by the network as a separate physical router. You can use VRF Lite to perform the functions of many routers using a single router running VRF Lite. This substantially reduces the cost associated with providing routing and traffic isolation for multiple clients.

SNMP configuration using CLI

Configure the SNMP engine to provide services to send and receive messages, authenticate and encrypt messages, and control access to managed objects. A one-to-one association exists between an SNMP engine and the SNMP entity.

- To perform the procedures in this section, you must log on to the Global Configuration mode in CLI. For more information about how to use CLI, see *Using CLI and EDM*.

This task flow shows you the sequence of procedures you perform to configure basic elements of SNMP when using CLI.

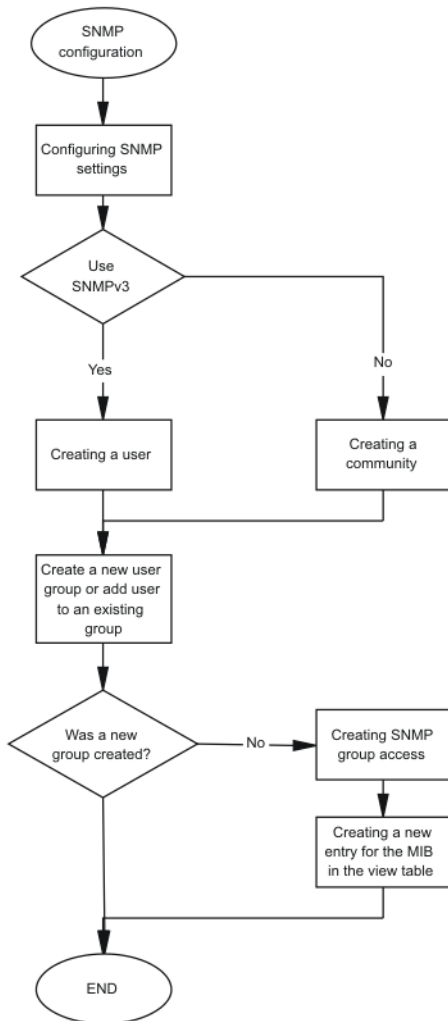

Figure 29: SNMP configuration procedures

Downloading the software

Download new software to upgrade the switch.

Before you begin

- You must have access to the new software from the Avaya support site: <https://support.avaya.com>. You need a valid user or site ID and password.

About this task

For more information about file names for the current release, see *Release Notes*.

Procedure

1. From an Internet browser, browse to <https://support.avaya.com>.
2. Under **Support by Product**, select **Downloads**.
3. In the product search field, type the product name.
4. In the **Choose Release** field, click a release number.
5. Click the download title to view the selected information.
6. Click the file you want to download.
7. Login to download the required software file.
8. Use an FTP client in binary mode to transfer the file to the switch.

Configuring SNMP settings

Configure Simple Network Management Protocol (SNMP) to define or modify the SNMP settings, and specify how secure you want SNMP communications.

Procedure

1. Enter Global Configuration mode:

```
enable
configure terminal
```
2. Enable the generation of authentication traps:

```
snmp-server authentication-trap enable
```
3. Configure the contact information for the system:

```
snmp-server contact WORD<0-255>
```
4. Configure the SNMP and IP sender flag to the same value:

```
snmp-server force-iphdr-sender enable
```
5. Send the configured source address (sender IP) as the sender network in the notification message:

```
snmp-server force-trap-sender enable
```
6. Create an SNMPv1 server host:

```
snmp-server host WORD<1-256> [port <1-65535>] v1 WORD<1-32> [filter WORD<1-32>]
```
7. Create an SNMPv2 server host:

```
snmp-server host WORD<1-256> [port <1-65535>] v2c WORD<1-32> [inform [timeout <1-2147483647>] [retries <0-255>] [mms <0-2147483647>]] [filter WORD<1-32>]
```

8. Create an SNMPv3 server host:

```
snmp-server host WORD<1-256> [port <1-65535>] v3 {noAuthNoPriv|
authNoPriv|authPriv WORD<1-32> [inform [timeout <1-2147483647>]
[retries <0-255>]] [filter WORD<1-32>]}
```

9. Configure the system location:

```
snmp-server location WORD<0-255>
```

10. Configure the system name:

```
snmp-server name WORD<0-255>
```

11. Create a new entry in the notify filter table:

```
snmp-server notify-filter WORD<1-32> WORD<1-32>
```

12. Configure the SNMP trap receiver and source IP addresses:

```
snmp-server sender-ip {A.B.C.D} {A.B.C.D}
```

Example

Enable the generation of SNMP traps. Configure the contact information for the system. Configure the SNMP and IP sender flag to the same value. Configure hosts to receive SNMP notifications:

```
Switch:1>enable
Switch:1#configure terminal
Switch:1(config)#snmp-server authentication-trap enable
Switch:1(config)#snmp-server contact xxxx@avaya.com
Switch:1(config)#snmp-server force-iphdr-sender enable
Switch:1(config)#snmp-server host 45.16.149.128 port 1 v1 SNMPv1 filter SNMPfilterv1
```

Variable definitions

Use the data in the following table to use the `snmp-server` command.

Table 9: Variable definitions

Variable	Value
bootstrap {min-secure semi-secure very-secure}	<p>Creates an initial set of configuration data for SNMPv3. This configuration data follows the conventions described in the SNMPv3 standard (see standard, RFC3515). This command creates a set of initial users, groups, and views.</p> <ul style="list-style-type: none"> • min-secure—a minimum security configuration that gives read access and notify access to all processes (MIB view restricted) with noAuth-noPriv and read, write, and notify access to all processes (MIB view internet) using Auth-Priv. <p>In this configuration, restricted MIB view matches internet MIB view.</p> <ul style="list-style-type: none"> • semi-secure—a security configuration that gives read access and notify access to all processes (MIB view restricted) with noAuth-noPriv and read, write, and notify access to all processes (MIB view Internet) using Auth-Priv.

Table continues...

Variable	Value
	<p>In this configuration, restricted MIB view contains a smaller subset of views than Internet MIB view. For more information, see RFC3515 for details.</p> <ul style="list-style-type: none"> • very-secure—a maximum security configuration that allows no access to the users. <p>With this command all existing SNMP configurations in the SNMPv3 MIB tables are removed and replaced with entries as described in the RFC.</p>
contact WORD<0-255>	Changes the sysContact information for the switch. WORD<0-255> is an ASCII string from 0–255 characters (for example a phone extension or e-mail address).
host WORD<1-256> [port <1-65535>] {v1 WORD<1-32> v2c WORD<1-32> [inform [timeout <1-2147483647>][retries <0-255>] [mms <0-2147483647>]] v3 {noAuthPriv authNoPriv authPriv} WORD<1-32> [inform [timeout <1-2147483647>][retries <0-255>]]} [filter WORD<1-32>]	<p>Configures hosts to receive SNMP notifications.</p> <ul style="list-style-type: none"> • host WORD<1-256> specifies the IPv4 or IPv6 host address • port <1-65535> specifies the port number • v1 WORD<1-32> specifies the SNMP v1 security name • v2c WORD<1-32> specifies the SNMPv2 security name • inform specifies the notify type • timeout <1-2147483647> specifies the timeout value • retries <0-255> specifies the number of retries • mms <1-2147483647> specifies the maximum message size • v3 specifies SNMPv3 • noAuthPriv authNoPriv authPriv specifies the security level • WORD<1-32> specifies the user name • filter specifies a filter profile name
location WORD<0-255>	Configures the sysLocation information for the system. <WORD 0-255> is an ASCII string from 0–255 characters.
name WORD<0-255>	Configures the sysName information for the system. <WORD 0-255> is an ASCII string from 0–255 characters.
notify-filter WORD<1-32> WORD<1-32>	Creates a new entry in the notify filter table. The first WORD<1-32> specifies the filter profile name, and the second WORD<1-32> specifies the subtree OID.
sender-ip {A.B.C.D} {A.B.C.D}	<p>The first {A.B.C.D} configures the SNMP trap receiver and source IP addresses. Specify the IP address of the destination SNMP server receives the SNMP trap notification in the first IP address.</p> <p>The second {A.B.C.D} specifies the source IP address of the SNMP trap notification packet that is transmitted in the second IP address. If you set this to 0.0.0.0, the system uses the IP address of the local</p>

Table continues...

Variable	Value
	interface that is closest (from an IP routing table perspective) to the destination SNMP server.

Creating a user

Create a new user in the USM table to authorize a user on a particular SNMP engine

Procedure

1. Enter Global Configuration mode:

```
enable
configure terminal
```

2. Create a user on a remote system:

```
snmp-server user engine-id WORD<16-97>WORD<1-32>[md5|sha]
WORD<1-32> [{aes|des} WORD<1-32>]
```

3. Create a user on the local system:

```
snmp-server user WORD<1-32> [notify-view WORD<0-32>][read-view
WORD<0-32>] [write-view WORD<0-32>] [{md5|sha} WORD<1-32>] [{aes|
des} WORD<1-32>]
```

4. Add the user to a group:

```
snmp-server user WORD<1-32> group WORD<1-32> [{md5|sha} WORD<1-32>]
[{aes|des} WORD<1-32>]
```

Example

Create a user named test1 on a remote system with MD5:

```
Switch:1>enable
Switch:1#configure terminal
Switch:1(config)#snmp-server user test1 md5 auth-password aes test write-view test1
```

Variable definitions

Use the data in the following table to use the `snmp-server user` command.

Table 10: Variable definitions

Variable	Value
{aes des} WORD<1-32>	Specifies a privacy protocol. If no value is entered, no authentication capability exists. The choices are aes or des. WORD<1-32> assigns a privacy password. If no value is entered, no privacy capability exists. The range is 1 to 32 characters.

Table continues...

Variable	Value
	 Important: You must set authentication before you can set the privacy option.
engine-id <i>WORD</i> <16-97>	Assigns an SNMPv3 engine ID. Use the no operator to remove this configuration.
group <i>WORD</i> <1-32>	Specifies the group access name.
{md5 sha} <i>WORD</i> <1-32>	Specifies an authentication protocol. If no value is entered, no authentication capability exists. The protocol choices are: MD5 and SHA. <i>WORD</i> <1-32> specifies an authentication password. If no value is entered, no authentication capability exists. The range is 1–32 characters.
notify-view <i>WORD</i> <0-32>	Specifies the view name in the range of 0 to 32 characters. The first instance is a noAuth view. The second instance is an auth view and the last instance is an authPriv view.
read-view <i>WORD</i> <0-32>	Specifies the view name in the range of 0 to 32 characters. The first instance is a noAuth view. The second instance is an auth view and the last instance is an authPriv view.
write-view <i>WORD</i> <0-32>	Specifies the view name in the range of 0 to 32 characters. The first instance is a noAuth view. The second instance is an auth view and the last instance is an authPriv view.
user <i>WORD</i> <1-32>	Creates the new entry with this security name. The name is used as an index to the table. The range is 1–32 characters. Use the no operator to remove this configuration.

Creating a new user group

Create a new user group to logically group users who require the same level of access. Create new access for a group in the View-based Access Control Model (VACM) table to provide access to managed objects.

Note:

There are several default groups (public and private) created that you can use. To see the list of default groups and their associated security names (secnames), enter **show snmp-server group**. If you use one of these groups, there is no need to create a new group.

Procedure

1. Enter Global Configuration mode:

```
enable
configure terminal
```

2. Create a new user group:

```
snmp-server group WORD <1-32> WORD<1-32> {auth-no-priv|auth-priv|no-
auth-no-priv} [notify-view WORD<1-32>] [read-view WORD<1-32>]
[write-view WORD<1-32>]
```

Example

This example uses the following variable names:

- The new group name is *lan6grp*.
- The context of the group is "", which represents the Global Router (VRF 0).
- The security level is *no-auth-no-priv*.
- The access view name is *v1v2only* for all three views: **notify-view**, **read-view**, and **write-view**.

```
Switch:1>enable
```

```
Switch:1#configure terminal
```

Create a new user group:

```
Switch:1(config)#snmp-server group lan6grp "" no-auth-no-priv notify-view
v1v2only read-view v1v2only write-view v1v2only
```

Variable definitions

Use the data in the following table use the `snmp-server group` command.

Table 11: Variable definitions

Variable	Value
auth-no-priv	Assigns the minimum level of security required to gain the access rights allowed by this conceptual row. If the auth-no-priv parameter is included, it creates one entry for SNMPv3 access.
auth-priv	Assigns the minimum level of security required to gain the access rights allowed by this conceptual row. If the auth-priv parameter is included, it creates one entry for SNMPv3 access.
group WORD<1-32> WORD<1-32>	<p>The first WORD<1–32> specifies the group name for data access. The range is 1–32 characters. Use the no operator to remove this configuration.</p> <p>The second WORD<1–32> specifies the context name. The range is 1–32 characters. If you use a particular group name value but with different context names, you create multiple entries for different contexts for the same group. You can omit the context name and use the default. If the context name value ends in the wildcard character (*), the resulting entries match a context name that begins with that context. For example, a context name value of foo* matches contexts starting with foo, such as foo6 and fofofum. Use the no operator to remove this configuration.</p>

Table continues...

Variable	Value
no-auth-no-priv	Assigns the minimum level of security required to gain the access rights allowed by this conceptual row. If the no-auth-no-priv parameter is included, it creates 3 entries, one for SNMPv1 access, one for SNMPv2c access, and one for SNMPv3 access.
notify-view WORD<1-32>	Specifies the view name in the range of 0–32 characters.
read-view WORD<1-32>	Specifies the view name in the range of 0–32 characters.
write-view WORD<1-32>	Specifies the view name in the range of 0–32 characters.

Creating a new entry for the MIB in the view table

Create a new entry in the MIB view table. The default Layer 2 MIB view cannot modify SNMP settings. However, a new MIB view created with Layer 2 permission can modify SNMP settings.

Procedure

1. Enter Global Configuration mode:

```
enable
configure terminal
```

2. Create a new entry:

```
snmp-server view WORD<1-32> WORD<1-32>
```

Example

```
Switch:1>enable
```

```
Switch:1#configure terminal
```

Create MIB views:

```
Switch:1(config)snmp-server view 2 1.3.8.7.1.4
```

Variable definitions

Use the data in the following table to use the `snmp-server view` command.

Table 12: Variable definitions

Variable	Value
The first WORD<1-32>	Specifies the prefix that defines the set of MIB objects accessible by this SNMP entity. The range is 1–32 characters.
The second WORD<1-32>	Specifies a new entry with this group name. The range is 1–32 characters.

Creating a community

Create a community to use in forming a relationship between an SNMP agent and one or more SNMP managers. You require SNMP community strings to access the system using an SNMP-based management software.

Procedure

1. Enter Global Configuration mode:

```
enable
configure terminal
```

2. Create a community:

```
snmp-server community WORD<1-32> [group WORD<1-32>] [index WORD<1-32>] [secname WORD<1-32>]
```

! Important:

- The **group** parameter is only required if you created a new user group using the procedure in [Creating a new user group](#) on page 255. If you use any of the default groups, the **secname** automatically links the community to its associated group so there is no need specify the group in this command.
- If you do create a new group, use the **snmp-server community** command to create an SNMP community with a new security name and link it to the new group you created. There is no separate command to create a security name (secname). You use the **snmp-server community** command. The security name is the key to link the community name to a group.
- You cannot use the @ character or the string : : when you create community strings.

Example

In the following example, the community name is *anewcommunity*, the index is *third*, and the secname is *readview*. There is no group specified because this is a default public/read only group.

```
Switch:1>enable
Switch:1#configure terminal
Switch:1(config)#snmp-server community anewcommunity index third secname readview
```

Variable definitions

Use the data in the following table to use the `snmp-server community` command.

Table 13: Variable definitions

Variable	Value
community WORD<1-32>	Specifies a community string. The range is 1–32 characters.
group WORD<1-32>	Specifies the group name. The range is 1–32 characters.
index WORD<1-32>	Specifies the unique index value of a row in this table. The range is 1–32 characters.
secname WORD<1-32>	Maps the community string to the security name in the VACM Group Member Table. The range is 1-32 characters.

Adding a user to a group

Add a user to a group to logically group users who require the same level of access.

Procedure

1. Enter Global Configuration mode:

```
enable
configure terminal
```

2. Create a new user group:

```
snmp-server user WORD<1-32> group WORD<1-32> [{md5 WORD<1-32>|sha
WORD<1-32>)} [{aes WORD<1-32>|des WORD<1-32>}]]
```

Example

```
Switch:1>enable
Switch:1#configure terminal
```

Add a user to a group to logically group users who require the same level of access:

```
Switch:1(config)#snmp-server user test1 group Grouptest1 md5 winter aes
summer
```

Variable definitions

Use the data in the following table to use the `snmp-server user` command.

Table 14: Variable definitions

Variable	Value
{aes des} WORD<1-32>	Specifies a privacy protocol. If no value is entered, no authentication capability exists. The choices are aes or des.

Table continues...

Variable	Value
	<p><i>WORD</i><1-32> assigns a privacy password. If no value is entered, no privacy capability exists. The range is 1 to 32 characters.</p> <p>! Important: You must set authentication before you can set the privacy option.</p>
engine-id <i>WORD</i> <16-97>	Assigns an SNMPv3 engine ID. Use the no operator to remove this configuration.
group <i>WORD</i> <1-32>	Specifies the group access name.
{md5 sha} <i>WORD</i> <1-32>	Specifies an authentication protocol. If no value is entered, no authentication capability exists. The protocol choices are: MD5 and SHA. <i>WORD</i> <1-32> specifies an authentication password. If no value is entered, no authentication capability exists. The range is 1–32 characters.
notify-view <i>WORD</i> <0-32>	Specifies the view name in the range of 0 to 32 characters. The first instance is a noAuth view. The second instance is an auth view and the last instance is an authPriv view.
read-view <i>WORD</i> <0-32>	Specifies the view name in the range of 0 to 32 characters. The first instance is a noAuth view. The second instance is an auth view and the last instance is an authPriv view.
write-view <i>WORD</i> <0-32>	Specifies the view name in the range of 0 to 32 characters. The first instance is a noAuth view. The second instance is an auth view and the last instance is an authPriv view.
user <i>WORD</i> <1-32>	Creates the new entry with this security name. The name is used as an index to the table. The range is 1–32 characters. Use the no operator to remove this configuration.

Blocking SNMP

Disable SNMP by using the SNMP block flag. By default, SNMP access is enabled.

Procedure

1. Enter Global Configuration mode:

```
enable
configure terminal
```
2. Disable SNMP:

```
boot config flags block-snmp
```

Example

```
Switch:1>enable
```

```
Switch:1#configure terminal
Disable SNMP:
Switch:1(config)#boot config flags block-snmp
```

Variable definitions

Use the data in the following table to use the `boot config flags` command.

Table 15: Variable definitions

Variable	Value
block-snmp	Configures the block SNMP flag as active. Use the <code>no</code> operator to remove this configuration. The default is off. To set this option to the default value, use the default operator with the command.

Displaying SNMP system information

Display SNMP system information to view trap and authentication profiles.

For a comprehensive set of SNMP-related `show` commands, see *CLI Commands Reference*.

Procedure

1. Log on to the switch to enter User EXEC mode.
2. Display SNMP system information:

```
show snmp-server
```

Example

```
Switch:1>show snmp-server
      trap-sender :
force-trap-sender : FALSE
force-iphdr-sender : FALSE
      contact : none
      location : none
      name : Switch:1
AuthenticationTrap : false
LoginSuccessTrap : false
```

SNMP configuration using Enterprise Device Manager

Configure SNMP to provide services to send and receive messages, authenticate and encrypt messages, and control access to managed objects with Enterprise Device Manager (EDM).

The following task flow shows you the sequence of procedures you perform to configure basic elements of SNMP using EDM.

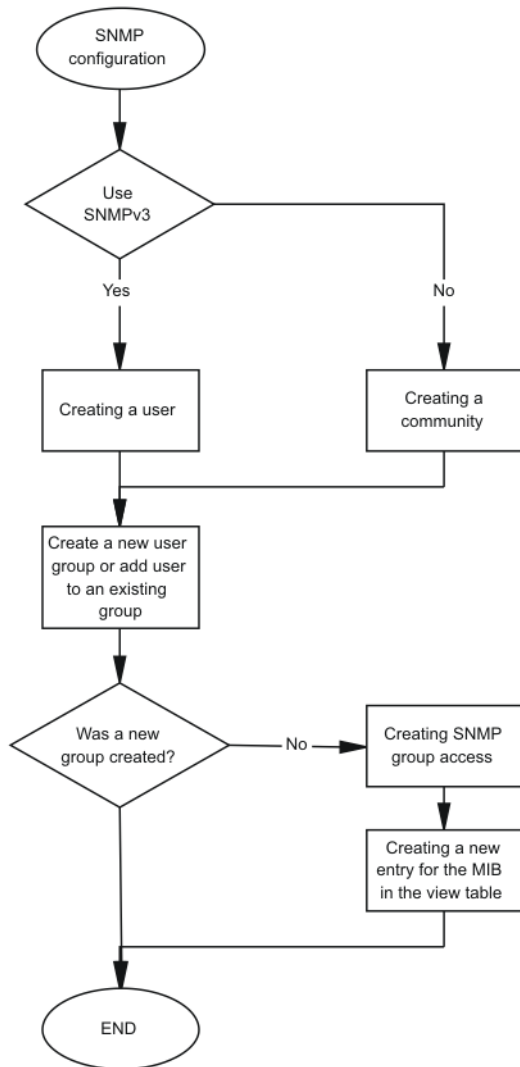

Figure 30: SNMP configuration using Enterprise Device Manager procedures

Creating a user

About this task

Create a new user in the USM table to authorize a user on a particular SNMP engine.

*** Note:**

In EDM, to create new SNMPv3 users you must use the **CloneFromUser** option. However, you cannot clone the default user, named initial. As a result, you must first use CLI to configure at least one user, and then you can use EDM to create subsequent users with the **CloneFromUser** option.

Procedure

1. In the navigation tree, open the following folders: **Configuration > Edit > SnmpV3**.
2. Click **USM Table**.
3. Click **Insert**.
4. In the **EngineID** box, use the default Engine ID provided or type an administratively-unique identifier to an SNMP engine.
5. In the **User Name** box, type a name.
6. From the **CloneFromUser** list, select a security name from which the new entry copies authentication data and private data, if required.
7. From the **Auth Protocol** list, select an authentication protocol.
8. In the **Cloned User's Auth Password** box, type the authentication password of the cloned user.
9. In the **New User's Auth Password** box, type an authentication password for the new user.
10. From the **Priv Protocol** list, select a privacy protocol.
11. In the **Cloned User's Priv Password** box, type the privacy password of the cloned user.
12. In the **New User's Priv Password** box, type a privacy password for the new user.
13. Click **Insert**.

 **Caution:**

Security risk

To ensure security, change the GroupAccess table default view after you set up a new user in the USM table. This prevents unauthorized people from accessing the system using the default user logon. Also, change the Community table defaults, because the community name is used as a community string in SNMPv1/v2 PDU.

USM Table field descriptions

Use the data in the following table to use the **USM Table** tab and the **Insert USM Table** dialog box. Some fields appear only on the Insert USM Table dialog box.

Name	Description
EngineID	Specifies an administratively-unique identifier to an SNMP engine.
UserName	Creates the new entry with this security name. The name is used as an index to the table. The range is 1–32 characters.
SecurityName	Identifies the name on whose behalf SNMP messages are generated.
Clone From User	Specifies the security name from which the new entry must copy privacy and authentication parameters. The range is 1–32 characters. This option appears only in the Insert USM Table dialog box.

Table continues...

Name	Description
Auth Protocol (Optional)	Assigns an authentication protocol (or no authentication) from a list. If you select an authentication protocol, you must enter an old AuthPass and a new AuthPass.
Cloned User's Auth Password	Specifies the current authentication password of the cloned user. This option appears only in the Insert USM Table dialog box.
New User's Auth Password	Specifies the authentication password of the new user. This option appears only in the Insert USM Table dialog box.
Priv Protocol (Optional)	Assigns a privacy protocol (or no privacy) from a list. If you select a privacy protocol, you must enter an old PrivPass and a new PrivPass.
Cloned User's Priv Password	Specifies the current privacy password of the cloned user. This option appears only in the Insert USM Table dialog box.
New User's Priv Password	Specifies the privacy password of the new user. This option appears only in the Insert USM Table dialog box.

Creating a new group membership

About this task

Create a new group membership to logically group users who require the same level of access.

* Note:

There are several default groups (public and private) created that you can use. To see the list of default groups and their associated security names (secnames), enter `show snmp-server group`. If you use one of these groups, there is no need to create a new group.

Procedure

1. In the navigation tree, open the following folders: **Configuration > Edit > SnmpV3**.
2. Click **VACM Table**.
3. Click the **Group Membership** tab.
4. Click **Insert**.
5. From the **SecurityModel** options, select a security model.
6. In the **SecurityName** box, type a security name.
7. In the **GroupName** box, type a group name.
8. Click **Insert**.

Group Membership field descriptions

Use the data in the following table to use the **Group Membership** tab.

Name	Description
SecurityModel	Specifies the security model to use with this group membership.
SecurityName	Specifies the security name assigned to this entry in the View-based Access Control Model (VACM) table. The range is 1–32 characters.
GroupName	Specifies the name assigned to this group in the VACM table. The range is 1–32 characters.

Creating access for a group

About this task

Create access for a group in the View-based Access Control Model (VACM) table to provide access to managed objects.

Procedure

1. In the navigation tree, open the following folders: **Configuration > Edit > SnmpV3**.
2. Click **VACM Table**.
3. Click the **Group Access Right** tab.
4. Click **Insert**.
5. In the **GroupName** box, type a VACM group name.
6. In the **ContextPrefix** box, select a VRF instance. This is an optional step.
7. From the **SecurityModel** options, select a model.
8. From the **SecurityLevel** options, select a security level.
9. In the **ContextMatch** option, select a value to match the context name. This value is **exact** by default.
10. **(Optional)** In the **ReadViewName** box, type the name of the MIB view that forms the basis of authorization when reading objects. This is an optional step.
11. **(Optional)** In the **WriteViewName** box, type the name of the MIB view that forms the basis of authorization when writing objects. This is an optional step.
12. **(Optional)** In the **NotifyViewName** box, type MIB view that forms the basis of authorization for notifications. This is an optional step.
13. Click **Insert**.

Group Access Right field descriptions

Use the data in the following table to use the **Group Access Right** tab.

Name	Description
GroupName	Specifies the name of the new group in the VACM table. The range is 1–32 characters.
ContextPrefix	Specifies if the contextName must match the value of the instance of this object exactly or partially. The range is an SnmpAdminString, 1–32 characters.
SecurityModel	Specifies the authentication checking to communicate to the switch. The security models are: <ul style="list-style-type: none"> • SNMPv1 • SNMPv2 • USM
SecurityLevel	Specifies the minimum level of security required to gain the access rights allowed. The security levels are: <ul style="list-style-type: none"> • noAuthNoPriv • authNoPriv • authpriv
ContextMatch	Specifies if the prefix and the context name must match. If the value is exact, all rows where the contextName exactly matches vacmAccessContextPrefix are selected. If you do not select exact, all rows where the contextName with starting octets that exactly match vacmAccessContextPrefix are selected.
ReadViewName	Identifies the MIB view of the SNMP context to which this conceptual row authorizes read access. The default is the empty string.
WriteViewName	Identifies the MIB view of the SNMP context to which this conceptual row authorizes write access. The default is the empty string.
NotifyViewName	Identifies the MIB view of the SNMP context to which this conceptual row authorizes access for notifications. The default is the empty string.

Creating access policies for SNMP groups

About this task

Create an access policy to determine the access level for the users who connect to the switch with different services like File Transfer Protocol (FTP), Trivial FTP (TFTP), Telnet, and rlogin.

You only need to create access policies for SNMP groups if you have the access policy feature enabled. For more information about access policies, see *Administering*.

Procedure

1. In the navigation pane, open the **Configuration > Security > Control Path** folders.
2. Click **Access Policies**.
3. Click the **Access Policies-SNMP Groups** tab.

4. Click **Insert**.
5. Enter an **ID** .
6. In the **Name** box, type a name.
7. From the **Model** options, select a security model.
8. Click **Insert**.

Access Policies — SNMP Groups field descriptions

Use the data in the following table to use the **Access Polices-SNMP Groups** tab.

Name	Description
Id	Specifies the ID of the group policy.
Name	Specifies the name assigned to the group policy. The range is 1–32 characters.
Model	Specifies the security model {SNMPv1 SNMPv2c USM}.

Assigning MIB view access for an object

About this task

Create a new entry in the MIB View table.

You cannot modify SNMP settings with the default Layer 2 MIB view. However, you can modify SNMP settings with a new MIB view created with Layer 2 permissions.

Procedure

1. In the navigation tree, open the following folders: **Configuration > Edit > SnmpV3**.
2. Click **VACM Table**.
3. In the VACM Table tab, click the **MIB View** tab.
4. Click **Insert**.
5. In the **ViewName** box, type a view name.
6. In the **Subtree** box, type a subtree.
7. In the **Mask** box, type a mask.
8. From the **Type** options, select whether access to the MIB object is granted.
9. Click **Insert**.

MIB View field descriptions

Use the data in the following table to use the **MIB View** tab.

Name	Description
ViewName	Creates a new entry with this group name. The range is 1–32 characters.
Subtree	Specifies a valid object identifier that defines the set of MIB objects accessible by this SNMP entity, for example, 1.3.6.1.1.5.
Mask (optional)	Specifies a bit mask with vacmViewTreeFamilySubtree to determine whether an OID falls under a view subtree.
Type	Determines whether access to a MIB object is granted (included) or denied (excluded). The default is included.

Creating a community

About this task

Create a community to use in forming a relationship between an SNMP agent and one or more SNMP managers. You require SNMP community strings for access to the switch using an SNMP-based management software.

Procedure

1. In the navigation tree, open the following folders: **Configuration > Edit > SnmpV3**.
2. Click **Community Table**.
3. Click **Insert**.
4. In the **Index** box, type an index.
5. In the **Name** box, type a name that is a community string.
6. In the **SecurityName** box, type a security name.
7. In the **ContextName** box, type the context name.
8. Click **Insert**.

Community Table field descriptions

Use the data in the following table to use the **Community Table** tab.

Name	Description
Index	Specifies the unique index value of a row in this table. The range is 1–32 characters.
Name	Specifies the community string for which a row in this table represents a configuration.
SecurityName	Specifies the security name in the VACM group member table to which the community string is mapped. The range is 1–32 characters.

Table continues...

Name	Description
ContextEngineID	Indicates the location of the context in which management information is accessed when using the community string specified in Name .
ContextName	Specifies the context in which management information is accessed when you use the specified community string.

Viewing all contexts for an SNMP entity

About this task

View contexts to see the contents of the context table in the View-based Access Control Model (VACM). This table provides information to SNMP command generator applications so that they can properly configure the VACM access table to control access to all contexts at the SNMP entity.

Procedure

1. In the navigation tree, open the following folders: **Configuration > Edit > SnmpV3**.
2. Click **VACM Table**.
3. In the **VACM Table** tab, click the **Contexts** tab.

Contexts field descriptions

Use the data in the following table to use the **Contexts** tab.

Variable	Value
ContextName	Shows the name identifying a particular context at a particular SNMP entity. The empty contextName (zero length) represents the default context.

Chapter 10: TACACS+

This chapter provides Terminal Access Controller Access Control Plus (TACACS+) concepts and procedures to complete TACACS+ configuration.

TACACS+ fundamentals

The switch supports the TACACS+ client. TACACS+ is a remote authentication protocol that provides centralized validation of users who attempt to gain access to a router or Network Access Server (NAS).

The TACACS+ feature is a client and server-based protocol that allows the switch to accept a user name and password and send a query to a TACACS+ authentication server, sometimes called a TACACS+ daemon. The TACACS+ server allows access or denies access based on the response by the client.

The TACACS+ feature facilitates the following services:

- Login authentication and authorization for CLI access through rlogin, Secure Shell (SSH), Telnet, or serial port.
- Login authentication for web access through EDM.
- Command authorization for CLI through rlogin, SSH, Telnet, or serial port.
- Accounting of CLI through rlogin, SSH, Telnet, and serial port.

The following figure displays the basic layout of the switch and the TACACS+ server.

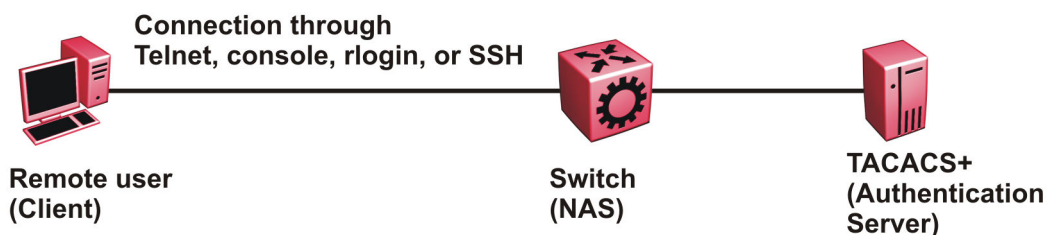

Figure 31: Switch and TACACS+ server

The TACACS+ feature uses Transmission Control Protocol (TCP) for its transport to ensure reliable delivery of packets. TACACS+ provides security by encrypting all traffic between the switch, which acts as the Network Access Server, and the TACACS+ server.

TACACS+ is a newer version of TACACS and provides separate authentication, authorization, and accounting (AAA) services. TACACS+ does not support earlier versions of TACACS.

TACACS+ is a base license feature. The TACACS+ feature is disabled by default.

TACACS+ Operation

The switch acts as an NAS to provide a connection to a single user, to a network, subnetwork or interconnected networks. The switch acts as a gateway to guard access to the TACACS+ server and network. Encryption relies on a secret key that is known to the client and the TACACS+ server.

Similar to the Remote Access Dial-In User Services (RADIUS) protocol, TACACS+ provides the ability to centrally manage the users who want to access a remote device. TACACS+ provides management of remote and local users who try to access a device through:

- rlogin
- Secure Shell (SSHv2)
- Telnet
- serial port
- Web management

A TACACS+ daemon, which typically runs on a UNIX or Windows NT workstation, maintains the TACACS+ authentication, authorization, and accounting services.

Avaya Identity Engine supports the TACACS+ daemon.

It is recommended to use the Avaya Identity Engines Ignition server as your TACACS+ server.

You configure users in the TACACS+ server. If you enable authentication, authorization, and accounting services, the following occurs:

- During the logon process, the TACACS+ client initiates the TACACS+ authentication session with the TACACS+ server.
- After successful authentication the TACACS+ client initiates the TACACS+ authorization session with the TACACS+ server. This is transparent to the user. The switch receives the user access level after a successful TACACS+ authorization. The TACACS+ server authorizes every command the user issues if TACACS + command authorization is enabled for that user access level.
- After successful authorization, if you enable TACACS+ accounting, the TACACS+ client sends accounting information to the TACACS+ server.

A TACACS+ session establishes with the server in one of two ways:

- Multi-connection mode (also known as per-session): For every authentication, authorization, and accounting (AAA) request the switch establishes a session with the TACACS+ server, and then once the request finishes, the session is torn down. Multi-connection mode is the default mode.

- Single-connection mode: The first AAA request establishes the session, which is only torn down if TACACS+ is disabled or due to inactivity.

TACACS+ Architecture

You can connect the TACACS+ server to the switch:

- In-band through one of the data ports.
- Out-of-band through the management port.

Connect the TACACS+ server through a local interface. Management PCs can reside on an out-of-band management Ethernet port, or on the corporate network. Place the TACACS+ server on the corporate network so you can route it to the switch.

Before you configure the switch, you must configure at least one TACACS+ server and a key.

The TACACS+ server and the switch must have the same:

- Encryption key
- Connection mode (single connection or per-session connection. Per-session connection is the same as multi-connection mode.)
- TCP port number

You can configure a secondary TACACS+ server for backup authentication. You specify the primary authentication server when you configure the switch.

Authentication, authorization, and accounting

A fundamental feature of TACACS+ is the separation of authentication, authorization, and accounting (AAA) services, which allows you to selectively implement one or more TACACS+ services.

TACACS+ authentication

TACACS+ authentication provides control of authentication through login and password.

Authentication uses a database of users and passwords to determine:

- who a user is
- whether to allow the user access to the NAS

Important:

Prompts for log on and password occur prior to the authentication process. If TACACS+ fails because no valid servers exist, the device uses the user name and password from the local database. If TACACS+ or the local database returns an access denied packet, the authentication process stops. The device attempts no other authentication methods.

The following figure illustrates the authentication process.

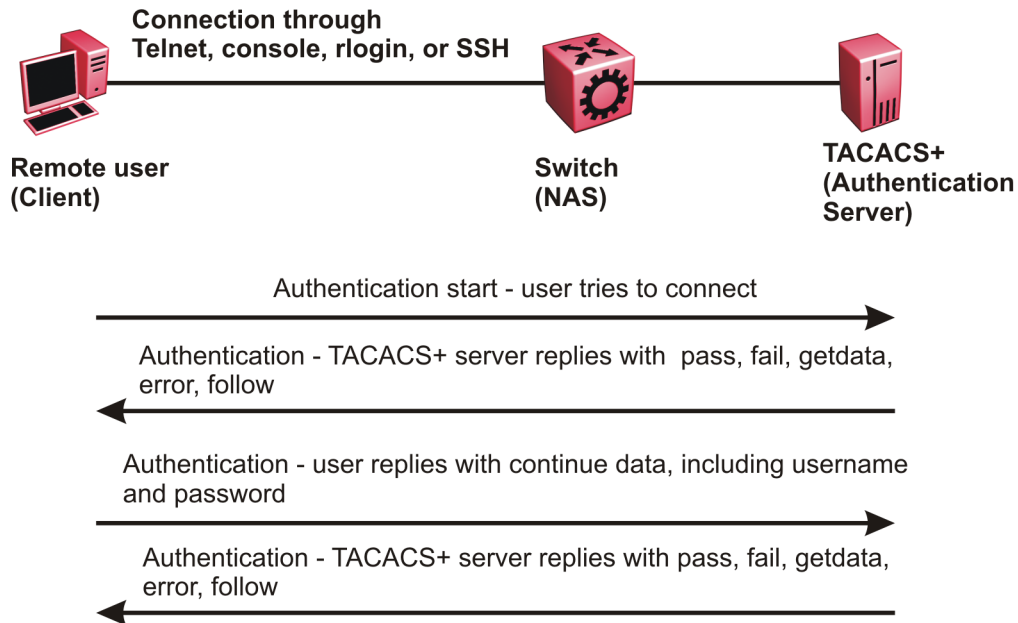

Figure 32: Authentication process

TACACS+ authorization

The transition from TACACS+ authentication to the authorization phase is transparent to the user. After successful completion of the authentication session, an authorization session starts with the authenticated user name. The authorization session provides access level functionality.

Authorization cannot occur without authentication.

Authorization:

- determines what a user can do
- allows administrators fine-grained control over the capabilities of users during sessions

The following figure illustrates the authorization process.

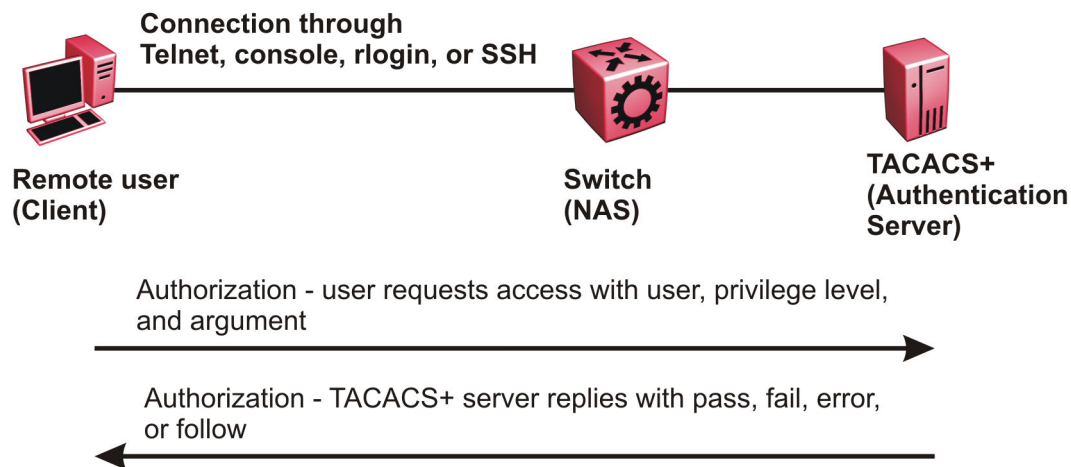

Figure 33: Authorization process

Authorization determines what a user can do. Authorization gives you the ability to limit network services to certain users and to limit the use of certain commands to certain users. The TACACS+ feature enhances the security by tightly policing the command execution for a particular user. After you enable command authorization, all commands, no matter the access level to which they belong, are sent to the TACACS+ server for authorization. Authorization cannot occur without first enabling authentication. You must configure command authorization globally and at individual access levels.

Two kinds of authorization requests exist:

1. Login authorization: Login authorization happens immediately after authentication and is transparent to the user. When the user logs on to the device, authorization provides the user access level. With log on, the device does not send a command to the TACACS+ server. You cannot configure login authorization.
2. Command authorization: When you configure command authorization for a particular level, all commands that you issue are sent to the TACACS+ server for authorization. The device can only issue the commands the TACACS+ server authorizes. You need to configure command authorization globally and at individual access levels, which are visible to the users.

*** Note:**

You must verify that the switch can reach the TACACS+ server and that you configure TACACS+ properly before you enable command authorization.

If a user is TACACS+ authenticated and command authorization is enabled for that level, then if the switch cannot reach the TACACS+ server, the switch does not allow the user to issue any command that has privilege level command authorization enabled. In such a case, the user can only issue logout and exit commands.

If a user tries to log in and the TACACS+ server does not exist or is not reachable, then, as discussed before, a local database in the switch authenticates the user. The switch authorizes a locally authenticated user and a locally authenticated user is not eligible for TACACS+ command authorization.

After the switch requests authorization, the logon credentials are sent to the TACACS+ daemon for authorization. If logon authorization fails, the user receives a permission denied message.

If TACACS+ logon authorization succeeds, the switch uses information from the user profile, which exists in the local user database or on the TACACS+ server, to configure the session for the user.

After you enable TACACS+ command authorization all commands are visible to all users; however, the user can only issue those commands that the TACACS+ server configuration allows.

The switch cannot enforce command access level. The TACACS+ server returns an access level to the switch. The switch allows the user to access the switch according to the access level. The device grants the user access to a command only if the profile for the user allows the access level.

You preconfigure command authorization on the TACACS+ server. You specify a list of regular expressions that match command arguments, and you associate each command with an action to deny or permit.

All members in a group have the same authorization. If you place a user in a group, the daemon looks in the group for authorization parameters if it cannot find them in the user profile.

TACACS+ accounting

TACACS+ accounting enables you to track the services users access and the amount of network resources users consume.

TACACS+ accounting allows you to track:

- what a user does
- when a user does certain actions

The accounting record includes the following information:

- User name
- Date
- Start/stop/elapsed time
- Access server IP address
- Reason

You can use accounting for an audit trail, to bill for connection time or resources used, or for network management. TACACS+ accounting provides information about user sessions using the following connection types: Telnet, rlogin, SSH, and web-based management.

With separation of AAA, accounting can occur independently from authentication and authorization.

The following figure illustrates the accounting process.

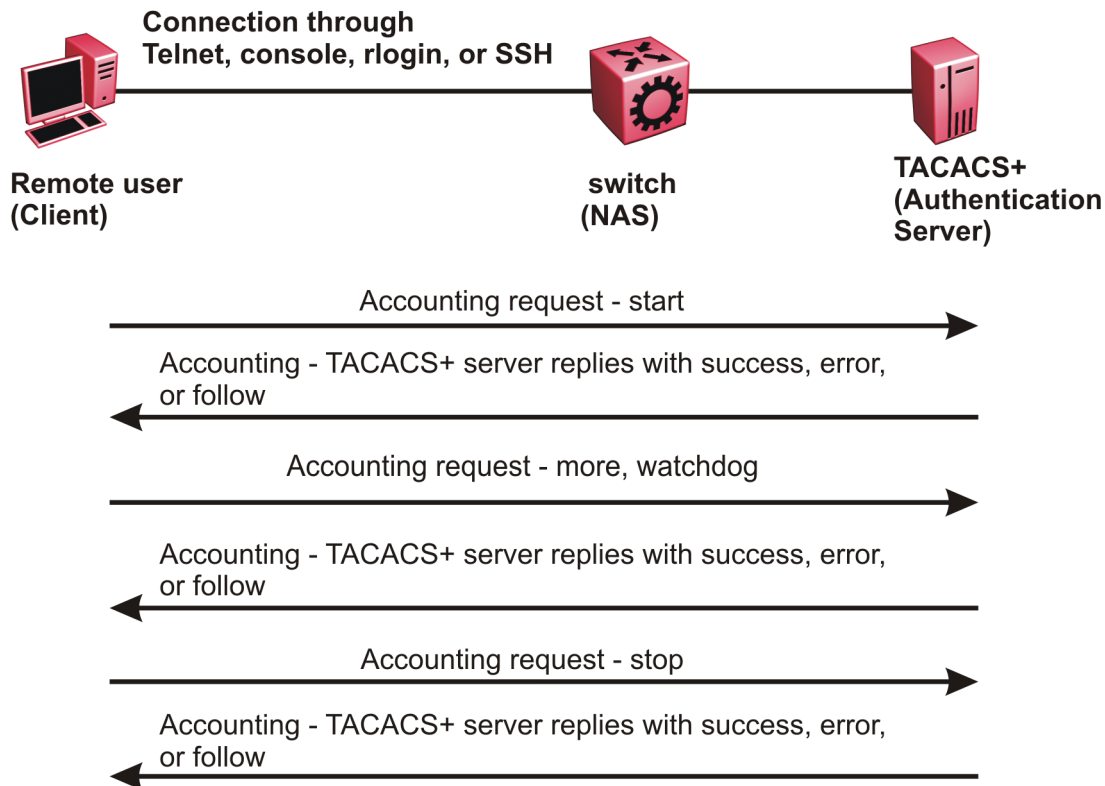

Figure 34: Accounting process

After you enable accounting, the switch reports user activity to the TACACS+ server in the form of accounting records. Each accounting record contains accounting attribute value (AV) pairs. AV pairs are strings of text in the form “attribute-value” sent between the switch and a TACACS+ daemon as part of the TACACS+ protocol. The TACACS+ server stores the accounting records.

You cannot customize the set of events the switch monitors and logs with TACACS+ accounting. TACACS+ accounting logs the following events:

- User logon and logoff
- Logoff generated because of activity timeout
- Unauthorized command
- Telnet session closed (not logged off)

Privilege level changes at runtime

You can change your privilege level at runtime with the `tacacs switch level` command.

You need to configure separate profiles in the TACACS+ server configuration file for the switch level. The switch supports only levels 1 to 6 and level 15. The switch uses the profile when you

issue the command `tacacs switch level <1-15>`. As part of the profile, you specify a user name, level, and password. To preconfigure a dummy user for that level on the TACACS+ daemon, the format of the user name for the dummy user is `$enab<n>$`, where `<n>` is the privilege level to which you want to allow access.

The following is an example of a TACACS+ server profile, which you configure on the TACACS+ server:

```
user = $enab6$ {
member = level6
login = cleartext get-me-on-6
}
```

The following table maps user accounts to TACACS+ privilege level.

Switch access level	TACACS+ privilege level	Description
NONE	0	If the TACACS+ server returns an access level of 0, the user is denied access. You cannot log into the device if you have an access level of 0.
READ ONLY	1	Permits you to view only configuration and status information.
LAYER 1 READ WRITE	2	Permits you to view most of the switch configuration and status information and change physical port settings.
LAYER 2 READ WRITE	3	Permits you to view and change configuration and status information for Layer 2 (bridging and switching) functions.
LAYER 3 READ WRITE	4	Permits you to view and change configuration and status information for Layer 2 and Layer 3 (routing) functions.
READ WRITE	5	Permits you to view and change configuration and status information across the switch. This level does not allow you to change security and password settings.
READ WRITE ALL	6	Permits you to have all the rights of read-write access and the ability to change security settings, including command line interface (CLI) and web-based management user names and passwords, and the SNMP community strings.

Table continues...

Switch access level	TACACS+ privilege level	Description
NONE	7 to 14	If the TACACS+ server returns an access level of 7 to 14, the user is denied access. You cannot log into the device if you have an access level of 7 to 14.
READ WRITE ALL	15	Permits you to have all the rights of read-write access and the ability to change security settings, including command line interface (CLI) and Web-based management user names and passwords, and the SNMP community strings.  Note: Access level 15 is internally mapped to access level 6, which ensures consistency with other vendor implementations. The switch does not differentiate between an access level of 6 and an access level of 15.

 **Note:**

If you enable enhanced secure mode with the `boot config flags enhancedsecure-mode` command, you enable different access levels, along with stronger password complexity, length, and minimum change intervals. With enhanced secure mode enabled, the switch supports the following access levels for RADIUS authentication:

- Administrator
- Privilege
- Operator
- Auditor
- Security

The switch associates each username with a certain role and appropriate authorization rights to view and configure commands. For more information on system access fundamentals and configuration, see *Administering*.

TACACS+ command authorization

After you enable TACACS+ authorization, the current privilege-level to command mapping on the switch is no longer relevant because the TACACS+ server has complete responsibility for command authorization. TACACS+ authorization provides access to the system based on username, not based on privilege level.

After you enable TACACS+ command authorization for a particular privilege level, and a user with that privilege level logs on, the user can access commands based on his user name.

TACACS+ switch level and TACACS+ switch back commands

The user can only issue the `tacacs switch level` command after TACACS+ authenticates the user. Locally authenticated users, which means users authenticated only by the switch and not by the TACACS+ server, cannot use the `tacacs switch level` command.

Consider a user, called X, with a privilege level of 4, who uses the `tacacs switch level <1-15>` command to change the privilege level from 4 to 6.

If user X successfully changes the switch level to 6, the user name changes from X to “\$enab6\$”, and the privilege level changes from 4 to 6. If TACACS+ command authorization is enabled for privilege level 6, then the TACACS+ server authorizes commands issued based on the rules defined for (dummy) user “\$enab6\$”.

If TACACS+ command authorization is not enabled for privilege level 6, then the switch locally authorizes the user X based on the privilege level of the user.

The user can return to his previous privilege level using the `tacacs switch back` command. In the preceding scenario, if the user issues the `tacacs switch back` command, the user name changes for user X from “\$enab6\$” to X, and the privilege level changes from 6 to 4.

TACACS+ switch level supports up to eight levels, and TACACS+ switch level allows a user to switch level up to eight times from his original privilege level. The switch stores all of the previous privilege levels in the same order in which the user switches levels. After switching eight times, if the user tries to switch a level the ninth time, the following error message displays:

```
Only allowed to switch level 8 times!
```

The user can switch back to his previous privilege levels using the `tacacs switch back` command. The `tacacs switch back` command switches back in the reverse order in which you issued the `tacacs switch level` command. Consider a user who switched levels from 4 to 5, and then to 6. If the user used the `tacacs switch back` command, the user first moves from 6 to 5, and then using the `tacacs switch back` command again moves from 5 to 4.

* Note:

If you want to switch to a privilege level 'X' using `tacacs switch level <1-15>` command, you must create a user "\$enabX\$" on the TACACS+ server. X is the privilege level that you want to change.

TACACS+ switch level functionality:

The following table explains TACACS+ switch level functionality.

User logs in with	TACACS+ server available	Result
TACACS+ authentication	Yes	The user can issue the <code>tacacs switch level <1-15></code> command.
Local authentication	No	The user cannot issue the <code>tacacs switch level <1-15></code> command.

Table continues...

User logs in with	TACACS+ server available	Result
Local authentication	Yes	Even if a TACACS+ server becomes reachable, the user remains locally authenticated and cannot issue the <code>tacacs switch level <1-15></code> command.

TACACS+ command authorization functionality:

The following table explains TACACS+ command authorization functionality.

User logs in with	Command authorization	Result
Local authentication	—	The switch authorizes the user locally.
TACACS+ authentication	Not enabled for the logged-in level.	The switch authorizes the user locally. If the server connection is lost, the switch authorizes the user locally.
TACACS+ authentication	Enabled for the logged-in level.	The TACACS+ server authorizes the user. If the server connection is lost, the user can only issue <code>exit</code> and <code>logout</code> commands.

* Note:

A user who configures TACACS+ is locally authenticated and authorized by the switch, so even after the user configures TACACS+, the switch continues to locally authorize the user.

TACACS+ and RADIUS differences

TACACS+ and RADIUS are security protocols that you can use on network devices.

You can enable TACACS+ and RADIUS together. However, TACACS+ has a higher priority. If the TACACS+ server is not available the authentication is sent to RADIUS, if RADIUS is enabled. However, if TACACS+ authentication fails, then requests are not sent to RADIUS.

Following is a list of differences between TACACS+ and RADIUS.

TACACS+	RADIUS
Separates Authorization, Authentication and Accounting (AAA). As a result, you can selectively implement one or more TACACS+ services. With TACACS+ you can use different servers for each service.	Combines authentication and authorization.
Uses TCP. TCP is connection-oriented.	Uses UDP. UDP is best-effort delivery.

Table continues...

TACACS+	RADIUS
TCP immediately indicates if a server crashes or is not running. TCP offers an acknowledgement that a request has been received.	RADIUS uses re-transmit attempts and timeouts to make up for the support TCP has.
Encrypts the entire body of the packet, which includes the password and username.	Encrypts only the password from the client to the server.
Used for administrator access. Usually used for administrator access to network devices.	Used for subscriber access. Usually used to authenticate remote users to a network.
Can control which access level of commands a user or group can access.	Cannot control which access level of commands can be used.

TACACS+ feature limitations

TACACS+ does not support the following features:

- Point-to-Point Protocol (PPP) authentication and accounting
- IPv6 for TACACS+
- S/KEY (One Time Password) authentication
- PAP/CHAP/MSCHAP authentication methods
- The FOLLOW response of a TACACS+ server, in which the AAA services are redirected to another server. The response is interpreted as an authentication failure.
- User capability to change passwords at runtime over the network. The system administrator must change user passwords locally, on the server.
- TACACS+ command authorization when the user accesses the switch through EDM and SNMP.
- Restriction of command authorization for a specific kind of access. After you enable command authorization, command authorization applies for Telnet, SSH, rlogin, and serial-port access. You cannot restrict command authorization to just one kind of access.

If a user is TACACS+ authenticated and command authorization is enabled for that level, then if the switch cannot reach the TACACS+ server, the switch does not allow the user to execute any command that has privilege level command authorization enabled.

TACACS+ configuration using CLI

Enabling TACACS+

Enable TACACS+ globally on the switch.

The switch supports the TACACS+ client. TACACS+ is a security application implemented as a client and server-based protocol that provides centralized validation of users who attempt to gain access to a router or network access server (the switch).

By default, TACACS+ is disabled.

Before you begin

- You must have access to and you must configure a TACACS+ server before the TACACS+ features on your switch are available.

Procedure

1. Enter Global Configuration mode:

```
enable
configure terminal
```

2. Enable TACACS+ globally:

```
tacacs protocol enable
```

3. Disable TACACS+ globally:

```
no tacacs protocol enable
default tacacs protocol enable
```

Example

```
Switch:1>enable
Switch:1#configure terminal
Switch:1(config)#tacacs protocol enable
```

Adding a TACACS+ server

Add a primary and secondary TACACS+ server and specify the authentication process.

If you have a backup server configured, the AAA request goes to the backup server if the primary server is not available.

You are recommended to use the Avaya Identity Engines Ignition server as your TACACS+ server.

About this task

The TACACS+ server and the switch must have the same:

- Encryption key
- Connection mode (single connection or per-session connection. Per-session connection is the same as multi-connection mode)
- TCP port number

Procedure

1. Enter Global Configuration mode:

```
enable
configure terminal
```

2. Add a primary TACACS+ server with an encryption key:

```
tacacs server host {A.B.C.D} key WORD<0-128>
```

3. **(Optional)** Configure the parameters for the primary TACACS+ server as required.

- a. **(Optional)** Specify a single connection. The single connection parameter maintains a constant connection between the switch and the TACACS+ daemon:

```
tacacs server host {A.B.C.D} single-connection
```

*** Note:**

The TACACS+ daemon must also support this mode. If you do not configure this, the switch uses the default connection type, which is the per-session connection. Per-session is the same as multi-connection mode.

- b. **(Optional)** Specify the TCP port to use when the switch connects to the TACACS+ daemon:

```
tacacs server host {A.B.C.D} port <1-65535>
```

The default port is 49.

- c. **(Optional)** Specify the period of time (in seconds) the switch waits for a response from the TACACS+ daemon before it times out and shows an error:

```
tacacs server host {A.B.C.D} timeout <10-30>
```

- d. **(Optional)** Designate a fixed source IP address for all outgoing TACACS+ packets and enable this option:

```
tacacs server host {A.B.C.D} source {A.B.C.D}source-ip-interface
enable
```

4. Specify the IP address of the secondary TACACS+ server and specify an encryption key:

```
tacacs server secondary-host {A.B.C.D} key WORD<0-128>
```

5. **(Optional)** Configure the optional parameters on the secondary TACACS+ server as required.

- a. **(Optional)** Specify a single connection for the secondary TACACS+ server. The single connection parameter maintains a constant connection between the switch and the TACACS+ daemon:

```
tacacs server secondary-host {A.B.C.D} single-connection
```

*** Note:**

The TACACS+ daemon must also support this mode. If you do not configure this, the switch uses the default connection type, which is the per-session connection. Per-session is the same as multi-connection mode.

- b. **(Optional)** Specify the TCP port to use when the switch connects to the TACACS+ daemon:

```
tacacs server secondary-host {A.B.C.D} port <1-65535>
```

- c. **(Optional)** Specify the period of time (in seconds) the switch waits for a response from the TACACS+ daemon before it times out and shows an error:

```
tacacs server secondary-host {A.B.C.D} timeout<10-30>
```

- d. **(Optional)** Designate a fixed source IP address for all outgoing TACACS+ packets and enable this option:

```
tacacs server secondary-host {A.B.C.D} source {A.B.C.D} source-  
ip-interface enable
```

6. Display the status of the TACACS+ configuration:

```
show tacacs
```

7. **(Optional)** Delete a primary TACACS+ server:

```
no tacacs server host{A.B.C.D} [single-connection][source source-ip-  
interface enable]
```

8. **(Optional)** Delete a backup TACACS+ server:

```
no tacacs server secondary-host{A.B.C.D} [single-connection][source  
source-ip-interface enable]
```

9. **(Optional)** Configure a primary TACACS+ server or secondary TACACS+ server to the default settings:

```
default tacacs server {A.B.C.D} [port][single-connection][source  
source-ip-interface enable][timeout]
```

Example

Configure the primary server with the IP address 192.0.2.1 and the encryption key 1dt41y. Configure the secondary server with the IP address 198.51.100.2 with the same encryption key 1dt41y. Display the configuration to ensure proper configuration.

```
Switch:1>enable  
Switch:1#configure terminal  
Switch:1(config)#tacacs server host 192.0.2.1 key 1dt41y
```

```

Switch:1(config)#tacacs server secondary-host 198.51.100.2 key 1dt4ly
Switch:1(config)#show tacacs

Global Status:

  global enable : true

  authentication enabled for : cli

  accounting enabled for : none

  authorization : disabled

  User privilege levels set for command authorization : None

Server:
      create :

Prio      Status  Key      Port  IP address      Timeout Single Source
SourceEnabled
Primary   Conn    *        49    192.0.2.1      10     false  0.0.0.0
false
Backup   NotConn *        49    198.51.100.2   10     false  0.0.0.0
false

Switch:1(config)#no tacacs server host 192.0.2.1
Switch:1(config)#no tacacs server secondary-host 198.51.100.2

```

Variable definitions

Use the data in the following table to use the `tacacs server host` and the `tacacs server secondary-host` commands.

Variable	Value
{A.B.C.D}	Specifies the IP address of the TACACS+ server you want to add. Only IPv4 addresses are valid.
key WORD <0-128>	Configures the authentication and encryption key for all TACACS+ communications between the device and the TACACS+ server. If the key length is zero, that indicates no encryption is used. You must configure the same encryption key for the TACACS+ server and the switch.
port <1-65535>	Configures the TCP port, on which the client establishes a connection to the server. A value of 0 indicates the system specified default value is used. The default is 49. You must configure the same TCP port for the TACACS+ server and the switch.
single-connection	Specifies if the TCP connection between the device and the TACACS+ server is a single connection. If you specify the single connection parameter, the

Table continues...

Variable	Value
	<p>connection between the switch and the TACACS+ daemon remains open, which is more efficient because it allows the daemon to handle a higher number of TACACS+ operations. The single-connection is torn down if TACACS+ is disabled due to inactivity.</p> <p>If you do not configure this, the switch uses the default connection type, which is the multi-connection. With the multi-connection, the connection opens and closes each time the switch and TACACS+ daemon communicate.</p> <p>* Note:</p> <p>You must configure the same connection mode for the TACACS+ server and the switch.</p> <p>To enable single-connection, the TACACS+ daemon has to support this mode as well.</p>
source {A.B.C.D}	<p>Designates a fixed source IP address for all outgoing TACACS+ packets, which is useful if the router has many interfaces and you want to make sure all TACACS+ packets from a certain router have the same IP address.</p> <p>If you do not configure an address, the system uses 0.0.0.0 as the default.</p> <p>Only IPv4 addresses are valid.</p> <p>* Note:</p> <p>If you configure a valid source IP address that is not 0.0.0.0 without enabling source-ip-interface, the source IP address returns to 0.0.0.0.</p>
source-ip-interface enable	<p>Enables the source address. You must enable this parameter if you configure a valid source IP address. The default is disabled.</p>
timeout <10-30>	<p>Configures the maximum time, in seconds, to wait for this TACACS+ server to reply before it times out. The default value is 10 seconds.</p>

Job aid

The following table describes the fields in the output for the `show tacacs` command.

Name	Description
Global Status	
global enable	Displays if the TACACS+ feature is enabled globally.

Table continues...

Name	Description
authentication enabled for	Displays which application is authenticated by TACACS+. The possibilities are CLI, web, or all.
accounting enabled for	Displays if accounting is enabled. You can only enable accounting for CLI. By default, accounting is not enabled.
authorization	Displays if authorization is enabled.
User privilege levels set for command authorization	Displays the privilege levels set for command authorization. When you configure command authorization for a particular level, all commands that you execute are sent to the TACACS+ server for authorization. The device can only execute the commands the TACACS+ server authorizes. The user privilege levels are: <ul style="list-style-type: none"> • 0: denied access • 1: read only (ro) access • 2: Layer 1 read and write (l1) access • 3: Layer 2 read and write (l2) access • 4: Layer 3 read and write (l3) access • 5: read and write (rw) access • 6: read and write all (rwa) access • 7-14: denied access • 15: read and write all (rwa) access
Server	
Prio	Displays the priority of the TACACS+ server. The switch attempts to use the primary server first, and the secondary server second.
Status	Displays the connection status between the server and the switch – connected or not connected.
Key	Displays as ***** instead of the actual key. The key is secret and is not visible.
Port	Displays the TCP port used to establish the connection to the server. The default port is 49.
IP address	Displays the IP address for the primary and secondary TACACS+ servers.
Timeout	Displays the period of time, in seconds, the switch waits for a response from the TACACS+ daemon before it times out and declares an error. The default is 10 seconds.

Table continues...

Name	Description
Single	Displays if a single open connection is maintained between the switch and TACACS+ daemon, or if the switch opens and closes the TCP connection to the TACACS+ daemon each time they communicate. The default is false, which means the device does not maintain the single open connection.
Source	Displays the fixed source IP address, if you configure one, for all outgoing TACACS+ packets.
SourceEnabled	Displays if the fixed source IP address is enabled for all outgoing TACACS+ packets.

Configuring TACACS+ authentication

Configure what application TACACS+ authenticates: CLI, web, or all.

TACACS+ authentication provides control of authentication through login and password.

By default, CLI authentication is enabled.

Before you begin

- You must enable TACACS+ globally for TACACS+ authentication to function.

Procedure

1. Enter Global Configuration mode:

```
enable
configure terminal
```
2. Configure TACACS+ authentication:

```
tacacs authentication <all/cli/web>
```
3. **(Optional)** Disable TACACS+ authentication:

```
no tacacs authentication <all/web>
```
4. **(Optional)** Configure TACACS+ authentication to the default settings (default is cli authentication enabled):

```
default tacacs authentication <all/cli/web>
```
5. Display the configuration:

```
show tacacs
```

Example

Configure TACACS+ to authenticate CLI and display the configuration.

```
Switch:1>enable
Switch:1#configure terminal
Switch:1(config)#tacacs authentication cli
```

```
Switch:1(config)#show tacacs
Global Status:

    global enable : true

    authentication enabled for : cli

    accounting enabled for : none

Server:

    create :

Prio    Status  Key      Port  IP address  Timeout  SingleSource  Source  Enabled
Primary Conn    *       49    192.0.2.1   10      false        0.0.0.0 false
Backup  NotConn *       49    198.51.100.2 10      false        0.0.0.0 false
```

Variable definitions

Use the data in the following table to use the `tacacs authentication` command.

Variable	Value
all	Specifies TACACS+ authentication for all applications. By default, CLI authentication is enabled.
cli	Specifies TACACS+ authentication for command line connections. By default, CLI authentication is enabled.
web	Specifies TACACS+ authentication for web connections. By default, CLI authentication is enabled.

Configuring TACACS+ accounting

Determines for which applications TACACS+ collects accounting information. Use TACACS+ accounting to track the services that users access and the amount of network resources that users consume. If unassigned, TACACS+ does not perform the accounting function.

If enabled, TACACS+ accounting logs the following events:

- User log on and log off
- Log off generated because of activity timeout
- Unauthorized command
- Telnet session closed (not logged off)

If unassigned, TACACS+ does not perform the accounting function. No default value exists.

Procedure

1. Enter Global Configuration mode:

```
enable
```

TACACS+

```
configure terminal
```

2. Enable TACACS+ accounting:

```
tacacs accounting enable cli
```

3. **(Optional)** Disable TACACS+ accounting:

```
no tacacs accounting cli
```

```
tacacs accounting disable [cli]
```

Example

Enable TACACS+ accounting:

```
Switch:1>enable
Switch:1#configure terminal
Switch:1(config)#tacacs accounting enable cli
```

Configuring command authorization with TACACS+

Use this procedure to enable TACACS+ authorization for a particular privilege level. Use this option to limit the use of certain commands to certain users.

If command authorization fails, the following log message displays: Command <command> not authorized for user <username>.

By default, command authorization is disabled on the switch. The default for the command authorization level is none.

Before you begin

- You must have access to and you must configure a TACACS+ server before the TACACS+ features on your switch are available. You must verify that the switch can reach the TACACS+ server and that you configure TACACS+ properly before you enable command authorization. If a user is TACACS+ authenticated and command authorization is enabled for that level, then if the switch cannot reach the TACACS+ server, the switch does not allow you to issue any command that has privilege level command authorization enabled. If the switch cannot reach the TACACS+ server, you can only issue logout and exit commands.
- To use TACACS+ authorization, you must enable TACACS+ authentication.

About this task

Two kinds of authorization requests exist:

1. Login authorization: Login authorization happens immediately after authentication when the user logs on to the device, authorization provides the user access level. You cannot configure login authorization.
2. Command authorization: When you configure command authorization for a particular level, all commands that you issue are sent to the TACACS+ server for authorization. You need to configure command authorization globally and at individual access levels.

Procedure

1. Enter Global Configuration mode:

- ```
enable
configure terminal
```
2. Enable TACACS+ authorization:

```
tacacs authorization enable
```
  3. Configure TACACS+ privilege level for TACACS+ command authorization:

```
tacacs authorization level <1-6>
tacacs authorization level all
tacacs authorization level none
```
  4. (Optional) Disable TACACS+ authorization:

```
tacacs authorization disable
default tacacs authorization
```

### Example

```
Switch:1>enable
Switch:1#configure terminal
Switch:1(config)#tacacs authorization enable
Switch:1(config)#tacacs authorization level 6
```

## Variable definitions

Use the data in the following table to use the `tacacs authorization` command.

| Variable    | Value                                                                                                                  |
|-------------|------------------------------------------------------------------------------------------------------------------------|
| level <1-6> | Enables command authorization for a specific privilege level. The default for the command authorization level is none. |
| level all   | Enables command authorization for all privilege levels. The default for the command authorization level is none.       |
| level none  | Disables command authorization for all privilege levels. The default for the command authorization level is none.      |

---

## Changing privilege levels at runtime

Users can change their privilege levels at runtime. The privilege level determines what commands a user can access through TACACS+ server authorization.

A user can only use the `tacacs switch level` command, after TACACS+ authenticates the user. Locally authenticated users, which means users authenticated only by the switch and not by the TACACS+ server, cannot use the `tacacs switch level` command.

## Before you begin

- You need to configure separate profiles in the TACACS+ server configuration file for switch level. As part of the profile, you specify a user name, level, and password.

## About this task

After you enable TACACS+ authorization, the current privilege-level to command mapping on the switch is no longer relevant because the TACACS+ server has complete responsibility for command authorization. TACACS+ authorization provides access to the system based on username, not based on privilege level.

After you enable TACACS+ command authorization for a particular privilege level, and a user with that privilege level logs on, the user can access commands based on his user name.

### \* Note:

If you want to switch to a privilege level 'X' using `tacacs switch level <1-15>` command, you must create a user "\$enabX\$" on the TACACS+ server. X is the privilege level to which you want to change.

## Procedure

- Enter Global Configuration mode:

```
enable
configure terminal
```

- Change the privilege level for a user at runtime:

```
tacacs switch level <1-15>
```

- Return to the original privilege level:

```
tacacs switch back
```

## Example

Change the privilege level for a user at runtime. Return to the original privilege level:

```
Switch:1>enable
Switch:1#configure terminal
Switch:1(config)#tacacs protocol enable
Switch:1(config)#tacacs switch level 5
Password:*****
```

Return to the original privilege level:

```
Switch:1(config)#tacacs switch back
```

## Variable definitions

Use the data in the following table to use the `tacacs switch` command.

| Variable     | Value                                                                                                     |
|--------------|-----------------------------------------------------------------------------------------------------------|
| level <1-15> | Specifies the privilege level you want to access. You can change your privilege level at runtime by using |

*Table continues...*

| Variable | Value                                                                                                                                                                                                                                                                                                                                                                                                                                                                                                                                                                                                                                                                           |
|----------|---------------------------------------------------------------------------------------------------------------------------------------------------------------------------------------------------------------------------------------------------------------------------------------------------------------------------------------------------------------------------------------------------------------------------------------------------------------------------------------------------------------------------------------------------------------------------------------------------------------------------------------------------------------------------------|
|          | <p>this parameter. You are prompted to provide the required password. If you do not specify a level in the command, the administration level is selected by default.</p> <p> <b>Note:</b></p> <p>For switch level, you need to configure separate profiles in the TACACS+ server configuration file. As part of the profile, you specify a username, level, and password. To preconfigure a dummy user for that level on the TACACS+ daemon, the format of the username for the dummy user is \$enab&lt;n&gt;\$, where &lt;n&gt; is the privilege level to which you want to allow access.</p> |
| back     | Specifies that you want to return to the original privilege level.                                                                                                                                                                                                                                                                                                                                                                                                                                                                                                                                                                                                              |

---

## TACACS+ configuration using EDM

---

### Configuring TACACS+ globally

Enable TACACS+ globally on the switch. TACACS+ is a security application implemented as a client and server-based protocol that provides centralized validation of users. By default, TACACS+ is disabled.

#### Before you begin

- You must have access to and you must configure a TACACS+ server before the TACACS+ features on your switch (network access server) are available.

You must verify that the switch can reach the TACACS+ server and that you configure TACACS+ properly before you enable command authorization.

- If a user is TACACS+ authenticated and command authorization is enabled for that level, then if the switch cannot reach the TACACS+ server, the switch does not allow the user to issue any command that has privilege level command authorization enabled. In such a case, the user can only issue logout and exit commands.
- You must enable TACACS+ globally for TACACS+ authentication to function.
- You must enable TACACS+ authentication for TACACS+ authorization to function.

#### About this task

Configure what application TACACS+ authenticates. TACACS+ authentication provides control of authentication through login and password dialog, challenge and response. By default, CLI authentication is enabled.

After authentication is complete, the switch starts the authorization process. By default, command authorization is disabled on the switch. The default for the command authorization level is none. If command authorization fails, the following log message displays: `Command <command> not authorized for user <username>`.

Two kinds of authorization requests exist:

1. Login authorization: Login authorization happens immediately after authentication when the user logs on to the device, authorization provides the user access level. You cannot configure login authorization.
2. Command authorization: When you configure command authorization for a particular level, all commands that you issue are sent to the TACACS+ server for authorization. You need to configure command authorization globally and at individual access levels.

Enable TACACS+ accounting function and determine which application TACACS+ accounts. After you enable accounting, the switch reports user activity to the TACACS+ server in the form of accounting records. The default for accounting is none.

### Procedure

1. In the navigation pane, expand the following folders: **Configuration > Security > Control Path**.
2. Click **TACACS+**.
3. Click the **TACACS+ Globals** tab.
4. Select the **GlobalEnable** check box to enable TACACS+ globally.
5. Select the **cli** check box to enable the **Accounting** option.
6. Select the **cli** or **web** check box to enable the **Authentication** option.
7. Click the **AcliCommandAuthorizationEnabled** box to enable TACACS+ authorization.
8. Select the level in the **AcliCommandAuthorizationLevels** box.
9. Click **Apply**.

## TACACS+ Globals field descriptions

Use the data in the following table to use the **TACACS+ Globals** tab.

| Name                | Description                                                                                                                                                                                                                                                                             |
|---------------------|-----------------------------------------------------------------------------------------------------------------------------------------------------------------------------------------------------------------------------------------------------------------------------------------|
| <b>GlobalEnable</b> | Enables or disables the TACACS+ feature globally.                                                                                                                                                                                                                                       |
| <b>Accounting</b>   | Determines for which applications TACACS+ collects accounting information. Use TACACS+ accounting to track the services that users access and the amount of network resources that users consume. If unassigned, TACACS+ does not perform the accounting function. The default is none. |

*Table continues...*

| Name                                   | Description                                                                                                                                                                                                                                                                                                                           |
|----------------------------------------|---------------------------------------------------------------------------------------------------------------------------------------------------------------------------------------------------------------------------------------------------------------------------------------------------------------------------------------|
|                                        | <p>If enabled, TACACS+ accounting logs the following events:</p> <ul style="list-style-type: none"> <li>• User log on and log off</li> <li>• Log off generated because of activity timeout</li> <li>• Unauthorized command</li> <li>• Telnet session closed (not logged off)</li> </ul>                                               |
| <b>Authentication</b>                  | <p>Configures what application TACACS+ authenticates. The options include:</p> <ul style="list-style-type: none"> <li>• cli</li> <li>• web</li> </ul> <p>TACACS + authentication provides control of authentication through login and password dialog, challenge and response.</p> <p>By default, CLI authentication is enabled.</p>  |
| <b>LastUserName</b>                    | Displays the last user for which the system attempted authentication.                                                                                                                                                                                                                                                                 |
| <b>LastAddressType</b>                 | Displays the type of address to access the TACACS + server.                                                                                                                                                                                                                                                                           |
| <b>LastAddress</b>                     | Displays the last address to access the TACACS+ server.                                                                                                                                                                                                                                                                               |
| <b>AcliCommandAuthorizationEnabled</b> | <p>Enables TACACS+ authorization for a particular privilege level. Use this option to limit the use of certain commands to certain users. To use TACACS + authorization, you must also use TACACS+ authentication.</p> <p>The switch allows the user to access the switch according to the access level. The default is disabled.</p> |
| <b>AcliCommandAuthorizationLevels</b>  | <p>Enables command authorization for a specific privilege level.</p> <p>The default for the command authorization level is none.</p>                                                                                                                                                                                                  |

---

## Adding a TACACS+ server

Add a TACACS+ server, configure the TACACS+ server, and specify the authentication process.

If you have a secondary server configured, the AAA request goes to the backup server if the primary server is not available.

You are recommended to use the Avaya Identity Engines Ignition server as your TACACS+ server.

## Before you begin

You must have access to and you must configure a TACACS+ server before the TACACS+ features on your switch are available.

## About this task

The TACACS+ server and the switch must have the same:

- Encryption key
- Connection mode (single connection or per-session connection. Per-session is the same as multi-connection mode.)
- TCP port number

## Procedure

1. In the navigation pane, expand the following folders: **Configuration > Security > Control Path**.
2. Click **TACACS+**.
3. Click the **TACACS+ Servers** tab.
4. Click **Insert**.
5. In the **AddressType** box, select **ipv4**.
6. In the **Address** field, type the IP address of the TACACS+ server.
7. **(Optional)** In the **PortNumber** field, type the TCP port on which the client establishes a connection to the TACACS+ server.
8. **(Optional)** In the **ConnectionType** box, select either **singleConnection** or **perSessionConnection** to specify the TCP connection type between the switch and TACACS+ server.
9. **(Optional)** In the **Timeout** field, type the period of time (in seconds) the switch waits for a response from the TACACS+ server.
10. In the **Key** field, enter the key that the switch and the TACACS+ server share.
11. **(Optional)** Select **SourceIPInterfaceEnabled**, if you want to enable the switch to designate a fixed source IP address for all outgoing TACACS+ packets.
12. In the **SourceIPInterfaceType** box, select **ipv4**.
13. **(Optional)** In the **SourceIPInterface** field, type a fixed source IP address if you want to designate a fixed source IP address for all outgoing TACACS+ packets.
14. In the **Priority** box, select either **primary** or **backup** to determine the order the switch uses the TACACS+ servers.
15. Click **Insert**.
16. If you want to delete an existing TACACS+ configuration perform the following procedure. In the navigation pane, expand the following folders: **Configuration > Security > Control Path**.
17. Click **TACACS+**.



18. In the **TACACS+** tab, click **TACACS+ Servers** tab.
19. Identify the configuration to delete by clicking anywhere in the row.
20. Click **Delete**.

## TACACS+ Servers field descriptions

Use the data in the following table to use the **TACACS+ Servers** tab.

| Name                    | Description                                                                                                                                                                                                                                                                                                                                                                                                                                                                                                                                                                                                                                                                                                                                                                                                                                                                                                                                                      |
|-------------------------|------------------------------------------------------------------------------------------------------------------------------------------------------------------------------------------------------------------------------------------------------------------------------------------------------------------------------------------------------------------------------------------------------------------------------------------------------------------------------------------------------------------------------------------------------------------------------------------------------------------------------------------------------------------------------------------------------------------------------------------------------------------------------------------------------------------------------------------------------------------------------------------------------------------------------------------------------------------|
| <b>AddressType</b>      | Specifies the type of IP address to use on the TACACS+ server. You must set the value to IPv4.                                                                                                                                                                                                                                                                                                                                                                                                                                                                                                                                                                                                                                                                                                                                                                                                                                                                   |
| <b>Address</b>          | Specifies the IP address of the TACACS+ server.                                                                                                                                                                                                                                                                                                                                                                                                                                                                                                                                                                                                                                                                                                                                                                                                                                                                                                                  |
| <b>PortNumber</b>       | <p>Configures the TCP port on which the client establishes a connection to the server. The default is 49. A value of 0 indicates that the system specified default value is used.</p> <p>You must configure the same TCP port for the TACACS+ server and the switch.</p>                                                                                                                                                                                                                                                                                                                                                                                                                                                                                                                                                                                                                                                                                         |
| <b>ConnectionType</b>   | <p>Specifies if the TCP connection between the device and the TACACS+ server is a single connection. If you specify the single connection parameter, the connection between the switch and the TACACS+ daemon remains open, which is more efficient because it allows the daemon to handle a higher number of TACACS+ operations. The single-connection session is torn down if TACACS+ is disabled due to inactivity.</p> <p>If you do not configure this parameter, the switch uses the default connection type, which is the multi-connection. With the multi-connection, the connection opens and closes each time the switch and TACACS+ daemon communicate.</p> <p> <b>Note:</b></p> <p>You must configure the same connection mode for the TACACS+ server and the switch.</p> <p>To enable single-connection, the TACACS+ daemon has to support this mode as well.</p> |
| <b>ConnectionStatus</b> | Specifies if the TCP connection between the device and TACACS+ server is connected or not connected.                                                                                                                                                                                                                                                                                                                                                                                                                                                                                                                                                                                                                                                                                                                                                                                                                                                             |
| <b>Timeout</b>          | Configures the maximum time, in seconds, to wait for this TACACS+ server to reply before it times out. The default value is 10 seconds.                                                                                                                                                                                                                                                                                                                                                                                                                                                                                                                                                                                                                                                                                                                                                                                                                          |

*Table continues...*

| Name                            | Description                                                                                                                                                                                                                                                                                                                                                                                                                                                                                                                                                                                                       |
|---------------------------------|-------------------------------------------------------------------------------------------------------------------------------------------------------------------------------------------------------------------------------------------------------------------------------------------------------------------------------------------------------------------------------------------------------------------------------------------------------------------------------------------------------------------------------------------------------------------------------------------------------------------|
| <b>Key</b>                      | <p>Configures the authentication and encryption key for all TACACS+ communications between the device and the TACACS+ server. If the key length is zero, that indicates no encryption is used.</p> <p>You must configure the same encryption key for the TACACS+ server and the switch.</p>                                                                                                                                                                                                                                                                                                                       |
| <b>SourceIpInterfaceEnabled</b> | <p>Enables the source address specification. If <b>SourceIpInterfaceEnabled</b> is true (the check box is selected), and you change <b>SourceIpInterfaceEnabled</b> to false (the check box is cleared), the <b>SourceIpInterface</b> is reset to 0.0.0.0. The default is disabled.</p> <p>You must enable this parameter if you configure a valid source IP address</p>                                                                                                                                                                                                                                          |
| <b>SourceIpInterfaceType</b>    | <p>Specifies the type of IP address to use on the interface that connects to the TACACS+ server.</p> <p> <b>Note:</b><br/>You must set the value to IPv4.</p>                                                                                                                                                                                                                                                                                                                                                                    |
| <b>SourceIpInterface</b>        | <p>Designates a fixed source IP address for all outgoing TACACS+ packets, which is useful if the router has many interfaces and you want to make sure all TACACS+ packets from a certain router have the same IP address.</p> <p>If you do not configure an address, the system uses 0.0.0.0 as the default.</p> <p>Only IPv4 addresses are valid.</p> <p> <b>Note:</b><br/>If you configure a valid source IP address that is not 0.0.0.0 without enabling source-ip-interface, the source IP address returns to 0.0.0.0.</p> |
| <b>Priority</b>                 | <p>Determines the order in which the switch uses the TACACS+ servers, where 1 is the highest priority. The priority values are primary and backup.</p> <p>If more than one server shares the same priority, the device uses the servers in the order they exist in the table.</p>                                                                                                                                                                                                                                                                                                                                 |

---

## Modifying a TACACS+ configuration

Modify an existing TACACS+ configuration to customize the server.



## Procedure

1. In the navigation tree, expand the following folders: **Configuration > Security > Control Path**.
2. Click **TACACS+**.
3. Click **TACACS+ Servers** tab.
4. Double-click in the fields that you want to modify.

In some of the fields, the text becomes bold, which indicates that you can edit them. In other fields, a list appears.

5. In the fields that you can edit, type the desired values.
6. In the fields with lists, select the desired option.
7. Click **Apply**.

---

## TACACS+ configuration examples

This section provides configuration examples to configure the switch and Avaya Identity Engines Ignition Server to use TACACS+.

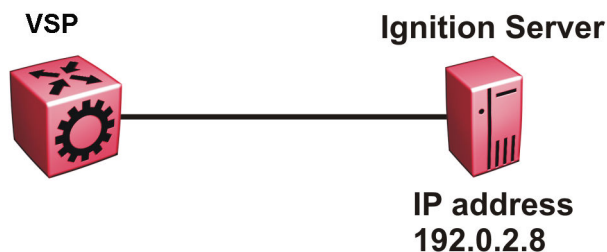

**Figure 35: VSP switch connects to the Identity Engines Ignition Server**

---

## TACACS+ configuration on the switch

The following section shows the steps required to configure TACACS+ on the switch.

The example displays how to:

- Configure a key to be used by the TACACS+ server and the switch. In the example, the key is configured to the word `secret`.
- Configure an IP address for the TACACS+ server. In the example the IP address for the primary server is 192.0.2.8, which is accessible by the Management Router VRF.
- Configure the TACACS+ server to authenticate CLI sessions.

- Enable TACACS+.

## Switch

```
TACACS CONFIGURATION

tacacs server host 192.0.2.8 key *****
tacacs protocol enable
tacacs accounting enable cli
tacacs authorization enable
tacacs authorization level 6
```

## Verify your configuration

The **show tacacs** output must show as `global enable: true` to confirm TACACS is enabled.

The output for the **show tacacs** command must display the IP addresses for the TACACS+ Identity Engines Ignition Server. The IP addresses must be accessible to the Management Router VRF on the switch.

If you want to use the TACACS+ server to authenticate sessions in CLI, the output must display as `authentication enabled for: cli`. If you want to authenticate EDM sessions, the output must display as `authentication enabled for: web`.

Ensure the other parameters match what you have configured.

```
Global Status:

 global enable : true

 authentication enabled for : cli

 accounting enabled for : cli

 authorization : enabled

 User privilege levels set for command authorization : rwa

Server:

 create :

Prio Status Key Port IP address Timeout Single Source
SourceEnabled
Primary Conn ***** 49 192.0.2.8 10 false 0.0.0.0
false
```

---

## Identity Engine Ignition Server TACACS+ configuration example

The following section shows the steps required to configure TACACS+ on Avaya Identity Engines Ignition Server, Release 8.0. Use the preceding information to configure the switch.

A TACACS+ server responds to and audits network access requests. In an installation, the Identity Engines Ignition Server is the TACACS+ server.

The example displays how to do the following:

- Enable TACACS+
- Configure a user
- Create a command set

- Configure the authentication protocol policy
- Create the authorization policy
- Configure TACACS+ authenticators

For more information on the Avaya Ignition Server, see *Avaya Identity Engines Ignition Server Administration*, NN47280–600.

### Before you begin

- Configure the Ignition Server appliance and set up its network settings. For more information, see *Avaya Identity Engines Ignition Server Getting Started*, NN47280–300.
- Install the Ignition Dashboard on your Windows OS.
- Configure each authenticator (switch) to recognize the Ignition Server appliance as its TACACS+ server.
- Configure your switch to send packets to the Ignition Server appliance with the appropriate IP address and port.
- Ensure licenses are up-to-date.

### Procedure

1. If the Ignition Server Dashboard is not connected to your Ignition Server, select **Administration: Login** to connect.
  - a. The default login credentials for **User Name** and **Password** are `admin/admin`. You are recommended to change the default values.
  - b. In the **Connect to** field enter the IP address of the Ignition Server for TACACS+. In this example, the IP address for the TACACS+ server is 192.0.2.8.
2. Enable TACACS+.
  - a. In the Ignition Server Dashboard, select **Site 0**.
  - b. In the Sites window, select the **Services** tab.
  - c. Under the Services tab, select the **TACACS+** tab.
  - d. Click the **Edit** button in the TACACS+ tab.
  - e. In the **Edit TACACS+ Configuration** dialog box, select the **Protocol is enabled** box.
  - f. In the **Bound Interface** field, select **Admin Port**.
  - g. In the **Port** field, enter 49.
  - h. Select **Accept Requests from Any Authenticator**.
 

Select this option if you want to create a global TACACS+ authenticator that sets policy for all authenticators that do not match a specific TACACS+-enabled authentication in your Ignition server configuration.
  - i. In the **Access Policy** field, select **default-tacacs-admin**.
 

Use this configuration in the case of a global TACACS+ authenticator. Choose your global TACACS+ policy that you want applied if the device finds no better matching authenticator.

- j. In **TACACS+ Shared Secret** field, enter the secret that the switch and TACACS+ Ignition server share. In this example, the shared secret is `secret`.
  - k. Click **OK**.
3. Configure a user recognized by the TACACS + server.
- a. In the Ignition Server Dashboard, expand the following in the Configuration tree: **Site Configuration > Directories > Internal Store > Internal Users**.
  - b. Click **New**.
  - c. Fill in the appropriate fields.  
As an example:  
User Name: jsmith  
First Name: John  
Last Name: Smith  
Password: test  
Confirm password: test
4. If your TACACS+ policy uses per-command authorization, create a command set.
- a. In the Ignition Server Dashboard, expand the following in the Configuration tree: **Site Configuration > Access Policies > TACACS+**.
  - b. Click **Define Command Sets**.
  - c. Click **New**.
  - d. In the New Device Command Set window, type a **Name** and **Description** for the command set; for instance, level5.  
  
In this window you build your command set by adding commands to the list. You can build the command list manually or you can import a list. For more information on importing a command list, see *Avaya Identity Engines Ignition Server Administration*, NN47280–600.
  - e. To manually add the commands, click **Add** in the New/Edit Device Command Set window.
  - f. Click the **Simple Command Using Keywords and Arguments** box.
  - g. In the **Command** field, type the command, and optionally its arguments.
  - h. To allow the command to be used with any argument, select the **Allow** box.
  - i. To allow only the specific command and arguments you have types, tick the **Deny** box.
  - j. Click **OK** to add the command to the list.
  - k. Continue to add the commands that you want.

5. If your TACACS+ policy uses privilege-level authorization, create the TACACS+ access policy to allow the TACACS+ Ignition Server to communicate with the switch.
  - a. In the Ignition Server Dashboard, expand the following in the Configuration tree: **Site Configuration > Access Policies > TACACS+**.
  - b. Select **default-tacacs-admin**.
  - c. Click on the **Authorization Policy** tab and select the name of the policy you want to edit.
  - d. Click **Edit** and the **Edit Authorization Policy** window appears.
  - e. In the **Rules** section, select the rule you want to edit. In this case select level5, to which you have already added commands.

The **Rules** list at the left lets you browse and sort the rules in your policy. Use the up and down arrow buttons at the right to set the rule sequence, and click a rule name in the list to edit that rule. The Selected Rule Details section lets you edit the rule you have selected.

- f. In the Selected Rule Details section, under **Rule Name**, for this example, it reads level5.
- g. Select **Rule Enabled**.
- h. With level5 selected in the Rules list, go to the buttons to the right of the **Constraint** list and click **New**.
- i. In the Action section, select **Allow**.
- j. Select the **Command Sets** tab, in the Action section. Allow Commands in Set should read level-5, in this example, and under All Command Sets all the commands that are accessible under level5 should be listed.
- k. Click **OK**.

For this example to function properly, the summary window must display:

IF User: user-id = level5 THEN Allow

Permit commands in Command Set: level-5

6. Configure the Ignition Server to connect to authenticators, which is the switch:
  - a. In the Ignition Server Dashboard, expand the following folders: **Site Configuration > Authenticators > default** and the Authenticator Summary window appears.
  - b. Click **New**, and the Authenticator Details window appears.
  - c. For this example, type `VSPswitch` under name.
  - d. To the right select **Enable Authenticator**.
  - e. Type the IP address for the switch, which is the authenticator. Use the primary CPU address or the management virtual address.
  - f. In the **Vendor** field, select **Nortel**.
  - g. In the **Device template** field, select **ers-switches-nortel**.

- h. Select the **TACACS+ Settings** tab.
- i. Select **Enable TACACS+ Access**.
- j. In the **TACACS+ Shared Secret** field, type the key value you entered into the switch. In this example, the key is the word `secret`.

To connect using TACACS+, you must use the shared secret for each device. In your switch documentation, the shared secret can also be referred to as a specific key string or an encryption string.

- k. Under **Access Policy**, select **default-tacacs-user**.
- l. Click **OK**.

# Chapter 11: Resources

---

## Support

Go to the Avaya Support website at <http://support.avaya.com> for the most up-to-date documentation, product notices, and knowledge articles. You can also search for release notes, downloads, and resolutions to issues. Use the online service request system to create a service request. Chat with live agents to get answers to questions, or request an agent to connect you to a support team if an issue requires additional expertise.

---

## Documentation

See *Documentation Reference* for a list of documentation for all VOSS products.

For installation and initial setup information of the Open Networking Adapter (ONA), refer to the Quick Install Guide that came with your ONA.

 **Note:**

The ONA works only with the Avaya Virtual Services Platform 4000 Series.

---

## Training

Ongoing product training is available. For more information or to register, you can access the Web site at <http://avaya-learning.com/>.

---

## Viewing Avaya Mentor videos

Avaya Mentor videos provide technical content on how to install, configure, and troubleshoot Avaya products.

## About this task

Videos are available on the Avaya Support website, listed under the video document type, and on the Avaya-run channel on YouTube.

## Procedure

- To find videos on the Avaya Support website, go to <http://support.avaya.com> and perform one of the following actions:
  - In **Search**, type `Avaya Mentor Videos` to see a list of the available videos.
  - In **Search**, type the product name. On the Search Results page, select **Video** in the **Content Type** column on the left.
- To find the Avaya Mentor videos on YouTube, go to [www.youtube.com/AvayaMentor](http://www.youtube.com/AvayaMentor) and perform one of the following actions:
  - Enter a key word or key words in the **Search Channel** to search for a specific product or topic.
  - Scroll down Playlists, and click the name of a topic to see the available list of videos posted on the website.

### **Note:**

Videos are not available for all products.

---

## Searching a documentation collection

On the Avaya Support website, you can download the documentation library for a specific product and software release to perform searches across an entire document collection. For example, you can perform a single, simultaneous search across the collection to quickly find all occurrences of a particular feature. Use this procedure to perform an index search of your documentation collection.

### Before you begin

- Download the documentation collection zip file to your local computer.
- You must have Adobe Acrobat or Adobe Reader installed on your computer.

## Procedure

1. Extract the document collection zip file into a folder.
2. Navigate to the folder that contains the extracted files and open the file named `<product_name_release>.pdx`.
3. In the Search dialog box, select the option **In the index named** `<product_name_release>.pdx`.
4. Enter a search word or phrase.
5. Select any of the following to narrow your search:
  - Whole Words Only



- Case-Sensitive
  - Include Bookmarks
  - Include Comments
6. Click **Search**.

The search results show the number of documents and instances found. You can sort the search results by Relevance Ranking, Date Modified, Filename, or Location. The default is Relevance Ranking.

---

## Subscribing to e-notifications

Subscribe to e-notifications to receive an email notification when documents are added to or changed on the Avaya Support website.

### About this task

You can subscribe to different types of general notifications, for example, Product Correction Notices (PCN), which apply to any product or a specific product. You can also subscribe to specific types of documentation for a specific product, for example, Application & Technical Notes for Virtual Services Platform 7000.

### Procedure

1. In an Internet browser, go to <https://support.avaya.com>.
2. Type your username and password, and then click **Login**.
3. Under **My Information**, select **SSO login Profile**.
4. Click **E-NOTIFICATIONS**.
5. In the GENERAL NOTIFICATIONS area, select the required documentation types, and then click **UPDATE**.

**GENERAL NOTIFICATIONS**  
1/5 Notifications Selected

|                                                 |                                     |
|-------------------------------------------------|-------------------------------------|
| End of Sale and/or Manufacturer Support Notices | <input type="checkbox"/>            |
| Product Correction Notices (PCN)                | <input checked="" type="checkbox"/> |
| Product Support Notices                         | <input type="checkbox"/>            |
| Security Advisories                             | <input type="checkbox"/>            |
| Services Support Notices                        | <input type="checkbox"/>            |

**UPDATE >>**

6. Click **OK**.
7. In the **PRODUCT NOTIFICATIONS** area, click **Add More Products**.

**PRODUCT NOTIFICATIONS** [Add More Products](#)

Show Details **1 Notices**

8. Scroll through the list, and then select the product name.
9. Select a release version.
10. Select the check box next to the required documentation types.

| PRODUCTS                                    | My Notifications                                                                                                                                                                                                                                                                                                                                                      |
|---------------------------------------------|-----------------------------------------------------------------------------------------------------------------------------------------------------------------------------------------------------------------------------------------------------------------------------------------------------------------------------------------------------------------------|
| Virtual Services Platform 7000              | <b>VIRTUAL SERVICES PLATFORM 7000</b><br>Select a Release Version<br>All and Future                                                                                                                                                                                                                                                                                   |
| Virtualization Provisioning Service         |                                                                                                                                                                                                                                                                                                                                                                       |
| Visual Messenger™ for OCTEL® 250/350        |                                                                                                                                                                                                                                                                                                                                                                       |
| Visual Vectors                              |                                                                                                                                                                                                                                                                                                                                                                       |
| Visualization Performance and Fault Manager |                                                                                                                                                                                                                                                                                                                                                                       |
| Voice Portal                                |                                                                                                                                                                                                                                                                                                                                                                       |
| Voice over IP Monitoring                    |                                                                                                                                                                                                                                                                                                                                                                       |
| W310 Wireless LAN Gateway                   |                                                                                                                                                                                                                                                                                                                                                                       |
| WLAN 2200 Series                            |                                                                                                                                                                                                                                                                                                                                                                       |
| WLAN Handset 2200 Series                    |                                                                                                                                                                                                                                                                                                                                                                       |
|                                             | Administration and System Programming <input type="checkbox"/><br>Application Developer Information <input type="checkbox"/><br>Application Notes <input type="checkbox"/><br>Application and Technical Notes <input checked="" type="checkbox"/><br>Declarations of Conformity <input type="checkbox"/><br>Documentation Library <input checked="" type="checkbox"/> |
|                                             | <b>SUBMIT &gt;&gt;</b>                                                                                                                                                                                                                                                                                                                                                |

11. Click **Submit**.

# Glossary

|                                                                   |                                                                                                                                                                                                                                                                                                                                                                                                                |
|-------------------------------------------------------------------|----------------------------------------------------------------------------------------------------------------------------------------------------------------------------------------------------------------------------------------------------------------------------------------------------------------------------------------------------------------------------------------------------------------|
| <b>American Standard Code for Information Interchange (ASCII)</b> | A code to represent characters in computers. ASCII uses uppercase and lowercase alphabetic letters, numeric digits, and special symbols.                                                                                                                                                                                                                                                                       |
| <b>authentication server</b>                                      | A RADIUS server that provides authorization services to the authenticator, which is software that authorizes or rejects a supplicant attached to the other end of the LAN segment.                                                                                                                                                                                                                             |
| <b>Authentication, Authorization, and Accounting (AAA)</b>        | Authentication, Authorization, and Accounting (AAA) is a framework used to control access to a network, limit network services to certain users, and track what users do. Authentication determines who a user is before allowing the user to access the network and network services. Authorization allows you to determine what you allow a user to do. Accounting records what a user is doing or has done. |
| <b>Challenge Handshake Authentication Protocol (CHAP)</b>         | An access protocol that exchanges a random value between the server and the client and is encrypted with a challenge password.                                                                                                                                                                                                                                                                                 |
| <b>controlled port</b>                                            | In relation to EAPoL, any port on the device with EAPoL enabled.                                                                                                                                                                                                                                                                                                                                               |
| <b>daemon/server</b>                                              | A daemon is a program that services network requests for authentication and authorization, verifies identities, grants or denies authorizations, and logs accounting records.                                                                                                                                                                                                                                  |
| <b>Data Encryption Standard (DES)access control entry (ACE)</b>   | A cryptographic algorithm that protects unclassified computer data. The National Institute of Standards and Technology publishes the DES in the Federal Information Processing Standard Publication 46-1.                                                                                                                                                                                                      |
| <b>Global routing engine (GRE)</b>                                | The base router or routing instance 0 in the Virtual Routing and Forwarding (VRF).                                                                                                                                                                                                                                                                                                                             |
| <b>Institute of Electrical and Electronics Engineers (IEEE)</b>   | An international professional society that issues standards and is a member of the American National Standards Institute, the International Standards Institute, and the International Standards Organization.                                                                                                                                                                                                 |

|                                               |                                                                                                                                                                                                                                                                                                                                                                                                                                            |
|-----------------------------------------------|--------------------------------------------------------------------------------------------------------------------------------------------------------------------------------------------------------------------------------------------------------------------------------------------------------------------------------------------------------------------------------------------------------------------------------------------|
| <b>Internet Engineering Task Force (IETF)</b> | A standards organization for IP data networks.                                                                                                                                                                                                                                                                                                                                                                                             |
| <b>Layer 2</b>                                | Layer 2 is the Data Link Layer of the OSI model. Examples of Layer 2 protocols are Ethernet and Frame Relay.                                                                                                                                                                                                                                                                                                                               |
| <b>Layer 3</b>                                | Layer 3 is the Network Layer of the OSI model. An example of a Layer 3 protocol is Internet Protocol (IP).                                                                                                                                                                                                                                                                                                                                 |
| <b>Local Area Network (LAN)</b>               | A data communications system that lies within a limited spatial area, uses a specific user group and topology, and can connect to a public switched telecommunications network (but is not one).                                                                                                                                                                                                                                           |
| <b>management information base (MIB)</b>      | The MIB defines system operations and parameters used for the Simple Network Management Protocol (SNMP).                                                                                                                                                                                                                                                                                                                                   |
| <b>mask</b>                                   | A bit string that the device uses along with an IP address to indicate the number of leading bits in the address that correspond with the network part.                                                                                                                                                                                                                                                                                    |
| <b>Media Access Control (MAC)</b>             | Arbitrates access to and from a shared medium.                                                                                                                                                                                                                                                                                                                                                                                             |
| <b>Message Digest 5 (MD5)</b>                 | A one-way hash function that creates a message digest for digital signatures.                                                                                                                                                                                                                                                                                                                                                              |
| <b>MultiLink Trunking (MLT)</b>               | A method of link aggregation that uses multiple Ethernet trunks aggregated to provide a single logical trunk. A multilink trunk provides the combined bandwidth of multiple links and the physical layer protection against the failure of a single link.                                                                                                                                                                                  |
| <b>network access server (NAS)</b>            | A network access server (NAS) is a single point of access to a remote device. The NAS acts as a gateway to guard the remote device. A client connects to the NAS and then the NAS connects to another device to verify the credentials of the client. Once verified the NAS allows or disallows access to the device. Network access servers are almost exclusively used with Authentication, Authorization, and Accounting (AAA) servers. |
| <b>next hop</b>                               | The next hop to which a packet can be sent to advance the packet to the destination.                                                                                                                                                                                                                                                                                                                                                       |
| <b>Point-to-Point Protocol (PPP)</b>          | Point-to-Point Protocol is a basic protocol at the data link layer that provides its own authentication protocols, with no authorization stage. PPP is often used to form a direct connection between two networking nodes.                                                                                                                                                                                                                |
| <b>port</b>                                   | A physical interface that transmits and receives data.                                                                                                                                                                                                                                                                                                                                                                                     |

|                                                  |                                                                                                                                                                                                                                                                                                                                                        |
|--------------------------------------------------|--------------------------------------------------------------------------------------------------------------------------------------------------------------------------------------------------------------------------------------------------------------------------------------------------------------------------------------------------------|
| <b>Port Access Entity (PAE)</b>                  | Software that controls each port on the switch. The PAE, which resides on the device, supports authenticator functionality. The PAE works with the Extensible Authentication Protocol over LAN (EAPoL).                                                                                                                                                |
| <b>Protocol Data Units (PDUs)</b>                | A unit of data that is specified in a protocol of a specific layer and that consists of protocol-control information of the specific layer and possibly user data of that layer.                                                                                                                                                                       |
| <b>quality of service (QoS)</b>                  | QoS features reserve resources in a congested network, allowing you to configure a higher priority for certain devices. For example, you can configure a higher priority for IP deskphones, which need a fixed bit rate and split the remaining bandwidth between data connections if calls in the network are more important than the file transfers. |
| <b>Read Write All (RWA)</b>                      | An access class that lets users access all menu items and editable fields.                                                                                                                                                                                                                                                                             |
| <b>remote login (rlogin)</b>                     | An application that provides a terminal interface between hosts (usually UNIX) that use the TCP/IP network protocol. Unlike Telnet, rlogin assumes the remote host is, or behaves like, a UNIX host.                                                                                                                                                   |
| <b>Routing Information Protocol (RIP)</b>        | A distance vector protocol in the IP suite, used by IP network-layer protocol, that enables routers in the same AS to exchange routing information by means of periodic updates. You often use RIP as a very simple interior gateway protocol (IGP) within small networks.                                                                             |
| <b>Secure Copy (SCP)</b>                         | Secure Copy securely transfers files between the switch and a remote station.                                                                                                                                                                                                                                                                          |
| <b>Simple Network Management Protocol (SNMP)</b> | SNMP administratively monitors network performance through agents and management stations.                                                                                                                                                                                                                                                             |
| <b>supplicant</b>                                | A device, such as a PC, that applies for access to the network.                                                                                                                                                                                                                                                                                        |
| <b>User Datagram Protocol (UDP)</b>              | In TCP/IP, a packet-level protocol built directly on the Internet Protocol layer. TCP/IP host systems use UDP for application-to-application programs.                                                                                                                                                                                                 |
| <b>user-based policies (UBP)</b>                 | Establishes and enforces roles and conditions on an individual user basis for access ports in the network.                                                                                                                                                                                                                                             |
| <b>view-based access control model (VACM)</b>    | Provides context, group access, and group security levels based on a predefined subset of management information base (MIB) objects.                                                                                                                                                                                                                   |
| <b>virtual router forwarding (VRF)</b>           | Provides traffic isolation between customers operating over the same node. Each virtual router emulates the behavior of a dedicated hardware router by providing separate routing functionality, and the network treats each VRF as a separate physical router.                                                                                        |