



ExtremeSwitching™

Configuring Security on VSP Operating System Software

Release 6.1 (VSP 8600)
9035291 Rev. 01
March 2018

© 2017-2018, Extreme Networks, Inc.
All Rights Reserved.

Notice

While reasonable efforts have been made to ensure that the information in this document is complete and accurate at the time of printing, Extreme Networks, Inc. assumes no liability for any errors. Extreme Networks, Inc. reserves the right to make changes and corrections to the information in this document without the obligation to notify any person or organization of such changes.

Documentation disclaimer

"Documentation" means information published in varying mediums which may include product information, operating instructions and performance specifications that are generally made available to users of products. Documentation does not include marketing materials. Extreme Networks shall not be responsible for any modifications, additions, or deletions to the original published version of Documentation unless such modifications, additions, or deletions were performed by or on the express behalf of Extreme Networks. End User agrees to indemnify and hold harmless Extreme Networks, Extreme Networks' agents, servants and employees against all claims, lawsuits, demands and judgments arising out of, or in connection with, subsequent modifications, additions or deletions to this documentation, to the extent made by End User.

Link disclaimer

Extreme Networks is not responsible for the contents or reliability of any linked websites referenced within this site or Documentation provided by Extreme Networks. Extreme Networks is not responsible for the accuracy of any information, statement or content provided on these sites and does not necessarily endorse the products, services, or information described or offered within them. Extreme Networks does not guarantee that these links will work all the time and has no control over the availability of the linked pages.

Warranty

Extreme Networks provides a limited warranty on Extreme Networks hardware and software. Refer to your sales agreement to establish the terms of the limited warranty. In addition, Extreme Networks' standard warranty language, as well as information regarding support for this product while under warranty is available to Extreme Networks customers and other parties through the Extreme Networks Support website: <http://www.extremenetworks.com/support> under the link "Policies" or such successor site as designated by Extreme Networks. Please note that if You acquired the product(s) from an authorized Extreme Networks Channel Partner outside of the United States and Canada, the warranty is provided to You by said Extreme Networks Channel Partner and not by Extreme Networks.

"Hosted Service" means an Extreme Networks hosted service subscription that You acquire from either Extreme Networks or an authorized Extreme Networks Channel Partner (as applicable) and which is described further in Hosted SAS or other service description documentation regarding the applicable hosted service. If You purchase a Hosted Service subscription, the foregoing limited warranty may not apply but You may be entitled to support services in connection with the Hosted Service as described further in your service description documents for the applicable Hosted Service. Contact Extreme Networks or Extreme Networks Channel Partner (as applicable) for more information.

Hosted Service

THE FOLLOWING APPLIES ONLY IF YOU PURCHASE AN EXTREME NETWORKS HOSTED SERVICE SUBSCRIPTION FROM EXTREME NETWORKS OR AN EXTREME NETWORKS CHANNEL PARTNER (AS APPLICABLE), THE TERMS OF USE FOR HOSTED SERVICES ARE AVAILABLE ON THE EXTREME NETWORKS WEBSITE, <https://extremeportal.force.com> OR SUCH SUCCESSOR SITE AS DESIGNATED BY EXTREME NETWORKS, AND ARE APPLICABLE TO ANYONE WHO ACCESSES OR USES THE HOSTED SERVICE. BY ACCESSING OR USING THE HOSTED SERVICE, OR AUTHORIZING OTHERS TO DO SO, YOU, ON BEHALF OF YOURSELF AND THE ENTITY FOR WHOM YOU ARE DOING SO (HEREINAFTER REFERRED TO INTERCHANGEABLY AS "YOU" AND "END USER"), AGREE TO THE TERMS OF USE. IF YOU ARE ACCEPTING THE TERMS OF USE ON BEHALF A COMPANY OR OTHER LEGAL ENTITY, YOU

REPRESENT THAT YOU HAVE THE AUTHORITY TO BIND SUCH ENTITY TO THESE TERMS OF USE. IF YOU DO NOT HAVE SUCH AUTHORITY, OR IF YOU DO NOT WISH TO ACCEPT THESE TERMS OF USE, YOU MUST NOT ACCESS OR USE THE HOSTED SERVICE OR AUTHORIZE ANYONE TO ACCESS OR USE THE HOSTED SERVICE.

Licenses

THE SOFTWARE LICENSE TERMS AVAILABLE ON THE EXTREME NETWORKS WEBSITE, <https://extremeportal.force.com> OR SUCH SUCCESSOR SITE AS DESIGNATED BY EXTREME NETWORKS, ARE APPLICABLE TO ANYONE WHO DOWNLOADS, USES AND/OR INSTALLS EXTREME NETWORKS SOFTWARE, PURCHASED FROM EXTREME NETWORKS, INC., ANY EXTREME NETWORKS AFFILIATE, OR AN EXTREME NETWORKS CHANNEL PARTNER (AS APPLICABLE) UNDER A COMMERCIAL AGREEMENT WITH EXTREME NETWORKS OR AN EXTREME NETWORKS CHANNEL PARTNER. UNLESS OTHERWISE AGREED TO BY EXTREME NETWORKS IN WRITING, EXTREME NETWORKS DOES NOT EXTEND THIS LICENSE IF THE SOFTWARE WAS OBTAINED FROM ANYONE OTHER THAN EXTREME NETWORKS, AN EXTREME NETWORKS AFFILIATE OR AN EXTREME NETWORKS CHANNEL PARTNER; EXTREME NETWORKS RESERVES THE RIGHT TO TAKE LEGAL ACTION AGAINST YOU AND ANYONE ELSE USING OR SELLING THE SOFTWARE WITHOUT A LICENSE. BY INSTALLING, DOWNLOADING OR USING THE SOFTWARE, OR AUTHORIZING OTHERS TO DO SO, YOU, ON BEHALF OF YOURSELF AND THE ENTITY FOR WHOM YOU ARE INSTALLING, DOWNLOADING OR USING THE SOFTWARE (HEREINAFTER REFERRED TO INTERCHANGEABLY AS "YOU" AND "END USER"), AGREE TO THESE TERMS AND CONDITIONS AND CREATE A BINDING CONTRACT BETWEEN YOU AND EXTREME NETWORKS, INC. OR THE APPLICABLE EXTREME NETWORKS AFFILIATE ("EXTREME NETWORKS").

Extreme Networks grants You a license within the scope of the license types described below. Where the order documentation does not expressly identify a license type, the applicable license will be a Designated System License as set forth below in the Designated System(s) License (DS) section as applicable. The applicable number of licenses and units of capacity for which the license is granted will be one (1), unless a different number of licenses or units of capacity is specified in the documentation or other materials available to You. "Software" means computer programs in object code, provided by Extreme Networks or an Extreme Networks Channel Partner, whether as stand-alone products, pre-installed on hardware products, and any upgrades, updates, patches, bug fixes, or modified versions thereto. "Designated Processor" means a single stand-alone computing device. "Server" means a set of Designated Processors that hosts (physically or virtually) a software application to be accessed by multiple users. "Instance" means a single copy of the Software executing at a particular time: (i) on one physical machine; or (ii) on one deployed software virtual machine ("VM") or similar deployment.

License type(s)

Designated System(s) License (DS). End User may install and use each copy or an Instance of the Software only: 1) on a number of Designated Processors up to the number indicated in the order; or 2) up to the number of Instances of the Software as indicated in the order, Documentation, or as authorized by Extreme Networks in writing. Extreme Networks may require the Designated Processor(s) to be identified in the order by type, serial number, feature key, Instance, location or other specific designation, or to be provided by End User to Extreme Networks through electronic means established by Extreme Networks specifically for this purpose.

Copyright

Except where expressly stated otherwise, no use should be made of materials on this site, the Documentation, Software, Hosted Service, or hardware provided by Extreme Networks. All content on this site, the documentation, Hosted Service, and the product provided by Extreme Networks including the selection, arrangement and design of the content is owned either by Extreme Networks or its licensors and is protected by copyright and other intellectual property laws including the sui generis rights relating to the protection of databases. You may not modify, copy, reproduce, republish, upload, post, transmit or distribute in any way any content, in whole or in part,

including any code and software unless expressly authorized by Extreme Networks. Unauthorized reproduction, transmission, dissemination, storage, and or use without the express written consent of Extreme Networks can be a criminal, as well as a civil offense under the applicable law.

Virtualization

The following applies if the product is deployed on a virtual machine. Each product has its own ordering code and license types. Note, unless otherwise stated, that each Instance of a product must be separately licensed and ordered. For example, if the end user customer or Extreme Networks Channel Partner would like to install two Instances of the same type of products, then two products of that type must be ordered.

Third Party Components

"Third Party Components" mean certain software programs or portions thereof included in the Software or Hosted Service may contain software (including open source software) distributed under third party agreements ("Third Party Components"), which contain terms regarding the rights to use certain portions of the Software ("Third Party Terms"). As required, information regarding distributed Linux OS source code (for those products that have distributed Linux OS source code) and identifying the copyright holders of the Third Party Components and the Third Party Terms that apply is available in the products, Documentation or on Extreme Networks' website at: <http://www.extremenetworks.com/support/policies/software-licensing> or such successor site as designated by Extreme Networks. The open source software license terms provided as Third Party Terms are consistent with the license rights granted in these Software License Terms, and may contain additional rights benefiting You, such as modification and distribution of the open source software. The Third Party Terms shall take precedence over these Software License Terms, solely with respect to the applicable Third Party Components to the extent that these Software License Terms impose greater restrictions on You than the applicable Third Party Terms.

The following applies only if the H.264 (AVC) codec is distributed with the product. THIS PRODUCT IS LICENSED UNDER THE AVC PATENT PORTFOLIO LICENSE FOR THE PERSONAL USE OF A CONSUMER OR OTHER USES IN WHICH IT DOES NOT RECEIVE REMUNERATION TO (i) ENCODE VIDEO IN COMPLIANCE WITH THE AVC STANDARD ("AVC VIDEO") AND/OR (ii) DECODE AVC VIDEO THAT WAS ENCODED BY A CONSUMER ENGAGED IN A PERSONAL ACTIVITY AND/OR WAS OBTAINED FROM A VIDEO PROVIDER LICENSED TO PROVIDE AVC VIDEO. NO LICENSE IS GRANTED OR SHALL BE IMPLIED FOR ANY OTHER USE. ADDITIONAL INFORMATION MAY BE OBTAINED FROM MPEG LA, L.L.C. SEE [HTTP://WWW.MPEGLA.COM](http://WWW.MPEGLA.COM).

Service Provider

THE FOLLOWING APPLIES TO EXTREME NETWORKS CHANNEL PARTNER'S HOSTING OF EXTREME NETWORKS PRODUCTS OR SERVICES. THE PRODUCT OR HOSTED SERVICE MAY USE THIRD PARTY COMPONENTS SUBJECT TO THIRD PARTY TERMS AND REQUIRE A SERVICE PROVIDER TO BE INDEPENDENTLY LICENSED DIRECTLY FROM THE THIRD PARTY SUPPLIER. AN EXTREME NETWORKS CHANNEL PARTNER'S HOSTING OF EXTREME NETWORKS PRODUCTS MUST BE AUTHORIZED IN WRITING BY EXTREME NETWORKS AND IF THOSE HOSTED PRODUCTS USE OR EMBED CERTAIN THIRD PARTY SOFTWARE, INCLUDING BUT NOT LIMITED TO MICROSOFT SOFTWARE OR CODECS, THE EXTREME NETWORKS CHANNEL PARTNER IS REQUIRED TO INDEPENDENTLY OBTAIN ANY APPLICABLE LICENSE AGREEMENTS, AT THE EXTREME NETWORKS CHANNEL PARTNER'S EXPENSE, DIRECTLY FROM THE APPLICABLE THIRD PARTY SUPPLIER.

WITH RESPECT TO CODECS, IF THE EXTREME NETWORKS CHANNEL PARTNER IS HOSTING ANY PRODUCTS THAT USE OR EMBED THE G.729 CODEC, H.264 CODEC, OR H.265 CODEC, THE EXTREME NETWORKS CHANNEL PARTNER ACKNOWLEDGES AND AGREES THE EXTREME NETWORKS CHANNEL PARTNER IS RESPONSIBLE FOR ANY AND ALL RELATED FEES AND/OR ROYALTIES. THE G.729 CODEC IS LICENSED BY SIPRO LAB TELECOM INC. SEE WWW.SIPRO.COM/CONTACT.HTML. THE H.264 (AVC) CODEC IS LICENSED UNDER THE AVC PATENT PORTFOLIO LICENSE FOR

THE PERSONAL USE OF A CONSUMER OR OTHER USES IN WHICH IT DOES NOT RECEIVE REMUNERATION TO: (I) ENCODE VIDEO IN COMPLIANCE WITH THE AVC STANDARD ("AVC VIDEO") AND/OR (II) DECODE AVC VIDEO THAT WAS ENCODED BY A CONSUMER ENGAGED IN A PERSONAL ACTIVITY AND/OR WAS OBTAINED FROM A VIDEO PROVIDER LICENSED TO PROVIDE AVC VIDEO. NO LICENSE IS GRANTED OR SHALL BE IMPLIED FOR ANY OTHER USE. ADDITIONAL INFORMATION FOR H.264 (AVC) AND H.265 (HEVC) CODECS MAY BE OBTAINED FROM MPEG LA, L.L.C. SEE [HTTP://WWW.MPEGLA.COM](http://WWW.MPEGLA.COM).

Compliance with Laws

You acknowledge and agree that it is Your responsibility for complying with any applicable laws and regulations, including, but not limited to laws and regulations related to call recording, data privacy, intellectual property, trade secret, fraud, and music performance rights, in the country or territory where the Extreme Networks product is used.

Preventing Toll Fraud

"Toll Fraud" is the unauthorized use of your telecommunications system by an unauthorized party (for example, a person who is not a corporate employee, agent, subcontractor, or is not working on your company's behalf). Be aware that there can be a risk of Toll Fraud associated with your system and that, if Toll Fraud occurs, it can result in substantial additional charges for your telecommunications services.

Security Vulnerabilities

Information about Extreme Networks' security support policies can be found in the Global Technical Assistance Center Knowledgebase at <https://gtacknowledge.extremenetworks.com/>.

Downloading Documentation

For the most current versions of Documentation, see the Extreme Networks Support website: <http://documentation.extremenetworks.com>, or such successor site as designated by Extreme Networks.

Contact Extreme Networks Support

See the Extreme Networks Support website: <http://www.extremenetworks.com/support> for product or Hosted Service notices and articles, or to report a problem with your Extreme Networks product or Hosted Service. For a list of support telephone numbers and contact addresses, go to the Extreme Networks Support website: <http://www.extremenetworks.com/support/contact/> (or such successor site as designated by Extreme Networks), scroll to the bottom of the page, and select Contact Extreme Networks Support.

Contact Avaya Support

See the Avaya Support website: <https://support.avaya.com> for product or Hosted Service notices and articles, or to report a problem with your Avaya product or Hosted Service. For a list of support telephone numbers and contact addresses, go to the Avaya Support website: <https://support.avaya.com> (or such successor site as designated by Avaya), scroll to the bottom of the page, and select Contact Avaya Support.

Trademarks

The trademarks, logos and service marks ("Marks") displayed in this site, the Documentation, Hosted Service(s), and product(s) provided by Extreme Networks are the registered or unregistered Marks of Extreme Networks, Inc., its affiliates, its licensors, its suppliers, or other third parties. Users are not permitted to use such Marks without prior written consent from Extreme Networks or such third party which may own the Mark. Nothing contained in this site, the Documentation, Hosted Service(s) and product(s) should be construed as granting, by implication, estoppel, or otherwise, any license or right in and to the Marks without the express written permission of Extreme Networks or the applicable third party.

Extreme Networks is a registered trademark of Extreme Networks, Inc.

All non-Extreme Networks trademarks are the property of their respective owners. Linux® is the registered trademark of Linus Torvalds in the U.S. and other countries.

For additional information on Extreme Networks trademarks, please see: <http://www.extremenetworks.com/company/legal/>

Contents

Chapter 1: Preface	12
Purpose	12
Training.....	12
Providing Feedback to Us.....	13
Getting Help.....	13
Extreme Networks Documentation.....	14
Subscribing to service notifications.....	14
Chapter 2: New in this document	16
Notice about feature support.....	16
Chapter 3: Security	17
Security overview.....	17
Security modes.....	18
hsecure mode.....	19
CLI passwords.....	20
Port Lock feature.....	21
Access policies for services.....	21
User-based policy support.....	21
Denial-of-service attack prevention.....	22
Configuration considerations.....	23
Interoperability configuration.....	24
Unicast Reverse Path Forwarding (uRPF).....	24
Digital Certificate/PKI.....	25
Certificate order priority.....	27
Security configuration using CLI.....	28
Enabling hsecure.....	28
Changing an invalid-length password.....	29
Changing passwords.....	30
Configuring directed broadcast.....	32
Preventing certain types of DOS attacks.....	33
Configuring port lock.....	34
Unicast Reverse Path Forwarding configuration using CLI.....	36
Digital certificate configuration using CLI.....	45
Security configuration using Enterprise Device Manager.....	61
Enabling port lock.....	62
Locking a port.....	62
Changing passwords.....	63
Configuring directed broadcast on a VLAN.....	65
Unicast Reverse Path Forwarding configuration using EDM.....	66
Viewing ASG global configuration.....	70

Viewing active ASG accounts.....	71
Digital certificate configuration using EDM.....	71
Chapter 4: Layer 2 security.....	80
Layer 2 security for IPv4 and IPv6 deployments.....	80
Dynamic ARP Inspection.....	80
First Hop Security.....	81
DHCP Snooping and Neighbor Discovery inspection.....	93
IP Source Guard.....	95
Layer 2 security configuration using the CLI.....	97
DHCP Snooping configuration using CLI.....	97
Dynamic ARP Inspection configuration using CLI.....	104
FHS configuration.....	107
DHCPv6 Guard policy configuration.....	112
RA Guard configuration.....	117
IPv6 Neighbor Discovery inspection configuration.....	123
IPv6 DHCP snooping configuration.....	126
IP Source Guard configuration	130
Layer 2 security configuration using the EDM.....	141
Dynamic ARP Inspection configuration using EDM.....	141
Configuring FHS Globals.....	142
IPv6 access list configuration.....	143
MAC access list configuration.....	145
DHCPv6 Guard policy configuration.....	147
RA Guard policy configuration.....	150
Port policy mapping configuration.....	154
DHCP Snooping configuration using EDM.....	156
IP Source Guard configuration using the EDM.....	162
Layer 2 security example scenarios.....	165
FHS deployment scenario.....	165
Creating FHS IPv6 ACL.....	166
Creating an FHS MAC ACL.....	167
Creating a DHCPv6 Guard policy for the router.....	167
Creating an RA Guard policy for the router.....	168
Attaching FHS policies to the interfaces.....	168
IPv6 DHCP Snooping and ND Inspection configuration example.....	169
Configuring IP Source Guard.....	170
Chapter 5: Extensible Authentication Protocol over LAN.....	174
EAPOL fundamentals.....	174
EAP terminology.....	174
EAP configuration.....	175
EAP system requirements.....	179
EAP dynamic VLAN assignment.....	180
Traffic forwarding on EAP enabled port.....	183

RADIUS-assigned VLAN.....	184
NEAP host.....	186
NEAP client.....	188
EAP and NEAP limitations.....	188
Multiple Host Single Authentication.....	190
Guest VLAN.....	190
EAP and NEAP separation.....	194
EAP and NEAP VLAN names.....	194
Fail Open VLAN.....	194
EAPoL configuration using CLI.....	195
Globally enabling EAP on the device.....	196
Configuring EAP on an interface.....	196
Configuring EAP on a port.....	197
Configuring an EAP-enabled RADIUS server.....	199
Configuring the switch for EAP and RADIUS.....	200
Changing the authentication status of a port.....	202
Deleting an EAP-enabled RADIUS server.....	203
Configuring Fail Open VLAN.....	204
Displaying the current EAP-based security status.....	205
Displaying the port VLAN information.....	206
Configuring the format of the RADIUS password attribute when authenticating NEAP MAC addresses using RADIUS.....	207
Enabling RADIUS authentication of NEAP hosts on EAP enabled ports.....	208
Configuring the maximum MAC clients.....	209
Configuring maximum EAP clients.....	210
Configuring maximum NEAP clients.....	210
Configuring the Guest VLAN ID.....	211
Clearing NEAP session.....	212
Configuring EAP operational mode.....	213
EAP configuration using Enterprise Device Manager.....	214
Globally configuring EAP on the server.....	214
Configuring EAP on a port.....	215
Showing the Port Access Entity Port table.....	218
Showing EAP Authentication.....	219
Viewing Multihost status information.....	220
Viewing EAP session statistics.....	221
Viewing NEAP MAC information.....	221
Chapter 6: IPsec.....	223
IPsec fundamentals.....	223
Authentication header.....	225
Encapsulating security payload.....	226
IPsec modes.....	226
Security association.....	227

Security policy.....	227
IPsec limitations.....	228
IPsec configuration using CLI.....	228
Creating an IPsec policy.....	228
Enabling an IPsec policy.....	229
Creating an IPsec security association.....	230
Configuring an IPsec security association.....	231
Configuring an IPsec policy.....	234
Linking the IPsec security association to an IPsec policy.....	236
Enabling IPsec on an interface.....	237
Linking an IPsec policy to an interface.....	238
Enabling IPsec on a management interface.....	240
Linking an IPsec policy to a management interface.....	240
Displaying IPsec information on an interface.....	242
Displaying configured IPsec policies.....	244
Displaying IPsec security association information.....	246
IPsec configuration using EDM.....	248
Creating an IPsec policy.....	249
Creating an IPsec security association.....	250
Linking the IPsec security association to an IPsec policy.....	253
Enabling IPsec on an IPv6 interface.....	254
Enabling IPsec on an IPv4 interface.....	254
Linking an IPsec policy to an interface.....	255
Displaying IPsec interface statistics.....	256
Displaying switch level statistics for IPsec-enabled interfaces.....	259
Configuring IPsec for the OSPF virtual link.....	261
IPsec configuration examples.....	263
IPsec configuration example.....	263
IPsec with ICMPv6 configuration example.....	264
OSPFv3 IPsec configuration example.....	266
OSPFv3 virtual link IPsec configuration example.....	272
IPsec configuration of TCP.....	276
Chapter 7: MACsec.....	279
MACsec fundamentals.....	279
MACsec keys.....	280
MACsec security modes.....	281
Connectivity associations and secure channels.....	282
MACsec 2AN and 4AN mode.....	282
MACsec components.....	282
MACsec operation.....	285
MACsec performance.....	286
MACsec configuration using CLI.....	286
Configuring a connectivity association.....	286

Updating the connectivity association key (CAK).....	288
Configuring MACsec encryption on a port.....	290
Configuring the confidentiality offset on a port.....	290
Viewing the MACsec connectivity association details.....	292
Viewing MACsec status.....	293
MACsec configuration using EDM.....	295
Configuring connectivity associations.....	295
Associating a port with a connectivity association.....	296
Chapter 8: RADIUS	298
RADIUS fundamentals.....	298
RADIUS configuration using CLI.....	303
Configuring RADIUS attributes.....	303
Configuring RADIUS profile.....	306
Enabling RADIUS authentication.....	307
Enabling the source IP flag for the RADIUS server.....	307
Enabling RADIUS accounting.....	308
Enabling RADIUS-SNMP accounting.....	309
Configuring RADIUS accounting interim request.....	310
Configuring RADIUS authentication and RADIUS accounting attributes.....	311
Adding a RADIUS server.....	314
Modifying RADIUS server settings.....	315
Showing RADIUS information.....	317
Displaying RADIUS server information.....	318
Configuring RADIUS server reachability.....	318
Displaying RADIUS server reachability.....	319
Showing RADIUS SNMP configurations.....	320
RADIUS configuration using Enterprise Device Manager.....	320
Enabling RADIUS authentication.....	321
Enabling RADIUS accounting.....	322
Disabling RADIUS accounting.....	324
Enabling RADIUS accounting interim request.....	324
Configuring the source IP option for the RADIUS server.....	326
Adding a RADIUS server.....	328
Reauthenticating the RADIUS SNMP server session.....	329
Configuring RADIUS SNMP.....	330
Modifying a RADIUS configuration.....	331
Deleting a RADIUS configuration.....	332
Configuring RADIUS server reachability.....	333
Chapter 9: Secure AAA server communication	335
IKE configuration for Secure AAA server using CLI.....	340
Configuring an IKE Phase 1 profile.....	340
Creating an IKE Phase 1 policy.....	341
Configuring profile to be used for IKE Phase 1 policy.....	342

Configuring IKE Phase 2 perfect forward secrecy	343
Configuring the IKE authentication method.....	343
Configuring dead-peer detection timeout.....	345
Enabling the admin state of IKE Phase 1 policy.....	345
Displaying IKE profiles.....	346
Displaying IKE policies.....	347
Displaying IKE security association.....	349
Configuring an IKEv2 profile.....	351
Displaying IKEv2 profiles.....	353
IKE configuration for Secure AAA server.....	354
Configuring IKE Phase 1 profile.....	354
Configuring IKEv2 profile.....	355
Configuring IKE Phase 1 policy.....	356
Displaying IKE Phase 1 security association.....	358
Displaying IKE V2 security association.....	359
Chapter 10: Simple Network Management Protocol (SNMP)	361
SNMPv3.....	361
SNMP community strings.....	366
SNMPv3 support for VRF.....	368
SNMP configuration using CLI.....	368
Configuring SNMP settings.....	369
Creating a user.....	372
Creating a new user group.....	374
Creating a new entry for the MIB in the view table.....	375
Creating a community.....	376
Adding a user to a group.....	377
Blocking SNMP.....	378
Displaying SNMP system information.....	379
SNMP configuration using Enterprise Device Manager.....	380
Creating a user.....	381
Creating a new group membership.....	382
Creating access for a group.....	383
Creating access policies for SNMP groups.....	384
Assigning MIB view access for an object.....	385
Creating a community.....	386
Viewing all contexts for an SNMP entity.....	387
Chapter 11: TACACS+	388
TACACS+ fundamentals.....	388
TACACS+ Operation.....	389
TACACS+ Architecture.....	390
Authentication, authorization, and accounting	390
Privilege level changes at runtime.....	394
TACACS+ and RADIUS differences.....	398

TACACS+ feature limitations.....	399
TACACS+ configuration using CLI.....	400
Enabling TACACS+.....	400
Adding a TACACS+ server.....	400
Configuring TACACS+ authentication.....	406
Configuring TACACS+ accounting.....	407
Configuring command authorization with TACACS+.....	408
Changing privilege levels at runtime.....	409
TACACS+ configuration using EDM.....	411
Configuring TACACS+ globally.....	411
Adding a TACACS+ server.....	413
Modifying a TACACS+ configuration.....	416
TACACS+ configuration examples.....	417
TACACS+ configuration on the switch.....	417
Identity Engines Ignition Server TACACS+ configuration example.....	418
Glossary.....	423

Chapter 1: Preface

Purpose

This document provides information on features in VSP Operating System Software (VOSS). VOSS runs on the following product families:

- Extreme Networks Virtual Services Platform 4000 Series
- Extreme Networks Virtual Services Platform 7200 Series
- Extreme Networks Virtual Services Platform 8000 Series (includes VSP 8200 and VSP 8400 Series)
- Extreme Networks Virtual Services Platform 8600

This security documentation provides conceptual information and procedures that you can use to administer and configure the security features for the VOSS switches.

The security function includes tasks related to product security such as the management and protection of resources from unauthorized or detrimental access and use. This document includes information that supports the configuration and ongoing management of the following:

- communications
- data security
- user security
- access

Examples and network illustrations in this document may illustrate only one of the supported platforms. Unless otherwise noted, the concept illustrated applies to all supported platforms.

Training

Ongoing product training is available. For more information or to register, you can access the Web site at www.extremenetworks.com/education/.

Providing Feedback to Us

We are always striving to improve our documentation and help you work better, so we want to hear from you! We welcome all feedback but especially want to know about:

- Content errors or confusing or conflicting information.
- Ideas for improvements to our documentation so you can find the information you need faster.
- Broken links or usability issues.

If you would like to provide feedback to the Extreme Networks Information Development team about this document, please contact us using our short [online feedback form](#). You can also email us directly at internalinfodev@extremenetworks.com

Getting Help

Product purchased from Extreme Networks

If you purchased your product from Extreme Networks, use the following support contact information to get help.

If you require assistance, contact Extreme Networks using one of the following methods:

- [GTAC \(Global Technical Assistance Center\) for Immediate Support](#)
 - Phone: 1-800-998-2408 (toll-free in U.S. and Canada) or +1 408-579-2826. For the support phone number in your country, visit: www.extremenetworks.com/support/contact
 - Email: support@extremenetworks.com. To expedite your message, enter the product name or model number in the subject line.
- [GTAC Knowledge](#) – Get on-demand and tested resolutions from the GTAC Knowledgebase, or create a help case if you need more guidance.
- [The Hub](#) – A forum for Extreme customers to connect with one another, get questions answered, share ideas and feedback, and get problems solved. This community is monitored by Extreme Networks employees, but is not intended to replace specific guidance from GTAC.
- [Support Portal](#) – Manage cases, downloads, service contracts, product licensing, and training and certifications.

Before contacting Extreme Networks for technical support, have the following information ready:

- Your Extreme Networks service contract number and/or serial numbers for all involved Extreme Networks products
- A description of the failure
- A description of any action(s) already taken to resolve the problem
- A description of your network environment (such as layout, cable type, other relevant environmental information)
- Network load at the time of trouble (if known)

- The device history (for example, if you have returned the device before, or if this is a recurring problem)
- Any related RMA (Return Material Authorization) numbers

Product purchased from Avaya

If you purchased your product from Avaya, use the following support contact information to get help.

Go to the Avaya Support website at <http://support.avaya.com> for the most up-to-date documentation, product notices, and knowledge articles. You can also search for release notes, downloads, and resolutions to issues. Use the online service request system to create a service request. Chat with live agents to get answers to questions, or request an agent to connect you to a support team if an issue requires additional expertise.

Extreme Networks Documentation

To find Extreme Networks product guides, visit our documentation pages at:

Current Product Documentation	www.extremenetworks.com/documentation/
Archived Documentation (for previous versions and legacy products)	www.extremenetworks.com/support/documentation-archives/
Release Notes	www.extremenetworks.com/support/release-notes

Open Source Declarations

Some software files have been licensed under certain open source licenses. More information is available at: www.extremenetworks.com/support/policies/software-licensing.

Subscribing to service notifications

Subscribe to receive an email notification for product and software release announcements, Vulnerability Notices, and Service Notifications.

About this task

You can modify your product selections at any time.

Procedure

1. In an Internet browser, go to <http://www.extremenetworks.com/support/service-notification-form/>.
2. Type your first and last name.
3. Type the name of your company.
4. Type your email address.

5. Type your job title.
6. Select the industry in which your company operates.
7. Confirm your geographic information is correct.
8. Select the products for which you would like to receive notifications.
9. Click **Submit**.

Chapter 2: New in this document

The following sections detail what is new in *Configuring Security*.

IPsec updates

IPsec information is updated in the document. CLI commands and EDM paths are updated.

For more information, see:

- [IPsec configuration using CLI](#) on page 228
- [IPsec configuration using EDM](#) on page 248

Notice about feature support

This document includes content for multiple hardware platforms across different software releases. As a result, the content can include features not supported by your hardware in the current software release.

If a documented command, parameter, tab, or field does not appear on your hardware, it is not supported.

For information about feature support, see *Release Notes*.

For information about physical hardware restrictions, see your hardware documentation.

Chapter 3: Security

This section provides conceptual content to help you configure and customize the security services on the switch.

Security overview

Security is a critical attribute of networking devices. Security features are split into two main areas:

- Control path—protects the access to the device from a management perspective.
- Data path—protects the network from malicious users by controlling access authorization to the network resources (such as servers and stations). This protection is primarily accomplished by using filters or access lists.

You can protect the control path using the following mechanism:

- logon and passwords
- access policies to specify the network and address that can use a service or daemon
- secure protocols, such as Secure Shell (SSH), Secure Copy (SCP), and the Simple Network Management Protocol version 3 (SNMPv3)
- the Message Digest 5 Algorithm (MD5) to protect routing updates, Open Shortest Path First (OSPF), and Border Gateway Protocol (BGP)

You can protect the data path using the following mechanism

- Media Access Control (MAC) address filtering
- Layer 3 filtering, such as Internet Protocol (IP) and User Datagram Protocol (UDP)/Transmission Control Protocol (TCP) filtering
- routing policies to prevent users from accessing restricted areas of the network
- mechanisms to prevent denial-of-service (DOS) attacks

Security modes

The switch support three security modes:

- Enhanced secure
- Hsecure
- SSH secure

Enable SSH secure mode to allow only SSH to be used and disable all other protocols which include Telnet, rlogin, FTP, SNMP, TFTP, HTTP, and HTTPS. Enabling this mode disables Telnet, rlogin, FTP, SNMP, TFTP, HTTP, and HTTPS by setting the boot flags for these protocols to off. You can over-ride the configuration and enable required protocols individually for run-time use. The administrator must enable required protocols individually for run-time use again following a reboot even if you save the configuration. This is because the SSH secure mode enable takes precedence at the time of reboot and the other protocols will be disabled even though the configuration file has them set to enabled.

*** Note:**

Disabling SSH secure mode will not automatically enable the OA&M protocols that were disabled. The boot flags for the required protocols will have to be individually set to enabled.

The following table lists the differences between enhanced secure mode and hsecure mode.

Table 1: Enhanced secure mode versus hsecure mode

Feature	Enhanced secure	Hsecure
Authentication	Role-based: <ul style="list-style-type: none"> • admin • privilege • operator • security • auditor 	Access-level based: <ul style="list-style-type: none"> • rwa • rw • ro • l3 • l2 • l1
Password length	Minimum of 8 characters with the exception of the Admin, which requires a minimum of 15 characters	10 characters, minimum
Password rules	1 or 2 upper case, lower case, numeric and special characters	Minimum of 2 upper case, 2 lower case, 2 numeric and 2 special characters
Password expiration	Per-user minimum change interval is enforced, which is programmed by the Administrator	Global expiration, configured by the Admin

Table continues...

Feature	Enhanced secure	Hsecure
Password-unique	Previous passwords and common passwords between users are prevented	The same
Password renewal	Automatic password renewal is enforced	The same
Audit logs	Audit logs are encrypted, and authorized users are able to view, modify, and delete.	Standard operation
SNMPv3	Password rules apply to SNMPv3 Auth&Priv. SNMPv3 is required (V1/V2 disabled)	SNMPv1 and SNMPv2 can be enabled.
EDM	Site Admin to enable or disable	Disabled
Telnet and FTP	Site Admin to enable or disable	The same
DOS attack Prevention	Not available	Prevents DOS attacks by filtering IP addresses and IP address ranges.

For information on Enhanced secure mode and SSH, see *Administering*.

hsecure mode

The switch supports a flag called high secure (hsecure). hsecure introduces the following behaviors for passwords:

- 10-character enforcement
- aging time
- limitation of failed logon attempts
- protection mechanism to filter certain IP addresses

After you enable the hsecure flag, the software enforces the 10-character rule for all passwords. This password must contain a minimum of two uppercase characters, two lowercase characters, two numbers, and two special characters.

After you enable hsecure, the system requires you to save the configuration file and reboot the system for hsecure to take effect. If the existing password does not meet the minimum requirements for hsecure, the system prompts you to change the password during the first login.

The default username is rwa and the default password is rwa. In hsecure, the system prompts you to change these during first login because they do not meet the minimum requirements for hsecure.

When you enable hsecure, the system disables Simple Network Management Protocol (SNMP) v1, SNMPv2 and SNMPv3. If you want to use SNMP, you must re-enable SNMP, using the command `no boot config flag block-snmp`.

Aging enforcement

After you enable the `hsecure` flag, you can configure a duration after which you must change your password. You configure the duration by using the `aging` parameter.

For SNMP and File Transfer Protocol (FTP), after a password expires, access is denied. Before you access the system, you must change a community string to a new string consisting of more than eight characters.

Important:

Consider the following after you enable the `hsecure` flag:

- You cannot enable the Web server for Enterprise Device Manager (EDM) access.
- You cannot enable the Secure Shell (SSH) password authentication.

For more information, see *Administering*.

Filtering mechanism

Incorrect IP source addresses as network or broadcast addresses are filtered at the virtual router interface. Source addresses 192.168.168.0 and 192.168.168.255 are discarded.

This change is valid for all IP subnets, not only for /24.

You can filter addresses only if you enable the `hsecure` mode.

CLI passwords

The switch ships with default passwords assigned for access to Command Line Interface (CLI) through a console or management session. If you have `read/write/all` access authority, and you are using SNMPv3, you can change passwords that are in an encrypted format. If you are using Enterprise Device Manager (EDM), you can also specify the number of available Telnet sessions and `rlogin` sessions.

Important:

The default passwords are documented and well known. Change the default passwords and community strings immediately after you first log on.

If you enable enhanced secure mode with the `boot config flags enhancedsecure-mode` command, you enable different access levels, along with stronger password complexity, length, and minimum change intervals. For more information on system access fundamentals and configuration, see *Administering*.

Port Lock feature

You can use the Port Lock feature to administratively lock a port or ports to prevent other users from changing port parameters or modifying port action. You cannot modify locked ports until the ports are first unlocked.

Access policies for services

You can control access to the switch by creating an access policy. An access policy specifies the hosts or networks that can access the device through various services, such as Telnet, SNMP, Trivial File Transfer Protocol (TFTP), File Transfer Protocol (FTP), Hypertext Transfer Protocol (HTTP), Remote Shell (RSH), and remote login (rlogin). You can enable or disable access services by setting flags from CLI.

You can define network stations that can explicitly access the switch or stations that cannot access it. For each service you can also specify the level of access, such as read-only or read-write-all.

Important:

A third-party security scan shows the switch service ports open and in the listen state. No connections are accepted on these ports unless you enable the particular daemon. The switch does not dynamically start and stop the daemons at runtime and needs to keep them running from system startup.

For more information about configuring access policies, see *Administering*.

User-based policy support

You can set up a user-based policy (UBP) system by using Enterprise Policy Manager (EPM), a RADIUS server.

EPM is an application designed to manage the traffic prioritization and network access security for business applications. It provides centralized control of advanced packet classification and the ability to priority mark, police, meter, or block traffic.

EPM 5.0 supports UBPs, which allow security administrators to establish and enforce roles and conditions for each user for all access ports in the network. The UBP feature in EPM works in conjunction with Extensible Access Protocol (EAP) technology to enhance the security of the network. Users log on to the networks and are authenticated as the network connection is established.

The UBP feature works as an extension to the Roles feature in EPM. In a UBP environment, role objects are linked directly to specific users (as RADIUS attributes), as opposed to being linked

simply to device interfaces. The role object then links the users to specific policies that control the user's access to the network.

When the RADIUS server successfully authenticates a user, the device sends an EAP session start event to the EPM policy server. The policy server then sends user-based policy configuration information for the new user roles to the interface, based on the role attribute that was assigned to that user on the RADIUS server.

Denial-of-service attack prevention

Hsecure

The switch supports a configurable flag, called high secure (hsecure). High secure mode introduces a protection mechanism to filter certain IP addresses, and two restrictions on passwords: 10-character enforcement and aging time.

If the device starts in hsecure mode with default factory settings, and no previously configured password, the system will prompt you to change the password. The new password must follow the rules mandated by high secure mode. After you enable hsecure and restart the system, if you have an invalid-length password you must change the password.

If you enable hsecure for the first time and the password file does not exist, then the device creates a normal default username (rwa) and password (rwa). In this case, the password does not meet the minimum requirements for hsecure and as a result the system prompts you to change the password.

The following information describes hsecure mode operations:

- When you enable the hsecure flag, after a certain duration you are asked to change your password. If not configured, the aging parameter defaults to 90 days.
- For SNMP and FTP, access is denied when a password expires. You must change the community strings to a new string made up of more than eight characters before accessing the system.
- You cannot enable the Web server at any time.
- You cannot enable the SSH password-authentication feature at any time.

Hsecure is disabled by default. When you enable hsecure, the desired behavior applies to all ports.

For more information, see [Preventing certain types of DOS attacks](#) on page 33.

Prioritization of control traffic

The switch uses a sophisticated prioritization scheme to schedule control packets on physical ports. This scheme involves two levels with both hardware and software queues to guarantee proper handling of control packets regardless of the switch load. In turn, this scheme guarantees the stability of the network. Prioritization also guarantees that applications that use many broadcasts are handled with lower priority.

You cannot view, configure, or modify control-traffic queues.

Directed broadcast suppression

You can enable or disable forwarding for directed broadcast traffic on an IP-interface basis. A directed broadcast is a frame sent to the subnet broadcast address on a remote IP subnet. By

disabling or suppressing directed broadcasts on an interface, you cause all frames sent to the subnet broadcast address for a local router interface to be dropped. Directed broadcast suppression protects hosts from possible DoS attacks.

To prevent the flooding of other networks with DoS attacks, such as the Smurf attack, the switch is protected by directed broadcast suppression. This feature is enabled by default. It is recommended not to disable it.

For more information, see [Configuring directed broadcast](#) on page 32.

ARP request threshold recommendations

The Address Resolution Protocol (ARP) request threshold defines the maximum number of outstanding unresolved ARP requests. The default value for this function is 500 ARP requests. To avoid excessive amounts of subnet scanning that a virus can cause, it is recommended that you change the ARP request threshold to a value between 100 and 50. This configuration protects the CPU from causing excessive ARP requests, protects the network, and lessens the spread of the virus to other PCs. The following list provides further recommended ARP threshold values:

- Default: 500
- Severe conditions: 50
- Continuous scanning conditions: 100
- Moderate: 200
- Relaxed: 500

For more information about how to configure the ARP threshold, see *Configuring IPv4 Routing*.

Multicast Learning Limitation

The Multicast Learning Limitation feature protects the CPU from multicast data packet bursts generated by malicious applications. If more than a certain number of multicast streams enter the CPU through a port during a sampling interval, the port is shut down until the user or administrator takes the appropriate action.

For more information, see *Configuring IP Multicast Routing Protocols*.

Configuration considerations

Use the information in this section to understand the limitations of some security functions such as BSAC RADIUS servers and Layer 2 protocols before you attempt to configure security.

Single profile enhancement for BSAC RADIUS servers

Before enabling Remote Access Dial-In User Services (RADIUS) accounting on the device, you must configure at least one RADIUS server.

The switch software supports Microsoft Radius Servers (NPS Windows 2008, Windows 2003 IAS Server), BaySecure Access Control (BSAC), Merit Network servers and Linux based servers. To use these servers, you must first obtain the software for the server. You must also make changes to one or more configuration files for these servers.

Single Profile is a feature that is specific to BSAC RADIUS servers. In a BSAC RADIUS server, when you create a client profile, you can specify all the returnable attributes. When you use the

same profile for different products (Virtual Services Platform 8000 Series and Baystack 450, for example) you specify all the returnable attributes in the single profile.

Attribute format for a third-party RADIUS server

If you use a third-party RADIUS server and need to modify the dictionary files, you must add a vendor-specific attribute (attribute #26) and use 1584 as vendor code for all the devices and then send back access-priority vendor-assigned attribute number 192 with a decimal value of 1 to 6, depending upon whether you want read only to read-write-all.

RADIUS on management ports

The management port supports the RADIUS protocol. When RADIUS packets are sent out of the management port, the SRC-IP address is properly entered in the RADIUS header.

For more information about the supported RADIUS servers, see the documentation of the RADIUS server.

SNMP cloned user considerations

If the user from which you are cloning has authentication, you can choose for the new user to either have the same authentication protocol as the user from which it was cloned, or no authentication. If you choose authentication for the new user, you must provide a password for that user. If you want a new user to have authentication, you must indicate that at the time you create the new user. You can assign a privacy protocol only to a user that has authentication.

If the user from which you are cloning has no authentication, then the new user has no authentication.

Interoperability configuration

The switch is compatible with RADIUS servers.

Unicast Reverse Path Forwarding (uRPF)

The Unicast Reverse Path Forwarding (uRPF) feature prevents packet forwarding for incoming unicast IP packets that have incorrect or forged (spoofed) IP addresses. The uRPF feature checks that the traffic received on an interface comes from a valid IP address, thereby preventing address spoofing. On a reverse path check, if the source IP address of the received packet at the interface is not reachable using the FIB, the system drops the packet as the packet may have originated from a misconfigured or a malicious source.

You can configure uRPF for each IP interface or VLAN. When uRPF is enabled on an interface, the switch checks all routing packets that come through that interface. It ensures that the source address and source interface appear in the routing table, and that it matches the interface, on which the packet was received.

You can use one of two modes for uRPF:

- **Strict mode:** In strict mode, uRPF checks whether the source IP address of the incoming packet exists in the FIB. If the incoming interface is not the best reverse path, the packet check fails and uRPF drops the packet. If the routing engine finds the source IP entry, uRPF further checks if the source IP interface matches the incoming interface of the packet. If they match, the system forwards the packet as usual, otherwise, the system discards the packet.

*** Note:**

The number of packets dropped due to uRPF check on the ingress interface gets incremented along with other general dropped statistics under the `IN-DISCARD` column in the output of the command `show interfaces gigabitEthernet error <collision|verbose> {slot/port[-slot/port][, ...]}`.

- **Loose mode:** In loose mode, uRPF checks whether the source IP address of the incoming packet exists in the FIB. The packet is dropped only if the source address is not reachable via any interface on that router.

uRPF can be enabled independently for IPv4 and IPv6. However, on a given interface, if uRPF is enabled for both IPv4 and IPv6, the `urpf-mode` can be either `strict-mode` or `loose-mode` for both IPv4 and IPv6. That means we cannot have IPv4 `urpf-mode` configured differently than that of IPv6.

*** Note:**

uRPF check cannot detect spoofed source IP address if the source IP address belongs to a known subnet.

Digital Certificate/PKI

This section provides information on the digital certificate framework and offline certificate management.

A digital certificate is an electronic document that identifies subject, proves the ownership of public key, and is digitally signed by a certification authority (CA) that certifies the validity of the information in the certificate. A digital certificate is valid for only a specific period of time.

Public Key Infrastructure (PKI) support assists the switches to obtain and use digital certificates for secure communication in the network.

To be certified, a switch performs the following tasks:

- Generate certificate signing request
- Verify that a present certificate has not been revoked
- Validate the certificate
- Renew the certificate before it expires
- Remove the certificate if required

Subject

An administrator configures the subject parameters such as common name, organization name, organization unit, locality, state and country for requesting the identity certificate.

Challenge password

A password is required for Simple Certificate Enrollment Protocol (SCEP) operations like the enrollment and renewal of identity certificate. This password is given offline by the CA during end entity registration. The administrator provides this password during enroll and renew operations.

UsePost

There are different types of CAs like EJBCA, Win2012, and others. The usePost parameter allows you to choose the style of HTTP request. The value for usePost parameter can be set True or False.

For example, if Win2012 SCEP does not support POST mode of HTTP request, set the usePost as False for Win2012 and set usePost as True for EJBCA.

Root CA certificate

The Root CA certificate obtained offline from CA must be installed for SCEP operations. This Root CA certificate is transferred to the device during the installation. The system does not allow any SCEP operations if the offline Root CA certificate is not installed and error messages are logged.

Key generation

The supported key type is RSA with RSA key of size 2048. At a time, there is only one active key-pair associated with trustpoint CA and digital certificate. The system does not allow generating a new key-pair if there is a key-pair already associated with the active digital certificate. The system logs the error message if such new key generation is attempted. In such case the certificate must be revoked first before a new key-pair is generated.

TrustPoint CA setup

Trustpoints let us manage and track CAs and certificates. A trustpoint is a representation of a CA or identity pair. A trustpoint contains the identity of the CA, CA-specific configuration parameters, and an association with one generated key. The switch can enroll with a trust point to obtain an identity certificate. Trustpoint is set up once RSA key pair is generated and the CA identity and other configuration parameters are available. The CA name to configure a trustpoint should be unique.

Certificate enrollment

Certificate enrolment involves generating certificate signing request (CSR). Before certificate enrolment, trustpoint CA must be configured and the user configuration parameters should be available. The key usage extension parameter is required as an input. It indicates the purpose of the key contained in the certificate, that the key can be used for encipherment, digital signature, certificate signing and so on.

The certificate enrollment is not allowed if there is an active certificate already available. If new certificate enrollment is required, the existing active certificate must be revoked first. The system logs the enrollment success or failure responses.

Certificate renewal

The certificate renewal must be done by the administrator before it expires. A trap is set for a pre-defined period before expiry date of the certificate and the certificate renewal due warning message is logged by the system. The system does not allow certificate renewal request if an active

certificate is not available. The system replaces the existing certificate with the newly obtained certificate on successful renewal. The system logs the renewal success or failure responses.

Certificate revocation or removal

The certificate can be revoked or withdrawn from the specific device for a specific reason at any point of time. The system does not allow certificate revocation request if an active certificate is not available. The system releases the existing certificate on successful revocation. The system logs the revocation success or failure responses.

During boot up, the system checks whether an active installed certificate is available. If a valid certificate is not available the system logs the warning message.

Offline certificate management

Offline certificate management supports the switches that cannot communicate with the Certificate Authority to obtain the identity certificate online by certificate enrollment operation.

Configure the subject and RSA key-pair to obtain the offline identity certificate. The configured subject parameters and RSA key are used to generate the Certificate Signing Request (CSR). This CSR is used to obtain the offline identity certificate.

The Root CA certificate and all the intermediate CA certificates of certificate chain must be installed in the device before installing the offline identity or device certificate. All the intermediate and Root CA certificates are stored in certificate store and are used for CA certificate chain validation. The CA certificate chain validation is performed starting from the issuing CA certificate till the Root CA certificate during the install operation of offline identity certificate. The offline identity certificate is installed only if the CA certificate chain validation, subject and key match.

Storage

The system stores all of the configurations of the digital certificate module in `/intflash/.cert` in a file named `cert.info.cfg`. After a reboot, the system loads the configurations directly from this file. As a result, no digital certificate configuration is visible if you use the `show running-config` command. Instead use the commands appropriate for displaying digital certificate information. For more information, see [Viewing the certificate details](#) on page 50.

Certificate order priority

Use the following information to understand the certificate order priority when the TLS server and switch connect.

The TLS server selects the server certificate in the following order:

1. A CA-signed certificate if the certificate is already present in the `/intflash/.cert/` folder on the switch.
2. A self-signed certificate if the certificate is already present in the `/intflash/.cert/` folder on the switch.

If the server certificates are not available, TLS server generates a new self-signed certificate on boot and uses that by default. The self-signed certificate is available in `./intflash/.cert/.ssl`. You can choose to use an online or offline CA signed certificate which will take precedence over the self-signed one.

SSL-based self-signed certificate

Some earlier releases use the default certificate available in the `/intflash/.ssh` folder, which is the open SSL-based self-signed certificate that is named `host.cert`.

To use the Mocana stack based self-signed certificate, delete the open SSL self-signed certificate prior to upgrading your software release. The Mocana certificate offers better and stronger encryption.

If a user does not delete the `host.cert` file in the `/intflash/.ssh` folder used in earlier releases, forcefully generates a self-signed certificate automatically during upgrade or post upgrade using the command `config ssl certificate`.

If you have a subscribed CA-signed certificate renamed as `host.cert` in folder `/intflash/.ssh` in the previous release, it cannot be reused now.

To use your subscribed CA-signed certificate, upgrade with the Mocana-based self-signed certificate, and then use the digital certificates feature to install a CA-signed certificate through the online or offline method.

You cannot obtain a CA-signed certificate and rename the certificate as `host.cert`. You must use the online or offline method to obtain certificate.

Security configuration using CLI

Configure security information used on the control and data paths to protect the network from uncontrolled access to network resources.

For more information about how to configure passwords and access policies, see *Administering*.

Enabling hsecure

The `hsecure` flag is disabled by default. When you enable it, the software enforces the 10 character rule for all passwords.

About this task

When you upgrade from a previous release, if the password does not have at least 10 characters, you receive a prompt to change your password to the mandatory 10-character length.

If you enable `hsecure` for the first time and the password file does not exist, then the device creates a normal default username (`rwa`) and password (`rwa`). In this case, the password does not meet the minimum requirements for `hsecure` and as a result the system prompts you to change the password.

Procedure

1. Enter Global Configuration mode:

```
enable
configure terminal
```

2. Enable or disable hsecure mode:

```
boot config flags hsecure
```

The following warning messages appear:

```
Warning: For security purposes, all unsecure services - TFTP, FTP, Rlogin, Telnet,
SNMP are disabled. Individually enable the required services.
Warning: Please save boot configuration and reboot the switch for this to take
effect.
```

3. Save the configuration and restart the device for the change to take effect.

Example

```
Switch:1> enable
```

```
Switch:1# configure terminal
```

Enable hsecure mode:

```
Switch:1(config)# boot config flags hsecure
```

```
Warning: For security purposes, all unsecure services - TFTP, FTP,
Rlogin, Telnet, SNMP are disabled. Individually enable the required
services. Warning: Please save boot configuration and reboot the switch
for this to take effect.
```

Save the configuration:

```
Switch:1(config)# save config
```

Restart the switch:

```
Switch:1(config)# reset
```

```
Are you sure you want to reset the switch (y/n)? y
```

Changing an invalid-length password

Before you begin

Important:

When you enable hsecure, passwords must contain a minimum of 10 characters or numbers with a maximum of 20. The password must contain a minimum of: two uppercase characters, two lowercase characters, two numbers, and two special characters.

About this task

After you enable **hsecure** and restart the system, change your password if you have an invalid-length password.

Procedure

1. At the CLI prompt, log on to the system.
2. Enter the password.

When you have an invalid-length password, the following message appears:

```
Your password is valid but less than mandatory 10 characters.  
Please change the password to continue.
```

3. When prompted, enter the new password.
4. When prompted, reenter the new password.

Example

Log on to the switch:

```
Login: rwa
```

Enter the password:

```
Password: ***
```

```
Your password is valid but less than mandatory 10 characters. Please  
chnage the password to continue.
```

Enter the new password:

```
Enter the new password: *****
```

Re-enter the new password:

```
Re-enter the new password: *****
```

```
Password successfully changed.
```

Changing passwords

Configure new passwords for each access level, or change the logon or password for the different access levels of the switch. After you receive the switch, use default passwords to initially access CLI. If you use Simple Network Management Protocol version 3 (SNMPv3), you can change encrypted passwords.

Before you begin

- You must use an account with read-write-all privileges to change passwords. For security, the switch saves passwords to a hidden file.

About this task

If you enable the `hsecure` flag, after the aging time expires, the system prompts you to change your password. If you do not configure the aging time, the default is 90 days.

Procedure

1. Enter Global Configuration mode:

```
enable
```

```
configure terminal
```

2. Change a password:

```
cli password WORD<1-20> {layer1|layer2|layer3|read-only|read-write|
read-write-all}
```

3. Enter the old password.
4. Enter the new password.
5. Enter the new password a second time.
6. Configure password options:

```
password access-level WORD<2-8>
password aging-time day <1-365>
password default-lockout-time <60-65000>
password lockout WORD<0-46> [time <60-65000>]
password min-passwd-len <10-20>
password password-history <3-32>
```

Example

```
Switch:1>enable
```

```
Switch:1#configure terminal
```

Change a password:

```
Switch:1(config)#password smith read-write-all
```

Enter the old password:

```
Switch:1(config)#*****
```

Enter the new password:

```
Switch:1(config)#*****
```

Enter the new password a second time:

```
Switch:1(config)#*****
```

Set password to an access level of read-write-all and the expiration period for the password to 60 days:

```
Switch:1(config)#access-level rwa aging-time 60
```

Variable definitions

Use the data in the following table to use the `cli password` command.

Table 2: Variable definitions

Variable	Value
layer1 layer2 layer3 read-only read-write read-write-all	Changes the password for the specific access level.
WORD<1-20>	Specifies the user logon name.

Use the data in the following table to use the `password` command.

Table 3: Variable definitions

Variable	Value
access level WORD<2–8>	Permits or blocks this access level. The available access level values are as follows: <ul style="list-style-type: none"> • l1 • l2 • l3 • ro • rw • rwa
aging-time day <1-365>	Configures the expiration period for passwords in days, from 1–365. The default is 90 days.
default-lockout-time <60-65000>	Changes the default lockout time after three invalid attempts. Configures the lockout time, in seconds, and is in the 60–65000 range. The default is 60 seconds. To configure this option to the default value, use the default operator with the command.
lockout WORD<0–46> time <60-65000>	Configures the host lockout time. <ul style="list-style-type: none"> • WORD<0–46> is the host IP address in the format a.b.c.d. • <60-65000> is the lockout-out time, in seconds, in the 60–65000 range. The default is 60 seconds.
min-passwd-len <10-20>	Configures the minimum length for passwords in high-secure mode. The default is 10 characters. To configure this option to the default value, use the default operator with the command.
password-history <3-32>	Specifies the number of previous passwords the switch stores. You cannot reuse a password that is stored in the password history. The default is 3. To configure this option to the default value, use the default operator with the command.

Configuring directed broadcast

A directed broadcast is a frame sent to the subnet broadcast address on a remote IP subnet. When you disable (or suppress) directed broadcasts on an interface, all frames sent to the subnet broadcast address for a local router interface are dropped. Disabling directed broadcasts protects

hosts from possible denial-of-service (DOS) attacks. By default, this feature is enabled on the device.

Procedure

1. Enter VLAN Interface Configuration mode:

```
enable
configure terminal
interface vlan <1-4059>
```

2. Configure the switch to forward directed broadcasts for a VLAN:

```
ip directed-broadcast enable
```

Example

```
Switch:1>enable
Switch:1#configure terminal
Switch:1(config)#interface vlan 2
Switch:1(config-if)#ip directed-broadcast enable
```

Variable definitions

Use the data in the following table to use the `ip directed-broadcast` command.

Table 4: Variable definitions

Variable	Value
enable	Enables the device to forward directed broadcast frames to the specified VLAN. The default setting for this feature is enabled.

Preventing certain types of DOS attacks

Protect the switch against IP packets with illegal IP addresses such as loopback addresses or a source IP address of ones, or Class D or Class E addresses from being routed. The switch supports high-secure configurable flag.

About this task

Important:

After you enable this flag, the desired behavior (not routing source packets with an IP address of 255.255.255.255) applies to all ports that belong to the same port.

Important:

The setting to enable hsecure only takes effect for packets going to the CP; not to datapath traffic.

Procedure

1. Enter GigabitEthernet Interface Configuration mode:

```
enable

configure terminal

interface GigabitEthernet {slot/port[/sub-port] [-slot/port[/sub-
port]] [,...]}
```

*** Note:**

If your platform supports channelization and the port is channelized, you must also specify the sub-port in the format slot/port/sub-port.

2. Enable high-secure mode:

```
high-secure [port {slot/port[/sub-port] [-slot/port[/sub-port]]
[,...]] enable
```

Example

```
Switch:1> enable

Switch:1# configure terminal

Switch:1(config)# interface GigabitEthernet 1/16

Switch:1(config-if)# high-secure enable
```

Variable definitions

Use the data in the following table to use the **high-secure** command.

Variable	Value
<code>port {slot/port[/sub-port] [-slot/port[/sub-port]] [,...]}</code>	Specifies the port on which you want to enable high-secure mode. Identifies the slot and port in one of the following formats: a single slot and port (slot/port), a range of slots and ports (slot/port-slot/port), or a series of slots and ports (slot/port,slot/port,slot/port). If your platform supports channelization and the port is channelized, you must also specify the sub-port in the format slot/port/sub-port.
<code>enable</code>	Enables the high-secure feature that blocks packets with illegal IP addresses. This flag is disabled by default. Use the no operator to remove this configuration. To configure this option to the default value, use the default operator with the command.

Configuring port lock

Configure port lock to administratively lock a port or ports to prevent other users from changing port parameters or modifying port action. You cannot modify a locked port until you unlock the port.

Procedure

1. Enter Global Configuration mode:

```
enable
configure terminal
```

2. Enable port lock globally:

```
portlock enable
```

3. Enter GigabitEthernet Interface Configuration mode:

```
interface gigabitethernet {slot/port[/sub-port] [-slot/port[/sub-
port]] [,...]}
```

4. Lock a port:

```
lock [port {slot/port[/sub-port] [-slot/port[/sub-port]] [,...]]
enable
```

Example

```
Switch:1> enable
```

```
Switch:1# configure terminal
```

Log on to GigabitEthernet Interface Configuration mode:

```
Switch:1(config)# interface GigabitEthernet 1/1
```

Lock port 1/1:

```
Switch:1(config-if)# lock port 1/1 enable
```

Unlock port 1/1:

```
Switch:1(config-if)# no lock port 1/1 enable
```

Variable definitions

Use the data in the following table to use the **interface gigabitethernet** command.

Variable	Value
<i>{slot/port[/sub-port] [-slot/port[/sub-port]] [,...]}</i>	Identifies the slot and port in one of the following formats: a single slot and port (slot/port), a range of slots and ports (slot/port-slot/port), or a series of slots and ports (slot/port,slot/port,slot/port). If your platform supports channelization and the port is channelized, you must also specify the sub-port in the format slot/port/sub-port.

Use the data in the following table to use the **lock port** command.

Variable	Value
<i>{slot/port[/sub-port] [-slot/port[/sub-port]] [,...]}</i>	Specifies the port you want to lock.

Variable	Value
	<p>Identifies the slot and port in one of the following formats: a single slot and port (slot/port), a range of slots and ports (slot/port-slot/port), or a series of slots and ports (slot/port,slot/port,slot/port). If your platform supports channelization and the port is channelized, you must also specify the sub-port in the format slot/port/sub-port.</p> <p>The default is disabled.</p>

Unicast Reverse Path Forwarding configuration using CLI

This section provides CLI procedures for Unicast Reverse Path Forwarding configuration.

Enabling urpf-mode boot flag

To configure Unicast Reverse Path Forwarding on a port or VLAN, you are required to enable the urpf-mode boot flag. If you try to configure uRPF on an interface, that is, enable or change the urpf operating mode with the urpf-mode boot flag disabled, a consistency check error message is displayed: `Unicast Reverse Path Forwarding configuration is not supported when urpf-mode boot flag is disabled.`

About this task

Use the following procedure to enable the urpf-mode boot flag. By default, urpf-mode is disabled.

Procedure

1. Enter Global Configuration mode:

```
enable
configure terminal
```

2. Enable the urpf-mode boot flag:

```
boot config flags urpf-mode
```

3. When you get the following prompt to reboot the switch, enter `y` to reboot.

```
The new setting requires a reboot to take effect!
The configuration will be saved and rebooted.
Are you sure you want to re-boot the switch (y/n)?
```

Note:

If you enter `n`, the following message is displayed: `Warning: Please save the configuration and reboot the switch for this configuration to take effect.`

4. Check the status of the urpf-mode boot flag:

```
show boot config flags
```

Example

Enable the urpf-mode boot flag:

```
Switch:1> enable
Switch:1# configure terminal
Switch:1(config)# boot config flags urpf-mode
The new setting requires a reboot to take effect!
The configuration will be saved and rebooted.
Are you sure you want to re-boot the switch (y/n)? y
```

View the status of the urpf-boot flag:

```
Switch:1>enable
Switch:1#show boot config flags
flags block-snmp false
flags debug-config file
flags debugmode false
flags dvr-leaf-mode false
flags enhancedsecure-mode false
flags factorydefaults false
flags flow-control-mode false
flags ftpd true
flags ha-cpu true
flags hsecure false
flags linerate-directed-broadcast false
flags ipv6-mode false
flags logging true
flags nni-mstp false
flags reboot true
flags rlogind false
flags savetostandby true
flags spanning-tree-mode mstp
flags spbm-config-mode false
flags sshd true
flags syslog-rfc5424-format true
flags telnetd true
flags tftpd true
flags trace-logging false
flags urpf-mode false
flags verify-config true
flags vrf-scaling false
flags vxlan-gw-full-interworking-mode false
```

* Note:

The following **boot config flags** are not supported on all hardware models:

- ha-cpu flag
- ipv6-mode flag
- linerate-directed-broadcast
- savetostandby flag
- vxlan-gw-full-interworking-mode flag

Configuring unicast reverse path forwarding on a port

About this task

You can use the Unicast Reverse Path Forwarding (uRPF) feature to reduce the problems that are caused by the introduction of malformed or forged (spoofed) IP source addresses into a network. When you enable uRPF, the switch performs a check to determine if the source IP address of the packet is verifiable. If the address is not verifiable, the system drops the packet.

uRPF runs in two modes:

- strict mode
- loose mode (exist-only mode)

Before you begin

- You must enable the urpf-mode boot flag. See [Enabling urpf-mode boot flag](#) on page 36.

* Note:

When you try to configure uRPF on an interface, that is, enable or change the urpf operating mode with the urpf-mode boot flag disabled, a consistency check error message is displayed: Unicast Reverse Path Forwarding configuration is not supported when urpf-mode boot flag is disabled.

- You must log on to the GigabitEthernet Interface Configuration mode in CLI.

Procedure

1. Enter GigabitEthernet Interface Configuration mode:

```
enable

configure terminal

interface GigabitEthernet {slot/port[/sub-port] [-slot/port[/sub-
port]][,...]}
```

* Note:

If your platform supports channelization and the port is channelized, you must also specify the sub-port in the format slot/port/sub-port.

2. Set or change the urpf operating mode on a port:

For IPv4, enter: `ip rvs-path-chk mode {strict|exist-only}`

For IPv6, enter: `ipv6 rvs-path-chk mode {strict|exist-only}`

* Note:

3. Verify the configuration on the port:

For IPv4, enter: `show ip interface gigabitethernet`

For IPv6, enter: `show ipv6 interface gigabitethernet`

Example

Example for IPv4:

```
Switch:1> enable
Switch:1# configure terminal
Switch:1(config)# interface GigabitEthernet 1/10
```

Check whether the source IP address of the incoming packet exists in the FIB table:

```
Switch:1(config-if)# ip rvs-path-chk mode strict
```

Verify the configuration on the port:

```
Switch:1(config-if)# show ip interface gigabitethernet
```

```
=====
                        Router Port Ip
=====
```

PORT NUM	VRF NAME	IP_ADDRESS	NET_MASK	BROADCAST	REASM MAXSIZE	ADVERTISE WHEN_DOWN	DIRECT BCAST	RPC	RPCMODE
1/1	Glob~	192.0.2.1	255.255.255.0	ones	1500	disable	disable	disable	exist-only
1/10	spbo~	198.51.100.1	255.255.255.0	ones	1500	disable	disable	disable	exist-only

```
=====
```

PORT NUM	VRF NAME
1/1	GlobalRouter
1/10	spboip

```
=====
```

Example for IPv6:

```
Switch:1> enable
Switch:1# configure terminal
Switch:1(config)# interface GigabitEthernet 4/16
```

Check whether the source IP address of the incoming packet exists in the FIB table:

```
Switch:1(config-if)# ipv6 rvs-path-chk mode strict
```

Verify the configuration on the port:

```
Switch:1(config-if)#show ipv6 interface gigabitethernet
```

```
=====
                        Port Ipv6 Interface
=====
```

IFINDX INDX	BROUTER	PHYSICAL ADDRESS	ADMIN STATE	OPER STATE	TYPE	MTU	HOP LMT	REACHABLE TIME	RETRANSMIT TIME	MCAST STATUS	IPSEC	RPC	RPCMODE
192	4/16	e4:5d:52:3c:65:02	enable	down	ETHER	1500	2	30000	1000	disable	disable	disable	existonly

```
=====
```

Port Ipv6 Address				
IPV6 ADDRESS	BROUTER	TYPE	ORIGIN	STATUS
2001:DB8:0:0:0:0:0:ffff/64	4/16	UNICAST	MANUAL	INACCESSIBLE INF
2001:DB8:0:0:e65d:52ff:fe3c:6502/64	4/16	UNICAST	LINKLAYER	INACCESSIBLE INF

```
=====
```

1 out of 5 Total Num of Interface Entries displayed.
2 out of 10 Total Num of Address Entries displayed.

Variable definitions

Use the data in the following table to use the ip rvs-path-chk mode and ipv6 rvs-path-chk mode commands.

Variable	Value
mode{strict exist-only}	Specifies the mode for Unicast Reverse Path Forwarding (uRPF). In strict mode, uRPF checks whether the source IP address of the incoming

Variable	Value
	packet exists in the FIB. If the incoming interface is not the best reverse path, the packet check fails and uRPF drops the packet. In exist-only mode, uRPF checks whether the source IP address of the incoming packet exists in the FIB. The packet is dropped only if the source address is not reachable via any interface on that router.

Configuring unicast reverse path forwarding on a VLAN

About this task

Use the Unicast Reverse Path Forwarding (uRPF) feature to reduce the problems that are caused by the introduction of malformed or forged (spoofed) IP source addresses into a network. When you enable uRPF, the switch performs a check to determine if the source IP address of the packet is verifiable. If the address is not verifiable, the system drops the packet.

uRPF runs in two modes:

- strict mode
- loose mode (exist-only mode)

Before you begin

- You must enable the `urpf-mode boot` flag.

Note:

When you try to configure uRPF on an interface, that is, enable or change the `urpf` operating mode with the `urpf-mode boot` flag disabled, a consistency check error message is displayed: `Unicast Reverse Path Forwarding configuration is not supported when urpf-mode boot flag is disabled.`

- You must log on to the VLAN Interface Configuration mode in CLI.

Important:

You must assign a valid IP address to the selected port.

Procedure

1. Enter VLAN Interface Configuration mode:

```
enable
configure terminal
interface vlan <1-4059>
```

2. Set or change the `urpf` operating mode on a VLAN:

For IPv4, enter: `ip rvs-path-chk mode {strict|exist-only}`

For IPv6, enter: `ipv6 rvs-path-chk mode {strict|exist-only}`

3. Verify the configuration on the VLAN:

For IPv4, enter: `show interfaces vlan ip`

For IPv6, enter: show ipv6 interface vlan

Example

Example for IPv4:

```
Switch:1> enable
Switch:1# configure terminal
Switch:1(config)# interface vlan 2
```

Check whether the source IP address of the incoming packet exists in the FIB table:

```
Switch:1(config-if)# ip rvs-path-chk mode exist-only
```

Verify the configuration on the VLAN:

```
Switch:1(config-if)# show interfaces vlan ip
```

```
=====
Vlan Ip
=====
VLAN VRF IP NET BCASTADDR REASM ADVERTISE DIRECTED RPC RPCMODE RMON
ID NAME ADDRESS MASK FORMAT MAXSIZE WHEN_DOWN BROADCAST
-----
1050 Globa~ 192.0.2.9 255.255.255.0 ones 1500 disable disable disable exist-only disable
1102 Globa~ 198.51.100.1 255.255.255.0 ones 1500 disable disable disable exist-only disable
1133 iir3 192.0.2.10 255.255.255.0 ones 1500 disable disable disable exist-only disable
1500 spboip 192.0.2.11 255.255.255.0 ones 1500 disable disable disable exist-only disable
1590 spboip 198.51.100.2 255.255.255.0 ones 1500 disable disable disable exist-only disable
4057 Globa~ 192.0.2.12 255.255.255.0 ones 1500 disable disable disable exist-only disable
=====
```

All 16 out of 16 Total Num of Vlan Ip Entries displayed

```
VLAN VRF
ID NAME
-----
1050 GlobalRouter
1102 GlobalRouter
1133 iir3
1500 spboip
1590 spboip
4057 GlobalRouter
```

All 16 out of 16 Total Num of Vlan Ip Entries displayed

Example for IPv6:

```
Switch:1> enable
Switch:1# configure terminal
Switch:1(config)# interface vlan 2
```

Check whether the source IP address of the incoming packet exists in the FIB table:

```
Switch:1(config-if)# ipv6 rvs-path-chk mode exist-only
```

Verify the configuration on the VLAN:

```
Switch:1(config-if)# show ipv6 interface vlan
```

```
=====
Vlan Ipv6 Interface
=====
IFINDEX VLAN PHYSICAL ADMIN OPER TYPE MTU HOP REACHABLE RETRANSMIT MCAST IPSEC RPC RPCMODE
INDX ADDRESS STATE STATE LMT TIME TIME STATUS STATUS
-----
3170 1122 2c:f4:c5:dc:b4:89 enable up ETHER 1500 64 30000 1000 disable disable disable existonly
3174 1126 2c:f4:c5:dc:b4:8b enable up ETHER 1500 64 30000 1000 disable disable disable existonly
3185 1137 2c:f4:c5:dc:b4:90 enable up ETHER 1500 64 30000 1000 disable disable disable existonly
=====
```

```
=====
Vlan Ipv6 Address
=====
IPV6 ADDRESS VLAN-ID TYPE ORIGIN STATUS
-----
2001:db8:0:0:0:0:0:1 V-1122 UNICAST MANUAL PREFERRED
2001:db8:0:0:2ef4:c5ff:fedc:b489 V-1122 UNICAST LINKLAYER PREFERRED
2001:db8:0:0:0:0:0:1 V-1126 UNICAST MANUAL PREFERRED
2001:db8:0:0:2ef4:c5ff:fedc:b48b V-1126 UNICAST LINKLAYER PREFERRED
2001:db8:0:0:0:0:0:1 V-1137 UNICAST MANUAL PREFERRED
2001:db8:0:0:2ef4:c5ff:fedc:b490 V-1137 UNICAST LINKLAYER PREFERRED
=====
```

3 out of 4 Total Num of Interface Entries displayed.
6 out of 7 Total Num of Address Entries displayed.

Variable definitions

Use the data in the following table to use the `ip rvs-path-chk mode` and `ipv6 rvs-path-chk mode` commands.

Variable	Value
<code>mode{strict exist-only}</code>	Specifies the mode for Unicast Reverse Path Forwarding (uRPF). In strict mode, uRPF checks whether the source IP address of the incoming packet exists in the FIB. If the incoming interface is not the best reverse path, the packet check fails and uRPF drops the packet. In exist-only mode, uRPF checks whether the source IP address of the incoming packet exists in the FIB. The packet is dropped only if the source address is not reachable via any interface on that router.

Viewing unicast reverse path forwarding configuration on a port

About this task

Use the following procedure to view the status of the uRPF configuration on a port.

Before you begin

- You must enable the `urpf-mode boot` flag.

*** Note:**

When you try to configure uRPF on an interface, that is, enable or change the `urpf` operating mode with the `urpf-mode boot` flag disabled, a consistency check error message is displayed: Unicast Reverse Path Forwarding configuration is not supported when `urpf-mode boot` flag is disabled.

- You must log on to the GigabitEthernet Interface Configuration mode in CLI.
- You must configure unicast reverse path forwarding on a port.

Procedure

- Enter GigabitEthernet Interface Configuration mode:

```
enable
configure terminal
interface GigabitEthernet {slot/port[/sub-port] [-slot/port[/sub-port]][,...]}
```

*** Note:**

If your platform supports channelization and the port is channelized, you must also specify the sub-port in the format `slot/port/sub-port`.

2. Verify the configuration on the port:

For IPv4, enter: `show ip interface gigabitethernet`

For IPv6, enter: `show ipv6 interface gigabitethernet`

Example

Example for IPv4:

```
Switch:1> enable
Switch:1# configure terminal
Switch:1(config)# interface GigabitEthernet 1/10
```

Verify the configuration on the port:

```
Switch:1(config-if)# show ip interface gigabitethernet
```

```
=====
                        Brouter Port Ip
=====
PORT VRF   IP_ADDRESS   NET_MASK   BROADCAST REASM   ADVERTISE DIRECT  RPC   RPCMODE
NUM  NAME                                     MAXSIZE  WHEN_DOWN BCAST
-----
1/1  Glob~ 192.0.2.3   255.255.255.0 ones     1500   disable  disable disable exist-only
1/10 spbo~ 198.51.100.4 255.255.255.0 ones     1500   disable  disable disable exist-only

PORT  VRF
NUM   NAME
-----
1/1   GlobalRouter
1/10  spboip
```

Example for IPv6:

```
Switch:1> enable
Switch:1# configure terminal
Switch:1(config)# interface GigabitEthernet 4/16
```

Verify the configuration on the port:

```
Switch:1(config-if)#show ipv6 interface gigabitethernet
```

```
=====
                        Port Ipv6 Interface
=====
IFINDX BRROUTER PHYSICAL ADDRESS      ADMIN OPER TYPE MTU HOP REACHABLE RETRANSMIT MCAST IPSEC  RPC  RPCMODE
INDX                                     STATE STATE          STATE STATE  LMT TIME  TIME  STATUS STATUS
-----
192     4/16     e4:5d:52:3c:65:02 enable  down  ETHER 1500 2   30000    1000      disable  disable  disable  existonly

                        Port Ipv6 Address
=====
IPV6 ADDRESS                                     BRROUTER  TYPE  ORIGIN  STATUS
-----
2001:db8:0:0:0:0:0:ffff/64                       4/16      UNICAST MANUAL  INACCESSIBLE INF  INF
2001:db8:0:0:0:e65d:52ff:fe3c:6502/64            4/16      UNICAST LINKLAYER INACCESSIBLE INF  INF

1 out of 5 Total Num of Interface Entries displayed.
2 out of 10 Total Num of Address Entries displayed.
```

Viewing unicast reverse path forwarding configuration on a VLAN

About this task

Use the following procedure to view the status of the uRPF configuration on a VLAN.

Before you begin

- You must enable the `urpf-mode boot` flag.

*** Note:**

When you try to configure uRPF on an interface, that is, enable or change the urpf operating mode with the urpf-mode boot flag disabled, a consistency check error message is displayed: Unicast Reverse Path Forwarding configuration is not supported when urpf-mode boot flag is disabled.

- You must log on to the VLAN Interface Configuration mode in CLI.

! Important:

You must assign a valid IP address to the selected port.

- You must configure unicast reverse path forwarding on a VLAN.

Procedure

1. Enter VLAN Interface Configuration mode:

```
enable
configure terminal
interface vlan <1-4059>
```

2. Verify the configuration on the VLAN:

For IPv4, enter: show interfaces vlan ip

For IPv6, enter: show ipv6 interface vlan

Example

Example for IPv4:

```
Switch:1> enable
Switch:1# configure terminal
Switch:1(config)# interface vlan 2
```

Verify the configuration on the VLAN:

```
Switch:1(config-if)# show interfaces vlan ip
```

```
=====
Vlan Ip
=====
VLAN VRF   IP      NET      BCASTADDR REASM  ADVERTISE DIRECTED  RPC   RPCMODE  RMON
ID   NAME   ADDRESS MASK      FORMAT    MAXSIZE WHEN_DOWN BROADCAST
-----
1050 Globa~ 192.0.2.9   255.255.255.0  ones    1500   disable  disable  disable exist-only  disable
1102 Globa~ 198.51.100.1 255.255.255.0  ones    1500   disable  disable  disable exist-only  disable
1133 iir3   192.0.2.10  255.255.255.0  ones    1500   disable  disable  disable exist-only  disable
1500 spboip 192.0.2.11  255.255.255.0  ones    1500   disable  disable  disable exist-only  disable
1590 spboip 198.51.100.2 255.255.255.0  ones    1500   disable  disable  disable exist-only  disable
4057 Globa~ 192.0.2.12  255.255.255.0  ones    1500   disable  disable  disable exist-only  disable
```

All 16 out of 16 Total Num of Vlan Ip Entries displayed

```
VLAN VRF
ID   NAME
-----
1050 GlobalRouter
1102 GlobalRouter
1133 iir3
1500 spboip
1590 spboip
4057 GlobalRouter
```

All 16 out of 16 Total Num of Vlan Ip Entries displayed

Example for IPv6:

```
Switch:1> enable
Switch:1# configure terminal
Switch:1(config)# interface vlan 2
```

Verify the configuration on the VLAN:

```
Switch:1(config-if)# show ipv6 interface vlan
```

```
=====
Vlan Ipv6 Interface
=====
IFINDX  VLAN  PHYSICAL          ADMIN  OPER  TYPE  MTU  HOP  REACHABLE  RETRANSMIT  MCAST  IPSEC  RPC  RPCMODE
INDX    ADDRESS  STATE    STATE  MTU  LMT  TIME    TIME    STATUS    IPSEC    RPC    RPCMODE
-----
3170   1122  2c:f4:c5:dc:b4:89  enable up    ETHER 1500 64  30000    1000    disable disable disable existonly
3174   1126  2c:f4:c5:dc:b4:8b  enable up    ETHER 1500 64  30000    1000    disable disable disable existonly
3185   1137  2c:f4:c5:dc:b4:90  enable up    ETHER 1500 64  30000    1000    disable disable disable existonly
=====
Vlan Ipv6 Address
=====
IPV6 ADDRESS          VLAN-ID  TYPE  ORIGIN  STATUS
-----
2001:db8:0:0:0:0:1    V-1122  UNICAST MANUAL  PREFERRED
2001:db8:0:0:2ef4:c5ff:fedc:b489  V-1122  UNICAST LINKLAYER PREFERRED
2001:db8:0:0:0:0:1    V-1126  UNICAST MANUAL  PREFERRED
2001:db8:0:0:2ef4:c5ff:fedc:b48b  V-1126  UNICAST LINKLAYER PREFERRED
2001:db8:0:0:0:0:1    V-1137  UNICAST MANUAL  PREFERRED
2001:db8:0:0:2ef4:c5ff:fedc:b490  V-1137  UNICAST LINKLAYER PREFERRED

3 out of 4 Total Num of Interface Entries displayed.
6 out of 7 Total Num of Address Entries displayed.
```

Digital certificate configuration using CLI

The following section provides procedures to configure digital certificates using CLI.

Configuring device subject parameters

About this task

Use this procedure to configure the device subject parameters to identify the device, such as the name, Email ID, company, department, and location.

Procedure

1. Enter Global Configuration mode:

```
enable
configure terminal
```

2. Configure the subject parameters of the device:

```
certificate subject {[common-name WORD<0-64>] [e-mail WORD<0-254>]
[unit WORD<0-64>] [organization WORD<0-64>] [locality WORD<0-128>]
[province WORD<0-128>] [country WORD<0-128>]}
```

3. **(Optional)** Delete a subject parameter:

```
no certificate subject {[common-name] [e-mail] [unit] [organization]
[locality] [province] [country]}
```

4. (Optional) Configure the default subject parameters of the device:

```
default certificate subject
```

Example

Configuring subject parameters:

```
Switch:1>enable
Switch:1#configure terminal
Switch:1(config)# certificate subject common-name Self e-mail example@company.com unit
Engineering organization Company locality SanFrancisco province California country US
```

Variable definitions

Use the data in the following table to use the **Certificate Subject** command.

Variable	Value
common-name WORD<0-64>	Specifies the name of the subject sending the Certificate Signing Request to the Certificate Authority.
e-mail WORD<0-254>	Specifies the Email address of the subject sending the Certificate Signing Request to the Certificate Authority.
unit WORD<0-64>	Specifies the organizational unit of the subject sending the Certificate Signing Request to the Certificate Authority.
organization WORD<0-64>	Specifies the organization of the subject sending the Certificate Signing Request to the Certificate Authority.
locality WORD<0-128>	Specifies the locality of the subject sending the Certificate Signing Request to the Certificate Authority.
province WORD<0-128>	Specifies the province of the subject sending the Certificate Signing Request to the Certificate Authority.
country WORD<0-128>	Specifies the country of the subject sending the Certificate Signing Request to the Certificate Authority.

Generating key pair

About this task

Use the following procedure to generate the private and public key pair for the specific cryptography type.

Procedure

1. Enter Global Configuration mode:

```
enable
configure terminal
```

2. Generate the key pair:

```
certificate generate-keypair {type rsa size 2048}
```

3. (Optional) Delete a key pair:

```
no certificate generate-keypair
```

4. (Optional) Generate default key pair:

```
default certificate generate-keypair
```

Example

Generating the key pair:

```
Switch:1>enable
Switch:1#configure terminal
Switch:1(config)#certificate generate-keypair type rsa size 2048
```

Variable definition

Use the data in the following table to use the certificate **generate-keypair** command.

Variable	Value
type rsa	Specifies type of cryptography algorithm used to generate the key-pair. The switch uses only rsa as the cryptography algorithm type.
size 2048	Specifies the size or modulus of key-pair to be generated. The value should be 2048.

Configuring a trustpoint CA

About this task

Use this procedure to configure the certificate authority and perform related actions. You can configure only one CA in a device at a time.

Procedure

1. Enter Global Configuration mode:

```
enable
configure terminal
```

2. Configure the trustpoint by getting CA specific configuration parameters and perform related actions:

```
certificate ca WORD<1-45> [common-name WORD<0-64>] [key-name WORD<0-45>] [ca-url WORD<0-1000>] [use-post <true|false>] [action <noop | caauth | {enroll [validity-days <7-1185>] | } | {renew [validity-days <7-1185>] | install | remove | get-crl}] [install-file {root-ca-filename WORD<1-80>}]
```

- a. Configure the trustpoint and associate it with the generated key pair:

```
certificate ca WORD<1-45> {[common-name WORD<0-64>] [key-name WORD<0-45>] [ca-url WORD<0-1000>] [use-post <true|false>]}
```

- b. Configure trustpoint and perform no other operation:

```
certificate ca WORD<1-45> action noop
```

- c. Configure trustpoint, authenticate the trustpoint CA by getting the certificate of the CA, and store the CA certificate locally:

```
certificate ca WORD<1-45> action caauth
```

- d. Generate certificate signing request to obtain identity certificate from configured trustpoint CA, get the digital certificate, and store it locally, associating with the trustpoint CA:

```
certificate ca WORD<1-45> {action enroll [validity-days <7-1185>]}
```

- e. Generate certificate renew request for given trustpoint CA, get the new digital certificate, and store it locally by replacing the old certificate with the new one:

```
certificate ca WORD<1-45> {action renew [validity-days <7-1185>]}
```

- f. Release the locally stored certificate associated with the trustpoint CA post revocation.

```
certificate ca WORD<1-45> action remove
```

- g. Install the subject certificate obtained from the given trustpoint CA:

```
certificate ca WORD<1-45> action install
```

- h. Get the Certificate Revocation List from the CDP and store into a file.

```
certificate ca WORD<1-45> action get-crl
```

3. Install the Root Certificate Authority's certificate obtained offline:

```
certificate ca WORD<1-45> install-file {root-ca-filename WORD<1-80>}
```

4. Set the HTTP request type to support the type of CA:

```
certificate ca WORD<1-45> use-post <false | true>
```

5. (Optional) Delete a trustpoint CA:

```
no certificate ca WORD<1-45> [[common-name] | [key-name] | [ca-url] | [use-post] | [action]]
```

6. (Optional) Configure default trustpoint CA:

```
default certificate ca WORD<1-45>
```

Example

```
Switch:1>enable
Switch:1#configure terminal
Switch:1(config)#certificate ca ej common-name subca5 key-name rsa_2048
Switch:1(config)#certificate ca ej action enroll
Switch:1(config)#CP1 [07/21/16 12:22:11.992:CEST] 0x003a8604 00000000 GlobalRouter
DIGITALCERT
INFO Digital Certificate Module : Configuration Saved
CP1 [07/21/16 12:22:12.284:CEST] 0x003a8639 00000000 GlobalRouter DIGITALCERT INFO Sent
SCEP
Request To CA : ej
CP1 [07/21/16 12:22:12.504:CEST] 0x003a8615 00000000 GlobalRouter DIGITALCERT INFO
Received SCEP
Response With SUCCESS status!
CP1 [07/21/16 12:22:12.508:CEST] 0x003a8611 00000000 GlobalRouter DIGITALCERT INFO
Enroll
Certificate Successful!
CP1 [07/21/16 12:22:12.509:CEST] 0x003a8604 00000000 GlobalRouter DIGITALCERT INFO
```

Digital
Certificate Module : Configuration Saved

Variable definition

Use the data in the following table to use the `certificate ca` command.

Variable	Value
ca WORD<1–45>	Specifies the name of the certification authority. It should be alphanumeric and case-sensitive. The maximum length should be 45 characters.
common-name WORD<0–64>	Specifies the name of the owner of the device or user.
key-name WORD<0–45>	Specifies the key pair generated by the command that was first associated with the CA trustpoint.
ca-url WORD<0–1000>	Specifies the trusted CA url.
use-post <false true>	Specify the HTTP request style. The default value is True. For example, True for EJBCA and False for Win2012 CA.
action noop	Specifies that no operation should be performed after configuring trustpoint.
action caauth	Authenticates the trustpoint CA by getting the certificate of the CA and stores the CA certificate locally.
action enroll [validity-days <7–1185>]	Generates certificate signing request to obtain identity certificate from configured trustpoint CA, gets the digital certificate, and stores it locally, associating with the trustpoint CA. The validity-days specifies the number of days for which the certificate will remain valid. The default value is 365 days.
action renew [validity-days <7–1185>]	Generates certificate renewal request for given trustpoint CA, gets the digital certificate, and stores it locally by replacing the old certificate with the new one. The validity-days specifies the number of days for which the certificate will remain valid. The default value is 365 days.
action renew [challenge-password WORD<0-128>]	This password is given offline by the CA during the end entity registration. The length of the password is from 0 to 128.
action install	Installs the subject certificate obtained from the given trustpoint CA.
action remove	Releases the locally stored certificate associated with the trustpoint CA post revocation.
action get-crl	Gets the Certificate Revocation List from the CDP and stores into a file.
install-file root-ca-filename WORD<1–80>	Installs the Root CA file obtained offline from the CA.

Installing the certificate

About this task

Use this procedure to install CA, Root CA, subject certificate, or CRL file obtained offline from the certification authority (CA).

Procedure

1. Enter Global Configuration mode:

```
enable
configure terminal
```

2. Install the certificate obtained from the CA:

```
certificate install-file {[offline-ca-filename WORD<1-80>] |
[offline-root-ca-filename WORD<1-80>] | [offline-subject-filename
WORD<1-80>] | [offline-crl-filename WORD<1-80>]}
```

3. **(Optional)** Uninstall the certificate obtained from the CA:

```
no certificate install-file {[offline-ca-filename WORD<1-80>] |
[offline-root-ca-filename WORD<1-80>] | [offline-subject-filename
WORD<1-80>] | [offline-crl-filename WORD<1-80>]}
```

Variable definition

Use the data in the following table to use the **certificate install-file** command.

Variable	Definition
offline-ca-filename WORD<1-80>	Specifies the CA file name obtained from the CA.
offline-root-ca-filename WORD<1-80>	Specifies the Root CA file name obtained from the CA.
offline-subject-filename WORD<1-80>	Specifies the subject certificate file name obtained from the CA.
offline-crl-filename WORD<1-80>	Specifies the CRL file obtained from the CA.

Generating certificate signing request

About this task

Use this procedure to generate certificate signing request (CSR) and store it into a file. This CSR is required to obtain the offline subject certificate.

Procedure

1. Enter Global Configuration mode:

```
enable
configure terminal
```

2. Generate certificate signing request:

```
certificate generate-csr
```

Viewing the certificate details

About this task

Use this procedure for the following tasks:

- Displaying the digital certificate for given certificate type or list all the certificate details from the local store for given certificate type.
- Displaying the CA details for a given trustpoint CA name or listing all the CA details from the local store if the CA name is not specified.
- Displaying the configured key details for given key name.
- Displaying the configured subject details.

Procedure

1. Enter Privileged EXEC mode:

```
enable
```

2. Display the digital certificate for given certificate type:

```
show certificate cert-type [online-ca-cert] | [online-subject-cert]
| [offline-ca-cert] | [offline-subject-cert] | [intermediate-ca-cert
WORD<1-80>] | [root-ca-cert WORD<1-80>]]
```

3. Display the certificate authority details:

```
show certificate ca WORD<1-45>
```

4. Display the name and public key of all the key-pairs:

```
show certificate key-name
```

5. Display the details of the configured subject:

```
show certificate subject
```

Example

Enter privileged exec mode:

```
Switch:1>en
```

Display the CA certificate details:

```
Switch:1(config)#show certificate ca
```

CA table entry

```
Name           : caica2
CommonName     : caica2
KeyName        : rsa_2048
CaUrl          : http://192.51.100.9:8080/ejbca/publicweb/apply/scep/test/
pkiclient.exe
UsePost        : 0
SubjectCertValidityDays : 365
Action         : no-op
LastActionStatus : success
LastActionFailureReason :
```

Display the name and public key of all the key-pairs:

```
Switch:1(config)#show certificate key-name
```

```
Key Name: rsa_2048
```

```
Public Key Value:
```

```
00000000000000010000000102000000000301000100000100bcb8339f794b7ce8a90a7f3a238f07e176a48337
```

```
512173153ba5f6a2b33700db07957c4a1a7e6adb918ed046c2235e074fff4fcf15aa2e66c670ad14cee5d88a90
23d666798943d58ab793578438291532a700037d9b5cf97ce1321c63e16462bbb7c0f8fafale386d651caf6b6a
8b4e707d1f7c247900d21f711acf1eba9e293aff7de0dbc30b9733d26179827676044ea04b77412142dc6cd8fe
9fc4ebc5173a6d7c82cbf52090046efec0efb0356282208c94b5b954c9fca38d3e39e0778474cb423a1c8d9feb
4e64a1600a43d7d7b1db48dfa7b536772855b081c8d63aec3f94832fa558565b8e9b1f1b67121aa7d4a381
ff2c3dde78d65c271b83a9
```

Display the details of the configured subject:

```
Switch:1(config)#show certificate subject
Common Name      : tsenduser1
Email Address    : tsenduser1@mocana.com
Organizational Unit : Engineering
Organization     : Mocana
Locality        : San Francisco
Province       : California
Country        : US
```

Display the Root CA certificate:

```
Switch:1(config)#show certificate cert-type root-ca-cert

CERT STORE table entry
Certificate Type      : Root CA Certificate
CommonName           : ca
VersionNumber        : X.509 v3
SerialNumber         : 3f418444a5b29cbd
IssuerName           : CN:ca, EM:, OU:, O:, L:, P:, C:
ValidityPeriodNotBefore : 10/26/16 12:37:22
ValidityPeriodNotAfter  : 10/26/18 12:37:22
CertificateSignatureAlgorithm : sha256withRSAEncryption
CertificateSignature   :
856f7e66celbcbc3853dc22f969aff9bbb357d8d4e34274098e7c3c0b78cf0aba04b6d64ec22b4bee122243342
283348fb011edd25b44bf7b77d6cfb10eb662d97fafe6ce727622dfc205358513ceaef2a04bcd46b1372092ae
34c222a69237388f62c1efd8d0386102a69aa495a3070994620f2896c157c273185e8b6cc405083973b38418d7
efd9c992905df6e160c4bf3b916ec046c5291f9b2f280a178d5ac14ca6ee4ffc47059e522bbdafcc5560c55612
fbe3f6bcc603cec1ba0f24202ef6120c0f31259f6b5a80726ddf7f8b72359eac638b4a6289096db0cdc23839d
75ebe79dd3b5b7a365d1534a48f349dd3139d1e05e225711f07631ef5a2fbc
Subject              : CN:ca, EM:, OU:, O:, L:, P:, C:
SubjectPublicKeyAlgorithm : rsaEncryption
SubjectPublicKey     :
0000000000000000100000000000301000100000100a0457dd22f1ff11a2c4f01f5fedcda5b26d88a16
7f056b2c915e690b3a2c1e30373a8e14e5f23586aaa9e68544bf8b5931f0dff6057936c3e8f48d2430ce9bdf2c
00d30da314f4d3a88d7e112593429005b7095f8e4aec18fda5d1697d35882eab98796ae0fe20994edc5a5b1379
521a65d9e168e6bfe6d842139a294c94aac122e51d7a5438ad8bf00f5098857a557a4f69f4b21bd08c9213d345
8a7fb7c644c7fcb4806fb4f683941f7701cb131ffc2444aac314be88fb717c135bc7416390de4925d833e88936
2caefbaf1079656206acc5cfe424edc30e2cd7853223c505e3fef28cc35c94c14742a912baee7f4197f680a91
b69d496ea67b87cbd0c399
HasBasicConstraint   : 1
HasKeyUsage          : 1
IsCa                 : 1
KeyUsage             : 103 digitalSignature nonRepudiation
keyEncipherment keyCertSign cRLSign
ExtendedKeyUsage     : TLS Web Server Authentication, OCSP Signing,
CDPUrl              :
OCSPUrl             : http://192.51.100.9:8080/ejbca/publicweb/status/ocsp
CertificateFileName   : /intflash/.cert/.rootCACertStore/root_ca_cert_ca.der
```

Display the Intermediate CA certificate:

```
Switch:1(config)# show certificate cert-type intermediate-ca-cert

CERT STORE table entry
Certificate Type      : Intermediate CA Certificate
CommonName           : newsubca
VersionNumber        : X.509 v3
```

```

SerialNumber          : 59f0b1a73c93b194
IssuerName            : CN:ca, EM:, OU:, O:, L:, P:, C:
ValidityPeriodNotBefore : 10/27/16 09:49:59
ValidityPeriodNotAfter  : 10/26/18 12:37:22
CertificateSignatureAlgorithm : sha256withRSAEncryption
CertificateSignature    :
65c2bed6f0333d6bbc5aea24d682061cfebefeb4bea8f74b3687cb72d700aabcf38af039dbff1e3d818627c5a2
7bfb4310c5fdd8db7eaea7bfb06275bc86f1e479ed0ca5ec7a828b44f862e294ea4bd39a3a38b2ec5c87f2fb5b
af98a856f380d9ec9f022ba5b05c328556233b7dc5d1359edc08966a194311eb76965ce509439a224c5c000468
8cfd154a855a80fd385538e00f5644792f9e496def7e293b2a20a60c782cc9bfcddc448e15024a0a49caa2bbe
fc82fa71cbda495915910a4363e5d7d95303d44a14e95932b1797ecc252e7ffa4d7cb8d270c693cebbf3e632f1
accbe6920460496d1f873d35b92c5430cb870d84d61d0556eea94a003e6785
Subject               : CN:newsubca, EM:, OU:, O:, L:, P:, C:
SubjectPublicKeyAlgorithm : rsaEncryption
SubjectPublicKey      :
00000000000000010000000102000000000301000100000100a0457dd22f1ff11a2c4f01f5fedcda5b26d88a16
7f056b2c915e690b3a2c1e30373a8e14e5f23586aaa9e68544bf8b5931f0dff6057936c3e8f48d2430ce9bdf2c
00d30da314f4d3a88d7e112593429005b7095f8e4aec18fda5d1697d35882eab98796ae0fe20994edc5a5b1379
521a65d9e168e6bfe6d842139a294c94aac122e51d7a5438ad8bf00f5098857a557a4f69f4b21bd08c9213d345
8a7fb7c644c7fcb4806fb4f683941f7701cb131ffc244aac314be88fb717c135bc7416390de4925d833e88936
2caefbaf1079656206acc5cfe424edc30e2cd7853223c505e3fef28cc35c94c14742a912baee7f4197f680a91
b69d496ea67b87cbd0c399
HasBasicConstraint    : 1
HasKeyUsage           : 1
IsCa                  : 1
KeyUsage              : 119 digitalSignature nonRepudiation
keyEncipherment keyAgreement keyCertSign cRLSign
ExtendedKeyUsage      : TLS Web Server Authentication, OCSP Signing,
CDPUrl                : http://192.51.100.9:8080/ejbca/publicweb/webdist/
certdist?cmd=crl&issuer=CN=ca
OCSPUrl               :
CertificateFileName    : /intflash/.cert/.caCertStore/ca_cert_newsubca.der

```

Display the offline CA certificate:

```

Switch:1(config)#show certificate cert-type offline-ca-cert

CERT table entry
Certificate Type      : Offline CA Certificate
VersionNumber        : X.509 v3
SerialNumber         : 59f0b1a73c93b194
IssuerName           : CN:ca, EM:, OU:, O:, L:, P:, C:
ValidityPeriodNotBefore : 10/27/16 09:49:59
ValidityPeriodNotAfter  : 10/26/18 12:37:22
CertificateSignatureAlgorithm : sha256withRSAEncryption
CertificateSignature    :
65c2bed6f0333d6bbc5aea24d682061cfebefeb4bea8f74b3687cb72d700aabcf38af039dbff1e3d818627c5a2
7bfb4310c5fdd8db7eaea7bfb06275bc86f1e479ed0ca5ec7a828b44f862e294ea4bd39a3a38b2ec5c87f2fb5b
af98a856f380d9ec9f022ba5b05c328556233b7dc5d1359edc08966a194311eb76965ce509439a224c5c000468
8cfd154a855a80fd385538e00f5644792f9e496def7e293b2a20a60c782cc9bfcddc448e15024a0a49caa2bbe
fc82fa71cbda495915910a4363e5d7d95303d44a14e95932b1797ecc252e7ffa4d7cb8d270c693cebbf3e632f1
accbe6920460496d1f873d35b92c5430cb870d84d61d0556eea94a003e6785
Subject               : CN:newsubca, EM:, OU:, O:, L:, P:, C:
SubjectPublicKeyAlgorithm : rsaEncryption
SubjectPublicKey      :
00000000000000010000000102000000000301000100000100a0457dd22f1ff11a2c4f01f5fedcda5b26d88a16
7f056b2c915e690b3a2c1e30373a8e14e5f23586aaa9e68544bf8b5931f0dff6057936c3e8f48d2430ce9bdf2c
00d30da314f4d3a88d7e112593429005b7095f8e4aec18fda5d1697d35882eab98796ae0fe20994edc5a5b1379
521a65d9e168e6bfe6d842139a294c94aac122e51d7a5438ad8bf00f5098857a557a4f69f4b21bd08c9213d345
8a7fb7c644c7fcb4806fb4f683941f7701cb131ffc244aac314be88fb717c135bc7416390de4925d833e88936
2caefbaf1079656206acc5cfe424edc30e2cd7853223c505e3fef28cc35c94c14742a912baee7f4197f680a91
b69d496ea67b87cbd0c399
HasBasicConstraint    : 1
HasKeyUsage           : 1
IsCa                  : 1

```

```

KeyUsage          : 119 digitalSignature nonRepudiation
keyEncipherment  keyAgreement keyCertSign cRLSign
ExtendedKeyUsage : TLS Web Server Authentication, OCSP Signing,
CDPUrl           : http://192.51.100.9:8080/ejbca/publicweb/webdist/
certdist?cmd=crl&issuer=CN=ca
    
```

Display the offline subject certificate:

```

Switch:1(config)# show certificate cert-type offline-subject-cert
CERT table entry
Certificate Type   : Offline Subject Certificate
VersionNumber     : X.509 v3
SerialNumber      : 33f18af2c9ef62f5
IssuerName        : CN:newsubca, EM:, OU:, O:, L:, P:, C:
ValidityPeriodNotBefore : 11/03/16 11:40:28
ValidityPeriodNotAfter  : 10/26/18 12:37:22
CertificateSignatureAlgorithm : sha256withRSAEncryption
CertificateSignature :
2fd70da6d5a8f272f0f1cfc237eccb419eabd3c2fc8ca3c147c8f4b04efe2ecd8060f83f1ce420c37285e8a4a7
04249983e5b4545a9d0e7e684a03502d0d180ced5d2dd6747c8ab0f58b6f46ac56c6ff696dad6a93bd2c6249b3
2e74070499f6f94b0814ae7c14f1893ab1f2ce764340007eb06338bba5935ac5729e20e680c593f77dfa9aac96
ea5ec1a884e28db4e68bfbea116beffdb91cb09ab9fc6ac2aaee0064a2ef241412b6ebe21564623b28eaba14ff
7f2a07691c7703c50bc63b25dd18d21f0f08e63a33ca75cd49cfe93a9b6ff540d439008ac8e83a2393e94bf4b2
e5fal3e3d8df1df538651f4936f9db117fd6adf0960eaf116a92c5bfff7c06
Subject           : CN:newsub1, EM:test@mocana.com, OU:Engineering,
O:Mocana, L:San Francisco, P:California, C:US
SubjectPublicKeyAlgorithm : rsaEncryption
SubjectPublicKey   :
00000000000000010000000102000000000301000100000100d35e399359ee6c24837a0394dff783c039bf4c6f
e02000e31fecfa0a67b36fd390b3a1c29229af4ed24972186fc4991655479db597967b3bdda95c00bd1c07ca66
0ccf80acalbcbce8cbe2db31a5cd5868433eb9ac85ab7b54438c4e0b2da260a13eef4900929514ee8bee184df4
0f11c0c766a0e6ca89424f2f3753039e8e20e3809d20fa59d319ccaecee4a32a4ab1da9bf7f566241dd76c11eb
762ad320dafbcbca73e658d0faa5ea1caf75f1e4889038a58b3e48e9e541bcb4f818eb9b3e84a57bc6714e78906
7226953d740c6ef38d67d5ec891598f62248a337a1176bd3edef8adec606bbae9781b88d32c8867629ddbc9f53
2338cf4ca53918dd98c609
HasBasicConstraint : 1
HasKeyUsage        : 1
IsCa               : 0
KeyUsage           : 15 digitalSignature nonRepudiation keyEncipherment
dataEncipherment
ExtendedKeyUsage   : TLS Web Server Authentication, OCSP Signing,
CDPUrl            : http://192.51.100.9:8080/ejbca/publicweb/webdist/
certdist?cmd=crl=&CN=newsubca
OCSPUrl           : http://192.51.100.9:8080/ejbca/publicweb/status/ocsp
Status            : offline-certificate
Installed         : 1
    
```

Display the online CA certificate:

```

Switch:1(config)#show certificate cert-type online-ca-cert
CERT table entry
Certificate Type   : Online CA Certificate
VersionNumber     : X.509 v3
SerialNumber      : 59f0b1a73c93b194
IssuerName        : CN:ca, EM:, OU:, O:, L:, P:, C:
ValidityPeriodNotBefore : 10/27/16 09:49:59
ValidityPeriodNotAfter  : 10/26/18 12:37:22
CertificateSignatureAlgorithm : sha256withRSAEncryption
CertificateSignature :
65c2bed6f0333d6bbcb5aea24d682061cfebefeb4bea8f74b3687cb72d700aabc38af039dbff1e3d818627c5a2
7bfb4310c5fdd8db7eaea7bfb06275bc86f1e479ed0ca5ec7a828b44f862e294ea4bd39a3a38b2ec5c87f2fb5b
af98a856f380d9ec9f022ba5b05c328556233b7dc5d1359edc08966a194311eb76965ce509439a224c5c000468
8cfd154a855a80fd385538e00f5644792f9e496def7e293b2a20a60c782cc9bfcddc448e15024a0a49caa2bbe
fc82fa71cbda495915910a4363e5d7d95303d44a14e95932b1797ecc252e7ffa4d7cb8d270c693cebbf3e632f1
    
```

```

accbe6920460496d1f873d35b92c5430cb870d84d61d0556eea94a003e6785
Subject                               :   CN:newsubca, EM:, OU:, O:, L:, P:, C:
SubjectPublicKeyAlgorithm              :   rsaEncryption
SubjectPublicKey                      :
00000000000000010000000102000000000301000100000100a0457dd22f1ff11a2c4f01f5fedcda5b26d88a16
7f056b2c915e690b3a2c1e30373a8e14e5f23586aaa9e68544bf8b5931f0dff6057936c3e8f48d2430ce9bdf2c
00d30da314f4d3a88d7e112593429005b7095f8e4aec18fda5d1697d35882eab98796ae0fe20994edc5a5b1379
521a65d9e168e6bfe6d842139a294c94aac122e51d7a5438ad8bf00f5098857a557a4f69f4b21bd08c9213d345
8a7fb7c644c7fcb4806fb4f683941f7701cb131ffc2444aac314be88fb717c135bc7416390de4925d833e88936
2caefbaf1079656206acc5cfe424edc30e2cd7853223c505e3fefcd28cc35c94c14742a912baee7f4197f680a91
b69d496ea67b87cbd0c399
HasBasicConstraint                    :   1
HasKeyUsage                           :   1
IsCa                                   :   1
KeyUsage                              :   119 digitalSignature nonRepudiation
keyEncipherment keyAgreement keyCertSign cRLSign
ExtendedKeyUsage                      :   TLS Web Server Authentication, OCSP Signing,
CDPUrl                                :   http://192.51.100.9:8080/ejbca/publicweb/webdist/
certdist?cmd=crl=&CN=ca
OCSPUrl                               :

```

Display the online subject certificate:

```

Switch:1(config)#show certificate cert-type online-subject-cert

CERT table entry
Certificate Type                       :   Online Subject Certificate
VersionNumber                         :   X.509 v3
SerialNumber                          :   18684a25b80768f9
IssuerName                            :   CN:ca, EM:, OU:, O:, L:, P:, C:
ValidityPeriodNotBefore               :   11/07/16 12:36:43
ValidityPeriodNotAfter                :   10/26/18 12:37:22
CertificateSignatureAlgorithm         :   sha256withRSAEncryption
CertificateSignature                   :
6efc5c0fe4f054e9800b029a08b4d2b2f205692379a74818c6c57baba49a2efce1f622397d3b31aa81d55e2fb2
22610116e975900887d0e80d48718e080413c8d661a73503481a810f1559c97335a16bb53d1b08024fa6d568b1
56788670cf9d5cb34bdb10b1a8eb936869d4a2d2eeb96241865d685b018d0e094fea7b5a28f3e8d03c15e1baf
2ba7ce18aaadddc22b6928e597756067758412d283c187123fbedf55c252fabd22ee85cbe558aed6070db3aa8db
117f923d6509d543895c7510843c77b2b438de10e8bea2b76375e27641a6e6aaffd2003b58802a5c3d1b91e5f5
f2d5a68fea4a82c95745b954cc93924aa451458db1707594c871d14511e6cd
Subject                               :   CN:192.51.100.9, EM:test@mocana.com, OU:Engineering,
O:Mocana, L:San Francisco, P:California, C:US
SubjectPublicKeyAlgorithm              :   rsaEncryption
SubjectPublicKey                      :
00000000000000010000000102000000000301000100000100928124a0e780954494d384b15276bb6fc6b9a88b
b200bae0f7e8b9ce5fbae7387eff897e571362028b4678a491cbc9e74a2f985807c8ca48c5300cd17f349d9805
5f1a6868cd24956efa80ffd9013ce448ab58f31ce6fa0aaef9b6b2347d046af754cac7deb75c55eea7c5828
24d3f4fff9632d7044b532657777824105c1fd62584276be63c940effe5e307de1fe38fc50727cfdb6799f3575
e13451901ee16dbfcf7d18b6a78574f7230a90021b5b977571358871925239725044604e74edc4ee236243682b
db30541cc8369580177179c92bec6891473827dcecb3046cadd78530a3b7cb3aad5126a95daaae919f9355a232
ad1611b897ac22a08b7ff7
HasBasicConstraint                    :   1
HasKeyUsage                           :   1
IsCa                                   :   0
KeyUsage                              :   117 digitalSignature keyEncipherment keyAgreement
keyCertSign cRLSign
ExtendedKeyUsage                      :   TLS Web Server Authentication, OCSP Signing,
CDPUrl                                :   http://192.51.100.9:8080/ejbca/publicweb/webdist/
certdist?cmd=crl=&CN=ca
OCSPUrl                               :   http://192.51.100.9:8080/ejbca/publicweb/status/ocsp
Status                                :   active
Installed                             :   1

```

Variable definition

Use the data in the following table to use the **show certificate** command.

Variable	Value
cert-type [online-ca-cert]	Specifies Certificate Authority's Certificate obtained online from Certificate Authority.
cert-type [online-subject-cert]	Specifies subject certificate obtained online from Certificate Authority.
cert-type [offline-ca-cert]	Specifies Certificate Authority's certificate obtained offline from Certificate Authority.
cert-type [offline-subject-cert]	Specifies subject certificate obtained offline from Certificate Authority.
cert-type [intermediate-ca-cert WORD<1-80>]	Specifies the intermediate certificate obtained offline from Certificate Authority.
cert-type [root-ca-cert WORD<1-80>]	Specifies root certificate obtained offline from Root Certificate Authority.
ca [WORD<1-45>]	Specifies name of the Certificate Authority. If the name is not specified, the command displays the CA details of all configured CA.

Job aid

This section describes the fields in the output for the different **show certificate** commands.

The following table describes the fields in the output for the **show certificate cert-type** command

Parameter	Description
Certificate Type	Indicates the type of certificate. <ul style="list-style-type: none"> • Root Certificate • Offline subject certificate • Online subject certificate • Intermediate CA certificate • Offline CA certificate • Online CA certificate
VersionNumber	Indicates the certificate version number for the subject as issued by the Certificate Authority.
SerialNumber	Indicates the certificate serial number for the subject as issued by the Certificate Authority.
IssuerName	Indicates the certificate issuer name for the subject as issued by the Certificate Authority.

Table continues...

Parameter	Description
ValidityPeriodNotBefore	Indicates the certificate validation period start date for the subject as issued by the Certificate Authority.
ValidityPeriodNotAfter	Indicates the certificate validation period last date for the subject as issued by the Certificate Authority.
CertificateSignatureAlgorithm	Indicates the algorithm used for the issuer's signature on the certificate for the subject as issued by the Certificate Authority.
CertificateSignature	Indicates the issuer's signature on the certificate for the subject as issued by the Certificate Authority.
Subject	Indicates the details of the subject on its certificate as issued by Certificate Authority.
SubjectPublicKeyAlgorithm	Indicates the algorithm used to generate the subject's public key for the certificate issued by the Certificate Authority.
SubjectPublicKey	Indicates the public key of the subject used for Certificate Signing Request.
HasBasicConstraint	Indicates whether certificate contains basic certificate constraint.
HasKeyUsage	Indicates whether certificate contains basic key usage constraint.
IsCa	Indicates if the certificate is a CA certificate or not.
KeyUsage	Indicates the purpose of the key used in the certificate. It is represented in the form of bits as follows: <ul style="list-style-type: none"> • bit 0 - digitalSignature • bit 1 - nonRepudiation • bit 2 - keyEncipherment • bit 3 - dataEncipherment • bit 4 - keyAgreement • bit 5 - keyCertSign • bit 6 - cRLSign • bit 7 - encipherOnly • bit 8 - decipherOnly
ExtendedKeyUsage	Indicates the purpose for which the key is used in addition to or in place of the basic purposes indicated in the key-usage field of the certificate.
CDPUrl	Indicates the CDP URL present in the Digital Certificate Extensions field.
OCSPUrl	Indicates the OCSP URL present in the Digital Certificate AIA field.
Status	Indicates the certificate status.
Installed	Indicates if the certificate is installed.

The following table describes the fields in the output for the `show certificate ca` command

Parameter	Description
Name	Indicates the user defined name referring to the Certificate Authority issuing the Digital Certificate.
CommonName	Indicates the Common Name of the Certificate Authority issuing the Digital Certificate.
KeyName	Indicates the generated key pair that was first associated with the CA trustpoint.
CaUrl	Indicates the URL of the Certificate Authority issuing the Digital Certificate.
UsePost	Indicates if the HTTP request type is URL or POST. Where, TRUE indicates EJBCA and FALSE indicates Win2012 CA.
SubjectCertValidityDays	Indicates number of days for which subject certificate is valid.
Action	Indicates the various actions that a Certificate Authority can take. <ul style="list-style-type: none"> • noop - No operation • caauth - Certificate Authority authentication • enroll - Certificate Enrolment Request • renew - Certificate Renew Request • remove - Removes the subject certificate obtained online from the Certificate Authority • install - Installs the subject certificate obtained online from the Certificate Authority • generateCsr - Generates the Certificate Signing Request required to obtain the Offline Subject Certificate
LastActionStatus	Indicates the status of the last action. <ul style="list-style-type: none"> • none - No action is performed yet • success - Execution of the action triggered is completed successfully • failed - Execution of the action triggered has failed • inProgress - Execution of the action triggered is in progress
LastActionFailureReason	Indicates the reason of failure for the last action performed by the Certificate Authority.

The following table describes the fields in the output for the **show certificate key-name** command

Parameter	Description
Key Name	Indicates the name of the key-pair generated for the subject. It is an auto generated entity, generated as the combination of key-type and key-size.
Public Key Value	Indicates the public key of the subject used to the Certificate Signing Request.

The following table describes the fields in the output for the `show certificate subject` command

Parameter	Description
CommonName	Indicates the Common Name field of the subject sending the Certificate Signing Request (CSR) to the Certificate Authority.
EmailAddress	Indicates the Email address of the subject sending the CSR to the Certificate Authority.
OrganizationalUnit	Indicates the Organizational Unit field of the subject sending the CSR to the Certificate Authority.
Organization	Indicates the Organization of the subject sending the CSR to the Certificate Authority.
Locality	Indicates the name of the Locality of the subject sending the CSR to the Certificate Authority.
Province	Indicates the Province name of the subject sending the CSR to the Certificate Authority.
Country	Indicates the name of the country of the subject sending the CSR to the Certificate Authority.

Digital certificate configuration examples

This section shows how to obtain an online CA signed certificate, remove the expired certificate, renew the certificate, and install an offline subject certificate.

Obtaining an online CA-signed subject certificate

Use the following procedure as an example to obtain an online CA signed subject certificate that the application can use.

About this task

In the following commands, the variable `WORD<1-45>` refers to the name of the certificate authority and the variable `WORD<1-80>` refers to the certificate filename.

Procedure

1. Enter Global Configuration mode:

```
enable
configure terminal
```

2. Configure the subject:

```
certificate subject common-name scephub
certificate subject e-mail test@mocana.com
certificate subject unit Engineering
certificate subject organization "Mocana Corporation"
certificate subject locality "San Francisco"
certificate subject country US
certificate subject province California
```

*** Note:**

The values mentioned are for example only.

3. Generate the key pair:

```
certificate generate-keypair type rsa size 2048
```

4. Configure the certificate authority (CA):

```
certificate ca ej common-name subca5
certificate ca ej key-name rsa_2048
certificate ca ej ca-url http://192.51.100.9:8080/ejbca/publicweb/apply/scep/test/
pkiclient.exe
certificate ca ej use-post true
```

*** Note:**

The values mentioned are for example.

5. Copy and paste the Root CA certificate to: /intflash/.cert/.offlineRootCACert/.
6. Install the Root CA certificate:

```
certificate ca WORD<1-45> install-file root-ca-filename WORD<1-80>
```

7. Authenticate the CA:

```
certificate ca WORD<1-45> action caauth
```

8. Enroll the subject certificate by the CA:

```
certificate ca WORD<1-45> action enroll
```

9. Install the certificate:

```
certificate ca WORD<1-45> action install
```

10. **(Optional)** If the certificate expires, remove the enrolled subject certificate:

```
certificate ca WORD<1-45> action remove
```

The certificate is removed from /intflash/.cert and /intflash/.cert/.installedCert/.

11. **(Optional)** To obtain the new certificate before the old certificate expires, enter the following command to renew the certificate:

```
certificate ca WORD<1-45> action renew
```

The Certificate Authority generates a new certificate for the subject.

Installing an offline CA certificate

Use the following procedure as an example to install the offline CA certificate.

About this task

In the following commands, the variable *WORD<1-80>* refers to the certificate filename.

Procedure

1. Enter Global Configuration mode:

```
enable
```

```
configure terminal
```

2. Configure the subject:

```
certificate subject common-name scep-sub
certificate subject e-mail test@mocana.com
certificate subject unit Engineering
certificate subject organization "Mocana Corporation"
certificate subject locality "San Francisco"
certificate subject country US
certificate subject province California
```

* Note:

The values mentioned are for example only.

3. Generate the certificate signing request using the command:

```
certificate generate-csr
```

4. Use the generated CSR file to enroll the certificate on the server.

5. Copy and paste the enrolled certificate along with Root to: /

```
intflash/.cert/.offlineRootCACert/.
```

6. Install the Root CA certificate:

```
certificate install-file offline-root-ca-filename WORD<1-80>
```

* Note:

If the subject certificate issuer is directly the Root, then Step 7 and 8 are optional. If the subject is issued by Intermediate CA, then Step 7 and 8 are mandatory, also in the certificate chain between Root and Subject, all the Intermediates must be installed using these steps.

7. Copy and paste the Intermediate CA certificate to: /

```
intflash/.cert/.offlineCACert/.
```

8. Install the intermediate CA:

```
certificate install-file offline-ca-filename WORD<1-80>
```

9. Copy and paste the Offline subject certificate to: /intflash/.cert/.offlineCert/.

10. Install the offline subject filename:

```
certificate install-file offline-subject-filename WORD<1-80>
```

Security configuration using Enterprise Device Manager

Configure security information used on the control and data paths to protect the network from uncontrolled access to network resources.

For more information about how to configure passwords and access policies, see *Administering*.

Enabling port lock

About this task

Use the port lock feature to administratively lock a port or ports to prevent other users from changing port parameters or modifying port action. You cannot modify locked ports until you first unlock the port.

Procedure

1. In the navigation tree, open the following folders: **Configuration > Security > Control Path**.
2. Click **General**.
3. Click the **Port Lock** tab.
4. To enable port lock, select the **Enable** check box.
5. Click **Apply**.

Port Lock field descriptions

Use the data in the following table to use the **Port Lock** tab.

Name	Description
Enable	Activates the port lock feature. Clear this check box to unlock ports. The default is disabled.
LockedPorts	Lists the locked ports. Click the ellipsis (...) button to select the ports you want to lock or unlock.

Locking a port

Before you begin

- You must enable port lock before you lock or unlock a port.

About this task

Use the port lock feature to administratively lock a port or ports to prevent other users from changing port parameters or modifying port action. You cannot modify locked ports until you first unlock the port.

Procedure

1. In the navigation tree, open the following folders: **Configuration > Security > Control Path**.
2. Click **General**.
3. Click the **Port Lock** tab.
4. In the **LockedPorts** box, click the ellipsis (...) button.
5. Click the desired port or ports.

6. Click **Ok**.
7. In the Port Lock tab, click **Apply**.

Port Lock field descriptions

Use the data in the following table to use the **Port Lock** tab.

Name	Description
Enable	Activates the port lock feature. Clear this check box to unlock ports. The default is disabled.
LockedPorts	Lists the locked ports. Click the ellipsis (...) button to select the ports you want to lock or unlock.

Changing passwords

About this task

Configure new passwords for each access level, or change the logon or password for the different access levels of the system to prevent unauthorized access. After you receive the switch, use default passwords to initially access CLI. If you use Simple Network Management Protocol version 3 (SNMPv3), you can change passwords in encrypted format.

Procedure

1. In the navigation tree, open the following folders: **Configuration > Security > Control Path**.
2. Click **General**.
3. Click the **CLI** tab.
4. Specify the username and password for the appropriate access level.
5. Click **Apply**.

CLI field descriptions

Use the data in the following table to use the **CLI** tab.

Name	Description
RWAUserName	Specifies the user name for the read-write-all CLI account.
RWAPassword	Specifies the password for the read-write-all CLI account.
RWEnable	Activates the read-write access level.
RWUserName	Specifies the user name for the read-write CLI account.
RWPassword	Specifies the password for the read-write CLI account.

Table continues...

Name	Description
RWL3Enable	Activates the read-write Layer 3 access level.
RWL3UserName	Specifies the user name for the Layer 3 read-write CLI account.
RWL3Password	Specifies the password for the Layer 3 read-write CLI account.
RWL2Enable	Activates the read-write Layer 2 access level.
RWL2UserName	Specifies the user name for the Layer 2 read-write CLI account.
RWL2Password	Specifies the password for the Layer 2 read-write CLI account.
RWL1Enable	Activates the read-write Layer 1 access level.
RWL1UserName	Specifies the user name for the Layer 1 read-write CLI account.
RWL1Password	Specifies the password for the Layer 1 read-write CLI account.
ROEnable	Activates the read/only CLI account level.
ROUserName	Specifies the user name for the read-only CLI account.
ROPassword	Specifies the password for the read-only CLI account.
MaxTelnetSessions	Indicates the maximum number of concurrent Telnet sessions (0–8). The default is 8.
MaxRloginSessions	Indicates the maximum number of concurrent Rlogin sessions (0–8). The default is 8.
Timeout	Indicates the number of seconds of inactivity for a Telnet or Rlogin session before automatic timeout and disconnect (30–65535 seconds). The default is 900.
NumAccessViolations	Indicates the number of CLI access violations detected by the system. This field is a read-only field.
CustomBannerText	Specifies the text message that is displayed to users on the CLI before authentication. The message can be company information, such as company name and contact, or a warning message for the users of CLI. With character limitation from 1-1800, the text box displays 79 characters per line.
CustomBannerEnable	Specifies whether custom logon banner is enabled or disabled. The default is enabled.

Configuring directed broadcast on a VLAN

Configure directed broadcast on a VLAN to enable or disable directed broadcast traffic forwarding for an IP interface.

Procedure

1. In the navigation pane, expand the **Configuration > VLAN** folders.
2. Click **VLANs**.
3. Select the **Basic** tab.
4. Select a VLAN.
5. Click **IP**.
6. Click the **Direct Broadcast** tab.
7. Select **DirectBroadcastEnable**.

Important:

Configure multiple VLANs or IPs in the same subnet but in different systems simultaneously.

8. Click **Apply**.

Direct Broadcast field descriptions

Use the data in the following table to use the **Direct Broadcast** tab.

Name	Description
DirectBroadcastEnable	<p>Specifies that an Isolated Routing Port (IRP) can forward directed broadcast traffic. A directed broadcast is a frame sent to the subnet broadcast address on a remote IP subnet. By disabling or suppressing directed broadcast on an interface, all frames sent to the subnet broadcast address for a local router interface are dropped. Disabling this function protects a host from possible denial of service (DoS) attacks.</p> <p>With the feature enabled, the Control Processor (CP) does not receive a copy of the directed broadcast. As a result, the system does not respond to a subnet broadcast ping sent from a remote subnet.</p> <p>The default is disabled.</p>

Unicast Reverse Path Forwarding configuration using EDM

This section provides EDM procedures for Unicast Reverse Path Forwarding configuration.

Configuring reverse path checking on a port

Before you begin

- The system supports reverse path checking only on ports that have a valid IP address.

About this task

Configure reverse path checking on a port to determine if a packet IP address is verifiable. Use reverse path checking to reduce the problems that are caused by the introduction of malformed or forged (spoofed) IP source addresses into a network. After you enable reverse path checking, the switch performs a reverse path check to determine if the packet IP address is verifiable. If the address is not verifiable, the system discards the packet.

Reverse path checking operates in one of two modes:

- exist-only mode
- strict mode

Procedure

1. In the Device Physical View tab, select a port.
2. In the navigation tree, open the following folders: **Configuration > Edit > Port**.
3. Click **IP**.
4. Click the **Reverse Path Checking** tab.
5. Select the **Enable** check box to enable reverse path checking.
6. Select **exist-only** or **strict**.
7. Click **Apply**.

Reverse Path Checking field descriptions

Use the data in the following table to use the **Reverse Path Checking** tab.

Name	Description
Enable	Enables reverse path checking on the selected port. The default is disabled.
Mode	Specifies the mode for reverse path checking. The modes are <ul style="list-style-type: none"> • exist-only—reverse path checking checks whether the incoming packet source IP address exists in the routing table. If reverse path checking finds the source IP entry, the packet is forwarded; otherwise the packet is discarded. • strict—reverse path checking checks whether the incoming packet source IP address exists in routing table. If reverse

Table continues...

Name	Description
	<p>path checking does not find the source IP entry, the packet is dropped; otherwise, reverse path checking further checks if the source IP interface matches the incoming interface of the packet. If they match, the packet is forwarded; otherwise the packet is discarded.</p> <p>The default is exist-only.</p>

Configuring reverse path checking on an IPv6 port

Before you begin

- The system supports reverse path checking only on ports that have a valid IP address.

About this task

Configure reverse path checking on a port to determine if a packet IP address is verifiable. Use reverse path checking to reduce the problems that are caused by the introduction of malformed or forged (spoofed) IP source addresses into a network. After you enable reverse path checking, the switch performs a reverse path check to determine if the packet IP address is verifiable. If the address is not verifiable, the system discards the packet.

Reverse path checking operates in one of two modes:

- exist-only mode
- strict mode

Procedure

1. In the Device Physical View tab, select a port.
2. In the navigation pane, expand the : **Configuration** > **Edit** > **Port** folders.
3. Click **IPv6**.
4. Click the **Reverse Path Checking** tab.
5. Select the **ReversePathCheckEnable** check box to enable reverse path checking.
6. Select **exist-only** or **strict**.
7. Click **Apply**.

Reverse Path Checking field descriptions

Use the data in the following table to use the **Reverse Path Checking** tab.

Name	Description
ReversePathCheckEnable	Enables reverse path checking on the selected port. The default is disabled.
ReversePathCheckMode	<p>Specifies the mode for reverse path checking. The modes are</p> <ul style="list-style-type: none"> • exist-only—reverse path checking checks whether the incoming packet source IP address exists in the routing table.

Table continues...

Name	Description
	<p>If reverse path checking finds the source IP entry, the packet is forwarded; otherwise the packet is discarded.</p> <ul style="list-style-type: none"> • strict—reverse path checking checks whether the incoming packet source IP address exists in routing table. If reverse path checking does not find the source IP entry, the packet is dropped; otherwise, reverse path checking further checks if the source IP interface matches the incoming interface of the packet. If they match, the packet is forwarded; otherwise the packet is discarded. <p>The default is exist-only.</p>

Configuring reverse path checking on a VLAN

Before you begin

- Before you can configure reverse path checking on a VLAN, you must assign a valid IP address to the selected VLAN.

About this task

Configure reverse path checking on a VLAN to determine if a packet IP address is verifiable. Use reverse path checking to reduce the problems that are caused by the introduction of malformed or forged (spoofed) IP source addresses into a network. After you enable reverse path checking, the switch performs a reverse path check to determine if the packet IP address is verifiable. If the address is not verifiable, the system discards the packet.

Reverse path checking operates in one of two modes:

- exist-only mode
- strict mode

Procedure

1. In the navigation tree, open the following folders: **Configuration > VLAN**.
2. Click **VLANs**.
3. Click the VLAN on which you want to configure reverse path checking.
4. In the toolbar, click **IP**.
5. Click the **Reverse Path Checking** tab.
6. Select the **Enable** box to enable reverse path checking.
7. Select **exist-only** or **strict**.
8. Click **Apply**.

Reverse Path Checking field descriptions

Use the data in the following table to use the **Reverse Path Checking** tab.

Name	Description
Enable	Enables reverse path checking on the selected VLAN.
Mode	<p>Specifies the mode for reverse path checking. The modes are</p> <ul style="list-style-type: none"> • exist-only—reverse path checking checks whether the incoming packet source IP address exists in the routing table. If reverse path checking finds the source IP entry, the packet is forwarded; otherwise, the packet is discarded. • strict—reverse path checking checks whether the incoming packet source IP address exists in routing table. If reverse path checking does not find the source IP entry, then the packet is dropped. Otherwise, reverse path checking further checks if the source IP interface matches the incoming interface of the packet. If they match, then the packet is forwarded. Otherwise, the packet is discarded. <p>The default is exist-only.</p>

Configuring reverse path checking on an IPv6 VLAN

Before you begin

- Before you can configure reverse path checking on a VLAN, you must assign a valid IP address to the selected VLAN.

About this task

Configure reverse path checking on a VLAN to determine if a packet IP address is verifiable. Use reverse path checking to reduce the problems that are caused by the introduction of malformed or forged (spoofed) IP source addresses into a network. After you enable reverse path checking, the switch performs a reverse path check to determine if the packet IP address is verifiable. If the address is not verifiable, the system discards the packet.

Reverse path checking operates in one of two modes:

- exist-only mode
- strict mode

Procedure

1. In the navigation pane, expand the **Configuration > VLAN** folders.
2. Click **VLANs**.
3. Click the **Basic** tab.
4. Click the VLAN on which you want to configure reverse path checking.
5. Click **IPv6**.
6. Click the **Reverse Path Checking** tab.
7. Select the **ReversePathCheckEnable** box to enable reverse path checking.
8. Select **exist-only** or **strict**.

- Click **Apply**.

Reverse Path Checking field descriptions

Use the data in the following table to use the **Reverse Path Checking** tab.

Name	Description
ReversePathCheckEnable	Enables reverse path checking on the selected VLAN.
ReversePathCheckMode	<p>Specifies the mode for reverse path checking. The modes are</p> <ul style="list-style-type: none"> • exist-only—reverse path checking checks whether the incoming packet source IP address exists in the routing table. If reverse path checking finds the source IP entry, the packet is forwarded; otherwise, the packet is discarded. • strict—reverse path checking checks whether the incoming packet source IP address exists in routing table. If reverse path checking does not find the source IP entry, then the packet is dropped. Otherwise, reverse path checking further checks if the source IP interface matches the incoming interface of the packet. If they match, then the packet is forwarded. Otherwise, the packet is discarded. <p>The default is exist-only.</p>

Viewing ASG global configuration

About this task

Use this procedure to display the ASG global configuration.

Procedure

- In the navigation pane, expand the following folders: **Configuration > Security > Control Path > ASG**
- Click the **Globals** tab.

Field descriptions

Use the data in the following table to use the **ASG > Globals** tab.

Name	Description
EnableStatus	Specifies whether ASG is enabled or disabled. The value 1 indicates that ASG is enabled on the device.
AFID	Specifies the unique authentication file identification number.
Product	Specifies the device on which ASG is enabled.
DateAndTime	Specifies the date and time of configuration.
Release	Specifies the software release in which ASG is configured.

Viewing active ASG accounts

About this task

Use this procedure to display the accounts associated with ASG on the device.

Procedure

1. In the navigation tree, expand the following folders: **Configuration > Security > Control Path > ASG**
2. Click the **Accounts** tab.

Field descriptions

Use the data in the following table to use the **ASG > Accounts** tab.

Name	Description
AccessLevel	Specifies the authentication access level for each account.
Username	Specifies the user name corresponding to each account.

Digital certificate configuration using EDM

The following section provides procedures to configure digital certificates using EDM.

Configuring device subject parameters

Use this procedure to configure the device subject parameters to identify the device. The parameters include name, Email ID, company, department, and location of the subject.

Procedure

1. In the navigation pane, expand the following folders: **Configuration > Security > Control Path**.
2. Click **Certificate**.
3. Click the **Subject** tab.
4. In the **CommonName** field, type the name of the subject.
5. Complete the remaining optional configuration to customize the policy.
6. Click **Apply**.

Subject field descriptions

Use the data in the following table to use the Subject tab.

Name	Description
CommonName	Specifies the name of the subject sending the Certificate Signing Request to the Certificate Authority.
EmailAddress	Specifies the Email address of the subject sending the Certificate Signing Request to the Certificate Authority.
OrganizationalUnit	Specifies the organizational unit of the subject sending the Certificate Signing Request to the Certificate Authority.
Organization	Specifies the organization of the subject sending the Certificate Signing Request to the Certificate Authority.
Locality	Specifies the locality of the subject sending the Certificate Signing Request to the Certificate Authority.
Province	Specifies the province of the subject sending the Certificate Signing Request to the Certificate Authority.
Country	Specifies the country of the subject sending the Certificate Signing Request to the Certificate Authority.
InstallFile	Installs the specific certificate file type obtained offline from the Certificate Authority.
InstallFileName	Specifies the certificate file name to install.
UninstallFile	Uninstalls the specific certificate file type obtained offline from the Certificate Authority.
UninstallFileName	Specifies the certificate file name to uninstall.
GenerateCsr	Generates the certificate signing request to obtain the offline subject certificate.

Generating key pair

Use the following procedure to generate the private and public key pair for the specific cryptography type.

Procedure

1. In the navigation pane, expand the following folders: **Configuration > Security > Control Path**.
2. Click **Certificate**.
3. Click the **Key-pair** tab.
4. Click **Insert**.
5. In the **Type** field, select the cryptography type.

This software supports RSA only.

6. In the **Size** field, enter the size of the key.
7. Click **Insert**.

Certificate key-pair field description

Use the data in the following table to use the **Certificate > Key-Pair** tab.

Name	Description
Type	Specifies the cryptography algorithm used to generate the key-pair.
Size	Specifies the size of the key-pair to be generated.
Name	Specifies the name of the key-pair generated for the subject. This name is auto-generated as the combination of key-type and key-size.

Configuring certificate authority

Use this procedure to configure the certificate authority (CA) and perform related actions. You can configure only one CA in a device at a time.

Procedure

1. In the navigation pane, expand the following folders: **Configuration > Security > Control Path**.
2. Click **Certificate**.
3. Click the **CA** tab.
4. Click **Insert**.
5. In the **Name** field, type a user-defined name of the CA.
6. In the **CommonName** field, type the common name of the CA.
7. In the **KeyName** field, type the name of the associated key pair.
8. Complete the remaining optional configuration to customize the policy.
9. Click **Insert**.
10. **(Optional)** Click **Retry Action** if the trustpoint CA certificate authentication fails or takes time for authentication. This can be done only when the selected Action is caauth.

CA field descriptions

Use the data in the following table to use the CA tab.

Name	Description
Name	Specifies the user-defined name referring to the Certificate Authority issuing the Digital Certificate.
CommonName	Specifies the Common Name of the Certificate Authority issuing the Digital Certificate.
KeyName	Specifies the name of the associated key pair.
CaUrl	Specifies the URL of the Certificate Authority issuing the Digital Certificate.
Action	<p>Specifies the action the Certificate Authority can take:</p> <ul style="list-style-type: none"> • noop — no operation • caauth — CA authentication • enroll — certificate enrolment request • renew — certificate renew request • remove — remove the subject certificate obtained online from the CA • install — install the subject certificate obtained online from the CA
ActionChallengePassword	Specifies the challenge password required to perform the SCEP operation.
LastActionStatus	<p>Specifies the status of the last action:</p> <ul style="list-style-type: none"> • none - No action is performed yet • success - Execution of the action triggered is completed successfully • failed - Execution of the action triggered has failed • inProgress - Execution of the action triggered is in progress
LastActionFailureReason	Specifies the reason of failure for the last action performed by the Certificate Authority.
InstallRootCaFileName	Specifies the certificate file obtained offline from the Root Certificate Authority.
SubjectCertificateValidityDays	<p>Specifies the number of days for which subject certificate will remain valid.</p> <p>The default value is 365 days.</p>
UsePost	<p>Specifies the HTTP request type: URL or POST.</p> <p>TRUE for EJBCA and FALSE for Win2012 CA</p>

Viewing the certificate details

Use this procedure to:

- display the configured key details for given key name.
- display the digital certificate for the given certificate index or list all the certificate details from the local store if the certificate index is not specified.
- display the CA details for given trustpoint CA name or list all the CA details from the local store if the CA name is not specified.

Procedure

1. In the navigation pane, expand the following folders: **Configuration > Security > Control Path**.
2. Click **Certificate**.
3. Click the **Certificate** tab.

Certificate field descriptions

Use the data in the following table to use the **Certificate** tab.

Name	Description
Type	Specifies the certificate type.
VersionNumber	Specifies the version number of the certificate for the subject as issued by the Certificate Authority.
SerialNumber	Specifies the serial number of the certificate for the subject as issued by the Certificate Authority.
IssuerName	Specifies the name of the issuer of the certificate for the subject as issued by the Certificate Authority.
ValidStartPeriod	Specifies the start date of the validation period of the certificate for the subject as issued by the Certificate Authority.
ValidEndPeriod	Specifies the last date of the validation period of the certificate for the subject as issued by the Certificate Authority.
CertificateSignatureAlgorithm	Specifies the algorithm used for the signature of the issuer on the certificate for the subject as issued by the Certificate Authority.
CertificateSignature	Specifies the signature of the issuer on the certificate for the subject as issued by the Certificate Authority.
Subject	Specifies the details of the subject on its certificate as issued by Certificate Authority.
SubjectPublicKeyAlgorithm	Specifies the algorithm used to generate the public key of the subject for the certificate issued by the Certificate Authority.

Table continues...

Name	Description
SubjectPublicKey	Specifies the public key of the subject used for the Certificate Signing Request.
HasBasicConstraint	Specifies whether the certificate contains any basic certificate constraint or not.
HasKeyUsage	Specifies whether the certificate contains basic key usage constraint or not.
IsCa	Specifies whether the certificate is a ca certificate or not.
KeyUsage	Specifies the purpose of the key used in the certificate. It is represented in the form of bits as follows: <ul style="list-style-type: none"> • bit 0 - digitalSignature • bit 1 - nonRepudiation • bit 2 - keyEncipherment • bit 3 - dataEncipherment • bit 4 - keyAgreement • bit 5 - keyCertSign • bit 6 - cRLSign • bit 7 - encipherOnly • bit 8 - decipherOnly
Status	Specifies the status of the certificate.
Installed	Specifies whether the certificate is installed or not.
CdpUrl	Specifies the CDP URL present in the Digital Certificate Extensions field.
OcspUrl	Specifies the OCSP URL present in the Digital Certificate AIA field.
ExtendedKeyUsage	Indicates the purpose for which the key is used in addition to or in place of the basic purposes indicated in the key-usage field of the certificate.

Installing Root CA certificate

Use the following procedure to install the Root CA certificate obtained offline.

Procedure

1. In the navigation pane, expand the following folders: **Configuration > Edit > Diagnostics**.
2. Click **System Log**.
3. Click **Root Certificate Table** tab.
4. Click **Insert**.

5. In the **Filename** field, enter the filename obtained offline from the CA.
6. In the **Action** field, select the action.
7. Click **Insert**.

Root Certificate Table field description

Use the data in the following table to use the **System Log > Root Certificate Table** tab.

Name	Description
Filename	Specifies the certificate filename obtained offline from the Root Certificate Authority.
Action	<p>Specifies the action to be performed on Root CA.</p> <ul style="list-style-type: none"> • noaction: No action is performed. • install: Installs the Root CA certificate obtained offline. • uninstall: Uninstalls the Root CA certificate. <p>Conversion Fail appears if the execution of the action fails.</p>

Viewing Certificate Store

Use the following procedure to view the online, offline and root certificates in the local store.

Procedure

1. In the navigation pane, expand the following folders: **Configuration > Security > Control Path**.
2. Click **Certificate**.
3. Click the **Certificate Store** tab.

Certificate Store field descriptions

Use the data in the following table to use the **Certificate Store** tab.

Name	Description
CommonName	Specifies the Common Name of the Certificate Authority issuing the Digital Certificate.
Type	Specifies the certificate type.
VersionNumber	Specifies the version number of the certificate for the subject as issued by the Certificate Authority.
SerialNumber	Specifies the serial number of the certificate for the subject as issued by the Certificate Authority.
IssuerName	Specifies the name of the issuer of the certificate for the subject as issued by the Certificate Authority.

Table continues...

Name	Description
ValidStartPeriod	Specifies the start date of the validation period of the certificate for the subject as issued by the Certificate Authority.
ValidEndPeriod	Specifies the last date of the validation period of the certificate for the subject as issued by the Certificate Authority.
CertificateSignatureAlgorithm	Specifies the algorithm used for the signature of the issuer on the certificate for the subject as issued by the Certificate Authority.
CertificateSignature	Specifies the signature of the issuer on the certificate for the subject as issued by the Certificate Authority.
Subject	Specifies the details of the subject on its certificate as issued by Certificate Authority.
SubjectPublicKeyAlgorithm	Specifies the algorithm used to generate the subject's public key for the certificate issued by the Certificate Authority.
SubjectPublicKey	Specifies the public key of the subject used for Certificate Signing Request.
HasBasicConstraint	Specifies whether certificate contains basic certificate constraint.
HasKeyUsage	Specifies whether certificate contains basic key usage constraint.
IsCa	Specifies if the certificate is a CA certificate or not.
KeyUsage	Specifies the purpose of the key used in the certificate. It is represented in the form of bits as follows: <ul style="list-style-type: none"> • bit 0 - digitalSignature • bit 1 - nonRepudiation • bit 2 - keyEncipherment • bit 3 - dataEncipherment • bit 4 - keyAgreement • bit 5 - keyCertSign • bit 6 - cRLSign • bit 7 - encipherOnly • bit 8 - decipherOnly
Status	Specifies the status of the certificate.
Installed	Specifies whether the certificate is installed or not.
CdpUrl	Specifies the CDP URL present in the Digital Certificate Extensions field.

Table continues...

Name	Description
OscpUrl	Specifies the OCSP URL present in the Digital Certificate AIA field.
ExtendedKeyUsage	Indicates the purpose for which the key is used in addition to or in place of the basic purposes indicated in the key-usage field of the certificate.
CaFileName	Specifies the certificate file obtained offline from the Root Certificate Authority.

Chapter 4: Layer 2 security

Layer 2 security for IPv4 and IPv6 deployments

This chapter describes Layer 2 security concerns and the security features you can use to mitigate them.

Security features for IPv4 deployments:

- DHCP Snooping
- Dynamic ARP Inspection
- IP Source Guard for IPv4 addresses

Security features for IPv6 deployments:

- First Hop Security (FHS)
- DHCP Snooping and IPv6 Neighbor Discovery Inspection
- IP Source Guard for IPv6 addresses

Dynamic ARP Inspection

Dynamic ARP Inspection (DAI) is a security feature that validates ARP packets in the network.

Without DAI, a malicious user can attack hosts, switches, and routers connected to the Layer 2 network by poisoning the ARP caches of systems connected to the subnet, and intercepting traffic intended for other hosts on the subnet. DAI prevents these attacks by intercepting, logging, and discarding the ARP packets with invalid IP to MAC address bindings.

The switch dynamically builds the address binding table from the information gathered from the DHCP requests and replies when DHCP Snooping is enabled. The switch pairs the MAC address from the DHCP request with the IP address from the DHCP reply to create an entry in the DHCP binding table. For more information, see [Creating DHCP binding table entries](#) on page 158.

When you enable DAI, the switch filters ARP packets on untrusted ports based on the source MAC and IP addresses seen on the switch port. The switch forwards an ARP packet when the source MAC and IP address matches an entry in the address binding table. Otherwise, the switch drops the ARP packet.

Note:

- For DAI to function, you must enable DHCP Snooping globally.

- Configure DAI on a VLAN to VLAN basis.

DAI cannot be enabled on:

- Private VLANs (Etree)
- SPBM B-VLANs
- MLT port members

First Hop Security

First Hop Security (FHS) improves local network security by employing a number of mitigation techniques. This section describes the base set functionality which provides protection from a wide host of rogue or mis-configured users, and this can be extended with additional features for different deployment scenarios. For example, see the following topology.

Sample topology

In the following topology, Layer 2 switch SW-1 is connected to another Layer 2 switch SW-2. SW-2 is connected to three hosts and SW-1 is connected to two hosts.

In this network, if FHS is enabled only on SW-1, then it can only save the nodes which are directly connected to it. To protect the good node connected to SW-2, the FHS must be enabled on SW-2.

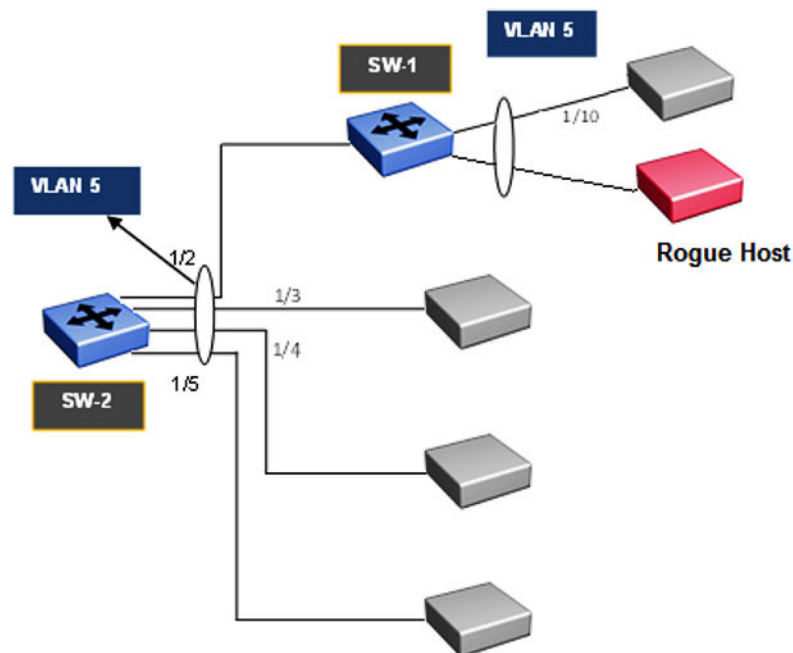

Figure 1: First Hop Security topology

First Hop Security contains the majority of the RIPE 554 mandatory requirements for Layer 2 switches. This includes the following:

- DHCPv6 Guard or DHCPv6 filtering
- RA Guard or Router Advertisement filtering

DHCPv6 security concerns

The enhancements in IPv6 provide better security in certain areas, but some of these areas are still open to exploitation by attackers. This section identifies the IPv6 FHS concerns associated with Dynamic Host Configuration Protocol version 6 (DHCPv6).

DHCPv6 (RFC 3315) describes how a host can acquire an IPv6 address and other configuration options from a server that is available on its local link. DHCPv6 is described as a stateful protocol. In other words, DHCPv6 can operate in a stateless fashion where it provides configuration information to nodes and does not perform address assignments (RFC 3736). In addition, it can operate in a stateful manner, where it assigns IPv6 addresses and configuration information to hosts that request it.

As in IPv4 DHCP, DHCPv6 is susceptible to rogue server attacks. In other words, if DHCPv6 is used to provide IPv6 addresses to the hosts, an attacker that managed to insert a rogue DHCPv6 server in the link can potentially assign addresses and configuration options to the link hosts. In turn, the attacker can deploy man-in-the-middle, traffic interception, or blackhole traffic, similar to those in the stateless address autoconfiguration scenario. Therefore, it is important to use DHCP protections for both IPv4 and IPv6.

DHCPv6 Guard

DHCPv6 Guard is a type of security for IPv6 deployments in an enterprise environment, it provides Layer 2 security to DHCPv6 clients by protecting them against rogue DHCPv6 servers. The basic concept of DHCPv6 Guard is that a Layer 2 device filters DHCPv6 messages meant to DHCPv6 clients, based on a number of different criteria. The basic filtering criterion is, the DHCPv6 server generated packets which are received on non-server ports or from an untrusted server will be dropped by the Layer 2 device.

Various levels of granularity are provided. Following are the policies that are supported:

- Port based filtering using device role (server or client)
- Server or relay agent IPv6 address based filtering
- Advertising IPv6 prefix based filtering
- DHCPv6 packet filtering based on Server Preference checks

The following are DHCPv6 topology samples:

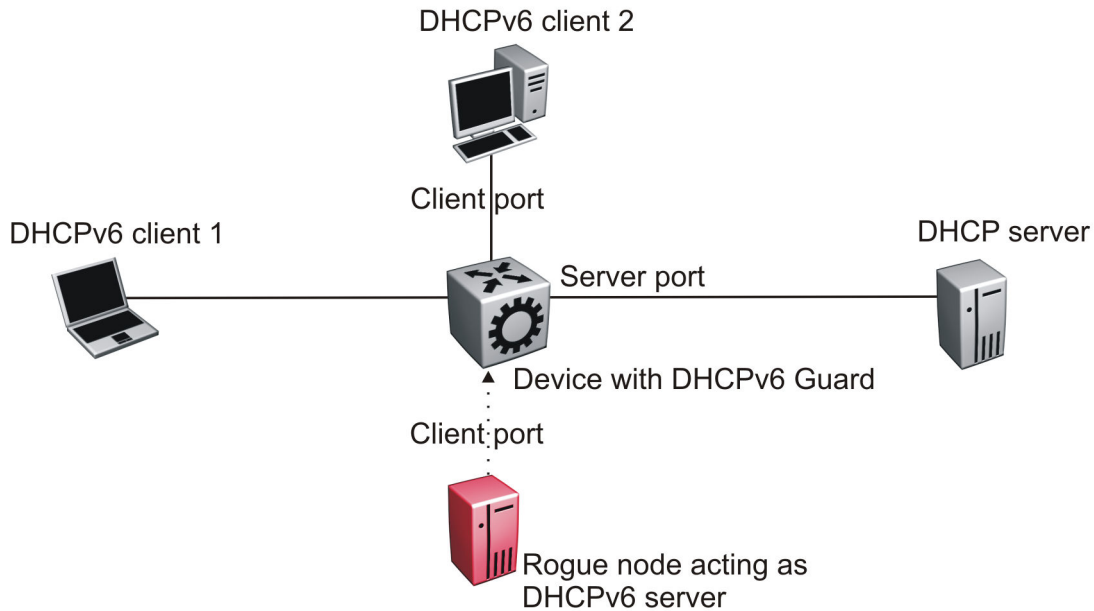

Figure 2: DHCPv6 Topology 1

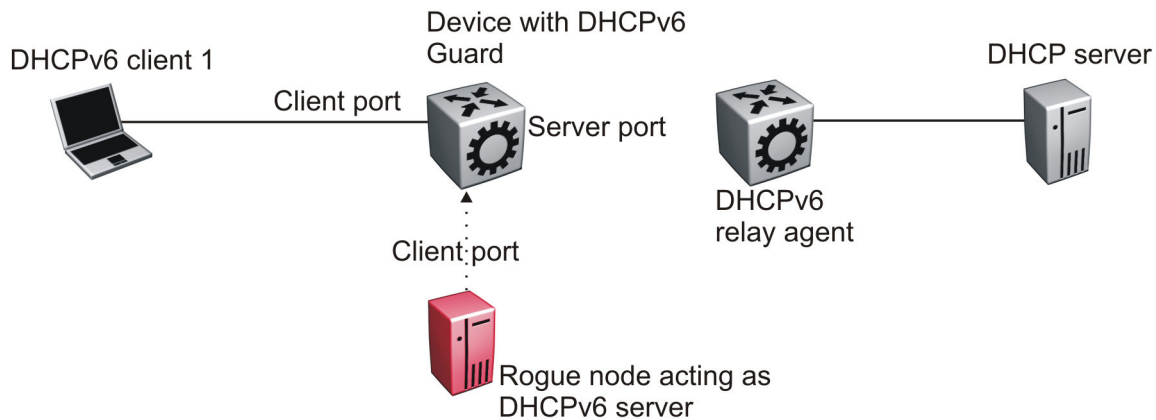

Figure 3: DHCPv6 Topology 2

DHCPv6 Guard policies configuration

You can configure DHCPv6 Guard policies using CLI, SNMP and EDM. The following policies are supported for DHCPv6 Guard.

Port-based filtering using device-role

Port-based filtering using device-role is an interface-level configuration. Only a DHCPv6 server or relay agent can send a DHCPv6 advertisement or reply. By configuring the device-role attached to the port (whether it is a client or server), the rogue server generating DHCPv6 advertisement or reply packets can be blocked if these packets are received on a port configured as a client. Device-role can be applied only on port, and not on MLT, SMLT, or VLAN. If you configure device-role on an MLT, SMLT, or VLAN, you must configure same device-role on all the MLT, SMLT, or VLAN member ports.

In DHCPv6 Guard Topology 1, only DHCPv6 server packets (that is, advertisement, reply) received on a port configured as a Server port accept the packets and process them for security validation and forwarding. The Client port drops the packets if it receives packets generated from a DHCPv6 rogue server.

Server or relay agent IPv6 address based filtering

Server or relay agent IPv6 address-based filtering enables the verification of the advertised DHCPv6 server and relay address in messages with the configured authorized server access list. In DHCPv6 Guard Topology 1 and Topology 2, you can configure the access list to accept DHCPv6 server packets from a specific Source IPv6 address such as a DHCPv6 server or DHCPv6 relay IPv6 address.

Advertising IPv6 prefix-based filtering

Advertising IPv6 prefix-based filtering enables verification of the advertised prefixes in DHCPv6 reply messages with the configured authorized prefix list.

Server preference-based filtering

Server preference-based filtering enables verification by checking if the advertised preference (in preference option) is greater than or less than the specified limit.

RA Guard

IPv6 hosts can configure themselves automatically when connected to a routed IPv6 network through ICMPv6 router discovery messages. When the host is connected to the network for the first time, it sends a link-local router solicitation multicast request for its configuration parameters. If the host is configured correctly, routers respond to the request with a Router Advertisement (RA) packet. The RA packet contains network-layer configuration parameters.

In addition to filtering RAs, RA Guard introduces the concept of router authorization proxy. Instead of each node on the link analyzing RAs and making an individual decision, a legitimate *node-in-the-middle* performs the analysis on behalf of all other nodes on the link.

Stateless and statefull RA Guard functions are available. The switch supports only the stateless RA Guard function.

Stateless RA Guard examines incoming RAs and decides whether to forward or block them based on the information found in the message or in the Layer 2 device configuration. The following list identifies the typical information available in the received frames that are used for RA validation:

- Port on which the frame is received
- Source IPv6 address
- Prefix list which RA carries
- Link-Layer address of the sender

After the Layer 2 device successfully validates the RA packet content against the configuration, the RA is forwarded to its destination, whether unicast or multicast. If the validation fails, the RA is dropped at the Layer 2 device.

RA Guard policies description

This section describes the RA Guard policies. The following policies are supported for RA Guard:

- Port-based filtering using device role (host or router)
- Source IPv6 based filtering
- Advertised IPv6 prefix-based filtering
- Source MAC address-based filtering
- RA packet for managed address configuration flag validation
- RA packet for hop count limit validation
- RA packet for Router Preference validation

Port-based filtering using device-role

This configuration is an interface-level configuration. According to Neighbor Discovery (ND) RFC 4861, only the IPv6 router can generate the RA packets. By configuring the device-role attached to the port whether it is a host or router, the rogue host which is generating RA packets can be blocked. Device-role can be applied only on a port, and not on an MLT, SMLT, or VLAN. If you configure device-role on an MLT, SMLT, or VLAN, you must configure the same device-role on all the MLT, SMLT, or VLAN member ports.

In the following topology, the switch is connected to a Layer 3 router and three hosts. Because the router is directly connected to port 1/2, the device-role of the port 1/2 is configured in Router mode. The other hosts are connected to ports 1/3, 1/4, and 1/5, and the device-role of ports 1/3, 1/4, and 1/5 are configured in Host Mode.

The host connected to the port 1/4 is a rogue host and if it is trying to send RA packets, then the switch drops those RA packets received on the interface 1/4 as the device-role of this port is Host Mode.

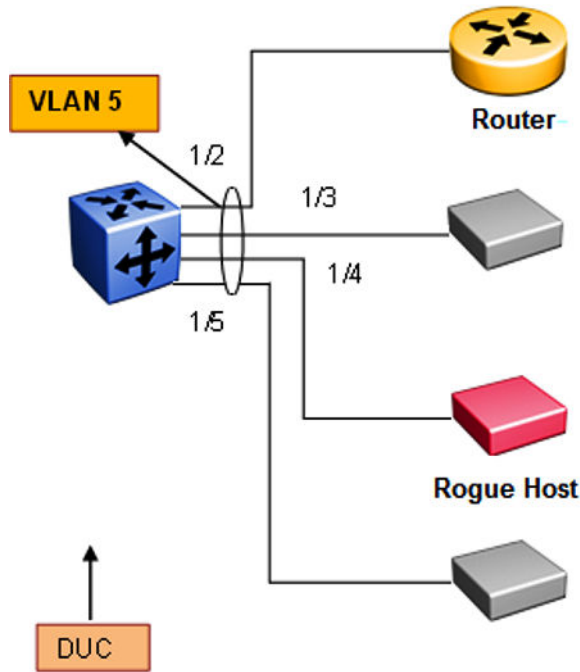

Figure 4: RA Guard Topology1

IPv6 source address based filtering

An IPv6 source address based filtering policy enables the source IPv6 address verification of the RA packets against the configured RA source IPv6 list.

The following figure shows the RA packet format. RA Guard policy verifies the IPv6 source address (SrcIP) in the IPv6 Header against the configured RA source IPv6 list.



Figure 5: IPv6 ICMP RA data packet online

Advertised IPv6 prefix-based filtering

Advertised IPv6 prefix-based filtering enables verification of the advertised prefixes in inspected messages against the configured RA prefix list.

The following figure illustrates the IPv6 ICMP RA data packet outline. This RA Guard policy verifies the RA (Prefix Information) in ICMPv6 data against the configured RA prefix list.



Figure 6: IPv6 ICMP RA data packet outline

Source MAC address-based filtering

Source MAC address-based filtering enables the source MAC address of the RA packets verification against the configured authorized MAC list.

The following figure illustrates the IPv6 Ethernet packet. This RA Guard policy verifies the received RA packets source MAC address against the configured authorized MAC access list.

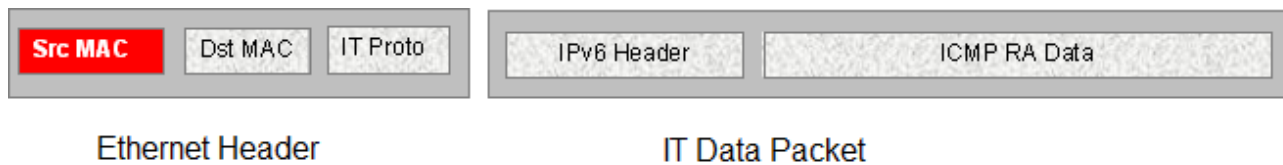

Figure 7: IPv6 Ethernet packet

RA packet for managed address configuration flag validation

In the RA packets, there is an “M” flag (managed address configuration flag) that can be configured to indicate that the address assignments are available through DHCPv6. This means that DHCPv6 takes care of the interface address assignment in that LAN segment. If a filtering policy is enabled, then all the RA packets without an “M” flag are dropped. By default, this validation is not performed.

The following figure illustrates IPv6 ICMP RA data packet outline for managed address configuration.



Figure 8: IPv6 ICMP RA data packet outline

RA packet for hop count limit validation

RA packet for hop count limit validation policy verifies the advertised RA message if the hop count limit is within the configured hop count limit. If the received hop count limit is not within the configured limit, then those RA packets are dropped.

The following figure illustrates IPv6 ICMP RA data packet outline for hop count limit validation.



Figure 9: IPv6 ICMP RA data packet outline

RA packet for router preference validation

The RA packet contains the Router Preference as part of the flags field. This can be high, medium, or low. This filtering policy option verifies if the advertised default router preference parameter value is lower than or equal to a specified limit.

The following figure illustrates IPv6 ICMP RA data packet outline for router preference validation.

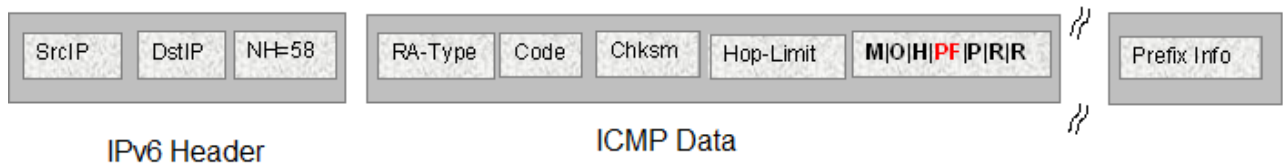

Figure 10: IPv6 ICMP RA data packet outline for router preference validation

Capturing and verifying FHS specific packets against the configured policies

First Hop Security filters can be installed only if FHS is enabled globally. The DHCPv6 Guard or RA Guard filters are created as a part of First Hop Security filter with port bit mask “0”.

The following list identifies the high-level tasks to capture DHCPv6 packets received on a physical port:

1. Enable FHS globally.
2. Enable DHCPv6 Guard or RA Guard globally.
3. Create a DHCPv6 Guard or an RA Guard policy.
4. Configure RA Guard or DHCPv6 Guard device role on the port.
5. Attach DHCPv6 Guard and/or RA Guard policy to a physical port if needed.

On configuring RA Guard or DHCPv6 Guard device role on the port, the appropriate port bitmask for that port will be updated in the data path filter.

The RA or DHCPv6 sever initiated packets received on trusted ports (router or server ports) will be sent to the local CPU for further validations. If these packets pass the RA Guard and DHCPv6 Guard validation, they will be forwarded towards the intended host or DHCPv6 client; if not, they will be dropped by the switch.

FHS limitations

The following limitations exist in First Hop Security:

- Fragmented RA and DHCPv6 server initiated packets are dropped on the FHS enabled switch.
- DHCPv6 Guard and RA Guard do not work on devices connected on shared media or on tunneled interfaces.
- DHCPv6 Guard or RA Guard policies are not VLAN or MLT based.
- FHS is not supported on the Out Of Band (OOB) port on the switch.
- Packets received on FHS ports with more than one extension header, and if they are destined to link-local unicast or link-scope multicast address, are dropped as they cannot be classified as RA or DHCPv6 reply packets.
- The FHS functionality can be bypassed at the first hop switch, if the malicious packets are destined to global address, and have more than one extension header.
- If the FHS rules and IPv6 filters match for a packet, the IPv6 filter has precedence.
- In a Layer 2 VSN, packets are not filtered based on FHS rules. Enable FHS on the required UNI ports to protect the connected devices from FHS attacks.

Guidelines for FHS configuration

Some of the FHS configurations need details on how they work and how they should be used. Following are the details:

1. FHS IPv6 Access lists are generic access/prefix lists which can be applied on IPv6 source address or the prefixes advertised in RA or DHCPv6 messages. If you filter on the basis of a particular IPv6 source address, you must configure the access list entry with complete source address with prefix-length value of 128. If you allow a group of source addresses within a prefix range, you must configure the IPv6 ACL entry with an appropriate prefix length and attach this IPv6 ACL to the appropriate match parameters in RA Guard or DHCPv6 Guard policies.

If you filter a particular prefix, you must configure an IPv6 access list entry with appropriate prefix and prefix-lengths. To filter based on prefix, prefix-lengths should be less than 128.

Following is an example of IPv6 access list entry:

```
ipv6 fhs ipv6-access-list match_src_allow
fe80:0:0:0:0:ff:fe00:113/128 mode allow
```

Note:

- a. If no IPv6 ACL is attached to an RA Guard or DHCPv6 Guard policy as a source ACL, then IPv6 source address in the incoming RA packets or packets from DHCP server will not be validated, and such packets will not be dropped due to source address validations.
- b. If no IPv6 ACL is attached to an RA Guard or DHCPv6 Guard policy as a prefix ACL, then prefix information in incoming RA packets or packets from DHCP server will not be validated and these packets will not be dropped due to prefix validations.

- c. The FHS access or prefix lists are different from IPv6 prefix lists. For FHS, the switch maintains a separate list (cannot reuse IPv6 prefix lists) as IPv6 prefix lists do not have any action associated with them, whereas FHS has an action associated with each ACL entry.
2. When an IPv6 ACL is attached to an RA Guard or DHCPv6 Guard policy and the address or prefix in the incoming RA Guard or DHCPv6 server packets received on port to which this RA Guard or DHCPv6 Guard policy is attached does not match any of the entries in that IPv6 ACL, the packet will be dropped by default. If you want to change this behavior to default (allow, for IPv6 ACLs), you can add an entry that matches all the packets and set the action as allow. To do this, use the following command:

```
ipv6 fhs ipv6-access-list no_match_src_def_allow 0:0:0:0:0:0:0:0/0 mode allow
```
3. IPv6 ACL entries with conflicting prefixes within an IPv6 ACLs are not allowed, and such configuration will fail with appropriate error message. Conflicting entries can be present in two or more different IPv6 ACLs.
4. The entries within an IPv6 ACL will be sorted in increasing order of IPv6 prefixes. If there are two entries with same prefix address within an ACL, then such entries will be ordered with increasing value of their prefix-lengths.
5. MAC ACL entries are ordered in the increasing order of MAC addresses within a MAC ACL. If none of the entries in the MAC ACL match the source MAC address of RA packet, then the packet will be dropped by default. If no MAC ACL is attached to an RA Guard policy, then the source MAC address of RA packets is not validated.
6. When matching for a prefix using IPv6 ACL entry, if you advertise a prefix with matching prefix but prefix-length lesser than configured prefix-length, then the packet has to be considered as no match and prefix matching process has to continue with remaining IPv6 ACL entries in that ACL.

The rationale behind this functionality is to avoid wrong configuration of access side devices. This functionality safeguards the devices in an access network if a wrongly configured IPv6 prefix is advertised or a malicious user is sending invalid (wrong) prefixes. For example, consider the following scenario:

Configure the prefix in ACL entry (without ge and le values): `ipv6 fhs ipv6-access-list ipv6_acl_entry_1 2000:0123:4567:89ab::/64 mode allow`

Advertise the prefix in RA packet: `2001:0123:4567:89ab::/48`

This advertised prefix matches the configured IPv6 ACL entry and without this prefix-length check functionality, the packet is allowed to pass through. But, actually it is configuring all access devices in that network with wrong IPv6 configurations in different IPv6 network (`2001:0123:4567::/48`)

With prefix-length check functionality (explained above), this configuration is not allowed as advertised prefix length is not equal to configured prefix length. So, the wrong configurations of access devices is avoided.

7. Importance of “ge” and “le” parameters in an IPv6 ACL entry:

A user can optionally configure “ge” (greater than or equal to) and “le” (lesser than or equal to) parameters while configuring an IPv6 ACL entry. If the prefix advertised in a packet matches the configured prefix in an IPv6 ACL entry, and “ge” and “le” values are configured (not default) for that IPv6 ACL entry:

- The packet will be allowed to go through only if the prefix-length in the packet is within the range of configured “ge” and “le” values.
- If prefix lengths in the packet are not within the configured range of “ge” and “le” values (non-default values), then the packets would be considered as no match for that IPv6 ACL entry and search for matching IPv6 ACL entry continues within that IPv6 ACL.
- If no ge and le values are configured, those values by default are set to configured prefix length in that IPv6 ACL entry.
- ge and le values are allowed only if they are greater than configured prefix.
- When both are configured (not default values), ge value should always be smaller than le value.

These configurations provide more control over the advertised prefixes in RA or DHCPv6 packets.

8. As “ge” and “le” values are valid only for advertised prefixes, they will not be applied to IPv6 addresses, which are not prefixes. For such addresses, prefix match is considered as match for that IPv6 ACL entry and the corresponding action of that ACL entry is applied on that packet. “ge” and “le” configurations are irrelevant for the following:

- IPv6 source address in RA packet
- IPv6 source address in packets from DHCPv6 server (like DHCPv6 advertise, DHCPv6 reply)
- IPv6 address (temporary or non-temporary) advertised in packets from DHCPv6 server. For example, IPv6 addresses advertised in IANA option of DHCPv6 reply packets

9. Order of packet validations:

In RA or DHCPv6 packets received at the CP for FHS processing, the following order of processing is carried out:

- a. Packet parsing
- b. Checking for presence of IPv6 fragment header
- c. Checking if packets are RA packets or DHCPv6 packets from server (Advertise, Reply, Reconfigure, Relay-Reply)
- d. Basic validations:
 - Non-Link-Local source IPv6 address (only for RA packets)
 - L4 length validations
 - Checksum validations

e. If an RA Guard or DHCPv6 Guard policy is attached to a port:

- MAC ACL validations (if configured) (Only for RA packets)
- IPv6 source address ACL validation (if configured)
- IPv6 prefix ACL validations (if configured)
- Other packet parameter validations like:
 - Managed config flag (RA)
 - ICMP hop limit (RA)
 - Router preference (RA)
 - Server preference (DHCPv6)

If any of these validations fail or if action associated with a match ACL entry indicates to DROP (or default drop if ACL is attached to corresponding policy but packet does not match any ACL entry in that ACL), then the packets are dropped and corresponding statistics are updated. If all these pass or actions related to all matched ACL entries are PERMIT, then the packet is allowed to go through.

10. Longest prefix match: If a packet matches multiple entries in an ACL, then the action associated with an entry with longest prefix match would be applied on the packet.

11. If a port is configured as untrusted (“host” as device role for RA Guard or “client” as device role for DHCPv6 Guard), all the FHS trusted traffic (RA packets for RA Guard or packets from DHCPv6 server for DHCPv6 Guard) are dropped in data path itself. Also for such drops, statistics are not incremented.

If a port is neither configured as trusted nor untrusted, then the FHS traffic (RA packets or DHCPv6 packets from DHCPv6 server) is switched as if FHS is not present.

12. Creation of FHS port policy mappings:

Until, and unless, any of the FHS parameters are configured on a port, port policy mappings are not created and thus with no port to policy mapping configured, no entries appear while listing port policy mappings using the command `show ipv6 fhs port-policy`.

13. If a RA Guard or DHCPv6 Guard policy is attached to any of the ports, deletion of such policy is not allowed. In the contrary, to delete an RA Guard or DHCPv6 Guard policy, those policies need to be detached from all the ports in the switch. However, modification of an RA Guard or DHCPv6 Guard policy is allowed even if it is attached to ports.

14. If a MAC or IPv6 ACL is attached to an RA Guard or DHCPv6 Guard policy, you cannot delete the ACL itself. You can delete the entries from this policy even if it is attached to any policy. At least one entry needs to exist in a MAC or IPv6 ACL; you cannot delete the last entry in that ACL if that ACL is attached to any RA Guard or DHCPv6 Guard policy. You must detach that ACL from all the policies to delete that ACL. However, you can update the entries in that ACL even if it is attached to a policy.

If a port is configured as trusted (“Server” port for DHCPv6 Guard and “Router” port for RA Guard), then only one can attach a DHCPv6 Guard or RA Guard policy to that port. In the contrary, if any policy is attached to a port, the port role cannot be changed from trusted (“Server” port for DHCPv6 Guard and “Router” port for RA Guard) to other role (“Client” port

for DHCPv6 Guard, “Host” port for RA Guard or “None” for both) until that policy is not detached from port.

DHCP Snooping and Neighbor Discovery inspection

DHCP Snooping

DHCP Snooping is a Layer 2 security feature, that provides network security by filtering untrusted DHCP messages received from the external network causing traffic attacks within the network. DHCP Snooping is based on the concept of trusted versus untrusted switch ports. Switch ports configured as trusted can forward DHCP Replies, and the untrusted switch ports cannot. DHCP Snooping acts like a firewall between untrusted hosts and DHCP servers.

Note:

The switch supports:

- DHCP Snooping for both IPv4 and IPv6.
- Neighbor Discovery (ND) inspection for IPv6.

Security is critically important in an access network because various devices can connect to an access network that may not be administratively controlled by a single administrator. Stateless Address Autoconfiguration (SLAAC) and Duplicate Address Detection (DAD) mechanisms used by IPv6 are more vulnerable to attacks from a malicious user. If any person, intentionally or unintentionally, configures an IP address on the device interface wrongly and advertises that IP address as one’s own address during DAD mechanism initiated by other device, DAD initiated devices cannot assign this address. If a malicious user replies to all the DAD IP addresses as own address, none of the devices in the access network can assign any IP addresses to their interfaces. Thus, DoS attacks can be easily carried out by the malicious user making the entire network unfunctional. In another kind of attack, a malicious user can try to poison the neighbor cache of a host by sending ND packets with bogus MAC address which is learnt by other hosts into their neighbor table. Due to the infiltration of the bogus MAC address in the host’s neighbor table, the packets destined to its neighbor is sent to the bogus MAC address and is eventually dropped or received by an unintended host.

In general, these kinds of attacks are carried out by sending different Neighbor Discovery (ND) packets – either through solicited ND packet exchanges or as a result of unsolicited ND packet exchanges triggered due to an event like the expiry of ND timers. These packets carry interface IP address information and link-layer address information. Other devices use this information to build their neighbor table for forwarding traffic to or through the malicious device. As part of ND inspection mechanism, ND (specifically, NS, NA, and redirect) packets from only trusted hosts are allowed to pass through and the packets from un-trusted hosts are dropped in the switch itself. Other network devices can safely use ND mechanisms for correctly assigning IP address to their interfaces resulting in a smooth traffic flow.

For validating the ND packets, the switch must first learn the trusted information by various mechanisms and store the information in a DHCP binding table. If the switch receives ND packets on an untrusted port, the packets are validated against entries in the DHCP binding table. If the ND packets pass the validation, the packets are forwarded. If the packets fail the validation, they are

dropped in the switch itself. This process avoids invalid NA packets from propagating beyond the access switch.

DHCP Snooping and ND inspection feature protects the network from the following types of attacks:

- **User misconfigurations:** Host assigns an address which should not be used by the recipient device. ND inspection blocks this address in the access switch because binding entry does not exist for that address for that host.
- **DAD spoofing:** Malicious user claims that the address is taken even if it is not.
- **NUD spoofing:** Malicious host responds to NUD NS packets indicating that the address is still reachable via that host even if that neighbor is actually not reachable.
- **ND cache poisoning:** Malicious user sends different (invalid) link-layer addresses for a target IP address causing other hosts in the network to program bogus MAC for a given IP neighbor, as a result of which, the traffic gets black-holed or misused by malicious host.

DHCP binding table

DHCP Snooping builds and maintains a binding table, this binding table contains the MAC address, IP address, lease time, binding type, VLAN number, and port information that correspond to the local untrusted ports of the switch. When the switch receives a DHCPRELEASE or DHCPDECLINE broadcast message, DHCP Snooping performs a lookup of the MAC address in the binding table to determine if the port information in the binding table matches the port on which the message was received. If the port information matches, the DHCP packet is forwarded, otherwise it is dropped.

Trust bindings

A switch enabled with the Neighbor Discovery inspection feature allows NA packets through, if the packets are from a trusted host. To allow or deny Neighbor Advertisement (NA) packets, trust bindings must be established using following methods:

- Configuring the port connected to a device (or host) as trusted.
- Building a DHCP binding table which contains entries from trusted devices (or hosts) only. This DHCP binding table is used for validating NA packets.

This method of trust binding involves 2 processes:

IP address learning (snooping) process

In this process an IP address is learnt through a trusted means and a DHCP binding table is built. The switch supports the DHCP binding table entry learning by:

- Statically configuring the entries
- Dynamically learning by DHCP Snooping packets

NA packet validation (inspection) process

This process uses the DHCP binding table entries which are populated as part of IP address learning process to validate the incoming NA packets.

Once the DHCP binding tables are built, the information gathered using trust binding is used to validate the ND packets. If the ND packets cannot be validated using this information, they are considered as packets received from an un-trusted host and are dropped by the switch.

Restrictions

In addition to the FHS restrictions, DHCP Snooping and ND inspection have the following restrictions:

- Link-local address validation is not supported under ND inspection. Thus, an FHS enabled switch is vulnerable to attackers who try to attack with link-local addresses.
- As a 5-second timer is used to cleanup expired DHCP binding table entries, the expired DHCP binding table entries may remain in the DHCP binding table for up to 5 seconds after they expire.
- If a FHS-enabled switch gets rebooted, all the dynamically-learned binding entries get flushed and those entries need to be re-learned for ND inspection to pass. However, when the switch is rebooted, DHCP clients connected to it do not re-initiate DHCP learning, due to which, the switch cannot learn these assigned IP addresses. As a result, ND inspection fails for these addresses. To overcome this problem either DHCP client must learn the IP address again through DHCP mechanisms or the administrator must add static entries for these addresses.
- For IPv6, DHCP binding table entries learned through DHCP are not removed from the DHCP table on DHCP clients that release these addresses. The administrator must manually remove these entries once the addresses are released.
- A dynamic DHCP binding table entry is learned only using the DHCP mechanism. For other modes of address configuration on the host, a relevant DHCP binding table entry must be configured on the FHS switch so that ND packets from such host are not blocked due to ND inspection processing.
- DHCP Snooping is not supported on:
 - DHCP Relay
 - Etree
 - Extensible Authentication Protocol over LAN (EAPoL)
 - Private VLANs
 - Split Multi-Link Trunking (SMLT)

IP Source Guard

IP Source Guard (IPSG) is a Layer 2 port-to-port feature that works closely with DHCP Snooping. It prevents IP spoofing by allowing only IP addresses obtained using DHCP Snooping. When you enable IPSG on an untrusted port with DHCP Snooping enabled, an IP filter is automatically created or deleted for that port based on the information stored in the corresponding DHCP Snooping binding table entry. When a connecting client receives a valid IP address from the DHCP server, the filter installed on the port allows traffic only from that assigned IP address.

You can configure IPSG on a port using the command line interface (CLI), the Enterprise Device Manager (EDM), or SNMP.

Note:

The switch supports configuration of IP Source Guard for both IPv4 and IPv6 addresses.

The following table shows you how IPSG works with DHCP Snooping.

Table 5: IP Source Guard and DHCP snooping

IP Source Guard configuration state	DHCP snooping configuration state	DHCP snooping Binding Entry action (untrusted ports)	IP Source Guard action
change from disabled to enabled	enabled	creates a binding entry	creates a filter for the IP address using the IP address from the binding table entry
enabled	enabled	creates a binding entry	creates a filter for the IP address using the IP address from the binding table entry
enabled	enabled	deletes a binding entry	deletes the IP filter and installs a default filter to block all IP traffic on the port
enabled	enabled	deletes binding entries when one of the following conditions occur: <ul style="list-style-type: none"> • a DHCP release packet is received • the port link is down • the lease time has expired • the port is removed from the VLAN • the VLAN is deleted • the port is set as trusted • the binding entries are manually deleted 	deletes the corresponding IP filter and installs a default filter to block all IP traffic
change from enabled to disabled	enabled	not applicable	deletes the installed IP filter for the port
disabled	enabled	creates a binding entry	not applicable
disabled	enabled	deletes a binding entry	not applicable

IPSG limitations

- You can enable IP Source Guard (IPSG) only on a port that is DHCP Snooping and Dynamic ARP Inspection untrusted.
- The port must be a member of a VLAN. DHCP Snooping must be enabled globally and on the VLAN. You must also enable Dynamic ARP Inspection on the same VLAN.
- You cannot enable IPSG on MLT, SMLT, DMLT or LAG ports.

- You cannot enable IPSG on a brouter port.
- You cannot enable IPSG on ports that are members of a private VLAN.
- You cannot remove a port that is IPSG enabled from a VLAN. Similarly, you cannot delete a VLAN that has at least one port that is IPSG enabled.
- A maximum of 10 IP addresses are allowed on each IPSG enabled port. Correspondingly, a maximum of 10 IP filters are automatically created for each of those ports. When this number is reached, no more filters are set up and all traffic is dropped.
- On the switch, the total number of IP filters must not exceed 256. This limit includes both IP filters that are automatically created on IPSG ports and the manually created ACLs.

Layer 2 security configuration using the CLI

Use the following sections to help you configure Layer 2 security features and protect the network by mitigating various types of attacks, using the Command Line Interface (CLI).

For IPv4 deployments, configure:

- DHCP Snooping
- Dynamic ARP Inspection
- IP Source Guard for IPv4 addresses

For IPv6 deployments, configure:

- First Hop Security (FHS)

 **Note:**

FHS does not solve all cases of denial of services like blocking flooding of the IPv6 messages.

- DHCP Snooping and IPv6 Neighbor Discovery Inspection
- IP Source Guard for IPv6 addresses

DHCP Snooping configuration using CLI

The following section provides procedures to configure DHCP Snooping using the CLI.

Enabling or disabling DHCP Snooping globally

Use the following procedure to enable DHCP Snooping globally. If DHCP Snooping is globally disabled, the switch forwards DHCP reply packets to all required ports, both trusted or untrusted.

Procedure

1. Enter Global Configuration mode:

```
enable
```

- ```
configure terminal
```
2. Enable DHCP Snooping globally:
 

```
ip dhcp-snooping enable
```
  3. Disable DHCP Snooping globally:
 

```
no ip dhcp-snooping enable
```

### Example

```
Switch:1>enable
Switch:1#configure terminal
Switch:1(config)#ip dhcp-snooping enable
```

### Variable definitions

Use the data in the following table to use the `ip dhcp-snooping` command.

| Variable | Value                                                                              |
|----------|------------------------------------------------------------------------------------|
| enable   | Enables or disables DHCP Snooping globally. By default, DHCP Snooping is disabled. |

## Enabling or disabling DHCP Snooping on a VLAN

Use the following procedure to configure DHCP Snooping on a specific VLAN. If DHCP Snooping is globally disabled, the switch forwards DHCP reply packets (received on trusted or untrusted ports) to all ports.

If you enable DHCP Snooping globally, the agent determines whether to forward DHCP reply packets based on the DHCP Snooping mode of the VLAN and trusted state of the port.

### \* Note:

You cannot enable DHCP Snooping on Private VLANs (E-Tree) and SPBM B-VLANs.

### Before you begin

You must enable DHCP Snooping globally.

### Procedure

1. Enter VLAN Interface Configuration mode:
 

```
enable
```

```
configure terminal
```

```
interface vlan <1-4059>
```
2. Enable DHCP Snooping on the VLAN:
 

```
ip dhcp-snooping enable
```
3. Disable DHCP Snooping on the VLAN:
 

```
no ip dhcp-snooping enable
```

## Example

```
Switch:1>enable
Switch:1#configure terminal
Switch:1(config)#interface vlan 5
Switch:1(config-if)#ip dhcp-snooping enable
```

## Variable definitions

Use the data in the following table to use the `ip dhcp-snooping` command.

| Variable | Value                                                    |
|----------|----------------------------------------------------------|
| enable   | Enables or disables DHCP Snooping on the specified VLAN. |

## Configuring trusted and untrusted ports

Use the following procedure to set the trust factor associated with a port for DHCP Snooping. By default, the trust factor is set to untrusted.

### \* Note:

For ports that are members of an MLT, DHCP Snooping must be configured using the MLT configuration mode.

### Before you begin

You must enable DHCP Snooping globally.

### Procedure

1. Enter Interface Configuration mode:

```
enable

configure terminal

interface GigabitEthernet {slot/port[/sub-port] [-slot/port[/sub-port]] [, ...]} or interface mlt <1-512>
```

### \* Note:

If your platform supports channelization and the port is channelized, you must also specify the sub-port in the format slot/port/sub-port.

2. Set the trust factor for the port:

```
ip dhcp-snooping <trusted|untrusted>
```

## Example

```
Switch:1>enable
Switch:1#configure terminal
Switch:1(config)#interface gigabitEthernet 1/2
Switch:1(config-if)#ip dhcp-snooping trusted
```

## Variable definitions

Use the data in the following table to use the `ip dhcp-snooping` command.

| Variable            | Value                                                     |
|---------------------|-----------------------------------------------------------|
| <trusted untrusted> | Specifies the trust factor of the port for DHCP Snooping. |

## Displaying DHCP Snooping global configuration

Use the following procedure to display the global status of DHCP Snooping configuration.

### Procedure

1. Log on to the switch to enter User EXEC mode.
2. Display the global configuration:

```
show ip dhcp-snooping
```

### Example

```
Switch:1>show ip dhcp-snooping
```

```
=====
 Dhcp Snooping General Info
=====
Dhcp Snooping : Enabled
=====
```

## Displaying DHCP Snooping interface information

Use the following procedure to view the DHCP Snooping interface information.

### Procedure

1. Log on to the switch to enter User EXEC mode.
2. Display DHCP Snooping brouter port information:

```
show ip dhcp-snooping interface [gigabitEthernet [{slot/port[/sub-
port] [-slot/port[/sub-port]] [,...]} [vrf WORD<1-16> | vrfids
WORD<0-512>] | <1-4059> [{slot/port[/sub-port] [-slot/port[/sub-
port]] [,...]} [vrf WORD<1-16> | vrfids WORD<0-512>] | vrf
WORD<1-16> | vrfids WORD<0-512>] | vrf WORD<1-16> | vrfids
WORD<0-512>]]
```

3. Display DHCP Snooping VLAN information:

```
show ip dhcp-snooping vlan <1-4059>
```

4. Display DHCP Snooping information for specific VRF name:

```
show ip dhcp-snooping vrf WORD<1-16>
```

5. Display DHCP Snooping information for specific VRF ID:

```
show ip dhcp-snooping vrfids WORD<0-512>
```

### Example

```
Switch:1>show ip dhcp-snooping interface gigabitEthernet
```

```
=====
 Dhcp Snooping Interface Info
=====
```

```
=====
```

| PORT<br>NUM | PORT<br>CLASS | TRUNK<br>ID |
|-------------|---------------|-------------|
| 1/1         | UNTRUSTED     | none        |
| 1/2         | UNTRUSTED     | none        |
| 2/1         | UNTRUSTED     | none        |
| 2/2         | UNTRUSTED     | none        |
| 2/3         | UNTRUSTED     | none        |
| 2/4         | UNTRUSTED     | none        |
| 2/5         | UNTRUSTED     | none        |
| 2/6         | UNTRUSTED     | none        |
| 2/7         | UNTRUSTED     | none        |
| 2/8         | UNTRUSTED     | none        |
| 2/9         | UNTRUSTED     | none        |
| 2/10        | UNTRUSTED     | none        |
| 2/11        | UNTRUSTED     | none        |
| 2/12        | UNTRUSTED     | none        |
| 2/13        | UNTRUSTED     | none        |
| 2/14        | UNTRUSTED     | none        |

```

```

All 16 out of 16 Total Num of Dhcp Snooping entries displayed

Switch:1>show ip dhcp-snooping vlan

```
=====
```

Dhcp Snooping Vlan Info

```
=====
```

| VLAN<br>ID | VRF<br>NAME  | ENABLE |
|------------|--------------|--------|
| 1          | GlobalRouter | false  |
| 10         | GlobalRouter | false  |
| 4051       | GlobalRouter | false  |
| 4052       | GlobalRouter | false  |

```

```

All 4 out of 4 Total Num of Dhcp Snooping entries displayed

Switch:1>show ip dhcp-snooping binding vrfids 0

```
=====
```

DHCP Snooping Binding Table

```
=====
```

| MAC<br>ADDRESS    | IP<br>ADDRESS | PORT<br>NUM | VLAN<br>ID | VRF<br>NAME  | LEASE<br>TIME | EXPIRY<br>TIME | ENTRY<br>TYPE |
|-------------------|---------------|-------------|------------|--------------|---------------|----------------|---------------|
| 36:63:0e:73:03:fe | 192.0.2.8     | 2/10/2      | 200        | GlobalRouter | 86400         | 83700          | Learned       |
| 36:63:0e:73:03:ff | 192.0.2.9     | 2/10/2      | 200        | GlobalRouter | 86400         | 83700          | Learned       |

Static entries : 0  
Learned entries : 2  
Total entries : 2

```

```

All 2 out of 2 Total DHCP Snooping binding entries displayed

Switch:1>show ip dhcp-snooping binding vrf vrf100

```
=====
```

DHCP Snooping Binding Table

```
=====
```

| MAC<br>ADDRESS    | IP<br>ADDRESS | PORT<br>NUM | VLAN<br>ID | VRF<br>NAME | LEASE<br>TIME | EXPIRY<br>TIME | ENTRY<br>TYPE |
|-------------------|---------------|-------------|------------|-------------|---------------|----------------|---------------|
| 00:00:00:00:01:01 | 192.0.2.11    | 2/30        | 100        | vrf100      | Infinite      | none           | Static        |

Static entries : 1  
Learned entries : 0  
Total entries : 1

```

```

All 1 out of 3 Total DHCP Snooping binding entries displayed

## Adding static entries to DHCP Snooping binding table

Use the following procedure to add devices with a specified MAC address to the DHCP Snooping binding table.

### Procedure

1. Enter Global Configuration mode:

```
enable
configure terminal
```

2. Add the static entry to the DHCP Snooping binding table:

```
ip dhcp-snooping binding <1-4059> 0x00:0x00:0x00:0x00:0x00:0x00 ip
{A.B.C.D} port {slot/port[sub-port]} [expiry <0-2147483646>]
```

### Example

```
Switch:1>enable
Switch:1#configure terminal
Switch:1(config)# ip dhcp-snooping binding 1 00-14-22-01-23-45 ip 10.10.10.01 port 1/2
expiry 2
```

### Variable definitions

Use the data in the following table to use the `ip dhcp-snooping binding` command.

| Variable                                                   | Value                                                        |
|------------------------------------------------------------|--------------------------------------------------------------|
| <1-4059>                                                   | Specifies the VLAN ID.                                       |
| 0x00:0x00:0x00:0x00:0x00:0x00                              | Specifies the MAC address of the DHCP client.                |
| ip {A.B.C.D}                                               | Specifies the IP address of the DHCP client.                 |
| port {slot/port[/sub-port] [-slot/port[/sub-port]] [,...]} | Specifies the switch port to which the DHCP client connects. |
| expiry <0-2147483646>                                      | Specifies the expiry time (in seconds) for the DHCP client.  |

## Clearing entries from DHCP Snooping binding table

Use the following procedure to clear entries (static or dynamic) from the DHCP Snooping binding table.

### Procedure

1. Enter Privileged EXEC mode:

```
enable
```

2. Enter:

```
clear ip dhcp-snooping binding [dynamic|static]
```

### Example

```
Switch:1>enable
Switch:1#clear ip dhcp-snooping binding static
```

## Variable definitions

Use the data in the following table to use the `clear ip dhcp-snooping binding` command.

| Variable | Value                                                        |
|----------|--------------------------------------------------------------|
| static   | Clears static entries from the DHCP Snooping binding table.  |
| dynamic  | Clears dynamic entries from the DHCP Snooping binding table. |

## Displaying DHCP Snooping binding table information

Use the following procedure to display the DHCP Snooping binding table, you can filter the entries displayed based on the type, port, or VLAN.

### Procedure

1. Log on to the switch to enter User EXEC mode.

2. Display all binding entries:

```
show ip dhcp-snooping binding
```

3. Display binding entries based on the MAC address or IP address:

```
show ip dhcp-snooping binding address
[0x00:0x00:0x00:0x00:0x00:0x00|{A.B.C.D}]
```

4. Display binding entries configured on the ports:

```
show ip dhcp-snooping binding interface [gigabitEthernet{slot/port[/
sub-port] [-slot/port[/sub-port]] [,...]]
```

5. Display binding entries configured on the VLANs:

```
show ip dhcp-snooping binding vlan <1-4059>
```

6. Display binding entries configured on a specific VRF:

```
show ip dhcp-snooping binding vrf WORD<1-16>
```

7. Display binding entries configured on a specific VRF ID:

```
show ip dhcp-snooping binding vrfids WORD<0-512>
```

8. Display a summary of the DHCP Snooping binding table:

```
show ip dhcp-snooping binding summary [<1-4059>] [vrf WORD<1-16>]
[vrfids WORD<0-512>] [{slot/port[/sub-port] [-slot/port[/sub-port]]
[,...]]
```

9. Display binding entries based on the type of entry:

```
show ip dhcp-snooping binding type [dynamic|static]
```

### Example

```
Switch:1>show ip dhcp-snooping binding
```

| DHCP Snooping Binding Table |             |          |         |          |            |             |            |
|-----------------------------|-------------|----------|---------|----------|------------|-------------|------------|
| MAC ADDRESS                 | IP ADDRESS  | PORT NUM | VLAN ID | VRF NAME | LEASE TIME | EXPIRY TIME | ENTRY TYPE |
| 23-74-44-33-15-33           | 192.0.2.40  | 225      | 1       | 13446    | 0          | 0           | Static     |
| ab-22-44-23-22-11           | 192.0.2.56  | 213      | 34      | 52341    | 0          | 0           | Static     |
| bb-22-44-33-af-ab           | 192.0.2.134 | 197      | 234     | 34345    | 0          | 0           | Static     |
| bb-22-44-af-af-ab           | 192.0.2.88  | 197      | 999     | 52342    | 0          | 0           | Static     |
| fe-92-44-33-22-33           | 192.0.2.13  | 211      | 333     | 52343    | 0          | 0           | Static     |
| fe-ab-44-33-22-33           | 192.0.2.45  | 197      | 74      | 52343    | 0          | 0           | Static     |
| -----                       |             |          |         |          |            |             |            |
| Static entries : 6          |             |          |         |          |            |             |            |
| Learned entries : 0         |             |          |         |          |            |             |            |
| Total entries : 6           |             |          |         |          |            |             |            |
| -----                       |             |          |         |          |            |             |            |

## Dynamic ARP Inspection configuration using CLI

The following section provides procedures to configure Dynamic ARP Inspection (DAI) using CLI.

### Enabling or disabling Dynamic ARP Inspection on a VLAN

You must enable DAI separately for each VLAN. When you enable DAI on a specific VLAN, the ARP packets are captured and inspected on that VLAN. DAI is disabled by default.

#### \* Note:

DAI cannot be enabled on Private VLANs (E-Tree) and SPBM B-VLANs.

#### Before you begin

You must enable DHCP Snooping globally.

#### Procedure

1. Enter VLAN Interface Configuration mode:

```
enable
configure terminal
interface vlan <1-4059>
```

2. Enable DAI on the VLAN:

```
ip arp-inspection enable
```

3. Disable DAI on the VLAN:

```
no ip arp-inspection enable
```

#### Example

```
Switch:1>enable
Switch:1#configure terminal
Switch:1(config)#interface vlan 5
Switch:1(config-if)#ip arp-inspection enable
```

#### Variable definitions

Use the data in the following table to use the `ip arp-inspection` command.



| Variable      | Value                                          |
|---------------|------------------------------------------------|
| <i>enable</i> | Enables or disables DAI on the specified VLAN. |

## Configuring trusted and untrusted ports

Use the following procedure to set the trust factor associated with a port for DAI. By default, the trust factor is set to untrusted.

### \* Note:

For ports that are part of an MLT, DAI must be configured using the MLT configuration mode.

### Before you begin

You must enable DHCP Snooping globally.

### Procedure

1. Enter Interface Configuration mode:

```
enable
configure terminal
interface GigabitEthernet {slot/port[/sub-port] [-slot/port[/sub-
port]][, ...]} or interface mlt <1-512>
```

### \* Note:

If your platform supports channelization and the port is channelized, you must also specify the sub-port in the format slot/port/sub-port.

2. Set the trust factor for the port:

```
ip arp-inspection <trusted|untrusted>
```

### Example

```
Switch:1>enable
Switch:1#configure terminal
Switch:1(config)#interface gigabitEthernet 1/2
Switch:1(config-if)#ip arp-inspection trusted
```

### Variable definitions

Use the data in the following table to use the `ip arp-inspection` command.

| Variable                         | Value                                           |
|----------------------------------|-------------------------------------------------|
| <i>&lt;trusted untrusted&gt;</i> | Specifies the trust factor of the port for DAI. |

## Displaying Dynamic ARP Inspection interface information

Use the following procedure to view the DAI interface information.

### Procedure

1. Log on to the switch to enter User EXEC mode.

2. Display DAI brouter port information:

```
show ip arp-inspection interface [gigabitEthernet [{slot/port[/sub-port] [-slot/port[/sub-port]] [,...]} [vrf WORD<1-16> | vrfids WORD<0-512>] | <1-4059> [{slot/port[/sub-port] [-slot/port[/sub-port]] [,...]} [vrf WORD<1-16> | vrfids WORD<0-512>] | vrf WORD<1-16> | vrfids WORD<0-512>]]]
```

3. Display DAI VLAN information:

```
show ip arp-inspection vlan <1-4059>
```

4. Display DAI information for specific VRF name:

```
show ip arp-inspection vrf WORD<1-16>
```

5. Display DAI information for specific VRF ID:

```
show ip arp-inspection vrfids WORD<0-512>
```

**Example**

```
Switch:1>show ip arp-inspection interface gigabitEthernet 1/2
```

```
=====
 Arp Inspection Port Info
=====
```

| PORT<br>NUM | PORT<br>CLASS | TRUNK<br>ID |
|-------------|---------------|-------------|
| 1/2         | UNTRUSTED     | none        |

```

```

All 1 out of 1 Total Num of Arp Inspection entries displayed

```
Switch:1>show ip arp-inspection vlan
```

```
=====
 Arp Inspection Vlan Info
=====
```

| VLAN<br>ID | VRF<br>NAME  | ENABLE |
|------------|--------------|--------|
| 1          | GlobalRouter | false  |
| 2          | GlobalRouter | false  |
| 20         | GlobalRouter | false  |
| 55         | GlobalRouter | true   |

```

```

All 4 out of 4 Total Num of Arp Inspection entries displayed

```
Switch:1>show ip arp-inspection vrfids 5
```

```
=====
 Arp Inspection Vlan Info
=====
```

| VLAN<br>ID | VRF<br>NAME | ENABLE |
|------------|-------------|--------|
|------------|-------------|--------|

```

```

```
10 tt true

```

```
Switch:1>show ip arp-inspection vrf TT
```

```
=====
 Arp Inspection Vlan Info
=====
VLAN VRF
ID NAME ENABLE

10 tt true

```

## FHS configuration

Configure IPv6 FHS features to enable IPv6 link security and management over the Layer 2 links.

### Enabling or disabling FHS globally

#### About this task

You must enable First Hop Security globally for RA Guard or DHCPv6 Guard to be operational.

Enabling FHS globally installs the required filters for FHS. Disabling FHS, uninstalls these filters. By default, FHS is disabled.

#### Procedure

1. Enter Global Configuration mode:

```
enable
configure terminal
```

2. Enable First Hop Security globally:

```
ipv6 fhs enable
```

3. Disable First Hop Security globally:

```
no ipv6 fhs enable
```

OR

```
default ipv6 fhs enable
```

### Managing the FHS IPv6 access list

#### About this task

You can create an FHS IPv6 access list or add IPv6 prefixes to an existing IPv6 access list.

#### Procedure

1. Enter Global Configuration mode:

```
enable
```

```
configure terminal
```

2. Create an FHS IPv6 access list or add IPv6 prefixes to an existing IPv6 access list:

```
ipv6 fhs ipv6-access-list [WORD<1-64>] [WORD<0-46>] [ge<0-128>] [le<0-128>] [mode <allow | deny>]
```

3. Delete an FHS IPv6 access list or delete a particular IPv6 prefix from the IPv6 access list:

```
no ipv6 fhs ipv6-access-list [WORD<1-64>] [WORD<0-46>]
```

4. Set the ge/le values and mode of the FHS IPv6 access list to default value:



```
default ipv6 fhs ipv6-access-list [WORD<1-64>] [WORD<0-46>] [ge|le|mode]
```

### Example

```
Switch>enable
Switch#config t
Enter configuration commands, one per line. End with CNTL/Z.
Switch(config)#ipv6 fhs ipv6-access-list ipv6_acl_1 fe80::221:2fff:fe31:5376/64
Switch(config)#
```

### Variable definitions

Use the data in the following table to use the `ipv6 fhs ipv6-access-list` command.

| Variable                         | Description                                                                                                                                                                                                                                                                                                                                                                                                                                                       |
|----------------------------------|-------------------------------------------------------------------------------------------------------------------------------------------------------------------------------------------------------------------------------------------------------------------------------------------------------------------------------------------------------------------------------------------------------------------------------------------------------------------|
| <i>WORD&lt;1-64&gt;</i>          | Specifies the IPv6 access list name.                                                                                                                                                                                                                                                                                                                                                                                                                              |
| <i>WORD&lt;0-46&gt;</i>          | Specifies the IPv6 address or the prefix length to be added to the IPv6 access list.                                                                                                                                                                                                                                                                                                                                                                              |
| <i>ge &lt;0 -128&gt;</i>         | <p>Specifies the minimum value of prefix length advertised in prefix information of RA or DHCPv6 packets.</p> <p>By default, the value is equal to the configured prefix length.</p> <p> <b>Note:</b></p> <p>If you manually configure the value, ensure that it is greater than the configured prefix length. Also ensure, the ge value is always less than the le value.</p> |
| <i>le &lt;0 -128&gt;</i>         | <p>Specifies the maximum value of prefix length advertised in prefix information of RA or DHCPv6 packets.</p> <p>By default, the value is equal to the configured prefix length.</p> <p> <b>Note:</b></p> <p>If you manually configure the value, ensure that it is greater than the configured prefix length.</p>                                                             |
| <i>mode &lt;allow   deny&gt;</i> | <p>Specifies the access mode.</p> <p>By default, the value is allow.</p>                                                                                                                                                                                                                                                                                                                                                                                          |

## Displaying FHS IPv6 access list information

### About this task

Displays the current FHS IPv6 access list information.

### Procedure

1. Enter Privileged EXEC mode:  
enable
2. Display the current FHS IPv6 access list information:  
show ipv6 fhs ipv6-access-list [WORD<1-64>]

### Example

```
Switch:1# show ipv6 fhs ipv6-access-list
=====
 IPv6 FHS Access List Table Info
=====
ACC-LIST-NAME IPV6-PREFIX MASK-RANGE
 MASK FROM TO MODE

v6_acl1 1:0:0:0:0:0:1 64 64 64 Allow
v6_acl2 1:0:0:0:0:0:1 64 64 64 Allow

All 2 out of 2 Total Num of ipv6 access list entries displayed
```

### Job aid

The following table shows the field descriptions for the **show ipv6 fhs ipv6-access-list** command.

| Field            | Description                                                 |
|------------------|-------------------------------------------------------------|
| Access list name | Indicates the IPv6 access list name.                        |
| ipv6_prefix      | Indicates the IPv6 prefix added to the IPv6 access list.    |
| mask_len         | Indicates prefix mask length added to the IPv6 access list. |
| mask_range_from  | Indicates the IPv6 range start mask length.                 |
| mask_range_to    | Indicates the IPv6 range end mask length.                   |
| mode             | Indicates the access mode.                                  |

## Managing the FHS MAC access list

### About this task

You can create an FHS MAC access list or add MAC addresses to an existing MAC access list.

### Procedure

1. Enter Global Configuration mode:

```
enable
```

```
configure terminal
```

2. Create an FHS MAC access list or add MAC addresses to an existing MAC access list:

```
ipv6 fhs mac-access-list WORD<1-64> <0x00:0x00:0x00:0x00:0x00:0x00>
[mode <allow | deny>]
```

3. Delete an FHS MAC access list or delete a particular MAC address from the MAC access list:

```
no ipv6 fhs mac-access-list WORD<1-64>
<0x00:0x00:0x00:0x00:0x00:0x00>
```

4. Set the MAC ACL mode to its default value:

```
default ipv6 fhs mac-access-list WORD<1-64>
<0x00:0x00:0x00:0x00:0x00:0x00> [mode]
```

### Variable definitions

Use the data in the following table to use the `ipv6 fhs mac-access-list` command.

| Variable                                           | Description                                                  |
|----------------------------------------------------|--------------------------------------------------------------|
| <code>WORD&lt;1-64&gt;</code>                      | Specifies the MAC access list name.                          |
| <code>&lt;0x00:0x00:0x00:0x00:0x00:0x00&gt;</code> | Specifies the MAC address to be added or deleted.            |
| <code>mode &lt;allow   deny&gt;</code>             | Specifies the access mode.<br>By default, the value is Allow |

## Displaying FHS MAC access list information

### About this task

Displays the current FHS MAC access list information.

### Procedure

1. Enter Privileged EXEC mode:

```
enable
```

2. Display the current FHS MAC access list information:

```
show ipv6 fhs mac-access-list [WORD<1-64>]
```

### Example

```
Switch#show ipv6 fhs mac-access-list
=====
IPv6 FHS Mac Access List Table Info
=====
ACC-LIST-NAME MAC-ADDRESS ACL-MODE

List2 10:20:30:40:50:60 Allow
 00:11:22:33:44:55 Deny
```

```

All 1 out of 1 Total Num of MAC access list entries displayed

```

### Job aid

The following table shows the field descriptions for the `show ipv6 fhs mac-access-list` command.

| Field         | Description                         |
|---------------|-------------------------------------|
| ACC-LIST-NAME | Indicates the MAC access list name. |
| MAC-ADDRESS   | Indicates the MAC address.          |
| ACL-MODE      | Indicates the ACL mode.             |

## Displaying current FHS configuration

### About this task

Displays the current FHS configuration.

### Procedure

1. Enter Privileged EXEC mode:

```
enable
```

2. Display the current FHS configuration:

```
show ipv6 fhs port-policy {slot/port[/sub-port] [-slot/port[/sub-
port]] [,...]}
```

### Example

```
Switch:1#show ipv6 fhs port-policy
```

```
=====
 IPv6 FHS Port Policy Info
=====
PORT DHCPG-DEVICE-ROLE DHCPG-POLICY RAG-DEVICE-ROLE RAG-POLICY

1/1 Server dhcp_poll Router ra_poll

```

```
All 1 out of 1 Total Num of fhs port policy entries displayed
```

### Job aid

The following table shows the field descriptions for the `show ipv6 fhs port-policy` command.

| Field          | Description                         |
|----------------|-------------------------------------|
| PORT           | Indicates the port number.          |
| DHCPV6G-POLICY | Indicates the DHCPv6 policy name.   |
| RA-POLICY      | Indicates the RA Guard policy name. |

## DHCPv6 Guard policy configuration

DHCPv6 Guard policy blocks DHCPv6 reply and advertisement messages that originate from unauthorized DHCPv6 servers and relay agents that forward DHCPv6 packets from servers to clients.

### Enabling or disabling DHCPv6 Guard globally

#### About this task

Enabling DHCPv6 Guard globally installs filters on the configured interfaces. By default, DHCPv6 Guard is disabled.

#### Procedure

1. Enter Global Configuration mode:  

```
enable
configure terminal
```
2. Enable FHS globally:  

```
ipv6 fhs enable
```
3. Enable DHCPv6 Guard globally:  

```
ipv6 dhcp-guard enable
```
4. Disable DHCPv6 Guard globally:  

```
no ipv6 dhcp-guard enable
```
5. Set DHCPv6 Guard to its default value:  

```
default ipv6 dhcp-guard enable
```

### Managing the DHCPv6 Guard policy

#### About this task

Configure or modify the DHCPv6 Guard policy.

#### Procedure

1. Enter Global Configuration mode:  

```
enable
configure terminal
```
2. Create a DHCPv6 Guard policy:  

```
ipv6 dhcp-guard policy WORD<1-64>
```
3. Delete a DHCPv6 Guard policy:  

```
no ipv6 dhcp-guard policy WORD<1-64>
```



**\* Note:**

You cannot delete a policy that is already attached to a port.

**Variable definitions**

Use the data in the following table to use the `ipv6 dhcp-guard policy` command.

| Variable                      | Description                                                |
|-------------------------------|------------------------------------------------------------|
| <code>WORD&lt;1-64&gt;</code> | Specifies the created or deleted DHCPv6 Guard policy name. |

**Attaching a DHCPv6 Guard policy to a port****About this task**

Applies a DHCPv6 Guard policy to a specific interface.

**Procedure**

1. Enter Interface Configuration mode:

```
enable
configure terminal
interface GigabitEthernet {slot/port[/sub-port] [-slot/port[/sub-port]] [, ...]} or interface vlan <1-4059>
```

**\* Note:**

If your platform supports channelization and the port is channelized, you must also specify the sub-port in the format slot/port/sub-port.

2. Apply a DHCPv6 Guard policy.

```
ipv6 fhs dhcp-guard attach-policy WORD<1-64>
```

3. Detach a DHCPv6 Guard policy from an interface.

```
no ipv6 fhs dhcp-guard attach-policy
OR
default ipv6 dhcp-guard attach-policy
```

4. Enable device role verification attached to the port. By default, router is selected.

```
ipv6 fhs dhcp-guard device-role {client|server} attach-policy
WORD<1-64>
```

**\* Note:**

A DHCPv6 Guard policy can be attached to a port only if the device-role configured on that port is 'server'.

## Variable definitions

Use the data in the following table to use the `ipv6 fhs dhcp-guard attach-policy` and `ipv6 fhs dhcp-guard device-role` command.

| Variable                       | Description                                                             |
|--------------------------------|-------------------------------------------------------------------------|
| <code>WORD&lt;1-64&gt;</code>  | Specify the name of the DHCPv6 Guard policy to be attached or detached. |
| <code>{client   server}</code> | Sets the DHCPv6 Guard device role as client or server.                  |

## Configuring DHCPv6 Guard in dhcp-guard mode

### About this task

Configures DHCPv6 Guard under dhcp-guard mode.

### Procedure

1. Enter DHCPv6 Guard Configuration mode.
 

```
enable
configure terminal
ipv6 fhs dhcp-guard policy WORD<1-64>
```
2. Specify IPv6 access list to verify IPv6 source address of DHCPv6 packets..
 

```
match server access-list <ipv6-access-list-name>
```
3. Remove DHCPv6 Guard filtering for the sender's IPv6 addresses.
 

```
no match server access-list
```

OR

```
default match server access-list
```
4. Specify IPv6 prefix list to verify advertised prefixes.
 

```
match reply prefix-list <ipv6-prefix-list-name>
```
5. Remove DHCPv6 Guard filtering for advertised prefixes.
 

```
no match reply prefix-list
```

OR

```
default match reply prefix-list
```
6. Specify the minimum limit for verification of the advertised preference.
 

```
preference min-limit <0-255>
```
7. Set the minimum limit for verification of the advertised preference to its default value.
 

```
default preference min-limit
```
8. Specify the maximum limit for verification of the advertised preference.

```
preference max-limit <0-255>
```

- Set the maximum limit for verification of the advertised preference to its default value.

```
default preference max-limit
```

## Variable definitions

Use the data in the following table to use the `dhcp-guard` configuration mode commands.

| Variable                                            | Description                                                                                                                                                                                                                                                                                                                                                                                                                                                                                                                                                                                    |
|-----------------------------------------------------|------------------------------------------------------------------------------------------------------------------------------------------------------------------------------------------------------------------------------------------------------------------------------------------------------------------------------------------------------------------------------------------------------------------------------------------------------------------------------------------------------------------------------------------------------------------------------------------------|
| match server access-list<br><ipv6-access-list-name> | <p>Enables verification of the sender's IPv6 address in inspected messages from the configured authorized device source access list specified.</p> <p><b>Note:</b></p> <p>If the access-list is not attached, the IPv6 source address in DHCPv6 packet is not validated.</p> <p>If the list is attached and it does not match any entries in IPv6 access list, the switch drops the DHCPv6 packet. If you wish to change this behavior, add an entry with IPv6 prefix "0::0/0" with the Allow option, which changes the default drop to default Allow.</p>                                     |
| { no   default } match server access-list           | Removes the sender's IPv6 address based DHCPv6 Guard filtering.                                                                                                                                                                                                                                                                                                                                                                                                                                                                                                                                |
| match reply prefix-list <ipv6-prefix-list-name>     | <p>Enables verification of the advertised prefixes in DHCPv6 reply messages from the configured authorized prefix list. If prefix-list is not configured, this check is bypassed.</p> <p><b>Note:</b></p> <p>If the access-list is not attached, the inspection does not occur.</p> <p>If the list is attached and advertised IPv6 address does not match any IPv6 prefixes in the list, the switch drops the DHCPv6 packet. If you wish to change this behavior, add an IPv6 access list entry with prefix 0::0/0 with the Allow option, which changes the default drop to default Allow.</p> |
| { no   default } match reply prefix-list            | Removes the advertised prefix-based DHCPv6 Guard filtering.                                                                                                                                                                                                                                                                                                                                                                                                                                                                                                                                    |
| preference min-limit<0-255>                         | <p>Enables validation of advertised preference (in preference option) to check if it is greater than the specified limit. If preference is not specified, this field in the packet is not validated.</p> <p>While changing the preference limit, ensure the maximum limit is greater than the minimum limit.</p>                                                                                                                                                                                                                                                                               |
| default preference min-limit                        | <p>Sets the specified limit to its default value.</p> <p>By default, the value is 0.</p>                                                                                                                                                                                                                                                                                                                                                                                                                                                                                                       |
| preference max-limit<0-255>                         | Enables validation of advertised preference (in preference option) to check if it is less than the specified limit. If preference is not specified, this field in the packet is not validated.                                                                                                                                                                                                                                                                                                                                                                                                 |

*Table continues...*

| Variable                     | Description                                                                                                                                                                                                   |
|------------------------------|---------------------------------------------------------------------------------------------------------------------------------------------------------------------------------------------------------------|
|                              | <p> <b>Note:</b></p> <p>The preference value in the packet is not validated if both minimum and maximum values are zero.</p> |
| default preference max-limit | <p>Sets the specified limit to its default value.</p> <p>By default, the value is 0.</p>                                                                                                                      |

## Displaying DHCPv6 Guard policy

### About this task

Displays DHCPv6 Guard policy information for all the configured DHCPv6 Guard policies or a particular policy.

### Procedure

1. Log on to the switch to enter User EXEC mode.
2. Display DHCPv6 Guard policy information:

```
show ipv6 fhs dhcp-guard policy WORD<1-64>
```

### Example

```
Switch:1# show ipv6 fhs dhcp-guard policy
```

```
=====
 IPv6 DHCP Guard Policy Info
=====
POLICY-NAME SERVER-ACC-LIST REPLY-PREF-LIST MIN-RTR-PREF MAX-RTR-PREF

dhcp_pol1 v6_acl1 v6_acl2 0 0

All 1 out of 1 Total Num of dhcp-guard stats entries displayed
```

### Variable definitions

Use the data in the following table to use the `show ipv6 dhcp-guard policy` command.

| Variable                      | Description                                                                                                                                                                                                                                    |
|-------------------------------|------------------------------------------------------------------------------------------------------------------------------------------------------------------------------------------------------------------------------------------------|
| <code>WORD&lt;1-64&gt;</code> | <p>Displays DHCPv6 Guard policy information for all the configured DHCPv6 Guard policies.</p> <p>Policy name is an optional parameter. If policy name is provided, only the DHCPv6 Guard policy of the specified policy-name is displayed.</p> |

### Job aid

The following table shows the field descriptions for the `show ipv6 dhcp-guard policy` command.

| Field           | Description                                                                                                  |
|-----------------|--------------------------------------------------------------------------------------------------------------|
| POLICY-NAME     | Indicates the DHCPv6 Guard policy name.                                                                      |
| SERVER-ACC-LIST | Indicates if the received DHCPv6 server packet source IPv6 addresss matches the configured IPv6 access list. |
| REPLY-PREF-LIST | Indicates if the advertised prefix in received DHCPv6 server packet matches the configured IPv6 access list. |
| MIN-RTR-PREF    | Indicates the advertised router preference minimum limit.                                                    |
| MAX-RTR-PREF    | Indicates the advertised router preference maximum limit.                                                    |

---

## RA Guard configuration

IPv6 RA Guard provides support to the administrator to block or reject unwanted RA Guard messages that arrive at the network switch platform. The routers use Router Advertisements (RAs) to announce themselves on the link. The RA Guard feature analyzes these RAs and filters out bogus RAs sent by unauthorized routers. The RA Guard feature compares configuration information on the Layer 2 device with the information found in the received RA frame. After the Layer 2 device validates the content of the RA packet against the configuration, it forwards the RA to its destination. If the RA packet validation fails, the RA is dropped.

### Enabling or disabling RA Guardd globally

#### About this task

Enables RA Guard globally. By default, RA Guard is disabled.

#### Procedure

1. Enter Global Configuration mode:
 

```
enable
configure terminal
```
2. Enable FHS globally:
 

```
ipv6 fhs enable
```
3. Enable RA Guard globally:
 

```
ipv6 fhs ra-guard enable
```
4. Disable RA Guard globally:
 

```
no ipv6 fhs ra-guard enable
```
5. Set the RA Guard to its default value:
 

```
default ipv6 fhs ra-guard enable
```

## Managing the RA Guard policy

### About this task

Configure or modify RA Guard policy. This command also enables the RA Guard configuration mode.

### Procedure

1. Enter Global Configuration mode:

```
enable
configure terminal
```

2. Create the RA Guard policy:

```
ipv6 fhs ra-guard policy WORD<1-64>
```

3. Delete the RA Guard policy:

```
no ipv6 fhs ra-guard policy WORD<1-64>
```

#### \* Note:

You cannot delete a policy that is attached to a port.

### Variable definitions

Use the data in the following table to use the `ipv6 fhs ra-guard policy` command.

| Variable                      | Description                                                                                                               |
|-------------------------------|---------------------------------------------------------------------------------------------------------------------------|
| <code>WORD&lt;1-64&gt;</code> | Specifies the name of the RA Guard policy to be created or deleted.<br><br>This is a mandatory parameter in this command. |

## Configuring RA Guard on an interface

### About this task

Attaches or detaches a RA Guard policy on the specific interface.

### Procedure

1. Enter GigabitEthernet Interface Configuration mode:

```
enable
configure terminal
interface GigabitEthernet {slot/port[/sub-port] [-slot/port[/sub-port]][,...]}
```

#### \* Note:

If your platform supports channelization and the port is channelized, you must also specify the sub-port in the format slot/port/sub-port.

2. Apply a RA Guard policy.

```
ipv6 fhs ra-guard attach-policy WORD<1-64>
```

**\* Note:**

RA Guard device-role on the port has to be configured as 'router' before attaching any RA Guard policy to the port. If device-role on the port is not 'router', this command will fail with an appropriate error message.

3. Detach a RA Guard policy from an interface.

```
no ipv6 fhs ra-guard attach-policy
```

OR

```
default ipv6 fhs ra-guard attach-policy
```

4. Enable device role verification attached to the port.

```
ipv6 fhs ra-guard device-role {router|host} attach-policy WORD<1-64>
```

**\* Note:**

A DHCPv6 Guard policy can be attached to a port only if the device-role configured on that port is 'server'.

## Variable definitions

Use the data in the following table to use the `ipv6 fhs ra-guard attach-policy` and `ipv6 fhs ra-guard device-role` command.

| Variable                      | Description                                                           |
|-------------------------------|-----------------------------------------------------------------------|
| <code>WORD&lt;1-64&gt;</code> | Specifies the name of the RA Guard policy to be attached or detached. |
| <code>{host   router}</code>  | Sets the RA Guard device role as host or router.                      |

## Configuring RA Guard in RA Guard mode

### About this task

Configures RA Guard in the RA Guard configuration mode.

### Procedure

1. Enter RA Guard Configuration mode.

```
enable
```

```
configure terminal
```

```
ipv6 fhs ra-guard policy WORD<1-64>
```

2. Configure the filter to match the IPv6 prefixes advertised in RA packets.

```
match ra-prefix-list WORD<1-64>
```

3. Remove RA Guard filtering for the advertised prefixes.

```
no match ra-prefix-list
```

OR

```
default match ra-prefix-list
```

4. Configure the filter to match the source MAC address of RA packets.

```
match ra-macaddr-list WORD<1-64>
```

5. Remove the source MAC address-based RA Guard filtering.

```
no match ra-macaddr-list
```

OR

```
default match ra-macaddr-list
```

6. Configure the filter to match source IPv6 address of RA packets.

```
match ra-srcaddr-list WORD<1-64>
```

7. Remove the source IPv6 address based RA Guard filtering.

```
no match ra-srcaddr-list
```

OR

```
default match ra-srcaddr-list
```

8. Enable managed address configuration flag verification in the advertised RA packet.

```
managed-config-flag <none | on | off>
```

9. Enable advertised hop count limit verification.

```
hop-limit {maximum | minimum} <0-255>
```

10. Enable the advertised default router-preference parameter value verification.

```
router-preference maximum {none | high | low | medium}
```

## Variable definitions

Use the data in the following table to configure RA Guard policy.

| Variable                        | Description                                                                                                                                                                                                                                                                                                                                                                                                                                                                                    |
|---------------------------------|------------------------------------------------------------------------------------------------------------------------------------------------------------------------------------------------------------------------------------------------------------------------------------------------------------------------------------------------------------------------------------------------------------------------------------------------------------------------------------------------|
| match ra-prefix-list WORD<1-64> | <p>Verifies the advertised prefixes in RA packets against the configured authorized prefix list.</p> <p> <b>Note:</b></p> <p>RA packet's sender IPv6 address is not validated if no IPv6 source access list is attached to the RA Guard policy.</p> <p>If the list is attached and if RA packet's sender IPv6 address does not match any entry in that IPv6 prefix list, then the RA packet is dropped.</p> |

*Table continues...*



| Variable                              | Description                                                                                                                                                                                                                                                                                                                                                                                                      |
|---------------------------------------|------------------------------------------------------------------------------------------------------------------------------------------------------------------------------------------------------------------------------------------------------------------------------------------------------------------------------------------------------------------------------------------------------------------|
|                                       | To change this behavior, add a entry with ipv6 prefix“0::0/0” with Allow option. The default value changes from Drop to Allow.                                                                                                                                                                                                                                                                                   |
| {no   default} match ra-prefix-list   | Removes the advertised prefix-based RA Guard filtering                                                                                                                                                                                                                                                                                                                                                           |
| match ra-macaddr-list WORD<1–64>      | Verifies sender’s source MAC address against the configured mac-access-list.<br><br><p><b>* Note:</b></p> <p>Advertised prefixes in RA packet are not validated if no IPv6 prefix list is attached to the RA Guard policy.</p> <p>If the list is attached and if it does not match any MAC in the list, then the RA packet is dropped.</p>                                                                       |
| {no   default} match ra-macaddr-list  | Removes the source MAC address-based RA Guard filtering for the specified MAC address access list names.                                                                                                                                                                                                                                                                                                         |
| match ra-srcaddr-list WORD<1–64>      | Verifies sender’s source IPV6 address against the configured list.<br><br><p><b>* Note:</b></p> <p>Inspection is not done if the access-list is not attached.</p> <p>If the list is attached and if it does not match any IPv6 in the list, then the RA packet is dropped. To change the behavior, add a dummy IPv6 “0:0:0:0:0” to the list with Allow option. The default value changes from Drop to Allow.</p> |
| {no   default} match ra-srcaddr-list  | Removes the source IPv6 address-based RA Guard filtering for the specified IPv6 address access list names.                                                                                                                                                                                                                                                                                                       |
| managed-config-flag <none   on   off> | Verifies managed address configuration flag in the advertised RA packet.<br><br>By default, the value is none and check is bypassed.                                                                                                                                                                                                                                                                             |
| hop-limit {maximum   minimum} <0–255> | Verifies the advertised hop count limit. The limit value range is from 0 to 255.<br><br>While changing the minimum or maximum value, ensure the maximum value is greater than the minimum value.<br><br>By default, the minimum and maximum limit are 0. In this case, the hop-limit check is bypassed.                                                                                                          |

*Table continues...*

| Variable                                               | Description                                                                                                                                                                       |
|--------------------------------------------------------|-----------------------------------------------------------------------------------------------------------------------------------------------------------------------------------|
| router-preference maximum {none   high   low   medium} | Verifies if the advertised default router-preference parameter value is lower than or equal to a specified limit.<br><br>By default, the value is none and the check is bypassed. |

## Displaying RA Guard configuration

### About this task

Display configured RA Guard policy information.

### Procedure

1. Log on to the switch to enter User EXEC mode.
2. Display configured RA Guard policy information:

```
show ipv6 fhs ra-guard policy WORD<1-64>
```

### Example

```
Switch:1# show ipv6 fhs ra-guard policy
=====
IPv6 Ra Guard Policy Info
=====
MANAGED
POLICY-NAME RA-SRC-ADDR-LIST RA-MAC-ADDR-LIST RA-PREFIX-LIST LIMIT LIMIT CON-FLAG PREF

Ra_guard_poll None None ac11 0 0 None
None

All 1 out of 1 Total Num of ra-guard policy entries displayed
```

### Variable definitions

Use the data in the following table to use the `show ipv6 fhs ra-guard policy` command.

| Variable   | Description                                                                                                                 |
|------------|-----------------------------------------------------------------------------------------------------------------------------|
| WORD<1-64> | Displays the RA Guard policy for the specified policy-name. By default, all the configured RA Guard policies are displayed. |

### Job aid

The following table shows the field descriptions for the `show ipv6 fhs ra-guard policy` command.

| Field    | Description                         |
|----------|-------------------------------------|
| POL-NAME | Indicates the RA Guard policy name. |

*Table continues...*

| Field             | Description                                                                                                                    |
|-------------------|--------------------------------------------------------------------------------------------------------------------------------|
| DEVICE-ROLE       | Indicates if the device role is router or host.                                                                                |
| IPv6-ACC-LIST     | Indicates the IPv6 access list against which the incoming RA packet's source IPv6 address has to be validated.                 |
| MAC-ACC-LIST      | Indicates the MAC access list against which the incoming RA packet's source MAC address has to be validated.                   |
| PREFIX-LIST       | Specifies the IPv6 prefix list against which advertised prefix information in incoming RA packets source need to be validated. |
| MIN HOP-LIMIT     | Indicates the advertised hop count minimum limit.                                                                              |
| MAX HOP-LIMIT     | Indicates the advertised hop count maximum limit.                                                                              |
| MANAGED CONF-FLAG | Indicates the managed address configuration flag status in the advertised RA packet.                                           |
| RTR-PREF          | Indicates the advertised default router preference value.                                                                      |

## IPv6 Neighbor Discovery inspection configuration

This section describes how to configure ND inspection on the switch and protect the network by mitigating the various types of attacks.

### Important:

Enable FHS globally before enabling ND inspection.

## Enabling ND inspection globally

### Before you begin

Enable FHS globally for ND inspection to work.

### About this task

Use this procedure to enable Neighbor Discovery (ND) inspection globally.

### Procedure

1. Enter Global Configuration mode:
 

```
enable
configure terminal
```
2. Enable ND inspection globally:
 

```
ipv6 fhs nd-inspection enable
```

## Clearing Neighbor Discovery inspection statistics

## About this task

Use this procedure to clear the Neighbor Discovery inspection statistics.

### Procedure

1. Enter Privileged EXEC mode:

```
enable
```

2. Clear the Neighbor Discovery inspection statistics:

```
clear ipv6 fhs statistics nd-inspection [{slot/port[/sub-port] [-slot/port[/sub-port]] [,...]]
```

#### \* Note:

Alternatively, you can use the command `clear ipv6 fhs statistics all` to clear the ND inspection statistics along with RA guard statistics and DHCPv6 Guard statistics.

### Variable definitions

Use the data in the following table to use the `clear ipv6 fhs statistics nd-inspection` command.

| Variable                                              | Value                                                                                                                                                                                                                                                                                                                                                          |
|-------------------------------------------------------|----------------------------------------------------------------------------------------------------------------------------------------------------------------------------------------------------------------------------------------------------------------------------------------------------------------------------------------------------------------|
| {slot/port[/sub-port] [-slot/port[/sub-port]] [,...]} | Identifies the slot and port in one of the following formats: a single slot and port (slot/port), a range of slots and ports (slot/port-slot/port), or a series of slots and ports (slot/port,slot/port,slot/port). If your platform supports channelization and the port is channelized, you must also specify the sub-port in the format slot/port/sub-port. |

## Enabling Neighbor Discovery inspection on a VLAN

### Before you begin

Enable FHS globally for ND inspection to work.

### About this task

Use this procedure to enable Neighbor Discovery inspection on a VLAN.

### Procedure

1. Enter VLAN Interface Configuration mode:

```
enable
```

```
configure terminal
```

```
interface vlan <1-4059>
```

2. Enable Neighbor Discovery inspection on the VLAN:

```
ipv6 fhs nd-inspection enable
```

## Enabling Neighbor Discovery inspection on a port

### Before you begin

Enable FHS globally for ND inspection to work.

### About this task

Use this procedure to enable Neighbor Discovery inspection on a port

### Procedure

1. Enter GigabitEthernet Interface Configuration mode:

```
enable
configure terminal
interface GigabitEthernet {slot/port[/sub-port] [-slot/port[/sub-port]][,...]}
```

#### \* Note:

If your platform supports channelization and the port is channelized, you must also specify the sub-port in the format slot/port/sub-port.

2. Enable Neighbor Discovery inspection on the port:

```
ipv6 fhs nd-inspection enable
```

## Viewing Neighbor Discovery inspection status globally

### About this task

Use this procedure to view the Neighbor Discovery inspection status globally

### Procedure

1. Enter Privileged EXEC mode:

```
enable
```

2. Display the ND inspection status globally:

```
show ipv6 fhs status
```

## Viewing Neighbor Discovery inspection status on a port

### About this task

Use this procedure to view Neighbor Discovery inspection status on a port.

### Procedure

1. Enter Privileged EXEC mode:

```
enable
```

2. Display port-wise ND inspection status:

```
show ipv6 fhs port-policy
```

## Viewing Neighbor Discovery inspection statistics on a port

### About this task

Use this procedure to view the Neighbor Discovery inspection statistics on a port or set of ports.

### Procedure

1. Enter Privileged EXEC mode:

```
enable
```

2. Display ND inspection statistics on a port or a set of ports:

```
show ipv6 fhs statistics nd-inspection {slot/port[/sub-port] [-slot/
port[/sub-port]] [,...]}
```

### Variable definitions

Use the data in the following table to use the `show ipv6 fhs statistics nd-inspection` command.

| Variable                                              | Value                                                                                                                                                                                                                                                                                                                                                          |
|-------------------------------------------------------|----------------------------------------------------------------------------------------------------------------------------------------------------------------------------------------------------------------------------------------------------------------------------------------------------------------------------------------------------------------|
| {slot/port[/sub-port] [-slot/port[/sub-port]] [,...]} | Identifies the slot and port in one of the following formats: a single slot and port (slot/port), a range of slots and ports (slot/port-slot/port), or a series of slots and ports (slot/port,slot/port,slot/port). If your platform supports channelization and the port is channelized, you must also specify the sub-port in the format slot/port/sub-port. |

---

## IPv6 DHCP snooping configuration

This section describes how to configure IPv6 DHCP snooping on the switch and protect the network by mitigating the various types of attacks.

### Important:

Configure DHCPv6 Guard before enabling IPv6 DHCP snooping. DHCPv6 Guard classifies the ports as trusted or untrusted and extracts DHCPv6 reply packets received on trusted ports to the control path. For more information on how to configure DHCPv6 Guard, see [DHCPv6 Guard policy configuration](#) on page 112.

## Creating a static Security Binding Table entry

Use this procedure to enable learning Security Binding Table (SBT) entries on all the VLANs where IPv6 DHCP snooping is configured.

### About this task

Use this procedure to create a static SBT entry.

## Procedure

1. Enter Global Configuration mode:

```
enable
configure terminal
```

2. Add a static SBT entry:

```
ipv6 fhs snooping static-binding ipv6-address WORD<0-46> vlan
<1-4059> mac-address 0x00:0x00:0x00 port {slot/port[/sub-port]}
```

### \* Note:

To delete an SBT entry, use the command `no ipv6 fhs snooping static-binding`.

## Example

Add a static SBT entry.

```
Switch:1> enable
Switch:1# configure terminal
Switch:1(config)#ipv6 fhs snooping static-binding ipv6-address 2001:DB8:89ab:cdef:
0123:4567:89ab:cdef vlan 1000 mac-address 00:11:22:33:44:55 port 1/2
```

## Variable definitions

Use the data in the following table to use the `ipv6 fhs snooping static-binding ipv6-address` command.

| Variable                    | Value                                                                                                                                                                                                                                                                                                                                                                                                        |
|-----------------------------|--------------------------------------------------------------------------------------------------------------------------------------------------------------------------------------------------------------------------------------------------------------------------------------------------------------------------------------------------------------------------------------------------------------|
| mac-address 0x00:0x00:0x00  | Specifies the MAC address of the binding entry.                                                                                                                                                                                                                                                                                                                                                              |
| port {slot/port[/sub-port]} | Identifies a single slot and port. If your platform supports channelization and the port is channelized, you must also specify the sub-port in the format slot/port/sub-port.                                                                                                                                                                                                                                |
| vlan <1-4059>               | Specifies the VLAN ID in the range of 1 to 4059. By default, VLAN IDs 1 to 4059 are configurable and the system reserves VLAN IDs 4060 to 4094 for internal use. On switches that support the vrf-scaling and spbm-config-mode boot configuration flags, if you enable these flags, the system also reserves VLAN IDs 3500 to 3998. VLAN ID 1 is the default VLAN and you cannot create or delete VLAN ID 1. |
| WORD<0-46>                  | Specifies the IPv6 address for the binding entry.                                                                                                                                                                                                                                                                                                                                                            |

## Clearing a dynamic SBT entry

### About this task

Use this procedure to clear all or a particular dynamic SBT entry.

## Procedure

1. Enter Privileged EXEC mode:

```
enable
```

2. Clear a dynamic SBT entry:

```
clear ipv6 fhs snooping [vlan <1-4059>][ipv6-address WORD<0-46>]
```

## Example

Clear a dynamic SBT entry on a VLAN.

```
Switch:1> enable
Switch:1>clear ipv6 fhs snooping vlan 1000 ipv6-address 2001:DB8:89ab:cdef:
0123:4567:89ab:cdef
```

## Variable definitions

Use the data in the following table to use the `clear ipv6 fhs snooping` command.

| Variable                | Value                                                                                                                                                                                                                                                                                                                                                                                                                                                                             |
|-------------------------|-----------------------------------------------------------------------------------------------------------------------------------------------------------------------------------------------------------------------------------------------------------------------------------------------------------------------------------------------------------------------------------------------------------------------------------------------------------------------------------|
| ipv6-address WORD<0-46> | Specifies the IPv6 address for the binding entry to clear. You cannot specify an address without first specifying the VLAN.                                                                                                                                                                                                                                                                                                                                                       |
| vlan <1-4059>           | Specifies the VLAN ID in the range of 1 to 4059. By default, VLAN IDs 1 to 4059 are configurable and the system reserves VLAN IDs 4060 to 4094 for internal use. On switches that support the vrf-scaling and spbm-config-mode boot configuration flags, if you enable these flags, the system also reserves VLAN IDs 3500 to 3998. VLAN ID 1 is the default VLAN and you cannot create or delete VLAN ID 1.<br><br>If you do not specify a VLAN, the command clears all entries. |

## Enabling IPv6 DHCP snooping on a VLAN

### Before you begin

Enable IPv6 DHCPv6 Guard for IPv6 DHCP snooping to work.

### About this task

Use this procedure to configure IPv6 DHCP snooping on a VLAN.

### Procedure

1. Enter VLAN Interface Configuration mode:

```
enable
```

```
configure terminal
```

```
interface vlan <1-4059>
```

2. Configure IPv6 DHCP snooping on the VLAN:



```
ipv6 fhs snooping dhcp enable
```

## Viewing IPv6 DHCP snooping and ND inspection status on a VLAN

### About this task

Use this procedure to view IPv6 DHCP snooping and ND inspection status on a VLAN.

### Procedure

1. Enter Privileged EXEC mode:

```
enable
```

2. View the IPv6 DHCP snooping and ND inspection status on a VLAN:

```
show ipv6 fhs status vlan [<1-4059>]
```

### Example

View the status for all VLANs.

```
Switch:1#show ipv6 fhs status vlan
```

```
=====
 IPv6 FHS VLAN Information
=====
VLAN-ID DHCP-SNOOPING-STATUS ND-INSPECTION-STATUS

1 Disabled Disabled
3 Disabled Disabled
4 Disabled Disabled
22 Disabled Disabled
=====
All 4 out of 4 Total Num of FHS VLAN entries displayed
```

### Variable definitions

Use the data in the following table to use the `show ipv6 fhs status vlan` command.

| Variable | Value                                                                                                                                                                                                                                                                                                                                                                                                                                                                                       |
|----------|---------------------------------------------------------------------------------------------------------------------------------------------------------------------------------------------------------------------------------------------------------------------------------------------------------------------------------------------------------------------------------------------------------------------------------------------------------------------------------------------|
| <1-4059> | Specifies the VLAN ID in the range of 1 to 4059. By default, VLAN IDs 1 to 4059 are configurable and the system reserves VLAN IDs 4060 to 4094 for internal use. On switches that support the vrf-scaling and spbm-config-mode boot configuration flags, if you enable these flags, the system also reserves VLAN IDs 3500 to 3998. VLAN ID 1 is the default VLAN and you cannot create or delete VLAN ID 1.<br><br>If you do not specify a VLAN ID, the command output includes all VLANs. |

## Viewing SBT entries

## About this task

Use this procedure to view SBT entries.

### Procedure

1. Enter Privileged EXEC mode:

```
enable
```

2. View all SBT entries:

```
show ipv6 fhs snooping binding
```

3. View the SBT entries by type:

```
show ipv6 fhs snooping binding type {dynamic | static}
```

4. View the SBT entries by VLAN:

```
show ipv6 fhs snooping binding vlan <1-4059>[ipv6-address
WORD<0-46>]
```

### Variable definitions

Use the data in the following table to use the `show ipv6 fhs snooping binding` command.

| Variable                        | Value                                                                                                                                                                                                                                                                                                                                                                                                        |
|---------------------------------|--------------------------------------------------------------------------------------------------------------------------------------------------------------------------------------------------------------------------------------------------------------------------------------------------------------------------------------------------------------------------------------------------------------|
| ipv6-address <i>WORD</i> <0-46> | Specifies the IPv6 address for the binding entry.                                                                                                                                                                                                                                                                                                                                                            |
| type {dynamic   static}         | Shows only dynamic binding entries or static binding entries.                                                                                                                                                                                                                                                                                                                                                |
| vlan <1-4059>                   | Specifies the VLAN ID in the range of 1 to 4059. By default, VLAN IDs 1 to 4059 are configurable and the system reserves VLAN IDs 4060 to 4094 for internal use. On switches that support the vrf-scaling and spbm-config-mode boot configuration flags, if you enable these flags, the system also reserves VLAN IDs 3500 to 3998. VLAN ID 1 is the default VLAN and you cannot create or delete VLAN ID 1. |

## IP Source Guard configuration

The following sections provide procedural information you can use to configure IP Source Guard (IPSG) using the Command Line Interface (CLI).

### \* Note:

The switch supports configuration of IP Source Guard for both IPv4 and IPv6 addresses.

## Enabling IP Source Guard on a port for IPv4 addresses

### About this task

Enable IP Source Guard (IPSG) on a port to add a higher level of security to the port by preventing IP spoofing. When you enable IPSG on the interface, filters are automatically installed for the IPv4 addresses that are already learned on that interface.

### ! Important:

Do not enable IPSG on MLT, DMLT, SMLT, LAG, trunk ports or ports that are a part of private VLANs.

### Before you begin

Ensure that the following conditions are *all* satisfied, before you enable IPSG on a port. Otherwise, the system displays error messages.

- DHCP Snooping is enabled globally.
- The port is a member of a VLAN that is configured with both DHCP Snooping and Dynamic ARP Inspection.
- The port is an untrusted port enabled with both DHCP Snooping and Dynamic ARP Inspection.
- The port has enough resources allocated, to support the maximum number of 10 IP addresses allowed for IPSG.

### Procedure

1. Enter GigabitEthernet Interface Configuration mode:

```
enable
configure terminal
interface GigabitEthernet {slot/port[/sub-port] [-slot/port[/sub-port]] [,...]}
```

### \* Note:

If your platform supports channelization and the port is channelized, you must also specify the sub-port in the format slot/port/sub-port.

2. Enable IPSG on the port:

```
ip source verify enable
```

3. Verify IPSG configuration:

```
show ip source verify interface gigabitEthernet [{slot/port[/sub-port] [-slot/port[/sub-port]] [,...]]
```

### Example

Configure IPSG on port 4/1.

```
Switch:1>enable
Switch:1#configure terminal
Enter configuration commands, one per line. End with CNTL/Z.
Switch:1(config)#interface gigabitEthernet 4/1
Switch:1(config-if)#ip source verify enable
```

Verify the configuration.

```
Switch:1(config-if)#show ip source verify interface gigabitEthernet
=====
Source Guard Port Info
=====
PORT
NUM ENABLE

1/1 false
1/2 false
4/1 true
4/2 false
4/3 false
4/4 false
4/5 false
4/6 false

All 8 out of 8 Total Num of Ip Source Guard entries displayed

Switch:1(config-if)#show ip source verify interface gigabitEthernet 4/1
=====
Source Guard Port Info
=====
PORT
NUM ENABLE

4/1 true

All 1 out of 1 Total Num of Ip Source Guard entries displayed
```

**Variable definitions**

Use the data in the following table to use the `ip source verify` command.

| Variable | Value                                |
|----------|--------------------------------------|
| enable   | Enables IP Source Guard on the port. |

**Disabling IP Source Guard for IPv4 addresses**

**About this task**

Disable IP Source Guard (IPSG) on a port to allow traffic from all IPv4 addresses to go through the port without being filtered.

**Procedure**

1. Enter GigabitEthernet Interface Configuration mode:
 

```
enable
configure terminal
interface GigabitEthernet {slot/port[/sub-port] [-slot/port[/sub-port]] [,...]}
```

**\* Note:**

If your platform supports channelization and the port is channelized, you must also specify the sub-port in the format slot/port/sub-port.

2. Disable IPSG for IPv4 addresses:

```
no ip source verify
```

3. Verify IPSG configuration:

```
show ip source verify interface gigabitEthernet [{slot/port[/sub-
port]} [-slot/port[/sub-port]] [,...]]
```

**Example**

Disable IPSG on port 4/1.

```
Switch:1>enable
Switch:1#configure terminal
Enter configuration commands, one per line. End with CNTL/Z.
Switch:1(config)#interface gigabitEthernet 4/1
Switch:1(config-if)#no ip source verify
```

Verify the configuration.

```
Switch:1(config-if)#show ip source verify interface gigabitEthernet 4/1
```

```
=====
Source Guard Port Info
=====
PORT
NUM ENABLE

4/1 false

```

```
All 1 out of 1 Total Num of Ip Source Guard entries displayed
```

**Viewing IP Source Guard configuration on a port****About this task**

View IP Source Guard (IPSG) configuration on a port, with filters for IPv4 addresses.

**Procedure**

1. Log on to the switch to enter User EXEC mode.
2. View IPSG configuration:

```
show ip source verify interface gigabitEthernet [{slot/port[/sub-
port]} [-slot/port[/sub-port]] [,...]]
```

**Example**

```
Switch:1>show ip source verify interface gigabitEthernet 4/1
```

```
=====
Source Guard Port Info
=====
PORT
NUM ENABLE
```

```

4/1 true

All 1 out of 1 Total Num of Ip Source Guard entries displayed
```

### Variable definitions

Use the data in the following table to use the `show ip source verify interface gigabitEthernet` command.

| Variable                                                          | Value                                                                                                                                                                                                                                                                                                                                                          |
|-------------------------------------------------------------------|----------------------------------------------------------------------------------------------------------------------------------------------------------------------------------------------------------------------------------------------------------------------------------------------------------------------------------------------------------------|
| <code>{slot/port[/sub-port] [-slot/port[/sub-port]] [...]}</code> | Identifies the slot and port in one of the following formats: a single slot and port (slot/port), a range of slots and ports (slot/port-slot/port), or a series of slots and ports (slot/port,slot/port,slot/port). If your platform supports channelization and the port is channelized, you must also specify the sub-port in the format slot/port/sub-port. |

### Viewing IPv4 address bindings

#### About this task

View the IPv4 address bindings that IP Source Guard (IPSG) allows.

#### Procedure

1. Log on to the switch to enter User EXEC mode.
2. View the allowed IPv4 address bindings for a specific interface:

```
show ip source binding [interface gigabitEthernet {slot/port[/sub-
port] [-slot/port[/sub-port]] [,...]]|[vlan <1-4059>]|[vrf
WORD<1-16>]|[vrfids WORD<0-512>]
```

3. View the allowed IPv4 address bindings for a specific IP address:

```
show ip source binding {A.B.C.D}
```

#### Example

View the allowed IPv4 address bindings for the port 4/1.

```
Switch:1>show ip source binding interface gigabitEthernet 4/1
```

```
=====
IPSG Source Table
=====
PORT IP VLAN VRF
NUM ADDRESS ID NAME

4/1 192.0.2.1 200 GlobalRouter

All 1 out of 1 Total IP Source Guard entries displayed
```

View the IPv4 address bindings for a specific IP address.

```
Switch:1>show ip source binding 192.0.2.1
```

```
=====
 IPSG Source Table
=====
PORT IP VLAN VRF
NUM ADDRESS ID NAME

4/1 192.0.2.1 200 GlobalRouter
=====
```

```
All 1 out of 1 Total IP Source Guard entries displayed
```

## Variable definitions

Use the data in the following table to use the `show ip source binding` command.

| Variable                                                                                    | Value                                                                                                                                                                                                                                                                                                                                                          |
|---------------------------------------------------------------------------------------------|----------------------------------------------------------------------------------------------------------------------------------------------------------------------------------------------------------------------------------------------------------------------------------------------------------------------------------------------------------------|
| <code>{A.B.C.D}</code>                                                                      | Identifies the IPv4 address.                                                                                                                                                                                                                                                                                                                                   |
| <code>interface gigabitEthernet {slot/port[/sub-port] [-slot/port[/sub-port]] [...]}</code> | Identifies the slot and port in one of the following formats: a single slot and port (slot/port), a range of slots and ports (slot/port-slot/port), or a series of slots and ports (slot/port,slot/port,slot/port). If your platform supports channelization and the port is channelized, you must also specify the sub-port in the format slot/port/sub-port. |
| <code>vlan &lt;1-4059&gt;</code>                                                            | Specifies the VLAN ID of the VLAN for which to view IPv4 address bindings.                                                                                                                                                                                                                                                                                     |
| <code>vrf WORD&lt;1-16&gt;</code>                                                           | Specifies the VRF name of the VRF for which to view the IPv4 address bindings.                                                                                                                                                                                                                                                                                 |
| <code>vrfids WORD&lt;0-512&gt;</code>                                                       | Specifies the VRF ID of the VRF for which to view IPv4 address bindings.                                                                                                                                                                                                                                                                                       |

## Enabling IP Source Guard on a port for IPv6 addresses

### About this task

Enable IP Source Guard (IPSG) on a port, to add a higher level of security to the port by preventing IP spoofing. When you enable IPSG on the interface, filters are installed for IPv6 addresses that are already learned on that interface.

### Important:

Do not enable IPSG on MLT, DMLT, SMLT, LAG, trunk ports or ports that are a part of private VLANs.

### Before you begin

Ensure that the following conditions are *all* satisfied, before you enable IPSG on a port. Otherwise, the system displays error messages.

- DHCP Snooping is enabled globally.
- The port is a member of a VLAN that is configured with both DHCP Snooping and IPv6 Neighbor Discovery inspection.

- The port is an untrusted port enabled with both DHCP Snooping and IPv6 Neighbor Discovery inspection.
- The port has enough resources allocated, to support the maximum number of 10 IP addresses allowed for IPSG.

## Procedure

1. Enter GigabitEthernet Interface Configuration mode:

```
enable
configure terminal
interface GigabitEthernet {slot/port[/sub-port] [-slot/port[/sub-port]] [,...]}
```

**\* Note:**

If your platform supports channelization and the port is channelized, you must also specify the sub-port in the format slot/port/sub-port.

2. Configure the maximum number of allowed IPv6 addresses on a port:

```
ipv6 source-guard [max-allowed-addr <2-10>]
```

**\* Note:**

Ensure that you configure the maximum number of allowed IPv6 addresses on a port, before you enable IPSG on that port.

3. Enable IPSG on the port:

```
ipv6 source-guard enable
```

4. Verify IPSG configuration information on the port:

```
show ipv6 source-guard interface gigabitEthernet [{slot/port[/sub-port] [-slot/port[/sub-port]] [,...]}
```

## Example

Enable IPSG on a port.

Configure the maximum allowed IPv6 addresses on port 4/1 as 10 and enable IPSG on that port.

```
Switch:1>enable
Switch:1#configure terminal
Enter configuration commands, one per line. End with CNTL/Z.
Switch:1(config)#interface gigabitEthernet 4/1
Switch:1(config-if)#ipv6 source-guard max-allowed-addr 10
Switch:1(config-if)#ipv6 source-guard enable
```

Verify the configuration.

```
Switch:1(config-if)#show ipv6 source-guard interface gigabitEthernet 4/1
Slot/Port Source Guard Number of IPv6 Address
 Mode address allowed overflow count
=====
4/1 Enabled 10 0
```



Optionally view all interfaces with IPSG enabled.

```
Switch:1(config-if)#show ipv6 source-guard interface enabled
Slot/Port Source Guard Number of IPv6 Address
 Mode address allowed overflow count
=====
4/1 Enabled 4 0
3/1 Enabled 9 0
```

## Variable definitions

Use the data in the following table to use the `ipv6 source-guard` command.

| Variable                                   | Value                                                                                                                                                                                                                                                                                             |
|--------------------------------------------|---------------------------------------------------------------------------------------------------------------------------------------------------------------------------------------------------------------------------------------------------------------------------------------------------|
| <code>enable</code>                        | Enables IP Source Guard on a port.                                                                                                                                                                                                                                                                |
| <code>max-allowed-addr &lt;2-10&gt;</code> | Specifies the maximum number of IPv6 addresses allowed to transmit data through the port. The default value is 4.<br><br> <b>Note:</b><br>To reset the value to default, IPSG must be disabled on the interface. |

## Disabling IP Source Guard for IPv6 addresses

### About this task

Disable IP Source Guard (IPSG) on a port to allow traffic from all IPv6 addresses to go through the port without being filtered.

### Procedure

1. Enter GigabitEthernet Interface Configuration mode:

```
enable
configure terminal
interface GigabitEthernet {slot/port[/sub-port] [-slot/port[/sub-port]] [,...]}
```

 **Note:**

If your platform supports channelization and the port is channelized, you must also specify the sub-port in the format `slot/port/sub-port`.

2. Disable IPSG for IPv6 addresses on a port:

```
no ipv6 source-guard enable
```

3. Verify IPSG configuration on the port:

```
show ipv6 source-guard interface gigabitEthernet [{slot/port[/sub-port] [-slot/port[/sub-port]] [,...]}
```

## Example

Disable IPSG on port 4/1.

```
Switch:1>enable
Switch:1#configure terminal
Enter configuration commands, one per line. End with CNTL/Z.
Switch:1(config)#interface gigabitEthernet 4/1
Switch:1(config-if)#no ipv6 source-guard enable
```

Verify the configuration.

```
Switch:1(config-if)#show ipv6 source-guard interface gigabitEthernet 4/1
Slot/Port Source Guard Number of IPv6 Address
 Mode address allowed overflow count
=====
4/1 Disabled 10 0
```

## Clearing IP Source Guard overflow counters

### About this task

Overflow counters consist of IPv6 addresses that are not added to IP Source Guard (IPSG) due to lack of filter resources. Use this procedure to clear the overflow counters for an IPSG port.

### Procedure

1. Enter GigabitEthernet Interface Configuration mode:

```
enable

configure terminal

interface GigabitEthernet {slot/port[/sub-port] [-slot/port[/sub-
port]] [,...]}
```

**\* Note:**

If your platform supports channelization and the port is channelized, you must also specify the sub-port in the format slot/port/sub-port.

2. Clear the overflow counters:

```
ipv6 source-guard overflow-count clear
```

3. Verify the configuration on the port:

```
show ipv6 source-guard interface gigabitEthernet [{slot/port[/sub-
port]} [-slot/port[/sub-port]] [,...]}
```

4. **(Optional)** View the overflow counters on all IPSG enabled ports:

```
show ipv6 source-guard interface enabled
```

## Example

Clear overflow counters on the IPSG port 4/1.

```
Switch:1>enable
Switch:1#configure terminal
Enter configuration commands, one per line. End with CNTL/Z.
```

```
Switch:1(config)#interface gigabitEthernet 4/1
Switch:1(config-if)#ipv6 source-guard overflow-count clear
```

Verify the configuration on port 4/1.

```
Switch:1(config-if)#show ipv6 source-guard interface gigabitEthernet 4/1
Slot/Port Source Guard Number of IPv6 Address
 Mode address allowed overflow count
=====
4/1 Enabled 10 0
```

Optionally view the overflow counters on all IPSG enabled ports.

```
Switch:1(config-if)#show ipv6 source-guard interface enabled
Slot/Port Source Guard Number of IPv6 Address
 Mode address allowed overflow count
=====
4/1 Enabled 4 0
3/1 Enabled 9 0
```

## Viewing IP Source Guard configuration for IPv6 addresses

### Procedure

1. Log on to the switch to enter User EXEC mode.
2. View IPSG configuration on a specified interface:
 

```
show ipv6 source-guard interface gigabitEthernet [{slot/port[/sub-
port]} [-slot/port[/sub-port]] [,...]]
```
3. View IPSG configuration on all IPSG enabled interfaces:

```
show ipv6 source-guard interface enabled
```

### Example

```
Switch:1#show ipv6 source-guard interface gigabitEthernet 4/1
Slot/Port Source Guard Number of IPv6 Address
 Mode address allowed overflow count
=====
4/1 Enabled 4 0
```

```
Switch:1#show ipv6 source-guard interface enabled
Slot/Port Source Guard Number of IPv6 Address
 Mode address allowed overflow count
=====
4/1 Enabled 4 0
4/2 Enabled 9 0
```

### Variable definitions

Use the data in the following table to use the `show ipv6 source-guard interface gigabitEthernet` command.

| Variable | Value                                                       |
|----------|-------------------------------------------------------------|
| enabled  | Displays IPSG configuration on all IPSG enabled interfaces. |

*Table continues...*

| Variable                                                                           | Value                                                                                                                                                                                                                                                                                                                                                                                                                                 |
|------------------------------------------------------------------------------------|---------------------------------------------------------------------------------------------------------------------------------------------------------------------------------------------------------------------------------------------------------------------------------------------------------------------------------------------------------------------------------------------------------------------------------------|
| <code>gigabitEthernet {slot/port[/sub-port] [-slot/port[/sub-port]] [,...]}</code> | <p>Displays IPSPG configuration on the specified interface.</p> <p>Identifies the slot and port in one of the following formats: a single slot and port (slot/port), a range of slots and ports (slot/port-slot/port), or a series of slots and ports (slot/port,slot/port,slot/port). If your platform supports channelization and the port is channelized, you must also specify the sub-port in the format slot/port/sub-port.</p> |

## Viewing IPv6 address bindings

### About this task

View the IPv6 address bindings that IP Source Guard (IPSPG) allows.

### Procedure

1. Log on to the switch to enter User EXEC mode.
2. View the allowed IPv6 address bindings:

```
show ipv6 source-guard binding [WORD<0-46>] [interface
gigabitEthernet {slot/port[/sub-port] [-slot/port[/sub-port]]
[,...]]
```

### Example

View the IPv6 address bindings for port 1/3.

```
Switch:1>show ipv6 source-guard binding interface gigabitEthernet 1/3
Slot/Port IPv6 Address

1/3 2001::10:10:0:1
1/3 fe80::210:94ff:fe00:550b

```

View the IPv6 address bindings for a specific IPv6 address.

```
Switch:1>show ipv6 source-guard binding fe80::210:94ff:fe00:550b
Slot/Port IPv6 Address

1/3 fe80::210:94ff:fe00:550b

```

## Variable definitions

Use the data in the following table to use the `show ipv6 source-guard binding` command.

| Variable                                                                                     | Value                                                                                                                                                                                                                                                                                                                                                          |
|----------------------------------------------------------------------------------------------|----------------------------------------------------------------------------------------------------------------------------------------------------------------------------------------------------------------------------------------------------------------------------------------------------------------------------------------------------------------|
| <code>WORD&lt;0-46&gt;</code>                                                                | Identifies the IPv6 address.                                                                                                                                                                                                                                                                                                                                   |
| <code>interface gigabitEthernet {slot/port[/sub-port] [-slot/port[/sub-port]] [,...]}</code> | Identifies the slot and port in one of the following formats: a single slot and port (slot/port), a range of slots and ports (slot/port-slot/port), or a series of slots and ports (slot/port,slot/port,slot/port). If your platform supports channelization and the port is channelized, you must also specify the sub-port in the format slot/port/sub-port. |

---

## Layer 2 security configuration using the EDM

Use the following sections to help you configure Layer 2 security features and protect the network by mitigating various types of attacks, using the Enterprise Device Manager (EDM).

### For IPv4 deployments, configure:

- DHCP Snooping
- Dynamic ARP Inspection
- IP Source Guard for IPv4 addresses

### For IPv6 deployments, configure:

- First Hop Security (FHS)

 **Note:**

FHS does not solve all cases of denial of services like blocking flooding of the IPv6 messages.

- DHCP Snooping and IPv6 Neighbor Discovery Inspection
- IP Source Guard for IPv6 addresses

---

## Dynamic ARP Inspection configuration using EDM

The following section provides procedures to configure Dynamic ARP Inspection (DAI) using EDM.

### Configuring Dynamic ARP Inspection on VLANs

Use the following procedure to enable or disable DAI on one or more VLANs.

 **Note:**

DAI cannot be enabled on Private VLANs (E-Tree) and SPBM B-VLANs.

#### Before you begin

You must enable DHCP Snooping globally.

#### Procedure

1. In the navigation pane, expand the **Configuration > IP** folders.
2. Click **ARP Inspection**.
3. Click the **ARP Inspection-VLAN** tab.
4. In the row for the VLAN, double-click the **Enabled** field, and select **true** to enable DAI.
5. Click **Apply**.

#### ARP Inspection-VLAN field descriptions

Use the data in the following table to use the ARP Inspection-VLAN tab.

| Name    | Description                                                                                   |
|---------|-----------------------------------------------------------------------------------------------|
| VlanId  | Specifies the VLAN ID.                                                                        |
| Enabled | Specifies if DAI is enabled or disabled for the particular VLAN. By default, DAI is disabled. |

## Configuring Dynamic ARP Inspection on ports

Use the following procedure to set the trust factor associated with a port for DAI . By default, the trust factor is set to untrusted.

### \* Note:

For ports that are part of an MLT, DAI must be configured using the MLT configuration mode.

### Before you begin

You must enable DHCP Snooping globally.

### Procedure

1. In the navigation pane, expand the **Configuration > IP** folders.
2. Click **ARP Inspection**.
3. Click the **ARP Inspection-port** tab.
4. In the row for the port, double-click the **IfTrusted** field, and select **trusted** or **untrusted** to set DAI.
5. Click **Apply**.

### ARP Inspection-port field descriptions

Use the data in the following table to use the ARP Inspection-port tab.

| Name      | Description                                                                                  |
|-----------|----------------------------------------------------------------------------------------------|
| Port      | Specifies the port on the switch.                                                            |
| IfTrusted | Specifies the trust factor for DAI on the specific port. By default, it is set as untrusted. |

---

## Configuring FHS Globals

### About this task

Use this procedure to enable FHS to enable DHCPv6 Guard, RA Guard, and ND-inspection globally, and to configure the lifetime for these policies.

### Procedure

1. From the navigation pane, expand the following folders: **Configuration > IPv6**.
2. Click **FHS**.
3. Click the **Globals** tab.

4. Select FHS global options.
5. Click **Apply** to save the changes.
6. **(Optional)** Click **Refresh** to update the results.

## Globals field descriptions

Use the data in the following table to use the Globals tab.

| Name                    | Description                                        |
|-------------------------|----------------------------------------------------|
| <b>Admin</b>            | Enables or disables the FHS policy.                |
| <b>RAGuardAdmin</b>     | Enables or disables the RA Guard policy.           |
| <b>DHCPv6GuardAdmin</b> | Enables or disables the DHCPv6 Guard policy.       |
| <b>NdInspectAdmin</b>   | Enables or disables Neighbor Discovery inspection. |

## IPv6 access list configuration

An IPv6 access list is created to verify the sender's IPv6 address in the inspected messages. You can create, view, or delete an IPv6 access list.

### Creating IPv6 access list

#### About this task

Use this procedure to create an FHS IPv6 access list or add IPv6 prefixes to the existing IPv6 access list.

#### Procedure

1. In the navigation pane, expand the following folders: **Configuration**—> **IPv6**.
2. Click **FHS**.
3. Click the **IPv6 Access List** tab.
4. Click **Insert**.
5. Configure the parameters for the IPv6 access list.
6. Click **Insert**.

### IPv6 Access List field descriptions

Use the data in the following table to use the IPv6 Access List tab.

| Name        | Description                                                       |
|-------------|-------------------------------------------------------------------|
| <b>Name</b> | Specify the IPv6 access list name to create the IPv6 access list. |

*Table continues...*

| Name                 | Description                                                                                                                                                                               |
|----------------------|-------------------------------------------------------------------------------------------------------------------------------------------------------------------------------------------|
| <b>Prefix</b>        | Specify the IPv6 prefix for adding it to the IPv6 access list.                                                                                                                            |
| <b>PrefixMaskLen</b> | Specify the prefix length for adding it to the IPv6 access list. The value range is from 0 to 128. By default, the value is 0.                                                            |
| <b>MaskLenFrom</b>   | Specify the start mask length for providing the IPv6 range. The value range is from 0 to 128. By default, the value is set to the configured prefix length of the IPv6 access list entry. |
| <b>MaskLenTo</b>     | Specify the end mask length for providing the IPv6 range. The value range is from 0 to 128. By default, the value is set to the configured prefix length of the IPv6 access list entry.   |
| <b>AccessType</b>    | Select the access type to allow or deny the entry. By default, the access type is allow.                                                                                                  |

**\* Note:**

- **MaskLenFrom** and **MaskLenTo** must always be greater than or equal to the configured **PrefixMaskLen** for this IPv6 access list entry
- The **MaskLenFrom** value must always be less than or equal to the **MaskLenTo** value.

## Viewing IPv6 access list

### About this task

Use this procedure to display the IPv6 access list.

### Procedure

1. In the navigation pane, expand the following folders: **Configuration**—> **IPv6**.
2. Click **FHS**.
3. Click the **IPv6 Access List** tab.

### IPv6 Access List field descriptions

Use the data in the following table to use the IPv6 Access List tab.

| Name                 | Description                                                                                                                    |
|----------------------|--------------------------------------------------------------------------------------------------------------------------------|
| <b>Name</b>          | Specify the IPv6 access list name to create the IPv6 access list.                                                              |
| <b>Prefix</b>        | Specify the IPv6 prefix for adding it to the IPv6 access list.                                                                 |
| <b>PrefixMaskLen</b> | Specify the prefix length for adding it to the IPv6 access list. The value range is from 0 to 128. By default, the value is 0. |

*Table continues...*



| Name               | Description                                                                                                                                                                               |
|--------------------|-------------------------------------------------------------------------------------------------------------------------------------------------------------------------------------------|
| <b>MaskLenFrom</b> | Specify the start mask length for providing the IPv6 range. The value range is from 0 to 128. By default, the value is set to the configured prefix length of the IPv6 access list entry. |
| <b>MaskLenTo</b>   | Specify the end mask length for providing the IPv6 range. The value range is from 0 to 128. By default, the value is set to the configured prefix length of the IPv6 access list entry.   |
| <b>AccessType</b>  | Select the access type to allow or deny the entry. By default, the access type is allow.                                                                                                  |

 **Note:**

- **MaskLenFrom** and **MaskLenTo** must always be greater than or equal to the configured **PrefixMaskLen** for this IPv6 access list entry
- The **MaskLenFrom** value must always be less than or equal to the **MaskLenTo** value.

## Deleting the IPv6 access list

### About this task

Use this procedure to delete the created IPv6 access list.

### Procedure

1. In the navigation pane, expand the following folders: **Configuration**—> **IPv6**.
2. Click **FHS**.
3. Click the **IPv6 Access List** tab.
4. Select a row from the IPv6 access list to delete.
5. Click **Delete**.

---

## MAC access list configuration

A MAC access list is created to verify the sender's MAC address in the RA packet. You can view, create or delete a MAC access list.

### Creating MAC access list

#### About this task

Use this procedure to create a MAC access list or add a MAC address to the existing MAC access list.

#### Procedure

1. In the navigation pane, expand the following folders: **Configuration** > **IPv6**.

2. Click **FHS**.
3. Click the **MAC Access List** tab.
4. Click **Insert**.
5. Configure the parameters for the MAC access list.
6. Click **Insert**.

### MAC Access List field descriptions

Use the data in the following table to use the MAC Access List tab.

| Name              | Description                                                                           |
|-------------------|---------------------------------------------------------------------------------------|
| <b>Name</b>       | Specify a name to create a MAC access list.                                           |
| <b>Mac</b>        | Specify the MAC address to add to the MAC access list, in (xx:xx:xx:xx:xx:xx) format. |
| <b>AccessType</b> | Specify allow or deny. By default, the access type is allow.                          |

## Viewing a MAC access list

### About this task

Use this procedure to display a configured MAC access list.

### Procedure

1. In the navigation pane, expand the following folders: **Configuration > IPv6**.
2. Click **FHS**.
3. Click the **MAC Access List** tab.

### MAC Access List field descriptions

Use the data in the following table to use the MAC Access List tab.

| Name              | Description                                                                           |
|-------------------|---------------------------------------------------------------------------------------|
| <b>Name</b>       | Specify a name to create a MAC access list.                                           |
| <b>Mac</b>        | Specify the MAC address to add to the MAC access list, in (xx:xx:xx:xx:xx:xx) format. |
| <b>AccessType</b> | Specify allow or deny. By default, the access type is allow.                          |

## Deleting a MAC access list

### About this task

Use this procedure to delete the created MAC access list.

### Procedure

1. In the navigation pane, expand the following folders: **Configuration > IPv6**.

2. Click **FHS**.
3. Click the **MAC Access List** tab.
4. Select a row from the MAC access list to delete.
5. Click **Delete**.

## DHCPv6 Guard policy configuration

Configure the DHCPv6 Guard policy to block DHCPv6 reply and advertisement messages that originate from unauthorized DHCPv6 servers and relay agents that forward DHCPv6 packets from servers to clients. You can view, create or delete a DHCPv6 Guard policy.

### Creating DHCPv6 Guard policy

#### About this task

Use this procedure to create the DHCPv6 Guard policy to block DHCPv6 reply and advertisement messages that originate from unauthorized DHCPv6 servers and relay agents.

#### Procedure



1. In the navigation pane, expand the following folders: **Configuration > IPv6**.
2. Click **FHS**.
3. Click the **DHCPv6 Guard Policy** tab.
4. Click **Insert**.
5. Configure the parameters for the DHCPv6 Guard policy.
6. Click **Insert**.
7. **(Optional)** Click **Refresh** to update the results.

### DHCPv6 Guard Policy field descriptions

Use the data in the following table to use the DHCPv6 Guard Policy tab.

| Name                        | Description                                                                                                                                                                                                                                                                                                                                                                                               |
|-----------------------------|-----------------------------------------------------------------------------------------------------------------------------------------------------------------------------------------------------------------------------------------------------------------------------------------------------------------------------------------------------------------------------------------------------------|
| <b>PolicyName</b>           | Specifies the policy name to create or modify DHCPv6 Guard policy.                                                                                                                                                                                                                                                                                                                                        |
| <b>ServerAccessListName</b> | <p>Enables verification of the sender IPv6 address in the DHCPv6 reply or advertisement packets against attached IPv6 server access list.</p> <p> <b>Note:</b></p> <p>If the access-list is not attached, the source IPv6 address is not validated. If the list is attached and it does not match with any entries</p> |

*Table continues...*

| Name                              | Description                                                                                                                                                                                                                                                                                                                                                                                                                                                                                                                                                                                                                                                   |
|-----------------------------------|---------------------------------------------------------------------------------------------------------------------------------------------------------------------------------------------------------------------------------------------------------------------------------------------------------------------------------------------------------------------------------------------------------------------------------------------------------------------------------------------------------------------------------------------------------------------------------------------------------------------------------------------------------------|
|                                   | <p>in attached IPv6 access list, the switch drops the DHCPv6 packet. To change this behavior, add an entry in the IPv6 access list with prefix 0::0/0 with access type as allow, which changes the drop by default to allow by default.</p>                                                                                                                                                                                                                                                                                                                                                                                                                   |
| <p><b>ReplyPrefixListName</b></p> | <p>Enables verification of the advertised prefixes in DHCPv6 reply messages against the attached prefix list. If not configured, this check is bypassed.</p> <p> <b>Note:</b></p> <p>If the access-list is not attached, the advertised address/prefix is not validated. If the list is attached and it does not match with any entries in attached IPv6 access list, the switch drops the DHCPv6 packet. To change this behavior, an entry in the IPv6 access list with prefix 0::0/0 with access type as allow, which changes the drop by default to allow by default.</p> |
| <p><b>PrefLimitMin</b></p>        | <p>Enables verification if the advertised preference (in reference option) is greater than the specified limit. If not specified, this check does not occur.</p> <p>The value range is from 0 to 255.</p>                                                                                                                                                                                                                                                                                                                                                                                                                                                     |
| <p><b>PrefixLimitMax</b></p>      | <p>Enables verification if the advertised preference (in preference option) is less than the specified limit. If not specified, this check does not occur.</p> <p>The value range is from 0 to 255.</p> <p> <b>Note:</b></p> <p>If both the maximum and minimum limit is 0, this preference check is ignored.</p>                                                                                                                                                                                                                                                          |

## Viewing a DHCPv6 Guard policy

### About this task



Use this procedure to display configured DHCPv6 Guard policies.

### Procedure

1. In the navigation pane, expand the following folders: **Configuration > IPv6**.
2. Click **FHS**.
3. Click the **DHCPv6 Guard Policy** tab.

### DHCPv6 Guard Policy field descriptions

Use the data in the following table to use the DHCPv6 Guard Policy tab.

| Name                        | Description                                                                                                                                                                                                                                                                                                                                                                                                                                                                                                                                                                                                                                                   |
|-----------------------------|---------------------------------------------------------------------------------------------------------------------------------------------------------------------------------------------------------------------------------------------------------------------------------------------------------------------------------------------------------------------------------------------------------------------------------------------------------------------------------------------------------------------------------------------------------------------------------------------------------------------------------------------------------------|
| <b>PolicyName</b>           | Specifies the policy name to create or modify DHCPv6 Guard policy.                                                                                                                                                                                                                                                                                                                                                                                                                                                                                                                                                                                            |
| <b>ServerAccessListName</b> | <p>Enables verification of the sender IPv6 address in the DHCPv6 reply or advertisement packets against attached IPv6 server access list.</p> <p> <b>Note:</b></p> <p>If the access-list is not attached, the source IPv6 address is not validated. If the list is attached and it does not match with any entries in attached IPv6 access list, the switch drops the DHCPv6 packet. To change this behavior, add an entry in the IPv6 access list with prefix 0::0/0 with access type as allow, which changes the drop by default to allow by default.</p>                  |
| <b>ReplyPrefixListName</b>  | <p>Enables verification of the advertised prefixes in DHCPv6 reply messages against the attached prefix list. If not configured, this check is bypassed.</p> <p> <b>Note:</b></p> <p>If the access-list is not attached, the advertised address/prefix is not validated. If the list is attached and it does not match with any entries in attached IPv6 access list, the switch drops the DHCPv6 packet. To change this behavior, an entry in the IPv6 access list with prefix 0::0/0 with access type as allow, which changes the drop by default to allow by default.</p> |
| <b>PrefLimitMin</b>         | <p>Enables verification if the advertised preference (in reference option) is greater than the specified limit. If not specified, this check does not occur.</p> <p>The value range is from 0 to 255.</p>                                                                                                                                                                                                                                                                                                                                                                                                                                                     |
| <b>PrefixLimitMax</b>       | <p>Enables verification if the advertised preference (in preference option) is less than the specified limit. If not specified, this check does not occur.</p> <p>The value range is from 0 to 255.</p> <p> <b>Note:</b></p> <p>If both the maximum and minimum limit is 0, this preference check is ignored.</p>                                                                                                                                                                                                                                                          |

## Deleting a DHCPv6 Guard policy

### About this task

Use this procedure to delete the created DHCPv6 Guard policy.

**\* Note:**

If this policy is already attached to an interface, then this policy cannot be deleted.

**Procedure**

1. In the navigation pane, expand the following folders: **Configuration > IPv6**.
2. Click **FHS**.
3. Click the **DHCPv6 Guard Policy** tab.
4. Select a row from DHCPv6 Guard policies to delete.
5. Click **Delete**.

## RA Guard policy configuration

Configure RA Guard to block or reject unwanted or rogue RA messages that arrive at the network device platform. You can view, create or delete RA Guard policy.

### Creating RA Guard policy

**About this task**

Use this procedure to create a RA Guard policy to block or reject unwanted or rogue RA messages that arrive at the network device platform.

**Procedure**



1. In the navigation pane, expand the following folders: **Configuration > IPv6**.
2. Click **FHS**.
3. Click the **RA Guard Policy** tab.
4. Click **Insert**.
5. Configure the parameters for the RA Guard policy.
6. Click **Insert**.
7. **(Optional)** Click **Refresh** to update the results.

### RA Guard Policy field descriptions

Use the data in the following table to use the RA Guard Policy tab.

| Name               | Description                                                                                                                  |
|--------------------|------------------------------------------------------------------------------------------------------------------------------|
| <b>PolicyName</b>  | Specifies the name of the RA Guard policy to be created or modified.                                                         |
| <b>SrcAddrList</b> | Specify the IPv6 access list name to verify the sender IPv6 address in the RA packets against the attached IPv6 access list. |

*Table continues...*

| Name                     | Description                                                                                                                                                                                                                                                                                                                                                                                                                                                                                                                                                                                                                              |
|--------------------------|------------------------------------------------------------------------------------------------------------------------------------------------------------------------------------------------------------------------------------------------------------------------------------------------------------------------------------------------------------------------------------------------------------------------------------------------------------------------------------------------------------------------------------------------------------------------------------------------------------------------------------------|
|                          | <p> <b>Note:</b></p> <p>The source address in the RA packet is not validated if the access-list is not attached.</p> <p>If the list is attached and the IPv6 source address in RA packet does not match any IPv6-prefix in the list, then the RA packet is dropped. To change this behavior, add an entry in the IPv6 access list with prefix 0::0/0 with access type as allow. The default value changes from drop to allow.</p>                                                                                                                       |
| <b>PrefixList</b>        | <p>Specify the IPv6 prefix list name to verify the advertised prefixes in the RA packet against the attached IPv6 prefix list.</p> <p> <b>Note:</b></p> <p>Advertised prefixes are not validated if the access-list is not attached.</p> <p>If the list is attached and the advertised prefix in the RA packet does not match any IPv6-prefix in the list, then the RA packet is dropped. To change this behavior, add an entry in the IPv6 access list with prefix 0::0/0 with access type as allow. The default value changes from drop to allow.</p> |
| <b>MacAddrList</b>       | <p>Specify the MAC list name to verify the sender source MAC address against the attached MAC access list.</p> <p> <b>Note:</b></p> <p>The source MAC address in the RA packet is not validated if the access-list is not attached.</p> <p>If the list is attached and the source MAC address in the RA packet does not match any MAC address in the list, then the RA packet is dropped.</p>                                                                                                                                                         |
| <b>ManagedConfigFlag</b> | <p>Select the managed configuration flag to verify managed address configuration in the advertised RA packet.</p> <p>By default, none is selected and managed configuration flag validation is skipped.</p>                                                                                                                                                                                                                                                                                                                                                                                                                              |
| <b>RouterPrefMax</b>     | <p>Select the router preference maximum to verify the if the advertised default router preference parameter value is lower than or equal to a specified limit.</p>                                                                                                                                                                                                                                                                                                                                                                                                                                                                       |

*Table continues...*

| Name               | Description                                                                                                                                                                                                                                                                         |
|--------------------|-------------------------------------------------------------------------------------------------------------------------------------------------------------------------------------------------------------------------------------------------------------------------------------|
|                    | By default, none is selected and router preference validation is skipped.                                                                                                                                                                                                           |
| <b>HopLimitMin</b> | Specify the minimum hop limit to verify the advertised hop count limit.<br><br>The value range is from 0 to 255<br>By default, minimum hop limit is 0.                                                                                                                              |
| <b>HopLimitMax</b> | Specify the maximum hop limit to verify the advertised hop count limit.<br><br>The value range is from 0 to 255<br><br>By default, the maximum hop limit is 0 and If both HopLimitMin and HopLimitMax are set to 0, then the hop limit parameter in the RA packet is not validated. |

## Viewing RA Guard policy

### About this task

Use this procedure to display configured RA Guard policies.

### Procedure

1. In the navigation pane, expand the following folders: **Configuration > IPv6**.
2. Click **FHS**.
3. Click the **RA Guard Policy** tab.



### RA Guard Policy field descriptions

Use the data in the following table to use the RA Guard Policy tab.

| Name               | Description                                                                                                                                                                                                                                                                                                                                                                                                                                                                                                                                                                      |
|--------------------|----------------------------------------------------------------------------------------------------------------------------------------------------------------------------------------------------------------------------------------------------------------------------------------------------------------------------------------------------------------------------------------------------------------------------------------------------------------------------------------------------------------------------------------------------------------------------------|
| <b>PolicyName</b>  | Specifies the name of the RA Guard policy to be created or modified.                                                                                                                                                                                                                                                                                                                                                                                                                                                                                                             |
| <b>SrcAddrList</b> | Specify the IPv6 access list name to verify the sender IPv6 address in the RA packets against the attached IPv6 access list.<br><br> <b>Note:</b><br>The source address in the RA packet is not validated if the access-list is not attached.<br><br>If the list is attached and the IPv6 source address in RA packet does not match any IPv6-prefix in the list, then the RA packet is dropped. To change this behavior, add an entry in the IPv6 access list with prefix 0::0/0 with access |

*Table continues...*



| Name                     | Description                                                                                                                                                                                                                                                                                                                                                                                                                                                                                                                                                                                                                              |
|--------------------------|------------------------------------------------------------------------------------------------------------------------------------------------------------------------------------------------------------------------------------------------------------------------------------------------------------------------------------------------------------------------------------------------------------------------------------------------------------------------------------------------------------------------------------------------------------------------------------------------------------------------------------------|
|                          | type as allow. The default value changes from drop to allow.                                                                                                                                                                                                                                                                                                                                                                                                                                                                                                                                                                             |
| <b>PrefixList</b>        | <p>Specify the IPv6 prefix list name to verify the advertised prefixes in the RA packet against the attached IPv6 prefix list.</p> <p> <b>Note:</b></p> <p>Advertised prefixes are not validated if the access-list is not attached.</p> <p>If the list is attached and the advertised prefix in the RA packet does not match any IPv6-prefix in the list, then the RA packet is dropped. To change this behavior, add an entry in the IPv6 access list with prefix 0::0/0 with access type as allow. The default value changes from drop to allow.</p> |
| <b>MacAddrList</b>       | <p>Specify the MAC list name to verify the sender source MAC address against the attached MAC access list.</p> <p> <b>Note:</b></p> <p>The source MAC address in the RA packet is not validated if the access-list is not attached.</p> <p>If the list is attached and the source MAC address in the RA packet does not match any MAC address in the list, then the RA packet is dropped.</p>                                                                                                                                                           |
| <b>ManagedConfigFlag</b> | <p>Select the managed configuration flag to verify managed address configuration in the advertised RA packet.</p> <p>By default, none is selected and managed configuration flag validation is skipped.</p>                                                                                                                                                                                                                                                                                                                                                                                                                              |
| <b>RouterPrefMax</b>     | <p>Select the router preference maximum to verify the if the advertised default router preference parameter value is lower than or equal to a specified limit.</p> <p>By default, none is selected and router preference validation is skipped.</p>                                                                                                                                                                                                                                                                                                                                                                                      |
| <b>HopLimitMin</b>       | <p>Specify the minimum hop limit to verify the advertised hop count limit.</p> <p>The value range is from 0 to 255</p> <p>By default, minimum hop limit is 0.</p>                                                                                                                                                                                                                                                                                                                                                                                                                                                                        |

*Table continues...*

| Name               | Description                                                                                                                                                                                                                                                                                |
|--------------------|--------------------------------------------------------------------------------------------------------------------------------------------------------------------------------------------------------------------------------------------------------------------------------------------|
| <b>HopLimitMax</b> | <p>Specify the maximum hop limit to verify the advertised hop count limit.</p> <p>The value range is from 0 to 255</p> <p>By default, the maximum hop limit is 0 and If both HopLimitMin and HopLimitMax are set to 0, then the hop limit parameter in the RA packet is not validated.</p> |

## Deleting an RA Guard policy

### About this task

Use this procedure to delete the created RA Guard policy.

#### \* Note:

If this policy is already attached to an interface, then you cannot delete this policy.

### Procedure

1. In the navigation pane, expand the following folders: **Configuration > IPv6**.
2. Click **FHS**.
3. Click the **RA Guard Policy** tab.
4. Select a row from the RA Guard policies to delete.
5. Click **Delete**.

---

## Port policy mapping configuration

This configuration allows you to map the port with DHCPv6 Guard or RA Guard policy. You can view, create or delete the mappings.

### Creating port to policy mapping

#### About this task

Use this procedure to map a port to a RA Guard or DHCPv6 Guard policy, DHCPv6 Guard or RA Guard statistics.

### Procedure

1. In the navigation pane, expand the following folders: **Configuration > IPv6**.
2. Click **FHS**.
3. Click the **Port Policy Mapping** tab.
4. Click **Insert**.
5. Configure the parameters for the port policy mapping.
6. Click **Insert**.

7. (Optional) Click **Refresh** to update the results.

### Port Policy Mapping field descriptions

Use the data in the following table to use the Insert Port Policy Mapping dialog box.

| Name                         | Description                                                                |
|------------------------------|----------------------------------------------------------------------------|
| <b>IfIndex</b>               | Specify the port.                                                          |
| <b>DHCPv6GuardPolicyName</b> | Enter an already-created DHCPv6 Guard policy name to map it with the port. |
| <b>RAGuardPolicyName</b>     | Enter an already-created RA Guard policy name to map it with the port.     |
| <b>Dhcpv6gDeviceRole</b>     | Select server or client configuration. The default is server.              |
| <b>RagDeviceRole</b>         | Select host or router configuration. The default is router.                |

## Viewing port policy mapping

### About this task

Use this procedure to display port policy mapping information.

### Procedure

1. In the navigation pane, expand the following folders: **Configuration > IPv6**.
2. Click **FHS**.
3. Click the **Port Policy Mapping** tab.

### Port Policy Mapping field descriptions

Use the data in the following table to use the Port Policy Mapping tab.

| Name                         | Description                                                                                                                                                     |
|------------------------------|-----------------------------------------------------------------------------------------------------------------------------------------------------------------|
| <b>IfIndex</b>               | Identifies the port.                                                                                                                                            |
| <b>Dhcpv6gDeviceRole</b>     | Specifies the DHCPv6 Guard device-role of the received port. If the device role is client and if it receives DHCPv6 reply then those packets should be dropped. |
| <b>DHCPv6GuardPolicyName</b> | Specifies the DHCPv6 Guard policy name associated with the port.                                                                                                |
| <b>TotalDHCPv6PktRcv</b>     | Shows the total number of DHCPv6 packets received on the DHCPv6 Guard enabled interface.                                                                        |
| <b>TotalDHCPv6PktDropped</b> | Shows the total number of DHCPv6 packets dropped due to DHCPv6 Guard filtering.                                                                                 |
| <b>RagDeviceRole</b>         | Specifies the RA Guard device-role.                                                                                                                             |

*Table continues...*

| Name                       | Description                                                                      |
|----------------------------|----------------------------------------------------------------------------------|
| <b>RAGuardPolicyName</b>   | Specifies the RA Guard policy name associated with the port.                     |
| <b>TotalRAPktRcv</b>       | Shows the total number of RA packets received on the RA Guard enabled interface. |
| <b>TotalRAPktDropped</b>   | Shows the total number of RA packets dropped due to RA Guard filtering.          |
| <b>NDInspection</b>        | Enables or disables Neighbor Discovery (ND) inspection. The default is disabled. |
| <b>TotNdPktRcv</b>         | Shows the total number of ND packets received on the RA Guard enabled interface. |
| <b>TotNdPktDropped</b>     | Shows the total number of ND packets dropped due to RA Guard filtering.          |
| <b>ClearDHCPGuardStats</b> | Clears, if true, the DHCPv6 Guard statistics for the port.                       |
| <b>ClearRAGuardStats</b>   | Clears, if true, the RA Guard statistics for the port.                           |
| <b>ClearNDInspectStats</b> | Clears, if true, the ND-inspection statistics for the port.                      |

## Deleting port policy mapping

### About this task

Use this procedure to delete the created port policy mapping.

### Procedure

1. In the navigation pane, expand the following folders: **Configuration > IPv6**.
2. Click **FHS**.
3. Click the **Port Policy Mapping** tab.
4. Select a row from Port Policy Mapping to delete.
5. Click **Delete**.
6. Click **Apply**.

---

## DHCP Snooping configuration using EDM

The following section provides procedures to configure DHCP Snooping using EDM.

### Enabling DHCP Snooping globally

Use the following procedure to enable DHCP Snooping globally. If DHCP Snooping is globally disabled, the switch forwards DHCP reply packets (received on trusted or untrusted ports) to all ports.

## Procedure

1. In the navigation pane, expand the **Configuration > IP** folders.
2. Click **DHCP Snooping**.
3. Click the **DHCP Snooping Globals** tab.
4. Select **Enabled**.
5. Click **Apply**.

## DHCP Snooping Globals field descriptions

Use data in the following table to use the DHCP Snooping Globals tab.

| Name    | Description                                                            |
|---------|------------------------------------------------------------------------|
| Enabled | Enables DHCP Snooping globally. By default, DHCP Snooping is disabled. |

## Configuring DHCP Snooping on VLANs

Use the following procedure to configure DHCP Snooping on a specific VLAN. If DHCP Snooping is globally disabled, the switch forwards DHCP reply packets (received on trusted or untrusted ports) to all ports.

If you enable DHCP Snooping globally, the agent determines whether to forward DHCP reply packets based on the DHCP Snooping mode of the VLAN and trusted state of the port.

### \* Note:

You cannot enable DHCP Snooping on Private VLANs (E-Tree) and SPBM B-VLANs.

## Before you begin

You must enable DHCP Snooping globally.

## Procedure

1. In the navigation pane, expand the **Configuration > IP** folders.
2. Click **DHCP Snooping**.
3. Click the **DHCP Snooping-VLAN** tab.
4. In the row for the VLAN, double-click the **DhcpSnoopingEnabled** field, and select **true** to enable DHCP Snooping.
5. Click **Apply**.

## DHCP Snooping-VLAN field descriptions

Use the data in the following table to use the DHCP Snooping-VLAN tab.

| Name   | Description            |
|--------|------------------------|
| VlanId | Specifies the VLAN ID. |

*Table continues...*

| Name                | Description                                                                                                       |
|---------------------|-------------------------------------------------------------------------------------------------------------------|
| DhcpSnoopingEnabled | Specifies if DHCP Snooping is enabled or disabled for the particular VLAN. By default, DHCP Snooping is disabled. |

## Configuring trusted and untrusted ports

Use the following procedure to set the trust factor associated with a port for DHCP Snooping. By default, the trust factor is set to untrusted on all ports.

### \* Note:

For ports that are members of an MLT, DHCP Snooping must be configured using the MLT configuration mode.

### Before you begin

To enable DHCP Snooping on a port, you must enable DHCP Snooping globally.

### Procedure

1. In the navigation pane, expand the **Configuration > IP** folders.
2. Click **DHCP Snooping**.
3. Click the **DHCP Snooping-port** tab.
4. In the row for the port, double-click the **DhcpSnoopingIfTrusted** field, and select **trusted** or **untrusted** to set DHCP Snooping.
5. Click **Apply**.

### DHCP Snooping-port field descriptions

Use data in the following table to use the DHCP Snooping-port tab.

| Name                  | Description                                                                                      |
|-----------------------|--------------------------------------------------------------------------------------------------|
| Port                  | Specifies the port on the switch.                                                                |
| DhcpSnoopingIfTrusted | Specifies if the switch ports are trusted for DHCP Snooping. By default, it is set as untrusted. |

## DHCP binding configuration

The following section provides procedures to configure the DHCP binding table using EDM.

### Creating DHCP binding table entries

Use the following procedure to add entries for devices with static IP addresses to the DHCP binding table.

### Procedure

1. In the navigation pane, expand the **Configuration > IP** folders.
2. Click **DHCP Snooping**.
3. Click the **DHCP Bindings** tab.

4. Click **Insert**.
5. In the **VlanId** field, enter the VLAN ID.
6. In the **MacAddress** field, enter the MAC address of the DHCP client.
7. In the **AddressType** field, select a value.
8. In the **Address** field, enter the IP address of the DHCP client.
9. In the **Interface** field, select a port.
10. In the **LeaseTime(sec)** field, enter the time in seconds.
11. Click **Insert**.
12. Click **Apply**.

### ***DHCP Bindings field descriptions***

Use data in the following table to use the DHCP Bindings tab.

| <b>Name</b>              | <b>Description</b>                                                                                                                                                                                                                                                   |
|--------------------------|----------------------------------------------------------------------------------------------------------------------------------------------------------------------------------------------------------------------------------------------------------------------|
| <b>VlanId</b>            | Specifies the VLAN to which the DHCP client belongs.                                                                                                                                                                                                                 |
| <b>MacAddress</b>        | Specifies the MAC address of the DHCP client.                                                                                                                                                                                                                        |
| <b>AddressType</b>       | Specifies the type of address. The default address type is IPv4.                                                                                                                                                                                                     |
| <b>Address</b>           | Specifies the IP address assigned to the DHCP client.                                                                                                                                                                                                                |
| <b>Interface</b>         | Specifies the interface to which the DHCP client connects.                                                                                                                                                                                                           |
| <b>LeaseTime(sec)</b>    | Specifies the lease time (in seconds) of the particular DHCP binding entry. The time range is 0 to 2147483646 seconds.                                                                                                                                               |
| <b>TimeToExpiry(sec)</b> | Species the time of expiry (in seconds) of the DHCP binding entry.                                                                                                                                                                                                   |
| <b>EntryType</b>         | Specifies the type of the DHCP binding entry. <ul style="list-style-type: none"> <li>• If the entry was created through DHCP snooping, the type is learned(1).</li> <li>• If the entry was created through a management operation, the type is static(2).</li> </ul> |

### **Viewing DHCP binding information**

Use the following procedure to view all entries in the DHCP binding table.

#### **Procedure**

1. In the navigation pane, expand the **Configuration > IP** folders.
2. Click **DHCP Snooping**.
3. Click the **DHCP Bindings** tab.

### ***DHCP Bindings field descriptions***

Use data in the following table to use the DHCP Bindings tab.

| Name                     | Description                                                                                                                                                                                                                                                                 |
|--------------------------|-----------------------------------------------------------------------------------------------------------------------------------------------------------------------------------------------------------------------------------------------------------------------------|
| <b>VlanId</b>            | Specifies the VLAN to which the DHCP client belongs.                                                                                                                                                                                                                        |
| <b>MacAddress</b>        | Specifies the MAC address of the DHCP client.                                                                                                                                                                                                                               |
| <b>AddressType</b>       | Specifies the type of address. The default address type is IPv4.                                                                                                                                                                                                            |
| <b>Address</b>           | Specifies the IP address assigned to the DHCP client.                                                                                                                                                                                                                       |
| <b>Interface</b>         | Specifies the interface to which the DHCP client connects.                                                                                                                                                                                                                  |
| <b>LeaseTime(sec)</b>    | Specifies the lease time (in seconds) of the particular DHCP binding entry. The time range is 0 to 2147483646 seconds.                                                                                                                                                      |
| <b>TimeToExpiry(sec)</b> | Species the time of expiry (in seconds) of the DHCP binding entry.                                                                                                                                                                                                          |
| <b>EntryType</b>         | <p>Specifies the type of the DHCP binding entry.</p> <ul style="list-style-type: none"> <li>• If the entry was created through DHCP snooping, the type is learned(1).</li> <li>• If the entry was created through a management operation, the type is static(2).</li> </ul> |

## SBT configuration

This configuration allows you to build a snooping binding table (SBT) which contains entries from only trusted devices or hosts. This SBT table is used to validate Neighbor Discovery (ND) packets. You can view, create, or delete the entries in the SBT.

### Creating an SBT entry

#### About this task

Use this procedure to create an SBT entry.

#### Procedure

1. In the navigation pane, expand the following folders: **Configuration > IPv6**.
2. Click **FHS**.
3. Click the **Snoop Binding** tab.
4. Click **Insert**.
5. Configure the parameters for the snoop binding.
6. Click **Insert**.
7. **(Optional)** Click **Refresh** to update the results.

#### *Snoop Binding field descriptions*

Use the data in the following table to use the Snoop Binding tab. A subset of these fields appear if click **Insert**.



| Name           | Description                                                          |
|----------------|----------------------------------------------------------------------|
| VlanId         | Specify the VLAN to which the snooped entry belongs.                 |
| Ipv6Address    | Enter the IPv6 address assigned to the IPv6 host.                    |
| MacAddress     | Enter the MAC address of the snooped entry.                          |
| InterfaceIndex | Specify the interface on which the entry is learnt.                  |
| EntryType      | Indicates the type of entry - static (1) or dynamic (2).             |
| EntrySource    | Indicates the method entry was learnt from - static (1) or dhcp (2). |
| ValidTime      | Indicates the valid time for the snooped entry.                      |
| TimeToExpiry   | Indicates the time to expiry of the snooped entry.                   |

## Viewing SBT entries

### About this task

Use this procedure to display a configured SBT table.

### Procedure

1. In the navigation pane, expand the following folders: **Configuration > IPv6**.
2. Click **FHS**.
3. Click the **Snoop Binding** tab.

### *Snoop Binding field descriptions*

Use the data in the following table to use the Snoop Binding tab. A subset of these fields appear if click **Insert**.

| Name           | Description                                                          |
|----------------|----------------------------------------------------------------------|
| VlanId         | Specify the VLAN to which the snooped entry belongs.                 |
| Ipv6Address    | Enter the IPv6 address assigned to the IPv6 host.                    |
| MacAddress     | Enter the MAC address of the snooped entry.                          |
| InterfaceIndex | Specify the interface on which the entry is learnt.                  |
| EntryType      | Indicates the type of entry - static (1) or dynamic (2).             |
| EntrySource    | Indicates the method entry was learnt from - static (1) or dhcp (2). |
| ValidTime      | Indicates the valid time for the snooped entry.                      |
| TimeToExpiry   | Indicates the time to expiry of the snooped entry.                   |

## Deleting an SBT entry

### About this task

Use this procedure to delete an entry from the SBT table.

## Procedure

1. In the navigation pane, expand the following folders: **Configuration > IPv6**.
2. Click **FHS**.
3. Click the **Snoop Binding** tab.
4. Select a row from the list to delete.
5. Click **Delete**.

---

## IP Source Guard configuration using the EDM

The following sections provide procedural information you can use to configure IP Source Guard (IPSG) on a port, using the Enterprise Device Manager (EDM).

### **Note:**

The switch supports configuration of IP Source Guard for both IPv4 and IPv6 addresses.

## Enabling IP Source Guard on a port for IPv4 addresses

### About this task

Enable IP Source Guard (IPSG) to add a higher level of security to a desired port by preventing IP spoofing. When you enable IPSG on the interface, filters are installed for IPv4 addresses that are already learned on that interface.

### Before you begin

Ensure that the following conditions are *all* satisfied, before you enable IPSG on a port. Otherwise, the system displays error messages.

- DHCP Snooping is enabled globally.
- The port on which you want to enable IPSG is a member of a VLAN that is configured with both DHCP Snooping and Dynamic ARP Inspection.
- The port is an untrusted port enabled with both DHCP Snooping and Dynamic ARP Inspection.
- The port has enough resources allocated to support the maximum number of 10 IP addresses allowed for IPSG.

## Procedure

1. In the navigation tree, expand the following folders: **Configuration > IP**.
2. Click **Source Guard**.
3. Click the **IP Source Guard-port** tab.
4. Double-click the **Mode** field
5. Select **ip** from the list, to enable IPSG.
6. Repeat the steps above to configure IPSG on additional ports.

7. Click **Apply** to save your changes.
8. Click **Refresh** to update the **IP Source Guard-port** tab.

### IP Source Guard-port field descriptions

Use the data in the following table to use the IP Source Guard-port tab.

| Name        | Description                                                                |
|-------------|----------------------------------------------------------------------------|
| <b>Port</b> | Identifies the port on which to enable IPSPG.                              |
| <b>Mode</b> | Displays whether IPSPG is enabled on the port.<br>The default is disabled. |

### Viewing IPv4 address bindings

View the IPv4 address bindings that IPSPG allows.

#### Procedure

1. In the navigation tree, expand the following folders: **Configuration > IP**.
2. Click **Source Guard**.
3. Click the **IP Source Guard-addresses** tab.

### IP Source Guard-addresses field descriptions

Use the data in the following table to use the IP Source Guard-addresses tab.

| Field          | Description                                                       |
|----------------|-------------------------------------------------------------------|
| <b>Port</b>    | Indicates the port on which IPSPG is configured.                  |
| <b>Type</b>    | Indicates the address type.                                       |
| <b>Address</b> | Indicates the IPv4 address that is allowed by IPSPG on the port.  |
| <b>Source</b>  | Indicates the source of the IPv4 address, which is DHCP Snooping. |

### Configuring IP Source Guard on a port for IPv6 addresses

#### About this task

Enable IPSPG to add a higher level of security to a desired port, by preventing IP spoofing. When you enable IPSPG on an interface, filters are automatically installed for the IPv6 addresses that are already learned on that interface.

#### Before you begin

Ensure that the following conditions are *all* satisfied, before you enable IPSPG on a port. Otherwise, the system displays error messages.

- DHCP Snooping is enabled globally.
- The port is a member of a VLAN that is configured with both DHCP Snooping and IPv6 Neighbor Discovery inspection.

- The port is an untrusted port enabled with both DHCP Snooping and IPv6 Neighbor Discovery inspection.
- The port has enough resources allocated to support the maximum number of 10 IP addresses allowed for IPSPG.

**Procedure**

1. In the navigation tree, expand the following folders: **Configuration > IPv6**.
2. Click **IPv6**.
3. Click the **Source Guard** tab.
4. Double-click the **InterfaceState** field.
5. Select a value from the list: **true** or **false**.
6. Double-click the **MaxAddr** field.
7. Enter the maximum number of IPv6 addresses that are allowed to transmit data on the port.
8. **(Optional)** To clear the overflow counters, double-click **ClearOverflowCount** and select **true**.
9. Click **Apply** to save your changes.
10. Click **Refresh** to update the **Source Guard** tab.

**Source Guard field descriptions**

Use the data in the following table to use the Source Guard tab.

| Name                      | Description                                                                                                                                                                                                                                                                                                |
|---------------------------|------------------------------------------------------------------------------------------------------------------------------------------------------------------------------------------------------------------------------------------------------------------------------------------------------------|
| <b>IfIndex</b>            | Specifies a value that uniquely identifies the port.                                                                                                                                                                                                                                                       |
| <b>InterfaceState</b>     | Specifies the state of the interface. The default value is false.                                                                                                                                                                                                                                          |
| <b>MaxAddr</b>            | Specifies the maximum number of IPv6 addresses allowed to transmit data through the port. The default value is 4.<br><br> <b>Note:</b><br>To reset the value to default, IPSPG must first be disabled on the interface. |
| <b>OverflowCount</b>      | Specifies the number of IPv6 addresses for which filters are not added on the IPSPG port, due to a lack of filter resources.<br><br>The default value is 0.                                                                                                                                                |
| <b>ClearOverflowCount</b> | Specifies whether the overflow counter must be cleared. By default, the value is false.                                                                                                                                                                                                                    |

**Viewing IPv6 address bindings**

View the IPv6 address bindings that IPSPG allows.

## Procedure

1. In the navigation tree, expand the following folders: **Configuration > IPv6**.
2. Click **IPv6**.
3. Click the **Source Guard Binding** tab.

## Source Guard Binding field descriptions

Use the data in the following table to use the Source Guard Binding tab.

| Field           | Description                                          |
|-----------------|------------------------------------------------------|
| <b>IfIndex</b>  | Specifies a value that uniquely identifies the port. |
| <b>IPv6Addr</b> | Specifies the binding entry for the IPv6 address.    |

---

## Layer 2 security example scenarios

The following sections describe configuration examples to configure Layer 2 security features for IPv4 and IPv6 deployments.

---

### FHS deployment scenario

In the following example, the Layer 2 switch “SW-1” is connected to another Layer 2 switch “SW-2”, two hosts and a DHCP server. Switch “SW-2” is connected to two other hosts and a router. Out of the two hosts connected to SW-2, one is a malicious host, which can generate bogus RA packets to advertise route prefix, and can also generate bogus DHCP reply packets to configure wrong IPv6 address or wrong default gateway. By doing this, it tries denial-of-service or Man-in-the-Middle attacks. These attacks must be prevented as it affects all the nodes present in the Layer 2 network and FHS can be effective in preventing these attacks.

These attacks can spread over the entire Layer 2 network and thus can affect the hosts connected to SW-2 as well as the hosts connected to SW-1. If you enable FHS only on SW-2, then it could only save the nodes which are directly connected to it. To prevent the good node connected to SW-1 from these attacks, the SW-1 switch also should be FHS enabled.

The following figure shows the FHS deployment scenario topology.

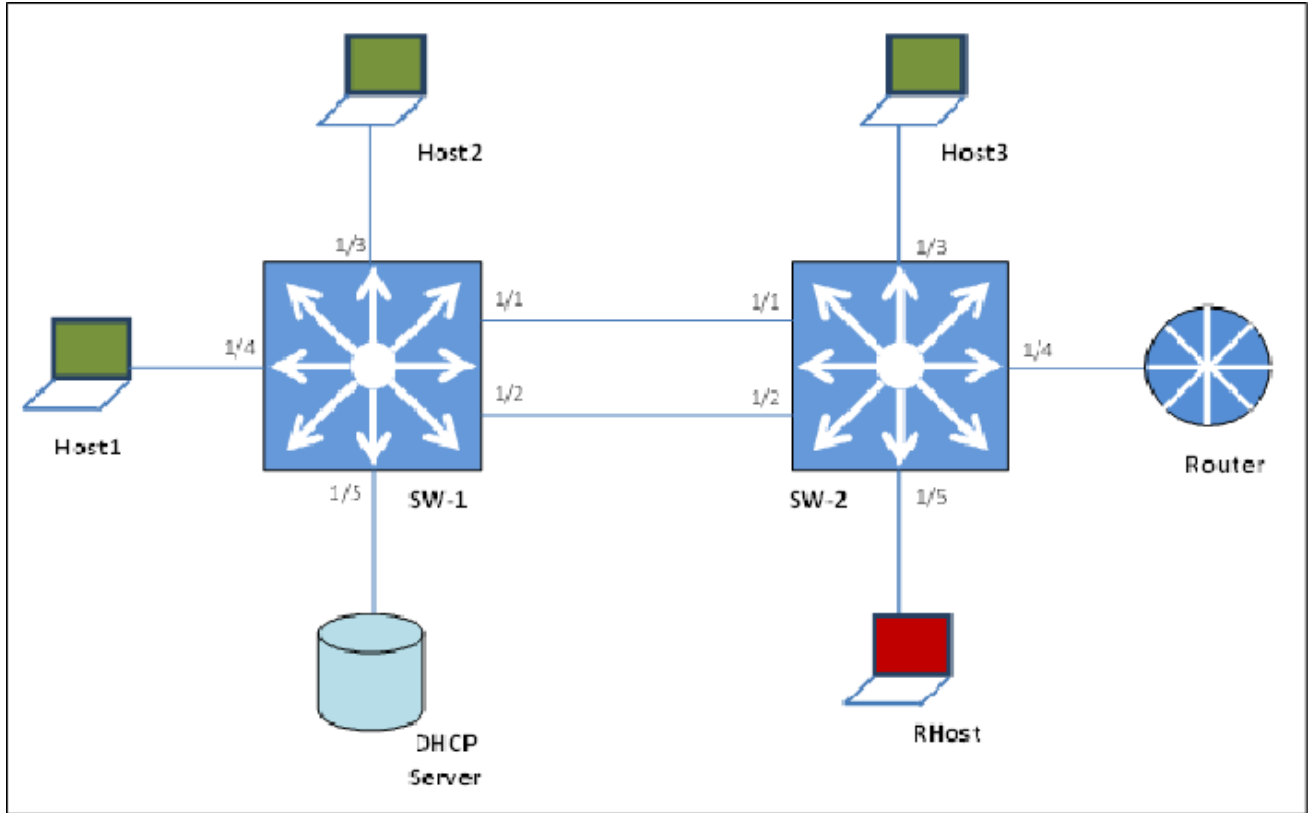

**Figure 11: FHS deployment topology**

By default, all the ports are trusted, until you configure DHCPv6 Guard or RA Guard policies.

See the following procedures to configure FHS RA Guard and DHCPv6 Guard for the preceding topology.

## Creating FHS IPv6 ACL

### About this task

Filter IPv6 traffic by creating IPv6 Access Control Lists (ACLs) and applying them to the interfaces similar to the way that you create and apply IPv4 named ACLs.

### Procedure

1. Enter Global Configuration mode:

```
enable
configure terminal
```

2. Create an IP ACL name (ipv6\_acl\_1) to match the source IPv6 address of the router connected to the interface.

```
ipv6 fhs ipv6-access-list ipv6_acl_1
fe80:0:0:0:cef9:54ff:feb4:9481/128 mode allow
```

3. Create an IP ACL name (ipv6\_acl\_1) to match the source IPv6 address of the DHCPv6-server connected to the interface.

```
ipv6 fhs ipv6-access-list ipv6_acl_1
fe80:0:0:0:cef9:54ff:feb4:9481/128 mode allow
```

### Next steps

Create a First Hop Security MAC ACL.

---

## Creating an FHS MAC ACL

### About this task

Filter the IPv6 traffic by creating a MAC access list with the ACL mode.

### Procedure

1. Enter Global Configuration mode:

```
enable
configure terminal
```

2. Create a MAC ACL name (rtr\_smac) to match the source MAC of the router connected to the interface 1/2.

```
ipv6 fhs mac-access-list mac_acl_1 00:11:22:33:44:66 mode allow
```

---

## Creating a DHCPv6 Guard policy for the router

### About this task

Create a DHCPv6 Guard policy to provide Layer 2 security to DHCPv6 clients by protecting them against rogue DHCPv6 servers.

### Procedure

1. Enter Global Configuration mode:

```
enable
configure terminal
```

2. Enter DHCP Guard mode with the DHCPv6 Guard policy name (dhcpv6g\_pol\_1). The DHCPv6 Guard policy for the interface is connected to a router.

```
ipv6 fhs dhcp-guard policy dhcpv6g_pol_1
```

3. Configure the source IPv6 access list to allow only a DHCPv6 server replies that originate from the IPv6 address `fe80:0:0:0:cef9:54ff:feb4:9481/128` and check the preceding IPv6 ACL configuration for `ipv6_acl_1` list.

```
match server access-list ipv6_acl_1
```

4. Verify the prefixes sent in the DHCPv6 server reply message so that the `ipv6_acl_2` IPv6 ACL configuration allows only the prefix `1000::1/64`.

```
match reply prefix-list ipv6_acl_1
```

---

## Creating an RA Guard policy for the router

### About this task

Create an `rag_pol_1` RA Guard policy for the router and configure the source IPv6 access list to allow only the RA packets that originate from the source IPv6 address `fe80:0:0:0:cef9:54ff:feb4:9481/128`. This configuration verifies the prefixes sent in the RA packets.

### Procedure

1. Enter Global Configuration mode:

```
enable
```

```
configure terminal
```

2. Enter the RA Guard mode and configure RA Guard policy (`rag_pol_1`) for the interface connected to a router.

```
ipv6 fhs ra-guard policy rag_pol_1
```

3. Configure the source IPv6 access list to allow only RA packets originating from the source IPv6 address `fe80:0:0:0:cef9:54ff:feb4:9481/128`.

```
match ipv6 ra-srcaddr-list ipv6_acl_1
```

4. Verify the prefixes sent in the RA packets so that the `rtr_pip` IPv6 ACL configuration allows only the prefix `60::0/64`.

```
match reply ra-prefix-list ipv6_acl_1
```

---

## Attaching FHS policies to the interfaces

### About this task

Attach the FHS policies to the interfaces.

### Procedure

1. Enter Global Configuration mode:

```
enable
```



```
configure terminal
```

2. Configure DHCPv6 Guard and RA Guard policies on the interface (1/2) that connects to the router.

```
interface ethernet 1/2
ipv6 dhcp-guard attach-policy dhcpv6g_pol_1
ipv6 ra-guard attach-policy rag_pol_1
```

---

## IPv6 DHCP Snooping and ND Inspection configuration example

This section shows examples of IPv6 DHCP snooping and ND inspection configuration.

Enable DHCPv6 Guard, ND inspection, and First Hop Security.

```
ipv6 fhs dhcp-guard enable
ipv6 fhs nd-inspection enable
ipv6 fhs enable
```

Create VLAN 1000 and add port members.

```
vlan create 1000 type port-mstprstp 0
vlan members add 1000 1/1-1/10
```

Enable DHCPv6 snooping and ND inspection on VLAN 1000.

```
interface vlan 1000
ipv6 fhs snooping dhcp enable
ipv6 fhs nd-inspection enable
exit
```

Add static SBT entry.

```
ipv6 fhs snooping static-binding ipv6-address 2001:DB8:0:0:0001:02ff:fe03:0405 vlan 1000
mac-address 00:01:02:03:04:05 port 1/5
```

Set the DHCPv6 Guard device-role on port 1/1 of the device on which DHCPv6 Guard is configured.

```
interface gigabitEthernet 1/1
ipv6 fhs dhcp-guard device-role server
exit
```

Enable ND inspection on ports 1/2 through 1/10.

```
interface gigabitEthernet 1/2-1/10
ipv6 fhs nd-inspection enable
exit
```

View the status.

```
show ipv6 fhs port-policy
show ipv6 fhs status
show ipv6 fhs status vlan
show ipv6 fhs snooping binding
```

---

## Configuring IP Source Guard

The following section describes a simple configuration example to configure IP Source Guard (IPSG) on a port.

When you enable IPSG on a port, filters are installed for the IPv4 or IPv6 addresses that are already learned on that port.

### Procedure

Enable DHCP Snooping globally on the switch and verify the configuration.

1. Enter Global Configuration mode:

```
enable
configure terminal
```

2. Enable DHCP Snooping globally.

```
ip dhcp-snooping enable
```

3. Verify the configuration.

```
show ip dhcp-snooping
```

Enable DHCP Snooping and Dynamic ARP Inspection on the VLAN that the port is a member of.

4. Enter VLAN Interface Configuration mode:

```
enable
configure terminal
interface vlan <1-4059>
```

5. Enable DHCP Snooping on the VLAN.

```
ip dhcp-snooping enable
```

6. Verify the configuration.

```
show ip dhcp-snooping vlan <1-4059>
```

7. Enable Dynamic ARP Inspection on the VLAN.

```
ip arp-inspection enable
```

8. Verify the configuration.

```
show ip arp-inspection vlan <1-4059>
```

9. Verify that the port on which you want to configure IPSG is a DHCP Snooping and a Dynamic ARP Inspection untrusted port.

```
show ip dhcp-snooping interface gigabitEthernet [{slot/port[/sub-
port]} [-slot/port[/sub-port]] [,...]]
```

```
show ip arp-inspection interface gigabitEthernet [{slot/port[/sub-
port]} [-slot/port[/sub-port]] [,...]]
```

Configure IPSG on a port and verify the configuration.

10. Perform one of the following steps to configure IPSG on a port, for IPv4 or IPv6 addresses.

- Enable and verify IPSG on a port for IPv4 addresses:

a. `ip source verify enable`

b. `show ip source verify interface gigabitEthernet [{slot/port[/sub-
port]} [-slot/port[/sub-port]] [,...]]`

- Enable and verify IPSG on a port for IPv6 addresses:

a. `ipv6 source-guard enable`

b. `ipv6 source-guard [max-allowed-addr <2-10>]`

**\* Note:**

The default value is 4. To reset the value to default, IPSG must first be disabled on the interface.

c. `show ipv6 source-guard interface gigabitEthernet [{slot/port[/sub-
port]} [-slot/port[/sub-port]] [,...]]`

### Example

The following example describes how to enable IPSG on port 4/5 which is a member of VLAN 10, for IPv4 or IPv6 addresses.

```
Switch:1>en
Switch:1#configure terminal
Enter configuration commands, one per line. End with CNTL/Z.
Switch:1(config)#
```

Enable DHCP Snooping globally and verify the configuration.

```
Switch:1(config)#ip dhcp-snooping enable
Switch:1(config)#show ip dhcp-snooping
```

```
=====
 Dhcp Snooping General Info
=====
Dhcp Snooping : Enabled
=====
```

Enable DHCP Snooping and Dynamic ARP Inspection on a VLAN that the port is a member of.

```
Switch:1(config)#interface vlan 10
Switch:1(config-if)#show ip dhcp-snooping vlan 10
```

```
=====
 Dhcp Snooping Vlan Info
=====
VLAN ID VRF NAME ENABLE

10 GlobalRouter true
=====
```

## Layer 2 security

```
All 1 out of 1 Total Num of Dhcp Snooping entries displayed
```

```
Switch:1(config-if)#ip arp-inspection enable
Switch:1(config-if)#show ip arp-inspection vlan 10
```

```
=====
```

| Arp Inspection Vlan Info |              |        |
|--------------------------|--------------|--------|
| VLAN ID                  | VRF NAME     | ENABLE |
| 10                       | GlobalRouter | true   |

```

```

```
All 1 out of 1 Total Num of Arp Inspection entries displayed
```

### Verify that the port is DHCP Snooping and Dynamic ARP Inspection untrusted.

```
Switch:1(config-if)#show ip dhcp-snooping interface gigabitEthernet 4/5
```

```
=====
```

| Dhcp Snooping Interface Info |            |          |
|------------------------------|------------|----------|
| PORT NUM                     | PORT CLASS | TRUNK ID |
| 4/5                          | UNTRUSTED  | none     |

```

```

```
All 1 out of 1 Total Num of Dhcp Snooping entries displayed
```

```
Switch:1(config-if)#show ip arp-inspection interface gigabitEthernet 4/5
```

```
=====
```

| Arp Inspection Port Info |            |          |
|--------------------------|------------|----------|
| PORT NUM                 | PORT CLASS | TRUNK ID |
| 4/5                      | UNTRUSTED  | none     |

```

```

```
All 1 out of 1 Total Num of Arp Inspection entries displayed
```

### Enable IPSPG on port 4/5 for IPv4 addresses, and verify the configuration. This port is a member of VLAN 10.

```
Switch:1(config-if)#ip source verify enable
Switch:1(config-if)#show ip source verify interface gigabitEthernet 4/5
```

```
=====
```

| Source Guard Port Info |        |
|------------------------|--------|
| PORT NUM               | ENABLE |
| 4/5                    | true   |

```

```

```
All 1 out of 1 Total Num of Ip Source Guard entries displayed
```

### Enable IPSPG on port 4/1 for IPv6 addresses, and verify the configuration. This port is a member of VLAN 10.

```
Switch:1(config-if)#ipv6 source-guard enable
Switch:1(config-if)#ipv6 source-guard max-allowed-addr 10
```

```
Switch:1(config-if)#show ipv6 source-guard interface gigabitEthernet 4/1
Slot/Port Source Guard Number of IPv6 Address
 Mode address allowed overflow count
=====
4/1 Enabled 10 0
```

# Chapter 5: Extensible Authentication Protocol over LAN

The following sections describe Extensible Authentication Protocol over LAN (EAPoL) and its configuration.

---

## EAPoL fundamentals

Extensible Authentication Protocol over LAN (EAPoL or EAP) is a port-based network access control protocol. EAP provides security by preventing users from accessing network resources before they are authenticated. The EAP authentication feature prevents users from accessing a network to assume a valid identity and access confidential material or launch denial-of-service attacks.

You can use EAP to set up network access control on internal LANs and to exchange authentication information between an end station or server that connects to a switch and an authentication server (such as a RADIUS server). This security feature extends the benefits of remote authentication to internal LAN clients. For example, if a new client PC fails the authentication process, EAP prevents the new client PC from accessing the network.

---

## EAP terminology

This section lists some components and terms used with EAP-based security.

- Supplicant—a device, such as a PC, that applies for access to the network.
- Authenticator—software on a switch that authorizes or rejects a Supplicant attached to the other end of a LAN segment.
  - Port Access Entity (PAE)—software that controls each port on the device. The PAE, which resides on the switch, supports the Authenticator functionality.
  - Controlled Port—any port on the device with EAP enabled.
- Authentication Server—a RADIUS server that provides AAA services to the authenticator.

---

# EAP configuration

## EAP configuration considerations

This section lists EAP configuration considerations.

- You must configure at least one EAP RADIUS server and shared secret fields.
- You cannot configure EAP on ports that are currently configured for the following:
  - Shared segments
  - MultiLink Trunking
- Change the authentication status to auto for each port that you want to control. The *auto* setting automatically authenticates the port according to the results of the RADIUS server. The default authentication setting for each port is *authorized*.
- When multiple clients are authenticated on the same port, the priority of the latest incoming client is applied on the port, and this priority is retained until all the clients log out on that port.

## Configuration process

The Authenticator facilitates the authentication exchanges that occur between the Supplicant and the Authentication Server. The Authenticator PORT ACCESS ENTITY (PAE) encapsulates the EAP message into a RADIUS packet, and then sends the packet to the Authentication Server.

The Authenticator manages the access to controlled port. At system initialization, or when a Supplicant initially connects to one of the controlled ports on the device, the system blocks data traffic of the Supplicant until gets authenticated. After the Authentication Server notifies the Authenticator PAE about the success or failure of the authentication, the Authenticator decides whether to permit/deny the traffic of client on controlled port.

non-EAPoL (NEAP) frames transmit according to the following rules:

- If authentication succeeds, the client blocked from accessing is allowed to the controlled port, which means the system allows all the incoming and outgoing traffic from that client through the port.
- If authentication fails, client is blocked from accessing, which means both incoming and outgoing traffic is not allowed to client.

The following figure illustrates how the switch, configured with EAP, reacts to a new network connection.

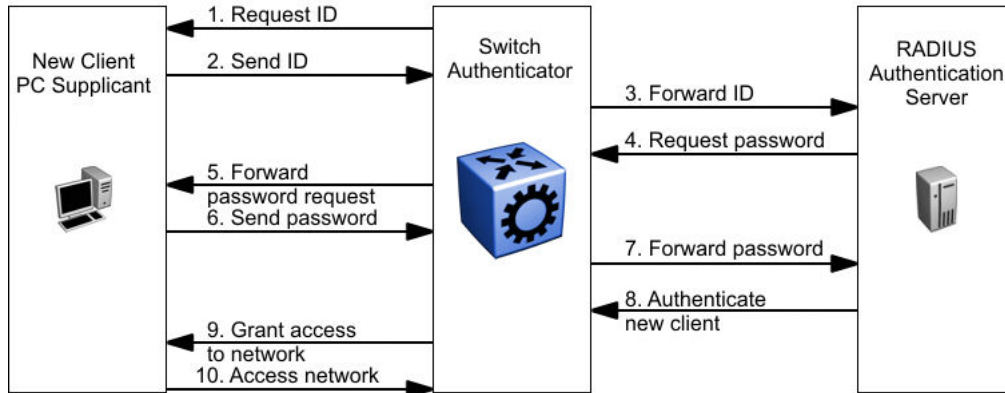

**Figure 12: EAP configuration example**

In the preceding figure, the switch uses the following steps to authenticate a new client:

1. The switch detects a new connection on one of its EAP-enabled ports and requests a user ID from the new client PC.
2. The new client sends its user ID to the switch.
3. The switch uses RADIUS to forward the user ID to the RADIUS server.
4. The RADIUS server responds with a request for the password of the user.
5. The switch forwards the request from the RADIUS server to the new client.
6. The new client sends an encrypted password to the switch, within the EAP packet.
7. The switch forwards the EAP packet to the RADIUS server.
8. The RADIUS server authenticates the password.
9. The switch grants the new client access to the network.
10. The new client accesses the network.

If the RADIUS server cannot authenticate the new client, it denies the new client access to the network.

The following figure shows the Ethernet frames and the corresponding codes for EAP as specified by 802.1x.



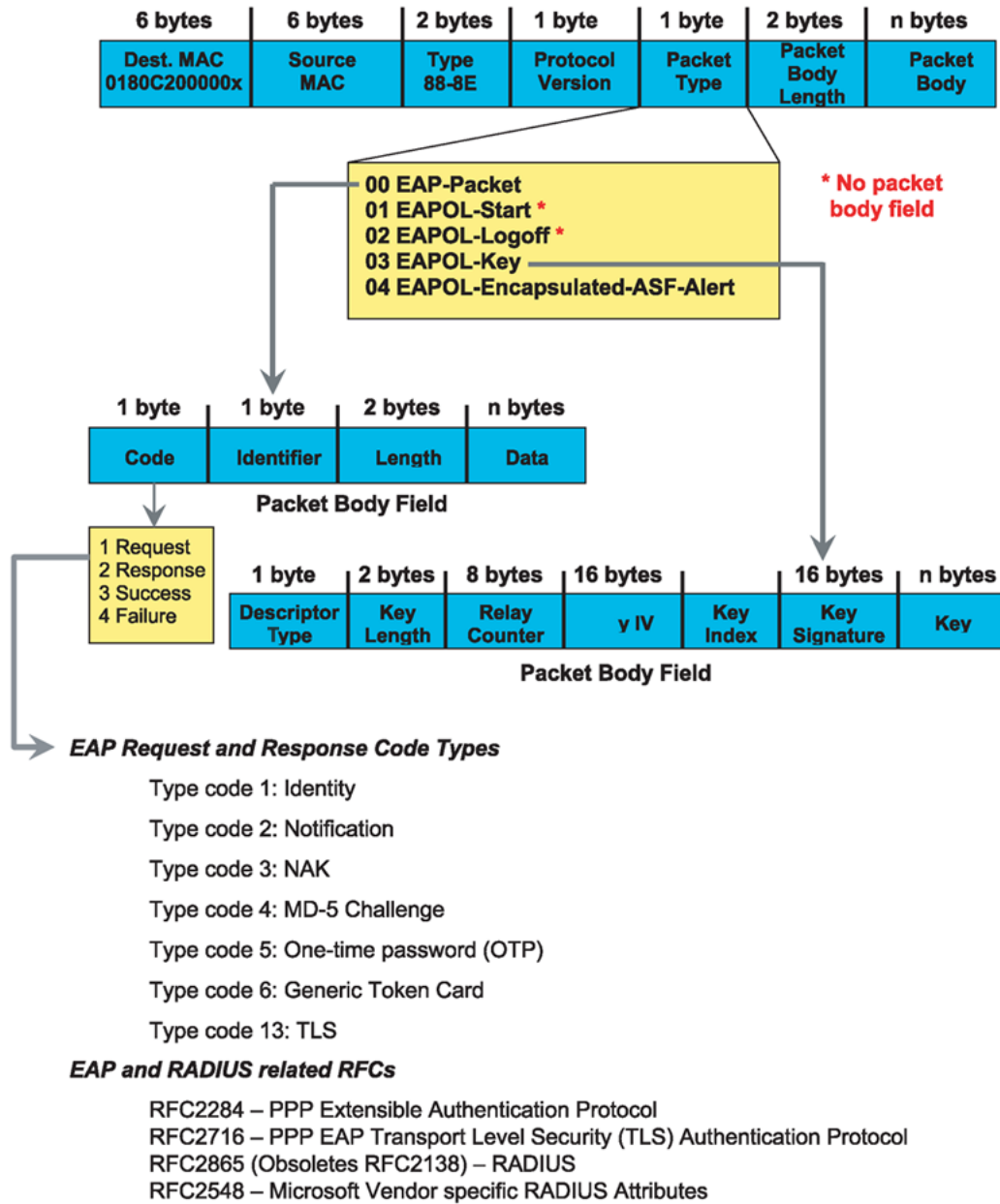

Figure 13: 802.1x Ethernet frame

The following figure shows the flow diagram for EAP on a switch.

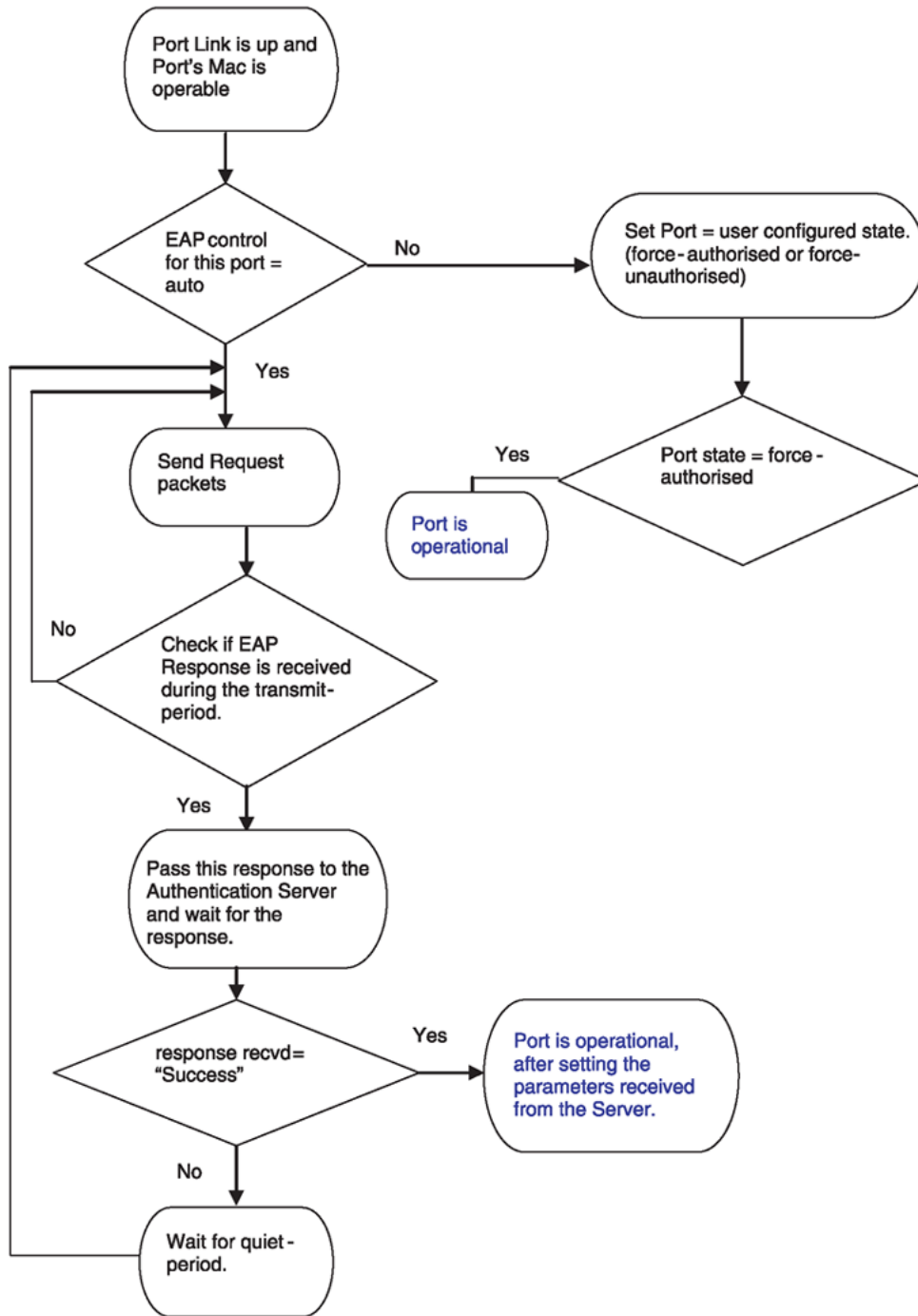

Figure 14: EAP flow diagram

---

## EAP system requirements

The following are the minimum system requirements for EAP:

- RADIUS server
- Client software that supports EAP

You must specify the RADIUS server that supports EAP as the primary RADIUS server for the switch. You must configure your switch for VLANs and EAP security.

If you configure EAP on a port, the following limitations apply:

- You cannot enable EAP on ports that belong to an MLT group.
- You cannot add EAP-enabled ports to an MLT group.
- You can configure a total of 32 MAC clients, EAP and NEAP hosts, on an EAP-enabled port. Two MAC clients per port is a typical configuration.
- You cannot configure EAP on MLT/LACP interfaces.
- You cannot add EAP-enabled ports to an MLT/LACP group.
- You cannot enable VLACP on EAP enabled ports.
- Manual VLAN changes on a EAP enabled port is restricted.
- You cannot change the VLAN port tagging on EAP enabled ports.
- You cannot configure the default VLAN ID. Use the Guest VLAN configuration to access unauthenticated devices.
- You cannot enable MACsec on EAP enabled ports.
- You cannot enable EAP on NNI interfaces.
- You cannot egress mirror an EAP PDU.
- Do not use EAP with a brouter port.
- Ping to and from services between nodes over the NNI will work even when it contains only EAP enabled ports with no authenticated clients on it.
- MHSA and Fail Open VLAN are mutually exclusive.
- You cannot change the EAP operation mode on EAP enabled ports.
- You cannot configure private VLANs as Fail Open VLAN or Guest VLAN.
- You cannot configure spbm-BVLAN as Fail Open VLAN or Guest VLAN.
- You cannot enable EAP on an IP Source Guard enabled port.
- You cannot delete a VLAN if the VLAN is configured as Fail Open VLAN or Guest VLAN.
- You cannot configure DHCP-Snooping enabled VLAN as Guest VLAN or Fail Open VLAN.
- You cannot configure DHCP-Snooping on VLANs used by EAP (Initial VLAN, Radius assigned VLAN, Guest VLAN, and Fail Open VLAN).
- You cannot configure EAP on a port member of DHCP-Snooping enabled VLAN.

---

## EAP dynamic VLAN assignment

If you configure a RADIUS server to send a VLAN ID in the Access-Accept response, the EAP feature dynamically changes the VLAN configuration of the port by adding the port to the specified VLAN.

EAP dynamic VLAN assignment affects the following VLAN configuration values:

- Port membership
- Port priority
- Default VLAN ID

When you disable EAP on a port that was previously authorized, VLAN configuration values for that port are restored directly from the nonvolatile random access memory (NVRAM) of the device.

You can set up your Authentication Server (RADIUS server) for EAP dynamic VLAN assignments. You can use the Authentication Server to configure user-specific settings for VLAN memberships and port priority.

When you log on to a system that is configured for EAP authentication, the Authentication Server recognizes your user ID and notifies the device to assign preconfigured (user-specific) VLAN membership and port priorities to the device. The configuration settings are based on configuration parameters that were customized for your user ID and previously stored on the Authentication Server.

### Note:

Static entries like IGMP, ARP, FDB configured on a port of a VLAN interface, will not be retained if the port is assigned a same VLAN by the RADIUS server and the client authenticated on the port gets disconnected or unauthenticated.

### Multiple Host Multiple VLAN (MHMV)

With the MHMV feature, you can assign multiple authenticated devices to different VLANs on the same EAP-enabled port using device MAC addresses. Using RADIUS VLAN attributes, different clients can access different VLANs. This separates traffic for different MAC clients.

#### Enhanced MHMV:

Use enhanced MHMV to assign multiple authenticated devices to different VLANs on the same port. Clients can access different VLANs access using the MAC address of the devices. Different clients with different level of access (unauthorized to authorized) in different VLANs can exist on the same port.

With enhanced MHMV, EAP Multihost VLAN supports tagged and untagged ports. A port can be a member of multiple tagged and untagged VLANs.

In MHMV mode, MAC based VLANs support traffic separation between different authenticated MAC clients. MAC based VLAN traffic separation applies only to untagged VLAN traffic. If the data traffic is tagged and if VLAN is configured on the port, then the traffic is forwarded to the VLAN associated with the tag.

## MHVM usage scenario

The following example illustrates the usage scenario for a MHMV port with n unauthenticated clients:

- Clients (n) connect to a switch port. The maximum number of clients (EAP + NEAP) allowed on a port is 32.
- EAP is enabled and the default operation mode is MHMV.
- Modify client counters to authenticate n clients.
- Initial VLANs are the VLANs which are manually set up before EAP is enabled.
- Port default VLAN ID is equal to one of the initial VLAN ID.
- All clients are unauthenticated, hence the clients cannot access the network.

The following figure represents the functionality when clients are not authenticated.

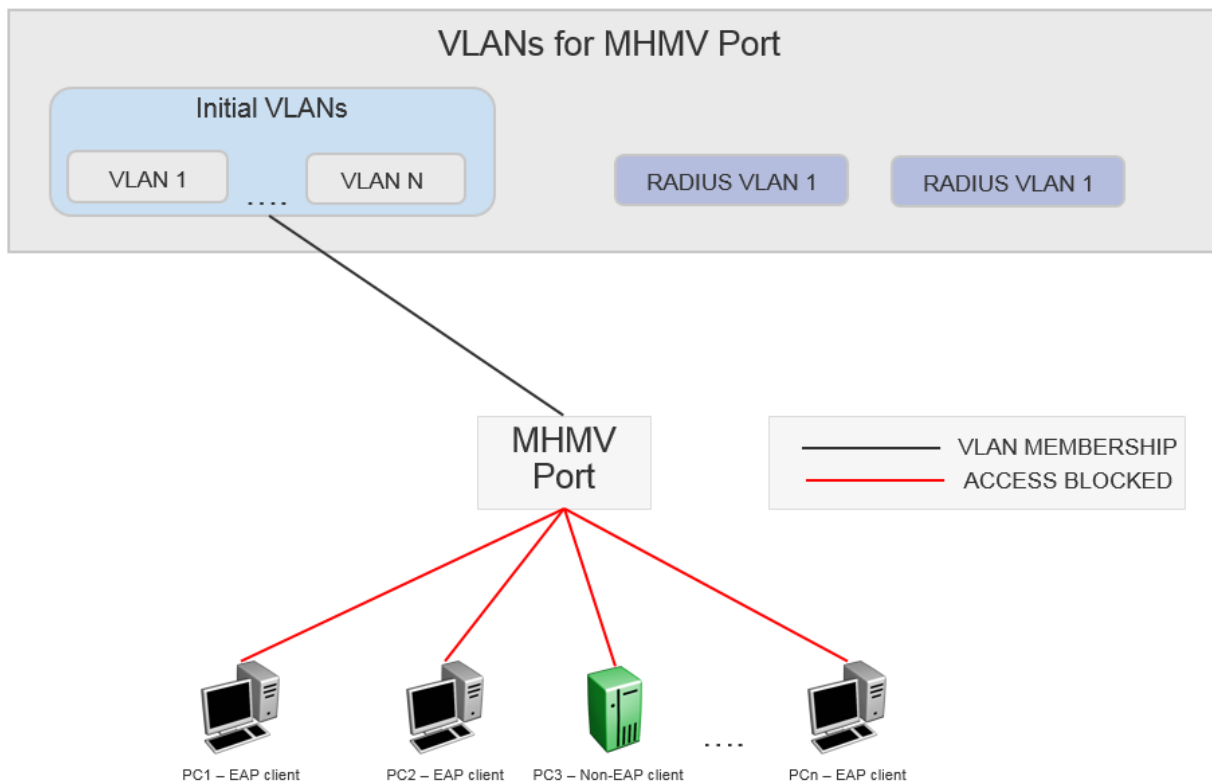

### \* Note:

The clients cannot access the network as they are not authenticated.

When client PC1 authenticates, there are two scenarios:

1. Client PC1 does not receive RADIUS VLAN attribute:
  - There are no changes to the port membership and port default VLAN ID.
  - PC1 is the only client that is allowed access to the initial VLANs.

- A VLAN MAC rule is added that associates the MAC with the default VLAN ID.
  - If the VLAN is configured on the port, then the tagged traffic from PC1 is forwarded to the VLAN associated with the tag.
  - Untagged traffic from PC1 is forwarded to the port default VLAN.
2. Client PC1 receives RADIUS VLAN attribute:
- The port is left in all initial VLANs and added to the VLAN corresponding to the RADIUS VLAN attribute.
  - Port default VLAN remains unchanged.
  - A VLAN MAC based rule is configured for client PC1.
  - Using the VLAN MAC based capabilities, the untagged traffic from PC1 goes to the RADIUS assigned VLAN 1 as shown in the figure below.
  - Client PC1 can access all initial VLANs using tagged frames.
  - The remaining clients stay unauthenticated and cannot access any VLANs.

The following figure represents the functionality when client PC1 authenticates.

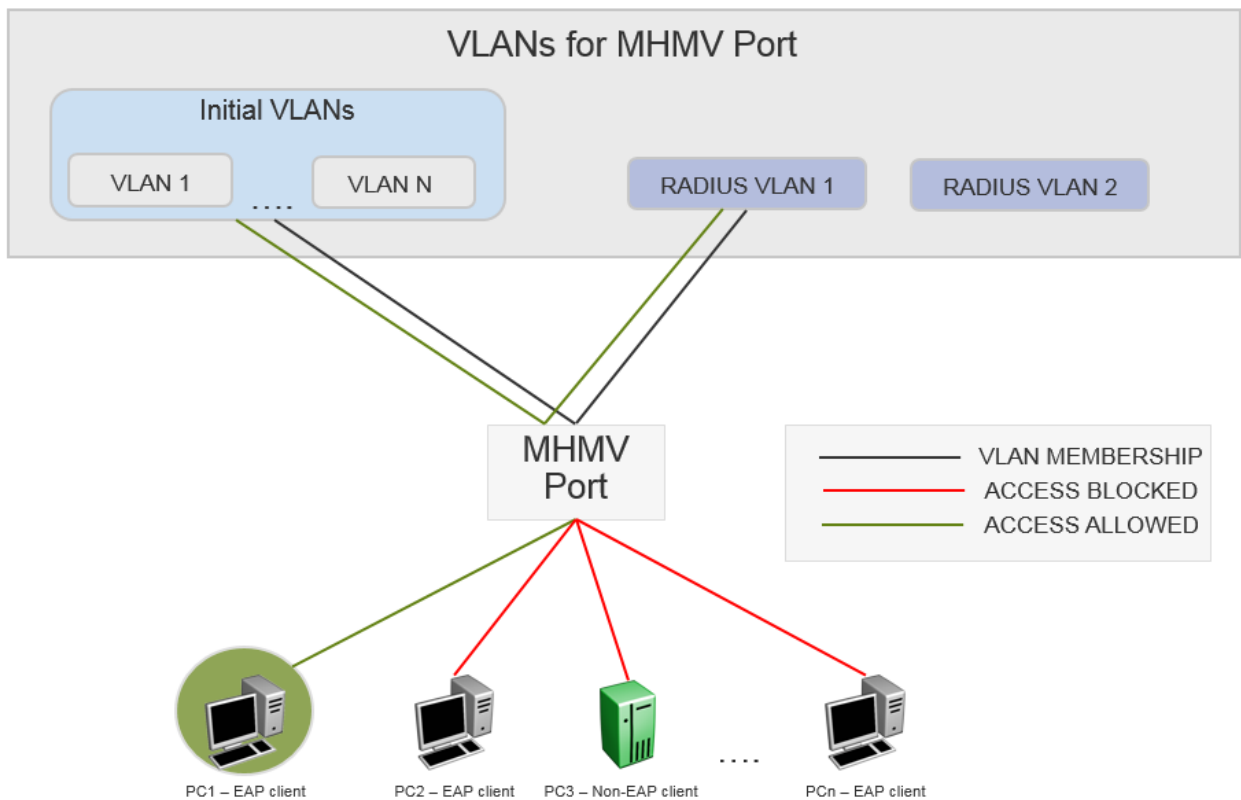

**\* Note:**

PC1 is authenticated with RADIUS VLAN 1. The other clients cannot access the network as they are unauthenticated.

When a client disconnects the following happens:

- The MAC VLAN rule is removed from the switch.
- If the RADIUS VLAN attribute was used with the client was authenticated and no other clients are authenticated on that RADIUS VLAN, then the port is removed from the VLAN. If other clients are authenticated on that RADIUS VLAN, then the VLAN MAC rule is deleted.
- If RADIUS VLAN attribute is not used when the client is authenticated, then only the VLAN MAC rule is deleted.

## Traffic forwarding on EAP enabled port

The following table summarizes how tagged and untagged traffic is forwarded on EAP enabled port after successful authentication.

| Port-tagging                                              | Untagged                          | Untagged                                        | Tagged                                                        | Tagged                                                        | Tagged                                          |
|-----------------------------------------------------------|-----------------------------------|-------------------------------------------------|---------------------------------------------------------------|---------------------------------------------------------------|-------------------------------------------------|
| EAP client authentication or authorization status         | Authenticated<br>RAV assigned     | Authentication failure                          | Authenticated<br>No RAV assigned                              | Authenticated<br>RAV assigned                                 | Authentication failure                          |
| Ingress untagged traffic                                  | Classified into RAV               | Drop                                            | Classified into port default VLAN                             | Classified into RAV                                           | Drop                                            |
| Ingress tagged with RAV                                   | Drop                              | Drop                                            | If configured, then classified into the TAG on the packet     | Classified into RAV                                           | Drop                                            |
| Ingress tagged (not RAV), VLAN not configured on the port | Drop                              | Drop                                            | Drop                                                          | Drop                                                          | Drop                                            |
| Ingress tagged (not RAV), VLAN configured on the port     | Drop                              | Drop                                            | Classified into TAG VLAN since VLAN is configured on the port | Classified into TAG VLAN since VLAN is configured on the port | Drop                                            |
| Egress traffic (RAV or configured)                        | Untagged traffic sent out of port | Drop till the first MAC client is authenticated | Untagged traffic sent out of port                             | Untagged traffic sent out of port                             | Drop till the first MAC client is authenticated |

*Table continues...*

| Port-tagging   | Untagged | Untagged | Tagged | Tagged | Tagged |
|----------------|----------|----------|--------|--------|--------|
| VLANs on port) |          |          |        |        |        |

## RADIUS-assigned VLAN

RADIUS-assigned VLAN gives you greater flexibility and a more centralized assignment. This allows the RADIUS server to dynamically assign VLANs to a port.

### RADIUS return attributes supported for EAP

The switch uses the RADIUS tunnel attributes to place a port into a particular VLAN to support dynamic VLAN switching based on authentication.

The RADIUS server indicates the desired VLAN by including the tunnel attribute within the Access-Accept message. RADIUS uses the following tunnel attributes:

- Tunnel-Type = VLAN (13)
- Tunnel-Medium-Type = 802
- Tunnel-Private-Group-ID = VLAN ID

The VLAN ID is 12 bits, uses a value from <1-4059>, and is encoded as a string.

In addition, you can set up the RADIUS server to send a vendor-specific attribute to configure port priority. You can assign the switch Supplicant port a QoS value from 0 to 6.

The following figure shows the RADIUS vendor-specific frame format.

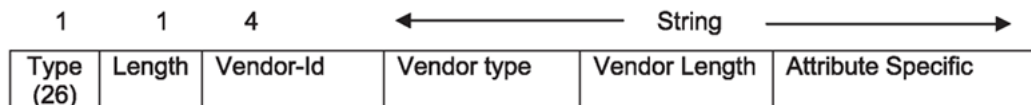

Figure 15: RADIUS vendor-specific frame format

The following list provides the switch Port Priority frame format:

- vendor specific type = 26
- length = 12
- vendor-id = 1584, 562
- string = vendor type = 1 + vendor length = 6 + attribute specific = priority

The following figure shows an example of the port priority frame format.



Figure 16: Port priority frame format



## RADIUS configuration prerequisites for EAP

Connect the RADIUS server to a force-authorized port. This ensures that the port is always available and not tied to whether or not the device is EAP-enabled. To set up the Authentication Server, set the following Return List attributes for all user configurations (for more information, see your Authentication Server documentation):

- VLAN membership attributes
  - Tunnel-Type: value 13, Tunnel-Type-VLAN
  - Tunnel-Medium-Type: value 6, Tunnel-Medium-Type-802
  - Tunnel-Private-Group-ID: ASCII value 1 to 4059 (this value identifies the specified VLAN)
- Port priority (vendor-specific) attributes
  - Vendor ID: value 562, Avaya Vendor ID and value 1584, Bay Networks Vendor ID
  - Attribute Number: value 1, Port Priority
  - Attribute Value: value 0 (zero) to 6 (this value indicates the port priority value assigned to the specified user)

### Important:

You need to configure these attributes only if you require Dynamic VLAN membership or Dynamic Port priority.

## RADIUS accounting for EAP

The switch provides the ability to account EAP and NEAP sessions using the RADIUS accounting protocol. A user session is defined as the interval between the instance at which a user is successfully authenticated (port moves to authorized state) and the instance at which the port moves out of the authorized state.

The following table summarizes the accounting events and information logged.

**Table 6: Summary of accounting events and information logged**

| Event                        | Radius attributes | Description                                               |
|------------------------------|-------------------|-----------------------------------------------------------|
| User is authenticated by EAP | Acct-Status-Type  | Start                                                     |
|                              | Nas-IP-Address    | IP address to represent the switch                        |
|                              | Nas-Port          | Port number on which the user is EAP or NEAP authorized   |
|                              | Acct-Session-ID   | Unique string representing the session                    |
|                              | User-Name         | EAP user name or NEAP MAC                                 |
| User logs off                | Acct-Status-Type  | Stop                                                      |
|                              | Nas-IP-Address    | IP address to represent the switch                        |
|                              | Nas-Port          | Port number on which the user is EAP or NEAP unauthorized |

*Table continues...*

| Event | Radius attributes    | Description                                                                                                                                                              |
|-------|----------------------|--------------------------------------------------------------------------------------------------------------------------------------------------------------------------|
|       | Acct-Session-ID      | Unique string representing the session                                                                                                                                   |
|       | User-Name            | EAP user name                                                                                                                                                            |
|       | Acct-Input-Octets    | Number of octets input to the port during the session                                                                                                                    |
|       | Acct-Output-Octets   | Number of octets output to the port during the session                                                                                                                   |
|       | Acct-Terminate-Cause | Reason for terminating user session. For more information about the mapping of 802.1x session termination cause to RADIUS accounting attribute, see the following table. |
|       | Acct-Session-Time    | Session interval                                                                                                                                                         |

The following table describes the mapping of the causes of 802.1x session terminations to the corresponding RADIUS accounting attributes.

**Table 7: 802.1x session termination mapping**

| IEEE 802.1Xdot1xAuthSessionTerminateCause Value | RADIUSAcct-Terminate-Cause Value    |
|-------------------------------------------------|-------------------------------------|
| supplicantLogoff(1)                             | User Request (1)                    |
| portFailure(2)                                  | Lost Carrier (2)                    |
| supplicantRestart(3)                            | Supplicant Restart (19)             |
| reauthFailed(4)                                 | Reauthentication Failure (20)       |
| authControlForceUnauth(5)                       | Admin Reset (6)                     |
| portReInit(6)                                   | Port Reinitialized (21)             |
| portAdminDisabled(7)                            | Port Administratively Disabled (22) |
| notTerminatedYet(999)                           | —                                   |

## NEAP host

### NEAP hosts on EAP-enabled ports

For an EAP-enabled port configured for NEAP host support, devices with MAC addresses getting authenticated are allowed access to the port.

The switch allows the following types of NEAP users:

- NEAP hosts whose MAC addresses are authenticated by RADIUS.

Support for NEAP hosts on EAP-enabled ports is primarily intended to accommodate printers and other passive devices sharing a hub with EAP clients.

Support for NEAP hosts on EAP-enabled ports includes the following features:

- Authenticated NEAP clients are hosts that satisfy one of the following criteria:
  - Host MAC address is authenticated by RADIUS.
- NEAP hosts are allowed even if no authenticated EAP hosts exist on the port.
- When a new host is seen on the port, NEAP authentication is performed as follows:
  - The switch generates a <username, password> pair, which it forwards to the network RADIUS server for authentication.

### NEAP MAC RADIUS authentication

For RADIUS authentication of a NEAP host MAC address, the switch generates a <username, password> pair as follows:

- The username is the NEAP MAC address in string format.
- The password is a string that combines the switch IP address, MAC address, port number and user-configurable key string. If padding option is enabled, the system will specify a dot(.) for every missing parameter. IP address is represented by three decimal characters per octet.

#### Important:

Follow these Global Configuration examples to select a password format that combines one or more of these three elements:

- Padding enabled , password = 010010011253..05. (when the switch IP address and port are used).
- Padding enabled, password = 010010011253... (when only the switch IP address is used).
- No padding (default option). Password = 000011220001 (when only the user's MAC address is used).

The following example illustrates the <username, password> pair format with no padding enabled and using the IP address, MAC address, and key-string as the password.

```
switch IP address = 192.0.2.5
non-EAP host MAC address = 00 C0 C1 C2 C3 C4
port = 25
Key-String = abcdef
```

- username = 00C0C1C2C3C4
- password = 010010011253.00C0C1C2C3C4.25.abcdef

Use the command **show eapol system** to verify the formatting.

```
Switch:1(config)#show eapol system
```

```
=====
 Eapol System
=====
 eap : enabled
 non-eap-pwd-fmt : ip-addr.mac-address.abcdef
 non-eap-pwd-fmt key : abcdef
 non-eap-pwd-fmt padding : disabled
```

---

## NEAP client

### NEAP client re-authentication

The NEAP client re-authentication feature supports the re-authentication of NEAP clients at defined intervals.

When you enable NEAP client re-authentication, an authenticated NEAP client is only removed from the authenticated client list if you remove the client account from the RADIUS server, or if you clear the NEAP authenticated client from the switch.

If an authenticated NEAP client does not generate traffic on the network, the system removes the MAC address for that client from the MAC address table when MAC ages out. Although the client MAC address does not appear in the MAC Address table, the client can appear as an authenticated client.

If you enable NEAP client re-authentication and the RADIUS server that the switch connects to becomes unavailable, the system clears all authenticated NEAP and removes those clients from the switch NEAP client list.

You cannot authenticate one NEAP client on more than one switch port simultaneously. If you connect NEAP clients to a switch port through a hub, those clients are authenticated on that switch port. If you disconnect a NEAP client from the hub and connect it directly to another switch port, the client is authenticated on the new port and its authentication is removed from the port to which the hub is connected.

### MAC move for authenticated Non-EAP clients

When you move a Non-EAP client that is authenticated on a specific port, to another port on which EAPoL or Non-EAP is enabled, MAC move of the client to the new port does not automatically happen. This is as designed.

As a workaround, do *one* of the following:

- Clear the non-EAP session on the port that the client is first authenticated on, before you move the client to another port.
- Create a VLAN on the switch with the same VLAN ID as that dynamically assigned by the RADIUS server during client authentication. Use the command `vlan create <2-4059> type port-mstprstp <0-63>`. Ensure that the new port is a member of this VLAN.

---

## EAP and NEAP limitations

The EAP and NEAP MAC clients on port limits the maximum number of all EAP and NEAP clients per port. EAP and NEAP MAC clients on port enhancements independently limits the EAP and NEAP clients per port. The following enhancements are added:

- EAP-MAC-MAX : Limits the total number of EAP clients
- NON-EAP-MAC-MAX: Limits the total number of NEAP clients

**\* Note:**

It is recommended that you do not connect more than 100 EAP and 100 NEAP devices on the switch.

**EAP and NEAP mac-max settings**

The total number of EAP clients can be set between 0 and 32, while the total number of NEAP clients can be set between 1 and 32.

**\* Note:**

EAP-MAC-MAX is overwritten by MAC-MAX. Even if EAP-MAC-MAX is set to a higher limit, then MAC-MAX must not exceed and you must not authenticate more than MAC-MAX clients.

**\* Note:**

NON-EAP-MAC-MAX is overwritten by MAC-MAX. Even if NON-EAP-MAC-MAX is set to a higher limit, then MAC-MAX must not exceed and you must not authenticate more than MAC-MAX clients.

**Example scenarios**

## 1. Scenario 1:

- EAP-MAC-MAX 32
- NON-EAP-MAC-MAX 32
- MAC-MAX 10

In this scenario, there are 10 EAP and NEAP authenticated clients, in the order of authentication.

## 2. Scenario 2:

- EAP-MAC-MAX 1
- NON-EAP-MAC-MAX 1
- MAC-MAX 1

In this scenario, only 1 EAP or 1 NEAP client is authenticated, in the order of authentication.

## 3. Scenario 3:

- EAP-MAC-MAX 5
- NON-EAP-MAC-MAX 10
- MAC-MAX 32

In this scenario, up to 5 EAP clients and 10 NEAP clients are allowed.

## 4. Scenario 4:

- EAP-MAC-MAX 5
- NON-EAP-MAC-MAX 8
- MAC-MAX 7

In this scenario, up to 5 EAP clients and 7 NEAP clients are allowed. The total number of EAP or NEAP clients is limited to 7.

---

## Multiple Host Single Authentication

Multiple Host Single Authentication (MHSA) allows MACs to access the network without EAP and NEAP authentication. Unauthenticated devices can access the network only after an EAP or NEAP client is successfully authenticated on a port. The VLAN to which the devices are allowed is the client authenticated VLAN. Unless Guest VLAN is configured, there is no authenticated client on the port, and no MAC is allowed to access the network.

MHSA is primarily intended to accommodate printers and other passive devices sharing a hub with EAP and NEAP clients.

MHSA support is on a port-by-port basis for EAP and NEAP enabled ports.

MHSA supports the following functionality:

- The port remains unauthorized when no authenticated hosts exist on the port. Before the first successful authentication occurs, both EAP and NEAP clients are allowed to negotiate access on that port but only one host is allowed to perform authentication.
- In MHSA mode, the Guest VLAN applies only when no authenticated client is present on the port.
- After the first EAP or NEAP client successfully authenticates on a port, other clients cannot negotiate authentication on that port.
- After the first successful authentication, MACs that are already learned on that port is flushed.
- NEAP clients are not removed at age event in MHSA mode.
- There is no limit to the number of MACs that are allowed after first successful authentication.

### EAP and NEAP MAC clients on port with MHSA

EAP and NEAP client counters such as MAC-MAX, EAP-MAC-MAX, and NON-EAP-MAC-MAX do not apply when the port operates in MHSA mode. In MHSA mode, there can be only one authenticated client (EAP or NEAP). Subsequent MACs seen on the port are allowed automatically without authentication.

---

## Guest VLAN

Guest VLAN support provides limited network access until the client is authenticated. Guest VLAN is configured irrespective of the number of authenticated clients present on the port. Guest VLAN is available for each port. Only port based VLANs are used as Guest VLANs. When the Guest VLAN is active, port is added to the VLAN ID, and port default VLAN ID changes to Guest VLAN ID.

### Guest VLAN on a MHMV port usage scenario

The following example illustrates the configuration of Guest VLAN support with an EAP MHMV port:

- Clients connect to a switch port through a hub.
- The initial VLANs are the VLANs on which the ports resides after a switch reboot.

- EAP is enabled.
- The port is a member of initial VLANs. The clients cannot access the VLANs since the VLANs are not authenticated. The port default VLAN ID corresponds to one of the initial VLAN IDs.
- Guest VLAN support is not activated.

The following figure represents the functionality when clients are not authenticated.

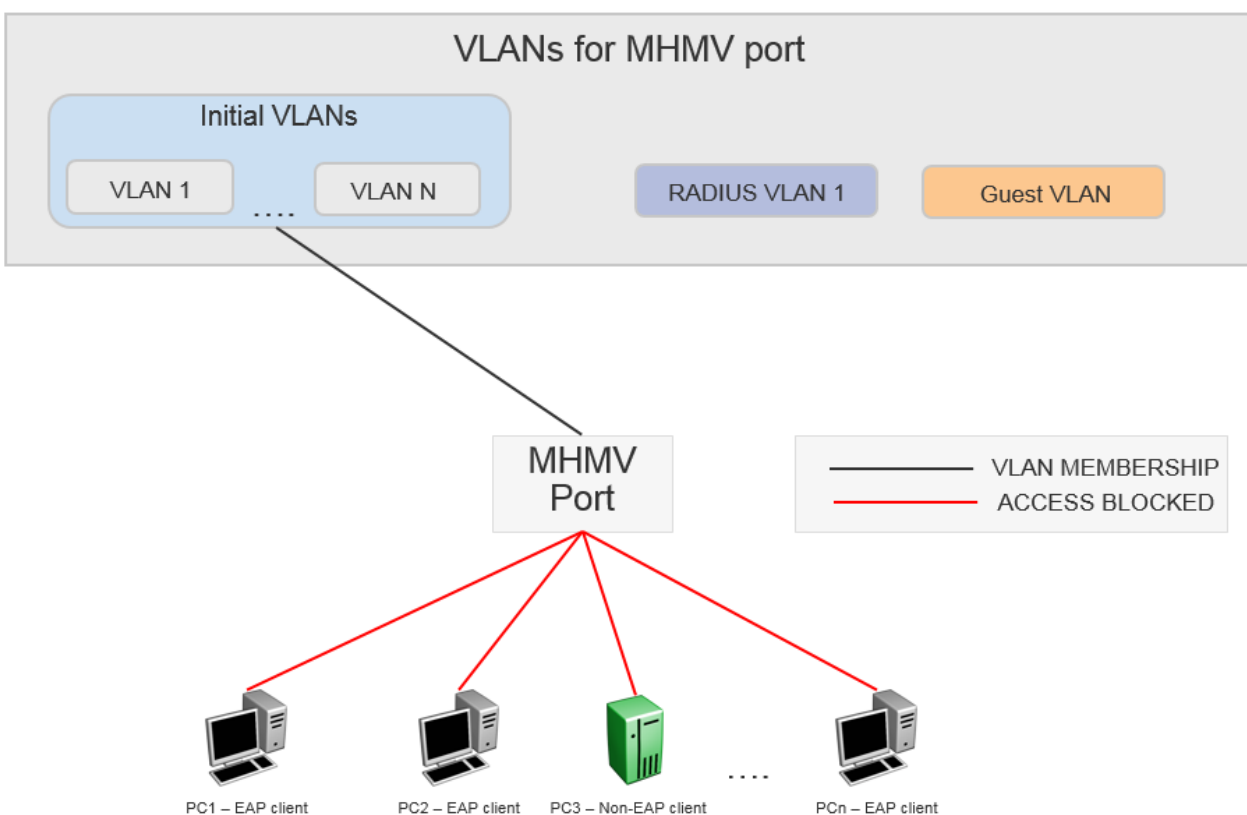

**\* Note:**

The clients cannot access the network as they are not authenticated and Guest VLAN is not configured.

- Guest VLAN support is activated.
- The MHMV port is in the initial VLAN stage but gets added to the Guest VLAN ID. The default VLAN ID is updated to correspond to the Guest VLAN ID.
- All Clients behind the port can access the Guest VLAN.

The following figure represents the functionality when Guest VLAN is activated.

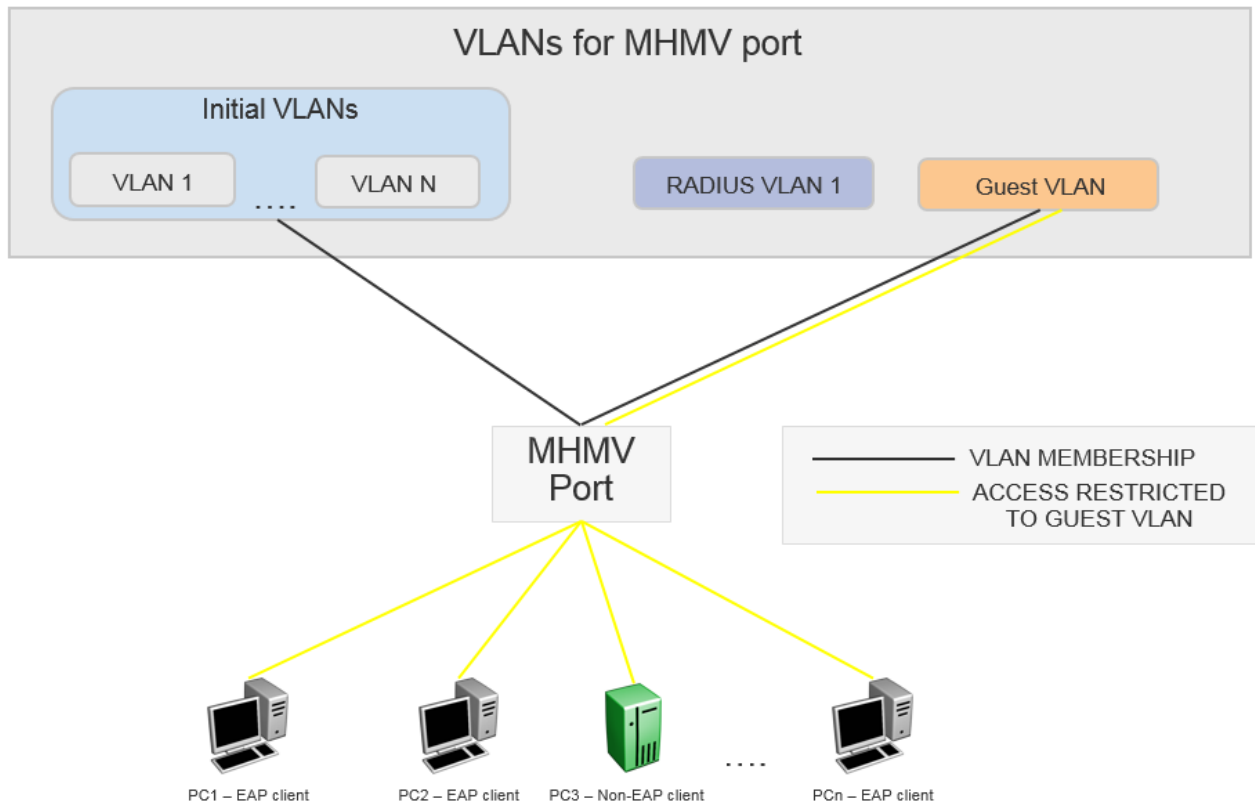

**\* Note:**

All clients have Guest VLAN access.

- A client behind the MHMV port gets authenticated. For this usage scenario let us consider PC1 as the authenticated client.
- The port default VLAN ID is equal to the Guest VLAN ID and remains unchanged.
- The port is copied into the RADIUS assigned VLAN (if any).
- The untagged traffic that originates from PC1 (identified by MAC address) can access only the RADIUS assigned VLAN or the initial port default VLAN ID, if the RADIUS VLAN attribute is missing.
- The remaining clients that send untagged traffic are unauthenticated devices. The unauthenticated devices can access only the Guest VLAN because the port VLAN ID is equal to the Guest VLAN ID.
- The initial VLANs are accessed by the following devices:
  - Authenticated devices that are missing RADIUS VLAN attributes.
  - Authenticated devices that send corresponding tagged packets.
- When another client gets authenticated, the authenticated client undergoes the same process as PC1.

The following figure represents the functionality when a client gets authenticated:



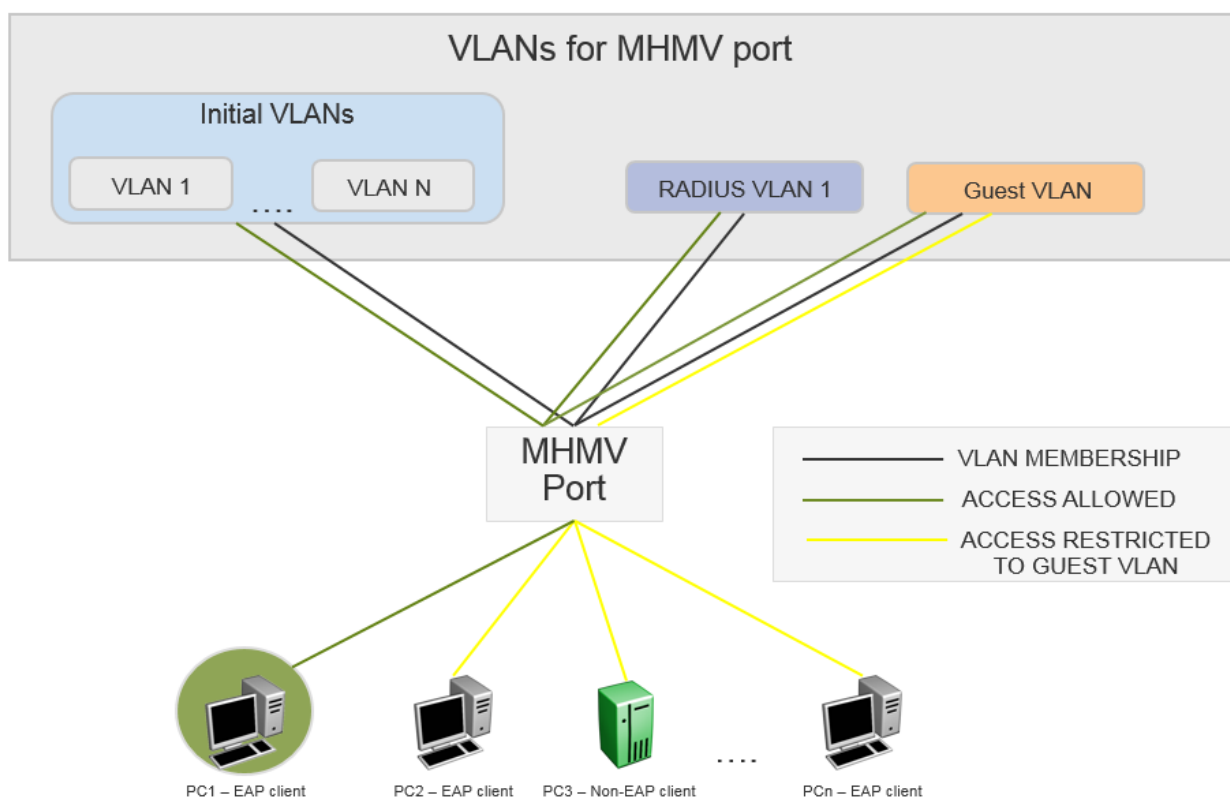

**\* Note:**

PC1 is authenticated with RADIUS VLAN 1. The remain clients have guest VLAN access.

When a client disconnects the following happens:

- The MAC VLAN rule is removed from the switch.
- If the RADIUS VLAN attribute was used with the client was authenticated and no other clients are authenticated on that RADIUS VLAN, then the port is removed from the VLAN. If other clients are authenticated on that RADIUS VLAN, then the VLAN MAC rule is deleted.
- If RADIUS VLAN attribute is not used when the client is authenticated, then only the VLAN MAC rule is deleted.

**Guest VLAN on a MHSa port usage scenario**

The following is a usage example when Guest VLAN is configured with an EAP MHSa port:

- There are no authenticated EAP or NEAP clients on a port.
- The port is removed from the initial VLANs and moved to Guest VLAN ID.
- The default port VLAN ID changes to Guest VLAN ID.
- All MACs seen on the port have Guest VLAN access.
- Port is removed from the Guest VLAN ID.
- If no RADIUS assigned VLAN is present, then the VLAN membership and the default port VLAN ID is restored to default settings.

- If the RADIUS assigned VLAN is present, then the VLAN membership and the default port VLAN ID is changed according to its value.
- Guest VLAN loses its purpose because all MACs are allowed automatically without authentication

In MSHA mode, the Guest VLAN applies only when no authenticated client is present on the port.

---

## EAP and NEAP separation

EAP and NEAP separation provide the ability to have only NEAP clients allowed on one port. This is done by allowing `eap-mac-max` to be set to 0. This enhancement gives you the ability to disable EAP clients authentication without disabling NEAP clients. There are no additional configuration commands. For more information, see [Configuring maximum EAP clients](#) on page 210 and [Configuring maximum NEAP clients](#) on page 210.

---

## EAP and NEAP VLAN names

VLAN names configures VLAN membership of EAP and NEAP clients. You do not have to configure this feature as this mode is always enabled by default.

---

## Fail Open VLAN

Fail Open VLAN provides network connectivity when the switch cannot connect to a RADIUS server. If the switch cannot connect to the primary and secondary RADIUS servers, then after a specified number of attempts to restore connectivity, the switch declares the RADIUS servers unreachable. Fail Open VLAN provides the below functionality:

- When the EAP RADIUS servers are not reachable, Fail Open VLAN provides restricted access to devices, which is separate from the Guest VLAN.
- The EAP and NEAP clients are not affected when the RADIUS servers are not reachable.

Fail Open VLAN is a per-port option. Enable Fail Open VLAN by setting a valid Fail Open VLAN ID. Configure the selected VLAN ID on the switch. Only port based VLANs must be used as Fail Open VLANs.

When you configure Fail Open VLAN on a port and the RADIUS servers are not reachable, then the Fail Open VLAN provides the following functionality:

- The port is removed from Guest VLAN if configured, but all other VLAN membership is kept and in addition the port is added to the Fail Open VLAN.
- Default VLAN ID is changed to Fail Open VLAN ID.

- Traffic from the authenticated EAP and NEAP clients are forwarded as before.
- If re-authentication is enabled in Fail Open VLAN mode, then EAP and NEAP clients stop performing re-authentication.
- All new MACs seen on the port are considered as potential EAP and NEAP clients and is granted Fail Open VLAN access.

When at least one RADIUS server recovers, all EAP enabled ports are removed from the Fail Open VLAN. All unauthenticated MACs are flushed in order to give the MACs an opportunity to authenticate.

### **Fail Open VLAN with Guest VLAN scenarios**

When an EAP port is configured with both Fail Open VLAN and Guest VLAN, consider the following scenarios:

1. EAP port operating in MHMV mode:
  - If the EAP RADIUS servers are reachable, then all the authenticated clients have Guest VLAN ID access.
  - If the EAP RADIUS servers are not reachable, then Guest VLAN must be removed from the port completely. Fail Open VLAN is the new default VLAN. All unauthenticated MACs have Fail Open VLAN access.
2. EAP port operating in MHSA mode:
  - Fail Open VLAN has no impact on the Guest VLAN functionality in MHSA mode.

---

## **EAPoL configuration using CLI**

EAPoL (EAP) uses RADIUS protocol for EAP-authorized logons. RADIUS supports IPv4 and IPv6 addresses, with no difference in functionality or configuration.

Before configuring your device, you must configure at least one EAP RADIUS server and shared secret fields.

You cannot configure EAP on ports that are currently configured for:

- Shared segments
- MultiLink Trunking (MLT)

Change the status of each port that you want to be controlled to auto. The auto setting automatically authenticates the port according to the results of the RADIUS server. The default authentication setting for each port is authorized.

You can connect only a single client on each port configured for EAP. If you attempt to add additional clients on the EAP authorized port, then the system denies access to the new client and displays a warning message.

---

## Globally enabling EAP on the device

Enable EAP globally on the switch before you enable it on a port or interface.

### Procedure

1. Enter Global Configuration mode:

```
enable
configure terminal
```

2. Globally configure EAP:

```
eapol enable
```

### Example

```
Switch:1> enable
Switch:1# configure terminal
Switch:1(config)# eapol enable
```

---

## Configuring EAP on an interface

Configure EAP on an interface.

### Before you begin

- EAP must be globally enabled.

### About this task

When you configure a port with the EAP status of auto (Authorization depends on result of EAP authentication), only one supplicant is allowed on this port. Multiple EAP supplicants are not allowed on the same physical switch port.

### Procedure

1. Enter GigabitEthernet Interface Configuration mode:

```
enable
configure terminal
interface GigabitEthernet {slot/port[/sub-port] [-slot/port[/sub-
port]][, ...]}
```

#### **Note:**

If your platform supports channelization and the port is channelized, you must also specify the sub-port in the format slot/port/sub-port.

2. Enable EAP on an interface:

```
eapol status {authorized|auto}
```

### 3. Disable EAP on on interface:

```
no eapol status
```

## Example

### Enable EAP on an interface:

```
Switch:1>enable
Switch:1#configure terminal
Switch:1(config)#interface GigabitEthernet 1/2
Switch:1(config-if)# eapol status auto
```

### Disable EAP on an interface:

```
Switch:1>enable
Switch:1#configure terminal
Switch:1(config)#interface GigabitEthernet 1/2
Switch:1(config-if)# no eapol status
```

## Variable definitions

Use the data in the following table to use the `eapol status` command.

| Variable   | Value                                                                                                                                     |
|------------|-------------------------------------------------------------------------------------------------------------------------------------------|
| authorized | Specifies that the port is always authorized. The default value is authorized.                                                            |
| auto       | Specifies that port authorization depends on the results of the EAP authentication by the RADIUS server. The default value is authorized. |

## Configuring EAP on a port

Configure EAP on a specific port when you do not want to apply EAP to all of the switch ports.

### Procedure

1. Enter GigabitEthernet Interface Configuration mode:

```
enable

configure terminal

interface GigabitEthernet {slot/port[/sub-port] [-slot/port[/sub-port]] [,...]}
```

#### \* Note:

If your platform supports channelization and the port is channelized, you must also specify the sub-port in the format slot/port/sub-port.

2. Configure the maximum EAP requests sent to the supplicant before timing out the session:

```
eapol port {slot/port[/sub-port] [-slot/port[/sub-port]] [,...]}
max-request <1-10>
```

3. Configure the time interval between authentication failure and the start of a new authentication:

```
eapol port {slot/port[/sub-port] [-slot/port[/sub-port]] [,...]}
quiet-interval <1-65535>
```

4. Enable reauthentication:

```
eapol port {slot/port[/sub-port] [-slot/port[/sub-port]] [,...]} re-
authentication enable
```

5. Configure the time interval between successive authentications:

```
eapol port {slot/port[/sub-port] [-slot/port[/sub-port]] [,...]} re-
authentication-period <1-65535>
```

**\* Note:**

The EAP re-authentication period value is between 1-65535. Early releases support up to 2147483647. To maintain backward compatibility the CLI value is between 1–2147483647. Trying to configure above 65535 results in an error.

6. Configure the EAP authentication status:

```
eapol port {slot/port[/sub-port] [-slot/port[/sub-port]] [,...]}
status {authorized|auto}
```

**Example**

Configure the maximum EAP requests sent to the supplicant before timing out the session:

```
Switch:1>enable
Switch:1#configure terminal
Switch:1(config)#interface GigabitEthernet 1/2
Switch:1(config-if)#eapol max-request 10
Switch:1(config-if)#eapol port 1/2 quiet-interval 500
```

**Variable definitions**

Use the data in the following table to use the `eapol port` command.

| Variable                                              | Value                                                                                                                                                                                                                                                                                                                                                                                                                  |
|-------------------------------------------------------|------------------------------------------------------------------------------------------------------------------------------------------------------------------------------------------------------------------------------------------------------------------------------------------------------------------------------------------------------------------------------------------------------------------------|
| {slot/port[/sub-port] [-slot/port[/sub-port]] [,...]} | Specifies the port or list of ports used by EAP.<br><br>Identifies the slot and port in one of the following formats: a single slot and port (slot/port), a range of slots and ports (slot/port-slot/port), or a series of slots and ports (slot/port,slot/port,slot/port). If your platform supports channelization and the port is channelized, you must also specify the sub-port in the format slot/port/sub-port. |
| max-request <1-10>                                    | Specifies the maximum EAP requests sent to the supplicant before timing out the session. The default is 2.                                                                                                                                                                                                                                                                                                             |
| quiet-interval <1-65535>                              | Specifies the time interval in seconds between the authentication failure and start of a new authentication. The default is 60.                                                                                                                                                                                                                                                                                        |

*Table continues...*

| Variable                           | Value                                                                                                                                                                                                                                                                                                                                                                                                                                                  |
|------------------------------------|--------------------------------------------------------------------------------------------------------------------------------------------------------------------------------------------------------------------------------------------------------------------------------------------------------------------------------------------------------------------------------------------------------------------------------------------------------|
| re-authentication enable           | Enables reauthentication of an existing supplicant at a specified time interval.                                                                                                                                                                                                                                                                                                                                                                       |
| re-authentication-period <1-65535> | Specifies the time interval in seconds between successive reauthentications. The default is 3600 (1 hour).<br><br> <b>Note:</b><br>The EAP re-authentication period value is between 1–65535. Early releases support up to 2147483647. To maintain backward compatibility the CLI value is between 1–2147483647. Trying to configure above 65535 results in an error. |
| status {authorized auto}           | Specifies the desired EAP authentication status for this port.                                                                                                                                                                                                                                                                                                                                                                                         |

## Configuring an EAP-enabled RADIUS server

The switch uses RADIUS servers for authentication and accounting services. Use the no form to delete a RADIUS server.

### Before you begin

- You must enable EAP globally.

### About this task

The RADIUS server uses the secret key to validate users.

RADIUS supports IPv4 and IPv6 addresses, with no difference in functionality or configuration.

### Procedure

1. Enter Global Configuration mode:

```
enable
configure terminal
```

2. Add an EAP-enabled RADIUS server:

```
radius server host WORD <0-46> used-by eapol acct-enable
radius server host WORD <0-46> used-by eapol acct-port <1-65536>
radius server host WORD <0-46> used-by eapol enable
radius server host WORD <0-46> used-by eapol key WORD<0-20>
radius server host WORD <0-46> used-by eapol port <1-65536>
radius server host WORD <0-46> used-by eapol priority <1-10>
radius server host WORD <0-46> used-by eapol retry <0-6>
radius server host WORD <0-46> used-by eapol source-ip WORD <0-46>
```

```
radius server host WORD <0-46> used-by eapol timeout <1-20>
```

By default, the switch uses RADIUS UDP port 1812 for authentication, and port 1813 for accounting. You can change the port numbers or other RADIUS server options.

**Example**

```
Switch:1> enable
```

```
Switch:1# configure terminal
```

Add an EAP RADIUS server:

```
Switch:1(config)# radius server host fe80:0:0:0:21b:4fff:fe5e:73fd key radiustest used-by eapol
```

**Variable definitions**

Use the data in the following table to configure an EAP-enabled RADIUS server with the **radius server host** command.

| Variable                | Value                                                                                                                                           |
|-------------------------|-------------------------------------------------------------------------------------------------------------------------------------------------|
| host <i>WORD</i> <0-46> | Specifies the IP address of the selected server. RADIUS supports IPv4 and IPv6 addresses, with no difference in functionality or configuration. |
| <i>WORD</i> <0-20>      | Specifies the secret key, which is a string of up to 20 characters.                                                                             |

Use the data in the following table to use optional arguments of the **radius server host** command.

| Variable                     | Value                                                                                                                   |
|------------------------------|-------------------------------------------------------------------------------------------------------------------------|
| port <1-65535>               | Specifies the port ID number.                                                                                           |
| priority <1-10>              | Specifies the priority number. The lowest number is the highest priority.                                               |
| retry <0-6>                  | Specifies the retry count of the account.                                                                               |
| timeout <1-10>               | Specifies the timeout of the server. The default is 30.                                                                 |
| enable                       | Enables the functions used by the RADIUS server host.                                                                   |
| acct-port <1-65536>          | Specifies the port account.                                                                                             |
| acct-enable                  | Enables the account.                                                                                                    |
| source-ip <i>WORD</i> <0-46> | Specifies the IP source. RADIUS supports IPv4 and IPv6 addresses, with no difference in functionality or configuration. |

---

**Configuring the switch for EAP and RADIUS**

Perform the following procedure to configure the switch for EAP and RADIUS.



## About this task

You must configure the switch, through which user-based-policy (UBP) users connect to communicate with the RADIUS server to exchange EAP authentication information, as well as user role information. You must specify the IP address of the RADIUS server, as well as the shared secret (a password that authenticates the device with the RADIUS server as an EAP access point). You must enable EAP globally on each device, and you must configure EAP authentication on each device port, through which EAP/UBP users connect.

RADIUS supports IPv4 and IPv6 addresses, with no difference in functionality or configuration.

For more information about EPM and UBP, see the user documentation for your Enterprise Policy Manager (EPM) application.

## Procedure

1. Enter Global Configuration mode:

```
enable
configure terminal
```

2. Create a RADIUS server that is used by EAP:

```
radius server host WORD <0-46> key WORD<0-20> used-by eapol
```

3. Log on to the Interface Configuration mode:

```
interface vlan <1-4059>
```

4. Enable the device to communicate through EAP:

```
eapol enable
```

5. Exit from VLAN interface mode:

```
exit
```

6. Enter Interface Configuration mode:

```
interface GigabitEthernet {slot/port[/sub-port] [-slot/port[/sub-
port]][, ...]}
```

7. Enable device ports for EAP authentication:

```
eapol port {slot/port[/sub-port] [-slot/port[/sub-port]][, ...]}
status auto
```

8. Enable periodic supplicant re-authenticating:

```
eapol port {slot/port[/sub-port] [-slot/port[/sub-port]][, ...]} re-
authentication enable
```

9. Save your changes:

```
save config
```

## Example

```
Switch:1> enable
```

```
Switch:1# configure terminal
```

**Create a RADIUS server that is used by EAP:**

```
Switch:1(config)# radius server host fe90:0:0:0:21b:4eee:fe5e:75fd key radiustest used-by eapol
```

```
Switch:1(config)# interface vlan 2
```

**Enable the device to communicate through EAP:**

```
Switch:1(config-if)# eapol enable
```

**Save your changes:**

```
Switch:1(config-if)# save config
```

## Variable definitions

Use the data in the following table to use the `radius server host WORD<0-46> usedby eapol` command.

| Variable                     | Value                                                                                                                                                                                                                                                                                                                                                                        |
|------------------------------|------------------------------------------------------------------------------------------------------------------------------------------------------------------------------------------------------------------------------------------------------------------------------------------------------------------------------------------------------------------------------|
| host <i>WORD&lt;0-46&gt;</i> | <p>Specifies the IP address of the selected server.</p> <p>This address tells the device where to find the RADIUS server, from which it obtains EAP authentication and user role information.</p> <p>RADIUS supports IPv4 and IPv6 addresses, with no difference in functionality or configuration.</p>                                                                      |
| key <i>WORD&lt;0-20&gt;</i>  | <p>Specifies the shared secret key that you use for RADIUS authentication. The shared secret is held in common by the RADIUS server and all EAP-enabled devices in your network. It authenticates each device with the RADIUS server as an EAP access point. When you configure your RADIUS server, you must configure the same shared secret value as you specify here.</p> |

---

## Changing the authentication status of a port

The switch authorizes ports by default, which means that the ports are always authorized and are not authenticated by the RADIUS server.

You can also make the ports controlled so that they are dependent on being authorized by the Radius Server when you globally enable EAP (auto).

### Procedure

1. Enter GigabitEthernet Interface Configuration mode:

```
enable
```

```
configure terminal
```

```
interface GigabitEthernet {slot/port[/sub-port] [-slot/port[/sub-port]][,...]}
```

**\* Note:**

If your platform supports channelization and the port is channelized, you must also specify the sub-port in the format slot/port/sub-port.

2. Configure the authorization status of a port:

```
eapol status {authorized|auto}
```

**Example**

```
Switch:1> enable
```

```
Switch:1# configure terminal
```

```
Switch:1(config)# interface GigabitEthernet 3/1
```

Configure the authorization status of a port:

```
Switch:1(config-if)# eapol status auto
```

**Variable definitions**

Use the data in the following table to use the `eapol status` command.

| Variable   | Value                                                                                                                                     |
|------------|-------------------------------------------------------------------------------------------------------------------------------------------|
| authorized | Specifies that the port is always authorized. The default value is authorized.                                                            |
| auto       | Specifies that port authorization depends on the results of the EAP authentication by the RADIUS server. The default value is authorized. |

**Deleting an EAP-enabled RADIUS server**

Delete an EAP-enabled RADIUS server if you want to remove the server.

**About this task**

RADIUS supports IPv4 and IPv6 addresses, with no difference in functionality or configuration.

**Procedure**

1. Enter Global Configuration mode:

```
enable
```

```
configure terminal
```

2. Delete an EAP-enabled RADIUS server:

```
no radius server host WORD<0-46> used-by eapol
```

**Example**

```
Switch:1> enable
```

```
Switch:1# configure terminal
```

```
Switch:1(config)# no radius server host fe79:0:0:0:21d:4fdf:fe5e:73fd
used-by eapol
```

## Variable definitions

Use the data in the following table to use the `radius server host WORD<0-46> usedby eapol` command.

| Variable                | Value                                                                                                                                                                                                                                                                                                                                                                        |
|-------------------------|------------------------------------------------------------------------------------------------------------------------------------------------------------------------------------------------------------------------------------------------------------------------------------------------------------------------------------------------------------------------------|
| host <i>WORD</i> <0-46> | <p>Specifies the IP address of the selected server.</p> <p>This address tells the device where to find the RADIUS server, from which it obtains EAP authentication and user role information.</p> <p>RADIUS supports IPv4 and IPv6 addresses, with no difference in functionality or configuration.</p>                                                                      |
| key <i>WORD</i> <0-20>  | <p>Specifies the shared secret key that you use for RADIUS authentication. The shared secret is held in common by the RADIUS server and all EAP-enabled devices in your network. It authenticates each device with the RADIUS server as an EAP access point. When you configure your RADIUS server, you must configure the same shared secret value as you specify here.</p> |

---

## Configuring Fail Open VLAN

### About this task

Use this procedure to configure Fail Open VLAN.

### Procedure

1. Enter GigabitEthernet Interface Configuration mode:

```
enable

configure terminal

interface GigabitEthernet {slot/port[/sub-port] [-slot/port[/sub-
port]] [,...]}
```

**\* Note:**

If your platform supports channelization and the port is channelized, you must also specify the sub-port in the format slot/port/sub-port.

2. Configure Fail Open VLAN:

```
eapol fail-open-vlan <1-4059>
```

### Example

Configure the Fail Open VLAN.

```
Switch:1>enable
Switch:1#configure terminal
```

```
Switch:1(config)#interface gigabitEthernet 1/1
Switch:1(config)#eapol fail-open-vlan 10
```

## Variable definitions

Use the data in the following table to use the `eapol fail-open-vlan` command.

| Variable | Value                                                                                                                                                                                                                                                                                                                                                                                                                                  |
|----------|----------------------------------------------------------------------------------------------------------------------------------------------------------------------------------------------------------------------------------------------------------------------------------------------------------------------------------------------------------------------------------------------------------------------------------------|
| <1-4059> | Specifies the VLAN ID in the range of 1 to 4059. By default, VLAN IDs 1 to 4059 are configurable and the system reserves VLAN IDs 4060 to 4094 for internal use. On switches that support the <code>vrf-scaling</code> and <code>spbm-config-mode</code> boot configuration flags, if you enable these flags, the system also reserves VLAN IDs 3500 to 3998. VLAN ID 1 is the default VLAN and you cannot create or delete VLAN ID 1. |

## Displaying the current EAP-based security status

Use the following procedure to display the status of the EAP-based security.

### Procedure

1. Enter Privileged EXEC mode:

```
enable
```

2. Display the current EAP-based security status:

```
show eapol auth-stats interface [gigabitEthernet {slot/port[/sub-
port]} [-slot/port[/sub-port]] [,...]]
```

```
show eapol multihost non-eap-mac status [vlan <1-4059>] [{slot/
port[/sub-port]} [-slot/port[/sub-port]] [,...]]
```

```
show eapol port {interface [gigabitEthernet {slot/port[/sub-port]} [-
slot/port[/sub-port]] [,...]] | {slot/port[/sub-port]} [-slot/port[/
sub-port]] [,...]]
```

```
show eapol session-stats interface [gigabitEthernet {slot/port[/sub-
port]} [-slot/port[/sub-port]] [,...]]
```

```
show eapol status interface [vlan <1-4059>] [gigabitEthernet {slot/
port[/sub-port]} [-slot/port[/sub-port]] [,...]]
```

```
show eapol system
```

### Example

```
Switch:#enable
Switch:1#show eapol system
```

```
=====
 Eapol System
=====
 eap : disabled
 Eapol Version : 3
```

```

non-eap-pwd-fmt : ip-addr.mac-addr.port-number
non-eap-pwd-fmt key :
non-eap-pwd-fmt padding : disabled

```

```

Switch:#enable
Switch:1#show eapol port interface gigabitEthernet

 Eapol Configuration

PORT STATUS OPER MAX QUIET REAUTH REAUTH NON-EAP MAX MAX MAX GST FA
NUM MODE REQ INTVL PERIOD ENABLE ENABLE ENABLE MAC EAP NEAP VLAN VL

1/1 Auth MHMV 2 60 3600 false false 8 1 1 N/A N/A
1/2 Auth MHMV 2 60 3600 false false 1 1 1 10 N/A
1/3 Auth MHSA 2 60 3600 false false 1 1 1 20 N/A

```

## Variable definitions

Use the data in the following table to use the **show eapol** command.

| Variable                                                                                                                                  | Value                                                                                                                                                                                                                                                                              |
|-------------------------------------------------------------------------------------------------------------------------------------------|------------------------------------------------------------------------------------------------------------------------------------------------------------------------------------------------------------------------------------------------------------------------------------|
| auth-stats [gigabitEthernet {slot/port/sub-port} [-slot/port/sub-port]] [...]]                                                            | Displays the authentication statistics interface.<br><br>* <b>Note:</b><br>auth-stats [gigabitEthernet {slot/port/sub-port} [-slot/port/sub-port]] [...]] is useful only for EAP supplicants. The command output changes only when the EAP supplicant tries to access the network. |
| multihost non-eap-mac status [vlan <1-4059>] [{slot/port/sub-port} [-slot/port/sub-port]] [...]]                                          | Displays EAP multihost configuration.                                                                                                                                                                                                                                              |
| port {interface [gigabitEthernet {slot/port/sub-port} [-slot/port/sub-port]] [...]]   {slot/port/sub-port} [-slot/port/sub-port]] [...]]} | Specifies the ports to display. If no port is entered, all ports are displayed.                                                                                                                                                                                                    |
| session-stats interface [gigabitEthernet {slot/port/sub-port} [-slot/port/sub-port]] [...]]                                               | Displays the authentication session statistics interface.                                                                                                                                                                                                                          |
| status interface [vlan <1-4059>] [gigabitEthernet {slot/port/sub-port} [-slot/port/sub-port]] [...]]                                      | Displays the port EAP operation statistics.                                                                                                                                                                                                                                        |
| system                                                                                                                                    | Displays EAP settings.                                                                                                                                                                                                                                                             |

## Displaying the port VLAN information

Use the following procedure to display the port VLAN information.

### Procedure

1. Enter Privileged EXEC mode:

```
enable
```

## 2. Display the port VLAN information:

```
show interfaces [gigabitEthernet {slot/port[/sub-port] [-slot/port[/sub-port]] [,...]] [vlan <1-4059>]
```

### Example

```
Switch:#enable
Switch:1#show interfaces gigabitethernet vlan
=====
 Port Vlans
=====
PORT DISCARD DISCARD DEFAULT VLAN PORT UNTAG DYNAMIC UNTAG
NUM TAGGING TAGFRAM UNTAGFRAM VLANID IDS TYPE DEFVLAN VLANS VLANS

1/1 disable false false 1 1 normal disable P 1
1/2 enable false false 1 1,3,10 normal disable P 1,10
1/3 enable false false 1 1,10,20 normal disable P
```

## Variable definitions

Use the data in the following table to use the **show interfaces** command.

| Variable                                                     | Value                                                                                                                                                                                                                                                                                                                                                                                                        |
|--------------------------------------------------------------|--------------------------------------------------------------------------------------------------------------------------------------------------------------------------------------------------------------------------------------------------------------------------------------------------------------------------------------------------------------------------------------------------------------|
| <i>{slot/port[/sub-port] [-slot/port[/sub-port]] [,...]}</i> | Identifies the slot and port in one of the following formats: a single slot and port (slot/port), a range of slots and ports (slot/port-slot/port), or a series of slots and ports (slot/port,slot/port,slot/port). If your platform supports channelization and the port is channelized, you must also specify the sub-port in the format slot/port/sub-port.                                               |
| <i>&lt;1-4059&gt;</i>                                        | Specifies the VLAN ID in the range of 1 to 4059. By default, VLAN IDs 1 to 4059 are configurable and the system reserves VLAN IDs 4060 to 4094 for internal use. On switches that support the vrf-scaling and spbm-config-mode boot configuration flags, if you enable these flags, the system also reserves VLAN IDs 3500 to 3998. VLAN ID 1 is the default VLAN and you cannot create or delete VLAN ID 1. |

## Configuring the format of the RADIUS password attribute when authenticating NEAP MAC addresses using RADIUS

Use the following procedure to configure the format of the RADIUS password when authenticating NEAP MAC addresses using RADIUS.

### Procedure

#### 1. Enter Global Configuration mode:

```
enable
configure terminal
```

2. Configure the RADIUS password format:

```
eapol multihost non-eap-pwd-fmt {[ip-addr] [key WORD<1-32>] [mac-addr] [padding] [port-number]}
```

**Variable definitions**

Use the data in the following table to use the `eapol multihost non-eap-pwd-fmt` command.

| Variable       | Value                                                              |
|----------------|--------------------------------------------------------------------|
| ip-addr        | Management ip-address of the switch.                               |
| key WORD<1-32> | Key value used for non-eap password format.                        |
| mac-addr       | Mac-Address of the client.                                         |
| padding        | Includes a dot in the RADIUS password for every missing parameter. |
| port-number    | Index of the port on which MAC is received.                        |

**\* Note:**

To derive the port number for an interface, use the command `show interfaces gigabit [ {slot/port[/sub-port] [-slot/port[/sub-port]] [, ...] }` .

If you configure interface 1/6 on the product, to derive the port-number for this interface, use the command `show interfaces gigabitEthernet 1/6`. From this command, you can ascertain that port number used in the NEAP password is 197.

```
Switch:1(config)# show interfaces gigabitEthernet 1/6
=====
Port Interface
=====
PORT LINK PORT PHYSICAL STATUS
NUM INDEX DESCRIPTION TRAP LOCK MTU ADDRESS ADMIN OPERATE

1/6 197 1000BaseTX true false 1950 f8:15:47:e1:dd:05 up up
```

**Enabling RADIUS authentication of NEAP hosts on EAP enabled ports**

For RADIUS authentication of NEAP hosts on EAP-enabled ports, you must enable EAP globally on the switch and then enable NEAP hosts on the local interface.

**Procedure**

1. Enter GigabitEthernet Interface Configuration mode:

```
enable
configure terminal
```



```
interface GigabitEthernet {slot/port[/sub-port] [-slot/port[/sub-
port]] [, ...]}
```

**\* Note:**

If your platform supports channelization and the port is channelized, you must also specify the sub-port in the format slot/port/sub-port.

2. Enable RADIUS authentication of NEAP hosts on the local interface:

```
eapol multihost radius-non-eap-enable
```

---

## Configuring the maximum MAC clients

Use this procedure to configure the maximum EAP and NEAP MAC clients supported on a port.

### Procedure

1. Enter Interface Configuration mode:

```
enable
```

```
configure terminal
```

```
interface GigabitEthernet {slot/port[/sub-port] [-slot/port[/sub-
port]] [, ...]} or interface vlan <1-4059>
```

**\* Note:**

If your platform supports channelization and the port is channelized, you must also specify the sub-port in the format slot/port/sub-port.

2. Set the maximum limit of allowed EAP and NEAP MAC clients supported on the port:

```
eapol multihost mac-max <1-32>
```

### Example

```
Switch:1> enable
Switch:1# configure terminal
Switch:1(config)# interface GigabitEthernet 1/16
Switch:1(config-if)# eapol multihost mac-max <1-32>
```

## Variable definitions

Use the data in the following table to use the `eapol multihost mac-max` command.

| Variable       | Value                                                                                                                  |
|----------------|------------------------------------------------------------------------------------------------------------------------|
| mac-max <1-32> | Specifies the maximum number of EAP and NEAP MAC addresses allowed on the port. The maximum limit is 32 MAC addresses. |

## Configuring maximum EAP clients

### About this task

Use this procedure to configure the maximum EAP clients allowed on the port at one time.

### Procedure

1. Enter GigabitEthernet Interface Configuration mode:

```
enable
configure terminal
interface GigabitEthernet {slot/port[/sub-port] [-slot/port[/sub-port]] [,...]}
```

**\* Note:**

If your platform supports channelization and the port is channelized, you must also specify the sub-port in the format slot/port/sub-port.

2. Configure the maximum EAP clients:

```
eapol multihost eap-mac-max <0-32>
```

**\* Note:**

eap-mac-max is also used to provide EAP and NEAP separation functionality. By default the EAP clients are enabled per port and eap-mac-max limit is 1. If eap-mac-max is set to 0 then EAP client authentication is disabled.

### Example

Configure the maximum EAP clients allowed on the port at one time.

```
Switch:1>enable
Switch:1#configure terminal
Switch:1(config)#interface gigabitEthernet 1/1
Switch:1(config)#eapol multihost eap-mac-max 10
```

## Variable definitions

Use the data in the following table to use the `eapol multihost eap-mac-max` command.

| Variable | Value                                                                                |
|----------|--------------------------------------------------------------------------------------|
| <0-32>   | Specifies the maximum EAP clients allowed on the port at one time. The default is 1. |

## Configuring maximum NEAP clients

### About this task

Use this procedure to configure the maximum NEAP clients allowed on the port at one time.

## Procedure

1. Enter GigabitEthernet Interface Configuration mode:

```
enable
configure terminal
interface GigabitEthernet {slot/port[/sub-port] [-slot/port[/sub-
port]] [,...]}
```

**\* Note:**

If your platform supports channelization and the port is channelized, you must also specify the sub-port in the format slot/port/sub-port.

2. Configure the maximum NEAP clients:

```
eapol multihost non-eap-mac-max <0-32>
```

**\* Note:**

non-eap-mac-max is also used to provide EAP and NEAP separation functionality. By default the NEAP clients are enabled per port and non-eap-mac-max limit is 1. If non-eap-mac-max is set to 0 then NEAP client authentication is disabled.

## Example

Configure the maximum NEAP clients allowed on the port at one time.

```
Switch:1>enable
Switch:1#configure terminal
Switch:1(config)#interface gigabitEthernet 1/1
Switch:1(config)#eapol multihost non-eap-mac-max 10
```

## Variable definitions

Use the data in the following table to use the **eapol multihost non-eap-mac-max** command.

| Variable | Value                                                                                 |
|----------|---------------------------------------------------------------------------------------|
| <0-32>   | Specifies the maximum NEAP clients allowed on the port at one time. The default is 1. |

---

## Configuring the Guest VLAN ID

### About this task

Use this procedure to configure the Guest VLAN ID.

### Procedure

1. Enter GigabitEthernet Interface Configuration mode:

```
enable
configure terminal
```

```
interface GigabitEthernet {slot/port[/sub-port] [-slot/port[/sub-port]] [,...]}
```

**\* Note:**

If your platform supports channelization and the port is channelized, you must also specify the sub-port in the format slot/port/sub-port.

2. Configure the Guest VLAN ID:

```
eapol guest-vlan <1-4059>
```

**Example**

Configure the Guest VLAN ID.

```
Switch:1>enable
Switch:1#configure terminal
Switch:1(config)#interface gigabitEthernet 1/1
Switch:1(config)#eapol guest-vlan 10
```

**Variable definitions**

Use the data in the following table to use the `eapol guest-vlan` command.

| Variable | Value                                                                                                                                                                                                                                                                                                                                                                                                        |
|----------|--------------------------------------------------------------------------------------------------------------------------------------------------------------------------------------------------------------------------------------------------------------------------------------------------------------------------------------------------------------------------------------------------------------|
| <1-4059> | Specifies the VLAN ID in the range of 1 to 4059. By default, VLAN IDs 1 to 4059 are configurable and the system reserves VLAN IDs 4060 to 4094 for internal use. On switches that support the vrf-scaling and spbm-config-mode boot configuration flags, if you enable these flags, the system also reserves VLAN IDs 3500 to 3998. VLAN ID 1 is the default VLAN and you cannot create or delete VLAN ID 1. |

**Clearing NEAP session**

Use this procedure to clear the NEAP session that is learnt on the switch.

**Procedure**

1. Enter Global Configuration mode:

```
enable
configure terminal
```

2. Clear the NEAP session:

```
clear eapol non-eap [<0x00:0x00:0x00:0x00:0x00:0x00>] [{slot/port[/sub-port] [-slot/port[/sub-port]] [,...]}
<0x00:0x00:0x00:0x00:0x00:0x00>]
```

## Example

```
Switch:1> enable
Switch:1# configure terminal
Switch:1(config)# clear 1/16 00:1b:63:84:45:e6
```

## Variable definitions

Use the data in the following table to use the `clear eapol non-eap` command.

| Variable                                                           | Value                                                    |
|--------------------------------------------------------------------|----------------------------------------------------------|
| <code>{slot/port[/sub-port] [-slot/port[/sub-port]][, ...]}</code> | Specifies the port list on which the NEAP MAC is learnt. |
| <code>0x00:0x00:0x00:0x00:0x00:0x00</code>                         | Specifies the MAC-Address on the NEAP session.           |

## Configuring EAP operational mode

### About this task

Use this procedure to configure the EAP operational mode.

### Procedure

1. Enter GigabitEthernet Interface Configuration mode:

```
enable
configure terminal
interface GigabitEthernet {slot/port[/sub-port] [-slot/port[/sub-port]][, ...]}
```

**\* Note:**

If your platform supports channelization and the port is channelized, you must also specify the sub-port in the format slot/port/sub-port.

2. configure the EAP operational mode:

```
eapol multihost eap-oper-mode {mhmhv | mhsa}
```

**\* Note:**

The default EAP operational mode is MHMV.

### Example

Configure the EAP operational mode:

```
Switch:1>enable
Switch:1#configure terminal
Switch:1(config)#interface gigabitEthernet 1/1
Switch:1(config)#eapol eap-oper-mode mhsa
```

## Variable definitions

Use the data in the following table to use the `eapol multihost eap-oper-mode` command.

| Variable   | Value                                                                      |
|------------|----------------------------------------------------------------------------|
| <i>mhm</i> | Specifies the EAP operational mode as Multiple Host Multiple VLAN.         |
| <i>mhs</i> | Specifies the EAP operational mode as Multiple Host Single Authentication. |

---

## EAP configuration using Enterprise Device Manager

EAPoL (EAP) uses RADIUS protocol for EAP-authorized logons. RADIUS supports IPv4 and IPv6 addresses with no difference in functionality or configuration in all but the following case. When adding a RADIUS server in Enterprise Device Manager (EDM) or modifying a RADIUS configuration in EDM, you must specify if the address type is an IPv4 or an IPv6 address.

### Before you begin

- Before configuring your device, you must configure at least one EAP RADIUS server and shared secret fields.
- You cannot configure EAP on ports that are currently configured for:
  - Shared segments
  - MultiLink Trunking (MLT)
- Change the status of each port that you want to be controlled to auto. For more information on changing the status, see [Configuring EAP on a port](#) on page 215. The auto setting automatically authenticates the port according to the results of the RADIUS server. The default authentication setting for each port is force-authorized.
- You can connect only a single client on each port configured for EAP. If you attempt to add additional clients on the EAP authorized port, the client traffic will be blocked from the switch till mac-ageing occurs for that client.

---

## Globally configuring EAP on the server

### About this task

Globally enable or disable EAP on the switch. By default, EAP is disabled.

### Procedure

1. In the navigation tree, expand the following folders: **Configuration** > **Security** > **Data Path**.
2. Click **802.1x - EAPOL**.
3. Click the **Global** tab.

4. From the AccessControl options, select **enable**.
5. **(Optional)** Select the appropriate **NonEapRadiusPwdAttrFmt** check boxes to configure the format of the RADIUS password when authenticating non-EAP MAC addresses using RADIUS.
6. **(Optional)** Enter the key string in the **NonNonEapRadiusPwdAttkeystring** field.
7. **(Optional)** Check the **ClearNonEap** check box to clear the NEAP session that is learned on the switch.
8. Click **Apply**.

## Global field descriptions

Use the data in the following table to use the **Global** tab.

| Name                                | Description                                                                                                                                                                                                                                                                                |
|-------------------------------------|--------------------------------------------------------------------------------------------------------------------------------------------------------------------------------------------------------------------------------------------------------------------------------------------|
| <b>EapolVersion</b>                 | Displays the EAP version on the switch.                                                                                                                                                                                                                                                    |
| <b>AccessControl</b>                | Enables system authentication control. EAP is disabled by default.                                                                                                                                                                                                                         |
| <b>NonEapRadiusPwdAttrFmt</b>       | Specifies the password attribute format for non EAP RADIUS authentication. <ul style="list-style-type: none"> <li>• ipAdd: Specifies IP address.</li> <li>• macAddr: Specifies MAC address.</li> <li>• portNumber: Specifies port number</li> <li>• padding: Specifies padding.</li> </ul> |
| <b>NonEapRadiusPwdAttrKeyString</b> | Specifies the attribute key string for non EAP RADIUS password. The range is 0– 32 characters.                                                                                                                                                                                             |
| <b>ClearNonEap</b>                  | Clears the NEAP session that is learned on the switch.                                                                                                                                                                                                                                     |

---

## Configuring EAP on a port

### About this task

Configure EAP or change the authentication status on one or more ports.

Ports are force-authorized by default. Force-authorized ports are always authorized and are not authenticated by the RADIUS server. You can change this setting so that the ports are always unauthorized.

### Procedure

1. In the Device Physical View tab, select the port you need to configure.
2. In the navigation tree, expand the following folders: **Configuration > Edit > Port**.
3. Click **General**.

4. Click the **EAPOL** tab.
5. **(Optional)** Select the **AllowNonEapHost** check box to allow hosts that do not participate in 802.1X authentication to get network access.
6. Select the **Status** option as **auto** or **forceAuthorized**.
7. In the **MultiHostMaxClients** field, type the maximum limit of allowed EAP and NEAP clients supported on this port.
8. In the **GuestVLANId** field, type the VLAN ID to be used as a Guest VLAN ID.
9. In the **FailOpenVlanId** field, type the Fail Open VLAN ID.
10. In the **NonEapMaxClients** field, type the maximum number NEAP authentication MAC addresses allowed on this port.
11. In the **EapMaxClients** field, type the maximum number of EAP authentication MAC addresses allowed on this port.
12. Select the **MultiHostSingleAuthEnabled** check box to automatically authenticate NEAP MAC addresses on this port.
13. Select the **ReAuthEnabled** field.
14. In the **QuietPeriod** field, type the time interval.
15. In the **ReauthPeriod** field, type the time between reauthentication.
16. In the **RetryMax** field, type the number of times.
17. Click **Apply**.

## EAPoL field descriptions

Use the data in the following table to use the **EAPoL** tab.

| Name                           | Description                                                                                                                                                                                                                                                                                                                                                                                                                                                                                                                                                                                                 |
|--------------------------------|-------------------------------------------------------------------------------------------------------------------------------------------------------------------------------------------------------------------------------------------------------------------------------------------------------------------------------------------------------------------------------------------------------------------------------------------------------------------------------------------------------------------------------------------------------------------------------------------------------------|
| <b>PortCapabilities</b>        | <p>Displays the capabilities of the Port Access Entity (PAE) associated with the port. This parameter indicates whether Authenticator functionality, supplicant functionality, both, or neither, is supported by the PAE of the port.</p> <p>The following capabilities are supported by the PAE of the port:</p> <ul style="list-style-type: none"> <li>• <b>authImplemented</b>: A Port Access Controller Protocol (PACP) Extensible Authentication Protocol (EAP) authenticator functions are implemented.</li> <li>• <b>virtualPortsImplemented</b>: Virtual Port functions are implemented.</li> </ul> |
| <b>PortVirtualPortsEnable</b>  | <p>Displays the status of the Virtual Ports function for the real port as True or False.</p>                                                                                                                                                                                                                                                                                                                                                                                                                                                                                                                |
| <b>PortCurrentVirtualPorts</b> | <p>Displays the current number of virtual ports running in the port</p>                                                                                                                                                                                                                                                                                                                                                                                                                                                                                                                                     |

*Table continues...*



| Name                               | Description                                                                                                                                                                                                                                                                                                                                                   |
|------------------------------------|---------------------------------------------------------------------------------------------------------------------------------------------------------------------------------------------------------------------------------------------------------------------------------------------------------------------------------------------------------------|
| <b>PortAuthenticatorEnable</b>     | Displays the status of the Authenticator function in the Port Access Entity (PAE) as True or False.                                                                                                                                                                                                                                                           |
| <b>PortSupplicantEnable</b>        | Displays the Supplicant function in the Port Access Entity (PAE) as True or False.                                                                                                                                                                                                                                                                            |
| <b>AllowNonEapHost</b>             | Enables the system to allow hosts that do not participate in 802.1X authentication to get network access. The default is disabled.                                                                                                                                                                                                                            |
| <b>Status</b>                      | Configures the authentication status for this port. The default is forceAuthorized. <ul style="list-style-type: none"> <li>• auto: enables the EAP authentication process by sending the EAP request messages to the RADIUS server.</li> <li>• forceAuthorized: disables the EAP authentication and puts the port into force-full authorized mode.</li> </ul> |
| <b>MultiHostMaxClients</b>         | Specifies the value representing the maximum number of supplicants allowed to get authenticated on the port.                                                                                                                                                                                                                                                  |
| <b>GuestVLANId</b>                 | Specifies the VLAN to be used as a Guest VLAN. Access to unauthenticated hosts connected to this port is provided through this VLAN. 0 indicates that Guest VLAN is not enabled for this port.                                                                                                                                                                |
| <b>FailOpenVlanId</b>              | Specifies the Fail Open VLAN ID for this port. If the switch declares the RADIUS servers unreachable, then all new devices are allowed access into the configured Fail Open VLAN. 0 indicates that Fail Open VLAN is not enabled for this port.                                                                                                               |
| <b>NonEapMaxClients</b>            | Specifies the maximum number of NEAP authentication MAC addresses allowed on this port. Zero indicates that NEAP authentication is disabled for this port.                                                                                                                                                                                                    |
| <b>EAPMaxClients</b>               | Specifies the maximum number of EAP authentication MAC addresses allowed on this port. Zero indicates that EAP authentication is disabled for this port.                                                                                                                                                                                                      |
| <b>MultiHostSingleAuthEnabled</b>  | Indicates that the unauthenticated devices can access the network only after an EAP or NEAP client is successfully authenticated on the port. The VLAN to which the devices are allowed access is the authenticated client's VLAN. The default is false.                                                                                                      |
| <b>Authenticator configuration</b> | Displays the current Authenticator Port Access Entity (PAE) state.<br>The states are: <ul style="list-style-type: none"> <li>• authenticate</li> <li>• authenticated</li> <li>• Failed</li> </ul>                                                                                                                                                             |

*Table continues...*

| Name                 | Description                                                                                                                                                                                                 |
|----------------------|-------------------------------------------------------------------------------------------------------------------------------------------------------------------------------------------------------------|
| <b>ReAuthEnabled</b> | Reauthenticates an existing supplicant at the time interval specified in ReAuthPeriod. The default is disabled.                                                                                             |
| <b>QuietPeriod</b>   | Configures the time interval (in seconds) between authentication failure and the start of a new authentication.                                                                                             |
| <b>ReAuthPeriod</b>  | Reauthenticates an existing supplicant at the time interval specified in ReAuthPeriod.<br><br>Configures the time interval (in seconds) between successive reauthentications. The default is 3600 (1 hour). |
| <b>RetryMax</b>      | Specifies the maximum Extensible Authentication Protocol (EAP) requests sent to the supplicant before timing out the session. The default is 2.                                                             |
| <b>RetryCount</b>    | Specifies the maximum number of retries attempted.                                                                                                                                                          |

## Showing the Port Access Entity Port table

### About this task

Use the Port Access Entity (PAE) Port Table to display system-level information for each port the PAE supports. An entry appears in this table for each port of this system.

### Procedure

1. In the navigation tree, expand the following folders: **Configuration > Security > Data Path**.
2. Click **802.1x - EAPOL**.
3. Click the **EAP Security** tab.

## EAP Security field descriptions

Use the data in the following table to use the **EAP Security** tab.

| Name                           | Description                                                                                                                                                                                                                                                           |
|--------------------------------|-----------------------------------------------------------------------------------------------------------------------------------------------------------------------------------------------------------------------------------------------------------------------|
| <b>PortNumber</b>              | Indicates the port number associated with this port.                                                                                                                                                                                                                  |
| <b>PortCapabilities</b>        | Indicates the capabilities of this PAE port. <ul style="list-style-type: none"> <li>• authImplemented—PACP EAP authenticator functions are implemented in this PAE.</li> <li>• virtualPortsImplemented—Virtual Port functions are implemented in this PAE.</li> </ul> |
| <b>PortVirtualPortsEnable</b>  | Displays the status of the Virtual Ports function for the real port as True or False.                                                                                                                                                                                 |
| <b>PortCurrentVirtualPorts</b> | Displays the current number of virtual ports running in the port                                                                                                                                                                                                      |

*Table continues...*

| Name                              | Description                                                                                                                                                                                                                                              |
|-----------------------------------|----------------------------------------------------------------------------------------------------------------------------------------------------------------------------------------------------------------------------------------------------------|
| <b>PortAuthenticatorEnable</b>    | Displays the status of the Authenticator function in the Port Access Entity (PAE) as True or False.                                                                                                                                                      |
| <b>PortSupplicantEnable</b>       | Displays the Supplicant function in the Port Access Entity (PAE) as True or False.                                                                                                                                                                       |
| <b>AllowNonEapHost</b>            | Displays the status if the system is enabled to allow hosts that do not participate in 802.1X authentication to get network access.                                                                                                                      |
| <b>Status</b>                     | Displays the authentication status for this port. The default is forceAuthorized.                                                                                                                                                                        |
| <b>MultiHostMaxClients</b>        | Indicates the value representing the maximum number of supplicants allowed to get authenticated on the port.                                                                                                                                             |
| <b>GuestVLANId</b>                | Displays the VLAN to be used as a Guest VLAN. Access to unauthenticated hosts connected to this port is provided through this VLAN. 0 indicates that Guest VLAN is not enabled for this port.                                                            |
| <b>FailOpenVLANId</b>             | Displays the Fail Open VLAN ID for this port. If the switch declares the RADIUS servers unreachable, then all new devices are allowed access into the configured Fail Open VLAN. 0 indicates that Fail Open VLAN is not enabled for this port.           |
| <b>NonEapMaxClients</b>           | Indicates the maximum number of non-EAPoL authentication MAC addresses allowed on this port. Zero indicates that non-EAPoL authentication is disabled for this port.                                                                                     |
| <b>EapMaxClients</b>              | Indicates the maximum number of EAPoL authentication MAC addresses allowed on this port. Zero indicates that EAPoL authentication is disabled for this port.                                                                                             |
| <b>MultiHostSingleAuthEnabled</b> | Indicates that the unauthenticated devices can access the network only after an EAP or NEAP client is successfully authenticated on the port. The VLAN to which the devices are allowed access is the authenticated client's VLAN. The default is false. |

---

## Showing EAP Authentication

### About this task

Use the Authenticator Configuration table to display configuration objects for the Authenticator PAE associated with each port.

### Procedure

1. In the navigation pane, expand the following folders: **Configuration > Security > Data Path**.
2. Click **802.1x - EAPOL**.
3. Click the **Authentication** tab.

## Authentication field descriptions

Use the data in the following table to use the **Authentication** tab.

| Name                 | Description                                                                                                                                     |
|----------------------|-------------------------------------------------------------------------------------------------------------------------------------------------|
| <b>PortNumber</b>    | Indicates the number associated with this port.                                                                                                 |
| <b>Authenticate</b>  | Indicates the status of the Port Access Entity (PAE) authenticator requesting authentication.                                                   |
| <b>Authenticated</b> | Indicates the current authentication status of the Port Access Entity (PAE) authenticator.                                                      |
| <b>Failed</b>        | Indicates the authentication status for failed or terminated state .                                                                            |
| <b>ReAuthEnabled</b> | Indicates the re-authentication status of an existing supplicant at the time interval specified in ReAuthPeriod. The default is false.          |
| <b>QuietPeriod</b>   | Indicates the time interval (in seconds) between authentication failure and the start of a new authentication.<br>The default is 60.            |
| <b>ReAuthPeriod</b>  | Indicates the time interval in seconds between successive re-authentications. The default is 3600 (1 hour ).                                    |
| <b>RetryMax</b>      | Indicates the maximum Extensible Authentication Protocol (EAP) requests sent to the supplicant before timing out the session. The default is 2. |
| <b>RetryCount</b>    | Indicates the count of the number of authentication attempts.                                                                                   |

---

## Viewing Multihost status information

Use the following procedure to display multiple host status for a port.

### Procedure

1. In the navigation pane, expand the **Configuration --> Security --> Data Path** folders.
2. Click **802.1x-EAPOL**.
3. Click the **MultiHost Status** tab.

## MultiHost status field descriptions

The following table describes values on the **MultiHost Status** tab.

| Name                 | Description                                                         |
|----------------------|---------------------------------------------------------------------|
| <b>PortNumber</b>    | Indicates the port number associated with this port.                |
| <b>ClientMACAddr</b> | Indicates the MAC address of the client.                            |
| <b>PaeState</b>      | Indicates the current state of the authenticator PAE state machine. |
| <b>VlanId</b>        | Indicates the VLAN assigned to the client.                          |

---

## Viewing EAP session statistics

Use the following procedure to display multiple host session information for a port.

### Procedure

1. In the navigation pane, expand the **Configuration --> Security --> Data Path** folders.
2. Click **802.1x-EAPOL**.
3. Click the **MultiHost Session** tab.

## MultiHost session field descriptions

The following table describes values on the **MultiHost Session** tab.

| Name                      | Description                                                                 |
|---------------------------|-----------------------------------------------------------------------------|
| <b>StatsPortNumber</b>    | Indicates the port number associated with this port.                        |
| <b>StatsClientMACAddr</b> | Indicates the MAC address of the client.                                    |
| <b>Id</b>                 | Indicates the unique identifier for the session.                            |
| <b>AuthenticMethod</b>    | Indicates the authentication method used to establish the session.          |
| <b>Time</b>               | Indicates the elapsed time of the session.                                  |
| <b>TerminateCause</b>     | Indicates the cause of the session termination.                             |
| <b>UserName</b>           | Indicates the user name that represents the identity of the supplicant PAE. |

---

## Viewing NEAP MAC information

Use this procedure to view NEAP client MAC information on a port.

### Procedure

1. In the navigation pane, expand the **Configuration --> Security --> Data Path** folders.
2. Click **802.1x-EAPOL**.
3. Click the **NEAP Radius** tab.

## NEAP Radius field descriptions

The following table describes values on the **NEAP Radius** tab.

| Name           | Description                                          |
|----------------|------------------------------------------------------|
| <b>MacPort</b> | Indicates the port number associated with this port. |
| <b>MacAddr</b> | Indicates the MAC address of the client.             |

*Table continues...*

| Name             | Description                                                                                         |
|------------------|-----------------------------------------------------------------------------------------------------|
| <b>MacStatus</b> | Indicates the authentication status of the NEAP host that is authenticated using the RADIUS server. |
| <b>VlanId</b>    | Indicates the VLAN assigned to the client.                                                          |
| <b>MacClear</b>  | Clears the non EAP MAC entry associated with a specific index.                                      |

# Chapter 6: IPsec

The following sections describe Internet Protocol Security (IPsec) and its configuration.

---

## IPsec fundamentals

Internet Protocol Security (IPsec) ensures the authenticity, integrity, and confidentiality of data at the network layer of the Open System Interconnection (OSI) stack.

The IPsec feature is a set of security protocols and cryptographic algorithms that protect communication in a network. Use IPsec in scenarios where you need to encrypt packets between two hosts, or two routers, or a router and a host.

You can only configure the IPsec policies for IPv4 addresses for UDP, TCP, and ICMPv4 protocols.

IPsec adds support for OSPF virtual link for the security protection of the communication between the end points. You can also use IPsec with OSPFv3 on a brouter port or VLAN interface, for example, if you want to encrypt OSPFv3 control traffic on a broadcast network. You can also use IPsec with ICMPv6.

### **Note:**

- If you downgrade your software, the current IPsec configurations are no longer supported. You must boot with the factory default settings for IPsec, and then reconfigure the IPsec features.
- You can only configure the IPsec policies for IPv4 addresses for UDP, TCP, and ICMPv4 protocols. You can continue to configure IPsec policies for IPv6 addresses for ICMPv6, OSPFv3, TCP, and UDP.

The following figure displays the movement of traffic using IPsec.

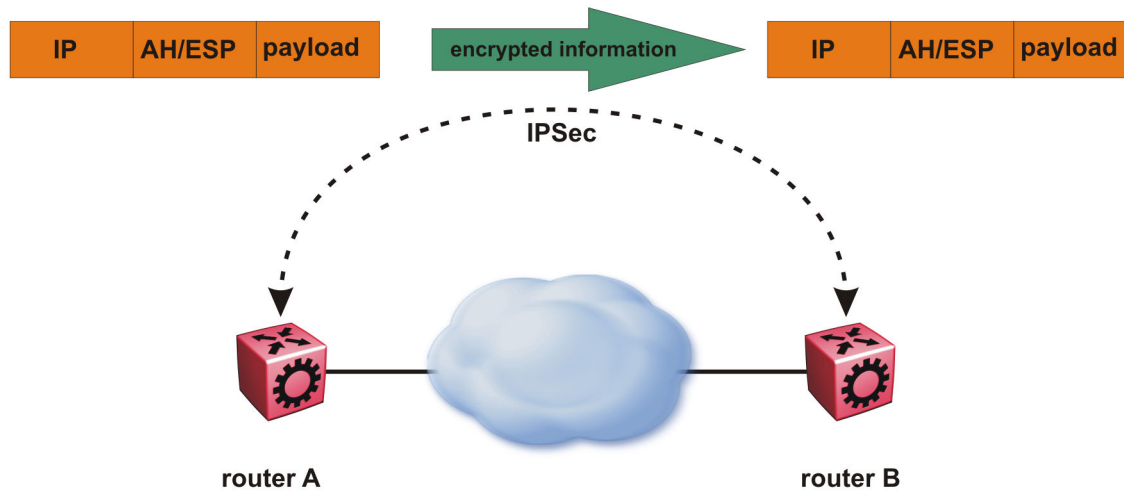

**Figure 17: Internet Protocol Security (IPsec)**

The IPsec feature uses security ciphers and encryption algorithms like AES, DES, and 3DES to ensure confidentiality of data, and keyed MAC for authenticity of data. The encryption algorithms require shared keys to secure the communication. The device only supports manual keying and configuration for IPsec. The IPsec feature supports IPv4 and IPv6 interfaces.

To configure IPsec, you create an IPsec policy, and then link the IPsec policy to an interface. You also link each IPsec policy to an IPsec security association. The IPsec policies define the amount of security applied to specific traffic on a specific interface. The IPsec feature supports the following security protocols:

- Encapsulating security payload (ESP)
- Authentication header (AH)

The device restricts IPsec encryption to control traffic through the CPU. The switch restricts IPsec to transport mode only. The IPsec feature processes either the ingress, the egress, or both the egress and ingress control packets to and from the CPU.

The device checks every ingress or egress packet for the IPsec base protocol, either AH or ESP. The base protocol interacts with the security policy database (SPD) and security association database (SADB) to check the level of security to apply to the packet. The device consults the SPD for both ingress and egress traffic. For egress traffic, the device consults the SPD to determine if IPsec needs to apply security considerations. For ingress traffic, the device consults the SPD to determine whether the traffic received with IPsec encapsulation complies with the policies defined in the system.

For more information on IPsec, see *Configuring IPv6 Routing and Monitoring Performance*.



---

## Authentication header

The authentication header (AH) authenticates IP traffic and ensures you connect with who you want to connect. The authentication header can detect if data is altered in transit and protect against replay attacks. The authentication header does not encrypt traffic.

The authentication header provides a small header that precedes the payload with the use of the security parameters index (SPI) and sequence number. The authentication header provides:

- IP datagram sender authentication by HMAC or MAC
- IP datagram integrity assurance by HMAC or MAC
- Replay detection and protection by sequence number

The IPsec feature inserts the AH header after the IP header in transport mode. Transport mode with AH authenticates only the payload of the IP packet. The device only supports transport mode.

The device does not support tunnel mode. Tunnel mode authenticates the entire IP packet, including the IP header and data, to provide a secure hop between two hosts, two routers, or a router and a host.

You can apply AH alone, or in combination with the Encapsulating Security Payload (ESP).

The following figures show an original IP packet and an IP packet with an AH header.



**Figure 18: Original IP packet**

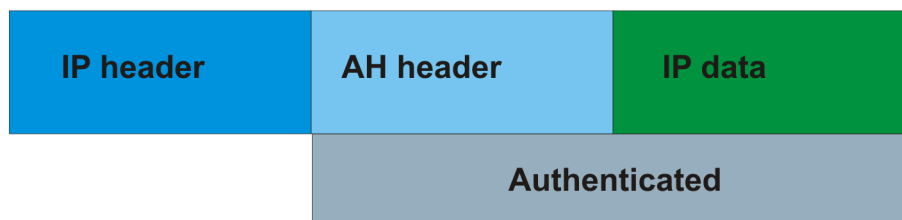

**Figure 19: AH in transport mode**

---

## Encapsulating security payload

The encapsulating security payload (ESP) encrypts traffic with use of encryption algorithms, such as 3DES, AES-CBC, and AES-CTR. The security association specifies the algorithm and key used in ESP.

The encapsulating security payload can protect origin authenticity, integrity, and confidentiality of packets. ESP supports encryption-only and authentication-only configurations. The IPsec feature inserts the ESP header after the IP header and before the next layer protocol header in transport mode. Transport mode with ESP encrypts or authenticates only the payload of the IP packet. The device only supports transport mode.

The device does not support tunnel mode. Tunnel mode encrypts or authenticates the entire IP packet, including the IP header and data, to provide a secure hop between two hosts, two routers, or a router and a host.

The following figures display the original IP packet and an IP packet with ESP.



Figure 20: Original IP packet

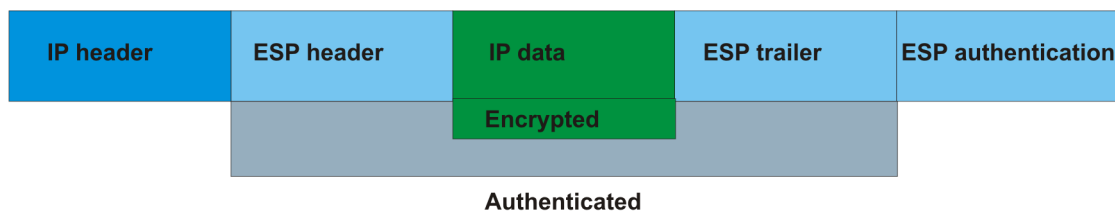

Figure 21: ESP in transport mode

---

## IPsec modes

The IPsec feature security protocols use two different modes to protect the entire IP payload or the upper layer protocols:

- Transport mode

- Tunnel mode

The device only supports transport mode. The device uses transport mode to protect the upper layer protocols. In transport mode, IPsec adds an IPsec header between the IP header and upper layer protocol header.

This device does not support tunnel mode. Under tunnel mode IPsec protects the whole IP packet. In tunnel mode, IPsec inserts the IPsec header between another IP datagram IP header and inner IP header.

---

## Security association

A security association (SA) is a group of algorithms and parameters used to encrypt and authenticate the flow of IP traffic in a particular direction. An SA contains the information IPsec needs to process an IP packet. IPsec identifies SAs by:

- Security Parameter Index (SPI)
- Protocol value (either AH or ESP)
- Destination address to which the SA applies

### Creation of a security association

Typically SAs exist in pairs; one in each direction, either inbound or outbound.

You can create SAs manually or dynamically. After you create an SA manually, the SA has no defined lifetime and the SA exists until you manually delete the SA.

After the device creates the SA dynamically, the SA can have a lifetime value that IPsec peers negotiate through use of a key management protocol. If the device uses the key excessively unauthorized access can occur. You must define the IPsec lifetime and other configurable parameters manually.

Security associations reside in the Security Association Database (SADB), which maintains a list of active SAs. The IPsec feature uses outbound SAs to secure the outgoing traffic and inbound SAs to process the incoming traffic. The device checks every ingress or egress packet for the IPsec base protocol, either AH or ESP. The base protocol interacts with the security policy database (SPD) and security association database (SADB) to check the level of security to apply to that packet.

The IPsec feature restricts SAs to the source and destination address of the connected router.

---

## Security policy

Use IPsec to create IPsec security policies that define the levels of security for different types of traffic. You can use IPsec security policies to create rules to filter traffic with IPsec. IPsec policies determine what IP traffic to secure. An IPsec security policy typically consists of:

- An IP filter
- Security algorithms for authentication and key exchange

- An action

### **Creation of a security policy**

You can configure IPsec on IPv4/IPv6 interfaces. First, create and configure an IPsec policy, and then add and enable the policy on an interface.

After you enable IPsec, the device encrypts all control traffic on the interface based on the policy. You have to specify individual policies to target a particular interface address or multiple addresses. By default, this implementation does not work on a subnet.

The Security Policy Database (SPD) maintains the IPsec security policies. The device checks every ingress or egress packet for the IPsec base protocol, either AH or ESP. The base protocol interacts with the security policy database (SPD) and security association database (SADB) to check the level of security to apply to that packet.

The IPsec feature only adds policies if the source address in the policy specified matches an interface IP address.

The IPsec feature restricts the policy match source address to the interface address of the router and destination IPv6 address.

---

## **IPsec limitations**

This section describes the limitations associated with IPsec.

- The device only supports IPsec transport mode. IPsec does not support tunnel mode.
- The IPsec feature implementation is available only in software. Hardware implementation is not available. Only control packets to and from the CPU are subject to IPsec. IPsec implements IPsec policies in the software on the control path.
- The device does not support address ranges facility for an IPsec policy.
- No fast-path support exists for IPsec.

---

## **IPsec configuration using CLI**

The following section provides procedures to configure Internet Protocol Security (IPsec).

---

### **Creating an IPsec policy**

Use the following procedure to configure an IPsec policy. An IPsec policy defines the level of security for different types of traffic.

**\* Note:**

- You can only configure the IPsec policies for IPv4 addresses for UDP, TCP, and ICMPv4 protocols. You can continue to configure IPsec policies for IPv6 addresses for ICMPv6, OSPFv3, TCP, and UDP.
- If you downgrade your software, the current IPsec configurations are no longer supported. You must boot with the factory default settings for IPsec, and then reconfigure the IPsec features.

**Procedure**

1. Enter Global Configuration mode:

```
enable
configure terminal
```

2. Create an IPsec policy:

```
ipsec policy WORD<1-32>
```

3. **(Optional)** Delete an IPsec policy:

```
no ipsec policy WORD<1-32>
```

**Example**

Create an IPsec policy named newpolicy:

```
Switch:1>enable
Switch:1#configure terminal
Switch:1(config)#ipsec policy newpolicy
```

**Variable definitions**

Use the data in the following table to use the `ipsec policy` command.

| Variable   | Value                            |
|------------|----------------------------------|
| WORD<1-32> | Specifies the IPsec policy name. |

**Enabling an IPsec policy**

Use the following procedure to enable an IPsec policy. An IPsec policy defines the level of security for different types of traffic.

**\* Note:**

If you downgrade your software, the current IPsec configurations are no longer supported. You must boot with the factory default settings for IPsec, and then reconfigure the IPsec features.

**Before you begin**

- Create an IPsec policy.

## About this task

The IPsec feature adds policies only if the admin status of the policy and the IPsec status on the interface are enabled.

If you disable the IPsec policy on an IPv4 or IPv6 interface, IPsec removes the policy-related information from the security policy database (SPD) and the security association database (SADB), but the information remains on the system. After you re-enable, the information reapplies on the interface.

## Procedure

1. Enter Global Configuration mode:

```
enable
configure terminal
```

2. Enable an IPsec policy:

```
ipsec policy WORD<1-32> admin enable
```

3. **(Optional)** Disable an IPsec policy:

```
no ipsec policy WORD<1-32> admin enable
```

## Example

Enable an IPsec policy named newpolicy:

```
Switch:1>enable
Switch:1#configure terminal
Switch:1(config)#ipsec policy newpolicy admin enable
```

## Variable definitions

Use the data in the following table to use the `ipsec policy` command.

| Variable     | Value                            |
|--------------|----------------------------------|
| admin enable | Enables the policy.              |
| WORD<1-32>   | Specifies the IPsec policy name. |

## Creating an IPsec security association

Use the following procedure to create an IPsec security association. A security association (SA) is a group of algorithms and parameters used to encrypt and authenticate the flow of IP traffic in a particular direction. An SA contains the information IPsec needs to process an IP packet.

### About this task

You cannot delete or modify a security association if the security association links to a policy. To modify a parameter in the security association or to delete the security association, you must first unlink the security association from a policy.

## Procedure

1. Enter Global Configuration mode:  

```
enable
configure terminal
```
2. Create an IPsec security association:  

```
ipsec security-association WORD<1-32>
```
3. **(Optional)** Delete an IPsec security association:  

```
no ipsec security-association WORD<1-32>
```

## Example

Create an IPsec security association named `newsa`:

```
Switch:1>enable
Switch:1#configure terminal
Switch:1(config)#ipsec security-association newsa
```

## Variable definitions

Use the data in the following table to use the `ipsec security-association` command.

| Variable                      | Value                                          |
|-------------------------------|------------------------------------------------|
| <code>WORD&lt;1-32&gt;</code> | Specifies the security association identifier. |

## Configuring an IPsec security association

Use the following procedure to configure an IPsec security association (SA). An SA is a group of algorithms and parameters used to encrypt and authenticate the flow of IP traffic in a particular direction. An SA contains the information IPsec needs to process an IP packet.

### Before you begin

- Create an IPsec security association to configure.

### About this task

You cannot delete or modify a security association if the security association links to a policy. To modify a parameter in the security association, or to delete the security association, you must first unlink the security association from a policy. You can only unlink a security association from a policy if the policy does not link to an interface. If a policy links to an interface, you must first unlink the policy from the interface, and then unlink the policy from the security association.

## Procedure

1. Enter Global Configuration mode:  

```
enable
configure terminal
```





```

111111111111111111111111111111111111 KeyLength 20
Switch:1(config)#ipsec security-association newsa key-mode manual
Switch:1(config)#ipsec security-association newsa spi 1
Switch:1(config)#ipsec security-association newsa lifetime seconds 1000

```

## Variable definitions

Use the data in the following table to use the `ipsec security-association` command.

| Variable                                                                                                                           | Value                                                                                                                                                                                                                                                                                                                                                                                                                                                                                                                                                                                                    |
|------------------------------------------------------------------------------------------------------------------------------------|----------------------------------------------------------------------------------------------------------------------------------------------------------------------------------------------------------------------------------------------------------------------------------------------------------------------------------------------------------------------------------------------------------------------------------------------------------------------------------------------------------------------------------------------------------------------------------------------------------|
| <code>WORD&lt;1–32&gt;</code>                                                                                                      | Specifies the security association.                                                                                                                                                                                                                                                                                                                                                                                                                                                                                                                                                                      |
| <code>auth-algo &lt;AES-XCBC-MAC MD5 SHA1 SHA2&gt;</code><br><code>[auth-key WORD&lt;1–256&gt; ] [KeyLength &lt;1–256&gt;]</code>  | <p>Specifies the authorization algorithm, which includes one of the following values:</p> <ul style="list-style-type: none"> <li>• AES-XCBC-MAC</li> <li>• MD5</li> <li>• SHA1</li> <li>• SHA2</li> </ul> <p>The default authentication algorithm name is MD5.</p> <p>The parameter <code>auth-key</code> specifies the authentication key.</p> <p>The <code>KeyLength</code> parameter specifies a string value of 1 to 256 characters in length. The default <code>KeyLength</code> is 128. The <code>KeyLength</code> values are as follows: 3DES is 48, AES-CBC is 32, 48, or 64, AES-CTR is 32.</p> |
| <code>encap-proto &lt;AH ESP&gt;</code>                                                                                            | <p>Specifies the encapsulation protocol:</p> <ul style="list-style-type: none"> <li>• AH—Specifies authentication header.</li> <li>• ESP—Specifies encapsulation security payload.</li> </ul> <p>If you configure the encapsulation protocol as AH, you cannot configure the encryption algorithms and other encryption related attributes. You can only access the encryption algorithm parameters if you configure the encapsulation protocol to ESP.</p> <p>The default value is ESP.</p>                                                                                                             |
| <code>Encrpt-algo &lt;3DES AES-CBC AES-CTR NULL&gt;</code><br><code>[EncrptKey WORD&lt;1–256&gt;] [KeyLength &lt;1–256&gt;]</code> | <p>Specifies the encryption algorithm value as one of the following:</p> <ul style="list-style-type: none"> <li>• 3DES-CBC</li> <li>• AES-CBC</li> <li>• AES-CTR</li> <li>• NULL—Only use the NULL parameter to debug. Do not use this parameter in other circumstances.</li> </ul> <p>The default encryption algorithm is AES-CBC.</p>                                                                                                                                                                                                                                                                  |

*Table continues...*

| Variable                                              | Value                                                                                                                                                                                                                                                                                                                                                                                                                                              |
|-------------------------------------------------------|----------------------------------------------------------------------------------------------------------------------------------------------------------------------------------------------------------------------------------------------------------------------------------------------------------------------------------------------------------------------------------------------------------------------------------------------------|
|                                                       | <p>You can only access the encryption algorithm parameters if you configure the encapsulation protocol to ESP.</p> <p>The EncrptKey specifies the encryption key.</p> <p>The KeyLength specifies the key length value in a string from 1 to 256 characters. The default KeyLength is 128. The KeyLength values are as follows: 3DES is 48, AES-CBC is 32, 48, or 64, AES-CTR is 32.</p>                                                            |
| key-mode < <i>automatic</i>   <i>manual</i> >         | <p>Specifies the key-mode as one of the following:</p> <ul style="list-style-type: none"> <li>• automatic</li> <li>• manual</li> </ul> <p>The default is manual.</p>                                                                                                                                                                                                                                                                               |
| lifetime <Bytes<1-4294967295>   seconds<1-4294967295> | <p>Specifies the lifetime value in seconds or bytes.</p> <p>The default lifetime value in seconds is 28800. The default lifetime value in bytes is 4294966272.</p>                                                                                                                                                                                                                                                                                 |
| mode < <i>transport</i>   <i>tunnel</i> >             | <p>Specifies the mode value as one of the following:</p> <ul style="list-style-type: none"> <li>• transport—Transport mode encapsulates the IP payload and provides a secure connection between two end points. This device only supports transport mode.</li> <li>• tunnel—Tunnel mode encapsulates the entire IP packet and provides a secure tunnel. This device does not support tunnel mode.</li> </ul> <p>The default is transport mode.</p> |
| spi<1-4294967295>                                     | <p>Specifies the security parameters index (SPI) value, which is a unique value. SPI is a tag IPsec adds to the IP header. The tag enables the system that receives the IP packet to determine under which security association to process the received packet.</p> <p>For IPsec to function, each peer must have the same SPI value configured on both peers for a particular policy.</p> <p>The default value is 0.</p>                          |

## Configuring an IPsec policy

Use the following procedure to configure an IPsec policy. An IPsec policy defines the level of security for different types of traffic.

## Before you begin

- Create an IPsec policy.

## About this task

You can only configure the IPsec policies for IPv4 addresses for UDP, TCP, and ICMPv4 protocols. You can continue to configure IPsec policies for IPv6 addresses for ICMPv6, OSPFv3, TCP, and UDP.

If you downgrade your software, the current IPsec configurations are no longer supported. You must boot with the factory default settings for IPsec, and then reconfigure the IPsec features.

You cannot delete or modify a policy if the policy links to a security association, or if the policy links to a port or VLAN interface. If you need to modify a policy you must first unlink the policy from the security association, and the port or VLAN interface.

## Procedure

1. Enter Global Configuration mode:

```
enable
configure terminal
```

2. Configure the remote address:

```
ipsec policy WORD<1-32> raddr WORD<1-32>
```

3. **(Optional)** Configure the local address:

```
ipsec policy WORD<1-32> laddr WORD<1-32>
```

The `laddr` parameter is an optional parameter that you can configure to have multiple local addresses for each remote address.

4. Configure the protocol:

```
ipsec policy WORD<1-32>[protocol <icmp|icmpv6|ospfv3|tcp|udp>]
[sport<1-65535|any>] [dport<1-65535|any>]
```

5. Configure the policy action:

```
ipsec policy WORD<1-32> [action <drop|permit>]
```

## Example

Configure the remote address to `2001:db8:0:0:0:0:0:1` and local address to `2001:db8:0:0:0:0:0:15`. configure the protocol to TCP source port 4 and destination port 5. Configure the policy to `permit`.

```
Switch:1>enable
Switch:1#configure terminal
Switch:1(config)#ipsec policy Ipv6policy raddr 2001:db8:0:0:0:0:0:1
Switch:1(config)#ipsec policy Ipv6policy laddr 2001:db8:0:0:0:0:0:15
Switch:1(config)#ipsec policy Ipv6policy protocol tcp sport 4 dport 5
Switch:1(config)#ipsec policy Ipv6policy action permit
```

Configure the remote address to 192.0.1.1 and local address to 192.0.1.2. configure the protocol to TCP source port 4 and destination port 5. Configure the policy to drop.

```
Switch:1>enable
Switch:1#configure terminal
Switch:1(config)#ipsec policy Ipv4policy raddr 192.0.1.1
Switch:1(config)#ipsec policy Ipv4policy laddr 192.0.1.2
Switch:1(config)#ipsec policy Ipv4policy protocol tcp sport 4 dport 5
Switch:1(config)#ipsec policy Ipv4policy action drop
```

## Variable definitions

Use the data in the following table to use the `ipsec policy` command.

| Variable                                                                         | Value                                                                                                                                                                                                                                                                                                                                                                                                                                                                                                    |
|----------------------------------------------------------------------------------|----------------------------------------------------------------------------------------------------------------------------------------------------------------------------------------------------------------------------------------------------------------------------------------------------------------------------------------------------------------------------------------------------------------------------------------------------------------------------------------------------------|
| action <drop permit>                                                             | Specifies the action the policy takes.<br>The default is permit.                                                                                                                                                                                                                                                                                                                                                                                                                                         |
| laddr WORD<1–32>                                                                 | Specifies the local address. The laddr parameter is an optional parameter that you can configure to have multiple local addresses for each remote address.<br>The default is 0::0.                                                                                                                                                                                                                                                                                                                       |
| protocol <icmp icmpv6 ospfv3 tcp udp> [sport<1–65535> any>][dport<1–65535> any>] | Specifies the protocol, as one of the following: <ul style="list-style-type: none"> <li>• ICMP</li> <li>• ICMPv6</li> <li>• OSPFv3</li> <li>• TCP</li> <li>• UDP</li> </ul> sport — Specifies the source port for TCP and UDP. You can specify any to configure any port as the source port.<br>dport — Specifies the destination port for TCP and UDP. You can specify any to configure any port as the destination port.<br>The default protocol is TCP any.<br>IPv4 only supports ICMP, UDP, and TCP. |
| raddr WORD<1–32>                                                                 | Specifies the remote address.<br>The default is 0::0.                                                                                                                                                                                                                                                                                                                                                                                                                                                    |
| WORD<1–32>                                                                       | Specifies the policy name.                                                                                                                                                                                                                                                                                                                                                                                                                                                                               |

## Linking the IPsec security association to an IPsec policy

Use the following procedure to link the security association to an IPsec policy.

## Before you begin

- The IPsec security association and IPsec policy must exist.

## About this task

You cannot delete or modify a security association if the security association links to a policy. To modify a parameter in the security association, or to delete the security association, you must first unlink the security association from the policy. You can only unlink a security association from a policy if the policy does not link to an interface. If a policy links to an interface, you must first unlink the policy from the interface, and then unlink the policy from the security association.

## Procedure

1. Enter Global Configuration mode:

```
enable
configure terminal
```

2. Link the IPsec security association to the IPsec policy:

```
ipsec policy WORD<1-32> security-association WORD<1-32>
```

3. **(Optional)** Unlink the IPsec security association to the IPsec policy:

```
no ipsec policy WORD<1-32> security-association WORD<1-32>
```

## Example

Link the IPsec security association named `new_sa` to the IPsec policy named `newpolicy`:

```
Switch:1>enable
Switch:1#configure terminal
Switch:1(config)#ipsec policy newpolicy security-association newsa
```

## Variable definitions

Use the data in the following table to use the `ipsec policy` command.

| Variable                                           | Value                                  |
|----------------------------------------------------|----------------------------------------|
| <code>WORD&lt;1-32&gt;</code>                      | Specifies the policy ID.               |
| <code>security-association WORD&lt;1-32&gt;</code> | Specifies the security association ID. |

## Enabling IPsec on an interface

Use the following procedure to enable IPsec on an interface. You can configure IPsec on a port, management port, VLAN, or loopback interface.

### Procedure

1. Enter Interface Configuration mode:

```
enable
configure terminal
```

followed by one of the following:

- `interface GigabitEthernet {slot/port[/sub-port] [-slot/port[/sub-port]] [,...]}`
- `interface loopback <1-256>`
- `interface mgmtEthernet <mgmt | mgmt2>`
- `interface vlan <1-4059>`

**\* Note:**

If your platform supports channelization and the port is channelized, you must also specify the sub-port in the format slot/port/sub-port.

2. Enable IPsec on an IPv6 interface:

```
ipv6 ipsec enable
default ipv6 ipsec enable
```

3. Enable IPsec on an IPv4 interface:

```
ip ipsec enable
default ip ipsec enable
```

4. **(Optional)** Disable IPsec on an IPv6 interface:

```
no ipv6 ipsec enable
```

5. **(Optional)** Disable IPsec on an IPv4 interface:

```
no ip ipsec enable
```

### Example

Enable IPsec for IPv6 on VLAN 100:

```
Switch:1>enable
Switch:1#configure terminal
Switch:1(config)#interface vlan 100
Switch:1(config-if)#ipv6 ipsec enable
```

## Variable definition

Use the data in the following table to use the `ip ipsec` and `ipv6 ipsec` commands.

| Variable | Value                           |
|----------|---------------------------------|
| enable   | Enables IPsec on the interface. |

## Linking an IPsec policy to an interface

Use the following procedure to link an IPsec policy to an interface, and configure a policy direction. By default, the direction is both.

## Before you begin

- You must enable IPsec on the interface first, and then you link the IPsec policy to the interface.

## About this task

You cannot delete or modify an IPsec policy if the policy links to a port or VLAN interface. If you need to modify the policy, first unlink the policy from the port or VLAN interface.

## Procedure

- Enter Interface Configuration mode:

```
enable
configure terminal
```

followed by one of the following:

- `interface GigabitEthernet {slot/port[/sub-port] [-slot/port[/sub-port]][,...]}`
- `interface loopback <1-256>`
- `interface mgmtEthernet <mgmt | mgmt2>`
- `interface vlan <1-4059>`

### \* Note:

If your platform supports channelization and the port is channelized, you must also specify the sub-port in the format slot/port/sub-port.

- Link the IPsec policy to an IPv4 interface:

```
ip ipsec policy WORD<1-32> dir <both|in|out>
```

- Link the IPsec policy to an IPv6 interface:

```
ipv6 ipsec policy WORD<1-32> dir <both|in|out>
```

- (Optional)** Unlink the IPsec policy from an IPv4 interface:

```
no ip ipsec policy WORD<1-32> dir <both|in|out>
```

- (Optional)** Unlink the IPsec policy from an IPv6 interface:

```
no ipv6 ipsec policy WORD<1-32> dir <both|in|out>
```

## Example

Link the IPsec policy newpolicy to the IPv6 interface VLAN 100:

```
Switch:1>enable
Switch:1#configure terminal
Switch:1(config)#interface vlan 100
Switch:1(config-if)#ipv6 ipsec policy newpolicy dir both
```

## Variable definitions

Use the data in the following table to use the `ip ipsec policy` and `ipv6 ipsec policy` commands.

| Variable                                            | Value                                                                                                                                                                                                                                                                                           |
|-----------------------------------------------------|-------------------------------------------------------------------------------------------------------------------------------------------------------------------------------------------------------------------------------------------------------------------------------------------------|
| <i>WORD</i> <1–32>                                  | Specifies the policy ID.                                                                                                                                                                                                                                                                        |
| <i>dir</i> < <i>both</i>   <i>in</i>   <i>out</i> > | Specifies the direction you want to protect with IPsec: <ul style="list-style-type: none"> <li>• <i>both</i>—Specifies both ingress and egress traffic.</li> <li>• <i>in</i>—Specifies ingress traffic.</li> <li>• <i>out</i>—Specifies egress traffic.</li> </ul> The default is <i>both</i> . |

---

## Enabling IPsec on a management interface

Use the following procedure to enable IPsec on a management interface.

By default, IPsec is disabled on the management interface.

### About this task

This procedure only applies to hardware with a dedicated, physical management interface.

### Procedure

1. Enter mgmtEthernet Interface Configuration mode:

```
enable
configure terminal
interface mgmtEthernet <mgmt | mgmt2>
```

2. Enable IPsec on an IPv6 interface:

```
ipv6 ipsec enable
```

3. Enable IPsec on an IPv4 interface:

```
ip ipsec enable
```

### Example

Enable IPsec for IPv4 on the management interface:

```
Switch:1>enable
Switch:1#configure terminal
Switch:1(config)#interface mgmtEthernet mgmt
Switch:1(config-if)#ip ipsec enable
```

---

## Linking an IPsec policy to a management interface

Use the following procedure to link an IPsec policy to a management interface, and configure a policy direction. By default, the direction is *both*.



## About this task

This procedure only applies to hardware with a dedicated, physical management interface.

## Before you begin

- You must enable IPsec on the interface first, and then you link the IPsec policy to the interface.

## Procedure

1. Enter mgmtEthernet Interface Configuration mode:

```
enable
configure terminal
interface mgmtEthernet <mgmt | mgmt2>
```

2. Link the IPsec policy to an IPv4 interface:

```
ip ipsec policy WORD<1-32> dir <both|in|out>
```

3. Link the IPsec policy to an IPv6 interface:

```
ipv6 ipsec policy WORD<1-32> dir <both|in|out>
```

4. **(Optional)** Unlink the IPsec policy from an IPv4 interface:

```
no ip ipsec policy WORD<1-32> dir <both|in|out>
```

5. **(Optional)** Unlink the IPsec policy from an IPv6 interface:

```
no ipv6 ipsec policy WORD<1-32> dir <both|in|out>
```

## Example

Link the IPsec policy for IPv4 to the management interface:

```
Switch:1>enable
Switch:1#configure terminal
Switch:1(config)#interface mgmtEthernet mgmt
Switch:1(config-if)#ip ipsec policy newpolicy dir both
```

## Variable definitions

Use the data in the following table to use the `ip ipsec policy` and `ipv6 ipsec policy` commands.

| Variable                             | Value                                                                                                                                                                                                                                                                                                                   |
|--------------------------------------|-------------------------------------------------------------------------------------------------------------------------------------------------------------------------------------------------------------------------------------------------------------------------------------------------------------------------|
| <code>WORD&lt;1-32&gt;</code>        | Specifies the policy ID.                                                                                                                                                                                                                                                                                                |
| <code>dir &lt;both in out&gt;</code> | Specifies the direction you want to protect with IPsec: <ul style="list-style-type: none"> <li>• <code>both</code>—Specifies both ingress and egress traffic.</li> <li>• <code>in</code>—Specifies ingress traffic.</li> <li>• <code>out</code>—Specifies egress traffic.</li> </ul> The default is <code>both</code> . |

## Displaying IPsec information on an interface

Use the following procedure to display IPsec information on an interface.

### Procedure

1. Log on to the switch to enter User EXEC mode.
2. Display the IPsec status on an Ethernet interface:

```
show ipsec interface gigabitethernet {slot/port[/sub-port] [-slot/
port[/sub-port]] [,...]}
```

3. Display the IPsec status on a VLAN interface:

```
show ipsec interface vlan <1-4059>
```

4. Display the IPsec status on a management interface:

```
show ipsec interface mgmtethernet mgmt
```

**\* Note:**

This step applies to hardware that includes a physical management interface.

5. Display the IPsec status on a loopback interface:

```
show ipsec interface loopback <1-256>
```

### Example

Display the IPsec status on a VLAN interface.

```
Switch:1>show ipsec interface vlan 22
```

```
=====
 VLAN Interface Policy Table
=====
```

| Vlan Interface | Policy Name | IPsec State | Direction |
|----------------|-------------|-------------|-----------|
| 22             | AAA         | Enable      | both      |
| 22             | tcp         | Enable      | both      |
| 22             | icmp        | Enable      | both      |

## Variable definitions

Use the data in the following table to use the **show ipsec interface** command.

| Variable                                                              | Value                                                                                                                                                                                                                                                                        |
|-----------------------------------------------------------------------|------------------------------------------------------------------------------------------------------------------------------------------------------------------------------------------------------------------------------------------------------------------------------|
| gigabitethernet {slot/port[/sub-port] [-slot/port[/sub-port]] [,...]} | Identifies the slot and port in one of the following formats: a single slot and port (slot/port), a range of slots and ports (slot/port-slot/port), or a series of slots and ports (slot/port,slot/port,slot/port). If your platform supports channelization and the port is |

*Table continues...*

| Variable          | Value                                                                                                                                                                                                                                                                                                                                                                                                        |
|-------------------|--------------------------------------------------------------------------------------------------------------------------------------------------------------------------------------------------------------------------------------------------------------------------------------------------------------------------------------------------------------------------------------------------------------|
|                   | channelized, you must also specify the sub-port in the format slot/port/sub-port.                                                                                                                                                                                                                                                                                                                            |
| mgmtethernet mgmt | Identifies the interface as the management interface.                                                                                                                                                                                                                                                                                                                                                        |
| loopback <1–256>  | Specifies the loopback interface.                                                                                                                                                                                                                                                                                                                                                                            |
| vlan <1-4059>     | Specifies the VLAN ID in the range of 1 to 4059. By default, VLAN IDs 1 to 4059 are configurable and the system reserves VLAN IDs 4060 to 4094 for internal use. On switches that support the vrf-scaling and spbm-config-mode boot configuration flags, if you enable these flags, the system also reserves VLAN IDs 3500 to 3998. VLAN ID 1 is the default VLAN and you cannot create or delete VLAN ID 1. |

## Job aid

The following table describes the fields in the output for the **show ipsec interface vlan** command.

| Parameter      | Description                                                                 |
|----------------|-----------------------------------------------------------------------------|
| Vlan Interface | Specifies the VLAN interface.                                               |
| Policy Name    | Specifies the IPsec policy that associates with the specific VLAN or VLANs. |
| IPsec State    | Specifies whether the IPsec policy is enabled on the VLAN interface.        |
| Direction      | Specifies the policy direction.                                             |

The following table describes the fields in the output for the **show ipsec interface gigabitethernet** command.

| Parameter   | Description                                                                 |
|-------------|-----------------------------------------------------------------------------|
| Interface   | Specifies the interface.                                                    |
| Policy Name | Specifies the IPsec policy that associates with the specific port or ports. |
| IPsec State | Specifies whether the IPsec policy is enabled on the interface.             |
| Direction   | Specifies the policy direction.                                             |

The following table describes the fields in the output for the **show ipsec interface mgmtethernet** command.

| Parameter   | Description                                                          |
|-------------|----------------------------------------------------------------------|
| Interface   | Specifies the VLAN interface.                                        |
| Policy Name | Specifies the IPsec policy that associates with the management port. |

*Table continues...*

| Parameter   | Description                                                     |
|-------------|-----------------------------------------------------------------|
| IPsec State | Specifies whether the IPsec policy is enabled on the interface. |
| Direction   | Specifies the policy direction.                                 |

The following table describes the fields in the output for the **show ipsec interface loopback** command.

| Parameter          | Description                                                     |
|--------------------|-----------------------------------------------------------------|
| LoopBack Interface | Specifies the loopback interface.                               |
| Policy Name        | Specifies the IPsec policy that associates with the interface.  |
| IPsec State        | Specifies whether the IPsec policy is enabled on the interface. |
| Direction          | Specifies the policy direction.                                 |

---

## Displaying configured IPsec policies

Use the following procedure to display IPsec policies.

### Procedure

1. Log on to the switch to enter User EXEC mode.
2. Display all of the IPsec policies on the switch:  

```
show ipsec policy all
```
3. Display a specific IPsec policy based on the policy name on the interface:  

```
show ipsec policy interface WORD<1-32>
```
4. Display the IPsec policy based on the policy name:  

```
show ipsec policy name WORD<1-32>
```

### Example

Display IPsec policy information:

```
Switch:1>show ipsec policy all
```

```
=====
 IPSEC Policy Table
=====
PolicyName : ospf1
LocalAddress: 0::0
RemoteAddress: 0::0
Protocol: ospfv3
src-port: 0
dest-port: 0
Action: Permit
Admin: Enable
```

```
Switch:1>show ipsec policy interface ospf1
```

```

=====
IPsec Policy Interface Table
=====
POLICY NAME InterfaceIndex Policy State Direction

ospf1 2/3 Enable both

Switch:1>show ipsec policy name ospf1
=====
IPSEC Policy Table
=====
PolicyName : ospf1
LocalAddress: 0::0
RemoteAddress: 0::0
Protocol: ospfv3
src-port: 0
dest-port: 0
Action: Permit
Admin: Enable

```

## Variable definitions

Use the data in the following table to use the **show ipsec policy** command.

| Variable                     | Value                                                                       |
|------------------------------|-----------------------------------------------------------------------------|
| all                          | Displays all of the IPsec policies on the switch.                           |
| interface <i>WORD</i> <1–32> | Displays a specific IPsec policy based on the policy name on the interface. |
| name <i>WORD</i> <1–32>      | Displays the IPsec policy based on the name of the policy.                  |

## Job aid

The following table describes the fields in the output for the **show ipsec policy all** and **show ipsec policy name** commands.

| Parameter     | Description                                        |
|---------------|----------------------------------------------------|
| PolicyName    | Specifies the IPsec policy name.                   |
| LocalAddress  | Specifies the local address. The default is 0::0.  |
| RemoteAddress | Specifies the remote address. The default is 0::0. |
| Protocol      | Specifies the protocol.                            |
| src-port      | Specifies the source port.                         |
| dest-port     | Specifies the destination port.                    |
| Action        | Specifies the action as either: permit or drop.    |
| Admin         | Specifies whether the policy is enabled.           |

The following table describes the fields in the output for the **show ipsec policy interface** command.

| Parameter      | Description                              |
|----------------|------------------------------------------|
| POLICY NAME    | Specifies the IPsec policy name.         |
| InterfaceIndex | Specifies the interface.                 |
| Policy State   | Specifies whether the policy is enabled. |

## Displaying IPsec security association information

Use the following procedure to display IPsec security association information.

### Procedure

1. Enter Privileged EXEC mode:  
enable
2. Display all IPsec security associations:  
show ipsec sa all
3. Display a specific IPsec security association:  
show ipsec sa name *WORD*<1-32>
4. Display all security associations linked to a specific policy:  
show ipsec sa-policy

### Example

Display information on IPsec security association policies:

```
Switch:1>enable
Switch:1#show ipsec sa all
=====
IPSEC Security Association Table
=====
sa-name: ospf1
key-Mode: manual
Encap protocol: ESP
SPI Value: 9
Encrypt Algorithm: 3dec-cbc
Encrypt-key: 52fb29f723b0800870dc83e3
Encrypt-key-Len: 24
Auth Algorithm: hmac-md5
Auth-key: 123456789abcdef0
Auth-key-Len: 16
Mode: transport
Lifetime-Sec: 1000
Lifetime-Byte: 20000

Switch:1#show ipsec sa name ospf1
=====
IPSEC Security Association Table
=====
sa-name: ospf1
key-Mode: manual
Encap protocol: ESP
```

```

SPI Value: 9
Encrypt Algorithm: 3dec-cbc
Encrypt-key: 52fb29f723b0800870dc83e3
Encrypt-key-Len: 24
Auth Algorithm: hmac-md5
Auth-key: 123456789abcdef0
Auth-key-Len: 16
Mode: transport
Lifetime-Sec: 1000
Lifetime-Byte: 20000

```

```
Switch:1#show ipsec sa-policy
```

```

=====
 SA POLICY TABLE
=====
Policy Name Security Association

ospf1 ospf1
=====

```

## Variable definitions

Use the data in the following table to use the `show ipsec sa` command.

| Variable                | Value                                                   |
|-------------------------|---------------------------------------------------------|
| all                     | Displays all security associations.                     |
| name <i>WORD</i> <1–32> | Displays a specific security association based on name. |

Use the data in the following table to use the `show ipsec` command.

| Variable  | Value                                                           |
|-----------|-----------------------------------------------------------------|
| sa-policy | Displays all security associations linked to a specific policy. |

## Job aid

The following table describes the fields in the output for the `show ipsec sa all` and `show ipsec saname` commands.

| Parameter      | Description                                                                                                                                                                     |
|----------------|---------------------------------------------------------------------------------------------------------------------------------------------------------------------------------|
| sa-name        | Specifies all of the IPsec security association names.                                                                                                                          |
| key-Mode       | Specifies the key mode as manual or automatic. The default is automatic.                                                                                                        |
| Encap protocol | Specifies the encapsulation protocol.                                                                                                                                           |
| SPI Value      | Specifies the SPI value, which is a tag added to the IP header. For IPsec to function, each peer must have the same SPI value configured on both peers for a particular policy. |

*Table continues...*

| Parameter         | Description                                                                                                                                                                                                                                                                                                                                                                                                                                |
|-------------------|--------------------------------------------------------------------------------------------------------------------------------------------------------------------------------------------------------------------------------------------------------------------------------------------------------------------------------------------------------------------------------------------------------------------------------------------|
| Encrypt Algorithm | Specifies the encrypt algorithm as one of the following: <ul style="list-style-type: none"> <li>• 3DES-CBC</li> <li>• AES-CBC</li> <li>• AES-CTR</li> <li>• NULL—Only used to debug.</li> </ul>                                                                                                                                                                                                                                            |
| Encrypt-key       | Specifies the encrypt-key parameter for the authentication key in either: <ul style="list-style-type: none"> <li>• hex— Specifies hexadecimal.</li> <li>• ascii—Specifies ASCII, the American Standard Code for Information Interchange character encoding scheme.</li> </ul>                                                                                                                                                              |
| Encrypt-key-Len   | Specifies the key length value in a string from 1 to 256 characters. The default KeyLength is 128.                                                                                                                                                                                                                                                                                                                                         |
| Mode              | Specifies the mode value as one of the following: <ul style="list-style-type: none"> <li>• tunnel—Tunnel mode encapsulates the entire IP packet and provides a secure tunnel. This device does not support tunnel mode.</li> <li>• transport—Transport mode encapsulates the IP payload and provides a secure connection between two endpoints. This device only supports transport mode.</li> </ul> <p>The default is transport mode.</p> |
| Lifetime-Sec      | Specifies the lifetime value in seconds. The default is 28800.                                                                                                                                                                                                                                                                                                                                                                             |
| Lifetime-Byte     | Specifies the lifetime value in bytes. The default is 4294966272.                                                                                                                                                                                                                                                                                                                                                                          |

The following table describes the fields in the output for the `show ipsec sa-policy` command.

| Parameter            | Description                              |
|----------------------|------------------------------------------|
| Policy Name          | Specifies the IPsec policy name.         |
| Security Association | Specifies the security association name. |

---

## IPsec configuration using EDM

The following section provides procedures to configure Internet Protocol security (IPsec).



## Creating an IPsec policy

Use the following procedure to configure an IPsec policy for an IPv4 or an IPv6 interface. An IPsec policy defines the level of security for different types of traffic.

### \* Note:

- You can only configure the IPsec policies for IPv4 addresses for UDP, TCP, and ICMPv4 protocols. You can continue to configure IPsec policies for IPv6 addresses for ICMPv6, OSPFv3, TCP, and UDP.
- If you downgrade your software, the current IPsec configurations are no longer supported. You must boot with the factory default settings for IPsec, and then reconfigure the IPsec features.

### About this task

You cannot delete or modify a policy if the policy links to a security association, or if the policy links to a port or VLAN interface. If you need to modify a policy you must first unlink the policy from the security association, and the port or VLAN interface.

### Procedure

1. In the navigation pane, expand the **Configuration > Security > Control Path** folders.
2. Click **IPSec**.
3. Click the **Policy** tab.
4. Click **Insert**.
5. In the **Name** field, type a policy name.
6. Complete the remaining optional configuration to customize the policy.
7. Click **Insert**.

## Policy field descriptions

Use the data in the following table to use the Policy tab.

| Name              | Description                                                                                                                                                                                                                                               |
|-------------------|-----------------------------------------------------------------------------------------------------------------------------------------------------------------------------------------------------------------------------------------------------------|
| <b>Name</b>       | Specifies the IPsec policy name.                                                                                                                                                                                                                          |
| <b>DstAddress</b> | Specifies the remote address. This field accepts IPv4 and IPv6 address, depending on the selected source address type.                                                                                                                                    |
| <b>SrcAddress</b> | Specifies the local address. The local address is optional that you can configure to have multiple local addresses for each remote (destination) address.<br><br>This field accepts IPv4 and IPv6 address, depending on the selected source address type. |

*Table continues...*

| Name              | Description                                                                                                                                                                                                                                         |
|-------------------|-----------------------------------------------------------------------------------------------------------------------------------------------------------------------------------------------------------------------------------------------------|
| <b>SrcPort</b>    | Specifies the source port for TCP and UDP. Leave this field empty to configure any port as the source port. The default value is 1.                                                                                                                 |
| <b>DstPort</b>    | Specifies the destination port for TCP and UDP. Leave this field empty to configure any port as the destination port. The default value is 1.                                                                                                       |
| <b>AdminFlag</b>  | Enables or disables the policy. The default is disabled.                                                                                                                                                                                            |
| <b>L4Protocol</b> | Specifies the protocol, as one of the following: <ul style="list-style-type: none"> <li>• tcp</li> <li>• udp</li> <li>• icmp</li> <li>• icmpv6</li> <li>• ospfv3</li> </ul> IPv4 interfaces only support TCP, UDP, and ICMP.<br>The default is TCP. |
| <b>Action</b>     | Specifies the action the policy takes. The default is to permit the packet.                                                                                                                                                                         |

## Creating an IPsec security association

Use the following procedure to create an IPsec security association. A security association (SA) is a group of algorithms and parameters used to encrypt and authenticate the flow of IP traffic in a particular direction. An SA contains the information IPsec needs to process an IP packet.

### About this task

You cannot delete or modify a security association if the security association links to a policy. To modify a parameter in the security association or to delete the security association, you must first unlink the security association from a policy.

You can only unlink a security association from a policy if the policy does not link to an interface. If a policy links to an interface, you must first unlink the policy from the interface, and then unlink the policy from the security association.

### Procedure

1. In the navigation pane, expand the following folders: **Configuration > Security > Control Path**.
2. Click **IPSec**.
3. Click the **Security Association** tab.
4. Click **Insert**.

5. In the **Name** field, type a name to identify the SA.
6. In the **SPI** field, type the security parameters index.

**\* Note:**

For IPsec to function, each peer must have the same SPI value configured for a particular policy.

7. Complete the remaining optional configuration.
8. Click **Insert**.

## Security Association field descriptions

Use the data in the following table to use the Security Association tab.

| Name                    | Description                                                                                                                                                                                                                                                                                                                                                                                                 |
|-------------------------|-------------------------------------------------------------------------------------------------------------------------------------------------------------------------------------------------------------------------------------------------------------------------------------------------------------------------------------------------------------------------------------------------------------|
| <b>Name</b>             | Specifies the name of the security association.                                                                                                                                                                                                                                                                                                                                                             |
| <b>Spi</b>              | <p>Specifies the security parameters index (SPI) value, which is a unique value. SPI is a tag IPsec adds to the IP header. The tag enables the system that receives the IP packet to determine under which security association to process the received packet.</p> <p>For IPsec to function, each peer must have the same SPI value configured for a particular policy.</p> <p>The default value is 0.</p> |
| <b>HashAlgorithm</b>    | <p>Specifies the authorization algorithm, which includes one of the following values:</p> <ul style="list-style-type: none"> <li>• AESXCBC</li> <li>• MD5</li> <li>• SHA1</li> <li>• SHA2</li> </ul> <p>The default authentication algorithm name is MD5.</p>                                                                                                                                               |
| <b>EncryptAlgorithm</b> | <p>Specifies the encryption algorithm value as one of the following:</p> <ul style="list-style-type: none"> <li>• DES3CBC</li> <li>• AES128CBC</li> <li>• AESCTR</li> <li>• NULL—Only use the NULL parameter to debug. Do not use this parameter in any other circumstance.</li> </ul> <p>The default encryption algorithm is AES128CBC. You can only access the encryption algorithm</p>                   |

*Table continues...*

| Name                    | Description                                                                                                                                                                                                                                                                                                                                                                                                                                                                               |
|-------------------------|-------------------------------------------------------------------------------------------------------------------------------------------------------------------------------------------------------------------------------------------------------------------------------------------------------------------------------------------------------------------------------------------------------------------------------------------------------------------------------------------|
|                         | parameters if you configure the encapsulation protocol to ESP.                                                                                                                                                                                                                                                                                                                                                                                                                            |
| <b>AuthMethod</b>       | <p>Specifies the encapsulation protocol:</p> <ul style="list-style-type: none"> <li>• ah—Specifies authentication header.</li> <li>• es—Specifies encapsulation security payload.</li> </ul> <p>If you configure the encapsulation protocol as ah, you cannot configure the encryption algorithms and other encryption related attributes. You can only access the encryption algorithm parameters if you configure the encapsulation protocol to es.</p> <p>The default value is es.</p> |
| <b>Mode</b>             | <p>Specifies the mode value as one of the following:</p> <ul style="list-style-type: none"> <li>• transport—Transport mode encapsulates the IP payload and provides a secure connection between two end points. This device only supports transport mode.</li> <li>• tunnel—Tunnel mode encapsulates the entire IP packet and provides a secure tunnel. This device does not support tunnel mode.</li> </ul> <p>The default is transport mode.</p>                                        |
| <b>KeyMode</b>          | <p>Specifies the key-mode as one of the following:</p> <ul style="list-style-type: none"> <li>• manual</li> <li>• auto</li> </ul> <p>The default is manual.</p>                                                                                                                                                                                                                                                                                                                           |
| <b>EncryptKeyName</b>   | Specifies the encryption key.                                                                                                                                                                                                                                                                                                                                                                                                                                                             |
| <b>EncryptKeyLength</b> | <p>Specifies the numbers of bits used in the encryption key. The key length values are as follows:</p> <ul style="list-style-type: none"> <li>• DES3CBC is 48</li> <li>• AES128CBC is 32, 48, 64</li> <li>• AESCTR is 32</li> </ul>                                                                                                                                                                                                                                                       |
| <b>HashKeyName</b>      | Specifies the authentication key.                                                                                                                                                                                                                                                                                                                                                                                                                                                         |
| <b>HashKeyLength</b>    | <p>Specifies the numbers of bits used in the hash key. The key length values are as follows:</p> <ul style="list-style-type: none"> <li>• AESXCBC is 32</li> <li>• MD5 is 32</li> <li>• SHA1 is 40</li> </ul>                                                                                                                                                                                                                                                                             |

*Table continues...*

| Name                   | Description                                                                                                                                                                                                                                          |
|------------------------|------------------------------------------------------------------------------------------------------------------------------------------------------------------------------------------------------------------------------------------------------|
| <b>LifetimeSeconds</b> | <p>Specifies the lifetime value in seconds. The lifetime determines the traffic that can pass between IPsec peers using a security association before that security association expires.</p> <p>The default lifetime value in seconds is 28800.</p>  |
| <b>LifetimeBytes</b>   | <p>Specifies the lifetime value in bytes. The lifetime determines the traffic that can pass between IPsec peers using a security association before that security association expires.</p> <p>The default lifetime value in bytes is 4294966272.</p> |

## Linking the IPsec security association to an IPsec policy

Use the following procedure to link the security association to an IPsec policy.

### About this task

You cannot delete or modify a security association if the security association links to a policy. To modify a parameter in the security association, or to delete the security association, you must first unlink the security association from the policy. You can only unlink a security association from a policy if the policy does not link to an interface. If a policy links to an interface, you must first unlink the policy from the interface, and then unlink the policy from the security association.

### Before you begin

- The IPsec security association and IPsec policy must exist.

### Procedure

1. In the navigation pane, expand the following folders: **Configuration > Security > Control Path**.
2. Click **IPSec**.
3. Click the **Policy SA Link** tab.
4. Click **Insert**.
5. In the **PolicyName** field, type the IPsec policy name.
6. In the **SAName** field, type the security association name.
7. Click **Insert**.

## Policy SA Link field descriptions

Use the data in the following table to use the **Policy SA Link** tab.

| Name              | Description                                     |
|-------------------|-------------------------------------------------|
| <b>PolicyName</b> | Specifies the name of the IPsec policy.         |
| <b>SAName</b>     | Specifies the name of the security association. |

---

## Enabling IPsec on an IPv6 interface

Use the following procedure to enable IPsec on an IPv6 interface.

**\* Note:**

If you downgrade your software, the current IPsec configurations are no longer supported. You must boot with the factory default settings for IPsec, and then reconfigure the IPsec features.

### Procedure

1. In the navigation pane, expand the following folder: **Configuration > Security > Control Path**.
2. Click **IPSec**.
3. Click the **IPv6 Interfaces** tab.
4. In the IpsecEnable column, double-click in the **IpsecEnable** field, and select **enable** from the drop-down box.
5. Click **Apply**.

---

## Enabling IPsec on an IPv4 interface

Use the following procedure to enable IPsec on an IPv4 interface.

**\* Note:**

If you downgrade your software, the current IPsec configurations are no longer supported. You must boot with the factory default settings for IPsec, and then reconfigure the IPsec features.

### Procedure

1. In the navigation pane, expand the following folder: **Configuration > Security > Control Path**.
2. Click **IPSec**.
3. Click the **IPv4 Interfaces** tab.
4. In the IpsecEnable column, double-click in the **IpsecEnable** field, and select **enable** from the drop-down box.
5. Click **Apply**.

## IPv4 Interfaces tab field descriptions

Use the data in the following table to use the **IPv4 Interfaces** tab.

| Name        | Description                                                 |
|-------------|-------------------------------------------------------------|
| Interface   | Specifies the interface.                                    |
| IpsecEnable | Specifies if IPsec is enabled on that particular interface. |

---

## Linking an IPsec policy to an interface

Use the following procedure to link an IPsec policy to an interface, and configure a policy direction. By default, the direction is both.

### About this task

You cannot delete or modify an IPsec policy if the policy links to a port or VLAN interface. If you need to modify the policy, first unlink the policy from the port or VLAN interface.

### Before you begin

- You must enable IPsec on the interface first, and then you link the IPsec policy to the interface.

### Procedure

- In the navigation pane, expand the following folders: **Configuration > Security > Control Path**.
- Click **IPSec**.
- Click the **Interface Policy** tab.
- Click **Insert**.
- In the **Name** field, type the name of the IPsec policy.
- In the **IfIndex** field, click either **Port** , **Vlan**, or **Mgmt Port**, and then select an interface.

#### **Note:**

The Mgmt Port button only appears for hardware with a dedicated, physical management interface. If you click this button, EDM automatically populates the IfIndex value.

- Click **Okay**.
- Complete the remaining optional configuration.
- Click **Insert**.

## Interface Policy field descriptions

Use the data in the following table to use the Interface Policy tab.

| Name               | Description                                                                                                                                                                                                                                                                                      |
|--------------------|--------------------------------------------------------------------------------------------------------------------------------------------------------------------------------------------------------------------------------------------------------------------------------------------------|
| <b>Name</b>        | Specifies the IPsec policy name.                                                                                                                                                                                                                                                                 |
| <b>IfIndex</b>     | Links a policy to either a port, VLAN, loopback, or management interface.                                                                                                                                                                                                                        |
| <b>IfEnabled</b>   | Shows if the IPsec is enabled on the interface and if the administrative state of the policy is enabled.                                                                                                                                                                                         |
| <b>IfDirection</b> | Specifies the direction you want to protect with IPsec: <ul style="list-style-type: none"> <li>• inbound—Specifies ingress traffic.</li> <li>• outbound—Specifies egress traffic.</li> <li>• bothDirections—Specifies both ingress and egress traffic.</li> </ul> The default is bothDirections. |

## Displaying IPsec interface statistics

Use this procedure to view IPsec statistics and counter values for each IPsec-enabled interface.

### About this task

If you select an interface on the **Stats** tab, you can click **Graph** to graph particular statistics for that interface.

### Procedure

1. In the navigation pane, expand the following folders: **Configuration > Security > Control Path**.
2. Click **IPSec**.
3. Click the **Interface Stats** tab.

## Interface Stats field descriptions

Use the data in the following table to use the Interface Stats tab.

| Name                  | Description                                                                                                    |
|-----------------------|----------------------------------------------------------------------------------------------------------------|
| <b>IfIndex</b>        | Shows the interface index for which the statistic is captured.                                                 |
| <b>InSuccesses</b>    | Specifies the number of ingress packets IPsec successfully carries.                                            |
| <b>InSPViolations</b> | Specifies the number of ingress packets IPsec discards since boot time because of a security policy violation. |

*Table continues...*



| Name                         | Description                                                                                                                   |
|------------------------------|-------------------------------------------------------------------------------------------------------------------------------|
| <b>InNotEnoughMemories</b>   | Specifies the number of ingress packets IPsec discards since boot time because not enough memory is available.                |
| <b>InAHESPReplays</b>        | Specifies the number of ingress packets IPsec discards since boot time because the AH replay check fails.                     |
| <b>InESPReplays</b>          | Specifies the number of ingress packets IPsec discards since boot time because the ESP replay check fails.                    |
| <b>InAHFailures</b>          | Specifies the number of ingress packets IPsec discards since boot time because the AH authentication check fails.             |
| <b>InESPFailures</b>         | Specifies the number of ingress packets IPsec discards since boot time because the ESP authentication check fails.            |
| <b>OutSuccesses</b>          | Specifies the number of egress packets IPsec successfully carries since boot time.                                            |
| <b>OutSPViolations</b>       | Specifies the number of egress packets IPsec discards since boot time because a security policy violation occurs.             |
| <b>OutNotEnoughMemories</b>  | Specifies the number of egress packets IPsec discards since boot time because not enough memory is available since boot time. |
| <b>generalError</b>          | Specifies a general error.                                                                                                    |
| <b>InAhSuccesses</b>         | Specifies the number of ingress packets IPsec carries because the AH authentication succeeds.                                 |
| <b>OutAHSuccesses</b>        | Specifies the number of egress packets IPsec successfully carries since boot time.                                            |
| <b>InESPSuccesses</b>        | Specifies the number of ingress packets IPsec carries since boot time because the ESP authentication succeeds.                |
| <b>OutESPSuccesses</b>       | Specifies the number of egress packets IPsec successfully carries since boot time.                                            |
| <b>OutKBytes</b>             | Specifies the total number of kilobytes on egress.                                                                            |
| <b>OutBytes</b>              | Specifies the total number of bytes on egress.                                                                                |
| <b>InKBytes</b>              | Specifies the total number of bytes on ingress.                                                                               |
| <b>InBytes</b>               | Specifies the total number of bytes on ingress.                                                                               |
| <b>TotalPacketsProcessed</b> | Specifies the total number of packets processed.                                                                              |
| <b>TotalPacketsByPassed</b>  | Specifies the total number of packets bypassed.                                                                               |

*Table continues...*

| Name                       | Description                                                                                                       |
|----------------------------|-------------------------------------------------------------------------------------------------------------------|
| <b>OutAHFailures</b>       | Specifies the number of egress packets IPsec discards since boot time because the AH authentication check fails.  |
| <b>OutESPFailures</b>      | Specifies the number of egress packets IPsec discards since boot time because the ESP authentication check fails. |
| <b>InMD5Hmacs</b>          | Specifies the number of inbound HMAC MD5 occurrences since boot time.                                             |
| <b>InSHA1Hmacs</b>         | Specifies the number of inbound HMAC SHA1 occurrences since boot time.                                            |
| <b>InAESXCBCs</b>          | Specifies the number of inbound AES XCBC MAC occurrences since boot time.                                         |
| <b>InAnyNullAuth</b>       | Specifies the number of inbound null authentication occurrences since boot time.                                  |
| <b>In3DESCBCs</b>          | Specifies the number of inbound 3DES CBC occurrences since boot time.                                             |
| <b>InAESCBCs</b>           | Specifies the number of inbound AES CBC occurrences since boot time.                                              |
| <b>InAESCTRs</b>           | Specifies the number of inbound AES CTR occurrences since boot time.                                              |
| <b>InAnyNulEncrypt</b>     | Specifies the number of inbound null occurrences since boot time. Used for debugging purposes.                    |
| <b>OutMD5Hmacs</b>         | Specifies the number of outbound HMAC MD5 occurrences since boot time.                                            |
| <b>OutSHA1Hmacs</b>        | Specifies the number of outbound HMAC SHA1 occurrences since boot time.                                           |
| <b>OutAESXCBCs</b>         | Specifies the number of outbound AES XCBC MAC occurrences since boot time.                                        |
| <b>OutInAnyNullAuth</b>    | Specifies the number of outbound null authentication occurrences since boot time.                                 |
| <b>Out3DESCBCs</b>         | Specifies the number of outbound 3DES CBC occurrences since boot time.                                            |
| <b>OutAESCBCs</b>          | Specifies the number of outbound AES CBC occurrences since boot time.                                             |
| <b>OutAESCTRs</b>          | Specifies the number of outbound AES CTR occurrences since boot time.                                             |
| <b>OutInAnyNullEncrypt</b> | Specifies the number of outbound null occurrences since boot time. Used for debugging purposes.                   |

## Displaying switch level statistics for IPsec-enabled interfaces

Use this procedure to view IPsec statistics and counter values at the switch level for all IPsec-enabled interfaces.

### Procedure

1. In the navigation pane, expand the following folders: **Configuration > Security > Control Path**.
2. Click **IPSec**.
3. Click the **Global Stats** tab.

### Global Stats field descriptions

Use the data in the following table to use the **Global Stats** tab.

| Name                       | Description                                                                                                        |
|----------------------------|--------------------------------------------------------------------------------------------------------------------|
| <b>InSuccesses</b>         | Specifies the number of ingress packets IPsec successfully carries.                                                |
| <b>InSPViolations</b>      | Specifies the number of ingress packets IPsec discards since boot time because of a security policy violation.     |
| <b>InNotEnoughMemories</b> | Specifies the number of ingress packets IPsec discards since boot time because not enough memory is available.     |
| <b>InAHESPReplays</b>      | Specifies the number of ingress packets IPsec discards since boot time because the AH replay check fails.          |
| <b>InESPReplays</b>        | Specifies the number of ingress packets IPsec discards since boot time because the ESP replay check fails.         |
| <b>InAHFailures</b>        | Specifies the number of ingress packets IPsec discards since boot time because the AH authentication check fails.  |
| <b>InESPFailures</b>       | Specifies the number of ingress packets IPsec discards since boot time because the ESP authentication check fails. |
| <b>OutSuccesses</b>        | Specifies the number of egress packets IPsec successfully carries since boot time.                                 |
| <b>OutSPViolations</b>     | Specifies the number of egress packets IPsec discards since boot time because a security policy violation occurs.  |

*Table continues...*

| Name                         | Description                                                                                                                   |
|------------------------------|-------------------------------------------------------------------------------------------------------------------------------|
| <b>OutNotEnoughMemories</b>  | Specifies the number of egress packets IPsec discards since boot time because not enough memory is available since boot time. |
| <b>generalError</b>          | Specifies a general error.                                                                                                    |
| <b>InAHSuccesses</b>         | Specifies the number of ingress packets IPsec carries because the AH authentication succeeds.                                 |
| <b>OutAHSuccesses</b>        | Specifies the number of egress packets IPsec successfully carries since boot time.                                            |
| <b>InESPSuccesses</b>        | Specifies the number of ingress packets IPsec carries since boot time because the ESP authentication succeeds.                |
| <b>OutESPSuccesses</b>       | Specifies the number of egress packets IPsec successfully carries since boot time.                                            |
| <b>OutKBytes</b>             | Specifies the total number of kilobytes on egress.                                                                            |
| <b>OutBytes</b>              | Specifies the total number of bytes on egress.                                                                                |
| <b>InKBytes</b>              | Specifies the total number of bytes on ingress.                                                                               |
| <b>InBytes</b>               | Specifies the total number of bytes on ingress.                                                                               |
| <b>TotalPacketsProcessed</b> | Specifies the total number of packets processed.                                                                              |
| <b>TotalPacketsByPassed</b>  | Specifies the total number of packets bypassed.                                                                               |
| <b>OutAHFailures</b>         | Specifies the number of egress packets IPsec discards since boot time because the AH authentication check fails.              |
| <b>OutESPFailures</b>        | Specifies the number of egress packets IPsec discards since boot time because the ESP authentication check fails.             |
| <b>InMD5Hmacs</b>            | Specifies the number of inbound HMAC MD5 occurrences since boot time.                                                         |
| <b>InSHA1Hmacs</b>           | Specifies the number of inbound HMAC SHA1 occurrences since boot time.                                                        |
| <b>InAESXCBCs</b>            | Specifies the number of inbound AES XCBC MAC occurrences since boot time.                                                     |
| <b>InAnyNullAuth</b>         | Specifies the number of inbound null authentication occurrences since boot time.                                              |
| <b>In3DESCBCs</b>            | Specifies the number of inbound 3DES CBC occurrences since boot time.                                                         |
| <b>InAESCBCs</b>             | Specifies the number of inbound AES CBC occurrences since boot time.                                                          |
| <b>InAESCTRs</b>             | Specifies the number of inbound AES CTR occurrences since boot time.                                                          |

*Table continues...*

| Name                       | Description                                                                                     |
|----------------------------|-------------------------------------------------------------------------------------------------|
| <b>InAnyNulEncrypt</b>     | Specifies the number of inbound null occurrences since boot time. Used for debugging purposes.  |
| <b>OutMD5Hmacs</b>         | Specifies the number of outbound HMAC MD5 occurrences since boot time.                          |
| <b>OutSHA1Hmacs</b>        | Specifies the number of outbound HMAC SHA1 occurrences since boot time.                         |
| <b>OutAESXCBCs</b>         | Specifies the number of outbound AES XCBC MAC occurrences since boot time.                      |
| <b>OutInAnyNullAuth</b>    | Specifies the number of outbound null authentication occurrences since boot time.               |
| <b>Out3DESCBCs</b>         | Specifies the number of outbound 3DES CBC occurrences since boot time.                          |
| <b>OutAESCBCs</b>          | Specifies the number of outbound AES CBC occurrences since boot time.                           |
| <b>OutAESCTRs</b>          | Specifies the number of outbound AES CTR occurrences since boot time.                           |
| <b>OutInAnyNullEncrypt</b> | Specifies the number of outbound null occurrences since boot time. Used for debugging purposes. |

## Configuring IPsec for the OSPF virtual link

Use the following procedure to configure and enable IPsec for the OSPF virtual link.

IPsec is disabled by default.

### About this task

Until you enable IPsec on both sides of the virtual links, the links cannot exchange OSPFv3 control messages, and the system drops OSPFv3 exchange packets.

You must disable IPsec before you can perform virtual link policy configuration changes.

### Before you begin

- Configure the OSPF virtual link.
- Create the IPsec security association.

### Procedure

1. In the navigation pane, expand the following folders: **Configuration > Security > Control Panel**.
2. Click **IPSec**.
3. Click the **OSPF Virtual Link** tab.
4. Click **Insert**.
5. Specify the area ID.

6. Specify the neighbor address.
7. Complete the remaining optional configuration.
8. Click **Insert**.

## OSPF Virtual Link field descriptions

Use the data in the following table to use the **OSPF Virtual Link** tab.

| Name               | Description                                                                                                                                                                                                                                                                                      |
|--------------------|--------------------------------------------------------------------------------------------------------------------------------------------------------------------------------------------------------------------------------------------------------------------------------------------------|
| <b>AreaId</b>      | Identifies the OSPF virtual link area.                                                                                                                                                                                                                                                           |
| <b>Neighbor</b>    | Identifies the OSPF virtual link neighbor.                                                                                                                                                                                                                                                       |
| <b>SAName</b>      | Links the security association to the OSPF virtual link.                                                                                                                                                                                                                                         |
| <b>AdminStatus</b> | Enables the policy. The default is disabled.                                                                                                                                                                                                                                                     |
| <b>Action</b>      | Configures the action of the IPsec policy under the OSPF virtual tunnel to one of the following: <ul style="list-style-type: none"> <li>• permit—Permits the IP packets.</li> <li>• drop—Drops the IP packets.</li> </ul> The default is permit.                                                 |
| <b>Direction</b>   | Specifies the direction you want to protect with IPsec: <ul style="list-style-type: none"> <li>• inBound—Specifies ingress traffic.</li> <li>• outBound—Specifies egress traffic.</li> <li>• bothDirections—Specifies both ingress and egress traffic.</li> </ul> The default is bothDirections. |
| <b>SrcAddress</b>  | Shows the address of the source interface to which the policy applies.                                                                                                                                                                                                                           |
| <b>DstAddress</b>  | Shows the address of the destination interface to which the policy applies.                                                                                                                                                                                                                      |
| <b>LinkID</b>      | Shows a unique ID for the OSPF virtual link. The default is 0.                                                                                                                                                                                                                                   |
| <b>IfIndex</b>     | Shows the interface index to which OSPF virtual link the policy applies.                                                                                                                                                                                                                         |
| <b>OperStatus</b>  | Shows the operational status of the link, either up or down. The default is down.                                                                                                                                                                                                                |

## IPsec configuration examples

The following section provides examples to configure Internet Protocol Security (IPsec).

**\* Note:**

If you downgrade your software, the current IPsec configurations are no longer supported. You must boot with the factory default settings for IPsec, and then reconfigure the IPsec features.

### IPsec configuration example

Review the following information to understand IPsec configuration.

Use the following steps to configure IPsec.

1. Create and configure an IPsec policy.
2. Enable the policy.
3. Create an IPsec security association to correspond with the IPsec policy.
4. Configure the key mode format.
5. Configure the security association.
6. Link the IPsec security association to the IPsec policy.
7. Enable the IPsec policy on the interface.
8. Link the IPsec policy with the interface.
9. Enable the IPsec on the interface that links to the IPsec policy.

For an example configuration and for more information on IPsec OSPFv3 and OSPFv3 virtual link, see *Configuring IPv6 Routing*.

Create a policy named `newpolicy` with a security association named `new_sa` on VLAN 100.

The following displays the IPsec policy configuration:

```
ipsec policy newpolicy raddr 2001:db8:0:0:0:0:0:1
ipsec policy newpolicy laddr 2001:db8:0:0:0:0:0:15
ipsec policy newpolicy protocol tcp sport 4 dport 5
ipsec policy newpolicy action permit
```

The following example displays the IPsec security association:

```
ipsec security-association new_sa
ipsec security-association new_sa key-mode manual
ipsec security-association new_sa mode transport
ipsec security-association new_sa encap-proto ESP
ipsec security-association new_sa Encrypt-algo 3DES-CBC encrypt-key
11111111111111111111111111111111 KeyLength 24
ipsec security-association new_sa auth-algo SHA1 auth-key 11111111111111111111111111111111 KeyLength
20
ipsec security-association new_sa spi 1
ipsec security-association new_sa lifetime seconds 1000
```

## IPsec with ICMPv6 configuration example

The following displays configuration of IPsec with ICMPv6.

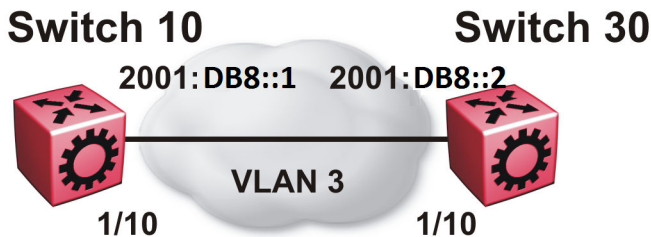

**Figure 22: IPsec configuration with ICMPv6**

### Switch 10 security association configuration

The following example displays the configuration of the security association on Switch 10.

```
ipsec security-association icmp
ipsec security-association icmp encap-proto ESP
ipsec security-association icmp mode transport
ipsec security-association icmp spi 1
ipsec security-association icmp auth-algo SHA1 auth-key
1234567890123456789012345678901234567890 keyLength 40
ipsec security-association icmp Enrcpt-algo AES-CBC EnrcptKey
12345678901234567890123456789012 keyLength 32
ipsec security-association icmp key-mode manual
ipsec security-association icmp lifetime seconds 1
ipsec security-association icmp lifetime bytes 1
```

### Switch 10 policy configuration

The following example displays the configuration of the security policy on Switch 10.

```
ipsec policy ICMP_Policy
ipsec policy ICMP_Policy admin enable
ipsec policy ICMP_Policy raddr 2001::2
ipsec policy ICMP_Policy laddr 2001::1
ipsec policy ICMP_Policy protocol icmpv6
ipsec policy ICMP_Policy action permit
ipsec policy ICMP_Policy security-association icmp
```

### Switch 10 interface configuration

The following example displays the configuration of IPsec on slot/port 1/10.

```
interface gigabitEthernet 1/10
no shut
interface vlan 3
interface address 2000::1
interface enable
ipv6 ipsec policy ICMP_Policy dir both
ipv6 ipsec enable
```



## Switch 10 VLAN configuration

The following example displays the creation and configuration of VLAN 3 with IPsec.

```
interface gigabitEthernet 1/10
no shut
exit
vlan create 3 type port-mstprstp 3
vlan members add 3 1/10 portmember
interface vlan 3
interface enable
interface address 2000::1
ipv6 ipsec policy ICMP_Policy dir both
ipv6 ipsec enable
```

## Switch 30 security association configuration

The following example displays the configuration of the security association on Switch 30.

```
ipsec security-association icmp
ipsec security-association icmp encap-proto ESP
ipsec security-association icmp mode transport
ipsec security-association icmp spi 1
ipsec security-association icmp auth-algo SHA1 auth-key
1234567890123456789012345678901234567890 keyLength 40
ipsec security-association icmp Encrpt-algo AES-CBC EncrptKey
12345678901234567890123456789012 keyLength 32
ipsec security-association icmp key-mode manual
ipsec security-association icmp lifetime seconds 1
ipsec security-association icmp lifetime bytes 1
```

## Switch 30 policy configuration

The following example displays the configuration of the security policy on Switch 30.

```
ipsec policy ICMP_Policy
ipsec policy ICMP_Policy admin enable
ipsec policy ICMP_Policy raddr 2001::1
ipsec policy ICMP_Policy laddr 2001::2
ipsec policy ICMP_Policy action permit
ipsec policy ICMP_Policy protocol icmpv6
ipsec policy ICMP_Policy security-association icmp
```

## Switch 30 interface configuration

The following example displays the configuration of IPsec on slot/port 1/10.

```
interface gigabitEthernet 1/10
no shut
ipv6 interface enable
ipv6 interface vlan 3
ipv6 interface address 2001::2
ipv6 ipsec policy ICMP_Policy dir both
ipv6 ipsec enable
```

## Switch 30 VLAN configuration

The following example displays the creation and configuration of VLAN 3 with IPsec.

```
interface gigabitEthernet 1/10
no shut
exit
vlan create 3 type port-mstprstp 0
vlan members add 3 1/20
interface vlan 3
ipv6 interface enable
```

```

ipv6 interface address 2001::2
ipv6 ipsec policy ICMP_Policy dir both
ipv6 ipsec enable

```

## OSPFv3 IPsec configuration example

The following example displays a network using IPsec used with OSPFv3.

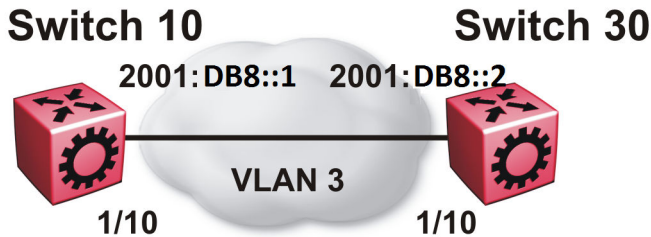

The following example displays the configuration of IPsec with OSPFv3. For OSPFv3 conceptual and procedural information, see *Configuring IPv6 Routing*.

### Switch 10 security associations

The following example displays the configuration of security associations for OSPFv3 for Switch 10.

```

ipsec security-association ospf1
ipsec security-association ospf1 encap-proto ESP
ipsec security-association ospf1 mode transport
ipsec security-association ospf1 spi 1
ipsec security-association ospf1 auth-algo MD5 auth-key 12345678901234567890123456789012
keyLength 32
ipsec security-association ospf1 Encrpt-algo AES-CTR EncrptKey
12345678901234567890123456789012 keyLength 32
ipsec security-association ospf1 key-mode manual
ipsec security-association ospf1 lifetime seconds 1
ipsec security-association ospf1 lifetime bytes 1

ipsec security-association ospf2
ipsec security-association ospf2 encap-proto ESP
ipsec security-association ospf2 mode transport
ipsec security-association ospf2 spi 2
ipsec security-association ospf2 auth-algo MD5 auth-key 12345678901234567890123456789012
keyLength 32
ipsec security-association ospf2 Encrpt-algo AES-CTR EncrptKey
12345678901234567890123456789012 keyLength 32
ipsec security-association ospf2 key-mode manual
ipsec security-association ospf2 lifetime seconds 1
ipsec security-association ospf2 lifetime bytes 1

ipsec security-association ospf3
ipsec security-association ospf3 encap-proto ESP
ipsec security-association ospf3 mode transport
ipsec security-association ospf3 spi 3
ipsec security-association ospf3 auth-algo MD5 auth-key 12345678901234567890123456789012

```

```

keyLength 32
ipsec security-association ospf3 Encrpt-algo AES-CTR EncrptKey
12345678901234567890123456789012 keyLength 32
ipsec security-association ospf3 key-mode manual
ipsec security-association ospf3 lifetime seconds 1
ipsec security-association ospf3 lifetime bytes 1

ipsec security-association ospf4
ipsec security-association ospf4 encap-proto ESP
ipsec security-association ospf4 mode transport
ipsec security-association ospf4 spi 4
ipsec security-association ospf4 auth-algo MD5 auth-key 12345678901234567890123456789012
keyLength 32
ipsec security-association ospf4 Encrpt-algo AES-CTR EncrptKey
12345678901234567890123456789012 keyLength 32
ipsec security-association ospf4 key-mode manual
ipsec security-association ospf4 lifetime seconds 1
ipsec security-association ospf4 lifetime bytes 1

ipsec security-association ospf5
ipsec security-association ospf5 encap-proto ESP
ipsec security-association ospf5 mode transport
ipsec security-association ospf5 spi 5
ipsec security-association ospf5 auth-algo MD5 auth-key 12345678901234567890123456789012
keyLength 32
ipsec security-association ospf5 Encrpt-algo AES-CTR EncrptKey
12345678901234567890123456789012 keyLength 32
ipsec security-association ospf5 key-mode manual
ipsec security-association ospf5 lifetime seconds 1
ipsec security-association ospf5 lifetime bytes 1

ipsec security-association ospf6
ipsec security-association ospf6 encap-proto ESP
ipsec security-association ospf6 mode transport
ipsec security-association ospf6 spi 6
ipsec security-association ospf6 auth-algo MD5 auth-key 12345678901234567890123456789012
keyLength 32
ipsec security-association ospf6 Encrpt-algo AES-CTR EncrptKey
12345678901234567890123456789012 keyLength 32
ipsec security-association ospf6 key-mode manual
ipsec security-association ospf6 lifetime seconds 1
ipsec security-association ospf6 lifetime bytes 1

```

## Switch 10 policy configuration

The following example displays the configuration of policies on Switch 10. The link local address is fe80:0:0:0:b2ad:aaff:fe43:100 and the remote link local address is fe80:0:0:0:b2ad:aaff:fe43:4d00. The following displays the policy with the laddr configured to the link local address and raddr configured to the remote link local address, with the direction configured as outbound.

```

ipsec policy ospf1
ipsec policy ospf1 admin enable
ipsec policy ospf1 raddr fe80:0:0:0:b2ad:aaff:fe43:4d00
ipsec policy ospf1 laddr fe80:0:0:0:b2ad:aaff:fe43:100
ipsec policy ospf1 protocol ospfv3
ipsec policy ospf1 action permit

```

The following example displays the configuration of policies on Switch 10. The link local address is fe80:0:0:0:b2ad:aaff:fe43:100 and the remote link local address is fe80:0:0:0:b2ad:aaff:fe43:4d00. The following displays the policy with the laddr configured to the link local address and raddr configured to the remote link local address, with the direction configured as inbound.

For a policy direction of inbound, laddr and raddr are reversed before storing to the stack. Because of this, even though the policy requires you to configure the laddr as the remote link local address, you need to configure laddr as the link local address in the configuration.

```
ipsec policy ospf2
ipsec policy ospf2 admin enable
ipsec policy ospf2 raddr fe80:0:0:0:b2ad:aaff:fe43:4d00
ipsec policy ospf2 laddr fe80:0:0:0:b2ad:aaff:fe43:100
ipsec policy ospf2 protocol ospfv3
ipsec policy ospf2 action permit
```

Laddr is configured to the link local and raddr is configured to ff02::05 with the direction configured as outbound.

```
ipsec policy ospf3
ipsec policy ospf3 admin enable
ipsec policy ospf3 raddr ff02::05
ipsec policy ospf3 laddr fe80:0:0:0:b2ad:aaff:fe43:100
ipsec policy ospf3 protocol ospfv3
ipsec policy ospf3 action permit
```

Laddr is configured to the remote link local and raddr is configured to ff02::05 with the direction configured as inbound.

```
ipsec policy ospf4
ipsec policy ospf4 admin enable
ipsec policy ospf4 raddr fe80:0:0:0:b2ad:aaff:fe43:4d00
ipsec policy ospf4 laddr ff02::05
ipsec policy ospf4 protocol ospfv3
ipsec policy ospf4 action permit
```

Laddr is configured to the link local and raddr is configured to ff02::06 with the direction as outbound.

```
ipsec policy ospf5
ipsec policy ospf5 admin enable
ipsec policy ospf5 raddr ff02::06
ipsec policy ospf5 laddr fe80:0:0:0:b2ad:aaff:fe43:100
ipsec policy ospf5 protocol ospfv3
ipsec policy ospf5 action permit
```

Laddr is configured to the remote link local and raddr is configured to ff02::06 with the direction configured as inbound.

```
ipsec policy ospf6
ipsec policy ospf6 admin enable
ipsec policy ospf6 raddr fe80:0:0:0:b2ad:aaff:fe43:4d00
ipsec policy ospf6 laddr ff02::06
ipsec policy ospf6 protocol ospfv3
ipsec policy ospf6 action permit
```

## Switch 10 link table configuration

The following example displays the linking of the policy with the security association on Switch 10.

```
ipsec policy ospf1 security-association ospf1
ipsec policy ospf2 security-association ospf2
ipsec policy ospf3 security-association ospf3
ipsec policy ospf4 security-association ospf4
ipsec policy ospf5 security-association ospf5
ipsec policy ospf6 security-association ospf6
```

## Switch 10 OSPFv3 configuration

The following example displays the OSPFv3 configuration on Switch 10.

```
router ospf ipv6-enable
router ospf
ipv6 router-id 1.1.1.1
ipv6 area 0.0.0.1
```

## Switch 10 interface configuration

The following example displays the interface configuration on slot/port 1/10.

```
interface gigabitEthernet 1/10
no shut
ipv6 interface vlan 3
ipv6 interface address 2000::1/64
ipv6 interface enable
ipv6 ospf area 0.0.0.1
ipv6 ospf enable
ipv6 ipsec policy ospf1 dir out
ipv6 ipsec policy ospf2 dir in
ipv6 ipsec policy ospf3 dir out
ipv6 ipsec policy ospf4 dir in
ipv6 ipsec policy ospf5 dir out
ipv6 ipsec policy ospf6 dir in
ipv6 ipsec enable
```

## Switch 10 VLAN configuration

The following example displays the creation of VLAN 3 and the configuration of IPsec on VLAN 3.

```
interface gigabitEthernet 1/10
no shut
exit
vlan create 3 type port-mstprstp 3
vlan members add 3 1/10 portmember
interface vlan 3
ipv6 interface enable
ipv6 interface address 2000::1/64
ipv6 ospf area 0.0.0.1
ipv6 ospf enable
ipv6 ipsec policy ospf1 dir out
ipv6 ipsec policy ospf2 dir in
ipv6 ipsec policy ospf3 dir out
ipv6 ipsec policy ospf4 dir in
ipv6 ipsec policy ospf5 dir out
ipv6 ipsec policy ospf6 dir in
ipv6 ipsec enable
```

## Switch 30 security associations

The following example displays the configuration of security associations for OSPFv3 for Switch 30.

```
ipsec security-association ospf1 auth-algo MD5 auth-key 12345678901234567890123456789012
keyLength 32
ipsec security-association ospf1 Encrpt-algo AES-CTR EncrptKey
12345678901234567890123456789012 keyLength 32
ipsec security-association ospf1 key-mode manual
ipsec security-association ospf1 lifetime seconds 1
ipsec security-association ospf1 lifetime bytes 1

ipsec security-association ospf2
ipsec security-association ospf2 encap-proto ESP
ipsec security-association ospf2 mode transport
ipsec security-association ospf2 spi 2
```

```

ipsec security-association ospf2 auth-algo MD5 auth-key 12345678901234567890123456789012
keyLength 32
ipsec security-association ospf2 Encrpt-algo AES-CTR EncrptKey
12345678901234567890123456789012 keyLength 32
ipsec security-association ospf2 key-mode manual
ipsec security-association ospf2 lifetime seconds 1
ipsec security-association ospf2 lifetime bytes 1

ipsec security-association ospf3
ipsec security-association ospf3 encap-proto ESP
ipsec security-association ospf3 mode transport
ipsec security-association ospf3 spi 3
ipsec security-association ospf3 auth-algo MD5 auth-key 12345678901234567890123456789012
keyLength 32
ipsec security-association ospf3 Encrpt-algo AES-CTR EncrptKey
12345678901234567890123456789012 keyLength 32
ipsec security-association ospf3 key-mode manual
ipsec security-association ospf3 lifetime seconds 1
ipsec security-association ospf3 lifetime bytes 1

ipsec security-association ospf4
ipsec security-association ospf4 encap-proto ESP
ipsec security-association ospf4 mode transport
ipsec security-association ospf4 spi 4
ipsec security-association ospf4 auth-algo MD5 auth-key 12345678901234567890123456789012
keyLength 32
ipsec security-association ospf4 Encrpt-algo AES-CTR EncrptKey
12345678901234567890123456789012 keyLength 32
ipsec security-association ospf4 key-mode manual
ipsec security-association ospf4 lifetime seconds 1
ipsec security-association ospf4 lifetime bytes 1

ipsec security-association ospf5
ipsec security-association ospf5 encap-proto ESP
ipsec security-association ospf5 mode transport
ipsec security-association ospf5 spi 5
ipsec security-association ospf5 key-mode manual
ipsec security-association ospf5 lifetime seconds 1
ipsec security-association ospf5 lifetime bytes 1

ipsec security-association ospf6
ipsec security-association ospf6 encap-proto ESP
ipsec security-association ospf6 mode transport
ipsec security-association ospf6 spi 6
ipsec security-association ospf6 auth-algo MD5 auth-key 12345678901234567890123456789012
keyLength 32
ipsec security-association ospf6 Encrpt-algo AES-CTR EncrptKey
12345678901234567890123456789012 keyLength 32
ipsec security-association ospf6 key-mode manual
ipsec security-association ospf6 lifetime seconds 1
ipsec security-association ospf6 lifetime bytes 1

```

### Switch 30 policy configuration

In the example, the local address is fe80:0:0:0:b2ad:aaff:fe43:4d00, and the remote address is fe80:0:0:0:b2ad:aaff:fe43:100. The policy has the laddr configured to the link local address and the raddr is configured to the remote link local address with the direction configured to outbound.

```

ipsec policy ospf1
ipsec policy ospf1 admin enable
ipsec policy ospf1 raddr fe80:0:0:0:b2ad:aaff:fe43:100
ipsec policy ospf1 laddr fe80:0:0:0:b2ad:aaff:fe43:4d00
ipsec policy ospf1 protocol ospv3
ipsec policy ospf1 action permit

```

Laddr is configured to the remote link local address and raddr is configured to the local link local address with the direction configured to inbound.

```
ipsec policy ospf2
ipsec policy ospf2 admin enable
ipsec policy ospf2 raddr fe80:0:0:0:b2ad:aaff:fe43:100
ipsec policy ospf2 laddr fe80:0:0:0:b2ad:aaff:fe43:4d00
ipsec policy ospf2 protocol ospfv3
ipsec policy ospf2 action permit
```

Laddr is configured to the link local address and raddr is configured to ff02::05 with the direction configured to outbound.

```
ipsec policy ospf3
ipsec policy ospf3 admin enable
ipsec policy ospf3 raddr ff02::05
ipsec policy ospf3 laddr fe80:0:0:0:b2ad:aaff:fe43:4d00
ipsec policy ospf3 protocol ospfv3
ipsec policy ospf3 action permit
```

Laddr is configured to the remote link local address and the raddr is configured to ff02::05 with the direction configured to inbound.

```
ipsec policy ospf4
ipsec policy ospf4 admin enable
ipsec policy ospf4 raddr fe80:0:0:0:b2ad:aaff:fe43:100
ipsec policy ospf4 laddr ff02::05
ipsec policy ospf4 protocol ospfv3
ipsec policy ospf4 action permit
```

Laddr is configured to the link local address and raddr is configured to ff02::06 with the direction configured to outbound.

```
ipsec policy ospf5
ipsec policy ospf5 admin enable
ipsec policy ospf5 raddr ff02::06
ipsec policy ospf5 laddr fe80:0:0:0:b2ad:aaff:fe43:4d00
ipsec policy ospf5 protocol ospfv3
ipsec policy ospf5 action permit
```

Laddr is configured to the remote link local address and raddr is configured to ff02::06 with the direction configured to inbound.

```
ipsec policy ospf6
ipsec policy ospf6 admin enable
ipsec policy ospf6 raddr fe80:0:0:0:b2ad:aaff:fe43:100
ipsec policy ospf6 laddr ff02::06
ipsec policy ospf6 protocol ospfv3
ipsec policy ospf6 action permit
```

### Switch 30 link table configuration

The following example displays the linking of the policy with the security association on Switch 30.

```
ipsec policy ospf1 security-association ospf1
ipsec policy ospf2 security-association ospf2
ipsec policy ospf3 security-association ospf4
ipsec policy ospf4 security-association ospf3
ipsec policy ospf5 security-association ospf5
ipsec policy ospf6 security-association ospf6
```

### Switch 30 OSPFv3 configuration

The following example displays the OSPFv3 configuration on Switch 30.

```
router ospf ipv6-enable
router ospf
ipv6 router-id 2.2.2.2
ipv6 area 0.0.0.1
```

### Switch 30 interface configuration

The following example displays the interface configuration on slot/port 1/10.

```
interface gigabitEthernet 1/10
no shut
ipv6 interface vlan 3
ipv6 interface address 2001::2/64
ipv6 interface enable
ipv6 ospf area 0.0.0.1
ipv6 ospf enable
ipv6 ipsec policy ospf1 dir out
ipv6 ipsec policy ospf2 dir in
ipv6 ipsec policy ospf3 dir out
ipv6 ipsec policy ospf4 dir in
ipv6 ipsec policy ospf5 dir out
ipv6 ipsec policy ospf6 dir in
ipv6 ipsec enable
```

### Switch 30 VLAN configuration

The following example displays the creation of VLAN 3 and the configuration of IPsec on VLAN 3.

```
interface gigabitEthernet 1/10
no shut
exit
minvlan create 3 type port-mstprstp 0
vlan members add 3 1/10 portmember
interface vlan 3
ipv6 interface enable
ipv6 interface address 2001::2/64
ipv6 ospf area 0.0.0.1
ipv6 ospf enable
ipv6 ipsec policy ospf1 dir out
ipv6 ipsec policy ospf2 dir in
ipv6 ipsec policy ospf3 dir out
ipv6 ipsec policy ospf4 dir in
ipv6 ipsec policy ospf5 dir out
ipv6 ipsec policy ospf6 dir in
ipv6 ipsec enable
```

---

## OSPFv3 virtual link IPsec configuration example

The following example displays a network using IPsec with OSPFv3 virtual link.



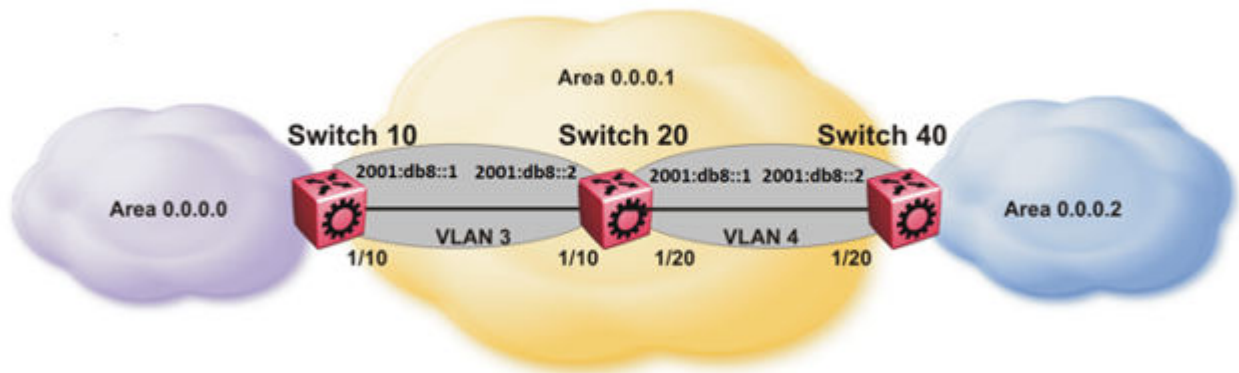

**Figure 23: OSPFv3 virtual link with IPsec configuration**

The following example displays the configuration of IPsec with OSPFv3 virtual link. For OSPFv3 conceptual and procedural information, see *Configuring IPv6 Routing*.

### Switch 10 security association configuration

The following example displays the configuration of security associations for OSPFv3 for Switch 10.

```
ipsec security-association ospf1
ipsec security-association ospf1 encap-proto ESP
ipsec security-association ospf1 mode transport
ipsec security-association ospf1 spi 1
ipsec security-association ospf1 auth-algo MD5 auth-key 12345678901234567890123456789012
keyLength 32
ipsec security-association ospf1 Encrpt-algo AES-CTR EncrptKey
12345678901234567890123456789012 keyLength 32
ipsec security-association ospf1 key-mode manual
ipsec security-association ospf1 lifetime seconds 1
ipsec security-association ospf1 lifetime bytes 1
```

### Switch 10 OSPFv3 configuration

The following example displays the OSPFv3 configuration on Switch 10.

```
router ospf ipv6-enable
ipv6 forwarding
router ospf
ipv6 router-id 1.1.1.1
ipv6 area 0.0.0.1
ipv6 as-boundary-router
ipv6 area 0.0.0.0
```

### Switch 10 virtual link and policy configuration

The following example displays the configuration of a OSPFv3 virtual link.

```
ipv6 area virtual-link 0.0.0.1 3.3.3.3
ipv6 area virtual-link 0.0.0.1 3.3.3.3 ipsec
ipv6 area virtual-link 0.0.0.1 3.3.3.3 ipsec security-association ospf1
ipv6 area virtual-link 0.0.0.1 3.3.3.3 ipsec action permit
ipv6 area virtual-link 0.0.0.1 3.3.3.3 ipsec direction both
ipv6 area virtual-link 0.0.0.1 3.3.3.3 ipsec enable
```

## Switch 10 interface configuration

The following example displays the interface configuration on slot/port 1/10.

```
interface gigabitEthernet 1/10
no shut
ipv6 interface vlan 3
ipv6 interface address 2000::1/64
ipv6 interface enable
ipv6 ospf area 0.0.0.1
ipv6 ospf enable
```

## Switch 10 VLAN configuration

The following example displays the creation of VLAN 3 and the configuration of IPsec on VLAN 3.

```
interface gigabitEthernet 1/10
no shut
exit
vlan create 3 type port-mstprstp 3
vlan members add 3 1/10 port-member
interface vlan 3
ipv6 interface enable
ipv6 interface address 2000::1/64
ipv6 ospf area 0.0.0.1
ipv6 ospf enable
```

## Switch 20 OSPFv3 configuration

The following example displays the OSPFv3 configuration on Switch 20.

```
router ospf ipv6-enable
ipv6 forwarding
router ospf
ipv6 router-id 2.2.2.2
ipv6 area 0.0.0.1
```

## Switch 20 interface configuration

The following example displays the interface configuration on slot/port 1/10 and 1/20.

```
interface gigabitEthernet 1/10
no shut
ipv6 interface vlan 3
ipv6 interface address 2000::2/64
ipv6 interface enable
ipv6 ospf area 0.0.0.1
ipv6 ospf enable

interface gigabitEthernet 1/20
no shut
ipv6 interface vlan 4
ipv6 interface address 2001::1/64
ipv6 interface enable
ipv6 ospf area 0.0.0.1
ipv6 ospf enable
```

## Switch 20 VLAN configuration

The following example displays the creation of VLAN 3 and the configuration of IPsec on VLAN 3 and VLAN 4.

```
interface gigabitEthernet 1/10
no shut
exit
vlan create 3 type port-mstprstp 0
```

```

vlan members add 3 1/10 portmember
interface vlan 3
ipv6 interface enable
ipv6 interface address 2000::2/64
ipv6 ospf area 0.0.0.1
ipv6 ospf enable

interface gigabitEthernet 1/20
no shut
exit
vlan create 4 type port-mstprstp 0
vlan members add 4 1/20 portmember
interface vlan 4
ipv6 interface enable
ipv6 interface address 2001::1/64
ipv6 ospf area 0.0.0.1
ipv6 ospf enable

```

### Switch 40 security association configuration

The following example displays the configuration of security associations for OSPFv3 for Switch 40.

```

ipsec security-association ospf1
ipsec security-association ospf1 encap-proto ESP
ipsec security-association ospf1 mode transport
ipsec security-association ospf1 spi 1
ipsec security-association ospf1 auth-algo MD5 auth-key 12345678901234567890123456789012
keyLength 32
ipsec security-association ospf1 Encrpt-algo AES-CTR EncrptKey
12345678901234567890123456789012 keyLength 32
ipsec security-association ospf1 key-mode manual
ipsec security-association ospf1 lifetime seconds 1
ipsec security-association ospf1 lifetime bytes 1

```

### Switch 40 OSPFv3 configuration

The following example displays the OSPFv3 configuration on Switch 40.

```

router ospf ipv6-enable
ipv6 forwarding
router ospf
ipv6 router-id 3.3.3.3
ipv6 area 0.0.0.1
ipv6 area 0.0.0.2
ipv6 as-boundary-router

```

### Switch 40 OSPFv3 virtual link and policy configuration

The following example displays the configuration of a OSPFv3 virtual link.

```

ipv6 area virtual-link 0.0.0.1 1.1.1.1
ipv6 area virtual-link 0.0.0.1 1.1.1.1 ipsec
ipv6 area virtual-link 0.0.0.1 1.1.1.1 ipsec security-association ospf1
ipv6 area virtual-link 0.0.0.1 1.1.1.1 ipsec action permit
ipv6 area virtual-link 0.0.0.1 1.1.1.1 ipsec direction both
ipv6 area virtual-link 0.0.0.1 1.1.1.1 ipsec enable

```

### Switch 40 interface configuration

The following example displays the interface configuration on slot/port 1/20.

```

interface gigabitEthernet 1/20
no shut
ipv6 interface vlan 4
ipv6 interface address 2001::2/64
ipv6 interface enable

```

## IPsec

```
ipv6 ospf area 0.0.0.1
ipv6 ospf enable
```

### Switch 40 VLAN interface configuration

The following example displays the creation of VLAN 4 and the configuration of IPsec on VLAN 4.

```
interface gigabitEthernet 1/20
no shut
exit
vlan create 4 type port-mstprstp 0
vlan members add 4 1/20
interface vlan 4
ipv6 interface enable
ipv6 interface address 2001::2/64
ipv6 ospf area 0.0.0.1
ipv6 ospf enable
```

---

## IPsec configuration of TCP

The following example displays the configuration of IPsec for TCP.

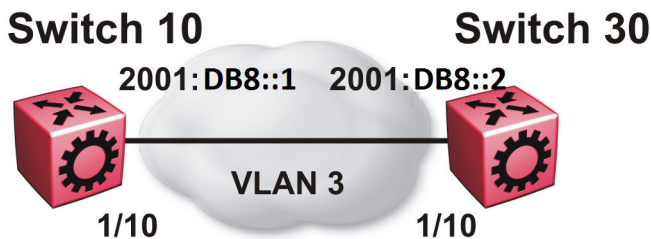

### Switch 10 IPsec security association configuration

The following example displays the configuration of the IPsec security association for TCP for Switch 10.

```
ipsec security-association tcp1
ipsec security-association tcp1 encap-proto ESP
ipsec security-association tcp1 mode transport
ipsec security-association tcp1 spi 100
ipsec security-association tcp1 auth-algo MD5 auth-key 12345678901234567890123456789012
keyLength 32
ipsec security-association tcp1 Encrpt-algo AES-CTR EncrptKey
12345678901234567890123456789012 keyLength 32
ipsec security-association tcp1 key-mode manual
ipsec security-association tcp1 lifetime seconds 1
ipsec security-association tcp1 lifetime bytes 1
```

### Switch 10 IPsec policy configuration

The following example displays the configuration of the IPsec policy for TCP for Switch 10.

```
ipsec policy tcp1
ipsec policy tcp1 admin enable
```

```
ipsec policy tcp1 raddr 2000::2
ipsec policy tcp1 raddr 2000::2 laddr 2000::1
ipsec policy tcp1 raddr 2000::2 protocol tcp sport 23 dport 23
ipsec policy tcp1 raddr 2000::2 action permit
```

### Switch 10 linking the IPsec policy with the IPsec security association

The following example displays the linking of the IPsec policy with the IPsec security association

```
ipsec policy tcp1 security-association tcp1
```

### Switch 10 interface configuration

The following examples displays the configuration of IPsec for slot/port 1/10.

```
interface gigabitEthernet 1/10
no shut
ipv6 interface vlan 3
ipv6 interface address 2000::1/64
ipv6 interface enable
ipv6 ipsec policy tcp1 dir both
ipv6 ipsec enable
```

### Switch 10 VLAN configuration

The following example displays the creation and configuration of VLAN 3.

```
interface gigabitEthernet 1/10
no shut
exit
vlan create 3 type port-mstprstp 3
vlan members add 3 1/10 portmember
interface vlan 3
ipv6 interface enable
ipv6 interface address 2000::1/64
ipv6 ipsec policy tcp1 dir both
ipv6 ipsec enable
```

### Switch 30 IPsec security association configuration

The following example displays the configuration of the IPsec security association for TCP for Switch 10.

```
ipsec security-association tcp1
ipsec security-association tcp1 encap-proto ESP
ipsec security-association tcp1 mode transport
ipsec security-association tcp1 spi 100
ipsec security-association tcp1 auth-algo MD5 auth-key 12345678901234567890123456789012
keyLength 32
ipsec security-association tcp1 Encrpt-algo AES-CTR EncrptKey
12345678901234567890123456789012 keyLength 32
ipsec security-association tcp1 key-mode manual
ipsec security-association tcp1 lifetime seconds 1
ipsec security-association tcp1 lifetime bytes 1
```

### Switch 30 IPsec policy configuration

The following example displays the configuration of the IPsec policy for TCP for Switch 10.

```
ipsec policy tcp1
ipsec policy tcp1 admin enable
ipsec policy tcp1 raddr 2000::1
ipsec policy tcp1 raddr 2000::1 laddr 2000::2
ipsec policy tcp1 raddr 2000::1 protocol tcp sport 23 dport 23
ipsec policy tcp1 raddr 2000::1 action permit
```

### Switch 30 linking the IPsec policy with the IPsec security association

The following example displays the linking of the IPsec policy with the IPsec security association

```
ipsec policy tcp1 security-association tcp1
```

### Switch 30 interface configuration

The following examples displays the configuration of IPsec for slot/port 1/10.

```
interface gigabitEthernet 1/10
no shut
ipv6 interface vlan 3
ipv6 interface address 2000::2/64
ipv6 interface enable
ipv6 ipsec policy tcp1 dir both
ipv6 ipsec enable
```

### Switch 30 VLAN configuration

The following example displays the creation and configuration of VLAN 3.

```
interface gigabitEthernet 1/10
no shut
exit
vlan create 3 type port-mstprstp 3
vlan members add 3 1/10 portmember
interface vlan 3
ipv6 interface enable
ipv6 interface address 2000::2/64
ipv6 ipsec policy tcp1 dir both
ipv6 ipsec enable
```

# Chapter 7: MACsec

The following sections describe Media Access Control Security (MACsec) and its configuration.

**\* Note:**

This feature is not supported on all hardware platforms. If you do not see commands for this feature in the command list or EDM, the feature is not supported on your hardware. For more information about feature support, see *Release Notes*.

---

## MACsec fundamentals

MAC Security (MACsec) is based on the IEEE 802.1ae standard that allows authorized systems in a network to transmit data confidentially and to protect against data transmitted or modified by unauthorized devices.

You can use MACsec for core and enterprise edge switches to secure site-to-site connectivity between data centers, provide data security on links that run over public ground, or outside the physically secure boundaries of a site. You can use MACsec on access switches to secure host to switch connectivity, and host to switch connectivity in an environment where both trusted and untrusted hosts co-exist.

In addition to host level authentication, MACsec capable LANs provide data origin authentication, data confidentiality, and data integrity between authenticated hosts or systems. MACsec protects data from external hacking while the data passes through the public network to reach a receiver host.

MACsec enabled hosts encrypt and decrypt every frame exchanged between them using a MACsec key. The source MACsec host encrypts data frames and destination MACsec host decrypts the frames, ensuring delivery of the frame in its original condition to the recipient host. This ensures secure data communication.

You can configure MACsec encryption over any type of point-to-point Ethernet or emulated Ethernet connection, which includes:

- Dark fiber
- Conventional wavelength-division multiplexing/dense wavelength-division multiplexing (CWDM/DWDM) service
- Multiprotocol label switching (MPLS) point-to-point (ELINE)

- Provider Backbone Bridge Traffic Engineering (PBB-TE)

You can configure MACsec on physical ports *only*. However, the physical ports can belong to an MLT trunk group that includes: Split MultiLink Trunking (SMLT), distributed MultiLink Trunking (DMLT), or Link aggregate group (LAG).

You configure a pre-shared key on either end of the MACsec link. The pre-shared key is an interface parameter, not a switch-wide parameter.

 **Note:**

MACsec encrypts all packets. If you configure MACsec on one or more MultiLink Trunking (MLT) port members on one side, you must configure MACsec on the same port members on the other side. If you do not do this, the port can physically be up, but any overlying protocols can be down. You do not have to provision MACsec on all MLT port members, but if you configure MACsec on an MLT port member on one side, you must also provision MACsec on the corresponding MLT port on the other side.

One way to detect a mismatch of MACsec configuration is to use Virtual Link Aggregation Control Protocol (VLACP) on the links.

MACsec provides security at the data link layer or the physical layer. It provides enhancements at the MAC service sub layer for its operation and services to the upper layer.

MACsec is an interface level feature and is disabled by default.

---

## MACsec keys

MACsec provides industry-standard security through secure point-to-point Ethernet links. The point-to-point links are secured after matching security keys.

Security keys are of two types:

- connectivity association key (CAK), which is a configured *pre-shared key*. If you enable MACsec using the static connectivity association key (CAK) security mode.

 **Important:**

The switch supports the configuration of a pre-shared key to enable MACsec using the static connectivity association key (CAK) security mode.

The CAK must be identical across both ends of MACsec links.

- secure association key (SAK), which is a configured *static secure association key*. If you use the static secure association key (SAK) security mode. SAKs are short-lived keys derived from the CAK or pre-configured for a particular secure channel (SC). MACsec uses a timer to refresh these keys so that the key, as well the session, is secure.

MACsec uses derived keys to encrypt or decrypt data at each end of the MACsec links.



## Integrity Check Verification (ICV)

MACsec ensures data integrity using Integrity Check Verification (ICV). MACsec introduces an 8 or 16 byte SecTag after the Ethernet header, and an 8 or 16 byte calculated ICV after the Encrypted Payload. MACsec computes the ICV for the entire frame, starting from the Ethernet header, SecTag until the Checksum. The receiving side recalculates the ICV after data decryption and verifies if the received ICV and computed ICV match. If the ICVs do not match, it indicates that data is modified, and MACsec drops the frame.

---

## MACsec security modes

The static Connectivity Association Key (CAK) security mode is the only supported MACsec security mode on the platform, and is also the most common mode to enable MACsec.

When you use the static connectivity association key (CAK) security mode to enable MACsec, you configure a community association on both ends of the link. A pre-shared key establishes the MACsec relationship between the switches on each end of the Ethernet link. The two pre-shared security association keys (SAKs) include a connectivity association key name (CKN) and its own connectivity association key (CAK). The MACsec CKN and CAK are configured in a connectivity association and the CAK must match on both ends of the link to initially enable MACsec.

To ensure link security, the system periodically refreshes keys based on traffic volume and link speed.

To enable MACsec at the port level, you must first associate the port to the connectivity association. You complete the configuration within the connectivity association, but outside of the secure channel.

When you use the static CAK security mode, the system automatically creates two secure channels, one for inbound traffic and another for outbound traffic. You cannot configure any parameters in the automatically-created secure channels.

The CAK security mode ensures security by frequently refreshing to a new random security key, and by only sharing the security key between the two devices on the MACsec-secured point-to-point link.

MACsec provides options to encrypt user payload, or send in a clear confidential offset, to start the encryption from selectable bytes of 0, 30, and 50 after the SecTag header.

You can choose to configure the following optional features:

- **Data encryption** — If you disable encryption, MACsec forwards traffic in clear text. You can view that data that is not encrypted in the Ethernet frame that travels across the link. Even if you disable encryption the MACsec header applies to the frame and integrity checks make sure that traffic has not been tampered with.
- **Confidentiality offset** — If encryption is enabled, and an offset is not configured, all traffic in the connectivity is encrypted. The confidentiality offset provides a way to start encryption after a few bytes following the Ethernet header. The confidentiality offset facilitates traffic flow inspection and classification on intermediate devices by not encrypting the Network Layer header for IPv4 or IPv6. For instance, if you configure the offset to 30, the IPv4 header and the

TCP/UDP header are not encrypted. If you configure the offset to 50, the IPv6 header and the TCP/UDP header is not encrypted.

---

## Connectivity associations and secure channels

You configure MACsec in connectivity associations (CA). You can enable MACsec after you attach a connectivity association to an interface. To use the static CAK security mode to enable MACsec, you must create, and configure connectivity associations on both ends of the link.

A connectivity association (CA) is a logical representation of a MACsec domain within a network. Each connectivity association is associated with a connectivity association key (CAK). MACsec links are associated with a CA to establish end-to-end MACsec communication. Every MACsec enabled interface is a member of one connectivity association. Switch ports are members of a connectivity association, and can only be a member of one connectivity association.

A secure channel (SC) is a unidirectional channel that connects two endpoints of MACsec. A secure channel is a long-term relationship that persists through the sequence of secure associations.

A secure association (SA) is a short-lived relationship within an SC. MACsec identifies each security association by AN, and supported Secure association key (SAK), which is derived from the CAK. The secure association key is used on both ends of MACsec links to encrypt and decrypt the frames. SAKs are frequently refreshed for security reasons. Periodically changing SAs allows the use of fresh keys without terminating the SC relationship.

You configure connectivity associations. Secure channels and secure associations are internally created in the hardware.

---

## MACsec 2AN and 4AN mode

MACsec 2AN mode implementations use two security associations (SA) for each secure channel (SC) and symmetric keys on both MACsec endpoints. The keys are symmetric because they are both derived from the same connectivity association key (CAK).

MACsec 4AN mode generates four Secure Associations Keys (SAK) per secure channel. It uses enhanced hashing algorithm to derive eight SAKs, and uses asymmetric keys on both ends. You can use the `macsec connectivity-association` command to configure different (asymmetric) transmit keys for each endpoint by using the `key-parity` keyword. If you do not specify a value for `key-parity`, the connectivity association is created in 2AN mode. For more information about configuring MACsec transmit keys, see [Configuring a connectivity association](#) on page 286.

---

## MACsec components

MACsec has three major components:

- **Security entity (SecY)**

SecY is the entity that operates the MACsec protocol within the system. You configure a secure community association (CA) to meet the requirements of MACsec for connectivity between stations that attach to an individual LAN. Unidirectional secure channels (SC) support each CA. Each SC supports secure transmission of frames through the use of symmetric key cryptography from one of the systems to all the others in the CA.

Each SecY transmits frames conveying secure MACsec service requests on a single SC, and receives frames conveying secure service indications on separate SCs, one for each of the other SecYs that participate in the secure CA.

A connectivity association (CA) is a logical representation of a MACsec domain within a network. Each connectivity association is associated with a connectivity association key (CAK). MACsec links are associated with a CA to establish end-to-end MACsec communication. Every MACsec enabled interface is a member of one connectivity association. Switch ports are members of a connectivity association, and can only be a member of one connectivity association.

A secure channel (SC) is a unidirectional channel that connects two endpoints of MACsec. A secure channel is a long-term relationship that persists through the sequence of secure associations. An SC is a unidirectional point to multipoint communication, and can persist through Secure Association Key (SAK) changes. A sequence of Secure Associations (SAs) support each SC and allow for the periodic use of fresh keys without terminating the relationship. A single secret key or a set of keys support each SA, where the cryptographic operations used to protect one frame require more than one key. An SCI identifies each SC. An SCI is comprised of a unique 48-bit universally administered MAC address, identifying the system to which the transmitting SecY belongs, concatenated with a 16-bit port number, identifying the SecY within that system.

The SCI concatenated with a two-bit AN identifies each SA. The Secure Association Identifier (SAI) created allows the receiving SecY to identify the SA, and the SAK used to decrypt and authenticate the received frame. The AN, and hence the SAI, are only unique for the SAs that can be used or recorded by participating SecYs at any instant.

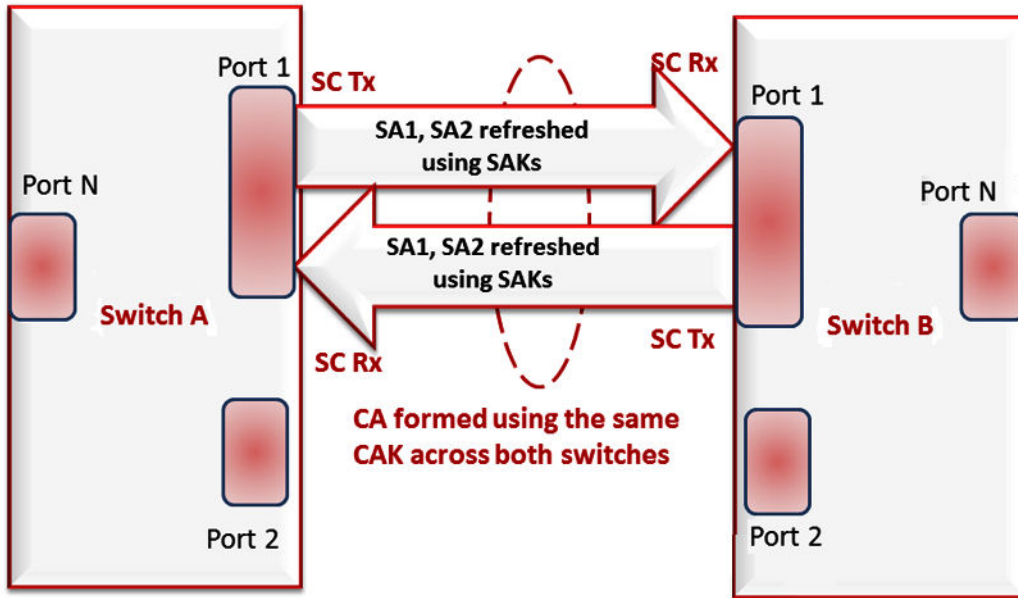

Figure 24: MACsec relationship

- **Key agreement entity (KaY)**

The KaY in MACsec is responsible for CAK and SAK computations, distributions and maintenance of those keys. CAK is a global key which is persistent until the CA exists. When you configure the CAK, ensure that it is identical across MACsec links. SAK are short-lived keys derived from the CAK, or pre-configured for a particular SC. MACsec uses a timer to refresh these keys so that the key, as well the session, is secure.

A separate 802.1x-2010 standard is available to automate the above key exchanges and maintenance. The keys are pre-configured.

- **Integrity check verification (ICV) or Cryptographic entity**

The Cryptographic entity provides integrity check protection and validation for frames transmitted or received through the SecY layer. The ICV is calculated for the frame SA/DA, SecTag, User Payload, and CRC. The calculated ICV is appended at the end-of-frame, recalculated at the receiver side of MACsec link and validated to see if they are equal. This is called Integrity Check Verification (ICV). The frames that pass the integrity check are further processed, while the system drops the frames that fail the integrity check.

MACsec configuration provides options to encrypt user payload or send in the clear. The option to start the encryption from N bytes after the Ethernet header also exists.

In the following figure, CA connects switches A, B, and C by their respective SC and SAK. Station D cannot participate in the secure communication between A, B, or C as station D does not know the SAK.

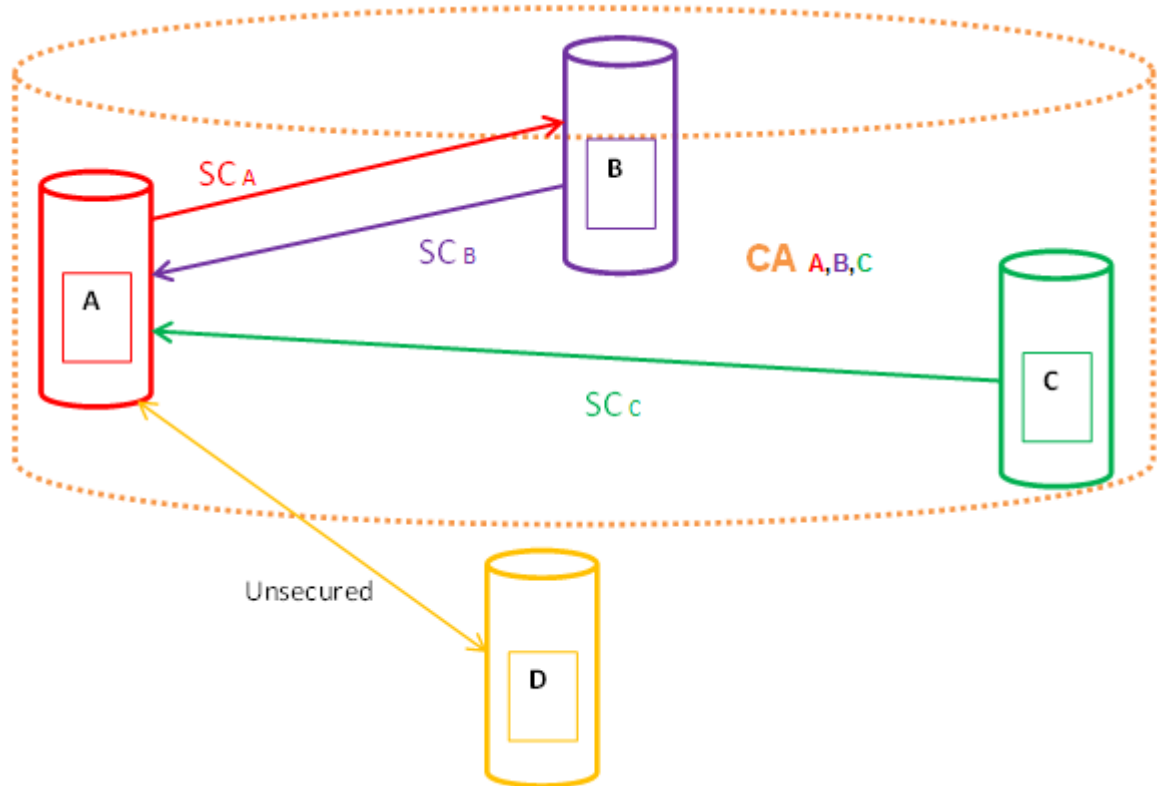

## MACsec operation

As shown in the following figure, a host that connects to Switch A sends an Ethernet frame to a host that connects to Switch B. Switch A encrypts the frame, excluding the Ethernet header and optionally the 802.1Q header. Switch A also appends MACsec information like SecTag and ICV to the encrypted payload and transmits the frame using normal frame transmission. This process ensures data confidentiality.

On receiving the frame, Switch B decrypts the frame. Switch B recalculates the ICV using a MACsec key and the SecTag present in the frame. If the ICV present in the received frame matches the recalculated ICV, the switch processes the frame. If the two ICVs do not match, the switch discards the frame. This process ensures data origin authenticity and data integrity. The encryption and decryption algorithms follow the AES-GCM-128 standard.

The MACsec key between switches A and B are statically pre-configured.

### \* Note:

MACsec will be operational between two switches across Point-to-Point Connectivity only when the switches are either directly connected or across a network cloud that provides P2P connectivity between the two switches.

For example, in the following figure you can enable MACsec between two switches across a network cloud where P2P connectivity between the switches is provided via services such as P2P, MPLS, Layer 2 VPN (ELINE), or connectivity across Dark Fiber. However, it is important to note that MACsec will not be operational between two switches across a network cloud if the intermediate routers/switches need to inspect the VLAN tag or IP header for service classification. This is because MACsec encrypts the entire data frame including the VLAN header and as such the intermediate switches/routers will not have visibility into the same to perform service classification.

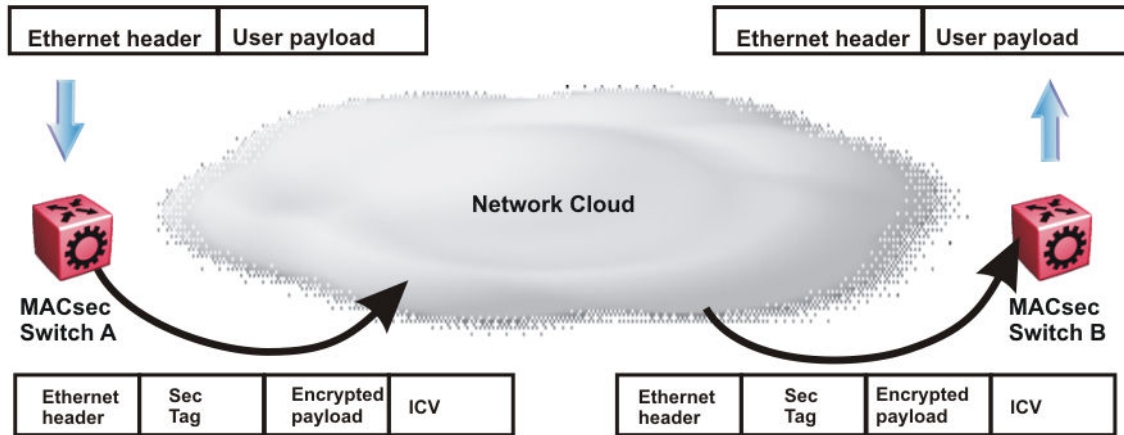

Figure 25: MACsec operation

## MACsec performance

To monitor MACsec performance, view the performance statistics. For information on the supported statistics, see *Monitoring Performance*.

## MACsec configuration using CLI

### Configuring a connectivity association

Use the following procedure to configure a connectivity association (CA) in static CAK security mode using the CLI.

#### Procedure

1. Enter Global Configuration mode:  

```
enable
```

```
configure terminal
```

## 2. Configure a CA:

```
macsec connectivity-association WORD<5-15> connectivity-association-
key WORD<10-32> [key-parity even|odd]
```

### \* Note:

If you do not specify a key-parity value, the CA is created in 2AN mode.

## 3. Enter GigabitEthernet Interface Configuration mode:

```
enable
```

```
configure terminal
```

```
interface GigabitEthernet {slot/port[/sub-port] [-slot/port[/sub-
port]][, ...]}
```

### \* Note:

If your platform supports channelization and the port is channelized, you must also specify the sub-port in the format slot/port/sub-port.

## 4. Associate a port with a CA:

```
macsec connectivity-association WORD<5-15>
```

## 5. Enable encryption on the port.

```
macsec encryption enable
```

## 6. Enable MACsec on the port:

```
macsec enable
```

## Example

Configure a connectivity association and enable MACsec on a port:

```
Switch:1>enable
Switch:1#configure terminal
Switch:1(config)#macsec connectivity-association caname1 connectivity-association-key
1029384756abcdef key-parity even
Switch:1(config)#interface gigabitethernet 1/2
Switch:1(config-if)#macsec connectivity-association caname1
Switch:1(config-if)#macsec encryption enable
Switch:1(config-if)#macsec enable
```

## Variable definitions

Use the data in the following table to use the `macsec` command.

| Variable                            | Value                                                                                     |
|-------------------------------------|-------------------------------------------------------------------------------------------|
| connectivity-association WORD<5-15> | Specifies a connectivity-association name. It is a 5 to 15 character alphanumeric string. |

*Table continues...*

| Variable                                         | Value                                                                                                                                                                                                                                                                                                                                |
|--------------------------------------------------|--------------------------------------------------------------------------------------------------------------------------------------------------------------------------------------------------------------------------------------------------------------------------------------------------------------------------------------|
| connectivity-association-key <i>WORD</i> <10–32> | Specifies the value of the connectivity-association key (CAK). A 32 character hexadecimal string is recommended.                                                                                                                                                                                                                     |
| key-parity even odd                              | Specifies Tx key parity using the following values: <ul style="list-style-type: none"> <li>• even — generates even-numbered keys for Tx</li> <li>• odd — generates odd-numbered keys for Tx</li> </ul> <p><b>* Note:</b><br/>If you do not specify a key-parity value, the connectivity association (CA) is created in 2AN mode.</p> |

Use the data in the following table to use the **interface gigabitethernet** command.

| Variable                                             | Value                                                                                                                                                                                                                                                                                                                                                                                                                            |
|------------------------------------------------------|----------------------------------------------------------------------------------------------------------------------------------------------------------------------------------------------------------------------------------------------------------------------------------------------------------------------------------------------------------------------------------------------------------------------------------|
| {slot/port[/sub-port][/-slot/port[/sub-port]][,...]} | Specifies the port that you want to associate with the CA.<br><br>Identifies the slot and port in one of the following formats: a single slot and port (slot/port), a range of slots and ports (slot/port-slot/port), or a series of slots and ports (slot/port,slot/port,slot/port). If your platform supports channelization and the port is channelized, you must also specify the sub-port in the format slot/port/sub-port. |

## Updating the connectivity association key (CAK)

Use the following procedure to update the connectivity association key (CAK).

### Procedure

1. Enter GigabitEthernet Interface Configuration mode:

```
enable
```

```
configure terminal
```

```
interface GigabitEthernet {slot/port[/sub-port][/-slot/port[/sub-port]][,...]}
```

**\* Note:**

If your platform supports channelization and the port is channelized, you must also specify the sub-port in the format slot/port/sub-port.

2. Disable MACsec on the port:

```
no macsec enable
```



### 3. Update the connectivity association key (CAK):

```
macsec connectivity-association WORD<5-15> connectivity-association
key WORD<10-32> {key-parity even|odd}
```

**\* Note:**

If you do not specify a key-parity value, the system defaults to 2AN mode.

### 4. Enable MACsec on the port:

```
macsec enable
```

## Example

Update the connectivity association key (CAK):

```
Switch:1>enable
Switch:1#configure terminal
Switch:1(config)#interface gigabit 1/2
Switch:1(config-if)#no macsec enable
Switch:1(config-if)#macsec connectivity-association caname1 connectivity-association-key
1029384756abcdef key-parity even
Switch:1(config-if)#macsec enable
```

## Variable definitions

Use the data in the following table to use the `macsec` command.

| Variable                                              | Value                                                                                                            |
|-------------------------------------------------------|------------------------------------------------------------------------------------------------------------------|
| connectivity-association <i>WORD&lt;5-15&gt;</i>      | Specifies a connectivity-association name. It is a 5 to 15 character alphanumeric string.                        |
| connectivity-association-key <i>WORD&lt;10-32&gt;</i> | Specifies the value of the connectivity-association key (CAK). A 32 character hexadecimal string is recommended. |

Use the data in the following table to use the `interface gigabitethernet` command.

| Variable                                             | Value                                                                                                                                                                                                                                                                                                                                                                                                                                                              |
|------------------------------------------------------|--------------------------------------------------------------------------------------------------------------------------------------------------------------------------------------------------------------------------------------------------------------------------------------------------------------------------------------------------------------------------------------------------------------------------------------------------------------------|
| {slot/port[/sub-port][/-slot/port[/sub-port]][,...]} | <p>Specifies the port that you want to associate with the connectivity association (CA).</p> <p>Identifies the slot and port in one of the following formats: a single slot and port (slot/port), a range of slots and ports (slot/port-slot/port), or a series of slots and ports (slot/port,slot/port,slot/port). If your platform supports channelization and the port is channelized, you must also specify the sub-port in the format slot/port/sub-port.</p> |

---

## Configuring MACsec encryption on a port

Use the following procedure to enable or disable encryption on a MACsec capable port. The default is disabled.

### About this task

If you disable encryption, MACsec forwards traffic in clear text. You can view that data that is not encrypted in the Ethernet frame that travels across the link. Even if you disable encryption the MACsec header applies to the frame and integrity checks make sure that traffic has not been tampered with.

### Procedure

1. Enter GigabitEthernet Interface Configuration mode:

```
enable

configure terminal

interface GigabitEthernet {slot/port[/sub-port] [-slot/port[/sub-
port]][,...]}
```

**\* Note:**

If your platform supports channelization and the port is channelized, you must also specify the sub-port in the format slot/port/sub-port.

2. Enable MACsec encryption on the port:

```
macsec encryption enable
```

3. Disable MACsec encryption on the port:

```
no macsec encryption enable
```

### Example

Configure MACsec encryption on a port:

```
Switch:1>enable
Switch:1#configure terminal
Switch:1(config)#interface gigabit 1/2
Switch:1(config-if)#macsec encryption enable
```

---

## Configuring the confidentiality offset on a port

Use the following procedure to configure the confidentiality offset on a port. The default is disabled.

### About this task

The confidentiality offset provides a way to start encryption after a few bytes following the Ethernet header. The confidentiality offset facilitates traffic flow inspection and classification on intermediate devices by not encrypting the Network Layer header for IPv4 or IPv6. For instance, if you configure

the offset to 30, the IPv4 header and the TCP/UDP header are not encrypted. If you configure the offset to 50, the IPv6 header and the TCP/UDP header are not encrypted.

## Procedure

1. Enter GigabitEthernet Interface Configuration mode:

```
enable

configure terminal

interface GigabitEthernet {slot/port[/sub-port] [-slot/port[/sub-
port]][,...]}
```

**\* Note:**

If your platform supports channelization and the port is channelized, you must also specify the sub-port in the format slot/port/sub-port.

2. Configure confidentiality offset on the port:

```
macsec confidentiality-offset <30-50>
```

3. Disable the confidentiality offset on the port:

```
no macsec confidentiality-offset
```

## Example

Configuring the confidentiality offset on the port:

```
Switch:1>enable
Switch:1#configure terminal
Switch:1(config)#interface gigabit 1/2
Switch:1(config-if)#macsec confidentiality-offset 30
```

## Variable definitions

Use the data in the following table to use the `macsec confidentiality-offset` command.

| Variable | Value                                                                                                        |
|----------|--------------------------------------------------------------------------------------------------------------|
| <30-50>  | Specifies the bytes after the Ethernet header from which data encryption begins. Valid values are 30 and 50. |

Use the data in the following table to use the `interface gigabitethernet` command.

| Variable                                             | Value                                                                                                                                                                                                                                                                                                                                                                     |
|------------------------------------------------------|---------------------------------------------------------------------------------------------------------------------------------------------------------------------------------------------------------------------------------------------------------------------------------------------------------------------------------------------------------------------------|
| {slot/port[/sub-port] [-slot/port[/sub-port]][,...]} | Specifies the port that you want to associate with the connectivity association (CA).<br><br>Identifies the slot and port in one of the following formats: a single slot and port (slot/port), a range of slots and ports (slot/port-slot/port), or a series of slots and ports (slot/port,slot/port,slot/port). If your platform supports channelization and the port is |

| Variable | Value                                                                             |
|----------|-----------------------------------------------------------------------------------|
|          | channelized, you must also specify the sub-port in the format slot/port/sub-port. |

## Viewing the MACsec connectivity association details

Perform this procedure to view the MACsec connectivity association (CA) details.

### Procedure

1. Enter Privileged EXEC mode:

```
enable
```

2. View the MACsec CA details:

```
show macsec connectivity-association [WORD<5-15>]
```

**\* Note:**

This command displays the MACsec CA details, including the MD5 hashed value of the CA key.

### Example

View the MACsec connectivity association details:

**\* Note:**

Slot and port information can differ depending on hardware platform. For more information about specific hardware, see your hardware documentation.

```
Switch:1>show macsec connectivity-association
=====
MACSEC Connectivity Associations Info
=====
Connectivity Connectivity AN_Mode / Port
Association Name Association Key Hash TxKeyParity Members

ca150 ba6b005bef79e7b95f3e08181e2501ce 2AN / NA 1/49
ca151 5b41f44ecaa54f3873e781557b39230b 4AN / odd 1/49
ca152 053f26fb96b011191f2da28849f08677 4AN / Even 1/50

Switch:1#show macsec statistics 1/50 secure-channel inbound
=====
MACSEC Port Inbound Secure Channel Statistics
=====
PortId UnusedSA NoUsingSA Late NotValid Invalid
Packets Packets Packets Packets Packets Packets

1/47 0 0 0 0 0

PortId Delayed Unchecked Ok Octets Octets
Packets Packets Packets Pkts Validated Decrypted

1/47 0 0 1796 0 169282
```

```
Switch:1#show macsec statistics 1/50 secure-channel outbound
```

```
=====
MACSEC Port Outbound Secure Channel Statistics
=====
```

| PortId | Protected<br>Packets | Encrypted<br>Packets | Octets<br>Protected | Octets<br>Encrypted |
|--------|----------------------|----------------------|---------------------|---------------------|
| 1/47   | 0                    | 2628                 | 0                   | 277182              |

## Viewing MACsec status

Perform this procedure to view MACsec status.

### About this task

This command displays the status for the following:

- MACsec status
- MACsec encryption status
- The associated Connectivity Association (CA) name

#### \* Note:

If you do not specify a port number, the information on all MACsec capable interfaces is displayed.

### Procedure

1. Enter Privileged EXEC mode:

```
enable
```

2. View the MACsec status:

```
show macsec status {slot/port[/sub-port][-slot/port[/sub-port]]
[,...]}
```

3. Display all MACsec related information:

```
show macsec
```

### Example

View the MACsec status:

#### \* Note:

Slot and port information can differ depending on hardware platform. For more information about specific hardware, see your hardware documentation.

The switch does not support replay protect.

```
Switch:1>enable
Switch:1#show macsec status
```

| MACSEC Port Status |               |                   |                |                      |                   |         |
|--------------------|---------------|-------------------|----------------|----------------------|-------------------|---------|
| PortId             | MACSEC Status | Encryption Status | Replay Protect | Replay Protect W'dow | Encryption Offset | CA Name |
| 1/39               | enabled       | enabled           | disabled       | --                   | ipv4Offset(30)    | ca333   |
| 1/40               | disabled      | disabled          | disabled       | --                   | none              | Nil     |

```
Switch:1#show macsec status 1/40
```

| MACSEC Port Status |               |                   |                |                      |                   |         |
|--------------------|---------------|-------------------|----------------|----------------------|-------------------|---------|
| PortId             | MACSEC Status | Encryption Status | Replay Protect | Replay Protect W'dow | Encryption Offset | CA Name |
| 1/40               | enabled       | enabled           | disabled       | --                   | ipv4Offset(30)    | ca333   |

Display all MACsec information:

```
Switch:1#show macsec
```

| MACSEC Connectivity Associations Info |                                   |                       |              |
|---------------------------------------|-----------------------------------|-----------------------|--------------|
| Connectivity Association Name         | Connectivity Association Key Hash | AN_Mode / TxKeyParity | Port Members |
| caname1                               | d4433e901bae92d0cc472706f66cfc18  | 4AN / odd             |              |

All 1 out of 1 Total Num of Macsec connectivity associates displayed

| MACSEC Port Status |               |                   |                |                      |                   |         |
|--------------------|---------------|-------------------|----------------|----------------------|-------------------|---------|
| PortId             | MACSEC Status | Encryption Status | Replay Protect | Replay Protect W'dow | Encryption Offset | CA Name |
| 1/1                | disabled      | disabled          | disabled       | --                   | none              | Nil     |
| 1/2                | disabled      | disabled          | disabled       | --                   | none              | Nil     |
| 1/3                | disabled      | disabled          | disabled       | --                   | none              | Nil     |
| 1/4                | disabled      | disabled          | disabled       | --                   | none              | Nil     |
| 1/5                | disabled      | disabled          | disabled       | --                   | none              | Nil     |
| 1/6                | disabled      | disabled          | disabled       | --                   | none              | Nil     |
| 1/7                | disabled      | disabled          | disabled       | --                   | none              | Nil     |
| 1/8                | disabled      | disabled          | disabled       | --                   | none              | Nil     |
| 1/9                | disabled      | disabled          | disabled       | --                   | none              | Nil     |
| 1/10               | disabled      | disabled          | disabled       | --                   | none              | Nil     |
| 1/11               | disabled      | disabled          | disabled       | --                   | none              | Nil     |

```
--More-- (q = quit)
```

## MACsec configuration using EDM

### Configuring connectivity associations

Use the following procedure to configure connectivity associations (CA) using EDM.

**\* Note:**

- You can configure MACsec on physical ports *only*. However, the physical ports can belong to an MLT trunk group that includes: Split MultiLink Trunking (SMLT), distributed MultiLink Trunking (DMLT), or Link aggregate group (LAG).
- MACsec encryption and decryption algorithms follow the AES-GCM-128 standard.

#### Procedure

1. In the navigation tree, expand the following folders: **Configuration > Edit**.
2. Click **Chassis**.
3. Click the **Macsec** tab.
4. Click **Insert**.
  - a. In the **AssociationName** field, type the connectivity-association name.
  - b. In the **AssociationKey** field, type the value of the connectivity-association key.

**\* Note:**

The connectivity-association key appears as an MD5-hashed text in the MAC security table.

- c. In the **AssociationTxKeyParity** box, select an option for Tx key parity.
  - d. Click **Insert** to save the configuration.
5. Click **Apply**.

### Macsec field descriptions

Use the data in the following table to use the Macsec tab.

| Name                   | Description                                                                  |
|------------------------|------------------------------------------------------------------------------|
| <b>AssociationName</b> | Specifies a name for each connectivity association configured on the device. |

*Table continues...*

| Name                          | Description                                                                                                                                                                                                                                                                                                                                                                                                                                                                                                                                                                                                                          |
|-------------------------------|--------------------------------------------------------------------------------------------------------------------------------------------------------------------------------------------------------------------------------------------------------------------------------------------------------------------------------------------------------------------------------------------------------------------------------------------------------------------------------------------------------------------------------------------------------------------------------------------------------------------------------------|
| <b>AssociationKey</b>         | Specifies a pre-shared, connectivity association key associated with each connectivity association configured on the device.                                                                                                                                                                                                                                                                                                                                                                                                                                                                                                         |
| <b>AssociationPortMembers</b> | Specifies the set of ports for which this connectivity association is associated.                                                                                                                                                                                                                                                                                                                                                                                                                                                                                                                                                    |
| <b>AssociationTxKeyParity</b> | <p>Specifies Tx key parity using the following values:</p> <ul style="list-style-type: none"> <li>• <b>None</b> — key parity is not specified</li> </ul> <p> <b>Note:</b></p> <p>The none value only applies to platforms that support 2AN mode. If you do not specify a key parity value, the system defaults to 2AN mode. For information about feature support, see <i>Release Notes</i>.</p> <ul style="list-style-type: none"> <li>• <b>Even</b> — generates even-numbered keys</li> <li>• <b>Odd</b> — generates odd-numbered keys</li> </ul> |

## Associating a port with a connectivity association

Use the following procedure to associate a port with a connectivity association (CA) using EDM.

For VSP 4000, you can associate connectivity associations to device ports 1/49 and 1/50 only.

 **Note:**

- You can configure MACsec on physical ports *only*. However, the physical ports can belong to an MLT trunk group that includes: Split MultiLink Trunking (SMLT), distributed MultiLink Trunking (DMLT), or Link aggregate group (LAG).
- MACsec encryption and decryption algorithms follow the AES-GCM-128 standard.

### Procedure

1. In the Device Physical View, click on the port that you want to associate with the connectivity association.
2. In the navigation tree, expand the following folders: **Configuration > Edit > Port**.
3. Click **General**.
4. Click the **Macsec** tab.
5. In the **CAName** field, type the connectivity-association name.
6. In the **OffsetValue** field, select the value of confidentiality offset to be achieved.
7. Select the **EncryptionEnable** checkbox to enable encryption for the frames transmitted on the port.
8. Select the **Macsec Enable** checkbox to enable MACsec on the port.



9. Click **Apply** to save the configuration.

## Macsec field descriptions

Use the data in the following table to configure the **Macsec** tab.

| Name                    | Description                                                                                                                                                                                                                                                                                                                                                                                                                                                                                                                                                                            |
|-------------------------|----------------------------------------------------------------------------------------------------------------------------------------------------------------------------------------------------------------------------------------------------------------------------------------------------------------------------------------------------------------------------------------------------------------------------------------------------------------------------------------------------------------------------------------------------------------------------------------|
| <b>CAName</b>           | Specifies the name of the connectivity association attached to the port or interface.                                                                                                                                                                                                                                                                                                                                                                                                                                                                                                  |
| <b>OffsetValue</b>      | <p>Offsets MACsec encryption in an IPv4 TCP/UDP header or IPv6 TCP/UDP header.</p> <p>The confidentiality offset provides a way to start encryption after a few bytes following the Ethernet header. The confidentiality offset facilitates traffic flow inspection and classification on intermediate devices by not encrypting the Network Layer header for IPv4 or IPv6. For instance, if you configure the offset to 30, the IPv4 header and the TCP/UDP header are not encrypted. If you configure the offset to 50, the IPv6 header and the TCP/UDP header is not encrypted.</p> |
| <b>EncryptionEnable</b> | <p>Specifies the encryption status per port.</p> <p>Use this field to enable or disable encryption for each MACsec capable port.</p>                                                                                                                                                                                                                                                                                                                                                                                                                                                   |
| <b>Macsec Enable</b>    | Enables or disables MACsec on the port.                                                                                                                                                                                                                                                                                                                                                                                                                                                                                                                                                |

# Chapter 8: RADIUS

The following sections describe Remote Access Dial-In User Services (RADIUS) and its configuration.

---

## RADIUS fundamentals

Remote Access Dial-In User Services (RADIUS) is a distributed client/server system that assists in securing networks against unauthorized access, allowing a number of communication servers and clients to authenticate users identity through a central database. The database within the RADIUS server stores information about clients, users, passwords, and access privileges including the use of shared secret.

RADIUS is a fully open and standard protocol, defined by two Requests for Comments (RFC) (Authentication: RFC2865, Accounting: RFC2866). You use RADIUS authentication to get secure access to the system (console/Telnet/SSH/EDM), and RADIUS accounting to track the management sessions (CLI only).

### RADIUS support for IPv6

RADIUS supports both IPv4 and IPv6 with no differences in functionality or configuration in all but the following case. When you add or update a RADIUS server in Enterprise Device Manager (EDM) you must specify if the address type is an IPv4 or an IPv6 address.

### How RADIUS works

A RADIUS application has two components:

- RADIUS server  
A computer equipped with server software (for example, a UNIX workstation) that is located at a central office or campus. The server has authentication and access information in a form that is compatible with the client. Typically, the database in the RADIUS server stores client information, user information, password, and access privileges, including the use of a shared secret. A network can have one server for both authentication and accounting, or one server for each service.
- RADIUS client  
A device, router, or a remote access server, equipped with client software, that typically resides on the same local area network (LAN) segment as the server. The client is the network access point between the remote users and the server.

The two RADIUS processes are

- RADIUS authentication—Identifies remote users before you give them access to a central network site.
- RADIUS accounting—Performs data collection on the server during a remote user's dial-in session with the client.

### Configuration of the RADIUS server and client

For more information about how to configure a RADIUS server, see the documentation that came with the server software.

The switch software supports BaySecure Access Control (BSAC) and the Merit Network servers. To use these servers, you must first obtain the software for the server you will use. Also, you must make changes to one or more configuration files for these servers.

### RADIUS authentication

You can use RADIUS authentication to use a remote server to authenticate logons. The RADIUS server also provides access authority. RADIUS assists network security and authorization by managing a database of users. The device uses this database to verify user names and passwords as well as information about the type of access priority available to the user.

When the RADIUS client sends an authentication request requesting additional information such as a SecurID number, it sends it as a challenge-response. Along with the challenge-response, it sends a reply-message attribute. The reply-message is a text string, such as `Please enter the next number on your SecurID card:`. The RFC defined maximum length of each reply-message attribute is 253 characters. If you have multiple instances of reply-message attributes that together form a large message that displays to the user, the maximum length is 2000 characters.

You can use additional user names to access the device, in addition to the six existing user names of `ro`, `L1`, `L2`, `L3`, `rw`, and `rwa`. The RADIUS server authenticates the user name and assigns one of the existing access priorities to that name. Unauthenticated user names are denied access to the device. You must add user names `ro`, `L1`, `L2`, `L3`, `rw`, and `rwa` to the RADIUS server if you enable authentication. Users not added to the server are denied access.

The following list shows the user configurable options of the RADIUS feature:

- Up to 10 RADIUS servers in each device for fault tolerance (each server is assigned a priority and is contacted in that order).
- A secret key for each server to authenticate the RADIUS client
- The server UDP port
- Maximum retries allowed
- Time-out period for each attempt

#### Note:

If you enable enhanced secure mode with the `boot config flags enhancedsecure-mode` command, you enable different access levels, along with stronger password complexity, length, and minimum change intervals. With enhanced secure mode enabled, the switch supports the following access levels for RADIUS authentication:

- Administrator
- Privilege

- Operator
- Auditor
- Security

The switch associates each username with a certain role and appropriate authorization rights to view and configure commands. For more information on system access fundamentals and configuration, see *Administering*.

### Use of RADIUS to modify user access to CLI commands

The switch provides CLI command access based on the configured access level of a user. However, you can use RADIUS to override CLI command access provided by the switch.

To override user access to CLI commands, you must configure the command-access-attribute on the switch and on the RADIUS server. (The switch uses decimal value 194 as the default for this parameter.) On the RADIUS server, you can then define the commands that the user can or cannot access.

#### Important:

When you enable RADIUS on the switch and configure a RADIUS server to be used by CLI or EDM, the server authenticates the connection, whether it is FTP, HTTPs, SSH, or TELNET. However, in the event that the RADIUS server is unresponsive or is unreachable, the switch falls back to the local authentication, so that you can access the switch using your local login credentials.

Regardless of the RADIUS server configuration, you must configure the user's access on the switch based on the six platform access levels.

### RADIUS accounting

RADIUS accounting logs all of the activity of each remote user in a session on the centralized RADIUS accounting server.

Session-IDs for each RADIUS account generate as 12-character strings. The first four characters in the string form a random number in hexadecimal format. The last eight characters in the string indicate the number of user sessions started since the last restart, in hexadecimal format.

The Network Address Server (NAS) IP address for a session is the address of the device interface to which the remote session is connected over the network. For a console session, modem session, and sessions running on debug ports, this value is set to 0.0.0.0, as is the case with RADIUS authentication.

The following table summarizes the events and associated accounting information logged at the RADIUS accounting server.

**Table 8: Accounting events and logged information**

| Event                              | Accounting information logged at server    |
|------------------------------------|--------------------------------------------|
| Accounting is turned on at router  | • Accounting on request: NAS IP address    |
| Accounting is turned off at router | • Accounting off request: NAS IP address   |
| User logs on                       | • Accounting start request: NAS IP address |

*Table continues...*

| Event                                  | Accounting information logged at server                                                                                                                                                                                                                                                                                                                                                |
|----------------------------------------|----------------------------------------------------------------------------------------------------------------------------------------------------------------------------------------------------------------------------------------------------------------------------------------------------------------------------------------------------------------------------------------|
|                                        | <ul style="list-style-type: none"> <li>• Session ID</li> <li>• User name</li> </ul>                                                                                                                                                                                                                                                                                                    |
| More than 40 CLI commands are executed | <ul style="list-style-type: none"> <li>• Accounting interim request: NAS IP address</li> <li>• Session ID</li> <li>• CLI commands</li> <li>• User name</li> </ul>                                                                                                                                                                                                                      |
| User logs off                          | <ul style="list-style-type: none"> <li>• Accounting stop request: NAS IP address</li> <li>• Session ID</li> <li>• Session duration</li> <li>• User name</li> <li>• Number of input octets for session</li> <li>• Number of octets output for session</li> <li>• Number of packets input for session</li> <li>• Number of packets output for session</li> <li>• CLI commands</li> </ul> |

When the device communicates with the RADIUS accounting server, the following actions occur:

1. If the server sends an invalid response, the response is silently discarded and the server does not make an attempt to resend the request.
2. User-specified number of attempts are made if the server does not respond within the user-configured timeout interval. If a server does not respond to any of the retries, requests are sent to the next priority server (if configured). You can configure up to 10 RADIUS servers for redundancy.

### **RFC 4675 RADIUS attributes: Egress VLAN**

Egress VLAN controls egress traffic. Egress VLAN supports two standard RADIUS attributes as defined in RFC 4675:

- Egress-VLANID
- Egress-VLAN-Name

RADIUS attributes control the 802.1Q tagging for traffic egressing a port where RADIUS authentication is performed for a connected EAP or NEAP client.

Egress VLANs are standard attributes, therefore the RADIUS server supports the attributes by default and offer the ability to configure the attributes. Each attribute has two parts:

1. Indicates if the frames on the VLAN egress must be tagged or untagged
2. Specifies the VLAN name or VLAN ID

The switch applies the VLAN received in the Egress-VLAN attributes to the port where the client is authenticated through RADIUS and then sets the tagging rules (tagged or untagged) accordingly.

The switch processes the Egress-VLAN attributes when decoding the RADIUS packet, therefore the switch adds the port to the VLANs first and then sets the proper tagging for the VLANs. You can create VLANs in advance on the switch.

In the MultiVlan operation mode, the EAP applies ingress hardware rules to ensure untagged traffic from each authenticated client goes into its own VLAN. The unauthenticated clients send traffic to the Guest VLAN which matches the PVID.

### **RADIUS server reachability**

Configure up to 10 EAP RADIUS servers on the switch to manage fault tolerance. Each server is assigned a priority and is contacted in the priority order. If the first server is unavailable, the switch tries the second server, and so on, until the switch establishes a successful connection. Higher priority means lower integer value.

RADIUS server reachability prevents clients from trying to establish a connection with non reachable servers. RADIUS server reachability runs a periodic check in the background to identify the available servers. The switch is aware of the first available EAP RADIUS server without going through each of the servers and wait for time-outs.

Use RADIUS server reachability to configure the switch to use dummy RADIUS requests to determine the reachability of the RADIUS server. The switch regularly performs the reachability test to determine if the switch should fail over to the secondary RADIUS server or activate the Fail Open VLAN, if configured on the switch. The switch regularly generates a dummy RADIUS request with the username *avaya* and password *avaya*. The switch interprets either Request Accept or Request Reject responses as a confirmation for server reachability, therefore it is not necessary to add the credentials on the server to test server reachability. Configure the Username and password for the dummy account through CLI.

#### **\* Note:**

The RADIUS server reachability is enabled on the switch and is not a configurable option.

Based on the number of EAP RADIUS servers configured, the switch performs the following:

- If the highest priority EAP RADIUS server is reachable, the server status is updated to reachable and further authentication will use this server. As long as the highest priority EAP RADIUS server is reachable, the rest of the EAP RADIUS servers are not tested for reachability.
- If the highest priority EAP RADIUS server is not reachable, then the switch tests the rest of the EAP RADIUS servers for reachability. The servers are checked one by one for reachability based on their priority from highest to lowest. The first server that is reachable is used for authentication and the rest of the lower priority EAP RADIUS servers if any, are skipped from the reachability test.
- If all the EAP RADIUS servers are unreachable, then no further authentication occurs until the next successful reachability check.

The intervals between two consecutive reachability checks can be configured. The default values are as follows:

- one minute, if the last check result was unreachable
- three minutes, if the last check result was reachable

A server is marked as unreachable after a number of retries and time-outs. The default number of retries is 1 and the default time-out value is 3 seconds, but you can also configure these values in CLI.

## RFC 3580 RADIUS attributes: IEEE 802.1X Remote Authentication Dial In User Service

RFC 3580 provides support for EAP and NEAP clients for the following RADIUS attributes:

- **Called-Station ID attribute:** For IEEE 802.1X authenticators, the Called-Station ID stores the bridge or access point MAC address in upper case ASCII format, with octet values separated by a hyphen (-). For example: 00-10-A4-23-19-C0.  
  
In IEEE 802.11, where the SSID is known, the SSID must be appended to the access point MAC address and separated from the MAC address with a colon (:). For example: 00-10-A4-23-19-C0:AP1.
- **Calling-Station ID:** For IEEE 802.1X authenticators, the Calling-Station ID is used to store the supplicant MAC address in upper case ASCII format, with octet values separated by a hyphen (-). For example: 00-10-A4-23-19-C0.
- **NAS-Port ID:** The NAS-Port ID is used to identify the IEEE 802.1X Authenticator port which authenticates the Supplicant. The NAS-Port-Id differs from the NAS-Port in that it is a string of variable length whereas the NAS-Port is a 4 octet value.

---

## RADIUS configuration using CLI

You can configure Remote Access Dial-In User Services (RADIUS) to secure networks against unauthorized access, and allow communication servers and clients to authenticate users identity through a central database.

The database within the RADIUS server stores client information, user information, password, and access privileges, including the use of shared secret.

RADIUS supports IPv4 and IPv6 addresses, with no difference in functionality or configuration using CLI.

RADIUS is a fully open and standard protocol, defined by RFCs (Authentication: RFC2865, accounting RFC2866). With the switch, you use RADIUS authentication to secure access to the device (console/Telnet/SSH), and RADIUS accounting to track the management sessions for Command Line Interface (CLI) only.

RADIUS authentication allows the remote server to authenticate logons. RADIUS accounting logs all of the activity of each remote user in a session on the centralized RADIUS accounting server.

---

## Configuring RADIUS attributes

Configure RADIUS to authenticate user identity through a central database.

### Procedure

1. Enter Global Configuration mode:

```
enable
```

## RADIUS

- ```
configure terminal
```
2. Configure RADIUS access priority:

```
radius access-priority-attribute <192-240>
```
 3. Configure RADIUS accounting:

```
radius accounting {attribute-value <192-240>|enable|include-cli-commands}
```
 4. Configure the RADIUS authentication info attribute value:

```
radius auth-info-attr-value <0-255>
```
 5. Clear RADIUS statistics:

```
radius clear-stat
```
 6. Configure the value of the CLI commands:

```
radius cli-commands-attribute <192-240>
```
 7. Configure the value of the command access attribute:

```
radius command-access-attribute <192-240>
```
 8. Configure the maximum number of servers allowed:

```
radius maxserver <1-10>
```
 9. Configure the multicast address attribute:

```
radius mcast-addr-attr-value <0-255>
```

Example

```
Switch:1>enable
```

```
Switch:1#configure terminal
```

Configure RADIUS access priority:

```
Switch:1(config)#radius access-priority-attribute 192
```

Configure RADIUS accounting to include CLI commands:

```
Switch:1(config)#radius accounting include-cli-commands
```

Variable definitions

Use the data in the following table to use the `radius` command.

Variable	Value
access-priority-attribute <192-240>	Specifies the value of the access priority attribute in the range of 192 to 240. The default is 192.
accounting {attribute-value <192-240> enable include-cli-commands}	Configures the accounting attribute value, enable accounting, or configure if accounting includes CLI commands. The default is

Table continues...

Variable	Value
	false. Use the no option to disable the accounting attribute value: no radius accounting enable .
auth-info-attr-value <0-255>	Specifies the value of the authentication information attribute in the range of 0 to 255. The default is 91.
clear-stat	Clears RADIUS statistics.
cli-cmd-count <1-40>	Specifies how many CLI commands, from 1 to 40, before the system sends a RADIUS accounting interim request. The default value is 40.
cli-commands-attribute <192-240>	Specifies the value of CLI commands attribute in the range of 192 to 240. The default is 195.
cli-profile	Enable RADIUS CLI profiling. CLI profiling grants or denies access to users being authenticated by way of the RADIUS server. You can add a set of CLI commands to the configuration on the RADIUS server, and you can specify the command-access more for these commands. The default is false.
command-access-attribute <192-240>	Specifies the value of the command access attribute in the range of 192 to 240. The default is 194.
enable	Enable RADIUS authentication globally on the switch.
maxserver <1-10>	Specific to RADIUS authentication, configures the maximum number of servers allowed for the device. The range is between 1 and 10. The default is 10.
mcast-addr-attr-value <0-255>	Specifies the value of the multicast address attribute in the range of 0 to 255. The default is 90.
server host WORD<0-46> key WORD<0-32> [used-by {cli snmp web} [acct-enable] [acct-port <1-65536>] [enable] [port <1-65536>] [priority <1-10>] [retry <0-6>] [source-ip WORD<0-46>] [timeout <1-60>]	<ul style="list-style-type: none"> • host WORD<0-46> Creates a host server. WORD<0-46> signifies an IP address. • key WORD<0-32> Specifies a secret key in the range of 0-32 characters. • used-by {cli snmp web} Specifies how the server functions. Configures the server for authentication for <ul style="list-style-type: none"> - cli - snmp - web • acct-enable Enables RADIUS accounting on this server. The system enables RADIUS accounting by default. • acct-port <1-65536> Specifies a UDP port of the RADIUS accounting server (1 to 65536). The default value is 1816. The UDP port value set for

Table continues...

Variable	Value
	<p>the client must match the UDP value set for the RADIUS server.</p> <ul style="list-style-type: none"> • enable Enables the server. The default is true. • port <1–65536> Specifies a UDP port of the RADIUS server. The default value is 1812. • priority <1–10> Specifies the priority value for this server. The default is 10. • retry <0–6> Specifies the maximum number of authentication retries. The default is 3. • source-ip <i>WORD</i><0–46> Specifies a configured IP address as the source address when transmitting RADIUS packets. <i>WORD</i><0–46> signifies an IP address. • timeout <1–60> Specifies the number of seconds before the authentication request times out. The default is 3.
sourceip-flag	<p>Enable the source IP so the switch uses a configured source IP address. If the outgoing interface on the switch fails, a different source IP address is used — requiring that you make configuration changes to define the new RADIUS client on the RADIUS server. To simplify RADIUS server configuration, you can configure the switch to use a Circuitless IP (CLIP) address as the source IP and NAS IP address when transmitting RADIUS packets. A CLIP is not associated with a physical interface and is always in an active and operational state. You can configure the switch with multiple CLIP interfaces.</p> <p>By default, the switch uses the IP address of the outgoing interface as the source IP, and the NAS Ip address for RADIUS packets that it transmits.</p>

Configuring RADIUS profile

Use RADIUS CLI profiling to grant or deny CLI command access to users being authenticated by way of the RADIUS server. You can add a set of CLI commands to the configuration file on the radius server, and you can specify the command-access mode for these commands. The default is false.

Procedure

1. Enter Global Configuration mode:

```
enable
configure terminal
```

2. Enable RADIUS CLI profiling:

```
radius cli-profile
```

Example

```
Switch:1> enable
Switch:1# configure terminal
Switch:1(config)# radius cli-profile
```

Enabling RADIUS authentication

About this task

Enable or disable RADIUS authentication globally on the device to allow further configuration to take place. Use the no option to disable RADIUS authentication globally. The default is false or disabled.

Procedure

1. Enter Global Configuration mode:

```
enable
configure terminal
```

2. Enable RADIUS authentication globally on the switch:

```
radius enable
```

Enabling the source IP flag for the RADIUS server

Before you begin

- To configure the CLIP as the source IP address, you must enable the global RADIUS sourceip-flag. You can then configure the source-ip address parameter while defining the RADIUS server on the switch. The source IP address must be a CLIP address, and that you can configure a different CLIP address for each RADIUS server.

! Important:

Use the source IP option only for the RADIUS servers connected to the in-band network.

About this task

By default, the switch uses the IP address of the outgoing interface as the source IP, and the NAS IP address for RADIUS packets that it transmits. Enable the source IP so the switch uses a

configured source IP address instead. Therefore, if the outgoing interface on the switch fails, a different source IP address is used—requiring that you make configuration changes to define the new RADIUS Client on the RADIUS server.

RADIUS supports IPv4 and IPv6 addresses, with no difference in functionality or configuration in CLI.

To simplify RADIUS Server configuration, you can configure the switch to use a Circuitless IP Address (CLIP) as the source IP and NAS IP address when transmitting RADIUS packets. A CLIP is not associated with a physical interface and is always in an active and operational state. You can configure the switch with multiple CLIP interfaces.

The default for `radius sourceip-flag` is false.

Procedure

1. Enter Global Configuration mode:

```
enable  
configure terminal
```
2. Enable the RADIUS packet source IP flag:

```
radius sourceip-flag
```

Enabling RADIUS accounting

Before you begin

- You must configure a RADIUS server before you can enable RADIUS accounting.

About this task

Enable Remote Access Dial-in User Services (RADIUS) accounting to log all of the activity of each remote user in a session on the centralized RADIUS accounting server.

Procedure

1. Enter Global Configuration mode:

```
enable  
configure terminal
```
2. Enable RADIUS accounting globally:

```
radius accounting enable
```
3. Include or exclude CLI commands in RADIUS accounting updates:

```
radius accounting include-cli-commands
```
4. Specify the integer value of the CLI commands attribute:

```
radius accounting attribute-value <192-240>
```

Example

```
Switch:1> enable
Switch:1# configure terminal
Switch:1(config)# radius accounting enable
Switch:1(config)# radius accounting include-cli-commands
```

Variable definitions

Use the data in the following table to use the **radius accounting** command.

Variable	Value
enable	Enable RADIUS globally.
include-cli-commands	Include CLI commands in RADIUS accounting updates.
attribute-value <192–240>	Specify the integer value of the CLI commands attribute.

Enabling RADIUS-SNMP accounting**Before you begin**

- You must configure a RADIUS server before you can enable RADIUS-SNMP accounting.

About this task

Enable Remote Access Dial-in User Services (RADIUS) Simple Network Managing Protocol (SNMP) accounting globally. Use SNMP to remotely collect management data. An SNMP agent is a software process that monitors the UDP port 161 for SNMP messages. Each SNMP message sent to the agent contains a list of management objects.

Procedure

1. Enter Global Configuration mode:

```
enable
configure terminal
```
2. Enable RADIUS Simple Network Management Protocol (SNMP) accounting globally:

```
radius-snmp acct-enable
```
3. Set a timer to send a stop accounting message for RADIUS Simple Network Management Protocol (SNMP):

```
radius-snmp abort-session-timer <30-65535>
```
4. Set the timer for re-authentication of the SNMP session:

```
radius-snmp re-auth-timer <30-65535>
```
5. Specify the user name for SNMP access:

```
radius-snmp user WORD <0-20>
```

Example

```
Switch:1> enable
Switch:1# configure terminal
Switch:1(config)# radius-snmp acct-enable
Switch:1(config)# radius-snmp abort-session-timer 30
```

Variable definitions

Use the data in the following table to use the `radius-snmp` command.

Table 9: Variable definitions

Variable	Value
acct-enable	Enables RADIUS accounting globally. You cannot enable RADIUS accounting before you configure a valid server. The system disables RADIUS accounting by default. The default is false. Use the <code>no</code> option to disable RADIUS accounting globally: <code>no radius-snmp acct-enable</code>
abort-session-timer <30–65535>	Set the timer, in seconds, to send a stop accounting message. The default is 180.
re-auth-timer <30–65535>	Sets timer for re-authentication of the SNMP session. The timer value ranges from 30 to 65535 seconds. The default is 180.
user <i>WORD</i> <0–20>	Specifies the user name for SNMP access. <i>WORD</i> <0–20> specifies the user name in a range of 0 to 20 characters. The default is <code>snmp_user</code> .

Configuring RADIUS accounting interim request**About this task**

Configure RADIUS accounting interim requests to create a log whenever a user executes more than the number of CLI commands you specify.

If the packet size equals or exceeds 1.8 KB, an interim request packet is sent even if the configured limit is not reached. Therefore, the trigger to send out the interim request is either the configured value or a packet size greater than, or equal to 1.8 KB, whichever happens first.

Procedure

1. Enter Global Configuration mode:

```
enable
configure terminal
```
2. Configure RADIUS accounting interim requests:

```
radius cli-cmd-count <1-40>
```
3. Include or exclude CLI commands in RADIUS accounting:

```
radius accounting include-cli-commands
```

! **Important:**

You must configure the **radius accounting include-cli-commands** command for accounting interim requests to function.

Example

```
Switch:1> enable
Switch:1# configure terminal
Switch:1(config)# radius cli-cmd-count 30
Switch:1(config)# radius accounting include-cli-commands
```

Variable definitions

Use the data in the following table to use the **radius cli-cmd-count** command.

Variable	Value
<1-40>	Specifies how many CLI commands, from 1 to 40, before the system sends a RADIUS accounting interim request. The default value is 40.

Configuring RADIUS authentication and RADIUS accounting attributes

About this task

Configure RADIUS authentication and RADIUS accounting attributes to determine the size of the packets received.

Procedure

1. Enter Global Configuration mode:

```
enable
configure terminal
```
2. Configure the RADIUS authentication attribute value:

```
radius command-access-attribute <192-240>
```
3. Configure the RADIUS accounting attribute value:

```
radius accounting attribute-value <192-240>
```

Example

```
Switch:1>enable
Switch:1#configure terminal
Switch:1(config)#radius command-access-attribute 192
```

```
Switch:1(config)#radius accounting attribute-value 192
```

Variable definitions

Use the data in the following table to use the **radius** command.

Variable	Value
access-priority-attribute <192-240>	Specifies the value of the access priority attribute in the range of 192 to 240. The default is 192.
accounting {attribute-value <192-240> enable include-cli-commands}	Configures the accounting attribute value, enable accounting, or configure if accounting includes CLI commands. The default is false. Use the no option to disable the accounting attribute value: no radius accounting enable .
auth-info-attr-value <0-255>	Specifies the value of the authentication information attribute in the range of 0 to 255. The default is 91.
clear-stat	Clears RADIUS statistics.
cli-cmd-count <1-40>	Specifies how many CLI commands, from 1 to 40, before the system sends a RADIUS accounting interim request. The default value is 40.
cli-commands-attribute <192-240>	Specifies the value of CLI commands attribute in the range of 192 to 240. The default is 195.
cli-profile	Enable RADIUS CLI profiling. CLI profiling grants or denies access to users being authenticated by way of the RADIUS server. You can add a set of CLI commands to the configuration on the RADIUS server, and you can specify the command-access more for these commands. The default is false.
command-access-attribute <192-240>	Specifies the value of the command access attribute in the range of 192 to 240. The default is 194.
enable	Enable RADIUS authentication globally on the switch.
maxserver <1-10>	Specific to RADIUS authentication, configures the maximum number of servers allowed for the device. The range is between 1 and 10. The default is 10.
mcast-addr-attr-value <0-255>	Specifies the value of the multicast address attribute in the range of 0 to 255. The default is 90.
server host WORD<0-46> key WORD<0-32> [used-by {cli snmp web} [acct-enable] [acct-port <1-65536>] [enable] [port <1-65536>] [priority <1-10>] [retry <0-6>] [source-ip WORD<0-46>] [timeout <1-60>]	<ul style="list-style-type: none"> • host WORD<0-46> Creates a host server. WORD<0-46> signifies an IP address. • key WORD<0-32> Specifies a secret key in the range of 0-32 characters. • used-by {cli snmp web} Specifies how the server functions. Configures the server for authentication for <ul style="list-style-type: none"> - cli - snmp

Table continues...

Variable	Value
	<ul style="list-style-type: none"> - web • acct-enable Enables RADIUS accounting on this server. The system enables RADIUS accounting by default. • acct-port <1–65536> Specifies a UDP port of the RADIUS accounting server (1 to 65536). The default value is 1816. The UDP port value set for the client must match the UDP value set for the RADIUS server. • enable Enables the server. The default is true. • port <1–65536> Specifies a UDP port of the RADIUS server. The default value is 1812. • priority <1–10> Specifies the priority value for this server. The default is 10. • retry <0–6> Specifies the maximum number of authentication retries. The default is 3. • source-ip <i>WORD</i><0–46> Specifies a configured IP address as the source address when transmitting RADIUS packets. <i>WORD</i><0–46> signifies an IP address. • timeout <1–60> Specifies the number of seconds before the authentication request times out. The default is 3.
sourceip-flag	<p>Enable the source IP so the switch uses a configured source IP address. If the outgoing interface on the switch fails, a different source IP address is used — requiring that you make configuration changes to define the new RADIUS client on the RADIUS server. To simplify RADIUS server configuration, you can configure the switch to use a Circuitless IP (CLIP) address as the source IP and NAS IP address when transmitting RADIUS packets. A CLIP is not associated with a physical interface and is always in an active and operational state. You can configure the switch with multiple CLIP interfaces.</p> <p>By default, the switch uses the IP address of the outgoing interface as the source IP, and the NAS Ip address for RADIUS packets that it transmits.</p>

Adding a RADIUS server

About this task

Add a RADIUS server to allow RADIUS service on the switch.

RADIUS supports IPv4 and IPv6 addresses, with no difference in functionality or configuration using CLI.

Procedure

1. Enter Global Configuration mode:

```
enable
configure terminal
```

2. Add a RADIUS server:

```
radius server host WORD <0-46> key WORD<0-32> [used-by {cli|snmp|
web}] [acct-enable][acct-port <1-65536>] [enable] [port <1-65536>]
[priority <1-10>][retry <0-6>] [source-ip WORD <0-46>] [timeout
<1-60>]
```

Example

```
Switch:1>enable
```

```
Switch:1#configure terminal
```

Add a RADIUS server:

```
Switch:1(config)#radius server host
4717:0000:0000:0000:0000:0000:7933:0001 key testkey1 used-by snmp port 12
retry 5 timeout 10 enable
```

Variable definitions

Use the data in the following table to use the **radius server** command.

Variable	Value
host WORD <0-46>	Creates a host server. WORD <0-46> signifies an IPv4 address in the format A.B.C.D or an IPv6 address in the format x:x:x:x:x:x:x. RADIUS supports IPv4 and IPv6 addresses, with no difference in functionality or configuration using CLI.
key WORD<0-32>	Specifies a secret key in the range of 0-32 characters.
used-by {cli snmp web}	Specifies how the server functions <ul style="list-style-type: none"> • cli—configure the server for CLI authentication. • snmp—configure the server for SNMP authentication.

Table continues...

Variable	Value
	<ul style="list-style-type: none"> • web—configure the server for http(s) authentication <p>Use the no option to remove a host server: no radius server host WORD<0-46> used-by {cli snmp web}. The default is cli. The default command is: default radius server host WORD<0-46> used-by {cli snmp web}</p>
acct-enable	Enables RADIUS accounting on this server. The system enables RADIUS accounting by default.
acct-port <1-65536>	Specifies a UDP port of the RADIUS accounting server (1 to 65536). The default value is 1816. ! Important: The UDP port value set for the client must match the UDP value set for the RADIUS server.
enable	Enables this server. The default is true.
port <1-65536>	Specifies a UDP port of the RADIUS server. The default value is 1812.
priority <1-10>	Specifies the priority value for this server. The default is 10.
retry <0-6>	Specifies the maximum number of authentication retries. The default is 3.
source-ip WORD <0-46>	Specifies a configured IP address as the source address when transmitting RADIUS packets. WORD <0-46> signifies an IPv4 address in the format A.B.C.D or an IPv6 address in the format x:x:x:x:x:x.x. RADIUS supports IPv4 and IPv6 addresses, with no difference in functionality or configuration using CLI.
timeout <1-60>	Specifies the number of seconds before the authentication request times out. The default is 3.

Modifying RADIUS server settings

About this task

Change a specified RADIUS server value without having to delete the server and recreate it again.

RADIUS supports IPv4 and IPv6 addresses, with no difference in functionality or configuration using CLI.

Procedure

1. Enter Global Configuration mode:

```
enable
```

RADIUS

```
configure terminal
```

2. Modify a RADIUS server:

```
radius server host WORD <0-46> [used-by {cli|eapol|snmp|web}] [key  
WORD<0-20>] [port 1-65536] [priority <1-10>] [retry <0-6>] [timeout  
<1-20>] [enable] [acct-port <1-65536>] [acct-enable] [source-ip WORD  
<0-46>]
```

Example

```
Switch:1>enable
```

```
Switch:1#configure terminal
```

Modify a RADIUS server:

```
Switch:1(config)#radius server host  
4717:0000:0000:0000:0000:0000:7933:0001 used-by snmp port 12 retry 5  
timeout 10 enable
```

Variable definitions

Use the data in the following table to use the **radius server host** command.

Variable	Value
used-by {cli eapol snmp web}	<p>Specifies how the server functions</p> <ul style="list-style-type: none">• cli—configure the server for CLI authentication.• eapol—configure the server for EAPoL authentication.• snmp—configure the server for SNMP authentication.• web—configure the server for Web authentication. <p>Use the no option to remove a host server: no radius server host WORD<0-46> used-by {cli snmp web}. The default is cli. The default command is: default radius server host WORD<0-46> used-by {cli snmp web}.</p>
host WORD <0-46>	<p>Configures a host server. WORD <0-46> signifies an IPv4 address in the format A.B.C.D or an IPv6 address in the format x:x:x:x:x:x. RADIUS supports IPv4 and IPv6 addresses, with no difference in functionality or configuration using CLI.</p>
acct-enable	<p>Enables RADIUS accounting on this server. The system enables RADIUS accounting by default.</p>
acct-port <1-65536>	<p>Configures the UDP port of the RADIUS accounting server (1 to 65536). The default value is 1813.</p> <p> Important:</p> <p>The UDP port value set for the client must match the UDP value set for the RADIUS server.</p>
enable	<p>Enables the RADIUS server. The default is true.</p>

Table continues...

Variable	Value
key <i>WORD</i> <0–20>	Configures the secret key of the authentication client.
port <1–65536>	Configures the UDP port of the RADIUS authentication server (1 to 65536). The default value is 1812.
priority <1–10>	Configures the priority value for this server (1 to 10). The default is 10.
retry <0–6>	Configures the number of authentication retries the server will accept (0 to 6). The default is 3.
source-ip <i>WORD</i> <0–46>	Specifies a configured IP address as the source address when transmitting RADIUS packets. To use this option, you must have the global RADIUS sourceip-flag set to true. RADIUS supports IPv4 and IPv6 addresses, with no difference in functionality or configuration using CLI.
timeout <1–20>	Configures the number of seconds before the authentication request times out (1 to 20). The default is 3.

Showing RADIUS information

Display the global status of RADIUS information to ensure you configured the RADIUS feature according to the needs of the network.

Procedure

1. Log on to the switch to enter User EXEC mode.
2. Display the global status of RADIUS information:

```
show radius
```

Example

```
Switch:1>show radius
  acct-attribute-value : 193
    acct-enable       : false
  acct-include-cli-commands : false
  access-priority-attribute : 192
    auth-info-attr-value : 91
  command-access-attribute : 194
  cli-commands-attribute : 195
    cli-cmd-count      : 40
  cli-profile-enable : false
    enable             : false
  igap-passwd-attr : standard
  igap-timeout-log-fsize : 512
    maxserver         : 10
  mcast-addr-attr-value : 90
    sourceip-flag     : false
  supported-vendor-ids : 1584, 562
```

Displaying RADIUS server information

If your system is configured with a RADIUS server you can display the RADIUS server information.

Procedure

1. Log on to the switch to enter User EXEC mode.
2. To display the RADIUS server information enter the following command:

```
show radius-server
```

* Note:

If no RADIUS server is configured, the system displays the following message:

```
no RADIUS server configured
```

Example

```
Switch:1>show radius-server
```

```
=====
                        Radius Server Entries
=====
```

Name	USED	SECRET	PORT	PRIO	RETRY	TIME	EN-	ACCT	EN-	SOURE
	BY					OUT	ABLED	PORT	ABLED	IP
1.1.1.1	cli	*****	1812	10	1	3	true	1813	true	0.0.0.0
1000:0:0:0:0:0:1	cli	*****	1812	10	1	3	true	1813	true	0:0:0:0:0:0:0
10.10.10.10	cli	*****	1812	10	1	3	true	1813	true	0.0.0.0
4000:0:0:0:0:0:1	cli	*****	1812	10	1	3	true	1813	true	0:0:0:0:0:0:0

Configuring RADIUS server reachability

About this task

Use this procedure to configure the RADIUS server reachability settings.

Procedure

1. Enter Global Configuration mode:

```
enable
```

```
configure terminal
```
2. Set the RADIUS request username and password:

```
radius reachability username WORD<1-16> password WORD<1-16>
```
3. Set the interval between checks when RADIUS server is reachable:

```
radius reachability keep-alive-timer <30-600>
```
4. Set the interval between checks when RADIUS server is unreachable:

```
radius reachability unreachable-timer <30-600>
```

Example

Configure the RADIUS server reachability settings:

```
Switch:1>enable
Switch:1#configure terminal
Enter configuration commands, one per line. End with CNTL/Z.
```

Set the RADIUS request username and password:

```
Switch:1(config)#radius reachability username avaya password avaya
```

Set the interval between checks when RADIUS server is reachable:

```
Switch:1(config)#radius reachability keep-alive-timer 30
```

Set the interval between checks when RADIUS server is unreachable:

```
Switch:1(config)#radius reachability unreachable-timer 30
```

Variable definitions

Use the data in the following table to use the **radius reachability** command.

Variable	Value
keep-alive-timer <30-600>	Specifies, in seconds, the interval between checks when radius server is reachable. The default is 180 seconds.
unreachable-timer <30-600>	Specifies, in seconds, the interval between checks when radius server is unreachable. The default is 60 seconds.
username <i>WORD</i> <1-16>	Configures the RADIUS request username. The default is avaya.
password <i>WORD</i> <1-16>	Configures the RADIUS request password. The default is avaya.

Displaying RADIUS server reachability

About this task

Use this procedure to display the RADIUS server reachability settings.

Procedure

1. Log on to the switch to enter User EXEC mode.
2. Display the RADIUS server reachability settings:

```
show radius reachability
```

Example

Display the RADIUS server reachability settings.

```
Switch:1#show radius reachability
Radius reachability status : reachable
```

```

Radius reachable server : 192.0.2.1
  Time until next check : In progress
    Radius username : avaya
    Radius password : avaya
  Radius keep-alive-timer : 180
  Radius unreachable-timer : 60

```

Showing RADIUS SNMP configurations

Display current RADIUS SNMP configurations.

Procedure

1. Log on to the switch to enter User EXEC mode.
2. Display the current RADIUS server SNMP configurations:

```
show radius snmp
```

Example

```

Switch:1>show radius snmp
      abort-session-timer : 180
      acct-enable : false
      user : snmp_user
      enable : false
      re-auth-timer : 180

```

RADIUS configuration using Enterprise Device Manager

You can configure Remote Access Dial-In User Services (RADIUS) to assist in securing networks against unauthorized access, and allow communication servers and clients to authenticate the identity of users through a central database.

The database within the RADIUS server stores client information, user information, password, and access privileges, including the use of shared secret.

RADIUS supports IPv4 and IPv6 addresses with no difference in functionality or configuration in all but the following case. When adding a RADIUS server in Enterprise Device Manager (EDM) or modifying a RADIUS configuration in EDM, you must specify if the address type is an IPv4 or an IPv6 address.

RADIUS is a fully open and standard protocol, defined by RFCs (Authentication: RFC2865, accounting RFC2866). With the switch, you use RADIUS authentication to secure access to the device (console/Telnet/SSH), and RADIUS accounting to track the management sessions for Command Line Interface (CLI) only.

RADIUS authentication allows the remote server to authenticate logons. RADIUS accounting logs all of the activity of each remote user in a session on the centralized RADIUS accounting server.

Enabling RADIUS authentication

About this task

Enable RADIUS authentication globally to allow all features and functions of RADIUS to operate with the RADIUS server.

Procedure

1. In the navigation tree, open the following folders: **Configuration > Security > Control Path**.
2. Click **RADIUS**.
3. In the **RADIUS Global** tab, select the **Enable** check box.
4. In the **MaxNumberServer** field, type a value for the maximum number of servers.
5. In the **AccessPriorityAttrValue** field, type an access policy value (by default, this value is 192).
6. Configure the rest of the parameters in the RADIUS global tab.
7. Click **Apply**.

RADIUS Global field descriptions

Use the data in the following table to use the **RADIUS Global** tab.

Name	Description
Enable	Enables the RADIUS authentication feature globally.
MaxNumberServer	Specifies the maximum number of servers to be used, between 1 and 10, inclusive.
AccessPriorityAttrValue	Specific to RADIUS authentication. Specifies the vendor-specific attribute value of the access-priority attribute to match the type value set in the dictionary file on the RADIUS server. The valid values are 192 through 240. The default is 192.
AcctEnable	Enables RADIUS accounting.
AcctAttriValue	Specific to RADIUS accounting. Specifies the vendor-specific attribute value of the CLI-command attribute to match the type value set in the dictionary file on the RADIUS server. This value must be different from the access-priority attribute value configured for authentication. The valid values are 192 through 240. The default value is 193.
AcctIncludeCli	Specifies whether you want CLI commands included in RADIUS accounting requests.
ClearStat	Clears RADIUS statistics from the device.
McastAttributeValue	Specifies the value of the Mcast attribute. The valid values are 0 through 255. The default value is 90.

Table continues...

Name	Description
AuthInfoAttrValue	Specifies the value of the authentication information attribute. The valid values are 0 through 255. The default value is 91.
CommandAccessAttrValue	Specifies the value of the command access attribute. The valid values are 192 through 240. The default value is 194.
CliCommandAttrValue	Specifies the value of the CLI command attribute. The valid values are 192 through 240. The default value is 195.
AuthInvalidServerAddress	Displays the number of access responses from unknown or invalid RADIUS servers.
SourceIpFlag	Includes a configured IP address as the source address in RADIUS packets. The default is false. RADIUS supports IPv4 and IPv6 addresses with no difference in functionality or configuration.
CliCmdCount	Gives the value for the CLI command count. Specify an integer from 1 to 40. The default is 40.
CliProfEnable	Enables RADIUS CLI profiling.
SupportedVendorIds	Shows the vendor IDs that the software supports for RADIUS.
UserName	Specifies the username for RADIUS server reachability. The default is avaya.
Password	Specifies the password for RADIUS server reachability. The default is avaya.
Confirm Password	Confirms the password for RADIUS server reachability.
Unreachable Timer	Specifies, in seconds, the interval between checks when radius server is unreachable. The default is 60 seconds.
Keep Alive Timer	Specifies, in seconds, the interval between checks when radius server is reachable. The default is 180 seconds.

Enabling RADIUS accounting

Before you begin

- You must set up a RADIUS server and add it to the configuration file of the device before you can enable RADIUS accounting on the device. Otherwise, the system displays an error message.

About this task

Enable RADIUS accounting to log all of the activity of each remote user in a session on the centralized RADIUS accounting server.

Procedure

- In the navigation tree, open the following folders: **Configuration** > **Security** > **Control Path**.
- Click **RADIUS**.
- In the **RADIUS Global** tab, select the **AcctEnable** check box.

4. In the **AcctAttrValue** field, type an access policy value (by default, this value is 193).
5. Click **Apply**.

RADIUS Global field descriptions

Use the data in the following table to use the **RADIUS Global** tab.

Name	Description
Enable	Enables the RADIUS authentication feature globally.
MaxNumberServer	Specifies the maximum number of servers to be used, between 1 and 10, inclusive.
AccessPriorityAttrValue	Specific to RADIUS authentication. Specifies the vendor-specific attribute value of the access-priority attribute to match the type value set in the dictionary file on the RADIUS server. The valid values are 192 through 240. The default is 192.
AcctEnable	Enables RADIUS accounting.
AcctAttrValue	Specific to RADIUS accounting. Specifies the vendor-specific attribute value of the CLI-command attribute to match the type value set in the dictionary file on the RADIUS server. This value must be different from the access-priority attribute value configured for authentication. The valid values are 192 through 240. The default value is 193.
AcctIncludeCli	Specifies whether you want CLI commands included in RADIUS accounting requests.
ClearStat	Clears RADIUS statistics from the device.
McastAttributeValue	Specifies the value of the Mcast attribute. The valid values are 0 through 255. The default value is 90.
AuthInfoAttrValue	Specifies the value of the authentication information attribute. The valid values are 0 through 255. The default value is 91.
CommandAccessAttrValue	Specifies the value of the command access attribute. The valid values are 192 through 240. The default value is 194.
CliCommandAttrValue	Specifies the value of the CLI command attribute. The valid values are 192 through 240. The default value is 195.
AuthInvalidServerAddress	Displays the number of access responses from unknown or invalid RADIUS servers.
SourcelpFlag	Includes a configured IP address as the source address in RADIUS packets. The default is false. RADIUS supports IPv4 and IPv6 addresses with no difference in functionality or configuration.
CliCmdCount	Gives the value for the CLI command count. Specify an integer from 1 to 40. The default is 40.
CliProfEnable	Enables RADIUS CLI profiling.
SupportedVendorIds	Shows the vendor IDs that the software supports for RADIUS.

Table continues...

Name	Description
UserName	Specifies the username for RADIUS server reachability. The default is avaya.
Password	Specifies the password for RADIUS server reachability. The default is avaya.
Confirm Password	Confirms the password for RADIUS server reachability.
Unreachable Timer	Specifies, in seconds, the interval between checks when radius server is unreachable. The default is 60 seconds.
Keep Alive Timer	Specifies, in seconds, the interval between checks when radius server is reachable. The default is 180 seconds.

Disabling RADIUS accounting

Before you begin

- You cannot globally disable RADIUS accounting unless a server entry exists.

About this task

Disabling RADIUS accounting removes the accounting function from the RADIUS server.

Procedure

1. In the navigation tree, open the following folders: **Configuration > Security > Control Path**.
2. Click **RADIUS**.
3. In the **RADIUS Global** tab, disable RADIUS accounting by clearing the **AcctEnable** check box.
4. Click **Apply**.

Enabling RADIUS accounting interim request

About this task

Enable the RADIUS accounting interim request feature to create a log whenever more than the specified number of CLI commands are executed.

Procedure

1. In the navigation tree, open the following folders: **Configuration > Security > Control Path**.
2. Click **RADIUS**.
3. In the **RADIUS Global** tab, type the number of CLI commands in the **CliCmdCount** field.
4. Click **Apply**.

RADIUS Global field descriptions

Use the data in the following table to use the **RADIUS Global** tab.

Name	Description
Enable	Enables the RADIUS authentication feature globally.
MaxNumberServer	Specifies the maximum number of servers to be used, between 1 and 10, inclusive.
AccessPriorityAttrValue	Specific to RADIUS authentication. Specifies the vendor-specific attribute value of the access-priority attribute to match the type value set in the dictionary file on the RADIUS server. The valid values are 192 through 240. The default is 192.
AcctEnable	Enables RADIUS accounting.
AcctAttriValue	Specific to RADIUS accounting. Specifies the vendor-specific attribute value of the CLI-command attribute to match the type value set in the dictionary file on the RADIUS server. This value must be different from the access-priority attribute value configured for authentication. The valid values are 192 through 240. The default value is 193.
AcctIncludeCli	Specifies whether you want CLI commands included in RADIUS accounting requests.
ClearStat	Clears RADIUS statistics from the device.
McastAttributeValue	Specifies the value of the Mcast attribute. The valid values are 0 through 255. The default value is 90.
AuthInfoAttrValue	Specifies the value of the authentication information attribute. The valid values are 0 through 255. The default value is 91.
CommandAccessAttrValue	Specifies the value of the command access attribute. The valid values are 192 through 240. The default value is 194.
CliCommandAttrValue	Specifies the value of the CLI command attribute. The valid values are 192 through 240. The default value is 195.
AuthInvalidServerAddress	Displays the number of access responses from unknown or invalid RADIUS servers.
SourceIpFlag	Includes a configured IP address as the source address in RADIUS packets. The default is false. RADIUS supports IPv4 and IPv6 addresses with no difference in functionality or configuration.
CliCmdCount	Gives the value for the CLI command count. Specify an integer from 1 to 40. The default is 40.
CliProfEnable	Enables RADIUS CLI profiling.
SupportedVendorIds	Shows the vendor IDs that the software supports for RADIUS.
UserName	Specifies the username for RADIUS server reachability. The default is avaya.
Password	Specifies the password for RADIUS server reachability. The default is avaya.

Table continues...

Name	Description
Confirm Password	Confirms the password for RADIUS server reachability.
Unreachable Timer	Specifies, in seconds, the interval between checks when radius server is unreachable. The default is 60 seconds.
Keep Alive Timer	Specifies, in seconds, the interval between checks when radius server is reachable. The default is 180 seconds.

Configuring the source IP option for the RADIUS server

Before you begin

- To configure the CLIP as the source IP address, you must configure the global RADIUS **sourceip-flag** parameter as true. You can configure the **source-ip** address parameter while you define the RADIUS Server on the switch. The source IP address must be a CLIP address, and you can configure a different CLIP address for each RADIUS server. For more information about configuring the source IP address, see [Adding a RADIUS server](#) on page 328.

Important:

Use the source IP option only for the RADIUS servers connected to the in-band network.

About this task

By default, the switch uses the IP address of the outgoing interface as the source IP and NAS IP address for RADIUS packets that it transmits. When you configure the RADIUS server, this IP address is used when defining the RADIUS Clients that communicate with it. Therefore, if the outgoing interface on the switch fails, a different source IP address is used—requiring that you make configuration changes to define the new RADIUS client on the RADIUS server.

To simplify RADIUS Server configuration, you can configure the switch to use a Circuitless IP Address (CLIP) as the source IP and NAS IP address when transmitting RADIUS packets. A CLIP is not associated with a physical interface and is always in an active and operational state. You can configure the switch with multiple CLIP interfaces.

RADIUS supports IPv4 and IPv6 addresses with no difference in functionality or configuration in all but the following case. When adding a RADIUS server in Enterprise Device Manager (EDM) or modifying a RADIUS configuration in EDM, you must specify if the address type is an IPv4 or an IPv6 address.

Procedure

- In the navigation tree, open the following folders: **Configuration > Security > Control Path**.
- Click **RADIUS**.
- In the **RADIUS Global** tab, select the **SourceIpFlag** check box.
- Click **Apply**.

RADIUS Global field descriptions

Use the data in the following table to use the **RADIUS Global** tab.

Name	Description
Enable	Enables the RADIUS authentication feature globally.
MaxNumberServer	Specifies the maximum number of servers to be used, between 1 and 10, inclusive.
AccessPriorityAttrValue	Specific to RADIUS authentication. Specifies the vendor-specific attribute value of the access-priority attribute to match the type value set in the dictionary file on the RADIUS server. The valid values are 192 through 240. The default is 192.
AcctEnable	Enables RADIUS accounting.
AcctAttriValue	Specific to RADIUS accounting. Specifies the vendor-specific attribute value of the CLI-command attribute to match the type value set in the dictionary file on the RADIUS server. This value must be different from the access-priority attribute value configured for authentication. The valid values are 192 through 240. The default value is 193.
AcctIncludeCli	Specifies whether you want CLI commands included in RADIUS accounting requests.
ClearStat	Clears RADIUS statistics from the device.
McastAttributeValue	Specifies the value of the Mcast attribute. The valid values are 0 through 255. The default value is 90.
AuthInfoAttrValue	Specifies the value of the authentication information attribute. The valid values are 0 through 255. The default value is 91.
CommandAccessAttrValue	Specifies the value of the command access attribute. The valid values are 192 through 240. The default value is 194.
CliCommandAttrValue	Specifies the value of the CLI command attribute. The valid values are 192 through 240. The default value is 195.
AuthInvalidServerAddress	Displays the number of access responses from unknown or invalid RADIUS servers.
SourceIpFlag	Includes a configured IP address as the source address in RADIUS packets. The default is false. RADIUS supports IPv4 and IPv6 addresses with no difference in functionality or configuration.
CliCmdCount	Gives the value for the CLI command count. Specify an integer from 1 to 40. The default is 40.
CliProfEnable	Enables RADIUS CLI profiling.
SupportedVendorIds	Shows the vendor IDs that the software supports for RADIUS.
UserName	Specifies the username for RADIUS server reachability. The default is avaya.
Password	Specifies the password for RADIUS server reachability. The default is avaya.
Confirm Password	Confirms the password for RADIUS server reachability.
Unreachable Timer	Specifies, in seconds, the interval between checks when radius server is unreachable. The default is 60 seconds.

Table continues...

Name	Description
Keep Alive Timer	Specifies, in seconds, the interval between checks when radius server is reachable. The default is 180 seconds.

Adding a RADIUS server

About this task

Add a RADIUS server to allow RADIUS service on the switch.

Remote Dial-In User Services (RADIUS) supports both IPv4 and IPv6 addresses, with no differences in functionality or configuration in all but the following case. When adding a RADIUS server or updating a RADIUS server in Enterprise Device Manager (EDM) you must specify if the address type is an IPv4 or an IPv6 address.

Procedure

1. In the navigation tree, open the following folders: **Configuration > Security > Control Path**.
2. Click **RADIUS**.
3. Click the **RADIUS Servers** tab.
4. Click **Insert**.
5. In the **AddressType** box, select IPv4 or IPv6.
6. In the **Address** box, type the IP address of the RADIUS server that you want to add.
7. In the **UsedBy** box, select an option for the user logon.
8. In the **SecretKey** box, type a secret key.
9. In the **SourceIpAddr** box, type the IP address to use as the source address in RADIUS packets.
10. Click **Insert**.

RADIUS Servers field descriptions

Use the data in the following table to use the **RADIUS Servers** tab.

Name	Description
AddressType	Specifies either an IPv4 or an IPv6 address. RADIUS supports IPv4 and IPv6 addresses.
Address	Specifies the IP address of the RADIUS server. RADIUS supports IPv4 and IPv6 addresses.
UsedBy	Specifies the user logon. <ul style="list-style-type: none"> • cli: for cli logon • eap: for EAPoL authentication • snmp: for snmp logon

Table continues...

Name	Description
	<ul style="list-style-type: none"> web: for HTTP(s) access authentication The default is cli.
Priority	Specifies the priority of each server, or the order of servers to send authentication (1 to 10). The default is 10.
TimeOut	Specifies the time interval in seconds before the client retransmits the packet (1 to 20).
Enable	Enables or disables authentication on the server. The default is true.
MaxRetries	Specifies the maximum number of retransmissions allowed (1 to 6). The default is 1.
UdpPort	Specifies the UDP port that the client uses to send requests to the server (1 to 65536). The default value is 1812. The UDP port value set for the client must match the UDP value set for the RADIUS server.
SecretKey	Specifies the RADIUS server secret key, which is the password used by the client to be validated by the server.
AcctEnable	Enables or disable RADIUS accounting. The default is true.
AcctUdpPort	Specifies the UDP port of the RADIUS accounting server (1 to 65536). The default value is 1813. The UDP port value set for the client must match the UDP value set for the RADIUS server.
SourceIpAddr	Specifies the IP address to use as the source address in RADIUS packets. To use this option, you must set the global RADIUS SourceIpFlag to true. RADIUS supports IPv4 and IPv6 addresses.

Reauthenticating the RADIUS SNMP server session

About this task

Specify the number of challenges that you want the RADIUS SNMP server to send to authenticate a given session.

Procedure

1. In the navigation tree, open the following folders: **Configuration > Security > Control Path**.
2. Click **RADIUS**.
3. Click the **RADIUS SNMP** tab.
The RADIUS SNMP tab appears.
4. Select the **Enable** check box.
5. In the **ReauthenticateTimer** field, enter a value to specify the interval between RADIUS SNMP server reauthentications.

The timer for reauthentication of the RADIUS SNMP server session is enabled.

! **Important:**

To abort the RADIUS SNMP server session, enter a value for the `AbortSessionTimer`, and then click **Enable**.

6. Select the **AcctEnable** check box if desired.
7. Click **Apply**.

RADIUS SNMP field descriptions

Use the data in the following table to use the **RADIUS SNMP** tab.

Name	Description
Enable	Enables or disables timer authentication on the server. The default is true.
AbortSessionTimer	Specifies the allowable time, in seconds, before aborting the RADIUS SNMP server session (30 to 65535). The default is 180.
ReAuthenticateTimer	Specifies the time, in seconds, between reauthentications of the RADIUS SNMP server (30 to 65535). The default is 180.
AcctEnable	Enables or disables the RADIUS SNMP session timer.
UserName	Specifies the user name for the RADIUS SNMP accounting.

Configuring RADIUS SNMP

About this task

Configure RADIUS SNMP parameters for authentication and session times.

Procedure

1. In the navigation tree, open the following folders: **Configuration > Security > Control Path**.
2. Click **RADIUS**.
3. Select the **RADIUS SNMP** tab.
4. Select the **Enable** check box to enable RADIUS SNMP.
5. In the **AbortSessionTimer** field, enter the period after which the session expires in seconds.
6. In the **ReAuthenticateTimer** field, enter the period of time the system waits before reauthenticating in seconds.
7. Select the **AcctEnable** check box to enable RADIUS accounting for SNMP.
8. In the **UserName** field, type the RADIUS SNMP user name.
9. Click **Apply**.

RADIUS SNMP field descriptions

Use the data in the following table to use the **RADIUS SNMP** tab.

Name	Description
Enable	Enables or disables timer authentication on the server. The default is true.
AbortSessionTimer	Specifies the allowable time, in seconds, before aborting the RADIUS SNMP server session (30 to 65535). The default is 180.
ReAuthenticateTimer	Specifies the time, in seconds, between reauthentications of the RADIUS SNMP server (30 to 65535). The default is 180.
AcctEnable	Enables or disables the RADIUS SNMP session timer.
UserName	Specifies the user name for the RADIUS SNMP accounting.

Modifying a RADIUS configuration

About this task

Use this procedure to modify an existing RADIUS configuration or single function such as retransmissions and RADIUS accounting.

RADIUS supports IPv4 and IPv6 addresses with no difference in functionality or configuration in all except the following case. When modifying a RADIUS configuration in Enterprise Device Manager (EDM), you must specify if the address type is an IPv4 or an IPv6 address.

Procedure

1. In the navigation tree, open the following folders: **Configuration > Security > Control Path**.
2. Click **RADIUS**.
3. Click the **RADIUS Servers** tab.
4. In the row and field to modify, type the information or use the lists to make a selection. Access the lists by double-clicking in a field.
5. When you are done with modifying the RADIUS configuration, click **Apply**.

RADIUS Servers field descriptions

Use the data in the following table to use the **RADIUS Servers** tab.

Name	Description
AddressType	Specifies either an IPv4 or an IPv6 address. RADIUS supports IPv4 and IPv6 addresses.
Address	Specifies the IP address of the RADIUS server. RADIUS supports IPv4 and IPv6 addresses.
UsedBy	Specifies the user logon. <ul style="list-style-type: none"> • cli: for cli logon • eap: for EAPoL authentication • snmp: for snmp logon • web: for HTTP(s) access authentication

Table continues...

Name	Description
	The default is cli.
Priority	Specifies the priority of each server, or the order of servers to send authentication (1 to 10). The default is 10.
TimeOut	Specifies the time interval in seconds before the client retransmits the packet (1 to 20).
Enable	Enables or disables authentication on the server. The default is true.
MaxRetries	Specifies the maximum number of retransmissions allowed (1 to 6). The default is 1.
UdpPort	Specifies the UDP port that the client uses to send requests to the server (1 to 65536). The default value is 1812. The UDP port value set for the client must match the UDP value set for the RADIUS server.
SecretKey	Specifies the RADIUS server secret key, which is the password used by the client to be validated by the server.
AcctEnable	Enables or disable RADIUS accounting. The default is true.
AcctUdpPort	Specifies the UDP port of the RADIUS accounting server (1 to 65536). The default value is 1813. The UDP port value set for the client must match the UDP value set for the RADIUS server.
SourcelpAddr	Specifies the IP address to use as the source address in RADIUS packets. To use this option, you must set the global RADIUS SourcelpFlag to true. RADIUS supports IPv4 and IPv6 addresses.

Deleting a RADIUS configuration

About this task

Delete an existing RADIUS configuration.

Procedure

1. In the navigation tree, open the following folders: **Configuration > Security > Control Path**.
2. Click **RADIUS**.
3. Click the **RADIUS Servers** tab.
4. Identify the configuration to delete by clicking anywhere in the row.
5. Click **Delete**.

Configuring RADIUS server reachability

About this task

Use this procedure to configure the RADIUS server reachability settings.

Procedure

1. In the navigation tree, expand the following folders: **Configuration > Security > Control Path**.
2. Click **RADIUS**.
3. Click the **RADIUS Global** tab.
4. In the **UserName** field, type the reachability user name.
5. In the **Password** field, type the reachability password.
6. In the **Confirm Password** field, retype the reachability password.
7. In the **Unreachable Timer** field, type the interval in seconds between checks when the RADIUS server is unreachable.
8. In the **KeepAlive Timer** field, type the interval in seconds between checks when the RADIUS server is reachable.
9. Click the **Apply**.

RADIUS Global field descriptions

Use the data in the following table to use the **RADIUS Global** tab.

Name	Description
Enable	Enables the RADIUS authentication feature globally.
MaxNumberServer	Specifies the maximum number of servers to be used, between 1 and 10, inclusive.
AccessPriorityAttrValue	Specific to RADIUS authentication. Specifies the vendor-specific attribute value of the access-priority attribute to match the type value set in the dictionary file on the RADIUS server. The valid values are 192 through 240. The default is 192.
AcctEnable	Enables RADIUS accounting.
AcctAttriValue	Specific to RADIUS accounting. Specifies the vendor-specific attribute value of the CLI-command attribute to match the type value set in the dictionary file on the RADIUS server. This value must be different from the access-priority attribute value configured for authentication. The valid values are 192 through 240. The default value is 193.
AcctIncludeCli	Specifies whether you want CLI commands included in RADIUS accounting requests.

Table continues...

RADIUS

Name	Description
ClearStat	Clears RADIUS statistics from the device.
McastAttributeValue	Specifies the value of the Mcast attribute. The valid values are 0 through 255. The default value is 90.
AuthInfoAttrValue	Specifies the value of the authentication information attribute. The valid values are 0 through 255. The default value is 91.
CommandAccessAttrValue	Specifies the value of the command access attribute. The valid values are 192 through 240. The default value is 194.
CliCommandAttrValue	Specifies the value of the CLI command attribute. The valid values are 192 through 240. The default value is 195.
AuthInvalidServerAddress	Displays the number of access responses from unknown or invalid RADIUS servers.
SourceIpFlag	Includes a configured IP address as the source address in RADIUS packets. The default is false. RADIUS supports IPv4 and IPv6 addresses with no difference in functionality or configuration.
CliCmdCount	Gives the value for the CLI command count. Specify an integer from 1 to 40. The default is 40.
CliProfEnable	Enables RADIUS CLI profiling.
SupportedVendorIds	Shows the vendor IDs that the software supports for RADIUS.
UserName	Specifies the username for RADIUS server reachability. The default is avaya.
Password	Specifies the password for RADIUS server reachability. The default is avaya.
Confirm Password	Confirms the password for RADIUS server reachability.
Unreachable Timer	Specifies, in seconds, the interval between checks when radius server is unreachable. The default is 60 seconds.
Keep Alive Timer	Specifies, in seconds, the interval between checks when radius server is reachable. The default is 180 seconds.

Chapter 9: Secure AAA server communication

An AAA server program deals with requests for access to computer resources and provides authentication, authorization, and accounting (AAA) services. The switch communicates with AAA servers using Remote Authorization Dial-in User Service (RADIUS) and Terminal Access Controller Access Control System Plus (TACACS+). It is not sufficient to protect authentication information with only RADIUS or TACACS+. To provide additional security to the traffic in the communication channel, the software adds support for IP Security (IPsec) for the AAA server communication.

IPsec provides the ability to secure RADIUS and TACACS+ servers against unwanted traffic by filtering on specific network adapters, by allowing or blocking specific protocols and enabling the server to selectively allow traffic from specific source IP addresses.

The following diagram shows the communication between AAA client and AAA server. The IPsec module on the client encrypts the packets to the AAA server and decrypts the packets from the AAA server. Similarly, the IPsec module on the server encrypts or decrypts the packets to or from the client.

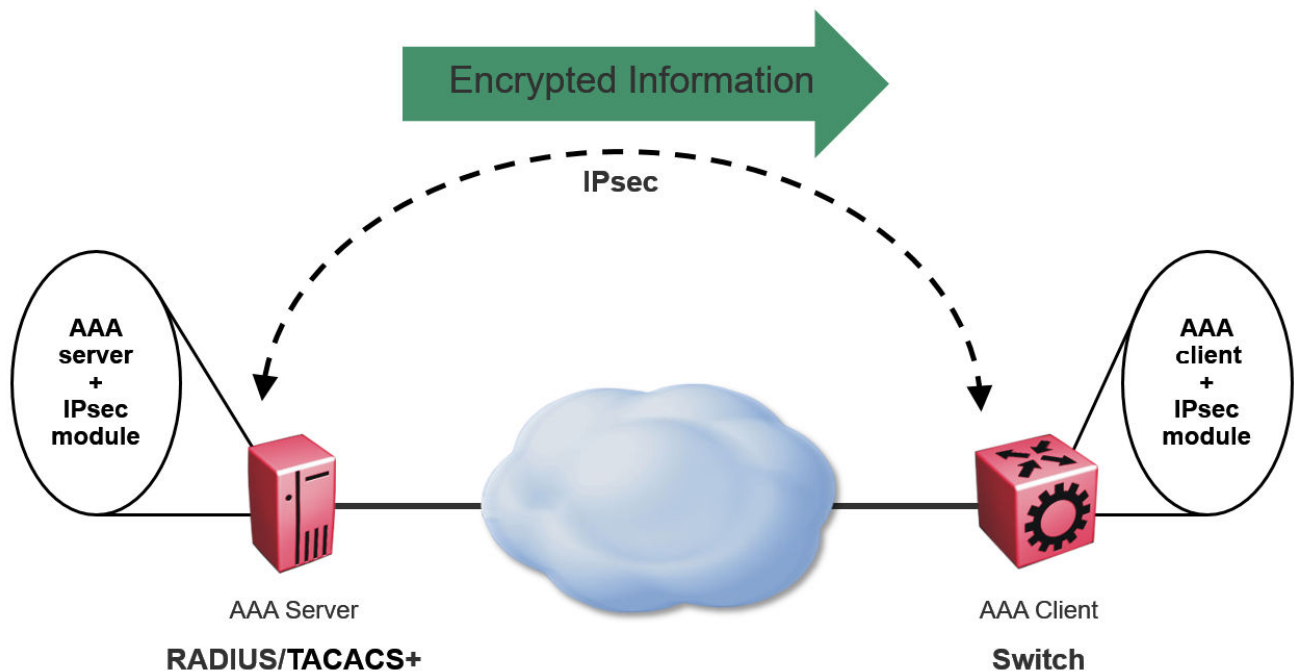

To implement secure AAA server communication, the software supports the following:

- IPsec with Internet Key Exchange (IKE) protocol for both IPv4 and IPv6.
- IPv4 implementation of IPsec, is mainly for protocols involved in communication with AAA servers, that is, RADIUS and TACACS+. However, it supports all UDP and TCP protocols.
- Digital signature as authentication method for IKE, in addition to the pre-shared key authentication method.
- Automatic and manual keying for session establishment. IKE is the default automated key management protocol for IPsec.
- IKEv1 and IKEv2 protocol.

IP security (IPsec)

Internet Protocol Security (IPsec) ensures the authenticity, integrity, and confidentiality of data at the network layer of the Open System Interconnection (OSI) stack.

IPsec secures the AAA server communication using packet filtering and cryptography. Cryptography provides user authentication, ensures data confidentiality and integrity, and enforces trusted communication. For more information on IPsec and its configuration, see [IPsec](#) on page 223.

Internet Key Exchange (IKE) protocol

Internet Key Exchange (IKE) protocol sets up a Security Association (SA) in IPsec. SA is the relationship between two network devices that define attributes such as authentication mechanism, encryption and hash algorithms, exchange mode, and key length for secured communications. SA should be agreed to by both the devices.

The IKE protocol is based on Internet Security Association and Key Management Protocol (ISAKMP) which helps in building a secured connection between two or more hosts using the following concepts:

- authentication
- encryption
- key management
- security association (SA)
- policy

IKE uses a key exchange mechanism based on the Diffie-Hellman encryption key exchange protocol. IKE provides periodic automatic key renegotiation, pre-shared and public key infrastructures, and anti-replay defence. It is layered on top of the UDP protocol and uses UDP port 500 to exchange information between peers.

IKE phases:

A switch negotiates with a peer using IKE in two phases.

- In phase 1, the switch negotiates the IKE SA to protect the negotiations that take place in phase 2. The SAs negotiated in phase 1 are bi-directional, and are applicable to traffic originating in both directions.
- In phase 2, the peers negotiate and establish the SAs for IPsec and session keys through quick mode. A Diffie-Hellman key exchange is done to achieve perfect forward secrecy, which ensures that the compromise of a single key does not permit access to data other than that

protected by that compromised key. The SAs in phase 2 are uni-directional. They are used according to the direction of the traffic. The quick mode is initiated by either of the peer endpoints irrespective of who initiated phase 1.

IKE modes:

There are two modes of exchanging messages in Phase 1:

- Main mode

This is a secure mode of exchanging messages. It allows protection of the confidentiality of the peers during negotiation. This mode provides more flexibility in proposals compared to aggressive mode. As the main mode requires a total of 6 messages to be exchanged between peers, it is more time consuming.

- Aggressive mode

This mode is less secure than the main mode. It does not protect the confidentiality of the peers. However, it requires only a total of 3 messages to be exchanged for phase 1, which makes this mode faster than the main mode. The number of total message exchange is reduced in this mode because some messages are embedded in other messages.

The mode of message exchange in phase 2 is called quick mode. In this mode a total of 3 messages are exchanged between the peers. This mode is used to establish IPsec SA. The negotiations in the quick mode are protected during the phase 1 negotiations in main mode.

IKE policies:

A combination of security parameters used during the IKE SA negotiation is called a policy. The policies must be configured on both the peers and at least one of the policies should match on both ends to have a successful negotiation for. If a policy is not configured on both peers or if a policy does not match on both ends, an SA cannot be setup and data cannot be exchanged.

The following are the attributes of an IKE policy:

- Encryption — This is the cryptographic algorithm that is sent in the proposal by the initiator or responder during the phase 1 negotiation. This cryptographic algorithm is used to encrypt phase 2 negotiation messages. The supported encryption algorithms are:
 - DES
 - 3DES
 - AES
- Hash function — This function is used as part of the authentication mechanism during the authentication of peers in phase 1. It is always used with the authentication algorithm. The supported values are:
 - MD5
 - SHA1
 - SHA256
- Authentication — This process authenticates the peers. Following are the supported authentication modes:
 - Digital Signatures — The digital signatures use digital certificate which is signed by the certificate authority (CA) for authentication.

- Pre-shared keys (PSK) — The PSKs are shared out-of-band between the peers before hand. Using PSK in main mode exchange limits identifying the peer to an IP address (and not host name).
- Diffie-Hellman (DH) Group — This is an algorithm used by two peers that are unknown to each other to establish a shared secret key. This key that is decided during phase 1 is used to encrypt subsequent message exchanges during phase 2 to establish security associations (SA) and security policies (SP) for IPsec sessions. The supported DH Groups are as follows:
 - Group 1 (MODP768)
 - Group 2 (MODP1024)
 - Group 14 (MODP2048)
- Lifetime — This is a time and data limit agreed by peers to protect an SA from getting compromised. It ensures that the peers renegotiate the SAs just before the lifetime value expires, that is, when the time limit is reached.
- Dead-peer detection – This is a process in which the switch waits for a response from peer for a limited number of seconds before declaring the peer as dead. It is a keep-alive mechanism required to perform IKE peer fail-over and to reclaim lost resources by freeing up SAs that are no longer in use.

IKE authentication:

The security gateway of a peer must authenticate the security gateway of the peer it intends to communicate with. This ensures that IKE SAs are established between the peers. The switch supports the following two authentication methods:

- Digital certificates (using RSA algorithms)

For digital certificate authentication, the initiator signs the message interchange data using the private key. The responder uses the public key of the initiator to verify the signature. The public key is exchanged by messages containing an X.509v3 certificate. This certificate provides an assurance that the identity of a peer, as represented in the certificate, is associated with a particular public key.

- Pre-shared keys

Pre-shared key authentication, the same secret must be configured on both security gateways before the gateways can authenticate each other.

Signature authentication:

The switch receives the digital signature of its peer in a message exchange. The switch verifies the digital signature by using the public key of the peer. The certificate of the peer, received during the IKE negotiation, contains the public key. To ensure that the peer certificate is valid, the switch verifies its digital signature by using the certificate authority (CA) public key contained in the root CA certificate. The switch and its IKE peer require at least one common trusted root CA for authentication to work.

When IKE is configured to use digital certificates for authentication, the certificates are retrieved from the trusted certificate store in the switch, based on the provided distinguished name. The certificates received from the peer are verified with the public key.

IKEv2

The software supports IKEv2, which is an enhancement of the IKEv1 protocol. All IKEv2 communications consist of pairs of messages: a request and a response. The IKEv2 protocol uses a

non-reliable transport protocol (UDP using ports 500). The pairs of exchanges allows ensuring of reliability to the IKEv2 protocol, as there is an expected response for each request.

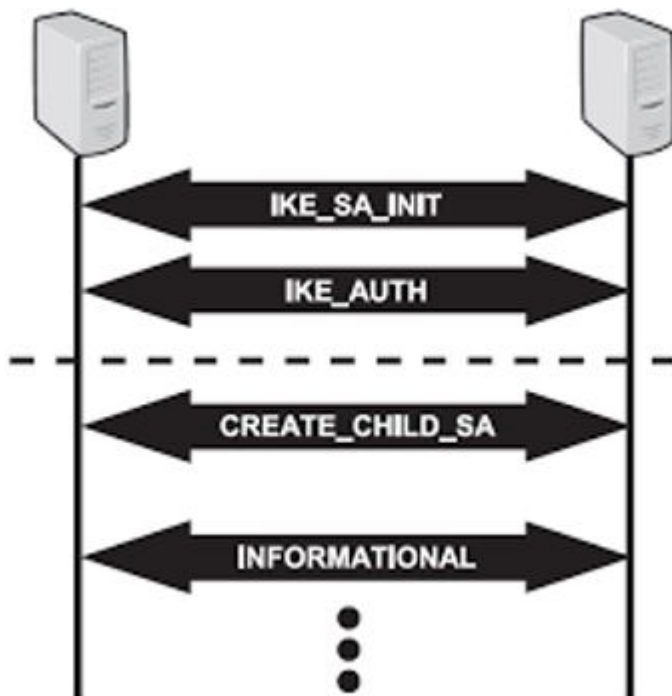

IKEv2 provides a number of improvements over IKEv1, including the following:

- A simplified initial exchange of messages that reduces latency and increases connection establishment speed.
 - IKEv2 makes use of a single four-message exchange instead of the eight different initial exchanges of IKEv1.
 - It improves upon IKEv1's latency by making the initial exchange to be of two round trips of four messages, and allows the ability to add setup of a child SA on that exchange.
- Improved reliability through the use of sequence numbers, and acknowledgements.
 - IKEv2 reduces the number of possible error states by making the protocol reliable as all messages are acknowledged and sequenced.
- IKE SA integrity algorithms are supported only in IKEv2.
- Traffic Selectors are specified in IKEv2 by their own payloads type and not by overloading ID payloads. This makes the Traffic Selectors more flexible.
- No lifetime negotiations for IKEv2, but in IKEv1 SA lifetimes are negotiated.

IKEv2 OCSP validation:

Confirmation of certificate reliability is essential to achieve the security assurances public key cryptography provides. One fundamental element of such confirmation is reference to certificate revocation status. IKEv2 enables the use of Online Certificate Status Protocol (OCSP) for in-band signaling of certificate revocation status. The IKEv2 supports the authentication methods as pre shared key and digital certificate. It allows the verification of the digital certificate sent by the peer

whether it is revoked or not. This is done through a method by sending the digital certificate to the OCSP server. The OCSP server in turn verifies the certificate status and sends the response back. Based on the response from OCSP server, the device validates the certificate.

Secure AAA server communication and IKE limitations

This section describes the limitations associated with secure AAA server communication feature.

- AAA server protection is provided only for SSH/CLI/WEB/Telnet/Console Access Protection.
- FQDN (Fully Qualified Domain Names) is not supported to identify endpoints. This is because, the user configures the IP address for the AAA servers in the switch.
- XAUTH (2-factor authentication) is not supported.
- Domain of Interpretation is not supported other than for IPsec.
- NAT Traversal is not supported.
- Custom IKE messages and vendor ID for the messages are not supported.
- IKE fragmentation is not supported.

IKE configuration for Secure AAA server using CLI

Configuring an IKE Phase 1 profile

About this task

Use the following procedure to configure an IKE Phase 1 profile.

Procedure

1. Enter Global Configuration mode:

```
enable  
configure terminal
```
2. Create an IKE phase 1 profile:

```
ike profile WORD<1-32>
```
3. Configure the IKE phase 1 profile hash algorithm:

```
ike profile WORD<1-32> hash-algo <md5|sha|sha256|any>
```
4. Configure the IKE phase 1 profile encryption algorithm:

```
ike profile WORD<1-32> encrypt-algo <desCbc|3DesCbc|aesCbc|any>
```
5. Configure the IKE phase 1 profile Diffie-Hellman group:

```
ike profile WORD<1-32> dh-group <modp768|modp1024|modp2048|any>
```

6. Configure the IKE phase 1 encryption key length:

```
ike profile WORD<1-32> encrypt-key-len <128|192|256>
```

7. Configure the IKE phase 1 lifetime, in seconds:

```
ike profile WORD<1-32> lifetime-sec <0-4294967295>
```

8. (Optional) Delete the IKE Phase 1 profile:

```
no ike profile WORD<1-32>
```

Variable definition

Use the data in the following table to use the `ike profile` commands.

Variable	Value
profile <i>WORD</i> <1-32>	Specifies the IKE profile name.
hash-algo < <i>md5 sha sha256 any</i> >	Specifies the type of hash algorithm. The default value is sha256. To set this option to the default value, use the default operator with the command: default ike profile WORD<1-32> hash-algo
encrypt-algo < <i>desCbc 3DesCbc aesCbc any</i> >	Specifies the type of encryption algorithm. The default value is aesCbc. To set this option to the default value, use the default operator with the command: default ike profile WORD<1-32> encrypt-algo
dh-group < <i>modp768 modp1024 modp2048 any</i> >	Specifies the Diffie-Hellman (DH) group. DH groups categorize the key used in the key exchange process, by its strength. The key from a higher group number is more secure. The default value is modp2048. To set this option to the default value, use the default operator with the command: default ike profile WORD<1-32> dh-group
encrypt-key-len < <i>128 192 256</i> >	Specifies the length of the encryption key. The default is 256. To set this option to the default value, use the default operator with the command: default ike profile WORD<1-32> encrypt-key-len
lifetime-sec < <i>0-4294967295</i> >	Specifies the lifetime value in seconds. The lifetime ensures that the peers renegotiate the SAs just before the expiry of the lifetime value, to ensure that Security Associations are not compromised. The default value is 86400 seconds. To set this option to the default value, use the default operator with the command: default ike profile WORD<1-32> lifetime-sec

Creating an IKE Phase 1 policy

IKE policy establishes Security Associations (SA) and message exchanges with IKE peers to successfully set up secured channels.

About this task

Use the following procedure to create the IKE Phase 1 policy.

Procedure

1. Enter Global Configuration mode:

- ```
enable
```
- ```
configure terminal
```
2. Create an IKE Phase 1 profile:

```
ike policy WORD<1-32> laddr WORD<1-256> raddr WORD<1-256>
```
 3. (Optional) Delete the IKE Phase 1 profile:

```
no ike policy WORD<1-32>
```

Variable definition

Use the data in the following table to use the `ike policy <1-320> laddr` command.

Variable	Value
policy <i>WORD<1-32></i>	Specifies the name of the IKE Phase 1 policy.
laddr <i>WORD<1-256></i>	Specifies the local IPv4 or IPv6 address.
raddr <i>WORD<1-256></i>	Specifies the remote IPv4 or IPv6 address.

Configuring profile to be used for IKE Phase 1 policy

Use the following procedure to configure the IKE Phase1 profile to be used for the IKE Phase 1 policy.

Procedure

1. Enter Global Configuration mode:

```
enable
```

```
configure terminal
```
2. Configure the profile name to be used for IKE Phase 1 policy:

```
ike policy WORD<1-32> profile WORD<1-32>
```

Variable definition

Use the data in the following table to use the `ike policy WORD<1-32> profile WORD<1-32>` command.

Variable	Value
policy <i>WORD<1-32></i>	Specifies the name of the IKE Phase 1 policy.
profile <i>WORD<1-32></i>	Specifies the name of the IKE Phase 1 profile to be used for the policy. To set this option to the default value, use the default operator with the command: default ike policy WORD<1-32> profile

Configuring IKE Phase 2 perfect forward secrecy

Use the following procedure to configure IKE Phase 2 perfect forward secrecy (PFS).

About this task

A Diffie-Hellman key exchange is done to achieve perfect forward secrecy. This ensures that the compromise of even a single key does not permit access to data other than that protected by that key.

Procedure

1. Enter Global Configuration mode:

```
enable
configure terminal
```

2. Configure the IKE Phase 2 perfect forward secrecy:

```
ike policy WORD<1-32> p2-pfs <enable|disable> [use-ike-group
<enable|disable>] [dh-group <modp768|modp1024|modp2048|any]
```

3. **(Optional)** Disable Phase 2 perfect forward secrecy:

```
no ike policy <1-32> p2-pfs
```

Variable definition

Use the data in this table to use the `ike policy WORD<1-32> p2-pfs` command.

Variable	Value
policy <i>WORD<1-32></i>	Specifies the name of the IKE Phase 1 policy.
p2-pfs	Enables the Phase 2 perfect forward secrecy.
dh-group <i><modp768 modp1024 modp2048 any></i>	Configures the Diffie-Hellman (DH) group to be used for Phase 2 perfect forward secrecy (PFS). The default value is modp2048. To set this option to the default value, use the default operator with the command: <code>default ike policy WORD<1-32> p2-pfs dh-group</code>
use-ike-group <i><enable disable></i>	Specifies whether to use the IKE Phase 1 DH group for Phase 2 PFS or not to use it. The default is enable. To set this option to the default value, use the default operator with the command: <code>default ike policy WORD<1-32> p2-pfs use-ike-group</code>

Configuring the IKE authentication method

Use the following procedure to configure the IKE authentication method.

About this task

As part of the IKE protocol, one security gateway must authenticate another security gateway to make sure that IKE SAs are established with the intended party. The switch supports two authentication methods:

- Digital certificates

Configure peer identity name for IKE phase 1 and revocation check method.

- Pre-shared keys

The same secret must be configured on both security gateways before the gateways can authenticate each other.

Procedure

1. Enter Global Configuration mode:

```
enable
configure terminal
```

2. Configure the IKE authentication method using any one of the following:

Digital certificate: `ike policy WORD<1-32> auth-method digital-certificate [peer-name WORD <1-64> | revocation-method <cr|none|ocsp>]`

Or

Pre-shared key: `ike policy WORD<1-32> auth-method pre-shared-key`

3. **(Optional)** Disable the IKE authentication method:

```
no ike policy WORD<1-32> auth-method digital-certificate peer-name
```

Variable definition

Use the data in the following table to use the `ike policy WORD<1-32> auth-method` command.

Variable	Value
<code>policy WORD<1-32></code>	Specifies the name of the IKE Phase 1 policy.
<code>auth-method</code>	Specifies the authentication method. The default is pre-shared key. To set this option to the default value, use the default operator with the command: default ike policy WORD<1-32> auth-method
<code>pre-shared-key WORD<0-32></code>	Specifies the pre-shared key.
<code>digital-certificate peer-name WORD <1-64></code>	Specifies peer identity name for IKE phase 1.
<code>digital-certificate revocation-check-method<cr none ocsp></code>	Specifies the revocation check method. To set this option to the default value, use the default operator with the command: default ike policy WORD<1-32> revocation-check-method

Configuring dead-peer detection timeout

Use the following procedure to configure the dead-peer detection (DPD) timeout for the IKE Phase 1 policy.

About this task

Dead Peer Detection (DPD) timeout is the interval for which the system sends messages to a peer to confirm its availability.

Procedure

1. Enter Global Configuration mode:

```
enable
configure terminal
```

2. Configure the DPD timeout:

```
ike policy WORD<1-32> dpd-timeout <1-4294967295>
```

Variable definition

Use the data in the following table to use the `ike policy WORD<1-32> dpd-timeout` command.

Variable	Value
policy WORD<1-32>	Specifies the name of the IKE Phase 1 policy.
dpd-timeout <1-4294967295>	Specifies the dead peer detection timeout in seconds for the IKE Phase 1 policy. The default is 300 seconds. To set this option to the default value, use the default operator with the command: <code>default ike policy WORD<1-32> dpd-timeout</code>

Enabling the admin state of IKE Phase 1 policy

Use the following procedure to enable admin state of IKE Phase 1 policy.

Procedure

1. Enter Global Configuration mode:

```
enable
configure terminal
```

2. Enable admin state of IKE Phase 1 policy:

```
ike policy WORD<1-32> enable
```

3. **(Optional)** Disable IKE Phase 1 policy:

```
no ike policy WORD<1-32> enable
```

Displaying IKE profiles

Use the following procedure to display the configured IKE profiles:

Procedure

1. Enter Privileged EXEC mode:
enable
2. Display all IKE profiles:
show ike profile
3. Display a specific ike profile:
show ike profile WORD<1-32>

Example

```
Switch:1#show ike profile
```

IKE Profile						
Name	Hash Algo	Encrypt Algo	Encrypt Key Len	DH Group	Exchange Mode	Lifetime seconds
DFLT_IKE_PROFILE	sha256	aesCbc	256	modp2048	main	86400
ikePRO	sha256	aesCbc	256	modp2048	main	180
test	sha256	aesCbc	256	modp2048	main	86400

Variable definition

Use the data in the following table to use the **show ike profile** command.

Variable	Value
profile WORD<1-32>	Specifies the name of the profile to be displayed.

Job aid

The following table describes the fields in the output for the **show ike profile** command.

Parameter	Description
Name	Specifies the name of the IKE Phase 1 profile.
Hash Algo	Specifies the hash authorization algorithm. The supported values are md5, sha, and sha256.
Encrypt Algo	Specifies the cryptographic algorithm. The supported values are desCbc, 3DesCbc, and aesCbc.

Table continues...

Parameter	Description
Encrypt Key Len	Specifies the length of the encryption key. The supported values are 128, 192 and 256.
DH Group	Specifies the Diffie-Hellman (DH) group. The supported values are modp768, modp1024, and modp2048.
Exchange Mode	Specifies the IKE mode. The supported mods are main mode and aggressive mode.
Lifetime seconds	Specifies the lifetime value in seconds. The value ranges from 0 to 4294967295 seconds.

Displaying IKE policies

Use the following procedure to display the configured IKE policies

Procedure

1. Enter Privileged EXEC mode:
enable
2. Display all IKE policies:
show ike policy
3. Display a specific IKE policy:
show ike policy WORD<1-32>
4. Display a specific IKE policy at local address.
show ike policy WORD<1-32> laddr WORD<1-256>
5. Display a specific IKE policy at remote address.
show ike policy WORD<1-32> laddr WORD<1-256> raddr WORD<1-256>

Example

```
Switch:1#show ike policy
```

```
=====
                                     IKE Policy
=====
-----
Policy                               Addr
Profile
  Name                               Type Local Address           Remote Address
-----
-----
iketest3                             IPv4 192.168.152.104           192.168.149.207
test
v1pol                                IPv4 192.168.152.104           192.168.152.152
```

```
ikepro
=====
IKE Policy
=====
Policy          Profile          Revocation-
Check peer-identity
Name           Version          Auth-Method    Pre-Shared Key
Method         name
-----
iketest3       2                digital-cert
ocsp
vlpol         1                digital-cert
ocsp
=====
IKE Policy
=====
Policy          DPD          Admin   Oper          Use IKE
Name           Timeout     State  State P2 PFS   DH Grp  DH Group IntfId
-----
iketest3       300         enable up    disable enable modp1024 3047
vlpol         300         enable up    disable enable modp1024 3047
```

Variable definition

Use the data in the following table to use the `show ike policy` command.

Variable	Value
policy <i>WORD</i> <1–32>	Specifies the name of the policy to be displayed.
laddr <i>WORD</i> <1–256>	Specifies the local IPv4 or IPv6 address.
raddr <i>WORD</i> <1–256>	Specifies the remote IPv4 or IPv6 address.

Job aid

The following table describes the fields in the output for the `show ike policy` command.

Parameter	Description
Policy Name	Specifies the name of the policy that is displayed.
Addr Type	Specifies whether the IP address is an IPv4 or IPv6 address.
Local Address	Specifies the local IPv4 or IPv6 address.

Table continues...

Parameter	Description
Remote Address	Specifies the remote IPv4 or IPv6 address.
Profile Name	Specifies the name of the profile.
Profile version	Specifies the version of the profile, version 1 or version 2.
Auth-Method	Specifies the authentication method. The supported values are digital-certificate and pre-shared-key.
Revocation-Check Method	Specifies the revocation check method as OCSP, CRL or none.
Peer-identity name	Specifies peer identity name for IKE phase 1.
Pre-Shared Key	Specifies the pre-shared key value.
DPD Timeout	Specifies the Dead-peer detection timeout in seconds. The supported value ranges from 1 to 4294967295 seconds.
Admin State	Specifies whether the IKE admin state is enabled or disabled.
Oper State	Specifies whether the policy is operational or not. The values are up and down.
P2 PFS	Specifies whether Phase 2 perfect forward secrecy is enabled or not.
Use IKE DH Grp	Specifies whether IKE can use the DH group or not. The values are enable and disable.
DH Group	Specifies the type of DH group selected. The supported values are modp768, modp1024, and modp2048.
IntfId	Specifies the ID of the interface on which the policy is applied.

Displaying IKE security association

Use the following procedure to display the configured IKE Phase 1 for version 1 and 2 security associations (SA).

Procedure

1. Enter Privileged EXEC mode:

```
enable
```
2. Display all the security associations:

```
show ike sa
```
3. Display security associations for IKE Phase 1 for version 1:

Secure AAA server communication

```
show ike sa version v1 WORD<1-32> laddr WORD<1-256> raddr  
WORD<1-256>
```

4. Display security associations for IKE Phase 1 for version 2:

```
show ike sa version v2 WORD<1-32> laddr WORD<1-256> raddr  
WORD<1-256>
```

Example

```
Switch:1(config)#show ike sa version v1
```

```
=====
                        IKE V1 Phase 1 Security Association
=====
Policy          Addr
Name            Type Local Address          Remote Address          Initiator/
-----
ikepsk          IPv4 192.0.2.5                198.51.100.15         Initiator
=====
```

```
=====
                        IKE V1 Phase 1 Security Association
=====
Name            DPD      Hash   Encrypt  DH      Lifetime
                Timeout  Algo   Algo     Group   seconds  Status
-----
ikepsk          300     sha    aesCbc  modp2048 3600     active
=====
```

```
Switch:1(config)#show ike sa version v2
```

```
=====
                        IKE V2 Phase 1 Security Association
=====
Policy          Addr
Name            Type Local Address          Remote Address          Initiator/
-----
v2policy        IPv4 203.0.113.6            198.51.100.20         Responder
=====
```

```
=====
                        IKE V2 Phase 1 Security Association
=====
Name            DPD      Hash   Encrypt  Integrity  DH      Lifetime
                Timeout  Algo   Algo     Algo       Group   seconds  Status
-----
v2policy        300     sha256 aesCbc          modp2048 86400     active
=====
```

Variable definition

Use the data in the following table to use the **show ike sa** command.

Variable	Value
sa	Specifies the IKE security association identifier.

Table continues...

Variable	Value
version v1 <i>WORD</i> <1-32> laddr <i>WORD</i> <1-256> raddr <i>WORD</i> <1-256>	Specifies the local IPv4 or IPv6 address for IKE Phase 1, version 1 SA.
version v2 <i>WORD</i> <1-32> laddr <i>WORD</i> <1-256> raddr <i>WORD</i> <1-256>	Specifies the local IPv4 or IPv6 address for IKE Phase 1, version 2 SA.

Job aid

The following table describes the fields in the output for the `show ike profile` command.

Parameter	Description
Policy Name	Specifies the name of the IKE Phase 1 policy.
Addr Type	Specifies whether the IP address is an IPv4 or IPv6 address.
Local Address	Specifies the local IPv4 or IPv6 address.
Remote Address	Specifies the remote IPv4 or IPv6 address.
Name	Specifies the name of the IKE Phase 1 profile.
DPD Timeout	Specifies the Dead-peer detection timeout in seconds. The supported value ranges from 1 to 4294967295 seconds.
Hash Algo	Specifies the hash authorization algorithm. The supported values are MD5, SHA1, and SHA256.
Encrypt Algo	Specifies the cryptographic algorithm. The supported values are DES, 3DES, and AES.
DH Group	Specifies the Diffe-Hellman (DH) group. The supported values are MOD768, MOD1024, and MOD2048.
Lifetime seconds	Specifies the lifetime value in seconds. The value ranges from 0 to 4294967295 seconds.
Status	Specifies the status of the security association.

Configuring an IKEv2 profile

About this task

Use the following procedure to configure an IKEv2 profile.

Procedure

1. Enter Global Configuration mode:

```
enable
configure terminal
```

2. Create an IKEv2-profile:

```
ike v2-profile WORD<1-32>
```

3. Configure the IKEv2 profile hash algorithm:

```
ike v2-profile WORD<1-32> hash-algo <md5|sha|sha256|any>
```

4. Configure the IKEv2 profile encryption algorithm:

```
ike v2-profile WORD<1-32> encrypt-algo <desCbc|3DesCbc|aesCbc|any>
```

5. Configure the IKEv2 profile integrity algorithm

```
ike v2-profile WORD<1-32> integrity-algo <hmac-md5|hmac-sha|hmac-  
sha256|aes-xcbc|any>
```

6. Configure the IKEv2 profile dh group

```
ike v2-profile WORD<1-32> dh-group <modp768|modp1024|modp2048|any
```

7. Configure the IKEv2 profile encryption key length:

```
ike v2-profile WORD<1-32> encrypt-key-len <128|192|256>
```

8. Configure the IKEv2 profile lifetime, in seconds:

```
ike v2-profile WORD<1-32> lifetime-sec <0-4294967295>
```

9. (Optional) Delete the IKEv2 profile:

```
no ike v2-profile WORD<1-32>
```

Variable definition

Use the data in the following table to use the `ike v2-profile` commands.

Variable	Value
profile <i>WORD<1-32></i>	Specifies the IKE v2-profile name.
hash-algo < <i>md5 sha sha256 any</i> >	Specifies the type of hash algorithm. The default value is sha256. To set this option to the default value, use the default operator with the command: default ike v2-profile WORD<1-32> hash-algo
encrypt-algo < <i>desCbc 3DesCbc aesCbc any</i> >	Specifies the type of encryption algorithm. The default value is aesCbc. To set this option to the default value, use the default operator with the command: default ike v2-profile WORD<1-32> encrypt-algo
integrity-algo <i>md5 sha-1 sha-256 aes-xcbc</i>	Specifies the type of integrity algorithm. The default is sha256. To set this option to the default value, use the default operator with the command: default ike v2-profile WORD<1-32> integrity-algo
dh-group < <i>modp768 modp1024 modp2048 any</i> >	Specifies the Diffie-Hellman (DH) group. DH groups categorize the key used in the key exchange process, by its strength. The key from a higher group number is more secure. The default value is modp2048. To set this option to the default value, use the default operator with the command: default ike v2-profile WORD<1-32> dh-group

Table continues...

Variable	Value
encrypt-key-len <128 192 256>	Specifies the length of the encryption key. The default is 256. To set this option to the default value, use the default operator with the command: <code>default ike v2-profile WORD<1-32> encrypt-key-len</code>
lifetime-sec <0-4294967295>	Specifies the lifetime value in seconds. The lifetime ensures that the peers renegotiate the SAs just before the expiry of the lifetime value, to ensure that Security Associations are not compromised. The default value is 86400 seconds. To set this option to the default value, use the default operator with the command: <code>default ike v2-profile WORD<1-32> lifetime-sec</code>

Displaying IKEv2 profiles

Use the following procedure to display the configured IKEv2 profiles:

Procedure

1. Enter Privileged EXEC mode:
enable
2. Display all IKEv2 profiles:
show ike v2-profile
3. Display a specific IKEv2 profile:
show ike v2-profile WORD<1-32>

Example

```
Switch:1#show ike v2-profile test
```

```
=====
                                IKE2 Profile
=====
```

Encrypt Name	Exchange Mode	Hash Algo	Encrypt Algo	Key
test	main	sha256	aesCbc	
256				

```
=====
                                IKE2 Profile
=====
```

Lifetime Name	DH Group	Integrity Algorithm
test	modp2048	sha256
180		

Variable definitions

Use the data in the following table to use the `show ike v-2profile` command.

Variable	Value
<code>WORD<1-32></code>	Specifies the name of the policy.

Job aid

The following table describes the fields in the output for the `show ike v2-profile` command.

Parameter	Description
Name	Specifies the name of the IKEv2 profile.
Hash Algo	Specifies the hash authorization algorithm. The supported values are MD5, SHA1, and SHA256.
Encrypt Algo	Specifies the cryptographic algorithm. The supported values are DES, 3DES, and AES.
Encrypt Key Length	Specifies the length of the encryption key. The supported values are 128, 192, and 256.
DH Group	Specifies the Diffe-Hellman (DH) group. The supported values are modp768, modp024, and modp048.
Integrity Algorithm	Specifies IKE SA integrity algorithms supported in IKEv2.
Exchange Mode	Specifies the IKE mode. The supported mods are main mode and aggressive mode.
Lifetime seconds	Specifies the lifetime value in seconds. The value ranges from 0 to 4294967295 seconds.

IKE configuration for Secure AAA server

Configuring IKE Phase 1 profile

Use the following procedure to create and configure an IKE Phase 1 profile.

Procedure

1. In the navigation pane, expand the following folders: **Configuration > Security > Control Path**.
2. Click **IKE**.
3. Click the **Profile** tab.

4. Click **Insert**.
5. In the **Name** field, type a profile name.
6. Complete the remaining optional configuration to customize the policy.
7. Click **Insert**.

IKE profile field descriptions

Use the data in the following table to use the **IKE > Profile** tab.

Name	Description
Name	Specifies the name of the profile.
HashAlgorithm	Specifies the hash algorithms that can be used during IKE Phase 1 SA negotiation. The default value is sha256.
EncryptionAlgorithm	Specifies the encryption algorithms that can be used during IKE Phase 1 SA negotiation. The default value is aesCbc.
EncryptKeyLen	Specifies the key length that should be used during IKE Phase 1 SA negotiation. The default value is 128.
DHGroup	Specifies the Diffie-Hellman groups that can be used during IKE Phase 1 SA negotiation. The default value is mod1024.
ExchangeMode	Specifies the IKE Phase 1 negotiation mode. The default value is main.
LifetimeSeconds	Specifies the amount of time for which an IKE Phase 1 SA can remain valid during IKE Phase 1 negotiation. A value of 0 means no the SA always remains valid. The default value is 86400 seconds.

Configuring IKEv2 profile

Use the following procedure to create and configure an IKEv2 profile.

Procedure

1. In the navigation pane, expand the following folders: **Configuration > Security > Control Path**.
2. Click **IKE**.
3. Click the **V2 Profile** tab.

4. Click **Insert**.
5. In the **Name** field, type a profile name.
6. Complete the remaining optional configuration to customize the policy.
7. Click **Insert**.

V2 Profile field descriptions

Use the data in the following table to use the **IKE > V2 Profile** tab.

Name	Description
Name	Specifies the IKE v2 profile name.
HashAlgorithm	Specifies the type of hash algorithm that can be used during IKE version 2 SA version 2 negotiation. The default value is sha256.
EncryptionAlgorithm	Specifies the encryption algorithms that can be used during IKE version 2 SA version 2 negotiation. The default value is aesCbc.
EncryptKeyLen	Specifies the type of encryption algorithm. The default value is keylen=256.
DHGroup	Specifies the Diffie-Hellman (DH) group. DH groups categorize the key used in the key exchange process, by its strength. The key from a higher group number is more secure. The default value is modp2048.
ExchangeMode	Specifies the IKE v2 profile negotiation mode. The default value is main.
LifetimeSeconds	Specifies the lifetime value in seconds. The lifetime ensures that the peers renegotiate the SAs just before the expiry of the lifetime value, to ensure that Security Associations are not compromised. The default value is 86400 seconds.
IntegrityAlgorithm	Specifies the type of integrity algorithm.

Configuring IKE Phase 1 policy

Use the following procedure to create and configure an IKE Phase 1 policy.

Procedure

1. In the navigation pane, expand the following folders: **Configuration > Security > Control Path**.
2. Click **IKE**.
3. Click the **Policy** tab.

4. Click **Insert**.
5. In the **LocalIfIndex** field, click either **Port** or **Vlan**, and then select an interface.
6. In the **LocalAddrType** field, select the type of the local address.
7. In the **LocalAddr** field, type the address of the local peer.
8. In the **RemoteAddrType** field, select the type of the remote address.
9. In the **RemoteAddr** field, type the address of the remote peer.
10. In the **Name** field, type the name for the policy.

Name must be assigned when creating the policy. Once the policy is created, the name cannot be changed.

11. Complete the remaining optional configuration to customize the policy.
12. Click **Insert**.

Policy field descriptions

Use the data in the following table to use the Policy tab.

Name	Description
LocalIfIndex	Specifies the Interface Index of the local address. Only port and vlan interfaces are supported.
LocalAddrType	Specifies whether the local address is an IPv4 or IPv6 address.
LocalAddr	Specifies the address of the local peer.
RemoteAddrType	Specifies whether the remote address is an IPv4 or IPv6 address.
RemoteAddr	Specifies the address of the remote peer.
Name	Specifies the name given to the policy. The name should be assigned while creating the policy. You cannot change the name after the policy is created.
ProfileName	Specifies the name of the profile that should be used for this policy.
ProfileVersion	Specifies the profile version used for the policy.
PeerName	Specifies the peer name.
AuthenticationMethod	Specifies the proposed authentication method for the Phase 1 security association. The default authentication method is pre-shared key.
PSKValue	Specifies the value of the Pre-Shared Key if the authentication method is set to PSK.
DPDTimeout	Specifies the Dead Peer Detection timeout in seconds.

Table continues...

Name	Description
	Default value is 300 seconds.
P2PFS	Specifies whether or not the perfect forward secrecy (PFS) is used when refreshing keys. To use PFS, select enable. The default value is disable.
P2PfsUseIkeGroup	Specifies whether or not to use the same GroupId (Diffie-Hellman Group) for phase 2 as was used in phase 1. Ignore this entry if P2PFS is disabled. The default value is enable.
P2PfsDHGroup	Specifies the Diffie-Hellman group to use for phase 2 when P2PFS is enabled and P2PfsUseIkeGroup is disabled. The default value is mod1024.
AdminState	Specifies whether the policy is administratively enabled or disabled. The default value is disable.
OperStatus	Shows is the policy is operationally up or down.
RevocationCheckMethod	Specifies the revocation check method as OCSP, CRL or none.

Displaying IKE Phase 1 security association

Use the following procedure to view the IKE Phase 1 security association.

Procedure

1. In the navigation pane, expand the following folders: **Configuration > Security > Control Path**.
2. Click **IKE**.
3. Click the **SA** tab.

IKE SA field descriptions

Use the data in the following table to use the **IKE > SA** tab.

Name	Description
Id	Specifies the profile ID.
LocalIndex	Specifies the Interface Index of the local address. Only port and vlan interfaces are supported.
LocalAddrType	Specifies whether the local address is an IPv4 or IPv6 address.

Table continues...

Name	Description
LocalAddr	Specifies the address of the local peer.
RemoteAddrType	Specifies whether the remote address is an IPv4 or IPv6 address.
RemoteAddr	Specifies the address of the remote peer.
Name	Specifies the name given to the SA.
AuthenticationMethod	Specifies the proposed authentication method for the Phase 1 security association. The default authentication method is pre-shared key.
DPDTimeout	Specifies the Dead Peer Detection timeout in seconds.
HashAlgorithm	Specifies the hash algorithm negotiated for this IKE Phase 1 SA.
EncryptionAlgorithm	Specifies the encryption algorithm negotiated for this IKE Phase 1 SA.
EncryptKeyLen	Specifies the encryption key length negotiated for this IKE Phase 1 SA.
DHGroup	Specifies the Diffie-Hellman group negotiated for this IKE Phase 1 SA.
ExchangeMode	Specifies the IKE Phase 1 SA mode.
LifetimeSeconds	Specifies the amount of time for which an IKE Phase 1 SA can remain valid during IKE Phase 1 negotiation. A value of 0 means no the SA always remains valid.
Status	Specifies whether the SA is active or inactive.
Initiator	Specifies whether specifies the whether the SA is created by an initiator or a responder.

Displaying IKE V2 security association

Use the following procedure to view the IKE version 2 security association.

Procedure

1. In the navigation pane, expand the following folders: **Configuration > Security > Control Path**.
2. Click **IKE**.
3. Click the **V2 SA** tab.

V2 SA field descriptions

Use the data in the following table to use the **IKE > V2 SA** tab.

Name	Description
Id	Specifies the profile ID.
LocalIfIndex	Specifies the Interface Index of the local address. Only port and vlan interfaces are supported.
LocalAddrType	Specifies whether the local address is an IPv4 or IPv6 address.
LocalAddr	Specifies the address of the local peer.
RemoteAddrType	Specifies whether the remote address is an IPv4 or IPv6 address.
RemoteAddr	Specifies the address of the remote peer.
Name	Specifies the name given to the SA.
AuthenticationMethod	Specifies the proposed authentication method for theVersion 2 security association. The default authentication method is pre-shared key.
DPDTimeout	Specifies the Dead Peer Detection timeout in seconds.
HashAlgorithm	Specifies the hash algorithm negotiated for this IKE Version 2 SA.
EncryptionAlgorithm	Specifies the encryption algorithm negotiated for this IKE Version 2 SA.
EncryptKeyLen	Specifies the encryption key length negotiated for this IKE Version 2 SA.
DHGroup	Specifies the Diffie-Hellman group negotiated for this IKE Version 2 SA.
ExchangeMode	Specifies the IKE Version 2 SA mode.
LifetimeSeconds	Specifies the amount of time for which an IKE Version 2 SA can remain valid during IKE Version 2 negotiation. A value of 0 means no the SA always remains valid.
Status	Specifies whether the SA is active or inactive.
Initiator	Specifies whether specifies the whether the SA is created by an initiator or a responder.
IntegrityAlgorithm	Specifies the type of integrity algorithm.

Chapter 10: Simple Network Management Protocol (SNMP)

You can use the Simple Network Management Protocol (SNMP) to remotely collect management data and configure devices.

An SNMP agent is a software process that monitors the UDP port 161 for SNMP messages. Each SNMP message sent to the agent contains a list of management objects to retrieve or modify.

SNMPv3

The SNMP version 3 (v3) is the third version of the Internet Standard Management Framework and is derived from and builds upon both the original Internet Standard Management Framework SNMP version 1 (v1) and the second Internet Standard Management Framework SNMP version 2 (v2).

The SNMPv3 is not a stand-alone replacement for SNMPv1 or SNMPv2. The SNMPv3 defines security capabilities you must use in conjunction with SNMPv2 (preferred) or SNMPv1. The following figure shows how SNMPv3 specifies a user-based security model (USM) that uses a payload of either an SNMPv1 or an SNMPv2 Protocol Data Unit (PDU).

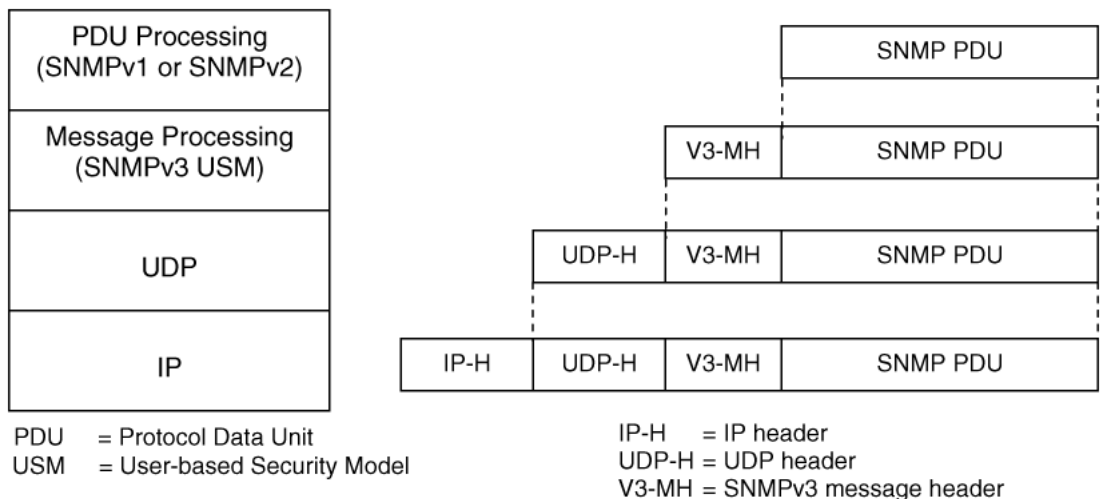

Figure 26: SNMPv3 USM

SNMPv3 is an SNMP framework that supplements SNMPv2 by supporting the following:

- New SNMP message formats
- Security for messages
- Access control
- Remote configuration of SNMP parameters

The recipient of a message can use authentication within the USM to verify the message sender and to detect if the message is altered. According to RFC2574, if you use authentication, the USM checks the entire message for integrity.

An SNMP entity is an implementation of this architecture. Each SNMP entity consists of an SNMP engine and one or more associated applications.

SNMP engine

An SNMP engine provides services for sending and receiving messages, authenticating and encrypting messages, and controlling access to managed objects. A one-to-one association exists between an SNMP engine and the SNMP entity, which contains the SNMP engine.

EngineID

Within an administrative domain, an EngineID is the unique identifier of an SNMP engine. Because there is a one-to-one association between SNMP engines and SNMP entities, the ID also uniquely and unambiguously identifies the SNMP entity within that administrative domain. The system generates an EngineID during the startup process. The SNMP engine contains a:

- [Dispatcher](#) on page 362.
- [Message processing subsystem](#) on page 362.
- [Security subsystem](#) on page 362.
- [Access control subsystem](#) on page 363.

Dispatcher

The dispatcher is part of an SNMP engine. You can use the dispatcher for concurrent support of multiple versions of SNMP messages in the SNMP engine through the following ways:

- To send and receive SNMP messages to and from the network.
- To determine the SNMP message version and interact with the corresponding message processing model.
- To provide an abstract interface to SNMP applications for delivery of a PDU to an application.
- To provide an abstract interface for SNMP applications to send a PDU to a remote SNMP entity.

Message processing subsystem

The message processing subsystem prepares messages for sending and extracts data from received messages. The subsystem can contain multiple message processing models.

Security subsystem

The security subsystem provides the following features:

- Authentication

- Privacy
- Security

Authentication

You can use authentication within the SNMPv3 to verify the message sender and whether the message is altered. If you use authentication, the integrity of the message is verified. The supported SNMPv3 authentication protocols are HMAC-MD5 and HMAC-SHA-96. By default, the switch uses HMAC-SHA1-96 with 160-bit key length.

Privacy

SNMPv3 is an encryption protocol for privacy. Only the data portion of a message is encrypted; the header and the security parameters are not. The privacy protocol that SNMPv3 supports is CBC-DES Symmetric Encryption Protocol and Advanced Encryption Standard (AES).

Security

The SNMPv3 security protects against:

- Modification of information—protects against altering information in transit.
- Masquerade—protects against an unauthorized entity assuming the identity of an authorized entity.
- Message stream modification—protects against delaying or replaying messages.
- Disclosure—protects against eavesdropping.

The SNMPv3 security also offers:

- Discovery procedure—finds the EngineID of an SNMP entity for a given transport address or transport endpoint address.
- Time synchronization procedure—facilitates authenticated communication between entities

The SNMPv3 does not protect against the following:

- Denial-of-service—prevention of exchanges between manager and agent.
- Traffic analysis—general pattern of traffic between managers and agents.

Access control subsystem

SNMPv3 provides a group option for access policies.

The access policy feature in the switch determines the access level for the users connecting to the device with different services like File Transfer Protocol (FTP), Trivial FTP (TFTP), Telnet, and rlogin. The system access policy feature is based on the user access levels and network address. This feature covers services, such as TFTP, HTTP, SSH, rlogin, and SNMP. However, with the SNMPv3 engine, the community names do not map to an access level. The View-based Access Control Model (VACM) determines the access privileges.

Use the configuration feature to specify groups for the SNMP access policy. You can use the access policy services to cover SNMP. Because the access restriction is based on groups defined through the VACM, the synchronization is made using the SNMPv3 VACM configuration. The administrator uses this feature to create SNMP users (USM community) and associate them to groups. You can configure the access policy for each group and network.

The following are feature specifications for the group options:

- After you enable SNMP service, this policy covers all users associated with the groups configured under the access policy. The access privileges are based on access allow or deny. If you select

allow, the VACM configuration determines the management information base (MIB)-views for access.

- The SNMP service is disabled by default for all access policies.
- The access level configured under `access-policy policy <id>` does not affect SNMP service. The VACM configuration determines the SNMP access rights.

User-based security model

In a USM system, the security model uses a defined set of user identities for any authorized user on a particular SNMP engine. A user with authority on one SNMP engine must also have authorization on all SNMP engines with which the original SNMP engine communicates.

The USM provides the following levels of communication:

- NoAuthNoPriv—communication without authentication and privacy.
- AuthNoPriv—communication with authentication and without privacy.
- AuthPriv—communication with authentication and privacy.

The following figure shows the relationship between USM and VACM.

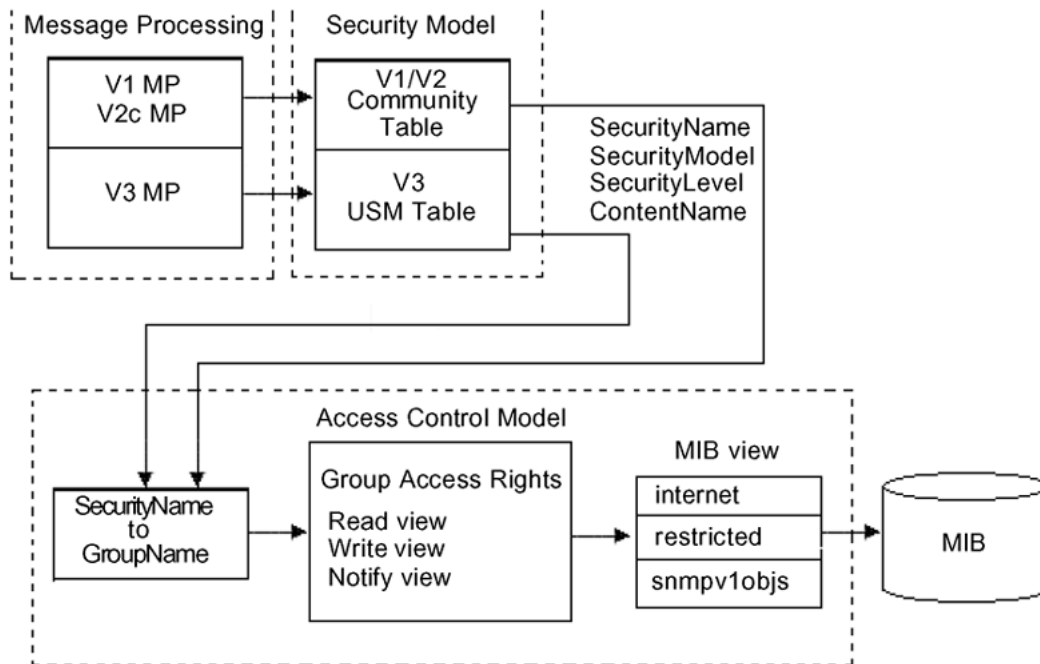

Figure 27: USM association with VACM

View-based Access Control

View-based Access Control Model (VACM) provides group access, group security levels, and context based on a predefined subset of MIB objects. These MIB objects define a set of managed objects and instances.

VACM is the standard access control mechanism for SNMPv3, and it provides:

- Authorization service to control access to MIB objects at the PDU level.

- Alternative access control subsystems.

The access is based on principal, security level, MIB context, object instance, and type of access requested (read or write). You can use the VACM MIB to define the policy and control remote management.

SNMPv3 encryption

A user-based security port for SNMPv3 is defined as a security subsystem within an SNMP engine. The switch USM uses HMAC-MD5-96 and HMAC-SHA-96 as the authentication protocols, and CBC-DES as the privacy protocol. Use USM to use other protocols instead of, or concurrently with, these protocols. CFB128-AES-128, an AES-based Symmetric Encryption Protocol, is an alternative privacy protocol for the USM.

The AES standard is the current encryption standard, Federal Information Processing Standard 140-2 (FIPS 140-2), intended to be used by the U.S. Government organizations to protect sensitive information. The AES standard is also becoming a global standard for commercial software and hardware that uses encryption or other security features.

The AES-based symmetric encryption protocol

This symmetric encryption protocol provides support for data confidentiality. The system encrypts the designated portion of the SNMP message and includes it as part of the transmitted message.

The USM specifies that the scoped PDU is the portion of the message that requires encryption. An SNMP engine that can legitimately originate messages on behalf of the appropriate user shares a secret value, in combination with a timeliness value and a 64-bit integer, used to create the (localized) encryption/decryption key and the initialization vector.

The AES encryption key and Initialization Vector

The AES encryption key uses the first 128 bits of the localized key. The 128-bit Initialization Vector (IV) is the combination of the authoritative SNMP engine 32-bit `snmpEngineBoot`, the SNMP engine 32-bit `snmpEngineTime`, and a local 64-bit integer. The system initializes the 64-bit integer to a pseudo-random value at startup time.

Data encryption

The switch handles data encryption in the following manner:

1. The system treats data as a sequence of octets.
2. The system divides the plaintext into 128-bit blocks.
The first input block is the IV, and the forward cipher operation is applied to the IV to produce the first output block.
3. The system produces the first cipher text block by executing an exclusive-OR function on the first plaintext block with the first output block.
4. The system uses the cipher text block as the input block for the subsequent forward cipher operation.
5. The system repeats the forward cipher operation with the successive input blocks until it produces a cipher text segment from every plaintext segment.
6. The system produces the last cipher text block by executing an exclusive-OR function on the last plaintext segment of r bits (r is less than or equal to 128) with the segment of the r most significant bits of the last output block.

Data decryption

The switch handles data decryption in the following manner:

1. In CFB decryption, the IV is the first input block, the system uses the first cipher text for the second input block, the second cipher text for the third input block, and this continues until the system runs out of blocks to decrypt.
2. The system applies the forward cipher function to each input block to produce the output blocks.
3. The system passes the output blocks through an exclusive-OR function with the corresponding cipher text blocks to recover the plaintext blocks.
4. The system sends the last cipher text block (whose size r is less than or equal to 128) through an exclusive-OR function with the segment of the r most significant bits of the last output block to recover the last plaintext block of r bits.

Trap notifications

You configure traps by creating SNMPv3 trap notifications, creating a target address to which you want to send the notifications, and specifying target parameters. For more information about how to configure trap notifications, see *Troubleshooting*.

SNMP community strings

For security reasons for SNMPv1 and SNMPv2, the SNMP agent validates each request from an SNMP manager before responding to the request by verifying that the manager belongs to a valid SNMP community. An SNMP community is a logical relationship between an SNMP agent and one or more SNMP managers (the manager software implements the protocols used to exchange data with SNMP agents). You define communities locally at the agent level.

The agent establishes one community for each combination of authentication and access control characteristics that you choose. You assign each community a unique name (community string), and all members of a community have the same access privileges, either read-only or read-write:

- Read-only: members can view configuration and performance information.
- Read-write: members can view configuration and performance information, and change the configuration.

By defining a community, an agent limits access to its MIB to a selected set of management stations. By using more than one community, the agent can provide different levels of MIB access to different management stations.

SNMP community strings are used when a user logs on to the device over SNMP, for example, using an SNMP-based management software. You set the SNMP community strings using CLI . If you have read/write/all access authority, you can modify the SNMP community strings for access to the device through Enterprise Device Manager (EDM).

You are provided with community strings for SNMPv1 and SNMPv2. If you want to use SNMPv3 only, you must disable SNMPv1 and SNMPv2 access by deleting the default community string entries and create the SNMPv3 user and group. [SNMPv3](#) on page 361.

*** Note:**

If you enable enhanced secure mode, the switch does not support the default SNMPv1 and default SNMPv2 community strings, and default SNMPv3 user name. The individual in the administrator access level role can configure a non-default value for the community strings, and the switch can continue to support SNMPv1 and SNMPv2. The individual in the administrator access level role can also configure a non-default value for the SNMPv3 user name and the switch can continue to support SNMPv3.

If you disable enhanced secure mode, the SNMPv1 and SNMPv2 support for community strings remains the same, and the default SNMPv3 user name remains the same. Enhanced secure mode is disabled by default.

For more information on enhanced secure mode, see *Administering*.

The following table lists the default community strings for SNMPv1 and SNMPv2.

VRF	Default community string	Access
GlobalRouter VRF	public	Read access
	private	Write access
ManagementRouter VRF	public:512	Read access
	private:512	Write access

Community strings are encrypted using the AES encryption algorithm. Community strings do not appear on the device and are not stored in the configuration file.

! Caution:

Security risk

For security reasons, it is recommended that you set the community strings to values other than the factory defaults.

The switch handles community string encryption in the following manner:

- When the device starts up, community strings are restored from the hidden file.
- When the SNMP community strings are modified, the modifications are updated to the hidden file.
- Stale snmp-server community entries for different VRFs appear after reboot with no VRFs . On an node with any valid config file saved with more than the default vrf0 , snmp_community entries for that VRF are created and maintained in a separate txt file, snmp_comm.txt, on every boot. The node reads this file and updates the snmp communities available on the node. As a result for a boot with config having no VRFs, you may still see snmp_community entries for VRFs other than the globalRouter vrf0.

Hsecure with SNMP

If you enable hsecure, the system disables SNMPv1, SNMPv2 and SNMPv3. If you want to use SNMP, you must use the command `no boot config flag block-snmp` to re-enable SNMP.

SNMPv3 support for VRF

Use Virtual Router Forwarding (VRF) to offer networking capabilities and traffic isolation to customers that operate over the same node (switch). Each virtual router emulates the behavior of a dedicated hardware router and is treated by the network as a separate physical router. You can use VRF Lite to perform the functions of many routers using a single router running VRF Lite. This substantially reduces the cost associated with providing routing and traffic isolation for multiple clients.

SNMP configuration using CLI

Configure the SNMP engine to provide services to send and receive messages, authenticate and encrypt messages, and control access to managed objects. A one-to-one association exists between an SNMP engine and the SNMP entity.

- To perform the procedures in this section, you must log on to the Global Configuration mode in CLI. For more information about how to use CLI, see *Using CLI and EDM*.

This task flow shows you the sequence of procedures you perform to configure basic elements of SNMP when using CLI.

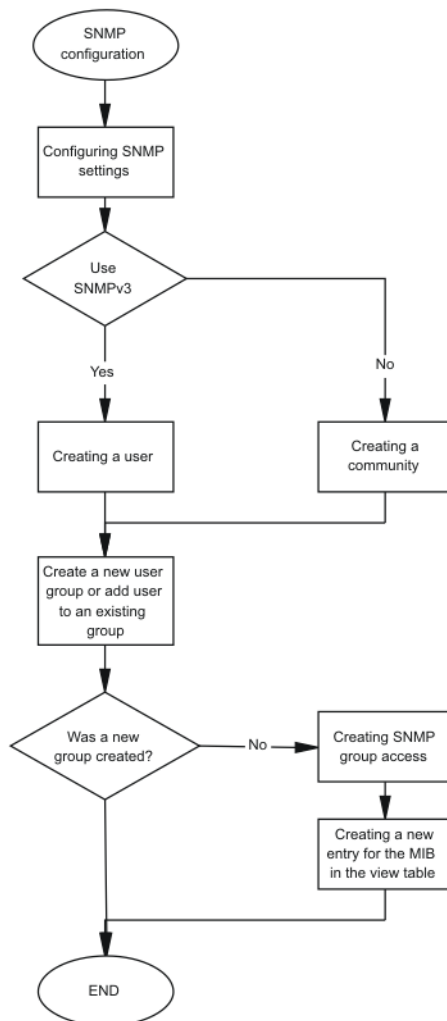

Figure 28: SNMP configuration procedures

Configuring SNMP settings

Configure Simple Network Management Protocol (SNMP) to define or modify the SNMP settings, and specify how secure you want SNMP communications.

Procedure

1. Enter Global Configuration mode:

```
enable
```

```
configure terminal
```

2. Enable the generation of authentication traps:

```
snmp-server authentication-trap enable
```

3. Configure the contact information for the system:

```
snmp-server contact WORD<0-255>
```

4. Configure the SNMP and IP sender flag to the same value:

```
snmp-server force-iphdr-sender enable
```

5. Send the configured source address (sender IP) as the sender network in the notification message:

```
snmp-server force-trap-sender enable
```

6. Create an SNMPv1 server host:

```
snmp-server host WORD<1-256> [port <1-65535>] v1 WORD<1-32> [filter WORD<1-32>]
```

7. Create an SNMPv2 server host:

```
snmp-server host WORD<1-256> [port <1-65535>] v2c WORD<1-32> [inform [timeout <1-2147483647>][retries <0-255>][mms <0-2147483647>]] [filter WORD<1-32>]
```

8. Create an SNMPv3 server host:

```
snmp-server host WORD<1-256> [port <1-65535>] v3 {noAuthNoPriv|authNoPriv|authPriv WORD<1-32> [inform [timeout <1-2147483647>][retries <0-255>]] [filter WORD<1-32>]}
```

9. Configure the system location:

```
snmp-server location WORD<0-255>
```

10. Configure the system name:

```
snmp-server name WORD<0-255>
```

11. Create a new entry in the notify filter table:

```
snmp-server notify-filter WORD<1-32> WORD<1-32>
```

12. Configure the SNMP trap receiver and source IP addresses:

```
snmp-server sender-ip {A.B.C.D} {A.B.C.D}
```

Example

Enable the generation of SNMP traps. Configure the contact information for the system. Configure the SNMP and IP sender flag to the same value. Configure hosts to receive SNMP notifications:

```
Switch:1>enable
Switch:1#configure terminal
Switch:1(config)#snmp-server authentication-trap enable
Switch:1(config)#snmp-server contact xxxx@company.com
Switch:1(config)#snmp-server force-iphdr-sender enable
Switch:1(config)#snmp-server host 192.0.2.16 port 1 v1 SNMPv1 filter SNMPfilterv1
```

Variable definitions

Use the data in the following table to use the `snmp-server` command.

Table 10: Variable definitions

Variable	Value
bootstrap {min-secure semi-secure very-secure}	<p>Creates an initial set of configuration data for SNMPv3. This configuration data follows the conventions described in the SNMPv3 standard (see standard, RFC3515). This command creates a set of initial users, groups, and views.</p> <ul style="list-style-type: none"> • min-secure—a minimum security configuration that gives read access and notify access to all processes (MIB view restricted) with noAuth-noPriv and read, write, and notify access to all processes (MIB view internet) using Auth-Priv. In this configuration, restricted MIB view matches internet MIB view. • semi-secure—a security configuration that gives read access and notify access to all processes (MIB view restricted) with noAuth-noPriv and read, write, and notify access to all processes (MIB view Internet) using Auth-Priv. In this configuration, restricted MIB view contains a smaller subset of views than Internet MIB view. For more information, see RFC3515 for details. • very-secure—a maximum security configuration that allows no access to the users. <p>With this command all existing SNMP configurations in the SNMPv3 MIB tables are removed and replaced with entries as described in the RFC.</p>
contact WORD<0-255>	Changes the sysContact information for the switch. WORD<0-255> is an ASCII string from 0–255 characters (for example a phone extension or e-mail address).
host WORD<1-256> [port <1-65535>] {v1 WORD<1-32> v2c WORD<1-32> [inform [timeout <1-2147483647>][retries <0-255>] [mms <0-2147483647>]] v3 {noAuthPriv authNoPriv authPriv} WORD<1-32> [inform [timeout <1-2147483647>][retries <0-255>]]} [filter WORD<1-32>]	<p>Configures hosts to receive SNMP notifications.</p> <ul style="list-style-type: none"> • host WORD<1-256> specifies the IPv4 or IPv6 host address • port <1-65535> specifies the port number • v1 WORD<1-32> specifies the SNMP v1 security name • v2c WORD<1-32> specifies the SNMPv2 security name • inform specifies the notify type • timeout <1-2147483647> specifies the timeout value • retries <0-255> specifies the number of retries • mms <1-2147483647> specifies the maximum message size • v3 specifies SNMPv3 • noAuthPriv authNoPriv authPriv specifies the security level

Table continues...

Variable	Value
	<ul style="list-style-type: none"> • <i>WORD<1-32></i> specifies the user name • <i>filter</i> specifies a filter profile name
location <i>WORD<0-255></i>	Configures the sysLocation information for the system. <i><WORD 0-255></i> is an ASCII string from 0–255 characters.
name <i>WORD<0-255></i>	Configures the sysName information for the system. <i><WORD 0-255></i> is an ASCII string from 0–255 characters.
notify-filter <i>WORD<1-32></i> <i>WORD<1-32></i>	Creates a new entry in the notify filter table. The first <i>WORD<1-32></i> specifies the filter profile name, and the second <i>WORD<1-32></i> specifies the subtree OID.
sender-ip { <i>A.B.C.D</i> } { <i>A.B.C.D</i> }	<p>The first {<i>A.B.C.D</i>} configures the SNMP trap receiver and source IP addresses. Specify the IP address of the destination SNMP server receives the SNMP trap notification in the first IP address.</p> <p>The second {<i>A.B.C.D</i>} specifies the source IP address of the SNMP trap notification packet that is transmitted in the second IP address. If you set this to 0.0.0.0, the system uses the IP address of the local interface that is closest (from an IP routing table perspective) to the destination SNMP server.</p>

Creating a user

Create a new user in the USM table to authorize a user on a particular SNMP engine

Procedure

1. Enter Global Configuration mode:

```
enable
configure terminal
```

2. Create a user on a remote system:

```
snmp-server user engine-id WORD<16-97>WORD<1-32> [{md5|sha}
WORD<1-32>] [{aes|des} WORD<1-32>]
```

3. Create a user on the local system:

```
snmp-server user WORD<1-32> [notify-view WORD<0-32>] [read-view
WORD<0-32>] [write-view WORD<0-32>] [{md5|sha} WORD<1-32>] [{aes|
des} WORD<1-32>]
```

4. Add the user to a group:

```
snmp-server user WORD<1-32> group WORD<1-32> [{md5|sha} WORD<1-32>]
[{aes|des} WORD<1-32>]
```

Example

Create a user named test1 on a remote system with MD5:

```
Switch:1>enable
Switch:1#configure terminal
Switch:1(config)#snmp-server user test1 md5 auth-password aes test write-view test1
```

Variable definitions

Use the data in the following table to use the `snmp-server user` command.

Table 11: Variable definitions

Variable	Value
{aes des} WORD<1-32>	<p>Specifies a privacy protocol. If no value is entered, no authentication capability exists. The choices are aes or des.</p> <p>WORD<1-32> assigns a privacy password. If no value is entered, no privacy capability exists. The range is 1 to 32 characters.</p> <p>! Important:</p> <p>You must set authentication before you can set the privacy option.</p>
engine-id WORD<16-97>	Assigns an SNMPv3 engine ID. Use the no operator to remove this configuration.
group WORD<1-32>	Specifies the group access name.
{md5 sha} WORD<1-32>	Specifies an authentication protocol. If no value is entered, no authentication capability exists. The protocol choices are: MD5 and SHA. WORD<1-32> specifies an authentication password. If no value is entered, no authentication capability exists. The range is 1–32 characters.
notify-view WORD<0-32>	Specifies the view name in the range of 0 to 32 characters. The first instance is a noAuth view. The second instance is an auth view and the last instance is an authPriv view.
read-view WORD<0-32>	Specifies the view name in the range of 0 to 32 characters. The first instance is a noAuth view. The second instance is an auth view and the last instance is an authPriv view.
write-view WORD<0-32>	Specifies the view name in the range of 0 to 32 characters. The first instance is a noAuth view. The second instance is an auth view and the last instance is an authPriv view.
user WORD<1-32>	Creates the new entry with this security name. The name is used as an index to the table. The range is 1–32 characters. Use the no operator to remove this configuration.

Creating a new user group

Create a new user group to logically group users who require the same level of access. Create new access for a group in the View-based Access Control Model (VACM) table to provide access to managed objects.

* Note:

There are several default groups (public and private) created that you can use. To see the list of default groups and their associated security names (secnames), enter `show snmp-server group`. If you use one of these groups, there is no need to create a new group.

Procedure

1. Enter Global Configuration mode:

```
enable
configure terminal
```

2. Create a new user group:

```
snmp-server group WORD <1-32> WORD<1-32> {auth-no-priv|auth-priv|no-
auth-no-priv} [notify-view WORD<1-32>] [read-view WORD<1-32>]
[write-view WORD<1-32>]
```

Example

This example uses the following variable names:

- The new group name is *lan6grp*.
- The context of the group is "", which represents the Global Router (VRF 0).
- The security level is *no-auth-no-priv*.
- The access view name is *v1v2only* for all three views: **notify-view**, **read-view**, and **write-view**.

```
Switch:1>enable
```

```
Switch:1#configure terminal
```

Create a new user group:

```
Switch:1(config)#snmp-server group lan6grp "" no-auth-no-priv notify-view
v1v2only read-view v1v2only write-view v1v2only
```

Variable definitions

Use the data in the following table use the `snmp-server group` command.

Table 12: Variable definitions

Variable	Value
auth-no-priv	Assigns the minimum level of security required to gain the access rights allowed by this conceptual row. If the auth-no-priv parameter is included, it creates one entry for SNMPv3 access.
auth-priv	Assigns the minimum level of security required to gain the access rights allowed by this conceptual row. If the auth-priv parameter is included, it creates one entry for SNMPv3 access.
group WORD<1-32> WORD<1-32>	<p>The first WORD<1–32> specifies the group name for data access. The range is 1–32 characters. Use the no operator to remove this configuration.</p> <p>The second WORD<1–32> specifies the context name. The range is 1–32 characters. If you use a particular group name value but with different context names, you create multiple entries for different contexts for the same group. You can omit the context name and use the default. If the context name value ends in the wildcard character (*), the resulting entries match a context name that begins with that context. For example, a context name value of foo* matches contexts starting with foo, such as foo6 and fofofum. Use the no operator to remove this configuration.</p>
no-auth-no-priv	Assigns the minimum level of security required to gain the access rights allowed by this conceptual row. If the no-auth-no-priv parameter is included, it creates 3 entries, one for SNMPv1 access, one for SNMPv2c access, and one for SNMPv3 access.
notify-view WORD<1-32>	Specifies the view name in the range of 0–32 characters.
read-view WORD<1-32>	Specifies the view name in the range of 0–32 characters.
write-view WORD<1-32>	Specifies the view name in the range of 0–32 characters.

Creating a new entry for the MIB in the view table

Create a new entry in the MIB view table. The default Layer 2 MIB view cannot modify SNMP settings. However, a new MIB view created with Layer 2 permission can modify SNMP settings.

Procedure

1. Enter Global Configuration mode:

```
enable
configure terminal
```

2. Create a new entry:

```
snmp-server view WORD<1-32> WORD<1-32>
```

Example

```
Switch:1>enable
```

```
Switch:1#configure terminal
```

Create MIB views:

```
Switch:1(config)#snmp-server view 2 1.3.8.7.1.4
```

Variable definitions

Use the data in the following table to use the `snmp-server view` command.

Table 13: Variable definitions

Variable	Value
The first <i>WORD</i> <1-32>	Specifies the prefix that defines the set of MIB objects accessible by this SNMP entity. The range is 1–32 characters.
The second <i>WORD</i> <1-32>	Specifies a new entry with this group name. The range is 1–32 characters.

Creating a community

Create a community to use in forming a relationship between an SNMP agent and one or more SNMP managers. You require SNMP community strings to access the system using an SNMP-based management software.

Procedure

1. Enter Global Configuration mode:

```
enable
```

```
configure terminal
```

2. Create a community:

```
snmp-server community WORD<1-32> [group WORD<1-32>] [index WORD<1-32>] [secname WORD<1-32>]
```

Important:

- The **group** parameter is only required if you created a new user group using the procedure in [Creating a new user group](#) on page 374. If you use any of the default groups, the **secname** automatically links the community to its associated group so there is no need specify the group in this command.
- If you do create a new group, use the **snmp-server community** command to create an SNMP community with a new security name and link it to the new group you created. There is no separate command to create a security name (secname). You use the **snmp-server community** command. The security name is the key to link the community name to a group.
- You cannot use the @ character or the string :: when you create community strings.

Example

In the following example, the community name is *anewcommunity*, the index is *third*, and the secname is *readview*. There is no group specified because this is a default public/read only group.

```
Switch:1>enable
```

```
Switch:1#configure terminal
```

```
Switch:1(config)#snmp-server community anewcommunity index third secname readview
```

Variable definitions

Use the data in the following table to use the `snmp-server community` command.

Table 14: Variable definitions

Variable	Value
community WORD<1-32>	Specifies a community string. The range is 1–32 characters.
group WORD<1-32>	Specifies the group name. The range is 1–32 characters.
index WORD<1-32>	Specifies the unique index value of a row in this table. The range is 1–32 characters.
secname WORD<1-32>	Maps the community string to the security name in the VACM Group Member Table. The range is 1-32 characters.

Adding a user to a group

Add a user to a group to logically group users who require the same level of access.

Procedure

1. Enter Global Configuration mode:

```
enable
```

```
configure terminal
```

2. Create a new user group:

```
snmp-server user WORD<1-32> group WORD<1-32> [{md5 WORD<1-32>|sha WORD<1-32>}] [{aes WORD<1-32>|des WORD<1-32>}]
```

Example

```
Switch:1>enable
```

```
Switch:1#configure terminal
```

Add a user to a group to logically group users who require the same level of access:

```
Switch:1(config)#snmp-server user test1 group Grouptest1 md5 winter aes
summer
```

Variable definitions

Use the data in the following table to use the `snmp-server user` command.

Table 15: Variable definitions

Variable	Value
{aes des} WORD<1-32>	Specifies a privacy protocol. If no value is entered, no authentication capability exists. The choices are aes or des. WORD<1-32> assigns a privacy password. If no value is entered, no privacy capability exists. The range is 1 to 32 characters. ! Important: You must set authentication before you can set the privacy option.
engine-id WORD<16-97>	Assigns an SNMPv3 engine ID. Use the no operator to remove this configuration.
group WORD<1-32>	Specifies the group access name.
{md5 sha} WORD<1-32>	Specifies an authentication protocol. If no value is entered, no authentication capability exists. The protocol choices are: MD5 and SHA. WORD<1-32> specifies an authentication password. If no value is entered, no authentication capability exists. The range is 1–32 characters.
notify-view WORD<0-32>	Specifies the view name in the range of 0 to 32 characters. The first instance is a noAuth view. The second instance is an auth view and the last instance is an authPriv view.
read-view WORD<0-32>	Specifies the view name in the range of 0 to 32 characters. The first instance is a noAuth view. The second instance is an auth view and the last instance is an authPriv view.
write-view WORD<0-32>	Specifies the view name in the range of 0 to 32 characters. The first instance is a noAuth view. The second instance is an auth view and the last instance is an authPriv view.
user WORD<1-32>	Creates the new entry with this security name. The name is used as an index to the table. The range is 1–32 characters. Use the no operator to remove this configuration.

Blocking SNMP

Disable SNMP by using the SNMP block flag. By default, SNMP access is enabled.

Procedure

1. Enter Global Configuration mode:

```
enable
configure terminal
```

2. Disable SNMP:

```
boot config flags block-snmp
```

Example

```
Switch:1>enable
```

```
Switch:1#configure terminal
```

Disable SNMP:

```
Switch:1(config)#boot config flags block-snmp
```

Variable definitions

Use the data in the following table to use the `boot config flags` command.

Table 16: Variable definitions

Variable	Value
block-snmp	Configures the block SNMP flag as active. Use the no operator to remove this configuration. The default is off. To set this option to the default value, use the default operator with the command.

Displaying SNMP system information

Display SNMP system information to view trap and authentication profiles.

For a comprehensive set of SNMP-related `show` commands, see *CLI Commands Reference*.

Procedure

1. Log on to the switch to enter User EXEC mode.
2. Display SNMP system information:

```
show snmp-server
```

Example

```
Switch:1>show snmp-server
```

```
trap-sender :
force-trap-sender : FALSE
force-iphdr-sender : FALSE
contact: none
location : none
name : Switch:1
AuthenticationTrap : false
LoginSuccessTrap : false
```

SNMP configuration using Enterprise Device Manager

Configure SNMP to provide services to send and receive messages, authenticate and encrypt messages, and control access to managed objects with Enterprise Device Manager (EDM).

The following task flow shows you the sequence of procedures you perform to configure basic elements of SNMP using EDM.

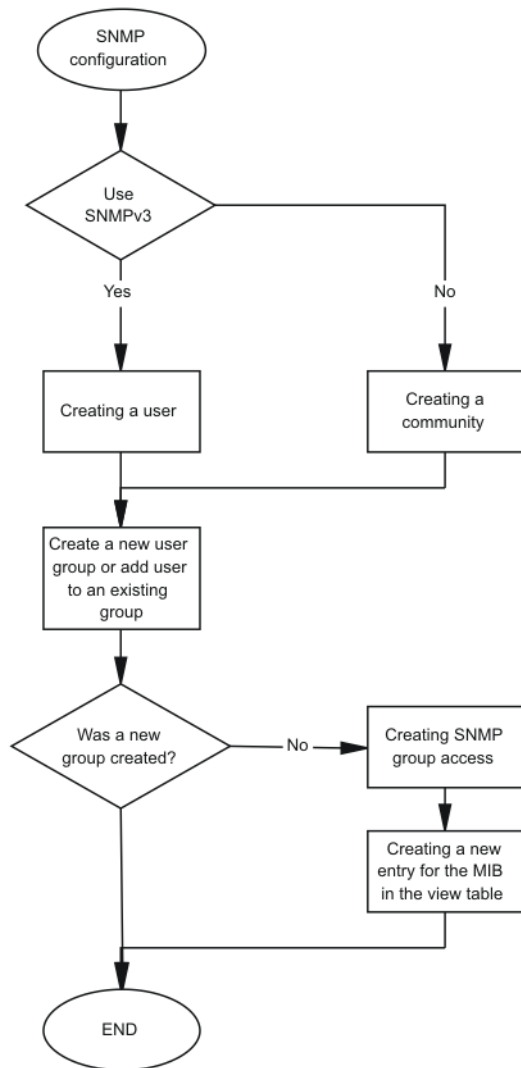

Figure 29: SNMP configuration using Enterprise Device Manager procedures

Creating a user

About this task

Create a new user in the USM table to authorize a user on a particular SNMP engine.

 **Note:**

In EDM, to create new SNMPv3 users you must use the **CloneFromUser** option. However, you cannot clone the default user, named initial. As a result, you must first use CLI to configure at least one user, and then you can use EDM to create subsequent users with the **CloneFromUser** option.

Procedure

1. In the navigation tree, open the following folders: **Configuration > Edit > SnmpV3**.
2. Click **USM Table**.
3. Click **Insert**.
4. In the **EngineID** box, use the default Engine ID provided or type an administratively-unique identifier to an SNMP engine.
5. In the **User Name** box, type a name.
6. From the **CloneFromUser** list, select a security name from which the new entry copies authentication data and private data, if required.
7. From the **Auth Protocol** list, select an authentication protocol.
8. In the **Cloned User's Auth Password** box, type the authentication password of the cloned user.
9. In the **New User's Auth Password** box, type an authentication password for the new user.
10. From the **Priv Protocol** list, select a privacy protocol.
11. In the **Cloned User's Priv Password** box, type the privacy password of the cloned user.
12. In the **New User's Priv Password** box, type a privacy password for the new user.
13. Click **Insert**.

 **Caution:**

Security risk

To ensure security, change the GroupAccess table default view after you set up a new user in the USM table. This prevents unauthorized people from accessing the system using the default user logon. Also, change the Community table defaults, because the community name is used as a community string in SNMPv1/v2 PDU.

USM Table field descriptions

Use the data in the following table to use the **USM Table** tab and the **Insert USM Table** dialog box. Some fields appear only on the Insert USM Table dialog box.

Name	Description
EngineID	Specifies an administratively-unique identifier to an SNMP engine.
UserName	Creates the new entry with this security name. The name is used as an index to the table. The range is 1–32 characters.
SecurityName	Identifies the name on whose behalf SNMP messages are generated.
Clone From User	Specifies the security name from which the new entry must copy privacy and authentication parameters. The range is 1–32 characters. This option appears only in the Insert USM Table dialog box.
Auth Protocol (Optional)	Assigns an authentication protocol (or no authentication) from a list. If you select an authentication protocol, you must enter an old AuthPass and a new AuthPass.
Cloned User's Auth Password	Specifies the current authentication password of the cloned user. This option appears only in the Insert USM Table dialog box.
New User's Auth Password	Specifies the authentication password of the new user. This option appears only in the Insert USM Table dialog box.
Priv Protocol (Optional)	Assigns a privacy protocol (or no privacy) from a list. If you select a privacy protocol, you must enter an old PrivPass and a new PrivPass.
Cloned User's Priv Password	Specifies the current privacy password of the cloned user. This option appears only in the Insert USM Table dialog box.
New User's Priv Password	Specifies the privacy password of the new user. This option appears only in the Insert USM Table dialog box.

Creating a new group membership

About this task

Create a new group membership to logically group users who require the same level of access.

* Note:

There are several default groups (public and private) created that you can use. To see the list of default groups and their associated security names (secnames), enter `show snmp-server group`. If you use one of these groups, there is no need to create a new group.

Procedure

1. In the navigation tree, open the following folders: **Configuration > Edit > SnmpV3**.
2. Click **VACM Table**.
3. Click the **Group Membership** tab.
4. Click **Insert**.
5. From the **SecurityModel** options, select a security model.
6. In the **SecurityName** box, type a security name.

7. In the **GroupName** box, type a group name.
8. Click **Insert**.

Group Membership field descriptions

Use the data in the following table to use the **Group Membership** tab.

Name	Description
SecurityModel	Specifies the security model to use with this group membership.
SecurityName	Specifies the security name assigned to this entry in the View-based Access Control Model (VACM) table. The range is 1–32 characters.
GroupName	Specifies the name assigned to this group in the VACM table. The range is 1–32 characters.

Creating access for a group

About this task

Create access for a group in the View-based Access Control Model (VACM) table to provide access to managed objects.

Procedure

1. In the navigation tree, open the following folders: **Configuration > Edit > SnmpV3**.
2. Click **VACM Table**.
3. Click the **Group Access Right** tab.
4. Click **Insert**.
5. In the **GroupName** box, type a VACM group name.
6. In the **ContextPrefix** box, select a VRF instance. This is an optional step.
7. From the **SecurityModel** options, select a model.
8. From the **SecurityLevel** options, select a security level.
9. In the **ContextMatch** option, select a value to match the context name. This value is **exact** by default.
10. **(Optional)** In the **ReadViewName** box, type the name of the MIB view that forms the basis of authorization when reading objects. This is an optional step.
11. **(Optional)** In the **WriteViewName** box, type the name of the MIB view that forms the basis of authorization when writing objects. This is an optional step.
12. **(Optional)** In the **NotifyViewName** box, type MIB view that forms the basis of authorization for notifications. This is an optional step.
13. Click **Insert**.

Group Access Right field descriptions

Use the data in the following table to use the **Group Access Right** tab.

Name	Description
GroupName	Specifies the name of the new group in the VACM table. The range is 1–32 characters.
ContextPrefix	Specifies if the contextName must match the value of the instance of this object exactly or partially. The range is an SnmpAdminString, 1–32 characters.
SecurityModel	Specifies the authentication checking to communicate to the switch. The security models are: <ul style="list-style-type: none"> • SNMPv1 • SNMPv2 • USM
SecurityLevel	Specifies the minimum level of security required to gain the access rights allowed. The security levels are: <ul style="list-style-type: none"> • noAuthNoPriv • authNoPriv • authpriv
ContextMatch	Specifies if the prefix and the context name must match. If the value is exact, all rows where the contextName exactly matches vacmAccessContextPrefix are selected. If you do not select exact, all rows where the contextName with starting octets that exactly match vacmAccessContextPrefix are selected.
ReadViewName	Identifies the MIB view of the SNMP context to which this conceptual row authorizes read access. The default is the empty string.
WriteViewName	Identifies the MIB view of the SNMP context to which this conceptual row authorizes write access. The default is the empty string.
NotifyViewName	Identifies the MIB view of the SNMP context to which this conceptual row authorizes access for notifications. The default is the empty string.

Creating access policies for SNMP groups

About this task

Create an access policy to determine the access level for the users who connect to the switch with different services like File Transfer Protocol (FTP), Trivial FTP (TFTP), Telnet, and rlogin.

You only need to create access policies for SNMP groups if you have the access policy feature enabled. For more information about access policies, see *Administering*.

Procedure

1. In the navigation pane, open the **Configuration > Security > Control Path** folders.

2. Click **Access Policies**.
3. Click the **Access Policies-SNMP Groups** tab.
4. Click **Insert**.
5. Enter an **ID** .
6. In the **Name** box, type a name.
7. From the **Model** options, select a security model.
8. Click **Insert**.

Access Policies — SNMP Groups field descriptions

Use the data in the following table to use the **Access Polices-SNMP Groups** tab.

Name	Description
Id	Specifies the ID of the group policy.
Name	Specifies the name assigned to the group policy. The range is 1–32 characters.
Model	Specifies the security model {SNMPv1 SNMPv2c USM}.

Assigning MIB view access for an object

About this task

Create a new entry in the MIB View table.

You cannot modify SNMP settings with the default Layer 2 MIB view. However, you can modify SNMP settings with a new MIB view created with Layer 2 permissions.

Procedure

1. In the navigation tree, open the following folders: **Configuration > Edit > SnmpV3**.
2. Click **VACM Table**.
3. In the VACM Table tab, click the **MIB View** tab.
4. Click **Insert**.
5. In the **ViewName** box, type a view name.
6. In the **Subtree** box, type a subtree.
7. In the **Mask** box, type a mask.
8. From the **Type** options, select whether access to the MIB object is granted.
9. Click **Insert**.

MIB View field descriptions

Use the data in the following table to use the **MIB View** tab.

Name	Description
ViewName	Creates a new entry with this group name. The range is 1–32 characters.
Subtree	Specifies a valid object identifier that defines the set of MIB objects accessible by this SNMP entity, for example, 1.3.6.1.1.5.
Mask (optional)	Specifies a bit mask with vacmViewTreeFamilySubtree to determine whether an OID falls under a view subtree.
Type	Determines whether access to a MIB object is granted (included) or denied (excluded). The default is included.

Creating a community

About this task

Create a community to use in forming a relationship between an SNMP agent and one or more SNMP managers. You require SNMP community strings for access to the switch using an SNMP-based management software.

Procedure

1. In the navigation tree, open the following folders: **Configuration > Edit > SnmpV3**.
2. Click **Community Table**.
3. Click **Insert**.
4. In the **Index** box, type an index.
5. In the **Name** box, type a name that is a community string.
6. In the **SecurityName** box, type a security name.
7. In the **ContextName** box, type the context name.
8. Click **Insert**.

Community Table field descriptions

Use the data in the following table to use the **Community Table** tab.

Name	Description
Index	Specifies the unique index value of a row in this table. The range is 1–32 characters.
Name	Specifies the community string for which a row in this table represents a configuration.
SecurityName	Specifies the security name in the VACM group member table to which the community string is mapped. The range is 1–32 characters.

Table continues...

Name	Description
ContextEngineID	Indicates the location of the context in which management information is accessed when using the community string specified in Name .
ContextName	Specifies the context in which management information is accessed when you use the specified community string.

Viewing all contexts for an SNMP entity

About this task

View contexts to see the contents of the context table in the View-based Access Control Model (VACM). This table provides information to SNMP command generator applications so that they can properly configure the VACM access table to control access to all contexts at the SNMP entity.

Procedure

1. In the navigation tree, open the following folders: **Configuration > Edit > SnmpV3**.
2. Click **VACM Table**.
3. In the **VACM Table** tab, click the **Contexts** tab.

Contexts field descriptions

Use the data in the following table to use the **Contexts** tab.

Variable	Value
ContextName	Shows the name identifying a particular context at a particular SNMP entity. The empty contextName (zero length) represents the default context.

Chapter 11: TACACS+

This chapter provides Terminal Access Controller Access Control Plus (TACACS+) concepts and procedures to complete TACACS+ configuration.

TACACS+ fundamentals

The switch supports the TACACS+ client. TACACS+ is a remote authentication protocol that provides centralized validation of users who attempt to gain access to a router or Network Access Server (NAS).

The TACACS+ feature is a client and server-based protocol that allows the switch to accept a user name and password and send a query to a TACACS+ authentication server, sometimes called a TACACS+ daemon. The TACACS+ server allows access or denies access based on the response by the client.

The TACACS+ feature facilitates the following services:

- Login authentication and authorization for CLI access through rlogin, Secure Shell (SSH), Telnet, or serial port.
- Login authentication for web access through EDM.
- Command authorization for CLI through rlogin, SSH, Telnet, or serial port.
- Accounting of CLI through rlogin, SSH, Telnet, and serial port.

The following figure displays the basic layout of the switch and the TACACS+ server.

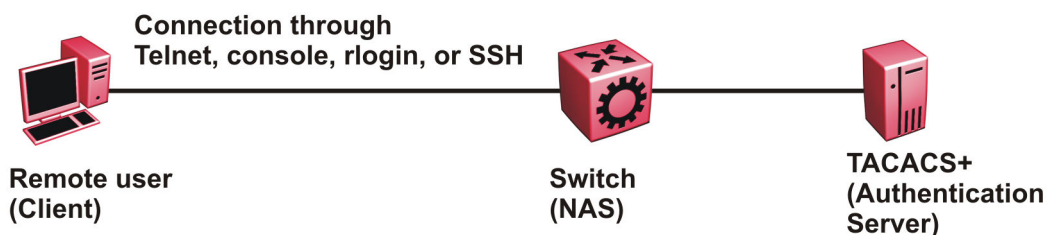

Figure 30: Switch and TACACS+ server

The TACACS+ feature uses Transmission Control Protocol (TCP) for its transport to ensure reliable delivery of packets. TACACS+ provides security by encrypting all traffic between the switch, which acts as the Network Access Server, and the TACACS+ server.

TACACS+ is a newer version of TACACS and provides separate authentication, authorization, and accounting (AAA) services. TACACS+ does not support earlier versions of TACACS.

TACACS+ is a base license feature. The TACACS+ feature is disabled by default.

TACACS+ Operation

The switch acts as an NAS to provide a connection to a single user, to a network, subnetwork or interconnected networks. The switch acts as a gateway to guard access to the TACACS+ server and network. Encryption relies on a secret key that is known to the client and the TACACS+ server.

Similar to the Remote Access Dial-In User Services (RADIUS) protocol, TACACS+ provides the ability to centrally manage the users who want to access a remote device. TACACS+ provides management of remote and local users who try to access a device through:

- rlogin
- Secure Shell (SSHv2)
- Telnet
- serial port
- Web management

A TACACS+ daemon, which typically runs on a UNIX or Windows NT workstation, maintains the TACACS+ authentication, authorization, and accounting services.

Extreme Networks Identity Engines supports the TACACS+ daemon.

It is recommended to use the Identity Engines Ignition Server as your TACACS+ server.

You configure users in the TACACS+ server. If you enable authentication, authorization, and accounting services, the following occurs:

- During the logon process, the TACACS+ client initiates the TACACS+ authentication session with the TACACS+ server.
- After successful authentication the TACACS+ client initiates the TACACS+ authorization session with the TACACS+ server. This is transparent to the user. The switch receives the user access level after a successful TACACS+ authorization. The TACACS+ server authorizes every command the user issues if TACACS + command authorization is enabled for that user access level.
- After successful authorization, if you enable TACACS+ accounting, the TACACS+ client sends accounting information to the TACACS+ server.

A TACACS+ session establishes with the server in one of two ways:

- Multi-connection mode (also known as per-session): For every authentication, authorization, and accounting (AAA) request the switch establishes a session with the TACACS+ server, and then once the request finishes, the session is torn down. Multi-connection mode is the default mode.

- Single-connection mode: The first AAA request establishes the session, which is only torn down if TACACS+ is disabled or due to inactivity.

TACACS+ Architecture

You can connect the TACACS+ server to the switch:

- In-band through one of the data ports.
- Out-of-band through the management port.

Connect the TACACS+ server through a local interface. Management PCs can reside on an out-of-band management Ethernet port, or on the corporate network. Place the TACACS+ server on the corporate network so you can route it to the switch.

Before you configure the switch, you must configure at least one TACACS+ server and a key.

The TACACS+ server and the switch must have the same:

- Encryption key
- Connection mode (single connection or per-session connection. Per-session connection is the same as multi-connection mode.)
- TCP port number

You can configure a secondary TACACS+ server for backup authentication. You specify the primary authentication server when you configure the switch.

Authentication, authorization, and accounting

A fundamental feature of TACACS+ is the separation of authentication, authorization, and accounting (AAA) services, which allows you to selectively implement one or more TACACS+ services.

TACACS+ authentication

TACACS+ authentication provides control of authentication through login and password.

Authentication uses a database of users and passwords to determine:

- who a user is
- whether to allow the user access to the NAS

Important:

Prompts for log on and password occur prior to the authentication process. If TACACS+ fails because no valid servers exist, the device uses the user name and password from the local database. If TACACS+ or the local database returns an access denied packet, the authentication process stops. The device attempts no other authentication methods.

The following figure illustrates the authentication process.

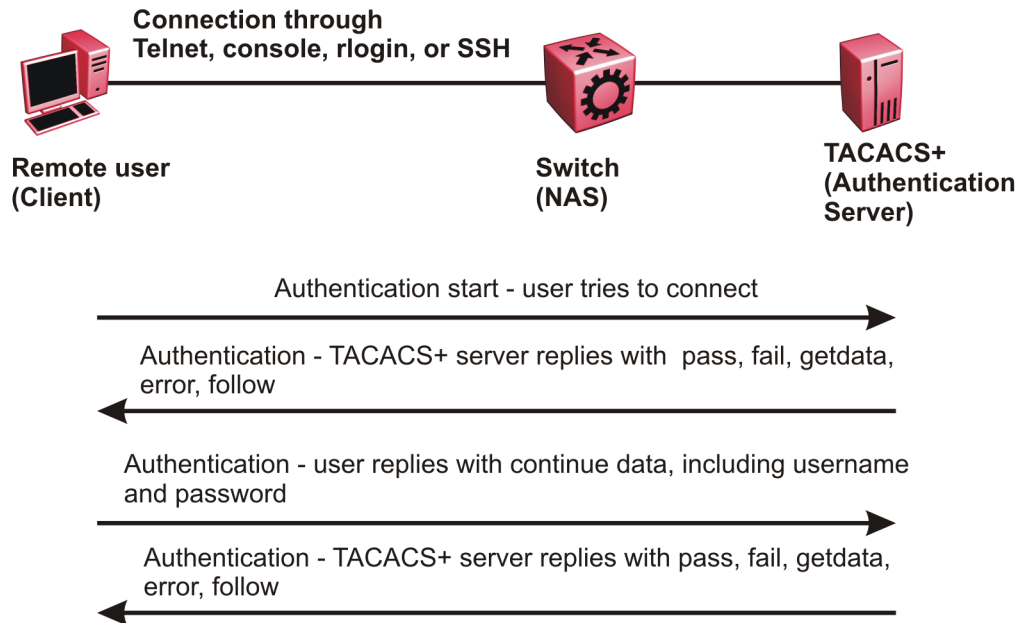

Figure 31: Authentication process

TACACS+ authorization

The transition from TACACS+ authentication to the authorization phase is transparent to the user. After successful completion of the authentication session, an authorization session starts with the authenticated user name. The authorization session provides access level functionality.

Authorization cannot occur without authentication.

Authorization:

- determines what a user can do
- allows administrators fine-grained control over the capabilities of users during sessions

The following figure illustrates the authorization process.

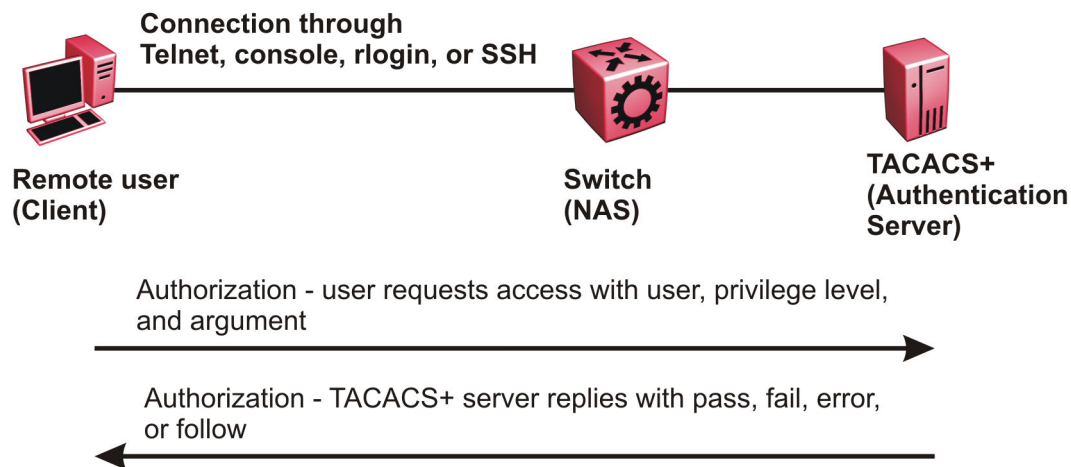

Figure 32: Authorization process

Authorization determines what a user can do. Authorization gives you the ability to limit network services to certain users and to limit the use of certain commands to certain users. The TACACS+ feature enhances the security by tightly policing the command execution for a particular user. After you enable command authorization, all commands, no matter the access level to which they belong, are sent to the TACACS+ server for authorization. Authorization cannot occur without first enabling authentication. You must configure command authorization globally and at individual access levels.

Two kinds of authorization requests exist:

1. Login authorization: Login authorization happens immediately after authentication and is transparent to the user. When the user logs on to the device, authorization provides the user access level. With log on, the device does not send a command to the TACACS+ server. You cannot configure login authorization.
2. Command authorization: When you configure command authorization for a particular level, all commands that you issue are sent to the TACACS+ server for authorization. The device can only issue the commands the TACACS+ server authorizes. You need to configure command authorization globally and at individual access levels, which are visible to the users.

*** Note:**

You must verify that the switch can reach the TACACS+ server and that you configure TACACS+ properly before you enable command authorization.

If a user is TACACS+ authenticated and command authorization is enabled for that level, then if the switch cannot reach the TACACS+ server, the switch does not allow the user to issue any command that has privilege level command authorization enabled. In such a case, the user can only issue logout and exit commands.

If a user tries to log in and the TACACS+ server does not exist or is not reachable, then, as discussed before, a local database in the switch authenticates the user. The switch authorizes a locally authenticated user and a locally authenticated user is not eligible for TACACS+ command authorization.

After the switch requests authorization, the logon credentials are sent to the TACACS+ daemon for authorization. If logon authorization fails, the user receives a permission denied message.

If TACACS+ logon authorization succeeds, the switch uses information from the user profile, which exists in the local user database or on the TACACS+ server, to configure the session for the user.

After you enable TACACS+ command authorization all commands are visible to all users; however, the user can only issue those commands that the TACACS+ server configuration allows.

The switch cannot enforce command access level. The TACACS+ server returns an access level to the switch. The switch allows the user to access the switch according to the access level. The device grants the user access to a command only if the profile for the user allows the access level.

You preconfigure command authorization on the TACACS+ server. You specify a list of regular expressions that match command arguments, and you associate each command with an action to deny or permit.

All members in a group have the same authorization. If you place a user in a group, the daemon looks in the group for authorization parameters if it cannot find them in the user profile.

TACACS+ accounting

TACACS+ accounting enables you to track the services users access and the amount of network resources users consume.

TACACS+ accounting allows you to track:

- what a user does
- when a user does certain actions

The accounting record includes the following information:

- User name
- Date
- Start/stop/elapsed time
- Access server IP address
- Reason

You can use accounting for an audit trail, to bill for connection time or resources used, or for network management. TACACS+ accounting provides information about user sessions using the following connection types: Telnet, rlogin, SSH, and web-based management.

With separation of AAA, accounting can occur independently from authentication and authorization.

The following figure illustrates the accounting process.

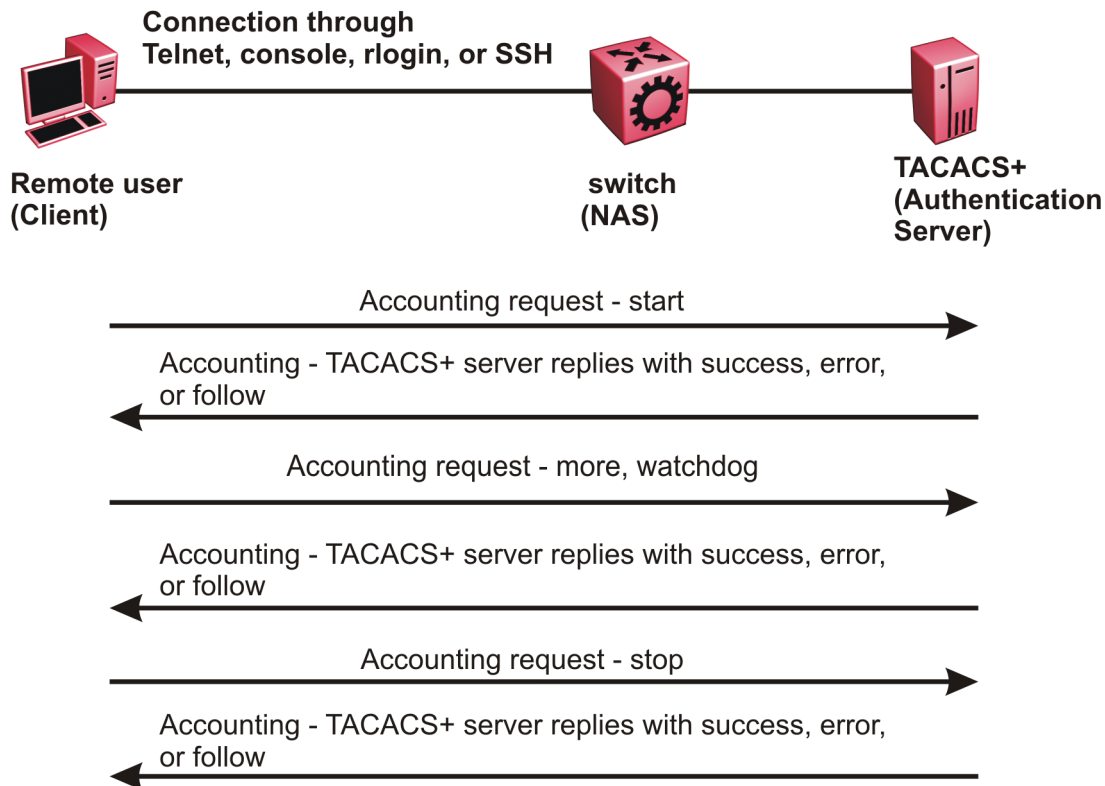

Figure 33: Accounting process

After you enable accounting, the switch reports user activity to the TACACS+ server in the form of accounting records. Each accounting record contains accounting attribute value (AV) pairs. AV pairs are strings of text in the form “attribute-value” sent between the switch and a TACACS+ daemon as part of the TACACS+ protocol. The TACACS+ server stores the accounting records.

You cannot customize the set of events the switch monitors and logs with TACACS+ accounting. TACACS+ accounting logs the following events:

- User logon and logoff
- Logoff generated because of activity timeout
- Unauthorized command
- Telnet session closed (not logged off)

Privilege level changes at runtime

You can change your privilege level at runtime with the `tacacs switch level` command.

You need to configure separate profiles in the TACACS+ server configuration file for the switch level. The switch supports only levels 1 to 6 and level 15. The switch uses the profile when you issue the

command `tacacs switch level <1-15>`. As part of the profile, you specify a user name, level, and password. To preconfigure a dummy user for that level on the TACACS+ daemon, the format of the user name for the dummy user is `$enab<n>$`, where `<n>` is the privilege level to which you want to allow access.

The following is an example of a TACACS+ server profile, which you configure on the TACACS+ server:

```
user = $enab6$ {
member = level6
login = cleartext get-me-on-6
}
```

The following table maps user accounts to TACACS+ privilege level.

Switch access level	TACACS+ privilege level	Description
NONE	0	If the TACACS+ server returns an access level of 0, the user is denied access. You cannot log into the device if you have an access level of 0.
READ ONLY	1	Permits you to view only configuration and status information.
LAYER 1 READ WRITE	2	Permits you to view most of the switch configuration and status information and change physical port settings.
LAYER 2 READ WRITE	3	Permits you to view and change configuration and status information for Layer 2 (bridging and switching) functions.
LAYER 3 READ WRITE	4	Permits you to view and change configuration and status information for Layer 2 and Layer 3 (routing) functions.
READ WRITE	5	Permits you to view and change configuration and status information across the switch. This level does not allow you to change security and password settings.
READ WRITE ALL	6	Permits you to have all the rights of read-write access and the ability to change security settings, including command line interface (CLI) and web-based management user names and passwords, and the SNMP community strings.

Table continues...

Switch access level	TACACS+ privilege level	Description
NONE	7 to 14	If the TACACS+ server returns an access level of 7 to 14, the user is denied access. You cannot log into the device if you have an access level of 7 to 14.
READ WRITE ALL	15	Permits you to have all the rights of read-write access and the ability to change security settings, including command line interface (CLI) and Web-based management user names and passwords, and the SNMP community strings.  Note: Access level 15 is internally mapped to access level 6, which ensures consistency with other vendor implementations. The switch does not differentiate between an access level of 6 and an access level of 15.

 **Note:**

If you enable enhanced secure mode with the `boot config flags enhancedsecure-mode` command, you enable different access levels, along with stronger password complexity, length, and minimum change intervals. With enhanced secure mode enabled, the switch supports the following access levels for RADIUS authentication:

- Administrator
- Privilege
- Operator
- Auditor
- Security

The switch associates each username with a certain role and appropriate authorization rights to view and configure commands. For more information on system access fundamentals and configuration, see *Administering*.

TACACS+ command authorization

After you enable TACACS+ authorization, the current privilege-level to command mapping on the switch is no longer relevant because the TACACS+ server has complete responsibility for command authorization. TACACS+ authorization provides access to the system based on username, not based on privilege level.

After you enable TACACS+ command authorization for a particular privilege level, and a user with that privilege level logs on, the user can access commands based on his user name.

TACACS+ switch level and TACACS+ switch back commands

The user can only issue the `tacacs switch level` command after TACACS+ authenticates the user. Locally authenticated users, which means users authenticated only by the switch and not by the TACACS+ server, cannot use the `tacacs switch level` command.

Consider a user, called X, with a privilege level of 4, who uses the `tacacs switch level <1-15>` command to change the privilege level from 4 to 6.

If user X successfully changes the switch level to 6, the user name changes from X to “\$enab6\$”, and the privilege level changes from 4 to 6. If TACACS+ command authorization is enabled for privilege level 6, then the TACACS+ server authorizes commands issued based on the rules defined for (dummy) user “\$enab6\$”.

If TACACS+ command authorization is not enabled for privilege level 6, then the switch locally authorizes the user X based on the privilege level of the user.

The user can return to his previous privilege level using the `tacacs switch back` command. In the preceding scenario, if the user issues the `tacacs switch back` command, the user name changes for user X from “\$enab6\$” to X, and the privilege level changes from 6 to 4.

TACACS+ switch level supports up to eight levels, and TACACS+ switch level allows a user to switch level up to eight times from his original privilege level. The switch stores all of the previous privilege levels in the same order in which the user switches levels. After switching eight times, if the user tries to switch a level the ninth time, the following error message displays:

```
Only allowed to switch level 8 times!
```

The user can switch back to his previous privilege levels using the `tacacs switch back` command. The `tacacs switch back` command switches back in the reverse order in which you issued the `tacacs switch level` command. Consider a user who switched levels from 4 to 5, and then to 6. If the user used the `tacacs switch back` command, the user first moves from 6 to 5, and then using the `tacacs switch back` command again moves from 5 to 4.

* Note:

If you want to switch to a privilege level 'X' using `tacacs switch level <1-15>` command, you must create a user "\$enabX\$" on the TACACS+ server. X is the privilege level that you want to change.

TACACS+ switch level functionality:

The following table explains TACACS+ switch level functionality.

User logs in with	TACACS+ server available	Result
TACACS+ authentication	Yes	The user can issue the <code>tacacs switch level <1-15></code> command.
Local authentication	No	The user cannot issue the <code>tacacs switch level <1-15></code> command.

Table continues...

User logs in with	TACACS+ server available	Result
Local authentication	Yes	Even if a TACACS+ server becomes reachable, the user remains locally authenticated and cannot issue the <code>tacacs switch level <1-15></code> command.

TACACS+ command authorization functionality:

The following table explains TACACS+ command authorization functionality.

User logs in with	Command authorization	Result
Local authentication	—	The switch authorizes the user locally.
TACACS+ authentication	Not enabled for the logged-in level.	The switch authorizes the user locally. If the server connection is lost, the switch authorizes the user locally.
TACACS+ authentication	Enabled for the logged-in level.	The TACACS+ server authorizes the user. If the server connection is lost, the user can only issue <code>exit</code> and <code>logout</code> commands.

* Note:

A user who configures TACACS+ is locally authenticated and authorized by the switch, so even after the user configures TACACS+, the switch continues to locally authorize the user.

TACACS+ and RADIUS differences

TACACS+ and RADIUS are security protocols that you can use on network devices.

You can enable TACACS+ and RADIUS together. However, TACACS+ has a higher priority. If the TACACS+ server is not available the authentication is sent to RADIUS, if RADIUS is enabled. However, if TACACS+ authentication fails, then requests are not sent to RADIUS.

Following is a list of differences between TACACS+ and RADIUS.

TACACS+	RADIUS
Separates Authorization, Authentication and Accounting (AAA). As a result, you can selectively implement one or more TACACS+ services. With TACACS+ you can use different servers for each service.	Combines authentication and authorization.
Uses TCP. TCP is connection-oriented.	Uses UDP. UDP is best-effort delivery.

Table continues...

TACACS+	RADIUS
TCP immediately indicates if a server crashes or is not running. TCP offers an acknowledgement that a request has been received.	RADIUS uses re-transmit attempts and timeouts to make up for the support TCP has.
Encrypts the entire body of the packet, which includes the password and username.	Encrypts only the password from the client to the server.
Used for administrator access. Usually used for administrator access to network devices.	Used for subscriber access. Usually used to authenticate remote users to a network.
Can control which access level of commands a user or group can access.	Cannot control which access level of commands can be used.

TACACS+ feature limitations

TACACS+ does not support the following features:

- Point-to-Point Protocol (PPP) authentication and accounting
- IPv6 for TACACS+
- S/KEY (One Time Password) authentication
- PAP/CHAP/MSCHAP authentication methods
- The FOLLOW response of a TACACS+ server, in which the AAA services are redirected to another server. The response is interpreted as an authentication failure.
- User capability to change passwords at runtime over the network. The system administrator must change user passwords locally, on the server.
- TACACS+ command authorization when the user accesses the switch through EDM and SNMP.
- Restriction of command authorization for a specific kind of access. After you enable command authorization, command authorization applies for Telnet, SSH, rlogin, and serial-port access. You cannot restrict command authorization to just one kind of access.

If a user is TACACS+ authenticated and command authorization is enabled for that level, then if the switch cannot reach the TACACS+ server, the switch does not allow the user to execute any command that has privilege level command authorization enabled.

TACACS+ configuration using CLI

Enabling TACACS+

Enable TACACS+ globally on the switch.

The switch supports the TACACS+ client. TACACS+ is a security application implemented as a client and server-based protocol that provides centralized validation of users who attempt to gain access to a router or network access server (the switch).

By default, TACACS+ is disabled.

Before you begin

- You must have access to and you must configure a TACACS+ server before the TACACS+ features on your switch are available.

Procedure

1. Enter Global Configuration mode:

```
enable
configure terminal
```

2. Enable TACACS+ globally:

```
tacacs protocol enable
```

3. Disable TACACS+ globally:

```
no tacacs protocol enable
default tacacs protocol enable
```

Example

```
Switch:1>enable
Switch:1#configure terminal
Switch:1(config)#tacacs protocol enable
```

Adding a TACACS+ server

Add a primary and secondary TACACS+ server and specify the authentication process.

If you have a backup server configured, the AAA request goes to the backup server if the primary server is not available.

You are recommended to use the Identity Engines Ignition server as your TACACS+ server.

About this task

The TACACS+ server and the switch must have the same:

- Encryption key
- Connection mode (single connection or per-session connection. Per-session connection is the same as multi-connection mode)
- TCP port number

Procedure

1. Enter Global Configuration mode:

```
enable
configure terminal
```

2. Add a primary TACACS+ server with an encryption key:

```
tacacs server host {A.B.C.D} key WORD<0-128>
```

3. **(Optional)** Configure the parameters for the primary TACACS+ server as required.

- a. **(Optional)** Specify a single connection. The single connection parameter maintains a constant connection between the switch and the TACACS+ daemon:

```
tacacs server host {A.B.C.D} single-connection
```

*** Note:**

The TACACS+ daemon must also support this mode. If you do not configure this, the switch uses the default connection type, which is the per-session connection. Per-session is the same as multi-connection mode.

- b. **(Optional)** Specify the TCP port to use when the switch connects to the TACACS+ daemon:

```
tacacs server host {A.B.C.D} port <1-65535>
```

The default port is 49.

- c. **(Optional)** Specify the period of time (in seconds) the switch waits for a response from the TACACS+ daemon before it times out and shows an error:

```
tacacs server host {A.B.C.D} timeout <10-30>
```

- d. **(Optional)** Designate a fixed source IP address for all outgoing TACACS+ packets and enable this option:

```
tacacs server host {A.B.C.D} source {A.B.C.D}source-ip-interface
enable
```

4. Specify the IP address of the secondary TACACS+ server and specify an encryption key:

```
tacacs server secondary-host {A.B.C.D} key WORD<0-128>
```

5. **(Optional)** Configure the optional parameters on the secondary TACACS+ server as required.

- a. **(Optional)** Specify a single connection for the secondary TACACS+ server. The single connection parameter maintains a constant connection between the switch and the TACACS+ daemon:

```
tacacs server secondary-host {A.B.C.D} single-connection
```

*** Note:**

The TACACS+ daemon must also support this mode. If you do not configure this, the switch uses the default connection type, which is the per-session connection. Per-session is the same as multi-connection mode.

- b. **(Optional)** Specify the TCP port to use when the switch connects to the TACACS+ daemon:

```
tacacs server secondary-host {A.B.C.D} port <1-65535>
```

- c. **(Optional)** Specify the period of time (in seconds) the switch waits for a response from the TACACS+ daemon before it times out and shows an error:

```
tacacs server secondary-host {A.B.C.D} timeout<10-30>
```

- d. **(Optional)** Designate a fixed source IP address for all outgoing TACACS+ packets and enable this option:

```
tacacs server secondary-host {A.B.C.D} source {A.B.C.D} source-  
ip-interface enable
```

6. Display the status of the TACACS+ configuration:

```
show tacacs
```

7. **(Optional)** Delete a primary TACACS+ server:

```
no tacacs server host{A.B.C.D} [single-connection][source source-ip-  
interface enable]
```

8. **(Optional)** Delete a backup TACACS+ server:

```
no tacacs server secondary-host{A.B.C.D} [single-connection][source  
source-ip-interface enable]
```

9. **(Optional)** Configure a primary TACACS+ server or secondary TACACS+ server to the default settings:

```
default tacacs server {A.B.C.D} [port][single-connection][source  
source-ip-interface enable][timeout]
```

Example

Configure the primary server with the IP address 192.0.2.1 and the encryption key 1dt41y. Configure the secondary server with the IP address 198.51.100.2 with the same encryption key 1dt41y. Display the configuration to ensure proper configuration.

```
Switch:1>enable  
Switch:1#configure terminal  
Switch:1(config)#tacacs server host 192.0.2.1 key 1dt41y
```

```

Switch:1(config)#tacacs server secondary-host 198.51.100.2 key 1dt4ly
Switch:1(config)#show tacacs

Global Status:

    global enable : true

    authentication enabled for : cli

    accounting enabled for : none

    authorization : disabled

    User privilege levels set for command authorization : None

Server:

    create :

Prio      Status  Key      Port  IP address      Timeout Single Source
SourceEnabled
Primary   Conn    *        49    192.0.2.1      10     false  0.0.0.0
false
Backup   NotConn *        49    198.51.100.2   10     false  0.0.0.0
false

Switch:1(config)#no tacacs server host 192.0.2.1
Switch:1(config)#no tacacs server secondary-host 198.51.100.2

```

Variable definitions

Use the data in the following table to use the **tacacs server host** and the **tacacs server secondary-host** commands.

Variable	Value
{A.B.C.D}	Specifies the IP address of the TACACS+ server you want to add. Only IPv4 addresses are valid.
key WORD <0-128>	Configures the authentication and encryption key for all TACACS+ communications between the device and the TACACS+ server. If the key length is zero, that indicates no encryption is used. You must configure the same encryption key for the TACACS+ server and the switch.
port <1-65535>	Configures the TCP port, on which the client establishes a connection to the server. A value of 0 indicates the system specified default value is used. The default is 49. You must configure the same TCP port for the TACACS+ server and the switch.
single-connection	Specifies if the TCP connection between the device and the TACACS+ server is a single connection. If you specify the single connection parameter, the

Table continues...

Variable	Value
	<p>connection between the switch and the TACACS+ daemon remains open, which is more efficient because it allows the daemon to handle a higher number of TACACS+ operations. The single-connection is torn down if TACACS+ is disabled due to inactivity.</p> <p>If you do not configure this, the switch uses the default connection type, which is the multi-connection. With the multi-connection, the connection opens and closes each time the switch and TACACS+ daemon communicate.</p> <p>* Note:</p> <p>You must configure the same connection mode for the TACACS+ server and the switch.</p> <p>To enable single-connection, the TACACS+ daemon has to support this mode as well.</p>
source {A.B.C.D}	<p>Designates a fixed source IP address for all outgoing TACACS+ packets, which is useful if the router has many interfaces and you want to make sure all TACACS+ packets from a certain router have the same IP address.</p> <p>If you do not configure an address, the system uses 0.0.0.0 as the default.</p> <p>Only IPv4 addresses are valid.</p> <p>* Note:</p> <p>If you configure a valid source IP address that is not 0.0.0.0 without enabling source-ip-interface, the source IP address returns to 0.0.0.0.</p>
source-ip-interface enable	<p>Enables the source address. You must enable this parameter if you configure a valid source IP address. The default is disabled.</p>
timeout <10-30>	<p>Configures the maximum time, in seconds, to wait for this TACACS+ server to reply before it times out. The default value is 10 seconds.</p>

Job aid

The following table describes the fields in the output for the `show tacacs` command.

Name	Description
Global Status	
global enable	Displays if the TACACS+ feature is enabled globally.

Table continues...

Name	Description
authentication enabled for	Displays which application is authenticated by TACACS+. The possibilities are CLI, web, or all.
accounting enabled for	Displays if accounting is enabled. You can only enable accounting for CLI. By default, accounting is not enabled.
authorization	Displays if authorization is enabled.
User privilege levels set for command authorization	<p>Displays the privilege levels set for command authorization. When you configure command authorization for a particular level, all commands that you execute are sent to the TACACS+ server for authorization. The device can only execute the commands the TACACS+ server authorizes.</p> <p>The user privilege levels are:</p> <ul style="list-style-type: none"> • 0: denied access • 1: read only (ro) access • 2: Layer 1 read and write (l1) access • 3: Layer 2 read and write (l2) access • 4: Layer 3 read and write (l3) access • 5: read and write (rw) access • 6: read and write all (rwa) access • 7-14: denied access • 15: read and write all (rwa) access
Server	
Prio	Displays the priority of the TACACS+ server. The switch attempts to use the primary server first, and the secondary server second.
Status	Displays the connection status between the server and the switch – connected or not connected.
Key	Displays as ***** instead of the actual key. The key is secret and is not visible.
Port	Displays the TCP port used to establish the connection to the server. The default port is 49.
IP address	Displays the IP address for the primary and secondary TACACS+ servers.
Timeout	Displays the period of time, in seconds, the switch waits for a response from the TACACS+ daemon before it times out and declares an error. The default is 10 seconds.

Table continues...

Name	Description
Single	Displays if a single open connection is maintained between the switch and TACACS+ daemon, or if the switch opens and closes the TCP connection to the TACACS+ daemon each time they communicate. The default is false, which means the device does not maintain the single open connection.
Source	Displays the fixed source IP address, if you configure one, for all outgoing TACACS+ packets.
SourceEnabled	Displays if the fixed source IP address is enabled for all outgoing TACACS+ packets.

Configuring TACACS+ authentication

Configure what application TACACS+ authenticates: CLI, web, or all.

TACACS+ authentication provides control of authentication through login and password.

By default, CLI authentication is enabled.

Before you begin

- You must enable TACACS+ globally for TACACS+ authentication to function.

Procedure

- Enter Global Configuration mode:

```
enable
configure terminal
```
- Configure TACACS+ authentication:

```
tacacs authentication <all/cli/web>
```
- (Optional)** Disable TACACS+ authentication:

```
no tacacs authentication <all/web>
```
- (Optional)** Configure TACACS+ authentication to the default settings (default is cli authentication enabled):

```
default tacacs authentication <all/cli/web>
```
- Display the configuration:

```
show tacacs
```

Example

Configure TACACS+ to authenticate CLI and display the configuration.

```
Switch:1>enable
Switch:1#configure terminal
Switch:1(config)#tacacs authentication cli
```

```

Switch:1(config)#show tacacs
Global Status:

    global enable : true

    authentication enabled for : cli

    accounting enabled for : none

Server:

    create :

Prio    Status  Key      Port  IP address  Timeout  SingleSource  Source  Enabled
Primary Conn    *       49    192.0.2.1   10      false        0.0.0.0 false
Backup  NotConn *       49    198.51.100.2 10      false        0.0.0.0 false

```

Variable definitions

Use the data in the following table to use the `tacacs authentication` command.

Variable	Value
all	Specifies TACACS+ authentication for all applications. By default, CLI authentication is enabled.
cli	Specifies TACACS+ authentication for command line connections. By default, CLI authentication is enabled.
web	Specifies TACACS+ authentication for web connections. By default, CLI authentication is enabled.

Configuring TACACS+ accounting

Determines for which applications TACACS+ collects accounting information. Use TACACS+ accounting to track the services that users access and the amount of network resources that users consume. If unassigned, TACACS+ does not perform the accounting function.

If enabled, TACACS+ accounting logs the following events:

- User log on and log off
- Log off generated because of activity timeout
- Unauthorized command
- Telnet session closed (not logged off)

If unassigned, TACACS+ does not perform the accounting function. No default value exists.

Procedure

1. Enter Global Configuration mode:

```
enable
```

```
configure terminal
```

2. Enable TACACS+ accounting:

```
tacacs accounting enable cli
```

3. **(Optional)** Disable TACACS+ accounting:

```
no tacacs accounting cli
```

```
tacacs accounting disable [cli]
```

Example

Enable TACACS+ accounting:

```
Switch:1>enable
Switch:1#configure terminal
Switch:1(config)#tacacs accounting enable cli
```

Configuring command authorization with TACACS+

Use this procedure to enable TACACS+ authorization for a particular privilege level. Use this option to limit the use of certain commands to certain users.

If command authorization fails, the following log message displays: `Command <command> not authorized for user <username>`.

By default, command authorization is disabled on the switch. The default for the command authorization level is none.

Before you begin

- You must have access to and you must configure a TACACS+ server before the TACACS+ features on your switch are available. You must verify that the switch can reach the TACACS+ server and that you configure TACACS+ properly before you enable command authorization. If a user is TACACS+ authenticated and command authorization is enabled for that level, then if the switch cannot reach the TACACS+ server, the switch does not allow you to issue any command that has privilege level command authorization enabled. If the switch cannot reach the TACACS+ server, you can only issue logout and exit commands.
- To use TACACS+ authorization, you must enable TACACS+ authentication.

About this task

Two kinds of authorization requests exist:

1. Login authorization: Login authorization happens immediately after authentication when the user logs on to the device, authorization provides the user access level. You cannot configure login authorization.
2. Command authorization: When you configure command authorization for a particular level, all commands that you issue are sent to the TACACS+ server for authorization. You need to configure command authorization globally and at individual access levels.

Procedure

1. Enter Global Configuration mode:

```
enable
configure terminal
```

2. Enable TACACS+ authorization:

```
tacacs authorization enable
```

3. Configure TACACS+ privilege level for TACACS+ command authorization:

```
tacacs authorization level <1-6>
tacacs authorization level all
tacacs authorization level none
```

4. **(Optional)** Disable TACACS+ authorization:

```
tacacs authorization disable
default tacacs authorization
```

Example

```
Switch:1>enable
Switch:1#configure terminal
Switch:1(config)#tacacs authorization enable
Switch:1(config)#tacacs authorization level 6
```

Variable definitions

Use the data in the following table to use the `tacacs authorization` command.

Variable	Value
level <1-6>	Enables command authorization for a specific privilege level. The default for the command authorization level is none.
level all	Enables command authorization for all privilege levels. The default for the command authorization level is none.
level none	Disables command authorization for all privilege levels. The default for the command authorization level is none.

Changing privilege levels at runtime

Users can change their privilege levels at runtime. The privilege level determines what commands a user can access through TACACS+ server authorization.

A user can only use the `tacacs switch level` command, after TACACS+ authenticates the user. Locally authenticated users, which means users authenticated only by the switch and not by the TACACS+ server, cannot use the `tacacs switch level` command.

Before you begin

- You need to configure separate profiles in the TACACS+ server configuration file for switch level. As part of the profile, you specify a user name, level, and password.

About this task

After you enable TACACS+ authorization, the current privilege-level to command mapping on the switch is no longer relevant because the TACACS+ server has complete responsibility for command authorization. TACACS+ authorization provides access to the system based on username, not based on privilege level.

After you enable TACACS+ command authorization for a particular privilege level, and a user with that privilege level logs on, the user can access commands based on his user name.

* Note:

If you want to switch to a privilege level 'X' using `tacacs switch level <1-15>` command, you must create a user "\$enabX\$" on the TACACS+ server. X is the privilege level to which you want to change.

Procedure

- Enter Global Configuration mode:

```
enable
configure terminal
```

- Change the privilege level for a user at runtime:

```
tacacs switch level <1-15>
```

- Return to the original privilege level:

```
tacacs switch back
```

Example

Change the privilege level for a user at runtime. Return to the original privilege level:

```
Switch:1>enable
Switch:1#configure terminal
Switch:1(config)#tacacs protocol enable
Switch:1(config)#tacacs switch level 5
Password:*****
```

Return to the original privilege level:

```
Switch:1(config)#tacacs switch back
```

Variable definitions

Use the data in the following table to use the `tacacs switch` command.

Variable	Value
level <1–15>	<p>Specifies the privilege level you want to access. You can change your privilege level at runtime by using this parameter. You are prompted to provide the required password. If you do not specify a level in the command, the administration level is selected by default.</p> <p> Note:</p> <p>For switch level, you need to configure separate profiles in the TACACS+ server configuration file. As part of the profile, you specify a username, level, and password. To preconfigure a dummy user for that level on the TACACS+ daemon, the format of the username for the dummy user is \$enab<n>\$, where <n> is the privilege level to which you want to allow access.</p>
back	Specifies that you want to return to the original privilege level.

TACACS+ configuration using EDM

Configuring TACACS+ globally

Enable TACACS+ globally on the switch. TACACS+ is a security application implemented as a client and server-based protocol that provides centralized validation of users. By default, TACACS+ is disabled.

Before you begin

- You must have access to and you must configure a TACACS+ server before the TACACS+ features on your switch (network access server) are available.

You must verify that the switch can reach the TACACS+ server and that you configure TACACS+ properly before you enable command authorization.

- If a user is TACACS+ authenticated and command authorization is enabled for that level, then if the switch cannot reach the TACACS+ server, the switch does not allow the user to issue any command that has privilege level command authorization enabled. In such a case, the user can only issue logout and exit commands.
- You must enable TACACS+ globally for TACACS+ authentication to function.
- You must enable TACACS+ authentication for TACACS+ authorization to function.

About this task

Configure what application TACACS+ authenticates. TACACS+ authentication provides control of authentication through login and password dialog, challenge and response. By default, CLI authentication is enabled.

After authentication is complete, the switch starts the authorization process. By default, command authorization is disabled on the switch. The default for the command authorization level is none. If command authorization fails, the following log message displays: `Command <command> not authorized for user <username>`.

Two kinds of authorization requests exist:

1. Login authorization: Login authorization happens immediately after authentication when the user logs on to the device, authorization provides the user access level. You cannot configure login authorization.
2. Command authorization: When you configure command authorization for a particular level, all commands that you issue are sent to the TACACS+ server for authorization. You need to configure command authorization globally and at individual access levels.

Enable TACACS+ accounting function and determine which application TACACS+ accounts. After you enable accounting, the switch reports user activity to the TACACS+ server in the form of accounting records. The default for accounting is none.

Procedure

1. In the navigation pane, expand the following folders: **Configuration > Security > Control Path**.
2. Click **TACACS+**.
3. Click the **TACACS+ Globals** tab.
4. Select the **GlobalEnable** check box to enable TACACS+ globally.
5. Select the **cli** check box to enable the **Accounting** option.
6. Select the **cli** or **web** check box to enable the **Authentication** option.
7. Click the **CliCommandAuthorizationEnabled** box to enable TACACS+ authorization.
8. Select the level in the **CliCommandAuthorizationLevels** box.
9. Click **Apply**.

TACACS+ Globals field descriptions

Use the data in the following table to use the **TACACS+ Globals** tab.

Name	Description
GlobalEnable	Enables or disables the TACACS+ feature globally.
Accounting	Determines for which applications TACACS+ collects accounting information. Use TACACS+ accounting to track the services that users access and the amount of network resources that users consume. If

Table continues...

Name	Description
	<p>unassigned, TACACS+ does not perform the accounting function. The default is none.</p> <p>If enabled, TACACS+ accounting logs the following events:</p> <ul style="list-style-type: none"> • User log on and log off • Log off generated because of activity timeout • Unauthorized command • Telnet session closed (not logged off)
Authentication	<p>Configures what application TACACS+ authenticates. The options include:</p> <ul style="list-style-type: none"> • cli • web <p>TACACS + authentication provides control of authentication through login and password dialog, challenge and response.</p> <p>By default, CLI authentication is enabled.</p>
LastUserName	Displays the last user for which the system attempted authentication.
LastAddressType	Displays the type of address to access the TACACS + server.
LastAddress	Displays the last address to access the TACACS+ server.
CliCommandAuthorizationEnabled	<p>Enables TACACS+ authorization for a particular privilege level. Use this option to limit the use of certain commands to certain users. To use TACACS + authorization, you must also use TACACS+ authentication.</p> <p>The switch allows the user to access the switch according to the access level. The default is disabled.</p>
CliCommandAuthorizationLevels	<p>Enables command authorization for a specific privilege level.</p> <p>The default for the command authorization level is none.</p>

Adding a TACACS+ server

Add a TACACS+ server, configure the TACACS+ server, and specify the authentication process.

If you have a secondary server configured, the AAA request goes to the backup server if the primary server is not available.

You are recommended to use the Identity Engines Ignition Server as your TACACS+ server.

Before you begin

You must have access to and you must configure a TACACS+ server before the TACACS+ features on your switch are available.

About this task

The TACACS+ server and the switch must have the same:

- Encryption key
- Connection mode (single connection or per-session connection. Per-session is the same as multi-connection mode.)
- TCP port number

Procedure



1. In the navigation pane, expand the following folders: **Configuration > Security > Control Path**.
2. Click **TACACS+**.
3. Click the **TACACS+ Servers** tab.
4. Click **Insert**.
5. In the **AddressType** box, select **ipv4**.
6. In the **Address** field, type the IP address of the TACACS+ server.
7. **(Optional)** In the **PortNumber** field, type the TCP port on which the client establishes a connection to the TACACS+ server.
8. **(Optional)** In the **ConnectionType** box, select either **singleConnection** or **perSessionConnection** to specify the TCP connection type between the switch and TACACS+ server.
9. **(Optional)** In the **Timeout** field, type the period of time (in seconds) the switch waits for a response from the TACACS+ server.
10. In the **Key** field, enter the key that the switch and the TACACS+ server share.
11. **(Optional)** Select **SourceIPInterfaceEnabled**, if you want to enable the switch to designate a fixed source IP address for all outgoing TACACS+ packets.
12. In the **SourceIPInterfaceType** box, select **ipv4**.
13. **(Optional)** In the **SourceIPInterface** field, type a fixed source IP address if you want to designate a fixed source IP address for all outgoing TACACS+ packets.
14. In the **Priority** box, select either **primary** or **backup** to determine the order the switch uses the TACACS+ servers.
15. Click **Insert**.

TACACS+ Servers field descriptions

Use the data in the following table to use the **TACACS+ Servers** tab.

Name	Description
AddressType	Specifies the type of IP address to use on the TACACS+ server. You must set the value to IPv4.
Address	Specifies the IP address of the TACACS+ server.
PortNumber	<p>Configures the TCP port on which the client establishes a connection to the server. The default is 49. A value of 0 indicates that the system specified default value is used.</p> <p>You must configure the same TCP port for the TACACS+ server and the switch.</p>
ConnectionType	<p>Specifies if the TCP connection between the device and the TACACS+ server is a single connection. If you specify the single connection parameter, the connection between the switch and the TACACS+ daemon remains open, which is more efficient because it allows the daemon to handle a higher number of TACACS+ operations. The single-connection session is torn down if TACACS+ is disabled due to inactivity.</p> <p>If you do not configure this parameter, the switch uses the default connection type, which is the multi-connection. With the multi-connection, the connection opens and closes each time the switch and TACACS+ daemon communicate.</p> <p>* Note:</p> <p>You must configure the same connection mode for the TACACS+ server and the switch.</p> <p>To enable single-connection, the TACACS+ daemon has to support this mode as well.</p>
ConnectionStatus	Specifies if the TCP connection between the device and TACACS+ server is connected or not connected.
Timeout	Configures the maximum time, in seconds, to wait for this TACACS+ server to reply before it times out. The default value is 10 seconds.
Key	<p>Configures the authentication and encryption key for all TACACS+ communications between the device and the TACACS+ server. If the key length is zero, that indicates no encryption is used.</p> <p>You must configure the same encryption key for the TACACS+ server and the switch.</p>

Table continues...

Name	Description
SourceIpInterfaceEnabled	<p>Enables the source address specification. If SourceIpInterfaceEnabled is true (the check box is selected), and you change SourceIpInterfaceEnabled to false (the check box is cleared), the SourceIpInterface is reset to 0.0.0.0. The default is disabled.</p> <p>You must enable this parameter if you configure a valid source IP address</p>
SourceIpInterfaceType	<p>Specifies the type of IP address to use on the interface that connects to the TACACS+ server.</p> <p> Note: You must set the value to IPv4.</p>
SourceIpInterface	<p>Designates a fixed source IP address for all outgoing TACACS+ packets, which is useful if the router has many interfaces and you want to make sure all TACACS+ packets from a certain router have the same IP address.</p> <p>If you do not configure an address, the system uses 0.0.0.0 as the default.</p> <p>Only IPv4 addresses are valid.</p> <p> Note: If you configure a valid source IP address that is not 0.0.0.0 without enabling source-ip-interface, the source IP address returns to 0.0.0.0.</p>
Priority	<p>Determines the order in which the switch uses the TACACS+ servers, where 1 is the highest priority. The priority values are primary and backup.</p> <p>If more than one server shares the same priority, the device uses the servers in the order they exist in the table.</p>

Modifying a TACACS+ configuration

Modify an existing TACACS+ configuration to customize the server.

Procedure

1. In the navigation tree, expand the following folders: **Configuration > Security > Control Path**.
2. Click **TACACS+**.
3. Click **TACACS+ Servers** tab.

4. Double-click in the fields that you want to modify.

In some of the fields, the text becomes bold, which indicates that you can edit them. In other fields, a list appears.

5. In the fields that you can edit, type the desired values.
6. In the fields with lists, select the desired option.
7. Click **Apply**.

TACACS+ configuration examples

This section provides configuration examples to configure the switch and Identity Engines Ignition Server to use TACACS+.

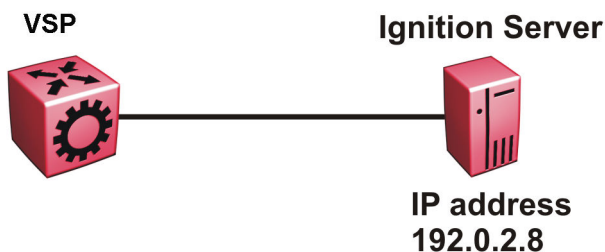

Figure 34: VSP switch connects to the Identity Engines Ignition Server

TACACS+ configuration on the switch

The following section shows the steps required to configure TACACS+ on the switch.

The example displays how to:

- Configure a key to be used by the TACACS+ server and the switch. In the example, the key is configured to the word `secret`.
- Configure an IP address for the TACACS+ server. In the example the IP address for the primary server is 192.0.2.8, which is accessible by the Management Router VRF.
- Configure the TACACS+ server to authenticate CLI sessions.
- Enable TACACS+.

Switch

```
TACACS CONFIGURATION
tacacs server host 192.0.2.8 key *****
tacacs protocol enable
```

```
tacacs accounting enable cli
tacacs authorization enable
tacacs authorization level 6
```

Verify your configuration

The `show tacacs` output must show as `global enable: true` to confirm TACACS is enabled.

The output for the `show tacacs` command must display the IP addresses for the TACACS+ Identity Engines Ignition Server. The IP addresses must be accessible to the Management Router VRF on the switch.

If you want to use the TACACS+ server to authenticate sessions in CLI, the output must display as `authentication enabled for: cli`. If you want to authenticate EDM sessions, the output must display as `authentication enabled for: web`.

Ensure the other parameters match what you have configured.

Global Status:

```
global enable : true
authentication enabled for : cli
accounting enabled for : cli
authorization : enabled
User privilege levels set for command authorization : rwa
```

Server:

```
create :
Prio      Status  Key      Port  IP address  Timeout  Single Source
SourceEnabled
Primary   Conn    *        49    192.0.2.8   10      false  0.0.0.0
false
```

Identity Engines Ignition Server TACACS+ configuration example

The following section shows the steps required to configure TACACS+ on Identity Engines Ignition Server, Release 8.0. Use the preceding information to configure the switch.

A TACACS+ server responds to and audits network access requests. In an installation, the Identity Engines Ignition Server is the TACACS+ server.

The example displays how to do the following:

- Enable TACACS+
- Configure a user
- Create a command set
- Configure the authentication protocol policy
- Create the authorization policy
- Configure TACACS+ authenticators

For more information on the Ignition Server, see *Identity Engines Ignition Server Administration*.

Before you begin

- Configure the Ignition Server appliance and set up its network settings. For more information, see *Identity Engines Ignition Server Getting Started*.
- Install the Ignition Dashboard on your Windows OS.
- Configure each authenticator (switch) to recognize the Ignition Server appliance as its TACACS+ server.
- Configure your switch to send packets to the Ignition Server appliance with the appropriate IP address and port.
- Ensure licenses are up-to-date.

Procedure

1. If the Ignition Server Dashboard is not connected to your Ignition Server, select **Administration: Login** to connect.
 - a. The default login credentials for **User Name** and **Password** are `admin/admin`. You are recommended to change the default values.
 - b. In the **Connect to** field enter the IP address of the Ignition Server for TACACS+. In this example, the IP address for the TACACS+ server is 192.0.2.8.
2. Enable TACACS+.
 - a. In the Ignition Server Dashboard, select **Site 0**.
 - b. In the Sites window, select the **Services** tab.
 - c. Under the Services tab, select the **TACACS+** tab.
 - d. Click the **Edit** button in the TACACS+ tab.
 - e. In the **Edit TACACS+ Configuration** dialog box, select the **Protocol is enabled** box.
 - f. In the **Bound Interface** field, select **Admin Port**.
 - g. In the **Port** field, enter 49.
 - h. Select **Accept Requests from Any Authenticator**.

Select this option if you want to create a global TACACS+ authenticator that sets policy for all authenticators that do not match a specific TACACS+-enabled authentication in your Ignition Server configuration.
 - i. In the **Access Policy** field, select **default-tacacs-admin**.

Use this configuration in the case of a global TACACS+ authenticator. Choose your global TACACS+ policy that you want applied if the device finds no better matching authenticator.
 - j. In **TACACS+ Shared Secret** field, enter the secret that the switch and TACACS+ Ignition Server share. In this example, the shared secret is `secret`.
 - k. Click **OK**.

3. Configure a user recognized by the TACACS + server.
 - a. In the Ignition Server Dashboard, expand the following in the Configuration tree: **Site Configuration > Directories > Internal Store > Internal Users**.
 - b. Click **New**.
 - c. Fill in the appropriate fields.
As an example:
User Name: jsmith
First Name: John
Last Name: Smith
Password: test
Confirm password: test
4. If your TACACS+ policy uses per-command authorization, create a command set.
 - a. In the Ignition Server Dashboard, expand the following in the Configuration tree: **Site Configuration > Access Policies > TACACS+**.
 - b. Click **Define Command Sets**.
 - c. Click **New**.
 - d. In the New Device Command Set window, type a **Name** and **Description** for the command set; for instance, level5.

In this window you build your command set by adding commands to the list. You can build the command list manually or you can import a list. For more information on importing a command list, see *Identity Engines Ignition Server Administration*.
 - e. To manually add the commands, click **Add** in the New/Edit Device Command Set window.
 - f. Click the **Simple Command Using Keywords and Arguments** box.
 - g. In the **Command** field, type the command, and optionally its arguments.
 - h. To allow the command to be used with any argument, select the **Allow** box.
 - i. To allow only the specific command and arguments you have types, tick the **Deny** box.
 - j. Click **OK** to add the command to the list.
 - k. Continue to add the commands that you want.
5. If your TACACS+ policy uses privilege-level authorization, create the TACACS+ access policy to allow the TACACS+ Ignition Server to communicate with the switch.
 - a. In the Ignition Server Dashboard, expand the following in the Configuration tree: **Site Configuration > Access Policies > TACACS+**.
 - b. Select **default-tacacs-admin**.
 - c. Click on the **Authorization Policy** tab and select the name of the policy you want to edit.

- d. Click **Edit** and the **Edit Authorization Policy** window appears.
- e. In the **Rules** section, select the rule you want to edit. In this case select `level5`, to which you have already added commands.

The **Rules** list at the left lets you browse and sort the rules in your policy. Use the up and down arrow buttons at the right to set the rule sequence, and click a rule name in the list to edit that rule. The Selected Rule Details section lets you edit the rule you have selected.
- f. In the Selected Rule Details section, under **Rule Name**, for this example, it reads `level5`.
- g. Select **Rule Enabled**.
- h. With `level5` selected in the Rules list, go to the buttons to the right of the **Constraint** list and click **New**.
- i. In the Action section, select **Allow**.
- j. Select the **Command Sets** tab, in the Action section. Allow Commands in Set should read `level-5`, in this example, and under All Command Sets all the commands that are accessible under `level5` should be listed.
- k. Click **OK**.

For this example to function properly, the summary window must display:

IF User: user-id = level5 THEN Allow

Permit commands in Command Set: level-5

6. Configure the Ignition Server to connect to authenticators, which is the switch:
 - a. In the Ignition Server Dashboard, expand the following folders: **Site Configuration > Authenticators > default** and the Authenticator Summary window appears.
 - b. Click **New**, and the Authenticator Details window appears.
 - c. For this example, type `VSPswitch` under name.
 - d. To the right select **Enable Authenticator**.
 - e. Type the IP address for the switch, which is the authenticator. Use the primary CPU address or the management virtual address.
 - f. In the **Vendor** field, select **Nortel**.
 - g. In the **Device template** field, select **ers-switches-nortel**.
 - h. Select the **TACACS+ Settings** tab.
 - i. Select **Enable TACACS+ Access**.
 - j. In the **TACACS+ Shared Secret** field, type the key value you entered into the switch. In this example, the key is the word `secret`.

To connect using TACACS+, you must use the shared secret for each device. In your switch documentation, the shared secret can also be referred to as a specific key string or an encryption string.

TACACS+

- k. Under **Access Policy**, select **default-tacacs-user**.
- l. Click **OK**.

Glossary

American Standard Code for Information Interchange (ASCII)	A code to represent characters in computers. ASCII uses uppercase and lowercase alphabetic letters, numeric digits, and special symbols.
authentication server	A RADIUS server that provides authorization services to the authenticator, which is software that authorizes or rejects a supplicant attached to the other end of the LAN segment.
Authentication, Authorization, and Accounting (AAA)	Authentication, Authorization, and Accounting (AAA) is a framework used to control access to a network, limit network services to certain users, and track what users do. Authentication determines who a user is before allowing the user to access the network and network services. Authorization allows you to determine what you allow a user to do. Accounting records what a user is doing or has done.
Challenge Handshake Authentication Protocol (CHAP)	An access protocol that exchanges a random value between the server and the client and is encrypted with a challenge password.
controlled port	In relation to EAPoL, any port on the device with EAPoL enabled.
daemon/server	A daemon is a program that services network requests for authentication and authorization, verifies identities, grants or denies authorizations, and logs accounting records.
Data Encryption Standard (DES)access control entry (ACE)	A cryptographic algorithm that protects unclassified computer data. The National Institute of Standards and Technology publishes the DES in the Federal Information Processing Standard Publication 46-1.
Global routing engine (GRE)	The base router or routing instance 0 in the Virtual Routing and Forwarding (VRF).
Institute of Electrical and Electronics Engineers (IEEE)	An international professional society that issues standards and is a member of the American National Standards Institute, the International Standards Institute, and the International Standards Organization.

Internet Engineering Task Force (IETF)	A standards organization for IP data networks.
Layer 2	Layer 2 is the Data Link Layer of the OSI model. Examples of Layer 2 protocols are Ethernet and Frame Relay.
Layer 3	Layer 3 is the Network Layer of the OSI model. An example of a Layer 3 protocol is Internet Protocol (IP).
Local Area Network (LAN)	A data communications system that lies within a limited spatial area, uses a specific user group and topology, and can connect to a public switched telecommunications network (but is not one).
management information base (MIB)	The MIB defines system operations and parameters used for the Simple Network Management Protocol (SNMP).
mask	A bit string that the device uses along with an IP address to indicate the number of leading bits in the address that correspond with the network part.
Media Access Control (MAC)	Arbitrates access to and from a shared medium.
Message Digest 5 (MD5)	A one-way hash function that creates a message digest for digital signatures.
MultiLink Trunking (MLT)	A method of link aggregation that uses multiple Ethernet trunks aggregated to provide a single logical trunk. A multilink trunk provides the combined bandwidth of multiple links and the physical layer protection against the failure of a single link.
network access server (NAS)	A network access server (NAS) is a single point of access to a remote device. The NAS acts as a gateway to guard the remote device. A client connects to the NAS and then the NAS connects to another device to verify the credentials of the client. Once verified the NAS allows or disallows access to the device. Network access servers are almost exclusively used with Authentication, Authorization, and Accounting (AAA) servers.
next hop	The next hop to which a packet can be sent to advance the packet to the destination.
Point-to-Point Protocol (PPP)	Point-to-Point Protocol is a basic protocol at the data link layer that provides its own authentication protocols, with no authorization stage. PPP is often used to form a direct connection between two networking nodes.
port	A physical interface that transmits and receives data.

Port Access Entity (PAE)	Software that controls each port on the switch. The PAE, which resides on the device, supports authenticator functionality. The PAE works with the Extensible Authentication Protocol over LAN (EAPoL).
Protocol Data Units (PDUs)	A unit of data that is specified in a protocol of a specific layer and that consists of protocol-control information of the specific layer and possibly user data of that layer.
quality of service (QoS)	QoS features reserve resources in a congested network, allowing you to configure a higher priority for certain devices. For example, you can configure a higher priority for IP deskphones, which need a fixed bit rate and split the remaining bandwidth between data connections if calls in the network are more important than the file transfers.
Read Write All (RWA)	An access class that lets users access all menu items and editable fields.
remote login (rlogin)	An application that provides a terminal interface between hosts (usually UNIX) that use the TCP/IP network protocol. Unlike Telnet, rlogin assumes the remote host is, or behaves like, a UNIX host.
Routing Information Protocol (RIP)	A distance vector protocol in the IP suite, used by IP network-layer protocol, that enables routers in the same AS to exchange routing information by means of periodic updates. You often use RIP as a very simple interior gateway protocol (IGP) within small networks.
Secure Copy (SCP)	Secure Copy securely transfers files between the switch and a remote station.
Simple Network Management Protocol (SNMP)	SNMP administratively monitors network performance through agents and management stations.
supplicant	A device, such as a PC, that applies for access to the network.
User Datagram Protocol (UDP)	In TCP/IP, a packet-level protocol built directly on the Internet Protocol layer. TCP/IP host systems use UDP for application-to-application programs.
user-based policies (UBP)	Establishes and enforces roles and conditions on an individual user basis for access ports in the network.
view-based access control model (VACM)	Provides context, group access, and group security levels based on a predefined subset of management information base (MIB) objects.
virtual router forwarding (VRF)	Provides traffic isolation between customers operating over the same node. Each virtual router emulates the behavior of a dedicated hardware router by providing separate routing functionality, and the network treats each VRF as a separate physical router.