



Configuring IPv6 Routing on VSP Operating System Software

Release 6.2 (VSP 8600)
9035578
September 2018

© 2017-2018, Extreme Networks, Inc.
All Rights Reserved.

Notice

While reasonable efforts have been made to ensure that the information in this document is complete and accurate at the time of printing, Extreme Networks, Inc. assumes no liability for any errors. Extreme Networks, Inc. reserves the right to make changes and corrections to the information in this document without the obligation to notify any person or organization of such changes.

Documentation disclaimer

"Documentation" means information published in varying mediums which may include product information, operating instructions and performance specifications that are generally made available to users of products. Documentation does not include marketing materials. Extreme Networks shall not be responsible for any modifications, additions, or deletions to the original published version of Documentation unless such modifications, additions, or deletions were performed by or on the express behalf of Extreme Networks. End User agrees to indemnify and hold harmless Extreme Networks, Extreme Networks' agents, servants and employees against all claims, lawsuits, demands and judgments arising out of, or in connection with, subsequent modifications, additions or deletions to this documentation, to the extent made by End User.

Link disclaimer

Extreme Networks is not responsible for the contents or reliability of any linked websites referenced within this site or Documentation provided by Extreme Networks. Extreme Networks is not responsible for the accuracy of any information, statement or content provided on these sites and does not necessarily endorse the products, services, or information described or offered within them. Extreme Networks does not guarantee that these links will work all the time and has no control over the availability of the linked pages.

Warranty

Extreme Networks provides a limited warranty on Extreme Networks hardware and software. Refer to your sales agreement to establish the terms of the limited warranty. In addition, Extreme Networks' standard warranty language, as well as information regarding support for this product while under warranty is available to Extreme Networks customers and other parties through the Extreme Networks Support website: www.extremenetworks.com/support/ under the link "Policies" or such successor site as designated by Extreme Networks. Please note that if You acquired the product(s) from an authorized Extreme Networks Channel Partner outside of the United States and Canada, the warranty is provided to You by said Extreme Networks Channel Partner and not by Extreme Networks.

"Hosted Service" means an Extreme Networks hosted service subscription that You acquire from either Extreme Networks or an authorized Extreme Networks Channel Partner (as applicable) and which is described further in Hosted SAS or other service description documentation regarding the applicable hosted service. If You purchase a Hosted Service subscription, the foregoing limited warranty may not apply but You may be entitled to support services in connection with the Hosted Service as described further in your service description documents for the applicable Hosted Service. Contact Extreme Networks or Extreme Networks Channel Partner (as applicable) for more information.

Hosted Service

THE FOLLOWING APPLIES ONLY IF YOU PURCHASE AN EXTREME NETWORKS HOSTED SERVICE SUBSCRIPTION FROM EXTREME NETWORKS OR AN EXTREME NETWORKS CHANNEL PARTNER (AS APPLICABLE), THE TERMS OF USE FOR HOSTED SERVICES ARE AVAILABLE ON THE EXTREME NETWORKS WEBSITE, <https://extremeportal.force.com/> OR SUCH SUCCESSOR SITE AS DESIGNATED BY EXTREME NETWORKS, AND ARE APPLICABLE TO ANYONE WHO ACCESSES OR USES THE HOSTED SERVICE. BY ACCESSING OR USING THE HOSTED SERVICE, OR AUTHORIZING OTHERS TO DO SO, YOU, ON BEHALF OF YOURSELF AND THE ENTITY FOR WHOM YOU ARE DOING SO (HEREINAFTER REFERRED TO INTERCHANGEABLY AS "YOU" AND "END USER"), AGREE TO THE TERMS OF USE. IF YOU ARE ACCEPTING THE TERMS OF USE ON BEHALF A COMPANY OR OTHER LEGAL ENTITY, YOU

REPRESENT THAT YOU HAVE THE AUTHORITY TO BIND SUCH ENTITY TO THESE TERMS OF USE. IF YOU DO NOT HAVE SUCH AUTHORITY, OR IF YOU DO NOT WISH TO ACCEPT THESE TERMS OF USE, YOU MUST NOT ACCESS OR USE THE HOSTED SERVICE OR AUTHORIZE ANYONE TO ACCESS OR USE THE HOSTED SERVICE.

Licenses

THE SOFTWARE LICENSE TERMS AVAILABLE ON THE EXTREME NETWORKS WEBSITE, <https://extremeportal.force.com/> OR SUCH SUCCESSOR SITE AS DESIGNATED BY EXTREME NETWORKS, ARE APPLICABLE TO ANYONE WHO DOWNLOADS, USES AND/OR INSTALLS EXTREME NETWORKS SOFTWARE, PURCHASED FROM EXTREME NETWORKS, INC., ANY EXTREME NETWORKS AFFILIATE, OR AN EXTREME NETWORKS CHANNEL PARTNER (AS APPLICABLE) UNDER A COMMERCIAL AGREEMENT WITH EXTREME NETWORKS OR AN EXTREME NETWORKS CHANNEL PARTNER. UNLESS OTHERWISE AGREED TO BY EXTREME NETWORKS IN WRITING, EXTREME NETWORKS DOES NOT EXTEND THIS LICENSE IF THE SOFTWARE WAS OBTAINED FROM ANYONE OTHER THAN EXTREME NETWORKS, AN EXTREME NETWORKS AFFILIATE OR AN EXTREME NETWORKS CHANNEL PARTNER; EXTREME NETWORKS RESERVES THE RIGHT TO TAKE LEGAL ACTION AGAINST YOU AND ANYONE ELSE USING OR SELLING THE SOFTWARE WITHOUT A LICENSE. BY INSTALLING, DOWNLOADING OR USING THE SOFTWARE, OR AUTHORIZING OTHERS TO DO SO, YOU, ON BEHALF OF YOURSELF AND THE ENTITY FOR WHOM YOU ARE INSTALLING, DOWNLOADING OR USING THE SOFTWARE (HEREINAFTER REFERRED TO INTERCHANGEABLY AS "YOU" AND "END USER"), AGREE TO THESE TERMS AND CONDITIONS AND CREATE A BINDING CONTRACT BETWEEN YOU AND EXTREME NETWORKS, INC. OR THE APPLICABLE EXTREME NETWORKS AFFILIATE ("EXTREME NETWORKS").

Extreme Networks grants You a license within the scope of the license types described below. Where the order documentation does not expressly identify a license type, the applicable license will be a Designated System License as set forth below in the Designated System(s) License (DS) section as applicable. The applicable number of licenses and units of capacity for which the license is granted will be one (1), unless a different number of licenses or units of capacity is specified in the documentation or other materials available to You. "Software" means computer programs in object code, provided by Extreme Networks or an Extreme Networks Channel Partner, whether as stand-alone products, pre-installed on hardware products, and any upgrades, updates, patches, bug fixes, or modified versions thereto. "Designated Processor" means a single stand-alone computing device. "Server" means a set of Designated Processors that hosts (physically or virtually) a software application to be accessed by multiple users. "Instance" means a single copy of the Software executing at a particular time: (i) on one physical machine; or (ii) on one deployed software virtual machine ("VM") or similar deployment.

License type(s)

Designated System(s) License (DS). End User may install and use each copy or an Instance of the Software only: 1) on a number of Designated Processors up to the number indicated in the order; or 2) up to the number of Instances of the Software as indicated in the order, Documentation, or as authorized by Extreme Networks in writing. Extreme Networks may require the Designated Processor(s) to be identified in the order by type, serial number, feature key, Instance, location or other specific designation, or to be provided by End User to Extreme Networks through electronic means established by Extreme Networks specifically for this purpose.

Copyright

Except where expressly stated otherwise, no use should be made of materials on this site, the Documentation, Software, Hosted Service, or hardware provided by Extreme Networks. All content on this site, the documentation, Hosted Service, and the product provided by Extreme Networks including the selection, arrangement and design of the content is owned either by Extreme Networks or its licensors and is protected by copyright and other intellectual property laws including the sui generis rights relating to the protection of databases. You may not modify, copy, reproduce, republish, upload, post, transmit or distribute in any way any content, in whole or in part,

including any code and software unless expressly authorized by Extreme Networks. Unauthorized reproduction, transmission, dissemination, storage, and or use without the express written consent of Extreme Networks can be a criminal, as well as a civil offense under the applicable law.

Virtualization

The following applies if the product is deployed on a virtual machine. Each product has its own ordering code and license types. Note, unless otherwise stated, that each Instance of a product must be separately licensed and ordered. For example, if the end user customer or Extreme Networks Channel Partner would like to install two Instances of the same type of products, then two products of that type must be ordered.

Third Party Components

"Third Party Components" mean certain software programs or portions thereof included in the Software or Hosted Service may contain software (including open source software) distributed under third party agreements ("Third Party Components"), which contain terms regarding the rights to use certain portions of the Software ("Third Party Terms"). As required, information regarding distributed Linux OS source code (for those products that have distributed Linux OS source code) and identifying the copyright holders of the Third Party Components and the Third Party Terms that apply is available in the products, Documentation or on Extreme Networks' website at: <https://extremeportal.force.com/ExtrLicenseLanding> or such successor site as designated by Extreme Networks. The open source software license terms provided as Third Party Terms are consistent with the license rights granted in these Software License Terms, and may contain additional rights benefiting You, such as modification and distribution of the open source software. The Third Party Terms shall take precedence over these Software License Terms, solely with respect to the applicable Third Party Components to the extent that these Software License Terms impose greater restrictions on You than the applicable Third Party Terms.

The following applies only if the H.264 (AVC) codec is distributed with the product. THIS PRODUCT IS LICENSED UNDER THE AVC PATENT PORTFOLIO LICENSE FOR THE PERSONAL USE OF A CONSUMER OR OTHER USES IN WHICH IT DOES NOT RECEIVE REMUNERATION TO (i) ENCODE VIDEO IN COMPLIANCE WITH THE AVC STANDARD ("AVC VIDEO") AND/OR (ii) DECODE AVC VIDEO THAT WAS ENCODED BY A CONSUMER ENGAGED IN A PERSONAL ACTIVITY AND/OR WAS OBTAINED FROM A VIDEO PROVIDER LICENSED TO PROVIDE AVC VIDEO. NO LICENSE IS GRANTED OR SHALL BE IMPLIED FOR ANY OTHER USE. ADDITIONAL INFORMATION MAY BE OBTAINED FROM MPEG LA, L.L.C. SEE [HTTP://WWW.MPEGLA.COM](http://WWW.MPEGLA.COM).

Service Provider

THE FOLLOWING APPLIES TO EXTREME NETWORKS CHANNEL PARTNER'S HOSTING OF EXTREME NETWORKS PRODUCTS OR SERVICES. THE PRODUCT OR HOSTED SERVICE MAY USE THIRD PARTY COMPONENTS SUBJECT TO THIRD PARTY TERMS AND REQUIRE A SERVICE PROVIDER TO BE INDEPENDENTLY LICENSED DIRECTLY FROM THE THIRD PARTY SUPPLIER. AN EXTREME NETWORKS CHANNEL PARTNER'S HOSTING OF EXTREME NETWORKS PRODUCTS MUST BE AUTHORIZED IN WRITING BY EXTREME NETWORKS AND IF THOSE HOSTED PRODUCTS USE OR EMBED CERTAIN THIRD PARTY SOFTWARE, INCLUDING BUT NOT LIMITED TO MICROSOFT SOFTWARE OR CODECS, THE EXTREME NETWORKS CHANNEL PARTNER IS REQUIRED TO INDEPENDENTLY OBTAIN ANY APPLICABLE LICENSE AGREEMENTS, AT THE EXTREME NETWORKS CHANNEL PARTNER'S EXPENSE, DIRECTLY FROM THE APPLICABLE THIRD PARTY SUPPLIER.

WITH RESPECT TO CODECS, IF THE EXTREME NETWORKS CHANNEL PARTNER IS HOSTING ANY PRODUCTS THAT USE OR EMBED THE G.729 CODEC, H.264 CODEC, OR H.265 CODEC, THE EXTREME NETWORKS CHANNEL PARTNER ACKNOWLEDGES AND AGREES THE EXTREME NETWORKS CHANNEL PARTNER IS RESPONSIBLE FOR ANY AND ALL RELATED FEES AND/OR ROYALTIES. THE G.729 CODEC IS LICENSED BY SIPRO LAB TELECOM INC. SEE WWW.SIPRO.COM/CONTACT.HTML. THE H.264 (AVC) CODEC IS LICENSED UNDER THE AVC PATENT PORTFOLIO LICENSE FOR

THE PERSONAL USE OF A CONSUMER OR OTHER USES IN WHICH IT DOES NOT RECEIVE REMUNERATION TO: (I) ENCODE VIDEO IN COMPLIANCE WITH THE AVC STANDARD ("AVC VIDEO") AND/OR (II) DECODE AVC VIDEO THAT WAS ENCODED BY A CONSUMER ENGAGED IN A PERSONAL ACTIVITY AND/OR WAS OBTAINED FROM A VIDEO PROVIDER LICENSED TO PROVIDE AVC VIDEO. NO LICENSE IS GRANTED OR SHALL BE IMPLIED FOR ANY OTHER USE. ADDITIONAL INFORMATION FOR H.264 (AVC) AND H.265 (HEVC) CODECS MAY BE OBTAINED FROM MPEG LA, L.L.C. SEE [HTTP://WWW.MPEGLA.COM](http://WWW.MPEGLA.COM).

Compliance with Laws

You acknowledge and agree that it is Your responsibility for complying with any applicable laws and regulations, including, but not limited to laws and regulations related to call recording, data privacy, intellectual property, trade secret, fraud, and music performance rights, in the country or territory where the Extreme Networks product is used.

Preventing Toll Fraud

"Toll Fraud" is the unauthorized use of your telecommunications system by an unauthorized party (for example, a person who is not a corporate employee, agent, subcontractor, or is not working on your company's behalf). Be aware that there can be a risk of Toll Fraud associated with your system and that, if Toll Fraud occurs, it can result in substantial additional charges for your telecommunications services.

Security Vulnerabilities

Information about Extreme Networks' security support policies can be found in the Global Technical Assistance Center Knowledgebase at <https://gtacknowledge.extremenetworks.com/>.

Downloading Documentation

For the most current versions of Documentation, see the Extreme Networks Support website: www.extremenetworks.com/documentation/, or such successor site as designated by Extreme Networks.

Contact Extreme Networks Support

See the Extreme Networks Support website: www.extremenetworks.com/support/ for product or Hosted Service notices and articles, or to report a problem with your Extreme Networks product or Hosted Service. For the support phone number in your country, visit: www.extremenetworks.com/support/contact (or such successor site as designated by Extreme Networks), scroll to the bottom of the page, and select Contact Extreme Networks Support.

Trademarks

The trademarks, logos and service marks ("Marks") displayed in this site, the Documentation, Hosted Service(s), and product(s) provided by Extreme Networks are the registered or unregistered Marks of Extreme Networks, Inc., its affiliates, its licensors, its suppliers, or other third parties. Users are not permitted to use such Marks without prior written consent from Extreme Networks or such third party which may own the Mark. Nothing contained in this site, the Documentation, Hosted Service(s) and product(s) should be construed as granting, by implication, estoppel, or otherwise, any license or right in and to the Marks without the express written permission of Extreme Networks or the applicable third party.

Extreme Networks is a registered trademark of Extreme Networks, Inc.

All non-Extreme Networks trademarks are the property of their respective owners. Linux[®] is the registered trademark of Linus Torvalds in the U.S. and other countries.

For additional information on Extreme Networks trademarks, please see: www.extremenetworks.com/company/legal/

Contents

Chapter 1: Preface	10
Purpose.....	10
Training.....	10
Providing Feedback to Us.....	11
Getting Help.....	11
Documentation and Training.....	12
Subscribing to Service Notifications.....	13
Chapter 2: New in this Document	14
Notice about Feature Support.....	15
Chapter 3: IPv6 basics	16
Origins of IPv6.....	16
Advantages of IPv6.....	16
Comparison of IPv4 and IPv6.....	17
IPv6 packet.....	18
IPv6 header.....	18
IPv6 extension headers.....	19
IPv6 address component summary.....	21
IPv6 address formats.....	22
Address types.....	22
IP address prefix.....	27
Interface ID.....	27
How to write an IPv6 address	28
ICMPv6.....	28
Path MTU discovery.....	29
Routing.....	30
Route scaling.....	34
IPv6 Circuitless IP.....	34
Equal Cost Multipath.....	35
ECMP with static routes.....	36
Disable IPv6 ICMP multicast.....	36
IPv6 basic configuration using the CLI.....	37
Enabling the IPv6-mode boot config flag.....	37
Configuring an IPv6 static neighbor address.....	37
Configuring an IPv6 interface	40
Assigning IPv6 addresses to a brouter port or VLAN.....	44
Configuring IPv6 route preferences.....	45
Viewing global IPv6 information.....	47
Creating IPv6 static routes.....	52
Viewing routes information.....	53

Creating an IPv6 CLIP interface.....	56
Enabling IPv6 ECMP.....	56
Configuring maximum number of ECMP paths	57
Enabling or disabling IPv6 ICMP multicast.....	58
Enabling Stateless Address Autoconfiguration.....	59
Configuring route advertisement on the management port.....	60
Configuring process-redirect for management port.....	61
Viewing IPv6 default routers.....	62
IPv6 basic configuration using EDM.....	63
Enabling the IPv6-mode boot config flag.....	63
Configuring IPv6 globally.....	64
Configuring an IPv6 interface.....	66
Configuring an IPv6 brouter port interface.....	68
Configuring an IPv6 VLAN interface.....	70
Assigning IPv6 addresses to interfaces.....	72
Assigning IPv6 addresses to a brouter port interface.....	74
Assigning an IPv6 address to a VLAN.....	76
Creating IPv6 static routes.....	77
Configuring IPv6 route preferences.....	79
Viewing route information.....	79
Viewing IPv6 Default Routers.....	80
Configuring a Circuitless IPv6 interface.....	81
Chapter 4: Neighbor discovery.....	83
Neighbor discovery.....	83
Host autoconfiguration.....	87
Neighbor discovery configuration using the CLI.....	88
Configuring an IPv6 discovery prefix.....	88
Configuring route advertisement.....	91
Configuring the neighbor cache.....	96
Viewing cached destination information.....	97
Neighbor discovery configuration using EDM.....	99
Configuring an IPv6 discovery prefix.....	99
Configuring an IPv6 discovery prefix port.....	102
Configuring an IPv6 discovery prefix on a VLAN.....	104
Configuring route advertisement.....	106
Configuring route advertisement on an IPv6 interface for a brouter port.....	108
Configuring route advertisement on an IPv6 interface for a VLAN.....	110
Configuring the neighbor cache.....	112
Viewing cached destination information.....	114
Chapter 5: DHCP Relay.....	115
DHCP Relay.....	115
DHCP Relay Network Topology and Workflow.....	116
DHCP Relay configuration using the CLI.....	117

Configuring a DHCP Relay forwarding path.....	117
Configuring DHCP Relay for an interface.....	119
Viewing DHCP Relay information.....	121
DHCP Relay configuration using EDM.....	122
Configuring a DHCP Relay forwarding path.....	122
Configuring DHCP Relay for an interface.....	123
Modifying DHCP Relay for a VLAN.....	124
Modifying DHCP Relay for a port.....	125
Chapter 6: Tunneling	127
Tunneling.....	127
Tunneling configuration using the CLI.....	129
Configuring a tunnel.....	129
Viewing tunnel interfaces.....	130
Modifying tunnel hop limits.....	131
Tunnel configuration using EDM.....	132
Configuring a tunnel.....	132
Modifying tunnel hop limits.....	133
Modifying tunnel hop limits for a specific tunnel.....	134
Viewing IPv6 addresses on a tunnel.....	136
Chapter 7: OSPFv3	138
OSPFv3.....	138
IPsec support with OSPFv3.....	141
OSPF Graceful Restart.....	142
Helper mode.....	142
ECMP with OSPFv3.....	143
OSPFv3 configuration using the CLI.....	144
Configuring OSPF globally.....	144
Creating an OSPF area.....	145
Creating OSPF area ranges.....	147
Creating an OSPF virtual link.....	148
Configuring IPsec for the OSPF virtual link.....	150
Configuring OSPF default metrics.....	151
Configuring OSPF on a port or VLAN.....	153
Configuring OSPF on a tunnel.....	157
Viewing OSPFv3 information.....	159
Viewing OSPFv3 default cost information.....	163
Adding an NBMA neighbor.....	164
Configuring link LSA suppression.....	165
Enabling OSPF route redistribution.....	166
Viewing the status of OSPFv3 redistribution.....	167
Disabling Helper mode for OSPFv3.....	167
OSPFv3 configuration using EDM.....	168
Configuring OSPF globally.....	168

Creating an OSPF area.....	170
Creating OSPF area ranges.....	172
Creating an OSPF virtual link.....	173
Configuring IPsec for the OSPF virtual link.....	175
Creating an OSPF interface on a brouter port.....	176
Creating an OSPF VLAN interface.....	179
Creating an OSPF interface on a tunnel.....	181
Viewing the AS-scope link-state database.....	183
Viewing the area-scope LSDB.....	184
Viewing the link-scope LSDB.....	185
Adding an NBMA neighbor.....	186
Enabling OSPF route redistribution.....	188
Modifying an OSPF interface.....	189
Viewing OSPF neighbors.....	191
Viewing virtual neighbors.....	192
Chapter 8: RIPng.....	194
RIPng fundamentals.....	194
RIPng configuration using the CLI.....	196
Configuring RIPng globally.....	196
Configuring RIPng on an interface.....	196
Configuring RIPng custom values	198
Configuring RIPng route distribution.....	200
RIPng Configuration using EDM.....	201
Configuring RIPng globally.....	201
Configuring an IPv6 RIPng interface.....	202
Configuring an IPv6 RIPng VLAN interface.....	203
Configuring an IPv6 RIPng brouter port interface.....	205
Graphing IPv6 RIPng statistics.....	206
Configuring route redistribution to RIPng.....	206
Viewing stats for RIPng interfaces.....	207
Chapter 9: VRRP	209
VRRP.....	209
VRRPv3.....	213
VRRPv3 guidelines.....	214
VRRP configuration using the CLI.....	215
Configuring the VRRP interface.....	215
Viewing VRRP information.....	217
Configuring VRRP notification control.....	220
Configuring additional VRRP parameters for an interface.....	220
Enabling IPv6 VRRP preempt-mode.....	223
VRRP configuration using EDM.....	224
Configuring VRRP for an interface.....	224
Configuring VRRP notification control.....	227

Configuring additional addresses on the VRRP brouter port.....	227
Configuring additional addresses on the VRRP interface.....	228
Chapter 10: RSMLT	230
RSMLT.....	230
RSMLT configuration using the CLI.....	231
Configuring RSMLT on a VLAN.....	231
Enabling RSMLT Edge support.....	233
Viewing RSMLT information.....	233
RSMLT configuration using EDM.....	235
Configuring RSMLT on a VLAN.....	235
Enabling RSMLT Edge support.....	236
Modifying the RSMLT local information.....	237
Modifying RSMLT peer information.....	238
Viewing RSMLT Edge peers.....	239
Chapter 11: Viewing IPv6 connections	240
Viewing IPv6 connections using CLI.....	240
Viewing TCP and UDP information.....	240
Viewing IPv6 connections using EDM.....	242
Viewing TCP global information.....	242
Viewing TCP connections information.....	243
Viewing TCP listeners information.....	244
Viewing UDP endpoint information.....	245
Chapter 12: IPv6 Alternative Routes	247
Alternative routes.....	247
Configuring IPv6 alternative routes.....	248
Chapter 13: IPv6 configuration examples	251
IPv6 tunnels.....	251
OSPFv3.....	255
IPv6 alternative routes configuration example.....	256
Chapter 14: VRF Lite	268
VRF Lite fundamentals.....	268
Overview.....	268
Management VRF.....	270
VRF Lite configuration rules.....	272
Virtualized protocols.....	273
VRF Lite configuration using CLI.....	274
Creating a VRF instance.....	274
Creating an IPv6 VPN instance.....	276
Enabling IPv6 trap notifications.....	278
Displaying IPv6 max-routes information.....	279
VRF Lite configuration using EDM.....	279
Configuring a VRF instance.....	279
Selecting and launching a VRF context view	280

Creating an IPv6 VPN instance on a VRF.....	281
Appendix A: ICMPv6 type and code.....	283
Glossary.....	285

Chapter 1: Preface

Purpose

This document provides information on features in VSP Operating System Software (VOSS). VOSS runs on the following product families:

- Extreme Networks Virtual Services Platform 4000 Series
- Extreme Networks Virtual Services Platform 7200 Series
- Extreme Networks Virtual Services Platform 8000 Series (includes VSP 8200 and VSP 8400 Series)
- Extreme Networks Virtual Services Platform 8600

This document provides conceptual and procedural information to configure IPv6 routing operations. Included in this document are Operations, Administration, and Management (OA&M), DHCP Relay, Virtual Router Redundancy Protocol (VRRP), static routes, Open Shortest Path First version 3 (OSPFv3), IPv6 tunnels, and Routed Split MultiLink Trunking (RSMLT).

Note:

The software does not support IPv4-mapped IPv6 addresses, for example, 0::FFFF:a.b.c.d, or IPv4-compatible IPv6 addresses, for example, 0::a.b.c.d.

Examples and network illustrations in this document may illustrate only one of the supported platforms. Unless otherwise noted, the concept illustrated applies to all supported platforms.

IPv6 uses the following key security features: SNMP version 3 (SNMPv3) and Secure Shell (SSH).

For detailed information about SNMPv3, see *Configuring Security*.

For detailed information about SSH, see *Administering*.

For information about IPv6 prefix lists for route policies, see *Configuring IPv4 Routing*.

For information about IPv6 shortcuts and IPv6 Inter-VSN routing, see *Configuring Fabric Basics and Layer 2 Services*.

Training

Ongoing product training is available. For more information or to register, you can access the Web site at www.extremenetworks.com/education/.

Providing Feedback to Us

Quality is our first concern at Extreme Networks, and we have made every effort to ensure the accuracy and completeness of this document. We are always striving to improve our documentation and help you work better, so we want to hear from you! We welcome all feedback but especially want to know about:

- Content errors or confusing or conflicting information.
- Ideas for improvements to our documentation so you can find the information you need faster.
- Broken links or usability issues.

If you would like to provide feedback to the Extreme Networks Information Development team, you can do so in two ways:

- Use our short online feedback form at <https://www.extremenetworks.com/documentation-feedback/>.
- Email us at documentation@extremenetworks.com.

Please provide the publication title, part number, and as much detail as possible, including the topic heading and page number if applicable, as well as your suggestions for improvement.

Getting Help

If you require assistance, contact Extreme Networks using one of the following methods:

- **GTAC (Global Technical Assistance Center) for Immediate Support**
 - **Phone:** 1-800-998-2408 (toll-free in U.S. and Canada) or +1 408-579-2826. For the support phone number in your country, visit: www.extremenetworks.com/support/contact
 - **Email:** support@extremenetworks.com. To expedite your message, enter the product name or model number in the subject line.
- **Extreme Portal** — Search the GTAC knowledge base, manage support cases and service contracts, download software, and obtain product licensing, training, and certifications.
- **The Hub** — A forum for Extreme Networks customers to connect with one another, answer questions, and share ideas and feedback. This community is monitored by Extreme Networks employees, but is not intended to replace specific guidance from GTAC.

Before contacting Extreme Networks for technical support, have the following information ready:

- Your Extreme Networks service contract number and/or serial numbers for all involved Extreme Networks products
- A description of the failure
- A description of any action(s) already taken to resolve the problem

- A description of your network environment (such as layout, cable type, other relevant environmental information)
- Network load at the time of trouble (if known)
- The device history (for example, if you have returned the device before, or if this is a recurring problem)
- Any related RMA (Return Material Authorization) numbers

Subscribing to Service Notifications

You can subscribe to email notifications for product and software release announcements, Vulnerability Notices, and Service Notifications.

1. Go to www.extremenetworks.com/support/service-notification-form.
2. Complete the form with your information (all fields are required).
3. Select the products for which you would like to receive notifications.



Note:

You can modify your product selections or unsubscribe at any time.

4. Click **Submit**.

Documentation and Training

To find Extreme Networks product guides, visit our documentation pages at:

Current Product Documentation	www.extremenetworks.com/documentation/
Archived Documentation (for earlier versions and legacy products)	www.extremenetworks.com/support/documentation-archives/
Release Notes	www.extremenetworks.com/support/release-notes
Hardware/Software Compatibility Matrices	https://www.extremenetworks.com/support/compatibility-matrices/
White papers, data sheets, case studies, and other product resources	https://www.extremenetworks.com/resources/

Open Source Declarations

Some software files have been licensed under certain open source licenses. More information is available at: www.extremenetworks.com/support/policies/open-source-declaration/.

Training

Extreme Networks offers product training courses, both online and in person, as well as specialized certifications. For more information, visit www.extremenetworks.com/education/.

Subscribing to Service Notifications

Subscribe to receive an email notification for product and software release announcements, Vulnerability Notices, and Service Notifications.

About this task

You can modify your product selections at any time.

Procedure

1. In an Internet browser, go to <http://www.extremenetworks.com/support/service-notification-form/>.
2. Type your first and last name.
3. Type the name of your company.
4. Type your email address.
5. Type your job title.
6. Select the industry in which your company operates.
7. Confirm your geographic information is correct.
8. Select the products for which you would like to receive notifications.
9. Click **Submit**.

Chapter 2: New in this Document

The following sections detail what is new in *Configuring IPv6 Routing*.

IPv6 Routing

This release introduces support for IPv6 routing:

- Dual-Stack IPv4/IPv6 support
- 6in4 configured tunnels—This feature enables you to transition from an IPv4 network to an IPv6 network. The software supports 16 manually-configured 6in4 tunnels per chassis.

 **Note:**

6in4 tunnels are not supported if the tunnel source IP address is reachable through an IPv4 Shortcuts route.

- IPv6 Routing (Static, OSPFv3)
- VRRPv3 and IPv6 support on SMLT/RSMLT links—This feature enables you to design resilient IPv6 networks. The switch supports up to eight VRRP links for IPv4 and IPv6 (combined).
- IPv6 connectivity for management protocols—This feature enables RADIUSv6, DHCPv6, DNSv6, and Syslog servers in an IPv6 network.
- IPv6 OAM support—This feature includes support for Ping, Traceroute, Telnet, FTP, TFTP, Rlogin, SSH, SNMPv3, and EDM access via IPv6 HTTPS.
- IPv6 Access Control Lists (ACLs)—This release adds support for IPv6 *ingress security ACL/*Filters for ports and VLANs. It does not support the following:
 - IPv6 ingress QoS ACL/Filters
 - IPv6 egress security ACL/Filters
 - IPv6 egress QoS ACL/Filters

For more information, see *Configuring QoS and ACL-Based Traffic Filtering*.

- IPv6 Routing provides partial HA support. The application synchronizes the static configuration from the master CPU to the standby CPU. However, the dynamic data learned by protocols are not synchronized.
- The switch supports a maximum of 64K IPv6 entries between Routes and Hosts entries. 32K entries are allocated for Route entries.

*** Note:**

IPv6 Routing has the following restrictions:

- The software does not support IPv4-mapped IPv6 addresses, for example, 0::FFFF:a.b.c.d, or IPv4-compatible IPv6 addresses, for example, 0::a.b.c.d.
- The neighbor entry state on the CP and hardware cannot be synchronized. In some cases the neighbor entry to which traffic is forwarded may be shown as stale on the CP.
- The switch does not support ipv6-mode and urpf-mode boot flags.
- IPv6 forwarding is disabled by default on a global configuration level.

Notice about Feature Support

This document includes content for multiple hardware platforms across different software releases. As a result, the content can include features not supported by your hardware in the current software release.

If a documented command, parameter, tab, or field does not appear on your hardware, it is not supported.

For information about feature support, see *Release Notes*.

For information about physical hardware restrictions, see your hardware documentation.

Chapter 3: IPv6 basics

This chapter provides concepts and procedures to complete basic IPv6 configuration, for example, IPv6 forwarding and static routes.

Origins of IPv6

The growth of IP address use is exponential.

Predictions indicated that the IPv4 address pool could be exhausted as early as 1994.

So, in July 1991, the Internet Engineering Task Force (IETF) began researching a replacement for IPv4.

That replacement is IPv6.

The Internet Assigned Numbers Authority (IANA) free pool of IPv4 addresses reached 0% in February 2011, according to the American Registry for Internet Numbers (ARIN).

While IPv4 addresses may remain available for some time within reserved pools, no further IPv4 addresses are available for reservation.

Although IPv6 is designed to replace IPv4, IPv6 is not backward-compatible and IPv4 and IPv6 need to coexist within your network during and after the transition to IPv6.

Advantages of IPv6

IPv6 can provide more addresses and support more networks than IPv4. For example, IPv6 offers enough addresses for every person on Earth to have 1 million addresses.

Because IPv6 offers a larger address space it offers improved scalability.

Following are additional advantages of IPv6 over IPv4:

- With 128 bit addresses, the larger IPv6 address space offers global access and scalability and solves the pending exhaustion of IP addresses.
- Network Address Translation (NAT) is no longer required.

Flat address space and transparency are restored by IPv6 because NAT is eliminated.

- Routing efficiency is improved due to the hierarchical network architecture.

IPv6 allows for hierarchical routing and effective route summarization.

- IPv6 supports Auto-configuration.
- IPv6 supports plug-and-play.
- Enhanced support is included for mobile IP and mobile computing devices.

Addresses can be permanently assigned to end devices such as DSL, PDAs, mobile terminals and PCs.

- Neighbor discovery (ND) replaces ARP in IPv6.

ND combines the IPv4 services for IPv4 Address Resolution Protocol (ARP) and router discovery.

Comparison of IPv4 and IPv6

The following table compares the key differences between IPv4 and IPv6.

*** Note:**

This information may not reflect IPv6 support in the current release.

Table 1: IPv4 and IPv6 key differences compared

Feature	IPv4	IPv6
Address length	32 bits	128 bits
IPsec support	Optional	Required
QoS support	Limited	Improved
Fragmentation	Hosts and routers	Hosts only
Minimum MTU packet size	576 bytes	1280 bytes
Checksum in header	Yes	No
Options in header	Yes	Yes
Link-layer address resolution	ARP (broadcast)	Multicast neighbor discovery messages
Multicast membership	IGMP	Multicast Listener Discovery
Router discovery	Optional	Optional
Uses broadcasts	Yes	No
Address configuration	Manual, DHCP	Automatic, DHCP

IPv6 packet

Each IPv6 packet can include mandatory and non-mandatory components.

An IPv6 packet includes:

- The basic header, which has a fixed length and is mandatory
- Extension header(s) , which has a variable length and is not mandatory
- Payload, which has a variable length and is not mandatory

The following figure illustrates the components of an IPv6 packet.

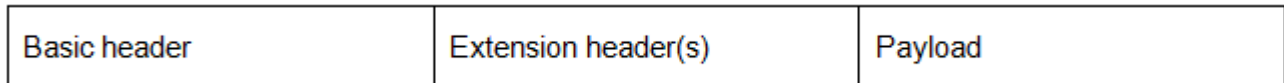

Figure 1: IPv6 packet components

*** Note:**

Nodes must be able to handle packets up to 1,280 octets in length.

IPv6 header

The IPv6 header basic length is fixed at 40 octets (bytes) and it contains the following fields:

Table 2: Fields in the IPv6 header

Field	Size in bits
Ver—Internet Protocol version number, with a value of 6	4
DS byte—Traffic class field, similar to Type of Service in IPv4	8
Flow label—identifies traffic flow for additional Quality of Service (QoS)	20
Payload Length—Unsigned integer, the length of the IPv6 payload	16
Next header selector—identifies the next header	8
Hop limit unsigned integer—decrements by 1 each time a node forwards the packet (nodes discard packets with hop limit values of 0)	8
Source address	128
Destination address	128

The following figure illustrates the basic IPv6 header, without extension headers.

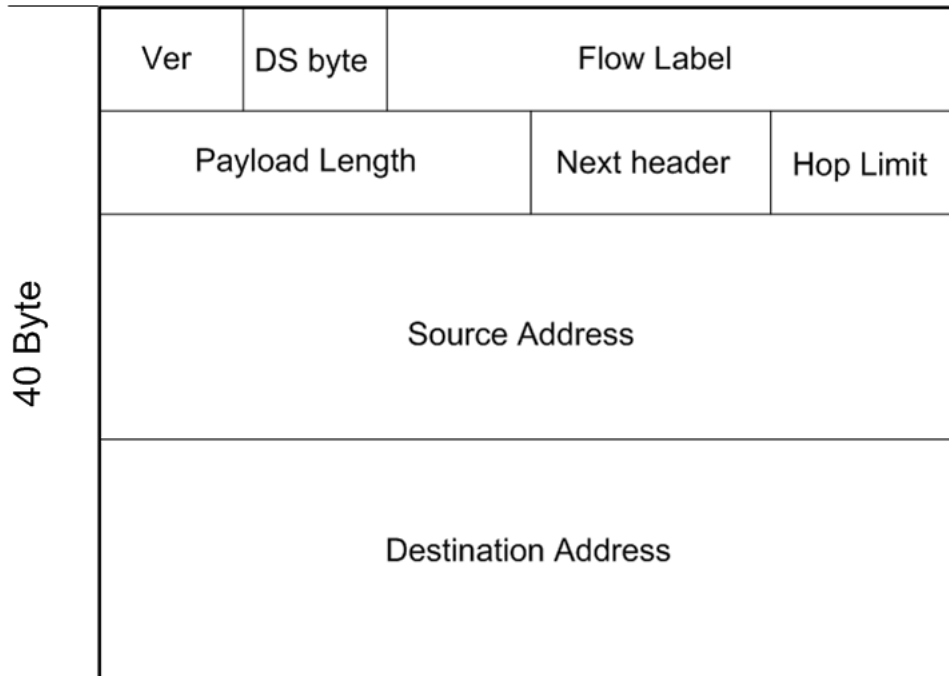

Figure 2: IPv6 header

IPv6 extension headers

IPv6 extension headers describe processing options.

Each extension header contains a separate category of options and is identified by a number, similar to protocol identification numbers.

An IPv6 packet can include extension headers, but they are not mandatory.

The following figure illustrates the IPv6 header with extension headers.

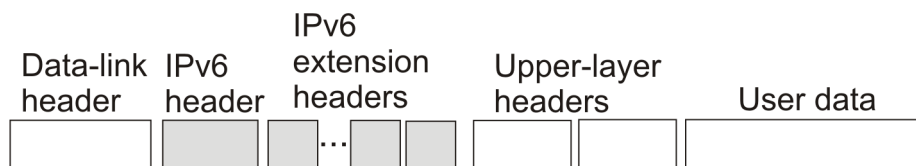

Figure 3: IPv6 header with extension headers

IPv6 examines the destination address in the main header of each packet it receives.

This examination determines whether the router is

- the packet destination - if the router is the packet destination, IPv6 examines the header extensions that contain options for destination processing.

- an intermediate node in the packet data path - if the router is an intermediate node, IPv6 examines the header extensions that contain forwarding options.

By examining only the extension headers that apply to the operations it performs, IPv6 reduces the amount of time and resources required to process a packet.

IPv6 defines the following extension headers as described in the following table:

Table 3: IPv6 extension headers

Extension header name	Description
hop-by-hop	Contains optional information, and sub-options for Router Alert and Jumbo Payload, that all intermediate IPv6 routers examine between the source and the destination.
destinations-options	Contains optional information for the destination node. This option can appear twice, once for way points and once for final destination.
source-routing	Contains a list of one or more intermediate nodes that define a path for the packet to follow through the network to the destination. The packet source creates this list. The source-routing function is similar to the IPv6 source routing options.
fragmentation	Uses an IPv6 source to send packets larger than the size specified for the path maximum transmission unit (MTU).
authentication	provides security for IPv6 datagrams
encapsulated security payload (ESP)	provides security for IPv6 datagrams
The authentication extension header and the encapsulated security payload extension header can be used together to provide security services for IPv6 datagrams.	

The recommended extension header order is:

- Hop-by-hop
- Destination option 1
- Routing
- Fragmentation
- Authentication/ESP
- Destination Option 2

The presence of particular extension headers within a packet can cause slower packet processing if the IPv6 implementation handles only certain headers and diverts others to a slow path. For example, many IPv6 implementations usually process Hop-by-Hop extension headers on the control plane.

IPv6 address component summary

The IPv6 Internet is divided into addressing zones and IPv6 addresses can be categorized by type and scope.

IPv6 addressing is represented in RFC 4291.

Address types

IPv6 addresses are divided into the following types:

- Unicast
- Multicast
- Anycast

Unicast:

Unicast addresses provide one-to-one communication.

Unicast addresses can be

- Global
- Link local
- Special, for example: Unspecified and Loopback

Multicast:

Multicast addresses are similar in operation to IPv4 and provide one-to-many communication.

Anycast:

An Anycast address is a Unicast address used for several devices to allow them to communicate with the device closest to the source; one-to-nearest communication.

The switch supports Subnet-Router Anycast: example <prefix>::0.

Broadcast:

In IPv6, broadcast addresses have been superseded by multicast addresses per RFC 4291.

Address scopes

Following are IPv6 address scopes:

- node-local
- link-local
- global

The switch does not support site-local addresses and, according to RFC 4193, site-local addresses will be replaced by unique-local addresses.

For more information about address types and scopes, see [IPv6 address formats](#) on page 22

Address zones

The IPv6 Internet is divided into zones.

For example:

- Each node is a separate zone of the node-local scope.
- Each link is a separate zone of the link-local scope.
- The entire Internet is a single zone of global scope.

Zones of the same scope do not overlap.

IPv6 address formats

IPv6 addresses are 128 bits long. In comparison, IPv4 addresses are 32 bits in length.

The IPv6 address contains an

- address type
- address prefix
- interface ID

The following figure illustrates the IPv6 address format.

Type	Address prefix	Interface ID
------	----------------	--------------

Figure 4: IPv6 address format

Address types

IPv6 uses three main address types to help route packets.

Address types are:

- Unicast: global, link—local, special unspecified, special loopback
- Multicast
- Anycast

Unicast addresses

Unicast addresses provide one-to-one communication.

Global:

A Unicast global address identifies a single interface and is similar to an IPv4 public address.

Unicast global addresses are globally routable in the same manner as IPv4 addresses.

The following figure illustrates the Unicast global address parts.

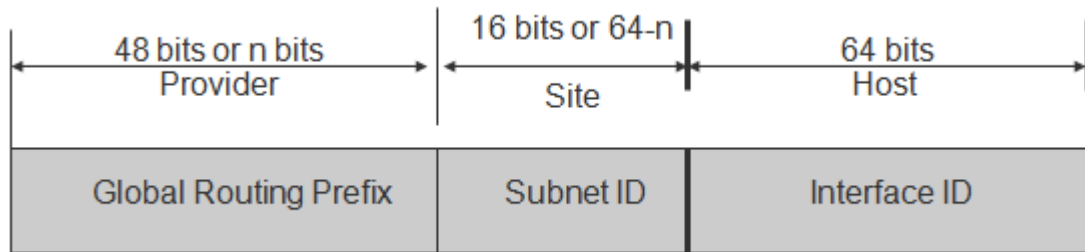

Figure 5: Unicast global address parts

An IPv6 Unicast global address is composed of the following 3 levels:

- public topology (48 bit Global Routing Prefix)
 - 001, specifies an IPv6 Unicast global address
 - Top Level Aggregation Identifier (TLA ID), the highest level in routing hierarchy
 - Res, reserved for future use
 - Next Level Aggregation Identifier (NLA ID), specifies a customer site
- site topology (16 bit Subnet ID)
 - Site Level Aggregation Identifier (SLA ID); assigned within the site, an ISP cannot affect the SLA ID, enables up to 65,536 subnets within a site
- interface ID (64 bits)
 - specifies the interface for a node on a subnet

The system uses the 48 bit global routing prefix for the route prefix exchange.

The IPv6 Prefix for Unicast global is 2000::/3 (RFC3513).

Link-local:

Hosts on the same link/subnet use automatically configured IPv6 Unicast link-local addresses to communicate with each other.

Link-local addresses are automatically configured on all interfaces.

Routers do not forward packets containing a destination or source address with a link-local address.

IPv6 uses neighbor discovery (ND) for address resolution.

The IPv6 prefix for link-local Unicast addresses is FE80::/10 (RFC3513).

The following figure illustrates the parts of a Unicast Link-local address.

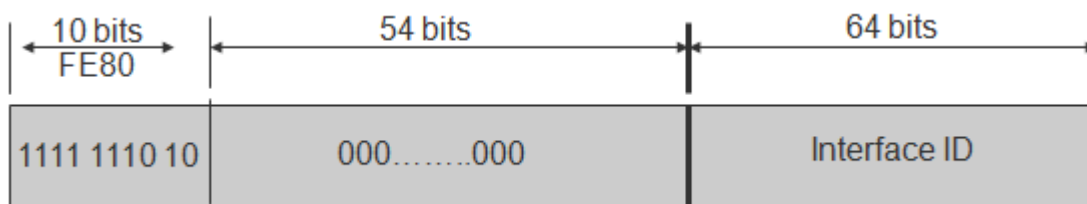

Figure 6: Unicast Link-local address

Special addresses:

The Unicast/special/unspecified address indicates the absence of an address and is the only valid SRC address for IPv6 Duplicate Address Detection (DAD).

Equivalent to the IPv4 unspecified address 0.0.0.0, represented as 0:0:0:0:0:0:0:0 or ::1; an IPv6 host that does not have a valid address uses the unspecified address as its source address when it sends a packet to discover whether an address is used by another node (during the boot process when the host requests address configuration information).

*** Note:**

Do not assign an unspecified address, either statically or dynamically, to an interface.

The Unicast/special/loopback address is a special case Unicast address only found inside a single node.

The switch does not support the loopback address.

Equivalent to the IPv4 loopback address 127.0.0.1, represented as 0:0:0:0:0:0:0:1 or ::1; a node uses a loopback address to send a packet to itself.

The loopback address is beneficial in troubleshooting and testing the IP stack because you can use it to send a packet to the protocol stack without sending it onto the subnet.

*** Note:**

Do not assign a loopback address, either statically or dynamically, to an interface.

Both Loopback and Unspecified addresses are not valid destination addresses.

IPv6 Unicast address example:

An example of a unicast IPv6 address is 1080:0:0:0:8:8000:200C:417A

IPv6 Link-local Unicast address example:

An example of a link-local Unicast IPv6 address is FE80::4445:4eff:fe54:1212

Multicast addresses

Multicast addresses provide one-to-many communication.

An IPv6 multicast address identifies a group of nodes.

The scope is built into the multicast address structure.

The system uses a multicast address to send traffic to multiple destinations. In this situation traffic experiences less delay with a multicast address than it would with Unicast address.

The following figure shows the format of an IPv6 multicast address.

8 bits	4 bits	4 bits	112 bits
11111111	flags	scope	group ID

Figure 7: IPv6 multicast address format

A value of FF (11111111) in the 8 high-order bits of an IPv6 address indicates that the address is an IP multicast address.

The Multicast IPv6 Prefix is FF00::/8 (RFC3513).

Flags:

The 4-bit flags field indicates whether the group is permanent or transient. The first 3 bits are reserved and the 4th bit represents the Transient flag. Currently only the Transient (T) flag is defined. A T flag set to 0 specifies a permanently assigned multicast address. A T flag set to 1 specifies a transient address.

Group ID:

The 112 bit group ID identifies the multicast group.

An example of a multicast address is FF01:0:0:0:0:0:101

Scope field:

The 4-bit scope field within the group ID specifies the multicast traffic scope.

Following is a list of the scope options that limit the scope of the multicast address:

- 1 - node-local
- 2 - link-local
- 3 - subnet local
- 4 - admin local
- 5 - site-local – not supported
- 8 - organization-local
- B - community-local
- E - global

Examples of multicast addresses:

All-nodes addresses look like this:

FF01::1 (Node Local), FF02::1 (Link Local)

All-routers addresses look like this:

FF01::2 (Node Local), FF02::2 (Link Local)

A solicited node or host address looks like this:

FF02::1:FF1E:8329.

In this case the MAC is 00-02-B3-1E-83-29 and the IPv6 address is fe80::202:B3FF:FE1E:8329.

The following table lists some well-known multicast IPv6 addresses

Table 4: Well-known multicast IPv6 addresses

Name	Address
All Nodes	FF02:0:0:0:0:0:1
All Routers	FF02:0:0:0:0:0:2
OSPFGRP	FF02:0:0:0:0:0:5

Table continues...

Name	Address
OSPF/IGP Designated Routers	FF02:0:0:0:0:0:6
All PIM Routers	FF02:0:0:0:0:0:D
VRRP	FF02:0:0:0:0:0:12
All MLDv2-capable routers	FF02:0:0:0:0:0:16
All DHCP agents	FF02:0:0:0:0:0:2
Solicited Node address	FF02::1:FF00:0000/104

Anycast

Anycast addresses provide one-to-nearest (one to one-of-many) communication.

An anycast address designates a set of interfaces that share an address.

A packet sent to an anycast address goes only to the nearest member of the group. Considering routing distance, the system delivers packets with anycast addresses only to the nearest member of a group of multiple interfaces.

Restrictions:

An anycast address must not be:

- used as the source address in an IPv6 packet
- assigned to an IPv6 host (you can assign an anycast address to an IPv6 router)

Anycast address scopes:

Anycast addresses have the following scopes:

- Link-local—the local link; nodes on the same subnet
- Global—IPv6 Internet addresses

Similar to anycast IPv4 addresses, IPv6 anycast addresses are more efficient. They use the unicast address space but identify multiple interfaces.

IPv6 delivers a packet bearing an anycast address to the nearest interface identified by the address.

Currently anycast addresses are assigned to routers and are used as destination addresses. Because packets bearing anycast addresses are delivered to the closest router, you can also access the closest name server or time server with an anycast address.

Visually there is no distinction between an anycast address and a unicast address.

* Note:

The switch supports only the subnet-router anycast address.

You cannot configure any specific anycast addresses beyond the automatic, generic subnet-router anycast address.

Difference between multicast and anycast

Anycast address delivery is from one to one-of-many, whereas multicast address delivery is from one to many.

IP address prefix

Address prefixes represent one of the following:

- network identifier
- fixed address part

Examples of IP address prefixes:

2001:10F2::/48 represents a summarized route prefix

2001:10F2:0:102F::/64 represents a subnet or link prefix

FF00::/8 represents Multicast IPv6

Interface ID

Interface identifiers identify interfaces on a link.

As long as the interfaces are attached to different subnets, you can use the same identifier on more than one interface on a single node.

The IPv6 interface ID is as unique as the MAC address.

The interface ID is derived by a formula that uses the link layer 48-bit MAC address. In most cases, the interface ID is a 64-bit interface ID that contains the 48-bit MAC address. If you enter less than 64 bits, the system adds leading zeroes to extend the interface ID length to 64 bits.

You can configure the interface ID in the following ways:

- Manual configuration
- DHCPv6 (can configure the whole address)
- Automatic derivation from EUI-64 (MAC address or other HW serial)—enables serverless or stateless auto-configuration when combined with high order part of address learned from router advertisements
- Pseudo-random generation (client privacy)—enables serverless or stateless auto-configuration when combined with high order part of address learned from router advertisements

The switch supports manual interface ID configuration or automatic derivation from EUI-64.

Note:

You must manually specify the network prefix, regardless of the interface ID formation method.

For stateless autoconfiguration, the ID is 64 bits in length.

For more information about stateless autoconfiguration, see [Host autoconfiguration](#) on page 87.

How to write an IPv6 address

The appearance of IPv6 addresses differs from IPv4 addresses and you express them differently.

The 128 bits in an IPv6 address are divided into 8 blocks of 16 bits each.

Following is the preferred IPv6 address format:

```
XXXX:XXXX:XXXX:XXXX:XXXX:XXXX:XXXX:XXXX
```

Hexadecimal IPv6 address representations:

Each 16 bit block in an IPv6 address is converted into a 1 to 4 digit hexadecimal number separated by colons (:).

The format to represent an IPv6 address is n:n:n:n:n:n:n, where n is the hexadecimal representation of 16 bits in the address; for example, 2001:0:0:0:0:0:0:43.

Each nonzero field must contain at least one numeral.

Within a hexadecimal field, you do not need leading zeros.

Certain classes of IPv6 addresses commonly include multiple adjacent fields that contain hexadecimal 0.

The sample address—2001::43—includes six adjacent fields that contain zeroes represented by a double colon (::) .

You can use a double colon to compress the leading zero fields in a hexadecimal address.

A double colon can appear only once in an address.

Four more ways to write an IPv6 address:

```
2001:DB8:0000:0000:25AB:0000:0000:0001
2001:DB8:0:0:25AB:0:0:1
2001:DB8:0:0:25AB::1
2001:DB8::25AB:0:0:1
```

ICMPv6

Internet Control Message Protocol version 6 (ICMPv6) maintains and improves on features from ICMP for IPv4.

ICMPv6 reports the delivery of forwarding errors.

For example:

- Destination unreachable
- Packet too big (path MTU)
- Time exceeded (fragmentation)
- Parameter problem

ICMPv6 also delivers information messages such as ping, otherwise known as

- Echo request
- Echo reply

! **Important:**

By providing a framework for informational messages, ICMPv6 plays an important role in IPv6 features such as

- Neighbor discovery (ND)
- Path MTU discovery
- Multicast Listener Discovery (MLD)

You can identify an IPv6 ICMP packet because the Next Header field in the IPv6 packet header is 58.

Internet Protocol Security (IPsec) with ICMPv6

You can configure IPsec with ICMPv6. For a configuration example of IPsec with ICMPv6, see *Configuring Security*.

Path MTU discovery

IPv6 routers do not fragment packets.

The source node may send packets less than or equal to the maximum transmission unit (MTU) of the link layer.

As the packet travels through the network to the source it may encounter a link with a smaller MTU. If so, the router sends the source node an ICMP error message that contains the MTU size of the next link. The source IPv6 node then resends a packet equal to the size of the MTU included in the ICMP message.

The default Layer 3 IPv6 MTU value is 1500 where the system MTU default value is 1950.

The default IPv6 MTU value is always less than the default System MTU value.

You can configure the MTU for each IPv6 interface.

***** **Note:**

To configure separate Layer 3 MTU values for IPv4 and IPv6 packets on the same VLAN interface, you must disable Unicast Reverse Path Forwarding (uRPF) mode. If you enable the uRPF mode using the command `boot config flags urpf-mode`, the MTU values for both IPv4 and IPv6 packets on the same VLAN are matched. Different Layer 3 MTU sizes on the same VLAN are not allowed in uRPF mode.

Routing

A routing table is present on all nodes.

The routing table stores information about IPv6 network prefixes and how to reach them.

*** Note:**

The switch requires routing protocols, such as OSPFv3 to exchange IPv6 routing prefixes.

For each incoming packet, the switch checks the destination neighbor cache first. If the destination is not in the destination neighbor cache, the routing table determines:

- the next-hop interface (the interface used for forwarding)
- the next-hop address

*** Note:**

The system uses the IPv6 Neighbor Cache for on-link, directly-connected destinations only. Off-link destinations go through a next-hop router, as determined by the next-hop address lookup.

IPv6 routes in a routing table can be:

- directly attached network routes using a 64-bit prefix
- remote network routes using a 64-bit or lower prefix
- host routes using a 128-bit prefix length
- the default route using a prefix of `::/0`

The switch supports the following IPv6 routing protocols:

- RIPng
- OSPFv3
- BGP+ (over 6in4 tunnels)
- IPv6 Shortcuts (over Fabric Connect)

You can redistribute IPv6 routes between any of these routing protocols.

This document focuses on OSPFv3. For information about OSPFv2, see *Configuring OSPF and RIP*.

To configure IPv6 routing on a VLAN, an IP address is assigned to the VLAN. This IP address is not associated with any particular physical port, but is used on all ports where this VLAN is a member.

On a brouter port, a single port VLAN is used to route the traffic. IPv4 and IPv6 traffic is routed in the single-port brouter VLAN.

Other VLANs (which are multiple port VLANs) can bridge and route the traffic.

Virtual routing between IPv6 subnets

The switch supports IPv6 routing between subnets.

When you add an IP address to the VLAN, the system maps an IP subnet to the VLAN.

As shown in the following figure, although VLAN 1 and VLAN 2 reside on the same switch, for traffic to flow from VLAN 1 to VLAN 2, you must route the traffic.

You must enable IPv6 forwarding to route IPv6 traffic between VLANs. And you must enable IPv6 both globally and on a specific VLAN basis in order for forwarding to function. You can enable or disable IPv6, either globally or on a specific VLAN basis.

IPv6 forwarding is enabled by default.

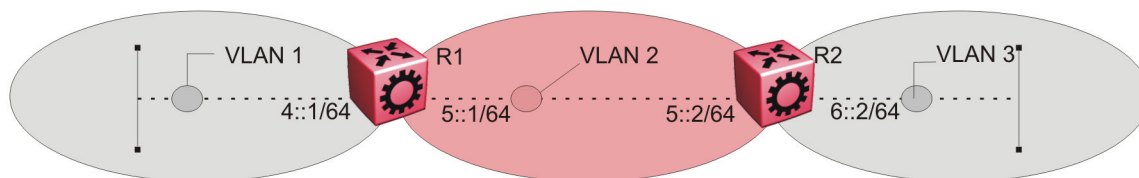

Figure 8: IPv6 routing between VLANs

When you configure routing on a VLAN, an IPv6 address assigned to the VLAN is the VLAN IP interface.

The VLAN IPv6 address can be reached through any VLAN port, and frames route from the VLAN through the gateway IPv6 address.

You can forward traffic to any IPv6 subnet in the switch. A VLAN can be reached only if it has an IPv6 interface configured on it.

Because a port can belong to multiple VLANs, a one-to-one correspondence no longer exists between the physical port and the router interface when VLAN tagging is enabled.

If you do not enable VLAN tagging a single port can belong only to one port-based VLAN, but that same single port can belong to multiple policy-based VLANs.

As with any IPv6 address, you can use any VLAN IP interface for device management.

For the Simple Network Management Protocol (SNMP) or Telnet management, you can use any VLAN IP interface to access the switch while routing is enabled on the VLAN.

Router ports

A router port is a single-port VLAN that can route IP packets and bridge all nonroutable traffic.

The difference between a router port and a standard protocol-based VLAN configured for routing is that the routing interface of the router port is not subject to the spanning tree state of the port. A router port can be in the blocking state for nonroutable traffic while it routes IP traffic.

* Note:

Because a router port is a one-port VLAN, each router port decreases the number of available VLANs by one and uses one VLAN ID.

Static routes

Static routes provide an alternative method for establishing route reachability.

Static routes, with dynamic routes, provide routing information from the forwarding database.

Only enabled static routes whose nexthop address is reachable are submitted to the Route Table Manager (RTM), which determines the best route based on reachability, route preference, and cost.

The RTM communicates all updates to best routes.

If the nexthop is not reachable you can use the `show ipv6 route static` command to display the status. If the nexthop is not reachable, the status is `TryToResolve` and the route does not appear in the RTM until the nexthop address is resolved.

For directly-connected IPv6 Subnets you do not need to specify a nexthop address; you can specify outgoing Tunnel-ID, VLAN, or port. If you use outgoing Tunnel-ID, VLAN, or port, the implied nexthop value is `0::0`.

When you configure static routes with a link-local nexthop, you must also specify the outgoing Tunnel-ID, VLAN, or port because link-local addresses are ambiguous unless the proper interface binding is attached. For example: `ipv6 route 1234::/64 cost 1 next-hop fe80::1 vlan 1900`.

You must provide the following options to configure a static route:

- local or nonlocal hop option

Configure a static route either with a next hop that exists on a locally attached network or a next hop that is reachable through a dynamic route. The static route is available as long as the next hop is reachable.

- route preference

You can specify the route preference for the static routes as follows:

- Global value for all static routes: the preference is either static or dynamic routes.
- Preference for each static route entry: if specified, this value overrides the global value for the entry which provides flexibility to change the general behavior of a specific static route.

- Administrative status

Controls when the static route is considered for forwarding. Administrative status differs from the operational status. An admin-enabled static route can still be unreachable and not used for forwarding. An admin-disabled static route is operationally a nonexistent route.

- Multiple static routes

Specify alternative paths to the same destination. Multiple static routes provide stability and load balancing.

To configure a default static route, supply a value of 0 for the prefix and the prefix length.

The following table describes events that affect static route operation.

Table 5: Events and their affects on static route operation

Action	Result
Change the administrative status of the static route	Makes the static route unavailable for forwarding You can use one CLI command to administratively enable or disable all static routes as follows <code>ipv6 route static enable</code> . You can administratively disable all routes but preserve the static route configuration when you use

Table continues...

Action	Result
	the CLI command: <code>no ipv6 static route enable</code> .
Delete the IPv6 addresses of a VLAN or router port	Permanently deletes the static routes with the corresponding local neighbors from the RTM, the forwarding database, and the configuration database
Delete a VLAN	Removes static routes with a local next-hop option from the configuration database. Static routes with a nonlocal next-hop option become inactive (they are removed from the forwarding database).
Disable forwarding on a VLAN or router port	Static routes reachable through the locally attached network become inactive
Disable a VLAN or router port	Makes the static route inactive
Disable IPv6 forwarding globally	Stops forwarding all IPv6 traffic
Learn changes about a dynamically learned neighbor	After a neighbor becomes unreachable or is deleted, the static route with the neighbor becomes inactive, and the configuration is not affected. The static route with the neighbor becomes active in the configuration and is added to the RTM and forwarding database when the neighbor becomes reachable.
Enable a static route	Adds the route to the RTM to change certain static routes to active.
Delete a static route	Permanently deletes a static route from the configuration.
Disable a static route	Stops traffic on the static route but does not remove the route from the configuration.
Change a route preference	After the static route preference changes, the best routes for the entries use both static and dynamic paths.
Delete or disable a tunnel	Removes the tunnel entry from the forwarding table
Enable a tunnel	Activates the tunnel static routes and adds an entry to the forwarding table.

The local-next-hop flag is not required for IPv6.

An IPv4 device cannot learn a neighbor ARP entry unless the device uses a local route entry.

In IPv6, a host can learn a neighbor entry if the device is physically connected to the neighbor (one hop).

The static route becomes active when the next hop is reachable by a dynamic route neighbor resolution. The static route takes the forwarding information from the dynamic route. If the next hop is reachable using a local route, the neighbor resolution is required.

Static route table:

The static route table is separate from the system routing table that the router uses to make forwarding decisions.

You can use the static route table to directly change static routes.

Although the tables are separate, the system routing table automatically reflects the static routing table manager entries if the next-hop address in the static route is reachable and if the static route is enabled.

The static route table is indexed by four attributes:

- destination network
- destination mask
- next hop
- interface

You can insert static routes by using the static route table, and you can delete static routes by using either the static route table or the system routing table. For information on route scaling, see *Release Notes*.

! **Important:**

The system routing table stores only active static routes with the best route preference. A static route is active only if the route is enabled and if the next-hop address is reachable; for example, if a valid IPv6 neighbor cache entry exists for the next hop.

You can enter multiple routes (for example, multiple default routes) that use different costs and the lowest cost route that is reachable appears in the routing table.

If you enter multiple next hops for the same route with the same cost, the switch does not replace the existing route.

If you enter the same route with the same cost and a different next hop, the switch uses the first route. If that first route becomes unreachable, the system activates the second route, with a different next-hop, with no connectivity loss.

Route scaling

IPv4 and IPv6 route scaling depends on the combination of the `ipv6-mode` and `urpf-mode` boot config flags. For more information, see *Release Notes*.

IPv6 Circuitless IP

IPv6 Circuitless IP (CLIP) is a virtual interface that is not associated with any physical port. You can use an IPv6 CLIP interface to provide uninterrupted connectivity to your switch as long as an actual path exists to reach the device. The system treats the IPv6 CLIP interface like an IPv6 interface and treats the network associated with the IPv6 CLIP as a local network attached to the device. This route always exists and the circuit is always up because no physical attachment exists.

You can use an IPv6 CLIP address as a logical IPv6 address for network management, as well as for other purposes. The IPv6 CLIP is typically a host address with any prefix length. You can redistribute this address as part of any other routing protocol update, so that the CLIP address is known to neighbors and available for use in routing or other types of connectivity. You can use IPv6 CLIP for many kinds of management connectivity such as telnet or SSH. You can also use IPv6 CLIP as a source IP address for sending Syslog messages.

For scaling information on IPv6 CLIP, see *Release Notes*.

IPv6 CLIP restrictions and limitations

This section describes the restrictions and limitations associated with IPv6 CLIP.

- Stateless address autoconfiguration (SLAAC) is not supported on IPv6 CLIP interfaces.
- IPv6 CLIP does not support link-local address configuration.
- To configure an IPv6 address with a prefix length from 65 to 127 on a CLIP interface, you must enable the IPv6 mode flag.

*** Note:**

This flag does not apply to all hardware platforms. For more information, see *Release Notes*.

- Neighbor discovery (ND) does not run on an IPv6 CLIP interface. Therefore, the system does not detect duplicate IPv6 address assignment to this interface.
- Multiple IPv6 address configuration on an IPv6 CLIP interface is not supported.
- IPv6 CLIP interface is enabled by default and it cannot be disabled.
- You cannot configure an IPv6 CLIP interface as the source or destination endpoint of an IPv6-in-IPv4 tunnel.

Equal Cost Multipath

With Equal Cost Multipath (ECMP), the switch can determine equal-cost paths to the same destination prefix. You can use multiple paths for load sharing of traffic. These multiple paths allow faster convergence to other active paths in case of network failure. By maximizing load sharing among equal-cost paths, you can use your links between routers more efficiently when sending IP traffic. ECMP is formed using routes from the same source or protocol, and the ECMP routes are evaluated within each routing protocol.

The ECMP feature supports and complements the following protocols and route types:

- OSPFv3
- Static routes
- BGP+
- RIPng
- IPv6 Shortcuts

ECMP with static routes

ECMP supports and complements static routes.

The following points need to be considered while configuring ECMP with static routes:

- When ECMP is globally enabled, the equal cost static routes are added in the Routing Table Manager (RTM).
- Static routes that are configured only using an interface, such as VLAN or port, do not support ECMP as these routes have a preference value of 0 and are treated like local routes.
- If your switch supports a management interface, then static routes configured on the management interface do not support ECMP.
- Static routes configured by next-hop are not considered equal cost with routes that are configured by tunnel even if the routes have the same cost and preference.
- A static route configured by tunnel is the least preferred and is programmed only when a next-hop or an interface does not configure a static route.
- Static routes configured by next-hop that resolves their next-hop using another static route will be in the `notReachable` state even if the next-hop can be pinged.
- If there are two static routes configured by next-hop, and both next-hops are resolved via a dynamic protocol to the same value, then only one route will be in the `reachableInRtm` state. The state of the other route will be `reachableNotInRtm`.

Disable IPv6 ICMP multicast

On IPv6 networks, a packet can be directed to an individual machine or multicasted to a set of hosts. When a packet is sent to an IPv6 multicast address from a machine on the local network, that packet is delivered to a subset or all machines on that network.

If the packet that is sent to the multicast address is an ICMP Echo Request packet, the machines on the network will receive this ICMPv6 echo request packet and send an ICMP echo reply packet back. When all the machines on a network respond to this ICMPv6 echo request, the result can be severe network congestion or outages.

Network devices always respond to the IPv6 ICMP packets sent to a multicast address. However, you can disable the processing of IPv6 ICMP packets sent to a multicast address on the device. On disabling the ICMP multicast processing, all the packets containing ICMP sent to multicast addresses are dropped when the packets reach the control plane.

IPv6 basic configuration using the CLI

Enabling the IPv6–mode boot config flag

Enable this flag to support IPv6 routes with prefix-lengths greater than 64 bits.

This flag is disabled by default. Use this procedure to enable (set to true) the IPv6-mode boot config flag.

When the IPv6-mode boot config flag is enabled, the maximum number of IPv4 routing table entries decreases. For scaling information, see *Release Notes*.

Procedure

1. Enter Global Configuration mode:

```
enable
configure terminal
```

2. Enable the IPv6-mode boot config flag:

```
boot config flags ipv6-mode
```

3. Save the configuration, and then reboot the switch for the change to the IPv6-mode boot config flag to take effect.

4. After you reboot the switch, verify that the IPv6-mode boot config flag is set to true:

```
show boot config flags
```

Configuring an IPv6 static neighbor address

You can use static IPv6 neighbors to manually specify the link-layer address for a given IPv6 endpoint.

About this task

Under normal operation you do not need to configure static IPv6 neighbors.

However, IPv6 static neighbors can be used to:

- avoid the overhead associated with dynamic neighbor discovery protocol traffic
- help troubleshoot specific network scenarios

* Note:

IPv6 static neighbors are not supported on SMLT.

Not all parameters are available in non-default VRFs.

Procedure

1. Enter either Global Configuration mode or VRF Router Configuration mode for a specific VRF context:

```
enable
configure terminal
router vrf WORD<1-16>
```

2. Configure an IPv6 neighbor address:

```
ipv6 neighbor WORD<0-128> port {slot/port[sub-port]} mac
<0x00:0x00:0x00:0x00:0x00:0x00> [vlan <1-4059>
```

3. Configure optional parameters if the default values do not meet your requirements:

- a. Configure the hop limit:

```
ipv6 hop-limit <0-255>
```

The default is 64.

- b. Configure ICMP network address unreachable messages:

```
ipv6 icmp addr-unreach
```

- c. Configure the ICMP error interval:

```
ipv6 icmp error-interval <1-2147483647>
```

The interval is in milliseconds. An interval of 0 results in no error messages. The default is 1000.

- d. Configure the ICMP error quota:

```
ipv6 icmp error-quota <0-2000000>
```

The default is 50.

- e. Configure ICMP port unreachable messages:

```
ipv6 icmp port-unreach
```

- f. Enable response to icmp echo multicast packets:

```
ipv6 icmp echo-multicast-request
```

The default is disabled.

- g. Enable ICMP network unreachable messages:

```
ipv6 icmp unreach-msg
```

The default is disabled.

Example

Add an IPv6 neighbor for a brouter port:

```
Switch:1(config)#ipv6 neighbor 3000:0:0:0:0:0:0:2 port 1/11 mac 00:0c:
42:07:35:90
```

Add an IPv6 neighbor for a VLAN:

```
Switch:1(config)#ipv6 neighbor 3000::3 port 1/12 mac 01:02:03:04:05:06
vlan 20
```

Variable definitions

Use the data in the following table to use the `ipv6` commands in this procedure.

Variable	Value
forwarding	Configures whether this entity is an IPv6 router with respect to the forwarding of datagrams received by, but not addressed to, this entity. Enable forwarding to act as a router. The default is enabled.
hop-limit <0–255>	Configures the hop limit. The default is 64.
icmp addr-unreach	Enables ICMP address unreachable messages. The default is enabled.
icmp echo-multicast-request	Enable response to icmp echo multicast packets. The default is enable.
icmp error interval <1–2147483647>	Configures the interval (in milliseconds) for sending ICMPv6 error messages. The default is 1000.
icmp error-quota <0-2000000>	Configures the number of ICMP error messages that can be sent during the ICMP error interval. A value of zero instructs the system not to send an ICMP error messages. The default value is 50.
icmp port-unreach	Enables ICMP port unreachable messages. The default is enabled.
icmp unreachable	Enables ICMP network unreachable messages. The default is disabled.
neighbor <i>WORD</i> <0-128> port {slot/port[sub-port]} mac <0x00:0x00:0x00:0x00:0x00:0x00> [vlan <1-4059>]	Creates a static IPv6 neighbor with the following variables: <ul style="list-style-type: none"> • <i>WORD</i><0-128> specifies the IPv6 address of the neighbor in hexadecimal colon format. • {slot/port[sub-port]} specifies the brouter port to use for the neighbor. Identifies a single slot and port. If your platform supports channelization and the port is channelized, you must also specify the sub-port in the format slot/port/sub-port. • mac <0x00:0x00:0x00:0x00:0x00:0x00> specifies the MAC address of the neighbor.

Table continues...

Variable	Value
	<ul style="list-style-type: none"> • <code>vlan <1-4059></code> specifies the VLAN ID to use for the neighbor. <p>Specifies the VLAN ID in the range of 1 to 4059. By default, VLAN IDs 1 to 4059 are configurable and the system reserves VLAN IDs 4060 to 4094 for internal use. On switches that support the vrf-scaling and spbm-config-mode boot configuration flags, if you enable these flags, the system also reserves VLAN IDs 3500 to 3998. VLAN ID 1 is the default VLAN and you cannot create or delete VLAN ID 1.</p> <p>Static IPv6 neighbors do not maintain any state machine and the system assumes that they are always reachable.</p>

Configuring an IPv6 interface

The information in this section can help you configure an IPv6 interface to make IPv6 active on the interface and fine-tune IPv6 neighbor discovery to control the frequency of protocol traffic.

By default, IPv6 forwarding is enabled on an interface.

Compared to IPv4/ARP, the IPv6 neighbor discovery mechanism maintains more protocol state, timers, and protocol traffic overhead.

There are two important tunable parameters for IPv6 ND that can control the frequency of protocol traffic:

- `ipv6 interface reachable-time`
- `ipv6 interface retransmit-timer`

Before you begin

- Before you can assign an IPv6 address to the interface, you must configure an IPv6 interface for a VLAN or router port.

You must configure a VLAN before you can give the VLAN an interface identifier or an IPv6 address.

The switch supports port-based and IPv6 protocol-based VLANs.

For information about how to configure VLANs, see the following documents:

- *Configuring VLANs, Spanning Tree, and NLB*
- *Configuring Link Aggregation, MLT, SMLT, and vIST*

Procedure

1. Enter Interface Configuration mode:

```
enable
```



```
configure terminal
interface GigabitEthernet {slot/port[/sub-port] [-slot/port[/sub-
port]][,...]} or interface vlan <1-4059>
```

*** Note:**

If your platform supports channelization and the port is channelized, you must also specify the sub-port in the format slot/port/sub-port.

2. Create IPv6 interface:

```
ipv6 interface
```

3. Configure optional parameters to meet your requirements:

a. Enable IPv6 router advertisement on the interface:

```
ipv6 nd send-ra
```

b. Configure the maximum number of hops before packets drop:

```
ipv6 interface hop-limit <1-255>
```

c. Configure the link-local address:

```
ipv6 interface link-local WORD<0-19>
```

d. Configure the mac offset:

```
ipv6 interface mac-offset <MAC-offset>
```

e. Configure the maximum transmission unit (MTU):

```
ipv6 interface mtu <1280-9500>
```

f. Configure an interface description:

```
ipv6 interface name WORD<0-255>
```

g. Configure the time a neighbor is considered reachable after receiving a reachability confirmation:

```
ipv6 interface reachable-time <1-3600000>
```

h. Configure the time between retransmissions of neighbor solicitation messages to a neighbor when resolving the address or when probing the reachability of a neighbor:

```
ipv6 interface retransmit-timer <1-4294967295>
```

i. Configure a brouter port as part of an IPv6 VLAN:

```
ipv6 interface vlan <1-4059>
```

j. Configure the interface to perform IPv6 unicast reverse path forwarding:

- To enable urpf-mode boot flag, enter:

```
boot config flags urpf-mode
```

- To configure unicast reverse path forwarding, enter:

```
ipv6 rvs-path-chk mode {strict|exist-only}
```

Example

Create and administratively enable the interface:

```
Switch:1(config-if)#ipv6 interface enable
```

* Note:

In contrast to IPv6 interface creation and address assignment in EDM, you use the **ipv6 interface** CLI command to create an interface and specify a single global address in one step.

Variable definitions

Use the data in the following table to use the **ipv6 interface** command.

Variable	Value
hop-limit <1–255>	Configures the maximum hops. The default is 64.
link-local <i>WORD</i> <0–19>	Specifies the 64-bit interface ID used to calculate the actual link-local address as a name up to 19 characters long.
mac-offset < <i>MAC-offset</i> >	<p>Use mac-offset to request a particular MAC for an IPv6 VLAN.</p> <p>* Note:</p> <p>This parameter applies only to VLANs.</p> <p>You can specify a MAC offset when you configure IPv6 on a VLAN, or the system can assign a MAC address from within the available range.</p> <p>Specifies a number by which to offset the MAC address from the chassis MAC address. This ensures that each IP address has a different MAC address. If you omit this variable, a unique MAC offset is automatically generated. Different hardware platforms support different ranges. To see which range is available on your switch, use the CLI command completion Help.</p>
mtu <1280–9500>	<p>Configures the maximum transmission unit for the interface: 1280–1500, 1850, or 9500. This value must be the same for all addresses defined on this interface.</p> <p>The default is 1500.</p> <p>Different hardware platforms support different MTU values. To see what values your switch supports, use the CLI command completion help.</p>

Table continues...

Variable	Value
name <i>WORD</i> <0–255>	Assigns a descriptive name. The network management system also configures this string.
reachable-time <0–3600000>	<p>Controls how long IPv6 neighbor entries learned on an interface remain in the REACHABLE state (as described in RFC 4861).</p> <p>The system randomizes the value you configure, per RFC specifications, to be 50%-150% of the configured value.</p> <p>By default the reachable-time base value is 30 seconds, with an actual 15-45 second range when you consider the randomization factor.</p> <p>The default is 3000 milliseconds</p>
retransmit-timer <0–4294967295>	<p>Controls the time, in milliseconds, between retransmission of Neighbor Solicitation messages when the system attempts to resolve or reconfirm the reachability of an IPv6 neighbor.</p> <p>By default, the system sends three Neighbor Solicitation messages with a one second interval between each message. If the system does not receive a corresponding Neighbor Advertisement within an interval equal to 3 X retransmit-timer milliseconds, the system declares the IPv6 neighbor unreachable.</p> <p> Tip: You can increase the retransmit-timer to extend the interval that the switch waits until it declares the neighbor unreachable. For example: a retransmit-timer value of 5000 means the switch waits 3 X 5000 milliseconds which equals 15000 milliseconds or 15 seconds.</p> <p>The default is 1000 milliseconds</p>
vlan <1-4059>	<p>Specifies the VLAN ID in the range of 1 to 4059. By default, VLAN IDs 1 to 4059 are configurable and the system reserves VLAN IDs 4060 to 4094 for internal use. On switches that support the vrf-scaling and spbm-config-mode boot configuration flags, if you enable these flags, the system also reserves VLAN IDs 3500 to 3998. VLAN ID 1 is the default VLAN and you cannot create or delete VLAN ID 1.</p> <p>This value corresponds to the lower 12 bits of the IEEE 802.1Q VLAN tag.</p>

Use the data in the following table to use the `ipv6 rvs-path-chk` command.

Variable	Value
mode {strict exist-only}	<p>Specifies the mode for Unicast Reverse Path Forwarding (uRPF).</p> <p>In strict mode, uRPF checks whether the source IP address of the incoming packet exists in the FIB. If the incoming interface is not the best reverse path, the packet check fails and uRPF drops the packet.</p> <p>In exist-only mode, uRPF checks whether the source IP address of the incoming packet exists in the FIB. The packet is dropped only if the source address is not reachable via any interface on that router.</p>

Use the data in the following table to use the **interface** command.

Variable	Value
<1-4059>	<p>Specifies the VLAN ID in the range of 1 to 4059. By default, VLAN IDs 1 to 4059 are configurable and the system reserves VLAN IDs 4060 to 4094 for internal use. On switches that support the vrf-scaling and spbm-config-mode boot configuration flags, if you enable these flags, the system also reserves VLAN IDs 3500 to 3998. VLAN ID 1 is the default VLAN and you cannot create or delete VLAN ID 1.</p>
{slot/port[/sub-port][-slot/port[/sub-port]][,...]}	<p>Identifies the slot and port in one of the following formats: a single slot and port (slot/port), a range of slots and ports (slot/port-slot/port), or a series of slots and ports (slot/port,slot/port,slot/port). If your platform supports channelization and the port is channelized, you must also specify the sub-port in the format slot/port/sub-port.</p>

Assigning IPv6 addresses to a router port or VLAN

Assign IPv6 addresses to interfaces to configure IPv6 routing for the interface.

Procedure

1. Enter Interface Configuration mode:

```
enable
```

```
configure terminal
```

```
interface GigabitEthernet {slot/port[/sub-port][-slot/port[/sub-port]][,...]} or interface vlan <1-4059>
```

*** Note:**

If your platform supports channelization and the port is channelized, you must also specify the sub-port in the format slot/port/sub-port.

2. Assign an IPv6 address:

```
ipv6 interface address WORD<0-255>
```

Example

Assign an IPv6 address specifying the full 128 bits of the address:

```
Switch:1(config-if)#ipv6 interface address 30:0:0:0:0:0:0:ffff/64
```

Assign an IPv6 address specifying only the upper 64 bits of the address:

```
Switch:1(config-if)#ipv6 nd prefix-interface <prefix> eui <1-3>
```

In this example you specify only the upper 64 bits of the address and allow the system to auto-generate the lower 64 bits from the MAC address.

Variable definitions

Use the data in the following table to use the **ipv6 interface address** command.

Variable	Value
WORD<0-255>	Specifies the IPv6 address for the port or VLAN.

Use the data in the following table to use the **interface** command.

Variable	Value
<1-4059>	Specifies the VLAN ID in the range of 1 to 4059. By default, VLAN IDs 1 to 4059 are configurable and the system reserves VLAN IDs 4060 to 4094 for internal use. On switches that support the vrf-scaling and spbm-config-mode boot configuration flags, if you enable these flags, the system also reserves VLAN IDs 3500 to 3998. VLAN ID 1 is the default VLAN and you cannot create or delete VLAN ID 1.
{slot/port[/sub-port][/-slot/port[/sub-port]][,...]}	Identifies the slot and port in one of the following formats: a single slot and port (slot/port), a range of slots and ports (slot/port-slot/port), or a series of slots and ports (slot/port,slot/port,slot/port). If your platform supports channelization and the port is channelized, you must also specify the sub-port in the format slot/port/sub-port.

Configuring IPv6 route preferences

Before you begin

! Important:

Changing route preferences can affect system performance and network accessibility while you perform the procedure. Change a prefix list or a routing protocol before you activate the protocols.

About this task

Configure IPv6 route preferences to give preference to routes learned for a specific protocol.

Procedure

1. Enter either Global Configuration mode or VRF Router Configuration mode for a specific VRF context:

```
enable
configure terminal
router vrf WORD<1-16>
```

2. Configure the route preference:

```
ipv6 route preference protocol <static|ebgp|ibgp|ospfv3-intra|
ospfv3-inter|ospfv3-extern1|ospfv3-extern2|ripng|spbm-level1>
<0-255>
```

3. Confirm that the configuration is correct:

```
show ipv6 route preference [vrf WORD<1-16> | vrfids WORD<0-512>]
```

Example

Configure the route preference to RIPng and confirm the configuration is correct.

```
Switch:1>enable
Switch:1#configure terminal
Enter configuration commands, one per line. End with CNTL/Z.
Switch:1(config)#ipv6 route preference protocol ripng 10
Switch:1(config)#show ipv6 route preference
```

```
=====
                                     IPv6 Route Preference - GlobalRouter
=====
=====
PROTOCOL          DEFAULT      CONFIG
-----
LOCAL             0            0
STATIC            5            5
SPBM_L1           7            7
OSPFv3_INTRA     20           20
OSPFv3_INTER     25           25
EBGP              45           45
RIPNG             100          100
OSPFv3_E1        120          120
OSPFv3_E2        125          125
IBGP              175          175
```

Variable definitions

Use the data in the following table to use the `ipv6 route preference` and the `show ipv6 route preference` commands.

Variable	Value
<0-255>	Assigns a route preference value.
ebgp	Configures the preference for protocol type EBGp.
ibgp	Configures the preference for protocol type IBGP.
ospfv3-extern1	Configures the preference for protocol type OSPFv3 external type 1.
ospfv3-extern2	Configures the preference for protocol type OSPFv3 external type 2.
ospfv3-intra	Configures the preference for protocol type OSPFv3 intra-area.
ospfv3-inter	Configures the preference for protocol type OSPFv3 inter-area.
ripng	Configures the preference for protocol type RIPng.
spbm-level1	Configures the preference for protocol type spbm-level1.
static	Configures the preference for protocol type static.

Viewing global IPv6 information

View and manage general IPv6 information.

Procedure

1. Log on to the switch to enter User EXEC mode.
2. Display IPv6 information for an interface:

```
show ipv6 interface [gigabitethernet {slot/port[/sub-port] [-slot/
port[/sub-port]] [,...]}] [loopback <1-256>][mgmtEthernet {slot/
port[/sub-port] [-slot/port[/sub-port]] [,...]}] [tunnel <1-2000>] [vlan
<1-4059>] [vrf WORD<1-16>] [vrfids WORD<0-512>]
```

3. Display IPv6 tunnel information:

```
show ipv6 interface tunnel <1-2000>
```

4. Display IPv6 address information for the specified slot and port:

```
show ipv6 address interface gigabitethernet {slot/port[/sub-port] [-
slot/port[/sub-port]] [,...]} [vrf WORD<1-16>] [vrfids WORD<0-512>]
```

5. Display IPv6 address information for the specified IPv6 address:

```
show ipv6 address interface ip WORD<0-46> [vrf WORD<1-16>] [vrfids
WORD<0-512>]
```

6. Display IPv6 address information for the specified tunnel:

```
show ipv6 address interface tunnel <1-2000>
```

7. Display IPv6 address information for the specified VLAN:

```
show ipv6 address interface vlan <1-4059>
```

8. Display the current state of IPv6 forwarding:

```
show ipv6 forwarding [vrf WORD<1-16>] [vrfids WORD<0-512>]
```

9. Display information on the current state of IPv6 functionality:

```
show ipv6 global [vrf WORD<1-16>] [vrfids WORD<0-512>]
```

10. Display IPv6 Gigabit Ethernet (GbE) router advertisement information:

```
show ipv6 nd interface gigabitethernet [{slot/port[/sub-port]} [-slot/port[/sub-port]] [,...]]
```

11. Display IPv6 router advertisement information for the management port:

```
show ipv6 nd interface mgmtEthernet mgmt
```

*** Note:**

This step only applies to hardware with a dedicated, physical management interface.

12. Display IPv6 VLAN router advertisement information:

```
show ipv6 nd interface vlan [<1-4059>]
```

13. Display detailed information in IPv6 router advertisements:

```
show ipv6 nd-prefix detail [vrf WORD<1-16> | vrfids WORD<0-512>]
```

14. Display GbE interface information in IPv6 router advertisements:

```
show ipv6 nd-prefix interface gigabitethernet [{slot/port[/sub-port]} [-slot/port[/sub-port]] [,...]]
```

15. Display VLAN interface information in IPv6 router advertisements:

```
show ipv6 nd-prefix interface vlan [<1-4059>]
```

16. Display VLAN information in IPv6 router advertisements:

```
show ipv6 nd-prefix vlan <1-4059>
```

17. Display IPv6 neighbor entries with specific brouter port numbers:

```
show ipv6 neighbor interface gigabitethernet {slot/port[/sub-port]}
```

18. Display IPv6 neighbor information for neighbors of the specified type:

```
show ipv6 neighbor type <1-4>
```

19. Display IPv6 neighbor information:

```
show ipv6 neighbor [WORD<0-46>]
```

Example

```
Switch:1(config)#show ipv6 interface vlan
```



```

=====
Vlan Ipv6 Interface
=====
IFINDX VLAN PHYSICAL ADMIN OPER TYPE MTU HOP REACHABLE RETRANSMIT MCAST IPSEC RPC RPCMODE
INDX ADDRESS STATE STATE LMT TIME TIME STATUS STATUS
-----
2070 22 e4:5d:52:3c:65:02 disable down ETHER 1500 64 30000 1000 disable disable disable existonly
=====
Vlan Ipv6 Address
=====
IPV6 ADDRESS VLAN-ID TYPE ORIGIN STATUS
-----
fe80:0:0:0:e65d:52ff:fe3c:6502 V-22 UNICAST LINKLAYER INACCESSIBLE
=====
1 out of 2 Total Num of Interface Entries displayed.
1 out of 2 Total Num of Address Entries displayed.

```

```
Switch:1#show ipv6 interface tunnel
```

```

=====
Tunnel Ipv6 Interface - GlobalRouter
=====
IF Descr VLAN PHYSICAL ADMIN OPER TYPE MTU HOP REACHABLE RETRANSMIT MCAST
INDX ADDRESS STATE STATE LMT TIME TIME STATUS
-----
6656 T-1 0 n/a enable down P2P 1280 64 30000 1000 disable
=====
Tunnel Ipv6 Address
=====
IPV6 ADDRESS TUNNEL-ID TYPE ORIGIN STATUS
-----
11:0:0:0:0:0:11:11/32 T-1 UNICAST MANUAL INACCESSIBLE INF INF
fe80:0:0:0:0:b0b:b0b/64 T-1 UNICAST LINKLAYER INACCESSIBLE INF INF
=====
1 out of 5 Total Num of Interface Entries displayed.
2 out of 9 Total Num of Address Entries displayed.

```

```
Switch:1#show ipv6 address interface tunnel 2
```

```

=====
Address Information
=====
IPV6 ADDRESS/PREFIX LENGTH VID/BID/TID TYPE ORIGIN STATUS
-----
44:211:0:0:0:0:2/64 T-2 UNICAST MANUAL PREFERRED
fe80:0:0:0:0:d301:3702/64 T-2 UNICAST LINKLAYER PREFERRED
=====
2 out of 407 Total Num of Address Entries displayed.

```

```
Switch:1#show ipv6 address interface vlan 100
```

```

=====
Address Information
=====
IPV6 ADDRESS/PREFIX LENGTH VID/BID/TID TYPE ORIGIN STATUS
-----
10:1:50:0:0:0:7/64 V-100 UNICAST MANUAL PREFERRED
fe80:0:0:0:b2ad:aaff:fe46:f19a/64 V-100 UNICAST LINKLAYER PREFERRED
=====
2 out of 407 Total Num of Address Entries displayed.

```

```
Switch:1#show ipv6 forwarding
Ipv6 forwarding - GlobalRouter : enable
ecmp : disable
ecmp-max-path : 1
```

```
Switch:1#show ipv6 global
```

```

=====
IPv6 Global Information - GlobalRouter
=====
forwarding : disable
default-hop-cnt : 64
number-of-interfaces : 1
icmp-error-interval : 1000
icmp-error-quota : 50
icmp-unreach-msg : disable
icmp-addr-unreach-msg : enable
icmp-port-unreach-msg : enable
icmp-echo-multicast-request : enable
static-route-admin-status : enable

```

IPv6 basics

```

alternative-route      : enable
ecmp                   : disable
ecmp-max-path          : 1
source-route           : disable
host-autoconfig        : disable
  
```

Switch:1#show ipv6 nd interface vlan

```

=====
Vlan Ipv6 Nd - GlobalRouter
=====
IFID VLAN  RTR-ADV MAX-INT MIN-INT LIFETIME MANAG OTHER DAD-NS MTU  HOP
REACHABLE RETRANSMIT
TIME      TIME
-----
2092 V-44  True  600   200   1800  False False 1    0 (d)  64 (d) 30000 (i) 1000 (i)
2081 V-33  True  600   200   1800  False False 1    0 (d)  64 (d) 30000 (i) 1000 (i)
  
```

Note: (s) = Set, (d) = Default, (i) = inherit.

2 out of 2 Total Num of Ipv6 ND Entries displayed.

Switch:1#show ipv6 nd interface mgmtEthernet mgmt

```

=====
Mgmt Ipv6 Nd
=====
IFID MGMT-IF RTR-ADV MAX-INT MIN-INT LIFETIME MANAG OTHER DAD-NS MTU  HOP  REACHABLE RETRANSMIT
FLAG CONF  LIFE      TIME
-----
64  mgmt   False  600   200   1800  False False 1    0 (d)  64 (d) 0 (d)  0 (d)
  
```

Switch:1#show ipv6 nd-prefix interface gigabitethernet

```

=====
Port Ipv6 Nd Prefix
=====
INTF IPV6
INDEX ADDRESS/PREFIX
-----
344  2011:beef:4004:0:0:0:0/64
                    BTR  VALID  PREF  EUI
                    LIFE  LIFE
                    -----
                    5/25 2592000 604800 1
  
```

1 out of 9 Total Num of Ipv6 ND prefix Entries displayed.

Switch:1#show ipv6 nd-prefix interface vlan

```

=====
Vlan Ipv6 Nd Prefix
=====
INTF IPV6
INDEX ADDRESS/PREFIX
-----
2148 2011:beef:100:0:0:0:0/64
2158 2011:beef:110:0:0:0:0/64
2248 2011:beef:200:0:0:0:0/64
2258 2011:beef:210:0:0:0:0/48
2548 2011:beef:500:0:0:0:0/64
2648 2011:beef:600:0:0:0:0/64
2948 2011:beef:900:0:0:0:0/64
                    VLAN  VALID  PREF  EUI
                    ID   LIFE  LIFE
                    -----
                    100 2592000 604800 1
                    110 2592000 604800 1
                    200 2592000 604800 1
                    210 2592000 604800 1
                    500 2592000 604800 1
                    600 2592000 604800 1
                    900 2592000 604800 1
  
```

7 out of 9 Total Num of Ipv6 ND prefix Entries displayed.

Switch:1#show ipv6 nd-prefix vlan 100

```

=====
Nd-Prefix Address Information
=====
INTF IPV6
INDEX ADDRESS/PREFIX
-----
2148 2011:beef:100:0:0:0:0/64
                    VLAN  VALID  PREF  EUI
                    ID   LIFE  LIFE
                    -----
                    100 2592000 604800 1
  
```

Legend: EUI: eui-not-used(1), eui-used-with-ul-complement(2) eui-used-without-ul-complement(3)

Switch:1#show ipv6 neighbor type 4

```

=====
Neighbor Information - GlobalRouter
=====
NET ADDRESS/
PHYSICAL ADDRESS
-----
123:0:0:0:0:0:123/
00:00:00:00:00:01
                    IPV6  PHYS  TYPE  STATE  LAST TUNNEL
                    INTF  INTF  TYPE  STATE  UPD
                    -----
                    C-1  cpp  LOCAL REACHABLE 0
  
```

```
1 out of 1 Total Num of Neighbor Entries displayed.
```

```
Switch:1(config)#show ipv6 neighbor
```

```

=====
Neighbor Information - GlobalRouter
=====
NET ADDRESS/          IPV6   PHYS   TYPE   STATE   LAST   TUNNEL
PHYSICAL ADDRESS     INTF   INTF                               UPD
=====
22:0:0:0:0:0:22/      V-22   1/2    DYNAMIC REACHABLE  570
   84:83:71:49:38:82
22:0:0:0:0:0:44/      V-22   cpp    LOCAL   REACHABLE  523
   d4:ea:0e:c8:8c:81
fe80:0:0:0:8683:71ff:fe49:3882/ V-22   1/2    DYNAMIC DELAY      579
   84:83:71:49:38:82
fe80:0:0:0:d6ea:eff:fec8:8c81/ V-22   cpp    LOCAL   REACHABLE  523
   d4:ea:0e:c8:8c:81
=====

```

Variable definitions

Use the data in the following table to use the `show ipv6` commands.

Variable	Value
address interface ip <i>WORD</i> <0-46>	Specifies the IPv6 address.
neighbor [<i>WORD</i> <0-46>]	Specifies the IPv6 address of the neighbor.
loopback <1-256>	Specifies the loopback interface ID value. If you do not specify a value, the output includes all IPv6 loopback interfaces.
{slot/port[/sub-port][<i>-slot/port[/sub-port]]</i> [,...]}	Identifies the slot and port in one of the following formats: a single slot and port (slot/port), a range of slots and ports (slot/port-slot/port), or a series of slots and ports (slot/port,slot/port,slot/port). If your platform supports channelization and the port is channelized, you must also specify the sub-port in the format slot/port/sub-port.
type <1-4>	Specifies the neighbor type as one of the following: <ul style="list-style-type: none"> • 1 - other • 2 - dynamic • 3 - static • 4 - local
tunnel <1-2000>	Specifies the tunnel ID.
vlan <1-4059>	Specifies the VLAN ID in the range of 1 to 4059. By default, VLAN IDs 1 to 4059 are configurable and the system reserves VLAN IDs 4060 to 4094 for internal use. On switches that support the vrf-scaling and spbm-config-mode boot configuration flags, if you enable these flags, the system also reserves VLAN IDs 3500 to 3998. VLAN ID 1 is the default VLAN and you cannot create or delete VLAN ID 1.
vrf <i>WORD</i> <1-16>	Specifies the VRF name.
vrfids <i>WORD</i> <1-256>	Specifies the VRF ID.

Creating IPv6 static routes

Use static routes to manually configure routes to destination IPv6 address prefixes.

About this task

Not all parameters are available in non-default VRFs.

Procedure

1. Enter either Global Configuration mode or VRF Router Configuration mode for a specific VRF context:

```
enable
configure terminal
router vrf WORD<1-16>
```

2. Enable IPv6 static routes globally:

```
ipv6 route static enable
```

If you disable static routes globally, the system removes all enabled static routes from the RTM and does not add new static routes to the RTM.

3. Configure a static route:

```
ipv6 route WORD<0-46> [enable] [cost <1-65535>] [next-hop WORD<0-46>] [preference <1-255>] [tunnel <1-2000>] [port {slot/port[sub-port]}] [vlan <1-4059>]
```

4. **(Optional)** Disable all IPv6 static routes:

```
no ipv6 route static enable
```

5. **(Optional)** Permanently delete the IPv6 static route configuration:

```
clear ipv6 route static [vrf WORD<1-16> | vrfids WORD<0-512>]
```

Example

Enable IPv6 static routes globally:

```
Switch:1(config)#ipv6 route static enable
```

Create and enable a static route through a global nexthop:

```
Switch:1(config)#ipv6 route 4000::/64 cost 1 next-hop 3000::2 enable
```

Create and enable a static route through an outgoing interface (VLAN or brouter port):

```
Switch:1(config)# ipv6 route 4000::/64 cost 1 vlan 1900 enable
```

Create and enable a static route through a link local nexthop and an outgoing interface:

```
Switch:1(config)# ipv6 route 4000::/64 cost 1 next-hop fe80::1 vlan 1900 enable
```

In the preceding example, you must specify the outgoing interface so that the system can apply the correct context to the link-local address.

Variable definitions

Use the data in the following table to use the `ipv6 route` command.

Variable	Value
<code>WORD <0–46></code>	Specifies the IPv6 destination address and prefix.
<code>enable</code>	Enables the static route. The default is enabled.
<code>cost <1–65535></code>	Specifies the cost or distance ratio to reach the destination for this static route. The default is 1.
<code>next-hop Word <0–46></code>	Specifies the IPv6 address of the next hop on this route. You do not need to specify the next hop if the devices directly connect to one another. Configure the next hop if the two nodes do not share the same network prefix but reside on the same link.
<code>preference <1–255></code>	Specifies the routing preference of the destination IPv6 address. The default is 5.
<code>{slot/port[/sub-port]}</code>	Identifies a single slot and port. If your platform supports channelization and the port is channelized, you must also specify the sub-port in the format slot/port/sub-port.
<code>tunnel <1–2000></code>	Specifies the tunnel ID.
<code>vlan <1-4059></code>	Specifies the VLAN ID in the range of 1 to 4059. By default, VLAN IDs 1 to 4059 are configurable and the system reserves VLAN IDs 4060 to 4094 for internal use. On switches that support the vrf-scaling and spbm-config-mode boot configuration flags, if you enable these flags, the system also reserves VLAN IDs 3500 to 3998. VLAN ID 1 is the default VLAN and you cannot create or delete VLAN ID 1.

Viewing routes information

View routes information to view the current configuration.

About this task

Not all parameters are available in non-default VRFs.

Procedure

1. Log on to the switch to enter User EXEC mode.
2. Show route information for alternative routes:

```
show ipv6 route alternative [vrf WORD<1-16> | vrfids WORD<1-256>]
```

3. Show the number of OSPF, RIP, static, and local routes:

```
show ipv6 route count-summary [vrf WORD<1-16> | vrfids WORD<1-256>]
```

4. Show route information for a destination:

```
show ipv6 route dest WORD<0-46> [vrf WORD<1-16> | vrfids WORD<1-256>]
```

5. Show route information for a port:

```
show ipv6 route gigabitethernet {slot/port[sub-port]}
```

6. Show route information for a next-hop address:

```
show ipv6 route next-hop WORD<0-46> [vrf WORD<1-16> | vrfids WORD<1-256>]
```

7. Show route information for an SPBM IPv6 route:

```
show ipv6 route spbm-nh-as-mac
```

8. Show route information for a static route:

```
show ipv6 route static [vrf WORD<1-16> | vrfids WORD<1-256>]
```

9. Show route information for a tunnel:

```
show ipv6 route tunnel <1-2000>
```

10. Show route information for a VLAN:

```
show ipv6 route vlan <1-4059>
```

Example

```
Switch:1(config-if)#show ipv6 route
=====
IPv6 Routing Table Information - GlobalRouter
=====
Destination Address/PrefixLen      NEXT HOP          VID/BID/TID  PROTO  COST  AGE  TYPE
-----
PREF
-----
22:0:0:0:0:0:0:0/64                0:0:0:0:0:0:0:0  V-22        LOCAL  1     0    B
0
22:0:0:0:0:0:0:0/22/128            0:0:0:0:0:0:0:0  V-22        LOCAL  1     0    B
0
123:0:0:0:0:0:0:0/64                0:0:0:0:0:0:0:0  C-1         LOCAL  1     0    B
0
123:0:0:0:0:0:0:0/123/128          0:0:0:0:0:0:0:0  C-1         LOCAL  1     0    B
0
-----
4 out of 4 Total Num of Route Entries displayed.
-----
TYPE Legend:
A=Alternative Route, B=Best Route, E=Ecmp Route
```

```
Switch:1#show ipv6 route count-summary
=====
IPv6 Route Summary - GlobalRouter
=====
TOTAL      OSPF      RIP      BGP      STATIC    LOCAL     ISIS
-----
13         10       0        3        1         2        7
```

```
Switch:1#show ipv6 route static
```

```
=====
                          Static Route Information - GlobalRouter
=====
DEST-IP                    NET IFINDX(VID/BRT/TUN) ENABLE  STATUS
NEXT-HOP                   PREFERENCE
-----
22:0:0:0:0:0:0:0          64 2059 (V-11      ) enable  NotReachable
66:0:0:0:0:0:0:66        5
1 out of 1 Total Num of Static Routes displayed.
Global IPv6 Static Routes Admin Status: enable
```

```
Switch:1#show ipv6 route spbm-nh-as-mac
```

```
=====
                          IPv6 Routing Table Information - GlobalRouter
=====
Destination Address/PrefixLen  NEXT HOP                VID/BID/TID  PROTO  COST
-----
2001:cdab:0:0:0:0:0:0/32      0:0:0:0:0:0:0:0        V-611        LOCAL  1
2001:cdab:0:0:0:0:0:1/128    0:0:0:0:0:0:0:0        V-611        LOCAL  1
2002:cdab:0:0:0:0:0:0/32      80:2d:30:00:00:01      V-10         ISIS   1
```

Variable definitions

Use the data in the following table to use the `show ipv6 route` command.

Variable	Value
count-summary	Shows the total number of OSPF, static, and local routes.
dest <i>WORD</i> <0-46>	Specifies the IPv6 destination network address. The prefix value must match the prefix length.
next-hop <i>WORD</i> <0-46>	Specifies the IPv6 address of the next hop on this route.
spbm-nh-as-mac	Shows the B-MAC address as the next hop rather than the host name.
{slot/port[/sub-port]}	Identifies a single slot and port. If your platform supports channelization and the port is channelized, you must also specify the sub-port in the format slot/port/sub-port.
<i>static</i>	Shows static IPv6 routes.
tunnel <1-2000>	Shows route entries for a specific tunnel ID.
vlan<1-4059>	Shows route entries for a specific VLAN ID.
vrf <i>WORD</i> <1-16>	Shows the VRF name.
vrfids <i>WORD</i> <1-256>	Shows the VRF ID.

Creating an IPv6 CLIP interface

About this task

Perform this procedure to create an IPv6 CLIP interface and associate it with a specific VRF.

Procedure

1. Enter Loopback Interface Configuration mode

```
enable
configure terminal
interface Loopback <1-256>
```
2. Create an IPv6 loopback interface address:

```
ipv6 interface address WORD <0-255> vrf WORD <1-16>
```
3. Ensure the configuration is correct:

```
show ipv6 interface loopback <1-256>
```

Example

```
Switch:1#show ipv6 interface loopback
=====
                        Loopback IPv6 Interfaces
=====
IF   VRF      Descr      VLAN  PHYSICAL      ADMIN  OPER  TYPE  MTU  HOP  REACHABLE  RETRANSMIT  IPSEC
INDX NAME                                           ADDRESS      STATE  STATE  TYPE  MTU  LMT  TIME  TIME  TIME  STATE
-----
1348 GlobalRouter  CLIPv6-5  --    00:00:00:00:00:05  enable  up    ETHER 1500 64  30000  1000  disable

=====
                        Loopback IPv6 Addresses
=====
IPv6 ADDRESS/PREFIX LENGTH      LOOPBACK-ID  TYPE  ORIGIN  STATUS
-----
2001:db8:0:0:0:0:0:ffff/32      C-5          UNICAST MANUAL  PREFERRED INF  INF

Legend: NA - Information not available

1 out of 1 Total Num of Interface Entries displayed.
1 out of 1 Total Num of Address Entries displayed.
```

Variable definitions

Use the data in the following table to use the `ipv6` commands.

Variable	Value
WORD<1–256>	Specifies the CLIP interface ID.
WORD<0–255>	Specifies the IPv6 address.
vrf WORD<1–16>	Specifies the VRF name.

Enabling IPv6 ECMP

About this task

Use the following procedure to enable IPv6 ECMP globally or on a specific VRF. IPv6 ECMP is disabled by default.

Procedure

1. Enter either Global Configuration mode or VRF Router Configuration mode for a specific VRF context:

```
enable
configure terminal
router vrf WORD<1-16>
```

2. Enter the following command to enable IPv6 ECMP:

```
ipv6 ecmp enable
```

3. Set the default value, IPv6 ECMP is disabled by default.

```
default ipv6 ecmp enable
```

4. Disable IPv6 ECMP globally:

```
no ipv6 ecmp enable
```

Variable definitions

Use the data in the following table to use the `ipv6 ecmp` command.

Variable	Value
<code>enable</code>	Enables IPv6 ECMP globally.  Note: <ul style="list-style-type: none"> • Enabling IPv6 ECMP sets the maximum number of paths configured to its default value. This value is either 4 or 8 depending on your hardware platform. • Disabling IPv6 ECMP sets the maximum number of paths configured to 1.

Configuring maximum number of ECMP paths

Before you begin

Enable ECMP on the switch before configuring the max-path value. For more information, see [Enabling IPv6 ECMP](#) on page 56.

About this task

Use the following procedure to configure the maximum number of ECMP paths.

Procedure

1. Enter either Global Configuration mode or VRF Router Configuration mode for a specific VRF context:

```
enable
configure terminal
router vrf WORD<1-16>
```

2. Configure the maximum number of ECMP paths.

```
ipv6 ecmp max-path <ECMP-Paths>
```

3. Set the configured maximum number of ECMP paths to its default value:

```
default ipv6 ecmp max-path
```

* Note:

The default value for max-path is the maximum value, which varies depending on your hardware platform.

Example

```
Switch:1>enable
Switch:1#configure terminal
```

Enable ECMP on the switch:

```
Switch:1(config)#ipv6 ecmp enable
```

Configure the maximum number of ECMP paths to 4:

```
Switch:1(config)#ipv6 ecmp max-path 4
```

Variable definitions

Use the data in the following table to use the `ipv6 ecmp max-path` command.

Variable	Value
<ECMP-Paths>	Configures the maximum number of ECMP paths. Different hardware platforms can support a different number of ECMP paths. For more information on the maximum number of ECMP paths supported on your switch, see the scaling information in <i>Release Notes</i> . When ECMP is enabled, the default value is either 4 or 8 depending on your hardware platform.

Enabling or disabling IPv6 ICMP multicast

On disabling the ICMP multicast processing, ICMPv6 Echo Request packets sent to IPv6 multicast addresses are dropped when they reach the control plane.

About this task

Use this procedure to enable or disable the IPv6 ICMP multicast on the global router.

Procedure

1. Enter either Global Configuration mode or VRF Router Configuration mode for a specific VRF context:

```
enable
configure terminal
router vrf WORD<1-16>
```

2. Enable IPv6 ICMP multicast, enter:

```
ipv6 icmp echo-multicast-request
```

3. Disable IPv6 ICMP multicast, enter:

```
no ipv6 icmp echo-multicast-request
```

4. Set IPv6 ICMP multicast to default state, enter:

```
default ipv6 icmp echo-multicast-request
```

Note:

By default, the IPv6 ICMP multicast feature is enabled.

5. View the IPv6 ICMP multicast state:

```
show ipv6 global [vrf WORD<1-16> | vrfids WORD<0-512>]
```

Enabling Stateless Address Autoconfiguration

Enable IPv6 Stateless Address Autoconfiguration to generate addresses using a combination of locally available information and information advertised by routers.

The default is disabled.

Procedure

1. Enter Global Configuration mode:

```
enable
configure terminal
```

2. Enable IPv6 autoconfiguration:

```
ipv6 autoconfig
```

Example

```
Switch:1(config)#ipv6 autoconfig
```

The following example shows a sample output for the `show ipv6 global` command.

```
Switch:1#show ipv6 global
  forwarding                : disable
  default-hop-cnt           : 64
  number-of-interfaces      : 2
  icmp-error-interval       : 1000
  icmp-error-quota         : 50
  icmp-unreach-msg         : disable
  icmp-addr-unreach-msg    : enable
  icmp-port-unreach-msg    : enable
  icmp-echo-multicast-request : enable
  static-route-admin-status : enable
  alternative-route        : enable
  ecmp                     : disable
  ecmp-max-path            : 1
  source-route             : disable
  host-autoconfig         : enable
```

Configuring route advertisement on the management port

Configure route advertisement in IPv6 on the management port for neighbor discovery (ND).

* Note:

Not all hardware platforms include a dedicated, physical management interface. For more information about supported interfaces, see your hardware documentation.

Procedure

1. Enter mgmtEthernet Interface Configuration mode:

```
enable
configure terminal
interface mgmtEthernet <mgmt | mgmt2>
```

2. Configure the number of neighbor solicitation messages from duplicate address detection:

```
ipv6 nd dad-ns <0-600>
```

3. Configure the hop limit sent in router advertisements:

```
ipv6 nd hop-limit <0-255>
```

Example

```
Switch:1(config-if)#ipv6 nd dad-ns 2
Switch:1(config-if)#ipv6 nd hop-limit 2
```

```
Switch:1(config-if)#show ipv6 nd interface mgmtethernet mgmt
```

```
=====
Mgmt Ipv6 Nd
=====
IFID MGMT-IF RTR-ADV MAX-INT MIN-INT LIFETIME MANAG OTHER DAD-NS MTU      HOP  REACHABLE RETRANSMIT
      FLAG  CONF                                FLAG  CONF                                LIMIT TIME      TIME
-----
64  mgmt   False  600    200    0      False False  2      0 (d)  2 (s)  0 (d)  0 (d)
```

Note: (s) = Set, (d) = Default, (i) = inherit.

1 out of 5 Total Num of Ipv6 ND Entries displayed.

Variable definitions

Use the data in the following table to use the `ipv6 nd` command.

Variable	Value
dad-ns <0-600>	<p>Specifies the number of neighbor solicitation messages for duplicate address detection (DAD).</p> <p>A value of 0 disables the DAD process on this interface.</p> <p>A value of 1 sends one advertisement without retransmissions.</p> <p>The default is 1.</p>
hop-limit <0-255>	<p>Specifies the current hop limit field sent in router advertisements from this interface.</p> <p>The value must be the current diameter of the Internet.</p> <p>A value of zero indicates that the advertisement does not specify a hop-limit value.</p> <p>The default is 64.</p>

Configuring process-redirect for management port

Configure process-redirect messages to honor or ignore redirect messages for the management port. Redirect messages are visible only when Stateless Address Autoconfiguration is configured on switches capable of routing IPv6 traffic.

The default is disabled.

* Note:

Not all hardware platforms include a dedicated, physical management interface. For more information about supported interfaces, see your hardware documentation.

Before you begin

- Disable IPv6 forwarding.
- Enable Stateless Address Autoconfiguration
- Create an IPv6 interface.
- Configure an IPv6 address.

Procedure

1. Enter mgmtEthernet Interface Configuration mode:

```
enable
configure terminal
interface mgmtEthernet <mgmt | mgmt2>
```

2. Configure process-redirect messages:

```
ipv6 interface process-redirect
```

3. Verify that process-redirect messages are configured on the management port.

```
Switch:1(config-if)#ipv6 interface process-redirect
```

Example

The following examples shows a sample output of the **show ipv6 interface process-redirect** command.

```
Switch:1#show ipv6 interface process-redirect
=====
Process ICMP redirect status
=====
IFINDEX      DESCR          VLAN          STATUS
-----
64           PORT-mgmt     4092          Enabled
192          VLAN-5        5             Disabled
2050         VLAN-2        2             Disabled
```

Viewing IPv6 default routers

View the table of default routers learned from router advertisement messages.

A maximum of four routers are visible in the default routers list.

Procedure

1. Log on to the switch to enter User EXEC mode.
2. Show IPv6 default routers:

```
show ipv6 default-routers
```

Example

```
Switch:1#show ipv6 default-routers
=====
Default Routers
NET ADDRESS          VLAN    LIFETIME    IS ACTIVE
-----
fe80::211:58ff:fe2b:fc00    mgmt    1778        YES
fe80::215:e8ff:fe6e:2800    mgmt    1657        NO
```

Job aid

The following table describes the fields in the output for the **show ipv6 default-routers** command.

Parameter	Description
net address	Shows the IPv6 router address received from a valid router advertisement.

Table continues...

Parameter	Description
VLAN <1–4059>	Shows the VLAN ID in the range of 1 to 4059. By default, VLAN IDs 1 to 4059 are configurable and the system reserves VLAN IDs 4060 to 4094 for internal use. If you enable VRF scaling and SPBM mode, the system also reserves VLAN IDs 3500 to 3999. VLAN ID 1 is the default VLAN and you cannot create or delete VLAN ID 1.
LIFETIME	Shows the value placed in the router lifetime field of router advertisements. This value must be either 0 or between 4 and 9000. A value of zero indicates that the system is not a default router. The default is 1800.
IS ACTIVE	Shows if the default router is active or inactive.

IPv6 basic configuration using EDM

Enabling the IPv6–mode boot config flag

 **Note:**

Enable this flag to support IPv6 routes with prefix-lengths greater than 64 bits.

This flag is disabled by default. Use this procedure to enable (set to true) the IPv6-mode boot config flag.

When the IPv6-mode boot config flag is enabled, the maximum number of IPv4 routing table entries decreases. For scaling information, see *Release Notes*.

Procedure

1. In the navigation pane, expand the following folders: **Configuration > Edit**,
2. Click **Chassis**.
3. Click the **Boot Config** tab.
4. Select the **EnableIpv6Mode** check box.
5. Click **Apply**.
6. Save the configuration, and then reboot the switch for the change to the IPv6-mode boot config flag to take effect.

Configuring IPv6 globally

Global configuration includes the following:

- IPv6 alternative routes: To avoid traffic interruption, enable alternative routes globally on the switch, to replace the best route with the next-best route if the best route becomes unavailable. By default, this feature is enabled.

Before you begin

Change the VRF instance as required to configure IPv6 globally on a specific VRF instance. Not all parameters are configurable on non-default VRFs.

Procedure

1. In the navigation tree, expand the **Configuration > IPv6** folders.
2. Click **IPv6**.
3. Click the **Globals** tab.
4. In the **DefaultHopLimit** box, enter the preferred number of hops before packets drop.
5. To enable ICMP network unreachable messages, click **IcmpNetUnreach**.
6. In the **IcmpErrorInterval** box, enter the preferred interval for sending ICMPv6 error messages.
7. In the **IcmpErrorQuota** box, enter the preferred number of ICMP error messages that the system can send during the ICMP error interval.
8. To enable IPv6 multicast, click **IcmpMulticastRequestEnable**.
9. To enable IPv6 ICMP address unreachable messages, click **IcmpAddrUnreach**.
10. To enable IPv6 ICMP port unreachable messages, click **IcmpPortUnreach**.
11. To enable IPv6 autoconfiguration, click **Autoconfig**.
12. To enable IPv6 static routes globally, click **StaticRouteGlobalAdminEnabled**.
13. To enable IPv6 Source Routing, click **SourceRouteEnable**.
14. To clear all IPv6 static routes, click **RouteStaticClear**.
15. To enable IPv6 alternative routes, click **AlternativeRouteEnable**.
16. To configure IPv6 ECMP globally, select **enable** or **disable**, in the **EcmpEnable** option box.
17. In the **EcmpMaxPath** box, enter the preferred number of equal-cost paths.
18. Click **Apply**.

Globals field descriptions

Use the data in the following table to use the **Globals** tab.

Name	Description
Forwarding	Configures whether this switch is an IPv6 router with respect to the forwarding of datagrams received by, but not addressed to, the switch. Select forwarding for the switch to act as a router for IPv6 traffic. Select notForwarding to not act as a router for IPv6 traffic. The default is forwarding . You must enable forwarding to use Telnet or Ping with IPv6.
DefaultHopLimit	Configures the hop limit. The default is 64.
Interfaces	Shows the number of interfaces.
IfTableLastChange	Shows the date of the last interface table change.
IcmpNetUnreach	Enables ICMP network unreachable messages. The default is disabled.
IcmpErrorInterval	Configures the interval (in milliseconds) for sending ICMPv6 error messages. The default is 1000. An entry of 1 seconds results in no sent ICMPv6 error messages.
IcmpErrorQuota	Configures the number of ICMP error messages that the system can send during the ICMP error interval. A value of zero specifies not to send any. The default value is 50.
IcmpMulticastRequestEnable	Globally enables or disables the IPv6 ICMP echo multicast request feature. This is enabled by default.
IcmpAddrUnreach	Enables or disabled ICMP address unreachable messages. This is enabled by default.
IcmpPortUnreach	Enables or disables ICMP port unreachable messages. This is enabled by default.
Autoconfig	Enables or disables stateless address autoconfiguration. This is disabled by default.
StaticRouteGlobalAdminEnabled	Enables IPv6 static routes globally. If you disable static routes globally, the system removes all enabled static routes from the RTM and does not add new static routes to the RTM. The default is enabled.
RouteStaticClear	Clears all IPv6 static routes.

Table continues...

Name	Description
SourceRouteEnable	Globally enables or disables the IPv6 Source Routing feature. It is disabled by default.
PrefixListTableSize	Displays the prefix list table size.
RoutePrefTableSize	Displays the route preference table size.
AlternativeRouteEnable	Globally enables or disables the IPv6 alternative route feature. By default, this feature is enabled.
EcmpEnable	Enables or disables the IPv6 ECMP globally. By default, it is disabled.
EcmpMaxPath	<p>Globally configures the maximum number of ECMP paths.</p> <p>The number of paths supported is either 1 to 4 or 1 to 8, depending on your hardware platform.</p> <p>When ECMP is enabled, the default value is either 4 or 8 depending on your hardware platform.</p> <p>You cannot configure this feature unless ECMP is enabled globally.</p>

Configuring an IPv6 interface

You must configure an IPv6 interface for a VLAN or brouter port before you can assign an IPv6 address to the interface.

Before you begin

- You must configure a VLAN before you can give the VLAN an interface identifier or an IPv6 address. The switch supports port-based, protocol-based, and MAC-source-based VLANs.

For information about how to configure VLANs, see the following documents:

- *Configuring VLANs, Spanning Tree, and NLB*
- *Configuring Link Aggregation, MLT, SMLT, and vIST*
- Change the VRF instance as required to configure an IPv6 interface on a specific VRF instance. Not all parameters are configurable on non-default VRFs.

About this task

You can also configure an IPv6 interface for a brouter port through the **Edit > Port > IPv6** navigation path, and for a VLAN through the **VLAN > VLANs > Basic > IPv6** navigation path. This procedure uses the main IPv6 navigation path where you can create both types of interfaces.

Procedure

- In the navigation pane, expand the **Configuration > IPv6** folders.
- Click **IPv6**.
- Click the **Interfaces** tab.

4. Click **Insert**.
5. In the **Interface** field, click **Port** or **VLAN**.
6. Select a port or VLAN.
7. Click **OK**.
8. Select the **AdminStatus** field to activate the interface.
9. Configure the remaining parameters as required.
10. Click **Insert**.
11. Click **Apply**.

Interfaces field descriptions

Use the data in the following table to use the **Interfaces** tab.

Name	Description
Interface	Specifies the port or VLAN.
Identifier	Shows the IPv6 address interface identifiers. This value is a binary string of up to 8 octets in network byte-order.
IdentifierLength	Shows the length of the identifier, in bits.
Descr	Specifies a description of the interface. The network management system also configures this string.
VlanId	Specifies the VLAN ID in the range of 1 to 4059. By default, VLAN IDs 1 to 4059 are configurable and the system reserves VLAN IDs 4060 to 4094 for internal use. On switches that support the vrf-scaling and spbm-config-mode boot configuration flags, if you enable these flags, the system also reserves VLAN IDs 3500 to 3998. VLAN ID 1 is the default VLAN and you cannot create or delete VLAN ID 1. This value corresponds to the lower 12 bits of the IEEE 802.1Q VLAN tag.
Type	Shows the interface type.
ReasmMaxSize(MTU)	Specifies the maximum size of the MTU of this IPv6 interface. This value must be the same for all the IP addresses defined on this interface. The default value is 1500. Different hardware platforms support different MTU values.
PhysAddress	Specifies the media-dependent physical address. For Ethernet, this is a MAC address.
AdminStatus	Specifies if IPv6 is active on this interface. The default is false (disabled).

Table continues...

Name	Description
OperStatus	Specifies the current operational status of the interface.
ReachableTime	Specifies the time, in milliseconds, that a neighbor is considered reachable after receiving a reachability confirmation. The default is 30000.
RetransmitTimer	Specifies the time, in milliseconds, between retransmissions of neighbor solicitation messages to a neighbor when resolving the address, or when probing the reachability of a neighbor. The default is 1000.
CurHopLimit	Specifies the current hop limit field sent in router advertisements from this interface. The value must be the current diameter of the Internet. A value of zero indicates that the advertisement does not specify a value for CurHopLimit. The default is 64.
MulticastAdminStatus	The option to select MulticastAdminStatus is disabled. You cannot configure the administrative status for multicast in this context.
MacOffset	Requests a particular MAC for an IPv6 VLAN. You can specify a MAC offset when you configure IPv6 on a VLAN, or the system can assign a MAC address from within the available range. Different hardware platforms support different MAC offset ranges.
RSMLTEnable	Shows whether RSMLT is enabled on the interface. The default value is disabled (false).
ProcessRedirect	Shows whether ND Redirect messages processing is enabled or disabled on this interface. The default value is disabled (false).

Configuring an IPv6 router port interface

You must configure an IPv6 interface for a router port before you can assign an IPv6 address to the interface.

Procedure

1. In the Device Physical View, select a port.
2. In the navigation pane, expand the **Configuration > Edit > Port** folders.
3. Click **IPv6**.
4. Click the **IPv6 Interface** tab.

5. Click **Insert**.
6. Enter the interface identifier.
7. Select the **AdminStatus** field to activate the interface.
8. Configure the remaining parameters as required.
9. Click **Insert**.
10. Click **Apply**.

Interfaces field descriptions

Use the data in the following table to use the **Interfaces** tab.

Name	Description
Interface	Specifies the port or VLAN.
Identifier	Shows the IPv6 address interface identifiers. This value is a binary string of up to 8 octets in network byte-order.
IdentifierLength	Shows the length of the identifier, in bits.
Descr	Specifies a description of the interface. The network management system also configures this string.
VlanId	Specifies the VLAN ID in the range of 1 to 4059. By default, VLAN IDs 1 to 4059 are configurable and the system reserves VLAN IDs 4060 to 4094 for internal use. On switches that support the vrf-scaling and spbm-config-mode boot configuration flags, if you enable these flags, the system also reserves VLAN IDs 3500 to 3998. VLAN ID 1 is the default VLAN and you cannot create or delete VLAN ID 1. This value corresponds to the lower 12 bits of the IEEE 802.1Q VLAN tag.
Type	Shows the interface type.
ReasmMaxSize(MTU)	Specifies the maximum size of the MTU of this IPv6 interface. This value must be the same for all the IP addresses defined on this interface. The default value is 1500. Different hardware platforms support different MTU values.
PhysAddress	Specifies the media-dependent physical address. For Ethernet, this is a MAC address.
AdminStatus	Specifies if IPv6 is active on this interface. The default is false (disabled).
OperStatus	Specifies the current operational status of the interface.

Table continues...

Name	Description
ReachableTime	Specifies the time, in milliseconds, that a neighbor is considered reachable after receiving a reachability confirmation. The default is 30000.
RetransmitTimer	Specifies the time, in milliseconds, between retransmissions of neighbor solicitation messages to a neighbor when resolving the address, or when probing the reachability of a neighbor. The default is 1000.
CurHopLimit	Specifies the current hop limit field sent in router advertisements from this interface. The value must be the current diameter of the Internet. A value of zero indicates that the advertisement does not specify a value for CurHopLimit. The default is 64.
MulticastAdminStatus	The option to select MulticastAdminStatus is disabled. You cannot configure the administrative status for multicast in this context.
MacOffset	Requests a particular MAC for an IPv6 VLAN. You can specify a MAC offset when you configure IPv6 on a VLAN, or the system can assign a MAC address from within the available range. Different hardware platforms support different MAC offset ranges.
RSMLTEnable	Shows whether RSMLT is enabled on the interface. The default value is disabled (false).
ProcessRedirect	Shows whether ND Redirect messages processing is enabled or disabled on this interface. The default value is disabled (false).

Configuring an IPv6 VLAN interface

You must configure an IPv6 interface for a VLAN before you can assign an IPv6 address to the interface.

Before you begin

- You must configure a VLAN before you can give the VLAN an interface identifier or an IPv6 address. The switch supports port-based, protocol-based, and MAC-source-based VLANs.

For information about how to configure VLANs, see the following documents:

- *Configuring VLANs, Spanning Tree, and NLB*
- *Configuring Link Aggregation, MLT, SMLT, and vIST*

Procedure

1. In the navigation pane, expand the **Configuration > VLAN** folders.
2. Click **VLANs**.
3. Click the **Basic** tab.
4. Select a VLAN.
5. Click **IPv6**.
6. Click the **IPv6 Interface** tab.
7. Click **Insert**.
8. Enter the interface identifier.
9. Select the **AdminStatus** field to activate the interface.
10. Configure the remaining parameters as required.
11. Click **Insert**.
12. Click **Apply**.

IPv6 Interfaces field descriptions

Use the data in the following table to use the IPv6 Interfaces tab.

Name	Description
Interface	Specifies the port or VLAN.
Identifier	Shows the IPv6 address interface identifiers. This value is a binary string of up to 8 octets in network byte-order.
IdentifierLength	Shows the length of the identifier, in bits.
Descr	Specifies a description of the interface. The network management system also configures this string.
VlanId	Specifies the VLAN ID in the range of 1 to 4059. By default, VLAN IDs 1 to 4059 are configurable and the system reserves VLAN IDs 4060 to 4094 for internal use. On switches that support the vrf-scaling and spbm-config-mode boot configuration flags, if you enable these flags, the system also reserves VLAN IDs 3500 to 3998. VLAN ID 1 is the default VLAN and you cannot create or delete VLAN ID 1. This value corresponds to the lower 12 bits of the IEEE 802.1Q VLAN tag.
Type	Shows the interface type.
ReasmMaxSize(MTU)	Specifies the maximum size of the MTU of this IPv6 interface. This value must be the same for all the IP

Table continues...

Name	Description
	addresses defined on this interface. The default value is 1500.
PhysAddress	Specifies the media-dependent physical address. For Ethernet, this is a MAC address.
AdminStatus	Specifies if IPv6 is active on this interface. The default is false (disabled).
OperStatus	Specifies the current operational status of the interface.
ReachableTime	Specifies the time, in milliseconds, that a neighbor is considered reachable after receiving a reachability confirmation. The default is 30000.
RetransmitTimer	Specifies the time, in milliseconds, between retransmissions of neighbor solicitation messages to a neighbor when resolving the address, or when probing the reachability of a neighbor. The default is 1000.
CurHopLimit	Specifies the current hop limit field sent in router advertisements from this interface. The value must be the current diameter of the Internet. A value of zero indicates that the advertisement does not specify a value for CurHopLimit. The default is 64.
MulticastAdminStatus	The option to select MulticastAdminStatus is disabled. You cannot configure the administrative status for multicast in this context.
MacOffset	Requests a particular MAC for an IPv6 VLAN. You can specify a MAC offset when you configure IPv6 on a VLAN, or the system can assign a MAC address from within the available range. Different hardware platforms support different MAC offset ranges.
RSMLTEnable	Shows whether RSMLT is enabled on the interface. The default value is disabled (false).
ProcessRedirect	Shows whether ND Redirect messages processing is enabled or disabled on this interface. The default value is disabled (false).

Assigning IPv6 addresses to interfaces

Assign IPv6 addresses to interfaces to configure IPv6 routing for the interface.

You can assign an IPv6 address to a VLAN or router port.

Before you begin

Change the VRF instance as required to assign IPv6 addresses to interfaces on a specific VRF instance. Not all parameters are configurable on non-default VRFs.

About this task

To create MLT and LAG interfaces with IPv6, you must configure VLAN-based connections and you cannot use brouter ports.

Procedure

1. In the navigation pane, expand the following folders: **Configuration > IPv6**.
2. Click **IPv6**.
3. Click the **Addresses** tab.
4. Click **Insert**.
5. In the **Interface** field, click **Port** or **VLAN**.
6. Select the interface.
7. Click **OK**.
8. Type the IPv6 address and prefix length.
9. Click **Insert**.
10. Click **Apply**.

Addresses field descriptions

Use the data in the following table to use the Addresses tab.

Name	Description
Interface	Specifies the interface to which this entry applies.
Addr	Specifies the IPv6 address to which this entry applies.  Important: If the IPv6 address exceeds 116 octets, the object identifiers (OIDs) of instances of columns in this row are more than 128 subidentifiers and you cannot use SNMP-v1, SNMPv2c, or SNMPv3 to access them.
AddrLen	Specifies the prefix length value for this address. You cannot change the address length after you create it. You must provide this value to create an entry in this table.
Type	Specifies the type of address. The default is unicast.

Table continues...

Name	Description
Origin	Specifies the origin of the address. The following list shows the possible origins: <ul style="list-style-type: none"> • other • manual • dhcp • linklayer • random
Status	Specifies the status of the address, describing whether the address is used for communication. The following list shows the possible statuses: <ul style="list-style-type: none"> • preferred (default) • deprecated • invalid • inaccessible • unknown • tentative • duplicate
Created	Specifies the sysUpTime of the creation of this entry. If the entry was created prior to the last reinitialization of the local management subsystem, the object contains a zero value.
LastChanged	Specifies the value of sysUpTime of the last modification to this entry. If the entry was created prior to the last reinitialization of the local management subsystem, the object contains a zero value.
ValidLifetime	Shows how long, in seconds, the address is valid.
PrefLifetime	Shows how long, in seconds, the address is in use.

Assigning IPv6 addresses to a brouter port interface

Assign IPv6 addresses to interfaces to configure IPv6 routing for the interface.

You can assign an IPv6 address to a VLAN or brouter port.

Before you begin

Change the VRF instance as required to assign IPv6 addresses to a brouter port interface on a specific VRF instance. Not all parameters are configurable on non-default VRFs.

About this task

To create MLT and LAG interfaces with IPv6, you must configure VLAN-based connections and you cannot use brouter ports.

Procedure

1. In the navigation pane, expand the following folders: **Configuration > Edit > Port**.
2. Click **IPv6**.
3. Click the **Ipv6 Addresses** tab.
4. Click **Insert**.
5. Click **Insert**.
6. Click **Apply**.

IPv6 Addresses field descriptions

Use the data in the following table to use the IPv6 Addresses tab.

Name	Description
Interface	Specifies the port.
Addr	Specifies the IPv6 address to which this entry applies.  Note: If the IPv6 address exceeds 116 octets, the object identifiers (OIDs) of instances of columns in this row are more than 128 subidentifiers and you cannot use SNMP-v1, SNMPv2c, or SNMPv3 to access them.
AddrLen	Specifies the prefix length value for this address. You cannot change the address length after you create it. You must provide this value to create an entry in this table.
Type	Specifies the type of address. The default is unicast.
Origin	Specifies the origin of the address.
Status	Specifies the status of the address, describing whether the address is used for communication.
Created	Specifies the sysUpTime of the creation of this entry. If the entry was created prior to the last reinitialization of the local management subsystem, the object contains a zero value.
LastChanged	Specifies the value of sysUpTime of the last modification to this entry. If the entry was created prior to the last reinitialization of the local management subsystem, the object contains a zero value.

Assigning an IPv6 address to a VLAN

Assign an IPv6 address to a VLAN.

Procedure

1. In the navigation pane, expand the **Configuration > VLAN** folders.
2. Click **VLANs**.
3. Click the **Basic** tab.
4. Select a VLAN interface.
5. Click **IPv6**.
6. Click the **IPv6 Addresses** tab.
7. Click **Insert**.
8. Type the IPv6 address and length in the fields.
9. Click **Insert**.
10. Click **Apply**.

IPv6 Addresses field descriptions

Use the data in the following table to use the IPv6 Addresses tab.

Name	Description
Interface	Identifies the address to which the address is assigned.
Addr	Specifies an IP address that is associated with a VLAN.
AddrLen	Specifies the prefix address length value for this address.
Type	Specifies the type of address: either unicast or anycast.
Origin	Specifies the origin of the address as one of the following: <ul style="list-style-type: none"> • other • manual • dhcp • linklayer • random
Status	Shows the status of the address and if it can be used for communication.

Table continues...

Name	Description
Created	Shows the time this address entry was created.
LastChanged	Shows the time this address entry was last updated.

Creating IPv6 static routes

Use static routes to manually configure routes to destination IPv6 address prefixes.

Before you begin

- Enable IPv6 forwarding.
- Change the VRF instance as required to create IPv6 static routes on a specific VRF instance. Not all parameters are configurable on non-default VRFs.

Procedure

1. In the navigation tree, expand the following folders: **Configuration > IPv6**.
2. Click **IPv6**.
3. Click the **Globals** tab.
4. Select the **StaticRouteGlobalAdminEnabled** check box.
If you disable static routes globally, the system removes all enabled static routes from the RTM and does not add new static routes to the RTM. The default is enabled.
5. Click **Apply**.
6. Click the **Static Routes** tab.
7. Click **Insert**.
8. In the **Dest** field, type the IPv6 address.
9. In the **PrefixLength** field, type the length of the prefix for the IPv6 address.
10. In the **NextHop** field, type the IPv6 address of the router through which the specified route is accessible.
11. Beside the **Interface** field, click **Port** or **Vlan** or **Tunnel**.
12. Select the interface, and then click **OK**.
13. In the **Cost** field, type a number for the distance.
14. Select the **Enable** check box.
15. Click **Insert**.

Static Routes field descriptions

Use the data in the following table to use the **Static Routes** tab.

Name	Description
Dest	Specifies the IPv6 destination network address. The prefix value must match the PrefixLength.
PrefixLength	Specifies the number bits you want to advertise from the prefix. The prefix value must match the value in the Dest field. The range is 0 to 128.
NextHop	Specifies the IPv6 address of the next hop on this route. You do not need to specify the next hop if the devices directly connect to one another. Configure the next hop if the two nodes do not share the same network prefix but reside on the same link.
Interface	Specifies the interface to which this entry applies. You must specify the port or VLAN if the next hop is a link-local address.
Cost	Specifies the cost or distance ratio to reach the destination for this node. The range is 1-65535. The default value is 1.
Enable	Enables the static route on the port. The default value is enable.
Status	<p>Shows the status of the static route as one of the following:</p> <ul style="list-style-type: none"> • notReachable: The route is not reachable and no neighbor request entry is built to resolved the next-hop. This status appears if no route or neighbor exists to reach the next-hop of the static route. • tryToResolve: The route is not reachable but a neighbor request entry is built to resolve the next-hop. This status appears if a local equivalent route exists in the system to reach the next-hop but the neighbor is not learned. • reachableNotInRtm: The static route is reachable but it is not in RTM. This status appears if the static route is reachable, but it is not the best among alternative static routes. • reachableInRtm: The static route is reachable and it is in RTM. This status appears if the static route is reachable, and it is the best among alternative static routes to be added into RTM.
Preference	Specifies the routing preference of the destination IPv6 address. The range is 1-255. The default value is 5.

Configuring IPv6 route preferences

Change IPv6 route preferences to force the routing protocols to prefer one route over another. Configure route preferences to override default route preferences and give preference to routes learned for a specific protocol.

Before you begin

Change the VRF instance as required to configure IPv6 route preferences on a specific VRF instance. Not all parameters are configurable on non-default VRFs.

About this task

Important:

Changing route preferences is a process-oriented operation that can affect system performance and network reachability while you perform the procedures. If you want to change default preferences for routing protocols, do so before you enable the protocols.

Procedure

1. In the navigation pane, expand the following folders: **Configuration > IPv6**.
2. Click **IPv6**.
3. Click the **RoutePref** tab.
4. In the **ConfiguredValue** column, double-click a parameter to change the preference for the given protocol.
5. Click **Apply**.

RoutePref field descriptions

Use the data in the following table to use the **RoutePref** tab.

Name	Description
DefaultValue	Specifies the default preference value for the specified protocol.
Protocol	Specifies the protocol name.
ConfiguredValue	Configures the preference value for the specified protocol.

Viewing route information

View routes information to view the current configuration.

Before you begin

Change the VRF instance as required to view route information on a specific VRF instance. Not all parameters are configurable on non-default VRFs.

Procedure

1. In the navigation tree, expand the following folders: **Configuration > IPv6**.
2. Click **IPv6**.
3. Click the **Routes** tab.

Routes field descriptions

Use the data in the following table to use the **Routes** tab.

Name	Description
Dest	Specifies the IPv6 destination network address. The prefix value must match the PrefixLength.
PfxLength	Specifies the number bits you want to advertise from the prefix. The prefix value must match the value in the Dest field. The range is 0 to 128.
Index	Specifies the unique value that identifies the route among the routes to the same network layer destination.
Interface	Specifies the interface to which this entry applies.
NextHop	Specifies the IPv6 address of the next hop on this route.
Protocol	Specifies the routing protocol, such as OSPF.
Metric	Specifies the metric assigned to this interface. The default value of the metric is the reference bandwidth or ifSpeed. The value of the reference bandwidth is configured by the rcOspf3ReferenceBandwidth object. For more information about reference bandwidth, see Globals field descriptions on page 168.
NextHopId	Identifier of the next-hop, hostname, or mac address.
Age	Specifies the number of seconds since the route was last updated or is last active.
Type	Specifies the type of route.
PathType	Specifies the type of path.
Pref	Specifies the preference.

Viewing IPv6 Default Routers

View the table of default routers learned from router advertisement messages.

A maximum of four routers are visible in the default routers list.

*** Note:**

Not all hardware platforms include a dedicated, physical management interface. For more information about supported interfaces, see your hardware documentation.

Procedure

1. In the navigation tree, expand the **Configuration > IPv6** folders.
2. Click **IPv6**.
3. Click the **Default Routers** tab.

Default Routers field descriptions

Use the data in the following table to use the Default Routers tab.

Name	Description
Address	Specifies the learned router address for an IPv6 default routers entry.
IfIndex	Specifies the interface number for an IPv6 default routers entry.
Lifetime	Specifies the remaining router lifetime.
Active	Specifies if the default router is active for an IPv6 default routers entry.

Configuring a Circuitless IPv6 interface

Before you begin

Change the VRF instance as required to configure a Circuitless IPv6 interface on a specific VRF instance. Not all parameters are configurable on non-default VRFs.

About this task

You can use a circuitless IPv6 (CLIPv6) interface to provide uninterrupted connectivity to your system.

Procedure

1. In the navigation pane, expand the **Configuration > IPv6** folders.
2. Click **IPv6**.
3. Click the **Circuitless IP** tab.
4. Click **Insert**.
5. In the **Interface** field, assign a CLIP interface number.
6. Type the IPv6 address and prefix length.

Circuitless IPv6 field descriptions

Use the data in the following table to use the **Circuitless IPv6** tab.

Name	Description
Interface	Specifies the interface to which this entry applies.
Addr	Specifies the IPv6 address to which this entry applies.
AddrLen	Specifies the prefix length value for this address. You cannot change the address length after you create it. You must provide this value to create an entry in this table.

Chapter 4: Neighbor discovery

This chapter provides concepts and procedures to complete IPv6 neighbor discovery configuration.

Neighbor discovery

IPv6 nodes (routers and hosts) on the same link use neighbor discovery (ND) to discover link-layer addresses and to obtain and advertise various network parameters and reachability information. ND combines the services for IPv4 with the Address Resolution Protocol (ARP) and router discovery. In IPv6 ND performs a function similar to ARP (Address Resolution Protocol) in IPv4.

Hosts use ND to discover the routers in the network that you can use as the default routers, and to determine the link-layer address of neighbors attached to local links. Routers also use ND to discover neighbors and link-layer information. ND updates the neighbor database with valid entries, invalid entries, and entries migrated to various locations.

The ND protocol provides the following services:

- address and prefix discovery

Hosts determine the set of addresses that are on-link for the given link. Nodes determine which addresses or prefixes are locally reachable or remote with address and prefix discovery.

- router discovery

Hosts discover neighboring routers with router discovery. Hosts establish neighbors as default packet-forwarding routers.

- parameter discovery

Hosts and routers discover link parameters such as the link MTU or the hop-limit value placed in outgoing packets.

- address autoconfiguration

Hosts configure an address for an interface with address autoconfiguration.

- duplicate address detection

Hosts and nodes determine if an address is assigned to another router or a host.

- address resolution

Hosts determine link-layer addresses (MAC for Ethernet) of the local neighbors (attached on the local network), provided the IP address is known.

Neighbor discovery

- next-hop determination

Hosts determine how to forward local or remote traffic with next-hop determination. The next hop can be a local or remote router.

- neighbor unreachability detection

Hosts determine if the neighbor is unreachable, and if address resolution must be performed again to update the database. For neighbors you use as routers, hosts attempt to forward traffic through alternative default routers.

- redirect

Routers inform the host of more efficient routes with redirect messages.

Neighbor discovery uses three components:

- host-router discovery

Host-router discovery performs the following functions:

- router discovery
- prefix discovery
- parameter discovery
- address autoconfiguration

- host-host communication

Host-host communication performs the following functions:

- address resolution
- next-hop determination
- neighbor unreachability detection
- duplicate address detection

- route redirect

Note:

When a neighbor transitions to the STALE state, to initiate Neighbor Unreachability detection (NUD), a duplicate copy of the traffic destined to this neighbor is sent to the switch Control Processor (CP) on a low priority queue (queue 0). The original packet is forwarded to this neighbor. Once NUD is initiated, the hardware records are updated and the traffic is no longer sent to the CP. When a high rate of such traffic is sent to CP, the switch can drop some of these packets due to the in built CP rate limiting feature, which protects the CP from DOS attacks.

Use the command `show qos cosq-stats cpu-port` to view drop statistics on the CPU queue. This design does not result in loss of traffic.

Use the command `ipv6 nd reachable-time <0-3600000>` to increase the default value of 3000 milliseconds which in turn delays the scenario of data path sending STALE neighbor destined packets to the CP.

Recommended values for reachable time is 180000, and for retransmit interval is 5000.

ND messages

The following table compares the ICMP message types.

Table 6: IPv4 and IPv6 neighbor comparison

IPv4 Function	IPv6 Function	Description
ARP request message	Neighbor solicitation message	A node sends this message to determine the link-layer address of a neighbor or to verify that a neighbor is still reachable through a cached link-layer address. You can also use neighbor solicitations for duplicate address detection.
ARP reply message	Neighbor advertisement	A node sends this message either in response to a received neighbor solicitation message or to communicate a link-layer address change.
ARP cache	Neighbor cache	The neighbor cache contains information about neighbor types on the network.
Gratuitous ARP	Duplicate address detection New VRRP master interface announcement	A host or node sends a request with its own IP address to determine if another router or host uses the address. If the sender receives a reply, then there is a device with a duplicate address. Both hosts and routers use this function. Gratuitous ARP can also be used to announce the new VRRP master interface so that all switches can adjust their MAC tables.
Router solicitation message (optional)	Router solicitation message (required)	The host sends this message after it detects a change in a network interface operational state. The message includes a request for routers to generate router advertisement immediately rather than at the scheduled time.
Router advertisement message (optional)	Router advertisement message (required)	Routers send this message to advertise their presence with various links and Internet parameters either periodically or in response to a router solicitation message. Router advertisements contain prefixes that you use for on-link determination or address configuration, and a suggested hop limit value.
Redirect message	Redirect message	Routers send this message to inform hosts of a better first hop for a destination.

Neighbor discovery cache

The neighbor discovery cache lists information about neighbors in the network and can contain the following types of neighbors:

- static: a configured neighbor

- local: a device on the local system
- dynamic: a discovered neighbor

The following table describes the states in the neighbor cache.

Table 7: Neighbor cache states

State	Description
Incomplete	<p>Address resolution is in progress and the system has not yet determined the link-layer address of the neighbor.</p> <p>The neighbor cache may also enter the Incomplete state when the switch cannot confirm subsequent reachability during the ND process for router neighbors. By contrast, the system deletes host neighbors, rather than enter the Incomplete state, if ND fails to confirm reachability.</p> <p> Tip:</p> <p>Router neighbors: when the R bit is set in the received neighbor advertisement</p> <p>Host neighbors: when the R bit is not set in the received neighbor advertisement</p>
Reachable	A node receives positive confirmation within the last reachable time period.
Stale	<p>Reachability of the neighbor is unknown.</p> <p>Until the system sends traffic to the neighbor, make no attempt to verify its reachability.</p>
Delay	<p>A time period longer than the reachable time period passes since the node received the last positive confirmation, and a packet was sent within the last DELAY_FIRST_PROBE_TIME period.</p> <p>If no reachability confirmation is received within the DELAY_FIRST_PROBE_TIME period after entering the DELAY state, neighbor solicitation is sent and the state changes to probe.</p>
Probe	Reachability confirmation is sought from the device every retransmit timer period.

The following events involve Layer 2 and Layer 3 interaction during processing and affect the neighbor cache:

- flushing the virtual LAN (VLAN) MAC
- removing a VLAN or brouter port
- performing an action on all VLANs
- removing a port from a VLAN

- removing a port from a spanning tree group (STG)
- removing a multilink trunk (MLT) group from a VLAN
- removing an MLT port from a VLAN
- removing an MLT port from an STG
- performing an action that disables a VLAN, such as removing all ports from a VLAN
- disabling a tagged port that is a member of multiple routable VLANs

Router discovery

IPv6 nodes discover routers on the local link with router discovery.

Router advertisement:

Configured interfaces on an IPv6 router send router-advertisement messages. Interfaces also send router advertisements in response to router-solicitation messages from IPv6 nodes on the link.

Router solicitation:

An IPv6 host without a configured unicast address sends router solicitation messages.

Host autoconfiguration

The switch can automatically configure a host (node), and assign IPv6 addresses automatically. This process is called stateless address autoconfiguration (SLAAC). The neighbor discovery (ND) protocol performs autoconfiguration.

Stateless autoconfiguration enables serverless basic configuration of IPv6 nodes and renumbering from a mathematical perspective.

Stateless autoconfiguration uses the following equation:

$$\text{Stateless autoconfiguration} = \text{network prefix (router advertisement)} + \text{IPv6 interface identifiers}$$

Stateless autoconfiguration uses the network prefix information in the router advertisement and integrates this with the interface ID to form the node global address(es).

* Note:

The switch cannot autoconfigure an IPv6 address local to itself because IPv6 routers do not process router advertisements in the same manner as hosts. That is, routers check only for consistency in information advertised in IPv6 Router Advertisements on the same link.

+ Tip:

You must manually assign all addresses/prefixes local to the switch.

Assuming an EUI-64 based interface ID is used, the IPv6 interface address is created from the 48-bit (6-byte) MAC address as follows:

1. EUI-64 hexadecimal digits 0xff-fe are inserted between the third and fourth bytes of the MAC address to obtain the EUI-64.

2. The universal or local bit, the second lower-order bit of the first byte of the MAC address, is complemented.

For example, the IPv6 identifier for host A uses the MAC address 00-AA-00-3F-2A-1C.

To automatically assign an address, the following occurs:

1. Convert to EUI-64 format
00-AA-00-FF-FE-3F-2A-1C

2. Complement the Universal/Local (U/L) bit.

The first byte in binary form is 00000000. When the seventh bit is complemented, it becomes 00000010 (0x02).

The result is 02-AA-00-FF-FE-3F-2A-1C or 2AA:FF:FE3F:2A1C.

Host A with MAC address 00-AA-00-3F-2A-1C, combined with network prefix 2001::/64 provided by router advertisement, uses an IPv6 address 2001::2AA:FF:FE3F:2A1C.

A host generates a link-local address with the prefix FE80 regardless of whether an IPv6 router is present or not.

The link-local address for a node with the MAC address 00-AA-00-3F-2A-1C is FE80::2AA:FF:FE3F:2A1C.

The following list explains the states of an autoconfiguration address:

- Tentative: the address is being verified as unique (link-local address)
- Valid: an address from which unicast traffic can be sent and received; can be in one of two states—either preferred or deprecated
- Preferred: an address for which uniqueness was verified for unrestricted use; can be in one of three states—either tentative, preferred, or deprecated
- Deprecated: an address that remains valid but is withheld for new communication
- Invalid: an address for which a node can no longer send or receive unicast traffic

Neighbor discovery configuration using the CLI

Configuring an IPv6 discovery prefix

Configure the discovery prefixes to send in router advertisement.

About this task

Hosts on the link use router advertisements to perform IPv6 autoconfiguration.

The discovery prefix controls which IPv6 addresses will be automatically configured, and for how long they are valid.

Procedure

1. Enter Interface Configuration mode:

```
enable
configure terminal
interface GigabitEthernet {slot/port[/sub-port] [-slot/port[/sub-port]] [, ...]} OR interface vlan <1-4059>
```

*** Note:**

If your platform supports channelization and the port is channelized, you must also specify the sub-port in the format slot/port/sub-port.

2. Create neighbor discovery prefixes for an interface:

```
ipv6 nd prefix-interface WORD<0-255> [eui <1-3>] [no-advertise] [no-autoconfig] [no-onlink]
```

3. Modify an existing neighbor discovery prefix:

```
ipv6 nd prefix WORD<0-255> infinite [no-advertise] [preferred-life <0-4294967295>] [valid-life <0-4294967295>]
```

Example

Create a new neighbor discovery prefix:

```
Switch:1(config-if)#ipv6 nd prefix-interface fd48:bfb6:4c09:9499::1/64
```

Variable definitions

Use the data in the following table to use the `ipv6 nd prefix` and `ipv6 nd prefix-interface` commands.

Variable	Value
eui <1-3>	<p>Configures the EUI address. The values are:</p> <ul style="list-style-type: none"> • (1) EUI not used • (2) EUI with Universal/Local bit (U/L) complement enabled • (3) EUI used without U/L <p>Use an EUI-64 interface ID in the address field. If enabled, use EUI, or use EUI-64 and the complement Universal/Local (U/L) bit. This operation provides for both global- and link-local addresses. After you create the entry, you cannot modify this value. This value is valid for use only when the prefix length is 64 or less. The default is EUI not used.</p> <p>If you select EUI not used, this configuration creates an IPv6 ND prefix but no associated IPv6 address on</p>

Table continues...

Variable	Value
	the router. IF you select either EUI used with UL complement or EUI used without UL complement, an associated IPv6 address is created by concatenating the specified prefix with the EUI-64 interface ID.
infinite	Configures the prefix valid lifetime so it never expires. The default is disabled, which means the prefix expires.
no-advertise	Removes the prefix from the neighbor advertisement. The default is disabled, which means the prefix is advertised.
no-autoconfig	Configures the prefix for use as the autonomous address configuration. This value is placed in the autoflag field in the prefix information option. The value is a 1-bit flag. The default is enabled.
no-onlink	Configures the prefix for use when determining if a node is online. This value is placed in the L-bit field in the prefix information option. The value is a 1-bit flag. The default is enabled.
preferred-life <0–4294967295>	<p>Configures the preferred lifetime in seconds that indicates the length of time this prefix is advertised. The default value is 604800.</p> <p>The preferred lifetime is the length of time for the tentative, preferred, and depreciated state of an autoconfiguration address.</p> <p>The preferred lifetime value must be less than the valid lifetime value. If you must configure the valid lifetime value to a value lower than the current preferred lifetime, you must lower the preferred lifetime value first.</p>
valid-life <0–0–4294967295>	<p>Configures the valid lifetime in seconds that indicates the length of time this prefix is advertised. The default is 2592000.</p> <p>A valid lifetime is the length of time of the preferred and depreciated state of an autoconfiguration address.</p> <p>The preferred lifetime value must be less than the valid lifetime value. If you must configure the valid lifetime to a value lower than the current preferred lifetime, you must lower the preferred lifetime value first.</p>
WORD <0–255>	Specifies the IPv6 address and prefix.

Use the data in the following table to use the **interface** command.

Variable	Value
<1-4059>	Specifies the VLAN ID in the range of 1 to 4059. By default, VLAN IDs 1 to 4059 are configurable and the system reserves VLAN IDs 4060 to 4094 for internal use. On switches that support the vrf-scaling and spbm-config-mode boot configuration flags, if you enable these flags, the system also reserves VLAN IDs 3500 to 3998. VLAN ID 1 is the default VLAN and you cannot create or delete VLAN ID 1.
{slot/port[/sub-port][/-slot/port[/sub-port]][,...]}	Identifies the slot and port in one of the following formats: a single slot and port (slot/port), a range of slots and ports (slot/port-slot/port), or a series of slots and ports (slot/port,slot/port,slot/port). If your platform supports channelization and the port is channelized, you must also specify the sub-port in the format slot/port/sub-port.

Configuring route advertisement

Configure route advertisement in IPv6 for neighbor discovery (ND).

About this task

IPv6 nodes on the same link use ND to discover link-layer addresses and to obtain and advertise various network parameters and reachability information. ND combines the services provided by Address Resolution Protocol (ARP) and router discovery for IPv4.

Procedure

1. Enter Interface Configuration mode:

```
enable
```

```
configure terminal
```

```
interface GigabitEthernet {slot/port[/sub-port][/-slot/port[/sub-port]][,...]} or interface vlan <1-4059>
```

Note:

If your platform supports channelization and the port is channelized, you must also specify the sub-port in the format slot/port/sub-port.

2. Configure the number of neighbor solicitation messages from duplicate address detection:

```
ipv6 nd dad-ns <0-600>
```

3. Configure the hop limit sent in router advertisements:

```
ipv6 nd hop-limit <0-255>
```

4. Enable managed address configuration (M-bit) on the router:

```
ipv6 nd managed-config-flag
```

5. Configure the MTU for router advertisements:

```
ipv6 nd mtu <0-9500>
```

6. Enable other stateful configuration (O-bit) on the router:

```
ipv6 nd other-config-flag
```

7. Configure the router lifetime included in router advertisement:

```
ipv6 nd ra-lifetime <0-9000>
```

8. Configure the neighbor reachable time:

```
ipv6 nd reachable-time <0-3600000>
```

9. Configure the time between neighbor solicitation messages:

```
ipv6 nd retransmit-timer <0-4294967295>
```

10. Configure the maximum time allowed between sending unsolicited multicast router advertisements:

```
ipv6 nd rtr-advert-max-interval <4-1800>
```

11. Configure the minimum time allowed between sending unsolicited multicast router advertisements:

```
ipv6 nd rtr-advert-min-interval <3-1350>
```

12. Enable periodic router advertisement messages:

```
ipv6 nd send-ra
```

Example

Configure the maximum time between sending unsolicited router advertisements:

```
Switch:1(config-if)#ipv6 nd rtr-advert-max-interval 700
```

Configure the minimum time between sending unsolicited router advertisements:

```
Switch:1(config-if)#ipv6 nd rtr-advert-min-interval 500
```

Enable periodic router advertisement messages:

```
Switch:1(config-if)#ipv6 nd send-ra
```

Variable definitions

Use the data in the following table to use the **ipv6 nd** commands.

Variable	Value
dad-ns <0-600>	Specifies the number of neighbor solicitation messages for duplicate address detection (DAD).

Table continues...

Variable	Value
	<p>A value of 0 disables the DAD process on this interface.</p> <p>A value of 1 sends one advertisement without retransmissions.</p>
hop-limit <0–255>	<p>Specifies the current hop limit field sent in router advertisements from this interface.</p> <p>The value must be the current diameter of the Internet.</p> <p>A value of zero indicates that the advertisement does not specify a hop-limit value.</p> <p>The default is 64.</p>
managed-config-flag	<p>Enables the system to configure the M-bit, or managed address configuration flag, in the router advertisements</p> <p>When set, the M-bit flag indicates that addresses are available through DHCPv6.</p> <p>If the M flag is set, the O flag is redundant because DHCPv6 returns all available configuration information.</p> <p>If neither the M nor O flags are set, no information is available through DHCPv6.</p> <p>The default is disabled.</p>
mtu <0–9500>	<p>Shows the MTU value sent in router advertisements on this interface.</p> <p>A value of zero indicates that the system sends no MTU options.</p> <p>The default is 0.</p>
other-config-flag	<p>Enables the O-bit, or other stateful configuration, flag in the router advertisement.</p> <p>Other stateful configuration autoconfigures received information without addresses.</p> <p>When set, the O-bit flag indicates that other configuration information is available through DHCPv6; for example, DNS-related information or information about other servers within the network.</p> <p>If neither the M nor O flags are set, no information is available through DHCPv6.</p> <p>The default is disabled.</p>
ra-lifetime <0–9000>	<p>Specifies a value placed in the router lifetime field of router advertisements sent from this interface.</p>

Table continues...

Variable	Value
	<p>This value must be either 0, or 4 to 9000 seconds.</p> <p>A value of zero indicates that the system is not a default router.</p> <p>The default is 1800.</p>
reachable-time <0-3600000>	<p>Specifies a value (in milliseconds) placed in the router advertisement message sent by the router.</p> <p>The value zero means unspecified (by this system).</p> <p>Configure the amount of time that a remote IPv6 node is considered reachable after a reachability confirmation event.</p> <p>The default is 0.</p>
retransmit-timer <0-4294967295>	<p>Specifies a value (in milliseconds) placed in the retransmit timer field in the router advertisement message sent from this interface.</p> <p>The value zero means unspecified (by this system).</p> <p>The value configures the amount of time the system waits for the transmission to occur.</p> <p>The default is 0.</p>
rtr-advert-max-interval <4-1800>	<p>Specifies the maximum interval (in seconds) at which the transmission of route advertisements occurs on this interface.</p> <p>The default is 600.</p>
rtr-advert-min-interval <3-1350>	<p>Specifies the minimum interval (in seconds) at which the transmission of route advertisements occurs on this interface.</p> <p>The default is 200.</p>
send-ra	<p>Specifies whether the router sends periodic router advertisements and responds to router solicitations on this interface.</p> <p>The default is enabled.</p>

Use the data in the following table to use the **interface** command.

Variable	Value
<1-4059>	<p>Specifies the VLAN ID in the range of 1 to 4059. By default, VLAN IDs 1 to 4059 are configurable and the system reserves VLAN IDs 4060 to 4094 for internal use. On switches that support the vrf-scaling and spbm-config-mode boot configuration flags, if you enable these flags, the system also reserves VLAN</p>

Table continues...

Variable	Value
	IDs 3500 to 3998. VLAN ID 1 is the default VLAN and you cannot create or delete VLAN ID 1.
{slot/port[/sub-port][/-slot/port[/sub-port]][,....]}	Identifies the slot and port in one of the following formats: a single slot and port (slot/port), a range of slots and ports (slot/port-slot/port), or a series of slots and ports (slot/port,slot/port,slot/port). If your platform supports channelization and the port is channelized, you must also specify the sub-port in the format slot/port/sub-port.

System interface values versus advertised values

There are differences in the relationship between the system interface values and advertised values related to Neighbor Discovery (ND). The information in this section describes differences and similarities and provides examples for important IPv6 interface and IPv6 ND commands.

Comparison of default values per interface and as advertised

The following table compares the default behavior of values per interface and advertised values.

Default values per interface	Default advertised values
hop-limit 64	hop-limit 64
mtu 1500	mtu 0 (unspecified)
reachable-time 30000 ms	reachable-time 0 (unspecified)
retransmit-timer 1000 ms	retransmit-timer 0 (unspecified)

What happens when you change the per interface value and the advertised value:

When you change per-interface values from default to non-default values, the system changes the advertised values to match the interface values.

For example, when you enter the `ipv6 interface mtu 1300` command the values become

- interface mtu 1300
- advertised mtu 1300

Then, when you enter the `show ipv6 nd interface` command, the system marks the mtu value with an (i) which signifies that the ND advertised value is inherited from the interface configuration.

Example:

```
Switch:1(config-if)#ipv6 interface mtu 1300
```

```
Switch:1(config-if)# show ipv6 nd interface GigabitEthernet 1/1
```

```

=====
                        Port Ipv6 Nd
=====
IFID BTR  RTR-  MAX-  MIN-  LIFE-  MANAG  OTHER  DAD-NS  MTU    HOP  REACH-  RETRANS-
      ADV  INT  INT  INT  TIME  CONF  LIMIT  TIME   TIME   ABLE  MIT
                        FLAG  CONF
=====

```

```
320 1/1 True 600 200 0 False False 1 1300(i) 64(d) 0(d) 0(d)
Note: (s) = Set, (d) = Default, (i) = inherit
```

What happens when you change the per interface value but do not change the advertised value:

To change the per-interface value from the default value to a non-default value but retain the advertised value of 0 (unspecified), you must enter two commands.

For example, to set the reachable-time to 60000 but retain the advertised value of the reachable-time parameter at 0, enter the following commands:

```
ipv6 interface reachable-time 6000
ipv6 nd reachable-time 0
```

When you enter the `show ipv6 nd interface` command, the system marks the reachable-time value with an (s) to signify that this value is explicitly set by the ND configuration.

Example:

```
Switch:1(config-if)#ipv6 interface reachable-time 60000
Switch:1(config-if)#ipv6 nd reachable-time 0
Switch:1(config-if)#show ipv6 nd interface GigabitEthernet 1/1
```

```
=====
Port Ipv6 Nd
=====
IFID BTR RTR- MAX- MIN- LIFETIME MANAG OTHER DAD-NS MTU HOP REACH- RETRANS-
ADV INT INT CONF FLAG LIMIT TIME TIME ABLE MIT
-----
320 1/1 True 600 200 0 False False 1 1500(i) 64(d) 0(s) 0(d)
Note: (s) = Set, (d) = Default, (i) = inherit
=====
```

Configuring the neighbor cache

Configure the address translation table used to map IPv6 addresses to physical addresses. You can manually add static neighbors to the cache.

* Note:

IPv6 static neighbors are not supported on SMLT.

About this task

Neighbor cache in IPv6 is similar to the IPv4 Address Resolution Protocol (ARP) table.

The neighbor cache is a set of entries for individual neighbors to which traffic was recently sent.

You make entries on the neighbor on-link unicast IP address, including information such as the link-layer address.

A neighbor cache entry contains information used by the Neighbor Unreachability Detection algorithm, including the reachability state, the number of unanswered probes, and the time the next Neighbor Unreachability Detection event is scheduled.

Procedure

1. Enter Global Configuration mode:

```
enable
configure terminal
```

2. Create a static neighbor:

```
ipv6 neighbor WORD<0-128> port {slot/port[sub-port]} mac
<0x00:0x00:0x00:0x00:0x00:0x00> [vlan <1-4059> ]
```

When you create a static neighbor, it always remains in the reachable state. This differs from the general neighbor cache behavior where, among other things, timers and neighbor unreachability detection events can be generated.

Example

Create a static neighbor:

```
Switch:1(config)#ipv6 neighbor 3000::3 port 1/11 mac 00-1A-4B-8A-FB-6B
```

Variable definitions

Use the data in the following table to use the `ipv6 neighbor` command.

Variable	Value
mac <0x00:0x00:0x00:0x00:0x00:0x00>	Specifies the MAC address.
{slot/port[/sub-port]}	Identifies a single slot and port. If your platform supports channelization and the port is channelized, you must also specify the sub-port in the format slot/port/sub-port.
vlan <1-4059>	Specifies the VLAN ID in the range of 1 to 4059. By default, VLAN IDs 1 to 4059 are configurable and the system reserves VLAN IDs 4060 to 4094 for internal use. On switches that support the vrf-scaling and spbm-config-mode boot configuration flags, if you enable these flags, the system also reserves VLAN IDs 3500 to 3998. VLAN ID 1 is the default VLAN and you cannot create or delete VLAN ID 1.
WORD<0-128>	Specifies the IPv6 address in hexadecimal colon format.

Viewing cached destination information

View the destination cache to see next-hop addresses for destinations.

The destination cache is only populated or updated when IPv6 packets originate locally on the central processor of the switch.

The main purpose of the destination cache is to store, on a per-destination basis, the dynamic Path MTU value currently used when transmitting packets from the local system to the remote destination.

The system uses the PMTU value to calculate how many bytes can fit into an individual packet before fragmentation should be applied.

About this task

The command output shows the following information:

- the IPv6 destination address
- the IPv6 address for the next hop to the destination
- the path maximum transmission unit (MTU) for the destination
- the time, in seconds, since an ICMPv6 packet-too-big message was received

Not all parameters are available in non-default VRFs.

Procedure

1. Log on to the switch to enter User EXEC mode.
2. View the destination cache for all interfaces:

```
show ipv6 dcache [vrf WORD<1-16> | vrfids WORD<0-512>]
```

3. View the destination cache for a brouter port:

```
show ipv6 dcache gigabitethernet {slot/port[/sub-port]}
```

4. View the destination cache for a management port:

```
show ipv6 dcache mgmtethernet mgmt
```

* Note:

This step only applies to hardware with a dedicated, physical management interface.

5. View the destination cache for a specific tunnel ID:

```
show ipv6 dcache tunnel <1-2000>
```

6. View the destination cache for a VLAN:

```
show ipv6 dcache vlan <1-4059>
```

7. Clear the destination cache:

```
clear ipv6 dcache [gigabitethernet {slot/port[/sub-port]}]
[mgmtethernet {slot/port[/sub-port]}] [tunnel <1-2000>] [vlan
<1-4059>] [vrf WORD<1-16> | vrfids WORD<0-512>]
```

Example

```
Switch:1(config-if)#show ipv6 dcache
```

```
=====
IPv6 Destination Cache Information - GlobalRouter
```

```

=====
Destination Address          NEXT HOP          VID/BID/TID  IF_TYPE  IF_DATA
PMTU      PMTU_AGE
-----
ff02:0:0:0:0:0:1          0:0:0:0:0:0:0          V-22        real      -
1500      0
-----
1 out of 1 Total Num of Destinaton Cache Entries displayed.

```

Variable definitions

Use the data in the following table to use the `show ipv6 dcache` and `clear ipv6 dcache` commands.

Variable	Value
<1-4059>	Specifies the VLAN ID in the range of 1 to 4059. By default, VLAN IDs 1 to 4059 are configurable and the system reserves VLAN IDs 4060 to 4094 for internal use. On switches that support the vrf-scaling and spbm-config-mode boot configuration flags, if you enable these flags, the system also reserves VLAN IDs 3500 to 3998. VLAN ID 1 is the default VLAN and you cannot create or delete VLAN ID 1.
{slot/port[/sub-port]}	Identifies a single slot and port. If your platform supports channelization and the port is channelized, you must also specify the sub-port in the format slot/port/sub-port.
vrf WORD<1-16>	Specifies the VRF name.
vrfids WORD<0-512>	Specifies the VRF ID.

Neighbor discovery configuration using EDM

Configuring an IPv6 discovery prefix

Configure the discovery prefixes to send in router advertisement.

Before you begin

Change the VRF instance as required to configure an IPv6 discovery prefix on a specific VRF instance. Not all parameters are configurable on non-default VRFs.

About this task

Hosts on the link use router advertisements to perform IPv6 autoconfiguration. The discovery prefix controls what IPv6 addresses to autoconfigure and how long they are valid.

You can also configure an IPv6 interface for a brouter port through the **Edit > Port > IPv6** navigation path, and for a VLAN through the **VLAN > VLANs > Basic > IPv6** navigation path. This procedure uses the main IPv6 navigation path where you can configure both types of interfaces.

Procedure

1. In the navigation tree, expand the following folders: **Configuration > IPv6**.
2. Click **IPv6**.
3. Click the **Discovery Prefix** tab.
4. Click **Insert**.
5. Beside the **Interface** field, click **Port** or **VLAN**.
6. Select a port or VLAN.
7. Click **OK**.
8. Specify the prefix and prefix length.
9. Click **Insert**.
10. Click **Apply**.

Discovery Prefix field descriptions

Use the data in the following table to use the Discovery Prefix tab.

Name	Description
Interface	Shows a read-only value that indicates an IPv6 interface. For the brouter port, it is the ifindex of the port and, in the case of the VLAN, it is the ifindex of the VLAN.
Prefix	Configures the prefix to create an IPv6 prefix entry as either advertised or suppressed.
PrefixLen	Configures the mask to create an IPv6 address in the IPv6 interface table.
VlanId	Specifies the VLAN ID in the range of 1 to 4059. By default, VLAN IDs 1 to 4059 are configurable and the system reserves VLAN IDs 4060 to 4094 for internal use. On switches that support the vrf-scaling and spbm-config-mode boot configuration flags, if you enable these flags, the system also reserves VLAN IDs 3500 to 3998. VLAN ID 1 is the default VLAN and you cannot create or delete VLAN ID 1.
UseDefaultVal	Specifies one included value to use the default value, or use all bits to configure all options to their default value.

Table continues...

Name	Description
ValidLifetime	<p>Configures the valid lifetime in seconds that indicates the length of time this prefix is advertised. The default is 2592000.</p> <p>A valid lifetime is the length of time of the preferred and depreciated state of an autoconfiguration address.</p> <p>The preferred lifetime value must be less than the valid lifetime value. If you must configure the valid lifetime value to a value lower than the current preferred lifetime, you must lower the preferred lifetime value first.</p>
PreferedLifetime	<p>Configures the preferred lifetime in seconds that indicates the length of time this prefix is advertised. The default value is 604800.</p> <p>The preferred lifetime is the length of time for the tentative, preferred, and depreciated state of an autoconfiguration address.</p> <p>The preferred lifetime value must be less than the valid lifetime value. If you must configure the valid lifetime value to a value lower than the current preferred lifetime, you must lower the preferred lifetime value first.</p>
Infinite	<p>Configures the prefix valid lifetime so it never expires. The default is false.</p>
OnLinkFlag	<p>Configures the prefix for use when determining if a node is online. This value is placed in the L-bit field in the prefix information option. It is a 1-bit flag. The default is true.</p>
AutoFlag	<p>Configures the prefix for use as the autonomous address configuration. This value is placed in the autoflag field in the prefix information option. It is a 1-bit flag. The default is true.</p>
AddressEui	<p>Configures the EUI address. Use an EUI-64 interface ID in the address field. If enabled, use EUI, or use EUI-64 and the complement Universal/Local (U/L) bit. This operation provides for both gloal and link-local addresses. After you create the entry, you cannot modify this value. This value is valid for use only when the PrefixLength is 64 or less. The default is eui-not-used.</p> <p>If you select eui-not-used, this configuration creates an IPv6 ND prefix but no associated IPv6 address on the router. IF you select either eui-used-with-ul-complement or eui-used-without-ul-complement, an</p>

Table continues...

Name	Description
	associated IPv6 address is created by concatenating the specified prefix with the EUI-64 interface ID.
NoAdvertise	Configures if the prefix is included in the router advertisement. Select true to not include the prefix in the router advertisement. The default is false.

Configuring an IPv6 discovery prefix port

Configure the discovery prefixes to send in router advertisement.

About this task

Hosts on the link use router advertisements to perform IPv6 autoconfiguration. The discovery prefix controls what IPv6 addresses to autoconfigure and how long they are valid.

Procedure

1. In the navigation pane, expand the following folders: **Configuration > Edit > Port**.
2. Click **IPv6**.
3. Click **Discovery Prefix**.
4. Click **Insert**.
5. Click **OK**.
6. Specify the prefix and prefix length.
7. Click **Insert**.
8. Click **Apply**.

IPv6 Discovery Prefix field descriptions

Use the data in the following table to use the **IPv6 Discovery Prefix** tab.

Name	Description
Interface	Shows a read-only value that indicates an IPv6 interface. For the brouter port, it is the ifindex of the port and, in the case of the VLAN, it is the ifindex of the VLAN.
Prefix	Configures the prefix to create an IPv6 prefix entry as either advertised or suppressed.
PrefixLen	Configures the mask to create an IPv6 address in the IPv6 interface table.
VlanId	Specifies the VLAN ID in the range of 1 to 4059. By default, VLAN IDs 1 to 4059 are configurable and the system reserves VLAN IDs 4060 to 4094 for internal

Table continues...

Name	Description
	use. On switches that support the vrf-scaling and spbm-config-mode boot configuration flags, if you enable these flags, the system also reserves VLAN IDs 3500 to 3998. VLAN ID 1 is the default VLAN and you cannot create or delete VLAN ID 1.
UseDefaultVal	Specifies one included value to use the default value, or use all bits to configure all options to their default value.
ValidLifetime	<p>Configures the valid lifetime in seconds that indicates the length of time this prefix is advertised. The default is 2592000.</p> <p>A valid lifetime is the length of time of the preferred and depreciated state of an autoconfiguration address.</p> <p>The preferred lifetime value must be less than the valid lifetime value. If you must configure the valid lifetime value to a value lower than the current preferred lifetime, you must lower the preferred lifetime value first.</p>
PreferredLifetime	<p>Configures the preferred lifetime in seconds that indicates the length of time this prefix is advertised. The default value is 604800.</p> <p>The preferred lifetime is the length of time for the tentative, preferred, and depreciated state of an autoconfiguration address.</p> <p>The preferred lifetime value must be less than the valid lifetime value. If you must configure the valid lifetime value to a value lower than the current preferred lifetime, you must lower the preferred lifetime value first.</p>
Infinite	Configures the prefix valid lifetime so it never expires. The default is false.
OnLinkFlag	Configures the prefix for use when determining if a node is online. This value is placed in the L-bit field in the prefix information option. It is a 1-bit flag. The default is true.
AutoFlag	Configures the prefix for use as the autonomous address configuration. This value is placed in the autoflag field in the prefix information option. It is a 1-bit flag. The default is true.
AddressEui	Configures the EUI address. Use an EUI-64 interface ID in the address field. If enabled, use EUI, or use EUI-64 and the complement Universal/Local (U/L)

Table continues...

Name	Description
	<p>bit. This operation provides for both global and link-local addresses. After you create the entry, you cannot modify this value. This value is valid for use only when the PrefixLength is 64 or less. The default is eui-not-used.</p> <p>If you select eui-not-used, this configuration creates an IPv6 ND prefix but no associated IPv6 address on the router. If you select either eui-used-with-ul-complement or eui-used-without-ul-complement, an associated IPv6 address is created by concatenating the specified prefix with the EUI-64 interface ID.</p>
NoAdvertise	Configures if the prefix is included in the router advertisement. Select true to not include the prefix in the router advertisement. The default is false.

Configuring an IPv6 discovery prefix on a VLAN

Configure the discovery prefixes to send in router advertisement.

About this task

Hosts on the link use router advertisements to perform IPv6 autoconfiguration. The discovery prefix controls what IPv6 addresses to autoconfigure and how long they are valid.

Procedure

1. In the navigation pane, expand the following folders: **VLAN > VLANs**.
2. Click the **Basic** tab.
3. Select an interface row.
4. Click **IPv6**.
5. Click the **IPv6 Discovery Prefix** tab.
6. Click **Insert**.
7. Specify the prefix and prefix length.
8. Configure the remaining parameters, as required.
9. Click **Insert**.
10. Click **Apply**.

IPv6 Discovery Prefix field descriptions

Use the data in the following table to use the **IPv6 Discovery Prefix** tab.

Name	Description
Interface	Shows a read-only value that indicates an IPv6 interface. For the brouter port, it is the ifindex of the port and, in the case of the VLAN, it is the ifindex of the VLAN.
Prefix	Configures the prefix to create an IPv6 prefix entry as either advertised or suppressed.
PrefixLen	Configures the mask to create an IPv6 address in the IPv6 interface table.
VlanId	Specifies the VLAN ID in the range of 1 to 4059. By default, VLAN IDs 1 to 4059 are configurable and the system reserves VLAN IDs 4060 to 4094 for internal use. On switches that support the vrf-scaling and spbm-config-mode boot configuration flags, if you enable these flags, the system also reserves VLAN IDs 3500 to 3998. VLAN ID 1 is the default VLAN and you cannot create or delete VLAN ID 1.
UseDefaultVal	Specifies one included value to use the default value, or use all bits to configure all options to their default value.
ValidLifetime	<p>Configures the valid lifetime in seconds that indicates the length of time this prefix is advertised. The default is 2592000.</p> <p>A valid lifetime is the length of time of the preferred and depreciated state of an autoconfiguration address.</p> <p>The preferred lifetime value must be less than the valid lifetime value. If you must configure the valid lifetime value to a value lower than the current preferred lifetime, you must lower the preferred lifetime value first.</p>
PreferedLifetime	<p>Configures the preferred lifetime in seconds that indicates the length of time this prefix is advertised. The default value is 604800.</p> <p>The preferred lifetime is the length of time for the tentative, preferred, and depreciated state of an autoconfiguration address.</p> <p>The preferred lifetime value must be less than the valid lifetime value. If you must configure the valid lifetime value to a value lower than the current preferred lifetime, you must lower the preferred lifetime value first.</p>
Infinite	Configures the prefix valid lifetime so it never expires. The default is false.

Table continues...

Name	Description
OnLinkFlag	Configures the prefix for use when determining if a node is online. This value is placed in the L-bit field in the prefix information option. It is a 1-bit flag. The default is true.
AutoFlag	Configures the prefix for use as the autonomous address configuration. This value is placed in the autoflag field in the prefix information option. It is a 1-bit flag. The default is true.
AddressEui	<p>Configures the EUI address. Use an EUI-64 interface ID in the address field. If enabled, use EUI, or use EUI-64 and the complement Universal/Local (U/L) bit. This operation provides for both global and link-local addresses. After you create the entry, you cannot modify this value. This value is valid for use only when the PrefixLength is 64 or less. The default is eui-not-used.</p> <p>If you select eui-not-used, this configuration creates an IPv6 ND prefix but no associated IPv6 address on the router. If you select either eui-used-with-ul-complement or eui-used-without-ul-complement, an associated IPv6 address is created by concatenating the specified prefix with the EUI-64 interface ID.</p>
NoAdvertise	Configures if the prefix is included in the router advertisement. Select true to not include the prefix in the router advertisement. The default is false.

Configuring route advertisement

Configure route advertisement in IPv6 for neighbor discovery (ND).

Before you begin

Change the VRF instance as required to configure route advertisement on a specific VRF instance. Not all parameters are configurable on non-default VRFs.

About this task

IPv6 nodes on the same link use ND to discover link-layer addresses and to obtain and advertise various network parameters and reachability information. ND combines the services provided by Address Resolution Protocol (ARP) and router discovery for IPv4.

Note:

You only use the ND level configuration when you want to create advertised values that differ from the interface values for reachable-time, retransmit-timer, mtu, or hop-limit.

You can also configure an IPv6 interface for a brouter port through the **Edit > Port > IPv6** navigation path, and for a VLAN through the **VLAN > VLANs > Basic > IPv6** navigation path. This procedure uses the main IPv6 navigation path where you can configure both types of interfaces.

Procedure

1. In the navigation tree, expand the following folders: **Configuration > IPv6**.
2. Click **IPv6**.
3. Click the **Route Advertisement** tab.
4. Double-click a parameter to change the current value.
You cannot modify the parameters in gray shading.
5. Click **Apply**.

Route Advertisement field descriptions

Use the data in the following table to use the **Route Advertisement** tab.

Name	Description
Interface	Specifies the interface to which this entry applies.
SendAdverts	Specifies whether the router sends periodic router advertisements and responds to router solicitations on this interface. The default is True.
UseDefaultVal	Specifies one included value to use the default value, or use all bits to configure all options to their default value.
MaxInterval	Specifies the maximum interval (in seconds) at which the transmission of route advertisements occurs on this interface. The value must be between 4 seconds and 1800 seconds. The default is 600.
MinInterval	Specifies the minimum interval (in seconds) at which the transmission of route advertisements occurs on this interface. The value must be between 3 seconds and 0.75 x max-interval. The default is 200.
ReachableTime	Shows a value (in milliseconds) placed in the router advertisement message sent by the router. The value zero means unspecified (by this system). Configure the amount of time that a remote IPv6 node is considered reachable after a reachability confirmation event. You cannot modify this parameter; use the Interfaces tab to change the value for the interface.
RetransmitTime	Shows a value (in milliseconds) placed in the retransmit timer field in the router advertisement message sent from this interface. The value zero means unspecified (by this system). The value configures the amount of time the system waits for the transmission to occur. You cannot modify this parameter; use the Interfaces tab to change the value for the interface.

Table continues...

Name	Description
DefaultLifeTime	Specifies a value placed in the router lifetime field of router advertisements sent from this interface. This value must be either 0 or between 4 and 9000 seconds. A value of zero indicates that the system is not a default router. The default is 1800.
CurHopLimit	Specifies the current hop limit field sent in router advertisements from this interface. The value must be the current diameter of the Internet. A value of zero indicates that the advertisement does not specify a value for CurHopLimit. The default is 64.
ManagedFlag	Enables the system to configure the M-bit or managed address configuration in the router advertisements. The default is false.
DadNsNum	Specifies the number of neighbor solicitation messages for duplicate address detection (DAD). A value of 0 disables the DAD process on this interface. A value of 1 sends one advertisement without retransmissions.
LinkMTU	Shows the MTU value sent in router advertisements on this interface. A value of zero indicates that the system sends no MTU options.
OtherConfigFlag	Enables the O-bit (other stateful configuration) in the router advertisement. Other stateful configuration autoconfigures received information without addresses. The default is disabled.

Configuring route advertisement on an IPv6 interface for a brouter port

Configure route advertisement in IPv6 for neighbor discovery (ND).

About this task

IPv6 nodes on the same link use ND to discover link-layer addresses and to obtain and advertise various network parameters and reachability information. ND combines the services provided by Address Resolution Protocol (ARP) and router discovery for IPv4.

* Note:

You only use the ND level configuration when you want to create advertised values that differ from the interface values for reachable-time, retransmit-timer, mtu, or hop-limit.

You can also configure an IPv6 interface for a VLAN through the **VLAN > VLANs > Basic > IPv6** navigation path.

Procedure

1. In the navigation pane, expand the following folders: **Configuration > Edit > Port**.

2. Click **IPv6**.
3. Click the **Route Advertisement** tab.
4. Double-click a parameter to change the current value.
You cannot modify the parameters in gray shading.
5. Click **Apply**.

Route Advertisement field descriptions

Use the data in the following table to use the **Route Advertisement** tab.

Name	Description
Interface	Specifies the interface to which this entry applies.
SendAdverts	Specifies whether the router sends periodic router advertisements and responds to router solicitations on this interface. The default is True.
UseDefaultVal	Specifies one included value to use the default value, or use all bits to configure all options to their default value.
MaxInterval	Specifies the maximum interval (in seconds) at which the transmission of route advertisements occurs on this interface. The value must be between 4 seconds and 1800 seconds. The default is 600.
MinInterval	Specifies the minimum interval (in seconds) at which the transmission of route advertisements occurs on this interface. The value must be between 3 seconds and 0.75 x max-interval. The default is 200.
ReachableTime	Shows a value (in milliseconds) placed in the router advertisement message sent by the router. The value zero means unspecified (by this system). Configure the amount of time that a remote IPv6 node is considered reachable after a reachability confirmation event. You cannot modify this parameter; use the Interfaces tab to change the value for the interface.
RetransmitTime	Shows a value (in milliseconds) placed in the retransmit timer field in the router advertisement message sent from this interface. The value zero means unspecified (by this system). The value configures the amount of time the system waits for the transmission to occur. You cannot modify this parameter; use the Interfaces tab to change the value for the interface.
DefaultLifeTime	Specifies a value placed in the router lifetime field of router advertisements sent from this interface. This value must be either 0 or between 4 and 9000

Table continues...

Name	Description
	seconds. A value of zero indicates that the system is not a default router. The default is 1800.
CurHopLimit	Specifies the current hop limit field sent in router advertisements from this interface. The value must be the current diameter of the Internet. A value of zero indicates that the advertisement does not specify a value for CurHopLimit. The default is 64.
ManagedFlag	Enables the system to configure the M-bit or managed address configuration in the router advertisements. The default is false.
DadNsNum	Specifies the number of neighbor solicitation messages for duplicate address detection (DAD). A value of 0 disables the DAD process on this interface. A value of 1 sends one advertisement without retransmissions.
LinkMTU	Shows the MTU value sent in router advertisements on this interface. A value of zero indicates that the system sends no MTU options.
OtherConfigFlag	Enables the O-bit (other stateful configuration) in the router advertisement. Other stateful configuration autoconfigures received information without addresses. The default is disabled.

Configuring route advertisement on an IPv6 interface for a VLAN

Configure route advertisement in IPv6 for neighbor discovery (ND).

About this task

IPv6 nodes on the same link use ND to discover link-layer addresses and to obtain and advertise various network parameters and reachability information. ND combines the services provided by Address Resolution Protocol (ARP) and router discovery for IPv4.

Note:

You only use the ND level configuration when you want to create advertised values that differ from the interface values for reachable-time, retransmit-timer, mtu, or hop-limit.

Procedure

1. In the navigation pane, expand the following folders: **VLAN > VLANs**.
2. Click the **Basic** tab.
3. Select an interface row, and click **IPv6**.
4. Click **Route Advertisement**.
5. Double-click a parameter to change the current value.

You cannot modify the parameters in gray shading.

- Click **Apply**.

Route Advertisement field descriptions

Use the data in the following table to use the **Route Advertisement** tab.

Name	Description
Interface	Specifies the interface to which this entry applies.
SendAdverts	Specifies whether the router sends periodic router advertisements and responds to router solicitations on this interface. The default is True.
UseDefaultVal	Specifies one included value to use the default value, or use all bits to configure all options to their default value.
MaxInterval	Specifies the maximum interval (in seconds) at which the transmission of route advertisements occurs on this interface. The value must be between 4 seconds and 1800 seconds. The default is 600.
MinInterval	Specifies the minimum interval (in seconds) at which the transmission of route advertisements occurs on this interface. The value must be between 3 seconds and 0.75 x max-interval. The default is 200.
ReachableTime	Shows a value (in milliseconds) placed in the router advertisement message sent by the router. The value zero means unspecified (by this system). Configure the amount of time that a remote IPv6 node is considered reachable after a reachability confirmation event. You cannot modify this parameter; use the Interfaces tab to change the value for the interface.
RetransmitTime	Shows a value (in milliseconds) placed in the retransmit timer field in the router advertisement message sent from this interface. The value zero means unspecified (by this system). The value configures the amount of time the system waits for the transmission to occur. You cannot modify this parameter; use the Interfaces tab to change the value for the interface.
DefaultLifeTime	Specifies a value placed in the router lifetime field of router advertisements sent from this interface. This value must be either 0 or between 4 and 9000 seconds. A value of zero indicates that the system is not a default router. The default is 1800.
CurHopLimit	Specifies the current hop limit field sent in router advertisements from this interface. The value must

Table continues...

Name	Description
	be the current diameter of the Internet. A value of zero indicates that the advertisement does not specify a value for CurHopLimit. The default is 64.
ManagedFlag	Enables the system to configure the M-bit or managed address configuration in the router advertisements. The default is false.
DadNsNum	Specifies the number of neighbor solicitation messages for duplicate address detection (DAD). A value of 0 disables the DAD process on this interface. A value of 1 sends one advertisement without retransmissions.
LinkMTU	Shows the MTU value sent in router advertisements on this interface. A value of zero indicates that the system sends no MTU options.
OtherConfigFlag	Enables the O-bit (other stateful configuration) in the router advertisement. Other stateful configuration autoconfigures received information without addresses. The default is disabled.

Configuring the neighbor cache

Configure the address translation table used to map IPv6 addresses to physical addresses. You can manually add static neighbors to the cache.

* Note:

IPv6 static neighbors are not supported on SMLT.

Before you begin

Change the VRF instance as required to configure neighbor cache on a specific VRF instance. Not all parameters are configurable on non-default VRFs.

About this task

Neighbor cache in IPv6 is similar to the IPv4 Address Resolution Protocol (ARP) table. The neighbor cache is a set of entries for individual neighbors to which traffic was sent recently. You make entries on the neighbor on-link unicast IP address, including information such as the link-layer address. A neighbor cache entry contains information used by the Neighbor Unreachability Detection algorithm, including the reachability state, the number of unanswered probes, and the time the next Neighbor Unreachability Detection event is scheduled.

Procedure

1. In the navigation tree, expand the following folders: **Configuration > IPv6**.
2. Click **IPv6**.
3. Click the **Neighbors** tab.

4. Click **Insert**.
5. Beside the **Interface** field, click **Port** or **Port in Vlan**.
6. Select a port or VLAN.
7. Configure the remaining parameters as required.
8. Click **Insert**.
9. Click **Apply**.

Neighbors field descriptions

Use the data in the following table to use the **Neighbors** tab.

Name	Description
Interface	Specifies the interface to which this entry applies.
NetAddress	Specifies the IP address of the media-dependent physical address.
PhyAddress	Specifies the MAC address.
Interface	Specifies a physical port ID or a MLT port ID.
LastUpdated	Specifies the value of sysUpTime of the last modification to this entry. If the entry was created prior to the last reinitialization of the local management subsystem, the object contains a zero value.
Type	Specifies the mapping type from manually configured entries. While the selection of either dynamic, static, or local is allowed; static is currently the only valid selection.
State	Specifies the Neighbor Unreachability Detection state for the interface after the address mapping in this entry is used. If Neighbor Unreachability Detection is not in use (for example, for IPv4), this object is always unknown. The options include the following: <ul style="list-style-type: none"> • reachable: confirmed reachability • stale: unconfirmed reachability • delay: waiting for reachability confirmation before entering the probe state • probe: actively probing • invalid: an invalidated mapping • unknown: state cannot be determined. • incomplete: address resolution is being performed
BMac	Specifies the backbone MAC address.
Cvid	Specifies the customer VID.

Viewing cached destination information

View the destination cache to see next-hop addresses for destinations.

The destination cache is only populated or updated when IPv6 packets are locally originated on the central processor of the switch.

The main purpose of the destination cache is to store, on a per-destination basis, the dynamic Path MTU value currently used when transmitting packets from the local system to the remote destination. The PMTU value itself is used to calculate how many bytes can fit into an individual packet before fragmentation should be applied.

Before you begin

Change the VRF instance as required to view cached destination information on a specific VRF instance. Not all parameters are configurable on non-default VRFs.

Procedure

1. In the navigation tree, expand the following folders: **Configuration > IPv6**.
2. Click **IPv6**.
3. Click the **Destination Cache** tab.

Destination Cache field descriptions

Use the data in the following table to use the **Destination Cache** tab.

Name	Description
DestAddr	Shows the IPv6 destination address.
Interface	Shows the interface number that is used to reach the destination.
NextHop	Shows the IPv6 address for the next hop to the destination.
IfType	Specifies the interface type (tunnel, VLAN, or brouter) or virtual circuit (VRRP, RSMLT).
IfData	Displays additional information about virtual circuits. For instance, for a VRRP or RSMLT the virtual router ID displays. If the interface type is tunnel, VLAN, or brouter, no additional information displays.
Pmtu	Shows the path maximum transmission unit (MTU) for the destination.
PmtuAge	Shows the time, in seconds, since an ICMPv6 packet too big message was received.

Chapter 5: DHCP Relay

This chapter provides concepts and procedures to complete IPv6 DHCP Relay configuration.

DHCP Relay

The Dynamic Host Configuration Protocol (DHCP) for IPv6 (RFC 3315) enables DHCP servers to pass configuration parameters such as IPv6 network addresses to IPv6 nodes. DHCP supports automatic allocation of reusable network addresses and of additional configuration parameters. This protocol is a stateful counterpart to stateless address autoconfiguration, and you can use it separately or concurrently with the latter to obtain configuration parameters. For more information about stateless address autoconfiguration, see [Host autoconfiguration](#) on page 87.

To request the assignment of one or more IPv6 addresses, a client first locates a DHCP server, and then requests the assignment of addresses and other configuration information from the server:

1. The client sends a solicit message to the All_DHCP_Relay_Agents_and_Servers (FF02::1:2) multicast address to find available DHCP servers.
2. Any server that can meet the requirements responds with an advertise message.
3. The client then chooses one of the servers and sends a request message to the server asking for confirmed assignment of addresses and other configuration information.
4. The server responds with a reply message that contains the confirmed addresses and configuration.

If a DHCP client does not need a DHCP server to assign it an IPv6 address, the client can obtain configuration information such as a list of available DNS servers or NTP servers through a single message and reply exchanged with a DHCP server.

IPv6 DHCP clients use link-local addresses to send and receive DHCP messages. To permit a DHCP client to send a message to a DHCP server that is not attached to the same link, you must configure a DHCP relay agent on the client link to relay messages between the client and server. The operation of the relay agent is transparent to the client.

A relay agent relays messages from clients and messages from other relay agents. The switch supports DHCP Relay for IPv6. Configure at least one relay agent when the client and server are in different networks.

You must configure the relay agent to use a list of destination addresses for available DHCP servers. The software does not support IPv6 multicast for site-local and global addresses.

The DHCP relay can be a Virtual Router Redundancy Protocol (VRRP) Address. The relay forwards the DHCP messages only if VRRP is in the Master state, otherwise the relay discards the messages.

*** Note:**

Since DHCP cannot work on the backup VRRP if the master fails, to achieve optimum results and to leverage redundancy you must configure DHCP on the backup VRRP.

Clients listen for DHCP messages on UDP port 546. Servers and relay agents listen for DHCP messages on UDP port 547.

Remote ID

IPv6 DHCP Relay supports the remote ID parameter (RFC4649). After you enable remote ID on the switch, the relay agent adds information about the relay to DHCPv6 messages before relaying the messages to the DHCP server. The server can use the supplied information in the process of assigning the addresses, delegated prefixes, and configuration parameters that the client is to receive.

The remote ID option contains two fields:

- vendor ID
- MAC address of the client

The switch uses a vendor ID of 1584.

Limitations

The following list identifies configuration limitations:

- You can configure only one relay for a VLAN, regardless of how many addresses are configured on that VLAN. The default address is the smallest address configured. If the relay is a VRRP address, the default value is the first VRRP address configured.
- The maximum number of servers to which a relay can send a message from one client, is 10.
- You can configure the number of forwarding paths per system. For information on the maximum limit, see *Release Notes*.

DHCP Relay Network Topology and Workflow

The following example depicts the interaction between a DHCP client and a server:

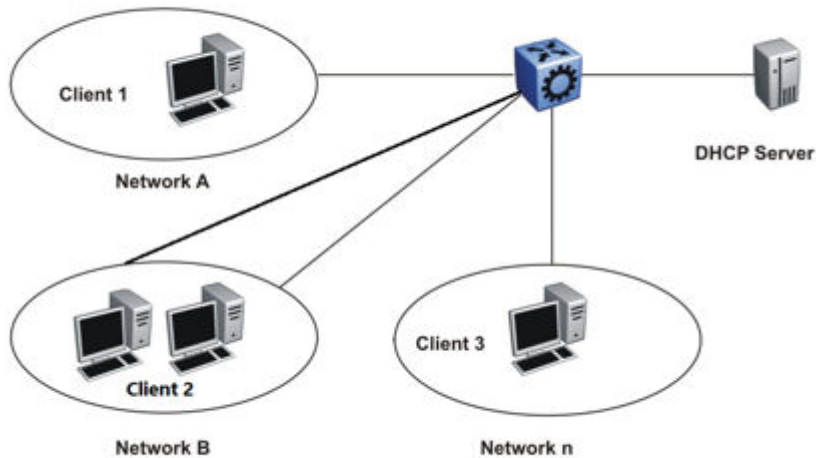

Figure 9: DHCP Client-Relay-Server Architecture

The following list outlines the operations that the DHCP relay agent performs to forward the message to the server :

- When a client sends a request for the IP address or configuration parameters, the server responds with the details as requested by the client.

*** Note:**

There should be at least one relay agent when client and server are located in different networks.

- A DHCP Relay IPv6 is established only between agents within the context of each VRF and when no cross VRF interaction is present.

*** Note:**

`All_DHCP_Servers` multicast address option is not implemented for IPv6, as there is no IPv6 MCAST support for site-local and global address.

DHCP Relay configuration using the CLI

Configuring a DHCP Relay forwarding path

Configure a forwarding path to specify the relay agent address and the DHCP server address to which to forward packets.

To use DHCP Relay for IPv6, you must configure at least one forwarding path and enable the relay on one interface.

Before you begin

For a VRF other than GlobalRouter, the interface must be first associated to that VRF.

About this task

The relay agent can use the IPv6 address of the interface or the VRRP global address linked to that interface. The relay forwards the DHCP messages only if VRRP is in the master state, otherwise the relay discards the messages.

You can configure only one relay agent on an interface. If you need to change the relay agent, you must delete all the forwarding paths with the old relay agent, and then configure the new relay agent.

For scaling information on DHCP Relay forwarding paths, see *Release Notes*.

Procedure

1. Enter either Global Configuration mode or VRF Router Configuration mode for a specific VRF context:

```
enable
configure terminal
router vrf WORD<1-16>
```

2. Configure a forwarding path:

```
ipv6 dhcp-relay fwd-path WORD<0-255> WORD<0-255> [enable]
```

If you configure the forwarding path globally, the relay agent address can be any configured IP address of the relay interface or the VRRP global address linked to the relay interface.

3. To configure a forwarding path on an interface, enter Interface Configuration mode:

```
interface GigabitEthernet {slot/port[/sub-port] [-slot/port[/sub-
port]] [,...]}
```

OR

```
interface vlan <1-4059>
```

4. Configure a forwarding path:

```
ipv6 dhcp-relay fwd-path WORD<0-255> [enable] [vrid WORD<1-255>]
```

If you configure the forwarding path on an interface, the relay agent address is either the smallest IP configured on the interface or the first VRRP global address configured, if the relay is the VRRP master. You do not specify the relay agent address as part of the command.

* Note:

IPv6 DHCP Relay is established only between agents within the context of each VRF.

Example

Configure a forwarding path globally:

```
Switch:1(config)#ipv6 dhcp-relay fwd-path 1111::1111 1234::1234 enable
```

Configure a forwarding path on an interface:

```
Switch:1(config)#interface GigabitEthernet 1/1
```

```
Switch:1(config-if)#ipv6 dhcp-relay fwd-path 1234::1234 enable
```

OR

Configure the VRRP master as the relay:

```
Switch:1(config-if)#ipv6 dhcp-relay fwd-path 1234::1234 vrid 12 enable
```

Variable definitions

Use the data in the following table to use the `ipv6 dhcp-relay fwd-path` command.

Variable	Value
<1-4059>	Specifies the VLAN ID in the range of 1 to 4059. By default, VLAN IDs 1 to 4059 are configurable and the system reserves VLAN IDs 4060 to 4094 for internal use. On switches that support the vrf-scaling and spbm-config-mode boot configuration flags, if you enable these flags, the system also reserves VLAN IDs 3500 to 3998. VLAN ID 1 is the default VLAN and you cannot create or delete VLAN ID 1.
enable	Enables the forwarding path. The default is disabled.
{slot/port[/sub-port][-slot/port[/sub-port]][,...]}	Identifies the slot and port in one of the following formats: a single slot and port (slot/port), a range of slots and ports (slot/port-slot/port), or a series of slots and ports (slot/port,slot/port,slot/port). If your platform supports channelization and the port is channelized, you must also specify the sub-port in the format slot/port/sub-port.
vrid WORD<1-255>	Specifies the VRRP ID to use the VRRP master as the relay agent interface.
WORD<0-255>	Specifies the IPv6 address of the DHCP server for the interface configuration.
WORD<0-255> WORD<0-255>	Specifies the IPv6 address of the relay agent interface and the IPv6 address of the DHCP server for the global configuration.

Configuring DHCP Relay for an interface

Configure the DHCP relay behavior on the interface.

About this task

You can configure only one relay for a VLAN, regardless of how many addresses are configured on that VLAN. The default address is the smallest address configured. If the relay is a VRRP address, the default value is the first VRRP address configured.

Procedure

1. Enter Interface Configuration mode:

```
enable
configure terminal
interface GigabitEthernet {slot/port[/sub-port] [-slot/port[/sub-
port]][,...]} or interface vlan <1-4059>
```

*** Note:**

If your platform supports channelization and the port is channelized, you must also specify the sub-port in the format slot/port/sub-port.

2. Enable DHCP on the interface:

```
ipv6 dhcp-relay
```

3. Configure the maximum hop count:

```
ipv6 dhcp-relay max-hop <1-32>
```

4. Enable the remote ID:

```
ipv6 dhcp-relay remote-id
```

Example

Configure the maximum hop count:

```
Switch:1(config-if)#ipv6 dhcp-relay max-hop 30
```

Disable the remote ID:

```
Switch:1(config-if)#no ipv6 dhcp-relay remote-id
```

Variable definitions

Use the data in the following table to use the **ipv6 dhcp-relay** command.

Variable	Value
max-hop <1-32>	Specifies the maximum number of hops a DHCP packet can take from the DHCP client to the DHCP server. The default is 32.
remote-id	Enables the relay agent to add information about the relay to DHCPv6 messages before relaying the messages to the DHCP server. The default is disabled

Use the data in the following table to use the **interface** command.

Variable	Value
<1-4059>	Specifies the VLAN ID in the range of 1 to 4059. By default, VLAN IDs 1 to 4059 are configurable and the system reserves VLAN IDs 4060 to 4094 for internal use. On switches that support the vrf-scaling and spbm-config-mode boot configuration flags, if you enable these flags, the system also reserves VLAN IDs 3500 to 3998. VLAN ID 1 is the default VLAN and you cannot create or delete VLAN ID 1.
{slot/port[/sub-port][/-slot/port[/sub-port]][,...]}	Identifies the slot and port in one of the following formats: a single slot and port (slot/port), a range of slots and ports (slot/port-slot/port), or a series of slots and ports (slot/port,slot/port,slot/port). If your platform supports channelization and the port is channelized, you must also specify the sub-port in the format slot/port/sub-port.

Viewing DHCP Relay information

View DHCP Relay information to display the current configuration for the forwarding path and the interface configuration.

About this task

Not all parameters are available in non-default VRFs.

Procedure

1. Enter Privileged EXEC mode:

```
enable
```

2. View DHCP Relay global information:

```
show ipv6 dhcp-relay {counters [vrf WORD<1-16> | vrfids WORD<0-512>]
| fwd-path [vrf WORD<1-16> | vrfids WORD<0-512>]}
```

3. View IPv6 DHCP Relay interface configuration:

```
show ipv6 dhcp-relay interface {gigabitEthernet {slot/port[/sub-
port] [-slot/port[/sub-port]] [,...]} | vlan <1-4059>}
```

* Note:

The `no ipv6 dhcp-relay` command disables DHCP on the interface but does not delete the entry.

Example

```
Switch:1(config-if)#show ipv6 dhcp-relay fwd-path
```

```
=====
DHCPv6 Fwd-path - GlobalRouter
=====
```

```

INTERFACE                                SERVER                                ENABLE
-----                                -
1111:0:0:0:0:0:0:1111                    1234:0:0:0:0:0:0:1234                enable

Switch:1(config-if)#show ipv6 dhcp-relay interface gigabitEthernet 5/1
=====
                                Port Dhcpv6
=====
PORT NUM    IF INDEX    MAX HOP    DHCP-RELAY    REMOTE ID
-----
1/1         320         30         enable        disable

```

Variable definitions

Use the information in the following table to help you use the `show ipv6 dhcp-relay` command.

Variable	Value
{slot/port[/sub-port][/-slot/port[/sub-port]][,...]}	Identifies the slot and port in one of the following formats: a single slot and port (slot/port), a range of slots and ports (slot/port-slot/port), or a series of slots and ports (slot/port,slot/port,slot/port). If your platform supports channelization and the port is channelized, you must also specify the sub-port in the format slot/port/sub-port.
vlan<1-4059>	Specifies the VLAN ID in the range of 1 to 4059. By default, VLAN IDs 1 to 4059 are configurable and the system reserves VLAN IDs 4060 to 4094 for internal use. On switches that support the vrf-scaling and spbm-config-mode boot configuration flags, if you enable these flags, the system also reserves VLAN IDs 3500 to 3998. VLAN ID 1 is the default VLAN and you cannot create or delete VLAN ID 1.
vrf WORD<1-16>	Specifies the VRF name.
vrfids WORD<0-512>	Specifies the VRF ID.

DHCP Relay configuration using EDM

Configuring a DHCP Relay forwarding path

Configure a forwarding path to specify the relay agent address and the DHCP server address to which to forward packets.

To use DHCP Relay for IPv6, you must configure at least one forwarding path and enable the relay on one interface.

Before you begin

Change the VRF instance as required to configure a DHCP Relay forwarding path on a specific VRF instance. Not all parameters are configurable on non-default VRFs.

About this task

The relay agent can use the IPv6 address of the interface or the VRRP global address linked to that interface. The relay forwards the DHCP messages only if VRRP is in the Master state, otherwise the relay discards the messages.

You can configure only one relay agent on an interface. If you need to change the relay agent, you must delete all the forwarding paths with the old relay agent, and then configure the new relay agent.

For scaling information on DHCP Relay forwarding paths, see *Release Notes*.

Procedure

1. In the navigation tree, expand the following folders: **Configuration > IPv6**.
2. Click **DHCP Relay**.
3. Click the **Forward Path** tab.
4. Click **Insert**.
5. In the **AgentAddr** field, type the address of the input interface that forwards the packets.
6. In the **ServerAddr** field, type the address of the DHCP server.
7. Select **Enabled**.
8. Click **Insert**.

Forward Path field descriptions

Use the data in the following table to use the **Forward Path** tab.

Name	Description
AgentAddr	Specifies the IP address of the input interface (relay agent) on which the DHCP request packets are received for forwarding. This address is the IPv6 or VRRP global address of either a brouter port or a VLAN for which forwarding is enabled.
ServerAddr	Specifies the IP address of the DHCP server. The request is unicast to the server address.
Enabled	Enables DHCP Relay for the system. The default is disabled (clear).

Configuring DHCP Relay for an interface

Configure the DHCP relay behavior on the interface.

Before you begin

Change the VRF instance as required to configure DHCP Relay for an interface on a specific VRF instance. Not all parameters are configurable on non-default VRFs.

About this task

You can configure only one relay for a VLAN, regardless of how many addresses are configured on that VLAN. The default address is the smallest address configured. If the relay is a VRRP address, the default value is the first VRRP address configured.

You can modify the DHCP Relay configuration for a brouter port through the **Edit > Port > IPv6** navigation path, and for a VLAN through the **VLAN > VLANs > Basic > IPv6** navigation path. This procedure uses the main IPv6 navigation path where you can configure both types of interfaces.

Procedure

1. In the navigation tree, expand the following folders: **Configuration > IPv6**.
2. Click **DHCP Relay**.
3. Click the **Interface** tab.
4. Click **Insert**.
5. Beside the **IfIndex** field, click **Port** or **Vlan**.
6. Select a port or VLAN, and then click **OK**.
7. Click **Insert**.

Interface field descriptions

Use the data in the following table to use the Interface tab.

Name	Description
IfIndex	Shows the unique value to identify an IPv6 interface. For the brouter port, the value is the ifindex of the port and, in the case of the VLAN, the value is the ifindex of the VLAN.
MaxHop	Specifies the maximum number of hops a DHCP packet can take from the DHCP client to the DHCP server. The default is 32.
RemoteldEnabled	Enables the relay agent to add information about the relay to DHCPv6 messages before relaying the messages to the DHCP server. The default is disabled (clear or false).

Modifying DHCP Relay for a VLAN

Modify the existing DHCP relay behavior on the VLAN interface.

About this task

You can configure only one relay for a VLAN, regardless of how many addresses are configured on that VLAN. The default address is the smallest address configured. If the relay is a VRRP address, the default value is the first VRRP address configured.

Procedure

1. In the navigation tree, expand the following folders: **Configuration > VLAN**.
2. Click **VLANs**.
3. Click the **Basic** tab.
4. Select a VLAN.
5. Click **IPv6**.
6. Click the **DHCP Relay** tab.
7. Double-click a cell to change the value.
8. Click **Apply**.

DHCP field descriptions

Use the data in the following table to use the **DHCP Relay** tab.

Name	Description
IfIndex	Shows the unique value to identify an IPv6 interface.
MaxHop	Specifies the maximum number of hops a DHCP packet can take from the DHCP client to the DHCP server. The default is 32.
RemoteldEnabled	Enables the relay agent to add information about the relay to DHCPv6 messages before relaying the messages to the DHCP server. The default is disabled (clear or false).
DhcpEnabled	Enables (true) or disables (false) DHCP Relay for an interface with an existing DHCP Relay configuration.

Modifying DHCP Relay for a port

Modify the existing DHCP relay behavior on the brouter port interface.

About this task

The default address is the smallest address configured. If the relay is a VRRP address, the default value is the first VRRP address configured.

Procedure

1. In the Device Physical View, select the port.
2. In the navigation pane, expand the following folders: **Configuration > Edit > Port**.

3. Click **IPv6**.
4. Click **DHCP Relay**.
5. Double-click a cell to change the value.
6. Click **Apply**.

DHCP Relay field descriptions

Use the data in the following table to use the DHCP Relay tab.

Name	Description
IfIndex	Shows the unique value to identify an IPv6 interface. For the brouter port, the value is the ifindex of the port and, in the case of the VLAN, the value is the ifindex of the VLAN.
MaxHop	Specifies the maximum number of hops a DHCP packet can take from the DHCP client to the DHCP server. The default is 32.
RemoteIdEnabled	Enables the relay agent to add information about the relay to DHCPv6 messages before relaying the messages to the DHCP server. The default is disabled (clear or false).
DhcpEnabled	Enables (true) or disables (false) DHCP Relay for an interface with an existing DHCP Relay configuration. This field appears on the DHCP Relay tab for a brouter port only if you modify an existing configuration. This field does not appear if you create a new DHCP Relay port configuration.

Chapter 6: Tunneling

This chapter provides concepts and procedures to complete IPv6 tunnel configuration.

Tunneling

Tunneling provides a mechanism to transfer IPv6 traffic through an IPv4-only network.

How tunneling works:

IPv6 tunneling encapsulates IPv6 packets in IPv4 packets for delivery across an IPv4 infrastructure.

At the tunnel source, or head end, the system encapsulates an IPv6 packet into an IPv4 packet and sends it to the remote tunnel destination.

The tunnel destination strips the IPv4 packet header and forwards the original IPv6 packet further into an IPv6 cloud.

These types of tunnels are called dual-stack tunnels because they support both IPv4 and IPv6.

Manually configured tunnels

Manually configured tunnels can provide communication between two isolated IPv6 domains over an IPv4 network.

Manually configured tunnels are point-to-point.

You can configure tunnel endpoints to create a point-to-point connection between two isolated IPv6 domains by configuring IPv6 and IPv4 addresses at each end of the tunnel.

Note:

The router or host at the source and destination ends of the tunnel must support both IPv4 and IPv6 protocol stacks.

Caution:

Ensure that all single-homed point-to-point traffic ingresses and egresses a configured tunnel. Otherwise the traffic is dropped.

IPv6 reachability enables tunnel forwarding but tunnel operational status depends on the IPv4 reachability of the tunnel endpoint.

The IPv4 tunnel endpoint configuration must be symmetrical; that is, if you configure a tunnel with a source of 10.10.10.1 and a destination of 11.11.11.1 from switch A, then Switch B must have a source of 11.11.11.1 and a destination of 10.10.10.1.

Tunnel interfaces are logical point-to-point interfaces.

You can enable dynamic routing when you enable a routing protocol, for example OSPFv3, on the tunnel interfaces.

Unicast routing protocols can detect link loss and redirect IPv6 route information:

There is no explicit signaling protocol applied to IPv6-in-IPv4 configured tunnels (refer to RFC 4213).

Therefore, if the remote endpoint of a tunnel that terminates several Layer 3 hops away in the network fails, the local state of the tunnel remains active even though the endpoint has failed.

However, you can enable unicast routing protocols over tunnels, for example OSPFv3. These unicast routing protocols introduce their own protocol-specific signaling and, when a unicast routing protocol is present over the tunnel link, the routing protocol can detect link loss and re-direct the IPv6 route information to use an alternate, reachable nexthop.

Operational events that trigger tunnel state transition:

The switch must be able to locally detect operational events that can trigger a tunnel state transition.

These events include:

- deletion of local IPv4 interface
- change or loss of the IPv4 route to the remote tunnel endpoint
- change in the nexthop of the IPv4 route to the remote tunnel endpoint
- loss of the ARP entry for the nexthop router that is used to reach the IPv4 tunnel endpoint

Tunnels and MTU:

You cannot configure the MTU for tunnels.

The default MTU value for tunnels is 1280.

Packets are forwarded through the tunnel using the line card network processing units (NPUs) only. Since the packets are not forwarded through the central processing unit (CPU) they do not impact the CPU load.

Tunnels and BGP+: You must configure an IPv6 tunnel and static routes on BGP+ peers when you use BGP+. For more information on IPv6 tunnel configuration for BGP+, see *Configuring BGP Services*.

Limitations

The following list identifies tunnel configuration limitations.

- You cannot configure IPv6 CLIP addresses for IPv6-in-IPv4 tunnels. Also, you cannot configure an IPv6 CLIP interface as the source or destination endpoint of a tunnel.
- You cannot configure SMLT on the switch terminating a tunnel.
- You cannot configure tunneling on vIST peers. Termination of tunnels on vIST peers is not supported.

Tunneling configuration using the CLI

Configuring a tunnel

Configure a tunnel for IPv6 VLANs or brouter ports to communicate through an IPv4-only network. Create a point-to-point connection between the two isolated IPv6 devices by configuring the tunnel endpoints.

Do not create tunnels in a native IPv6 network.

Before you begin

- The router or host at the source and destination of the tunnel must support both IPv4 and IPv6 protocol stacks.

About this task

Manual tunnels are point-to-point, so you configure both source and destination addresses. You must configure both IPv6 and IPv4 addresses for both source and destination devices. The IPv6 addresses must represent the same network, for example 6666::1/96 and 6666::2/96.

Tunnel interfaces are automatically configured with a link-local address in the format fe80::<local_ipv4_source_address>.

You cannot configure the maximum transmission unit (MTU) for tunnels. The default MTU value for tunnels is 1280.

Procedure

1. Enter Global Configuration mode:

```
enable
configure terminal
```

2. Create a tunnel:

```
ipv6 tunnel <1-2000> source {A.B.C.D} address WORD<0-46> destination
{A.B.C.D}
```

Example

Create tunnel 2:

```
Switch:1(config)#ipv6 tunnel 2 source 11.11.11.1 address
3000:0:0:0:0:0:0:1/64 destination 12.12.12.2
```

Variable definitions

Use the data in the following table to use the `ipv6 tunnel` command.

Variable	Value
<1-2000>	Configures the ID for the tunnel.

Table continues...

Variable	Value
address <i>WORD</i> <0-46>	Assigns an IPv6 address and prefix to the tunnel.
destination {A.B.C.D}	Configures the address of the remote endpoint of the tunnel.
source {A.B.C.D}	Configures the address of the local endpoint of the tunnel.

Viewing tunnel interfaces

View tunnel interfaces to verify the current configuration and operational status of IPv6 tunnels.

Procedure

1. Enter Privileged EXEC mode:

```
enable
```

2. Show IPv6 tunnel information:

```
show ipv6 tunnel [<1-2000>] [detail] [local {A.B.C.D}] [remote {A.B.C.D}]
```

Example

```
Switch:1#show ipv6 tunnel detail
```

```
=====
                        Tunnel Interface Information
=====
ID          LOCAL ADDRESS    REMOTE ADDRESS    OPER STATUS  TYPE
-----
2           211.1.55.2          44.1.55.1        active       manual
1           211.1.55.2          44.1.55.43       active       manual
210         211.1.60.2          47.1.60.1        active       manual

3 out of 3 Total number of entries displayed.
```

```
=====
                        Address Information
=====
IPV6 ADDRESS/PREFIX LENGTH          TYPE    ORIGIN    STATUS
-----
43:210:0:0:0:0:0:2/64                UNICAST MANUAL    PREFERRED
fe80:0:0:0:0:0:d301:3702/64          UNICAST LINKLAYER PREFERRED
44:211:0:0:0:0:0:2/64                UNICAST MANUAL    PREFERRED
fe80:0:0:0:0:0:d301:3702/64          UNICAST LINKLAYER PREFERRED
```

Variable definitions

Use the data in the following table to use the `show ipv6 tunnel` command.

Variable	Value
<1–2000>	Shows information for a specific tunnel ID.
detail	Shows detailed address information for the tunnel.
local {A.B.C.D}	Shows information for a specific local address (the local endpoint of the tunnel).
remote {A.B.C.D}	Shows information for a specific remote address (the remote endpoint of the tunnel).

Modifying tunnel hop limits

Modify tunnel hop limits to update hop-limit values on previously configured tunnels.

About this task

The tunnel hop limit configures the value of the time-to-live (TTL) for IPv4 packets.

Procedure

1. Enter Global Configuration mode:

```
enable
configure terminal
```

2. Modify the hop limit:

```
ipv6 tunnel <1-2000> hop-limit <0-255>
```

Example

Modify the hop limit for tunnel ID 5:

```
Switch:1(config)#ipv6 tunnel 5 hop-limit 200
```

Variable definitions

Use the data in the following table to use the `ipv6 tunnel` command.

Variable	Value
<0–255>	Configures the maximum number of hops in the tunnel. The default value is 255.
<1–2000>	Specifies the tunnel ID.

Tunnel configuration using EDM

Configuring a tunnel

Configure a tunnel for IPv6 VLANs or brouter ports to communicate through an IPv4-only network. Create a point-to-point connection between the two isolated IPv6 devices by configuring the tunnel endpoints.

Do not create tunnels in a native IPv6 network.

Before you begin

- The router or host at the source and destination of the tunnel must support both IPv4 and IPv6 protocol stacks.

About this task

Manual tunnels are point-to-point, so you configure both source and destination addresses. You must configure both IPv6 and IPv4 addresses for both source and destination devices. The IPv6 addresses must represent the same network, for example 6666::1/96 and 6666::2/96.

Tunnel interfaces are automatically configured with a link-local address in the format fe80::<local_ipv4_source_address>.

You cannot configure the maximum transmission unit (MTU) for tunnels. The default MTU value for tunnels is 1280.

Procedure

1. In the navigation tree, expand the following folders: **Configuration > IPv6**.
2. Click **Tunnel**.
3. Click the **Tunnel Config** tab.
4. Click **Insert**.
5. Beside the **LocalAddress** field, click the button, and then select the IPv4 address for the local VLAN or brouter port.
6. In the **RemoteAddress** field, type the IPv4 address for the destination VLAN or brouter port.
7. In the **ID** field, type a number to represent the tunnel.
8. In the **IPv6AddressAddr** field, type the IPv6 address for the tunnel VLAN or brouter port.
9. In the **IPv6AddressPrefixLength** field, type the number of bits to advertise in the IPv6 address.
10. Click **Insert**.

Tunnel Config field descriptions

Use the data in the following table to use the **Tunnel Config** tab.

Name	Description
AddressType	Shows the address type over which the tunnel encapsulates packets.
LocalAddress	Configures the address of the local endpoint of the tunnel.
RemoteAddress	Configures the address of the remote endpoint of the tunnel.
EncapsMethod	Configures the tunnel mode, which is manual for manually configured tunnels.
ID	Configures the ID for the tunnel.
IfIndex	Shows the value of ifIndex that corresponds to the tunnel interface. A value of 0 indicates that the interface index has not yet been assigned. This field appears only on the Tunnel Config tab.
Ipv6AddressAddr	Specifies the IPv6 address for the local VLAN or brouter port. This field appears only on the Insert Tunnel Config dialog box.
Ipv6AddressPrefixLength	Specifies the number of bits to advertise in the IPv6 address. This field appears only on the Insert Tunnel Config dialog box.

Modifying tunnel hop limits

Modify tunnel hop limits to update hop-limit values on previously configured tunnels.

Use this procedure to modify the hop limits for multiple tunnels simultaneously.

About this task

The tunnel hop limit configures the value of the time-to-live (TTL) for IPv4 packets.

Procedure

1. In the navigation pane, expand the **Configuration > IPv6** folders.
2. Click **Tunnel**.
3. Click the **Tunnel Interface** tab.
4. Double-click the **HopLimit** value to modify the information as required.
5. Click **Apply**.

Tunnel Interface field descriptions

Use the data in the following table to use the **Tunnel Interface** tab.

Name	Description
Index	Identifies the tunnel interface internally. The value is derived from the tunnel ID.
EncapsMethod	Displays the encapsulation method for the tunnel: manual for manually configured tunnels and 6to4 for automatically configured tunnels.
HopLimit	Configures the maximum number of hops in the tunnel. The default value is 255.
Security	Indicates the type of security on the tunnel interface.
TOS	Displays the method used to configure the high 6 bits (the differentiated services codepoint) of the IPv4 type of service (TOS) or IPv6 traffic class in the outer IP header. A value of -1 indicates that the bits are copied from the payload header. A value of -2 indicates that a traffic conditioner is invoked and more information can be available in a traffic conditioner MIB module. A value from 0 to 63 indicates that the bit field is configured to the indicated value.
FlowLabel	Displays the method used to configure the IPv6 flow label value. This object is not required where AddressType indicates the tunnel is not over IPv6. A value of -1 indicates that a traffic conditioner is invoked and more information can be available in a traffic conditioner MIB. Any other value indicates that the flow label field is configured to the indicated value.
AddressType	Displays manual for a manually configured tunnel, or sixToFour for autoconfigured tunnels.
LocalnetAddress	Identifies the local endpoint address of the tunnel.
RemotenetAddress	Identifies the remote endpoint of the tunnel.
EncapsLimit	Displays the maximum number of additional encapsulations permitted for packets undergoing encapsulation at this node. A value of -1 indicates that no limit exists, except as a result of the packet size.

Modifying tunnel hop limits for a specific tunnel

Modify tunnel hop limits to update hop-limit values on previously configured tunnels.

Use this procedure to modify the hop limits for a specific tunnel interface.

About this task

The tunnel hop limit configures the value of the time-to-live (TTL) for IPv4 packets.

Procedure

1. In the navigation pane, expand the **Configuration > IPv6** folders.
2. Click **Tunnel**.
3. Click the **Tunnel Config** tab.
4. Select the tunnel row.
5. Click **Tunnel Interface**.
6. Double-click the **HopLimit** value to modify the information as required.
7. Click **Apply**.

Tunnel Interface field descriptions

Use the data in the following table to use the **Tunnel Interface** tab.

Name	Description
Index	Identifies the tunnel interface internally. The value is derived from the tunnel ID.
EncapsMethod	Displays the encapsulation method for the tunnel: manual for manually configured tunnels and 6to4 for automatically configured tunnels.
HopLimit	Configures the maximum number of hops in the tunnel. The default value is 255.
Security	Indicates the type of security on the tunnel interface.
TOS	<p>Displays the method used to configure the high 6 bits (the differentiated services codepoint) of the IPv4 type of service (TOS) or IPv6 traffic class in the outer IP header.</p> <p>A value of -1 indicates that the bits are copied from the payload header. A value of -2 indicates that a traffic conditioner is invoked and more information can be available in a traffic conditioner MIB module. A value from 0 to 63 indicates that the bit field is configured to the indicated value.</p>
FlowLabel	<p>Displays the method used to configure the IPv6 flow label value. This object is not required where AddressType indicates the tunnel is not over IPv6. A value of -1 indicates that a traffic conditioner is invoked and more information can be available in a traffic conditioner MIB. Any other value indicates that the flow label field is configured to the indicated value.</p>
AddressType	Displays manual for a manually configured tunnel, or sixToFour for autoconfigured tunnels.

Table continues...

Name	Description
LocalnetAddress	Identifies the local endpoint address of the tunnel.
RemotenetAddress	Identifies the remote endpoint of the tunnel.
EncapsLimit	Displays the maximum number of additional encapsulations permitted for packets undergoing encapsulation at this node. A value of -1 indicates that no limit exists, except as a result of the packet size.

Viewing IPv6 addresses on a tunnel

View a tunnel for IPv6 addresses.

You can assign an IPv6 address to a VLAN or router port.

About this task

To create MLT and LAG interfaces with IPv6, you must configure VLAN-based connections and you cannot use router ports.

You can also assign an IPv6 address through the **Edit > Port > IPv6** navigation path, and through the **VLAN > VLANs > Basic > IPv6** navigation path.

Procedure

1. In the navigation pane, expand the following folders: **Configuration > IPv6**.
2. Click **Tunnel**.
3. Click the **Tunnel Config** tab.
4. Click **IPv6 Address**.

Tunnel Config field descriptions

Use the data in the following table to use the **Tunnel Config** tab.

Name	Description
AddressType	Shows the address type over which the tunnel encapsulates packets.
LocalAddress	Configures the address of the local endpoint of the tunnel.
RemoteAddress	Configures the address of the remote endpoint of the tunnel.
EncapsMethod	Configures the tunnel mode, which is manual for manually configured tunnels.
ID	Configures the ID for the tunnel.

Table continues...

Name	Description
IfIndex	Shows the value of ifIndex that corresponds to the tunnel interface. A value of 0 indicates that the interface index has not yet been assigned. This field appears only on the Tunnel Config tab.

Chapter 7: OSPFv3

This chapter provides concepts and procedures to complete IPv6 Open Shortest Path First (OSPF)v3 configuration.

OSPFv3

The Open Shortest Path First Protocol (OSPF) for IPv6, defined in RFC 2740 and RFC 5340, is an Interior Gateway Protocol used to distribute IPv6 routing information within a single Autonomous System (AS).

The IPv4 terms subnet and network are replaced in IPv6 by link. An IPv6 link is a communication medium between nodes at the link layer. You can assign multiple IP subnets (prefixes) to a link. Two IPv6 nodes with common or different prefixes can communicate over a single link.

OSPF for IPv6 operates on each link rather than each subnet as in IPv4. IPv6 makes the following changes to how packets are received and to the contents of network LSAs and hello packets:

- The OSPF packet contains no IPv6 addresses. LSA payloads carried in link state update packets contain IPv6 addresses.
- The following IDs remain at 32-bits and are not assigned IPv6 addresses: area IDs, LSA link state IDs, and OSPF router IDs.
- IPv6 OSPF neighbors use Router IDs to identify neighboring routers on broadcast and nonbroadcast multiaccess (NBMA) networks and for other communication media, point to point.

Flooding scope

LSA flooding scope is generalized in OSPFv3 and coded in the LS type field of the LSA. The following three flooding scopes are available for LSAs:

- Link scope: The LSA is not flooded beyond the local link.
- Area scope: The LSA is flooded in a single OSPF area. Area scope is used in router LSAs, network LSAs, Inter-Area-Prefix-LSAs, Inter-Area-Router LSAs, and Intra-Area-Prefix-LSAs.
- AS scope: The LSA is flooded through the routing domain. AS scope is used for AS external-LSAs.

Link-local addresses

IPv6 uses link-local addresses on a single link. Link-local addresses facilitate features such as neighbor discovery and autoconfiguration. Datagrams with link-local sources are not forwarded. Instead, routers assign link-local unicast addresses from the IPv6 address range.

OSPF for IPv6 does not assign link-local unicast addresses to physical segments attached to a router, it assumes that each router already has link-local unicast addresses assigned. The source for all OSPF packets sent on OSPF physical interfaces is the associated link-local unicast address. Routers learn link-local addresses for all other nodes on links. The nexthop information during packet forwarding includes the learned addresses.

OSPFv3 packets always use link-local addresses as the source and destination, except on a virtual link. All OSPFv3 packets sent over a virtual link use global addresses.

Link LSA is the only OSPF LSA type that includes link-local addresses. Link-local addresses must not be advertised in other LSA types.

Authentication

OSPFv3 for IPv6 requires the IP authentication header and the IP encapsulating security payload for authentication and security. OSPFv3 does not support the authentication feature from OSPFv2.

Packet format

OSPFv3 runs directly over IPv6. All other addressing information is absent in OSPF packet headers. OSPFv3 is network-protocol-independent. LSA types contain addressing information.

OSPFv3 implements the following packet changes from OSPFv2:

- The hello packet and database description packet operations fields are expanded to 24 bits.
- The packet header does not include Authentication and AuType fields.
- The interface ID replaces the address information in the hello packet. The Interface ID becomes the network LSA link-state ID, if the router becomes the designated router on the link.
- Router-bit (R-bit) and V6-bit in the options field process router LSAs during Shortest Path First (SPF) calculation. R-bits and V6-bits determine participation in topology distribution. The V6-bit specializes the R-bit. If the V6-bit is clear, the OSPF speaker can participate in the OSPF topology distribution without forwarding IPv6 datagrams. If the R-bit is set and the V6-bit is clear, the OSPF speaker still does not forward IPv6 datagrams, but it can forward IPv4 datagrams.
- The packet header includes the instance ID, which allows multiple OSPF protocol instances on the same link.

R-bit

Unlike OSPF for IPv4, OSPFv3 for IPv6 supports the R-bit. The R-bit indicates whether the originating node is an active router. If the R-bit is cleared, routes that transit the advertising node cannot be calculated.

For example, if a multi-homed host participates in routing without forwarding non-locally-addressed packets, the R-bit is cleared.

An IPv6-enabled switch can continue to operate as an OSPFv3 neighbor even if you disable IPv6 forwarding on the switch. This behavior differs from IPv4 OSPF, in which the switch drops a neighbor, if IP forwarding on the neighbor is disabled.

LSAs

OSPFv3 includes link LSAs and Intra-Area-Prefix LSAs.

Link LSA:

The link LSA uses link flooding scope, not flooded beyond the associated link.

Link LSAs have three purposes:

- to provide the link-local address of the router to all other nodes on the link
- to provide the list of IPv6 prefixes associated with the link
- to allow the router to associate options bits with the network LSA for the link

Intra-Area-Prefix LSA:

The Intra-Area-Prefix-LSA carries all IPv6 prefix information. In IPv4, this information is in router LSAs and network LSAs.

Unknown LSA types:

In OSPFv3, unknown LSA types are either stored and flooded as though understood or given link flooding scope. Specific behavior is coded in the LS type field of the header.

Link LSA Suppression

To decrease unnecessary link LSA generation and flooding for non-broadcast and non-NBMA interfaces, the Link LSA Suppression interface configuration parameter has been added in RFC 5340. If Link LSA Suppression is configured for an interface, and the interface type is not broadcast or NBMA, the originated link LSA may be suppressed. Link LSA suppression is disabled, by default. For more information on configuration see, [Configuring OSPF on a port or VLAN](#) on page 153.

Stub area

OSPFv3 retains the concept of stub areas, which minimize link-state databases and routing table sizes.

IPv6 stub areas carry only router LSAs, network LSAs, Inter-Area-Prefix-LSAs, link LSAs, and Intra-Area-Prefix-LSAs.

Unlike IPv4, IPv6 can store LSAs with unrecognized link-state (LS) types or flood them as though they are understood. Rules applied to the stub area prevent the excessive growth of the link-state database. An LSA with an unrecognized link state can be flooded only if the LSA uses area- or link-flooding scope, and the LSA U-bit is 1 throughout stub and NSSA areas.

Stub area

OSPFv3 retains the concept of stub areas, which minimize link-state databases and routing table sizes.

IPv6 stub areas carry only router LSAs, network LSAs, Inter-Area-Prefix-LSAs, link LSAs, and Intra-Area-Prefix-LSAs.

Unlike IPv4, IPv6 can store LSAs with unrecognized link-state (LS) types or flood them as though they are understood. Rules applied to the stub area prevent the excessive growth of the link-state database. An LSA with an unrecognized link state can be flooded only if the LSA uses area- or link-flooding scope, and the LSA U-bit is 0.

Deprecation of MOSPF for IPV6

OSPFv3 in RFC 5340 deprecates Multicast Extensions to OSPF (MOSPF) support, and its attendant protocol fields.

NSSA Specification

RFC 2740 partially specifies this protocol feature, the level of specification was insufficient to implement it. However, RFC 5340 includes an NSSA specification unique to OSPFv3. This specification coupled with NSSA provide sufficient specification for implementation. Current Infinity IPv6 OSPF has full support for NSSA feature and is consistent with the additional specifications in RFC 5340.

Stub Area Unknown LSA Flooding Restriction Deprecated

In RFC 2740, flooding of unknown LSA was restricted within stub and NSSA areas. Following were the restrictions:

- Unlike IPv4, in IPv6 you can label unrecognized LS types as "Store and flood the LSA, as if type understood". Uncontrolled introduction of such LSAs could cause a stub area's link-state database to grow larger than its component router's capacities
- To guard the above situation, the following rule regarding stub areas has been established:

An LSA whose LS type is unrecognized can be flooded only into a stub area, if both the LSAs have area or link-local flooding scope, and the LSA has U-bit set to 0

Now the above restrictions have been deprecated. OSPFv3 routers flood link and area scope LSAs whose LS type is unrecognized and U-bit is set to 1 throughout stub and NSSA areas. The only backward compatibility issue is that the OSPFv3 routers still supporting the restrictions may not propagate newly defined LSA types.

LSA Options and Prefix Options Updates

The LSA Options and Prefix Options fields have been updated to reflect recent protocol additions. Specifically, bits related to MOSPF have been deprecated, Options field bits common with OSPFv2 have been reserved, and the DN-bit has been added to the prefix- options.

IPv6 Site-Local Address

All references to IPv6 site-local addresses have been removed in RFC 5340. Infinity IPv6 OSPF does not contain any reference to IPv6 site-local addresses and is already compliant with RFC 5340 for this.

IPsec support with OSPFv3

You can use Internet Protocol Security (IPsec) with OSPFv3 virtual link for the security protection of communication between the end points. You can also use IPsec with OSPFv3 on a brouter port or VLAN interface, for example, if you want to encrypt OSPFv3 control traffic on a broadcast network.

OSPF virtual link provides connectivity to the OSPF backbone area for redundancy or to provide a virtual link if a physical connection is not possible.

Because the device does not know the IPv6 addresses of the OSPFv3 virtual link end points at the time of configuration, you cannot manually configure the security policy ahead of time. The system must self-manage its security policy dynamically. The device also dynamically manages the IPsec enable flag, which the virtual link uses on a Layer 2 interface, either a VLAN or brouter port interface.

The following events can trigger an IPsec policy activation:

1. An OSPFv3 routing module detects the establishment of a virtual link.
2. IPsec is enabled on the already established virtual link.

On the other hand, the following two events can dynamically trigger an IPsec policy deactivation:

1. The virtual link is turn down.
2. IPsec is disabled on the virtual link.

IPsec policies can also change dynamically if a neighbor address or a local address changes.

You can enable IPsec support for IPv6 OSPF virtual link at the system level through CLI. You must disable IPsec before you can perform virtual link policy configuration changes.

Until you enable IPsec on both sides of the virtual links, the links cannot exchange OSPFv3 control messages, and the system drops OSPFv3 exchange packets.

You can configure the direction you want IPsec to protect, either, ingress, egress, or both. In addition, you can permit or drop communication for the OSPF virtual link.

You can also use IPsec with OSPFv3 on a brouter port or VLAN interface. For a full configuration example and more information on IPsec, see *Configuring Security*.

OSPF Graceful Restart

In many OSPF networks, OSPF routers remove a restarting OSPF router from the network topology, if the router is restarted. This action causes all OSPF routers to re-converge and route around the restarting router. The OSPF Graceful Restart feature is an OSPF enhancement to allow an OSPF router to stay on the forwarding path when the software is restarting.

This feature is documented under RFC 3623 for OSPFv2 (IPv4) and RFC 5187 for OSPFv3 (IPv6). The switch software supports only helper mode for both OSPFv2 and OSPFv3 protocols.

Helper mode

Helper mode is a part of the OSPF Graceful restart feature. Helper mode uses the OSPF routers to help other OSPF routers on the network stay on the forwarding path while the software is restarting. The OSPF router sends a type of LSA called a GRACE-LSA to inform the other OSPF routers that it is restarting the software. When an OSPF router receives a GRACE-LSA from a neighbor OSPF Router, it enters the Helper mode for that neighbor on that network. An OSPF router supports Helper mode by default.

Operations of Helper mode

The following section describes the operations in the Helper mode:

- Entering Helper mode — An OSPF router enters the Helper mode provided the following conditions are true:
 - The router is fully adjacent with the neighbor already.
 - No changes have been made in the LSDB since the neighbor router started.
 - The grace period has not expired.
 - Local policy configured parameters allow it to help the neighbor.
 - The router is not in the process of restarting itself.

The OSPF router will not help the neighbor if any of the above conditions are not met.

If the OSPF router is already helping a neighbor, and receives another GRACE-LSA from the neighbor, it accepts the latest GRACE-LSA, and updates the grace period accordingly. The OSPF router in Helper mode continues to advertise its LSAs like the neighbor it is helping is still full, until any changes are made on the network during the grace period.

- Exiting Helper mode — An OSPF router exits the Helper mode, under the following conditions:
 - The GRACE-LSA is flushed. It means graceful restart has successfully terminated.
 - The GRACE-LSA's grace period expires.
 - There is a network topology change.

When an OSPF router exits Helper mode, the following actions occur:

- It recalculates the DR for the network.
- It re-originates its router LSA.
- If it is the DR, it re-originates the network LSA for the network.
- If it is a virtual link, it re-originates the router LSA for the virtual link transit area.

ECMP with OSPFv3

The ECMP feature supports and complements OSPFv3 protocol.

With Equal Cost Multipath (ECMP), you can use multiple paths for load sharing of traffic. These multiple paths allow faster convergence to other active paths in case of network failure. By maximizing load sharing among equal-cost paths, you can use your links between routers more efficiently when sending IP and IPv6 traffic. Equal Cost Multipath is formed using routes from the same protocol.

Note:

To add OSPFv3 equal cost paths in the routing table, you must first enable IPv6 ECMP feature globally.

For scaling information on the ECMP paths supported per destination prefix, see *Release Notes*.

OSPFv3 configuration using the CLI

Configuring OSPF globally

Configure OSPFv3 globally to enable it on the system and to configure the router ID.

Procedure

1. Enter Global Configuration mode:

```
enable
configure terminal
```

2. Enable OSPFv3 for IPv6:

```
router ospf ipv6-enable
```

The default is disabled.

3. Log on to OSPF Router Configuration mode:

```
router ospf
```

4. Specify the router ID:

```
ipv6 router-id {A.B.C.D}
```

5. Optionally, make the router an autonomous system (AS) boundary router (BR):

```
ipv6 as-boundary-router enable
```

Enable the ASBR if the router attaches at the edge of the OSPF network, and has one or more interfaces that run an interdomain routing protocol. The default is disabled.

Example

Enable OSPFv3 for IPv6:

```
Switch:1(config)#router ospf ipv6-enable
```

Log on to OSPF Router Configuration mode:

```
Switch:1(config)#router ospf
```

Specify the router ID:

```
Switch:1(config-ospf)#ipv6 router-id 1.1.1.1
```

Variable definitions

Use the data in the following table to use the `ipv6 router-id` command.

Variable	Value
{A.B.C.D}	Specifies a 32-bit integer that identifies the router in the autonomous system. This value must be unique.

Variable	Value
	The default value will be one of the IPv4 interface addresses.

Creating an OSPF area

Create an area to subdivide the autonomous system (AS) into areas that group contiguous networks, routers that connect to these networks, and attached hosts. Subdividing the AS into areas significantly reduces the amount of routing protocol traffic compared to treating the entire AS like a single link-state domain.

About this task

A stub area does not receive advertisements for external routes, which reduces the size of the link-state database (LSDB). A stub area uses only one area border router (ABR). Any packets destined for outside the area are routed to the area border exit point, examined by the ABR, and forwarded to a destination.

A not so stubby area (NSSA) prevents the flooding of AS-External link-state advertisements into the area by replacing them with a default route. NSSAs also import small stub (non- OSPF) routing domains into OSPF.

Procedure

1. Enter OSPF Router Configuration mode:

```
enable
configure terminal
router ospf
```

2. Specify the area ID:

```
ipv6 area {A.B.C.D}
```

3. Configure optional area parameters if the default values do not meet your requirements:

- a. Configure the area type if you need a stub or NSSA area:

```
ipv6 area {A.B.C.D} type <nssa|stub>
```

By default, the area is a normal area; neither a stub nor NSSA area.

- b. Configure the default cost:

```
ipv6 area {A.B.C.D} default-cost <0-16777215>
```

You do not need to configure this parameter if the area is a normal area.

- c. Configure the area support for importing advertisements:

```
ipv6 area {A.B.C.D} import <external|noexternal|nssa>
```

The default is external.

- d. Disable the importation of summary advertisements into a stub area:

```
no ipv6 area {A.B.C.D} import-summaries enable
```

The default is enabled.

- e. Configure translation of Type 7 LSAs into Type 5 LSAs:

```
ipv6 area {A.B.C.D} translator-role <1-2>
```

The default value is 2—candidate.

Example

Specify the area ID:

```
Switch:1(config-ospf)#ipv6 area 0.0.0.1
```

Variable definitions

Use the data in the following table to use the **ipv6 area** command.

Variable	Value
{A.B.C.D}	Specifies a 32-bit integer to uniquely identify an area. Use 0.0.0.0 for the OSPFv3 backbone.
default-cost <0-16777215>	Configures the metric value advertised for the default route to stub and NSSA areas.
import <external noexternal nssa>	Configures area support for importing AS-external LSAs: <ul style="list-style-type: none"> • external—normal area • noexternal—stub area • nssa—not-so-stubby area AS-scope LSAs are not imported into stub areas or NSSAs. NSSAs import AS-External data at Type 7 LSAs, which use area scope. The default is external.
import-summaries enable	Controls the import of inter-area LSAs into a stub area. If you disable this parameter, the router does not originate nor propagate inter-area LSAs into the stub area. If you enable this parameter (the default), the router both summarizes and propagates inter-area LSAs.
<nssa stub>	Configures the type of area. By default, the area is neither a stub area or an NSSA.
translator-role <1-2>	Indicates if the NSSA border router can perform NSSA translation of Type 7 LSAs to Type 6 LSAs. The possible values are always (1) or candidate (2). The default is candidate (2).

Creating OSPF area ranges

Create an area address range on the OSPF router to reduce the number of area border router (ABR) advertisements into other OSPF areas. An area address range is an implied contiguous range of area network addresses for which the ABR advertises a single summary route.

Before you begin

- You must create the OSPF area.

About this task

If you create two ranges, and one range is a subset of the other, the router uses the most specific match.

Procedure

- Enter OSPF Router Configuration mode:

```
enable
configure terminal
router ospf
```

- Create an area range:

```
ipv6 area range {A.B.C.D} WORD<0-255> [inter-area-prefix-link|nssa-
extlink] advertise-mode <advertise|not-advertise> [advertise-metric
<0-65535>]
```

Example

Create an area range:

```
Switch:1(config-ospf)#ipv6 area range 0.0.0.1 3000::0/16 advertise-mode
advertise
```

Variable definitions

Use the data in the following table to use the **ipv6 area range** command.

Variable	Value
{A.B.C.D}	Specifies the area in which the address aggregate exists. Use dotted decimal notation to specify the area name.
advertise-metric <0-65535>	Specifies a cost value to advertise for the OSPF area range. This value applies to summary LSAs (Type 3). If the value is 0, OSPF uses the cost to the farthest point in the network that is summarized.
advertise-mode <advertise not-advertise>	Specifies the advertisement mode for prefixes in the range. advertise advertises the aggregate summary

Table continues...

Variable	Value
	LSA with the same link-state ID. not-advertise does not advertise networks that fall within the range. The default is advertise.
<inter-area-prefix-link nssa-extlink>	Specifies the area LSDB type to which the address aggregate applies. inter-area-prefix-link generates an aggregated summary. nssa-extlink generates an NSSA link summary.
WORD<0-255>	Specifies the IPv6 address and prefix.

Creating an OSPF virtual link

Create a virtual link if the switch does not connect directly to the backbone. The switch can create automatic virtual links or you can perform this procedure to create virtual links manually. Manual virtual links conserve resources and provide specific control over virtual link placement in your OSPF configuration.

Before you begin

- The router must be an ABR to create a virtual router interface.

About this task

Virtual linking is similar to backup redundancy. The switch creates a virtual link for vital traffic paths in your OSPF configuration if traffic is interrupted, such as when an interface cable that provides a connection to the backbone (either directly or indirectly) is disconnected from the switch. Automatic virtual linking ensures that a link is created by using another switch.

OSPF routes cannot be learned through an ABR unless it connects to the backbone directly or through a virtual link.

Procedure

- Enter OSPF Router Configuration mode:

```
enable
configure terminal
router ospf
```

- Create a virtual link:

```
ipv6 area virtual-link {A.B.C.D} {A.B.C.D}
```

- Configure optional parameters for the virtual link if the default values do not meet your requirements:

- Configure the router dead interval:

```
ipv6 area virtual-link {A.B.C.D} {A.B.C.D} dead-interval
<1-65535>
```

The default is 60 seconds.

b. Configure the hello interval:

```
ipv6 area virtual-link {A.B.C.D} {A.B.C.D} hello-interval
<1-65535>
```

The default is 10 seconds.

c. Configure the retransmit interval:

```
ipv6 area virtual-link {A.B.C.D} {A.B.C.D} retransmit-interval
<1-1800>
```

The default is 5 seconds.

d. Configure the transit delay:

```
ipv6 area virtual-link {A.B.C.D} {A.B.C.D} transit-delay
<1-1800>
```

The default is 1 second.

Example

Create a virtual link:

```
Switch:1(config-ospf)#ipv6 area virtual-link 0.0.0.1 2.2.2.2
```

Configure optional parameters for a virtual link:

```
Switch:1(config-ospf)#ipv6 area virtual-link 0.0.0.1 4.4.4.4 dead-
interval 90 retransmit-interval 10
```

Variable definitions

Use the data in the following table to use the `ipv6 area virtual-link` command.

Variable	Value
{A.B.C.D} {A.B.C.D}	Specifies the ID for the transit area that the virtual link traverses and the router ID of the virtual neighbor. Do not use 0.0.0.0 for the transit area.
dead-interval <1-65535>	Specifies the number of seconds after which the neighbor declares the router down if it does not receive hello packets. Configure this value as a multiple of the hello interval. You must configure the same value on the virtual neighbor. The default is 60 seconds.
hello-interval <1-65535>	Specifies the number of seconds between hello packets that the router sends on this interface. Configure the same value on the virtual neighbor. The default is 10 seconds.
retransmit-interval <1-1800>	Specifies the number of seconds between link-state advertisement retransmissions for adjacencies that

Table continues...

Variable	Value
	belong to this interface. This value also applies to the retransmissions of database description and link-state request packets. The default is 5 seconds.
transit-delay <1-1800>	Specifies the estimated number of seconds to transmit a link-state update packet over this interface. The default is 1 second.

Configuring IPsec for the OSPF virtual link

Use the following procedure to configure and enable IPsec for the OSPF virtual link.

IPsec is disabled by default.

Before you begin

- Configure the OSPF virtual link.
- Create the IPsec security association. For more information on configuration of IPsec security associations and IPsec policies, and how to enable policies on an interface, see *Configuring Security*.

About this task

Until you enable IPsec on both sides of the virtual links, the links cannot exchange OSPFv3 control messages, and the system drops OSPFv3 exchange packets.

You must disable IPsec before you can perform virtual link policy configuration changes.

For configuration examples of IPsec used with OSPFv3 virtual link, see *Configuring Security*.

Procedure

1. Enter OSPF Router Configuration mode:

```
enable
configure terminal
router ospf
```
2. Create the IPsec policy under the OSPF virtual link:

```
ipv6 area virtual-link {A.B.C.D} {A.B.C.D} ipsec
```
3. Configure the action of the IPsec policy under the OSPF virtual link:

```
ipv6 area virtual-link {A.B.C.D} {A.B.C.D} ipsec action <drop|
permit>
```
4. Configure the direction of the IPsec policy under the OSPF virtual link:

```
ipv6 area virtual-link {A.B.C.D} {A.B.C.D} ipsec direction <both|in|
out>
```
5. Link the security association to the OSPF virtual link:

```
ipv6 area virtual-link {A.B.C.D} {A.B.C.D} ipsec security-
association WORD<0-32>
```

6. Enable the IPsec policy created under the OSPF virtual link:

```
ipv6 area virtual-link {A.B.C.D} {A.B.C.D} ipsec enable
```

Example

```
Switch:1>enable
Switch:1#configure terminal
Switch:1#(config)router ospf
Switch:1(config-ospf)#ipv6 area virtual-link 1.1.1.1 2.2.2.2 ipsec
Switch:1(config-ospf)#ipv6 area virtual-link 1.1.1.1 2.2.2.2 ipsec action permit
Switch:1(config-ospf)#ipv6 area virtual-link 1.1.1.1 2.2.2.2 ipsec direction both
Switch:1(config-ospf)#ipv6 area virtual-link 1.1.1.1 2.2.2.2 ipsec security-association
test1
Switch:1(config-ospf)#ipv6 area virtual-link 1.1.1.1 2.2.2.2 ipsec enable
```

Variable definitions

Use the data in the following table to use the **ipv6 area virtual link {A.B.C.D} {A.B.C.D} ipsec** command.

Variable	Value
{A.B.C.D}{A.B.C.D}	The first IP address specifies the area IP address, and the second IP address specifies the virtual-link IP address.
action <drop permit>	Configures the action of the IPsec policy under the OSPF virtual tunnel to one of the following: <ul style="list-style-type: none"> • drop—Drops the IP packets. • permit—Permits the IP packets. The default is permit.
direction <both in out>	Specifies the direction you want to protect with IPsec: <ul style="list-style-type: none"> • in—Specifies ingress traffic. • out—Specifies egress traffic. • both—Specifies both ingress and egress traffic. The default is both.
enable	Enables the IPsec policy under the OSPF virtual link.
security-association WORD<0-32>	Links the security association to the OSPF virtual link.

Configuring OSPF default metrics

About this task

Use the following procedure to configure global OSPF default metrics.

Procedure

1. Enter OSPF Router Configuration mode:

```
enable
configure terminal
router ospf
```

2. Configure OSPF default-cost:

```
ipv6 default-cost {ethernet|fast-ethernet|forty-gig-ethernet|
hundred-gig-ethernet|gig-ethernet|ten-gig-ethernet|twentyfive-gig-
ethernet|vlan} <1-65535>
```

*** Note:**

Different hardware platforms support different port speeds. For more information, see your hardware documentation.

Example

Configure IPv6 default cost metric for Ethernet to 100, for fast Ethernet to 20, for gig-ethernet, twentyfive-gig-ethernet, forty-gig-Ethernet, and hundred-gig-ethernet to 2, and VLAN to 1.

```
Switch:1>enable
Switch:1#configure terminal
Switch:1(config)#router ospf
Switch:1(config-ospf)#ipv6 default-cost ethernet 100
Switch:1(config-ospf)#ipv6 default-cost fast-ethernet 20
Switch:1(config-ospf)#ipv6 default-cost gig-ethernet 2
Switch:1(config-ospf)#ipv6 default-cost ten-gig-ethernet 2
Switch:1(config-ospf)#ipv6 default-cost Forty-gig-ethernet 2
Switch:1(config-ospf)#ipv6 default-cost twentyfive-gig-ethernet 2
Switch:1(config-ospf)#ipv6 default-cost hundred-gig-ethernet 2
Switch:1(config-ospf)#ipv6 default-cost vlan 1
```

Variable definitions

Use the data in the following table to use the `ipv6 default-cost` command.

*** Note:**

Different hardware platforms support different port speeds. For more information, see your hardware documentation.

Variable	Value
ethernet <1-65535>	Configures the IPv6 OSPF default metrics. The lower the metric, the more likely that OSPF chooses the link to route an OSPF packet. ethernet is for 10 Mb/s Ethernet (default is 100).
fast-ethernet <1-65535>	Configures the IPv6 OSPF default metrics. The lower the metric, the more likely that OSPF chooses the link to route an OSPF packet.

Table continues...

Variable	Value
	fast-ethernet is for 100 Mb/s Fast-Ethernet (default is 100).
forty-gig-ethernet <1-65535>	Configures the IPv6 OSPF default metrics. The lower the metric, the more likely that OSPF chooses the link to route an OSPF packet. forty-gig-ethernet is for 10 Mb/s Forty-Gigabit-Ethernet (default is 1).
gigabit-ethernet <1-65535>	Configures the IPv6 OSPF default metrics. The lower the metric, the more likely that OSPF chooses the link to route an OSPF packet. gigabit-ethernet is for 10 Mb/s Gigabit-Ethernet (default is 1).
hundred-gig-ethernet <1-65535>	Configures the IPv6 OSPF default metrics. The lower the metric, the more likely that OSPF chooses the link to route an OSPF packet. hundred-gig-ethernet is for 100 Gigabit Ethernet (default is 1).
ten-gig-ethernet <1-65535>	Configures the IPv6 OSPF default metrics. The lower the metric, the more likely that OSPF chooses the link to route an OSPF packet. ten-gig-ethernet is for 10 Mb/s Ten-Gigabit-Ethernet (default is 1).
twentyfive-gig-ethernet <1-65535>	Configures the IPv6 OSPF default metrics. The lower the metric, the more likely that OSPF chooses the link to route an OSPF packet. On a channelized 100 Gbps port, the default-cost for each 25 Gbps channel is 1.
vlan <1-65535>	Configures the IPv6 OSPF default metrics. The lower the metric, the more likely that OSPF chooses the link to route an OSPF packet. vlan is for Vlan interfaces (default is 10).

Configuring OSPF on a port or VLAN

Configure the OSPF protocol on IPv6 interface to support dynamic routing on the interface.

Before you begin

- The IPv6 interface must exist.

Procedure

1. Enter Interface Configuration mode:

```
enable
```

```
configure terminal
interface GigabitEthernet {slot/port[/sub-port] [-slot/port[/sub-
port]] [, ...]} or interface vlan <1-4059>
```

*** Note:**

If your platform supports channelization and the port is channelized, you must also specify the sub-port in the format slot/port/sub-port.

2. Create an OSPF area on the interface:

```
ipv6 ospf area {A.B.C.D}
```

3. Enable OSPFv3 on the interface:

```
ipv6 ospf enable
```

The default is disabled.

4. Configure optional parameters to meet your requirements:

- a. Configure the interface metric:

```
ipv6 ospf cost <0-65535>
```

The default for a brouter port or VLAN is 1.

*** Note:**

If you do not specify a cost for the interface, the switch dynamically updates the interface cost with the configured global OSPF default cost. The global OSPF default cost depends on the speed of the interface.

- b. Configure the router dead interval:

```
ipv6 ospf dead-interval <1-65535>
```

The default is 40 seconds.

- c. Configure the hello interval:

```
ipv6 ospf hello-interval <1-65535>
```

The default is 10 seconds.

- d. Configure the link LSA suppression:

```
ipv6 ospf link-lsa-suppression
```

*** Note:**

Before configuring Link LSA suppression for OSPF, configure Link LSA suppression for OSPF area for point to point (p2p) or point to multipoint interfaces (p2mp), otherwise it defaults to a broadcast interface type where you cannot use Link LSA suppression.

- e. Configure the poll interval:

```
ipv6 ospf poll-interval <0-65535>
```

The default is 120 seconds.

- f. Configure the interface priority:

```
ipv6 ospf priority <0-255>
```

The default is 1.

- g. Configure the retransmit interval:

```
ipv6 ospf retransmit-interval <1-1800>
```

The default is 5 seconds.

- h. Configure the transit delay:

```
ipv6 ospf transit-delay <1-1800>
```

The default is 1 second.

Example

Create an OSPF area on the interface:

```
Switch:1(config-if)#ipv6 ospf area 0.0.0.0
```

Enable OSPFv3 on the interface:

```
Switch:1(config-if)#ipv6 ospf enable
```

Variable definitions

Use the data in the following table to use the `ipv6 ospf` command.

Variable	Value
area {A.B.C.D}	Specifies the area ID to which the IPv6 interface connects. Use 0.0.0.0 for the OSPFv3 backbone.
cost <0-65535>	Specifies the cost for the interface. The default for a brouter port or VLAN is 1.
dead-interval <1-65535>	Specifies the number of seconds after which the neighbor declares the router down, if it does not receive hello packets. Configure this value as a multiple of the hello interval. You must configure the same value on the virtual neighbor. The default is 40 seconds.
enable	Specifies the administrative status for the OSPFv3 interface. If you enable the status, it is advertised as an internal route to some areas. If you disable the status, the interface is external to OSPFv3. The default is disabled.

Table continues...

Variable	Value
hello-interval <1-65535>	Specifies the number of seconds between hello packets that the router sends on this interface. Configure the same value on the virtual neighbor. The default is 10 seconds.
link-lsa-suppression	Configures link LSA suppression on the specified port or VLAN. It is only used for point to point or point to multipoint interfaces. By default, it is disabled.
poll-interval <0-65535>	Specifies the number of seconds between hello packets sent to an inactive NBMA neighbor. The default is 120.
priority <0-255>	Specifies the priority of this interface. Multiaccess networks use the priority in the designated router election. A higher priority value increases the chance the router becomes the designated router. A value of zero (0) indicates the router cannot become the designated router for the network. If more than one router uses the same priority value, the router ID determines the designated router. The default is 1.
retransmit-interval <1-1800>	Specifies the number of seconds between link-state advertisement retransmissions for adjacencies that belong to this interface. This value also applies to the retransmissions of database description and link-state request packets. The default is 5 seconds.
transit-delay <1-1800>	Specifies the estimated number of seconds to transmit a link-state update packet over this interface. The default is 1 second.

Use the data in the following table to use the **interface** command.

Variable	Value
<1-4059>	Specifies the VLAN ID in the range of 1 to 4059. By default, VLAN IDs 1 to 4059 are configurable and the system reserves VLAN IDs 4060 to 4094 for internal use. On switches that support the vrf-scaling and spbm-config-mode boot configuration flags, if you enable these flags, the system also reserves VLAN IDs 3500 to 3998. VLAN ID 1 is the default VLAN and you cannot create or delete VLAN ID 1.
{slot/port[/sub-port][/-slot/port[/sub-port]][,...]}	Identifies the slot and port in one of the following formats: a single slot and port (slot/port), a range of

Table continues...

Variable	Value
	slots and ports (slot/port-slot/port), or a series of slots and ports (slot/port,slot/port,slot/port). If your platform supports channelization and the port is channelized, you must also specify the sub-port in the format slot/port/sub-port.

Configuring OSPF on a tunnel

Configure the OSPF protocol on IPv6 interface to support dynamic routing on the interface.

Before you begin

- The IPv6 interface must exist.

Procedure

1. Enter OSPF Router Configuration mode:

```
enable
configure terminal
router ospf
```

2. Create an OSPF area on the interface:

```
ipv6 tunnel <1-2000> area {A.B.C.D}
```

3. Enable OSPFv3 on the interface:

```
ipv6 tunnel <1-2000> enable
```

4. Configure optional parameters to meet your requirements:

- a. Configure the router dead interval:

```
ipv6 tunnel <1-2000> dead-interval <1-65535>
```

The default is 40 seconds.

- b. Configure the hello interval:

```
ipv6 tunnel <1-2000> hello-interval <1-65535>
```

The default is 10 seconds.

- c. Configure the interface metric:

```
ipv6 tunnel <1-2000> metric <0-65535>
```

- d. Configure the poll interval:

```
ipv6 tunnel <1-2000> poll-interval <0-65535>
```

The default is 120 seconds.

- e. Configure the interface priority:

```
ipv6 tunnel <1-2000> priority <0-255>
```

The default is 1.

- f. Configure the retransmit interval:

```
ipv6 tunnel <1-2000> retransmit-interval <1-1800>
```

The default is 5 seconds.

- g. Configure the transit delay:

```
ipv6 tunnel <1-2000> transit-delay <1-1800>
```

The default is 1 second.

Example

Create an OSPF area on the interface:

```
Switch:1(config-if)#ipv6 tunnel 4 area 0.0.0.0
```

Enable OSPFv3 on the interface:

```
Switch:1(config-if)#ipv6 tunnel 4 enable
```

Variable definitions

Use the data in the following table to use the `ipv6 tunnel` command.

Variable	Value
<1-2000>	Specifies the tunnel ID.
area {A.B.C.D}	Specifies the area ID to which the IPv6 interface connects. Use 0.0.0.0 for the OSPFv3 backbone.
dead-interval <1-65535>	Specifies the number of seconds after which the neighbor declares the router down if it does not receive hello packets. Configure this value as a multiple of the hello interval. + Tip: You must configure the same value on the virtual neighbor. The default is 40 seconds.
enable	Specifies the administrative status for the OSPFv3 interface. If you enable the status, it is advertised as an internal route to some areas. If you disable the status, the interface is external to OSPFv3.

Table continues...

Variable	Value
	The default is enabled.
hello-interval <1-65535>	<p>Specifies the number of seconds between hello packets that the router sends on this interface.</p> <p>+ Tip: You must configure the same value on the virtual neighbor.</p> <p>The default is 10 seconds.</p>
metric <0-65535>	<p>Specifies the cost for the interface.</p> <p>The default for a tunnel is 100.</p>
poll-interval <0-65535>	<p>Specifies the number of seconds between hello packets sent to an inactive NBMA neighbor.</p> <p>The default is 120.</p>
priority <0-255>	<p>Specifies the priority of this interface.</p> <p>Multiaccess networks use the priority in the designated router election.</p> <p>A higher priority value increases the likelihood that the router becomes the designated router.</p> <p>A value of zero (0) indicates the router cannot become the designated router for the network.</p> <p>If more than one router uses the same priority value, the system uses the router ID to determine which router becomes the designated router.</p> <p>The default is 1.</p>
retransmit-interval <1-1800>	<p>Specifies the number of seconds between link-state advertisement retransmissions for adjacencies that belong to this interface.</p> <p>The retransmit-interval value also applies to the retransmissions of database description and link-state request packets.</p> <p>The default is 5 seconds.</p>
transit-delay <1-1800>	<p>Specifies the estimated number of seconds required to transmit a link-state update packet over this interface.</p> <p>The default is 1 second.</p>

Viewing OSPFv3 information

View information about OSPF to view the current configuration.

Procedure

1. Enter Privileged EXEC mode:

```
enable
```

2. View OSPF global information:

```
show ipv6 ospf
```

3. View OSPF areas:

```
show ipv6 ospf area
```

4. View OSPF interface information

```
show ipv6 ospf interface [gigabitEthernet {slot/port[sub-port]}|vlan
<1-4059>]
```

5. View OSPF interface timers:

```
show ipv6 ospf int-timers
```

6. View the link-state database (LSDB) table:

```
show ipv6 ospf lsdb [adv-rtr <A.B.C.D>] [area <A.B.C.D>] [interface
gigabitEthernet {slot/port[sub-port]}|vlan <1-4059> ] [lsa-type
<1-8>] [lsid <0-4294967295>] [scope <1-3>] [tunnel <1-2000>]
[detail]
```

7. View OSPF neighbors to see routers with interfaces to a common network, including neighbors on the virtual link to the OSPF backbone:

```
show ipv6 ospf neighbor
```

Example

```
Switch:1#show ipv6 ospf
```

```
=====
                        OSPFv3 Global Information
=====
router-id                : 170.76.84.0
admin-state              : DISABLE
version                  : 3
area-bdr-rtr-state      : FALSE
as-bdr-rtr-state        : FALSE
helper-mode              : ENABLED
as-scope-lsa-count      : 0
lsa-checksum             : 0
originate-new-lsas     : 0
rx-new-lsas              : 0
ext-lsa-count            : 0

  default-metric :
    ethernet      - 100
    fast-ethernet - 10
    gig-ethernet  - 1
    ten-gig-ethernet - 1
    forty-gig-ethernet - 1
```



```
vlan - 10
```

```
Switch:1>show ipv6 ospf area
```

```
=====
                        OSPF Area
=====
AREA_ID          STUB_AREA  NSSA   IMPORT_SUM  TRANS_ROLE  TRANS_STATE
-----
0.0.0.0          false     false true        always      disabled
STUB_METRIC STUB_METRIC_TYPE SPF_RUNS  BDR_RTR_CNT ASBDR_RTR_CNT LSA_CNT  LSACK_SUM
-----
10              ospfv3Metric    0         0           0           0         0
=====
```

```
Switch:1#show ipv6 ospf interface
```

```
Total ospf areas: 1
```

```
Total ospf interfaces: 2
```

```
=====
                        OSPF Interface
=====
IFINDX(VID/BRT) AREAID          ADM IFSTATE  METRIC PRI DR/BDR          IFTYPE
-----
331  (5/12 ) 0.0.0.0          ena DOWN     1     1  0.0.0.0          PT-PT
                                0.0.0.0          lnklsaSup
2078 (30 ) 0.0.0.0          ena DR      1     1  197.146.128.0   BROADCAST
                                0.0.0.0
=====
```

```
2 out of 2 Total Num of ospf interfaces displayed
```

```
Total ospf virtual interfaces: 0
```

```
=====
                        OSPF Virtual Interface
=====
```

```
=====
AREAID          NBRIPADDR          STATE
-----
```

```
0 out of 0 Total Num of ospf virtual interfaces displayed
```

```
Switch:1#show ipv6 ospf int-timers
```

```
=====
                        OSPF Interface Timers
=====
IFINDX(VID/BRT) AREAID          TRANSIT  RETRANS  HELLO  DEAD  POLL
DELAY      INTERVAL  INTERVAL INTERVAL INTERVAL
-----
2059 (11 ) 0.0.0.0          1        5       10     40    120
2060 (12 ) 0.0.0.0          1        5       10     40    120
=====
```

```
=====
                        OSPF Virtual Interface Timers
=====
```

```
=====
TRANSIT  RETRANS  HELLO  DEAD
=====
```

```

AREAID          NBRIPADDR      DELAY      INTERVAL INTERVAL INTERVAL
-----
Switch:1#show ipv6 ospf neighbor
=====
                        OSPF Neighbor
=====
IFINDEX(VID/BRT) NBRROUTERID      NBRIPADDR          STATE      TTL
-----
331      (10/19) 97.146.128.0    fe80:0:0:0:2ef4:c5ff:fe92:8a00  Restart   120
1 out of 1 Total Num of Neighbor Entries displayed.
=====
                        OSPF Virtual Neighbor
=====
NBRAREAID      NBRROUTERID      VIRTINTFID NBRIPV6ADDR
STATE
-----
0 out of 0 Total Num of Virtual Neighbor Entries displayed.
=====
                        OSPF NBMA Neighbor
=====
INTERFACE NBRROUTERID      NBRIPADDR          STATE
-----
0 out of 0 Total Num of NBMA Neighbor Entries displayed.
=====
                        OSPF NBMA Neighbor
=====
INTERFACE NBRROUTERID      NBRIPADDR          STATE
-----
0 out of 0 Total Num of NBMA Neighbor Entries displayed.

```

Variable definitions

Use the data in the following table to use the `show ipv6 ospf lsdb` commands.

Variable	Value
adv-rtr <A.B.C.D>	Shows information for the specified advertising router.
area <A.B.C.D>	Shows information for the specified area.
detail	Shows information beyond the basic information.
{slot/port[/sub-port]}	Identifies a single slot and port. If your platform supports channelization and the port is channelized, you must also specify the sub-port in the format slot/port/sub-port.
lsa-type <1-8>	Shows information for the specified LSA type.
lsid <0-4294967295>	Shows information for the specified link-state ID.

Table continues...

Variable	Value
scope <1-3>	Shows information for the specified scope: <ol style="list-style-type: none"> 1. link-scope LSAs-View the link-scope LSDB to view the LSAs that are not flooded beyond the local link. 2. area-scope LSAs-View the area-scope LSDB to see the LSAs that are flooded in a single OSPF area. Area scope is used in router LSAs, network LSAs, Inter-Area-Prefix-LSAs, Inter-Area-Router LSAs, and Intra-Area-Prefix-LSAs. 3. AS-scope LSAs-View the AS-scope LSDB to see the LSAs that are flooded through the routing domain. The AS scope is used for ASexternal- LSAs.
tunnel <1-2000>	Specifies the ID number of the tunnel.
vlan <1-4059>	Specifies the VLAN ID in the range of 1 to 4059. By default, VLAN IDs 1 to 4059 are configurable and the system reserves VLAN IDs 4060 to 4094 for internal use. On switches that support the vrf-scaling and spbm-config-mode boot configuration flags, if you enable these flags, the system also reserves VLAN IDs 3500 to 3998. VLAN ID 1 is the default VLAN and you cannot create or delete VLAN ID 1.

Viewing OSPFv3 default cost information

About this task

Use the following procedure to View the OSPF default cost information, to ensure accuracy.

Procedure

1. Enter Privileged EXEC mode:

```
enable
```
2. View the OSPF cost information:

```
show ipv6 ospf default-cost
```

Example

```
Switch:1#show ipv6 ospf default-cost
```

```
=====
                        IPv6 OSPF Default Metric
=====
 10MbpsPortDefaultMetric: 100
 100MbpsPortDefaultMetric: 10
 1000MbpsPortDefaultMetric: 1
10000MbpsPortDefaultMetric: 1
 25000MbpsPortDefaultMetric: 1
 40000MbpsPortDefaultMetric: 1
```

```
100000MbpsPortDefaultMetric: 1
    VlanDefaultMetric: 10
```

Adding an NBMA neighbor

Add an NBMA neighbor for each interface that is eligible to become the DR.

An NBMA interface with a positive nonzero router priority is eligible to become the DR for the NBMA network and is configured with the identification of all attached routers, IPv6 addresses, and router priorities.

Before you begin

- Identify the following information:
 - specific interfaces to include in the NBMA network
 - the IPv6 address for each interface
 - the router priority for each interface
 - the hello interval for the network
 - the router dead interval for the network
 - the poll interval for the network

About this task

In contrast to a broadcast network where switches multicast (send to AllSPFRouters and AllDRouters) certain OSPF protocol packets, switches replicate and send NBMA packets to each neighboring router as unicast. NBMA networks drop all OSPF packets with destination addresses AllSPFRouters and AllDRouters. Because the NBMA network does not broadcast, you must manually configure a list of neighbors and priorities for all routers in the network that can become the DR. Potential DRs use a positive nonzero router priority.

Procedure

1. Enter Interface Configuration mode:

```
enable
configure terminal
interface GigabitEthernet {slot/port[/sub-port] [-slot/port[/sub-
port]][, ...]} or interface vlan <1-4059>
```

*** Note:**

If your platform supports channelization and the port is channelized, you must also specify the sub-port in the format slot/port/sub-port.

2. Create a new NBMA neighbor:

```
ipv6 ospf nbma-nbr WORD<0-43> <0-255>
```

3. Change the priority of an existing NBMA neighbor:

```
ipv6 ospf nbma-nbr WORD<0-43> priority <0-255>
```

Example

Create an NBMA neighbor that will not become the DR:

```
Switch:1(config-if)#ipv6 ospf nbma-nbr fe80:0:0:0:8217:7dff:fe76:8a03 0
```

Variable definitions

Use the data in the following table to use the `ipv6 ospf nbma-nbr` command.

Variable	Value
priority <0-255>	Specifies the priority to use for this neighbor in the designated router election process. A value of 0 indicates the neighbor cannot become the designated router. The higher the priority value, the higher chance the switch will win the election process. The default is 1.
WORD<0-43>	Specifies the IPv6 address of the neighbor.

Configuring link LSA suppression**About this task**

Use the following procedure to configure link LSA suppression on a port or a VLAN, to decrease unnecessary link LSA generation and flooding for non-broadcast and non-NBMA interface.

Procedure

1. Enter Interface Configuration mode:

```
enable
```

```
configure terminal
```

```
interface GigabitEthernet {slot/port[/sub-port] [-slot/port[/sub-port]] [, ...]} or interface vlan <1-4059>
```

 **Note:**

If your platform supports channelization and the port is channelized, you must also specify the sub-port in the format slot/port/sub-port.

2. Enter the following command:

```
ipv6 ospf area {A.B.C.D} network {p2p | p2mp} link-lsa-suppression
```

Example**Variable definitions**

Following table describes the variables to the `ipv6 ospf area {A.B.C.D} network p2p link-lsa-suppression` command.

Variable	Description
<i>area {A.B.C.D}</i>	Create an IPv6 OSPF area.
<i>network</i>	Sets the type of interface.
<i>[eth NBMA p2mp p2p passive]</i>	Specifies the type of interface.
<i>link-lsa-suppression</i>	Enables link LSA suppression.

Enabling OSPF route redistribution

Enable redistribution to announce routes, of a certain source protocol type, into the OSPFv3 domain.

You can redistribute directly connected routes, IS-IS routes, and static routes into OSPFv3.

About this task

If you do not configure a redistribution entry, the switch generates external LSAs for non-OSPF routes.

Procedure

1. Enter OSPF Router Configuration mode:

```
enable
configure terminal
router ospf
```

2. Enable IPv6 router redistribution:

```
ipv6 redistribute <bgp|direct|isis|rip|static> enable
```

Example

Announce IPv6 static routes into the OSPFv3 domain:

```
Switch:1(config-ospf)#ipv6 redistribute static enable
```

Variable definitions

Use the data in the following table to use the `ipv6 redistribute` command.

Variable	Value
<bgp direct isis rip static>	Shows the source protocol from which to receive routes to insert into the OSPFv3 domain. By default, no routes are announced. Route redistribution is disabled.

Viewing the status of OSPFv3 redistribution

View the status of OSPFv3 route redistribution to verify the current configuration. You can redistribute directly connected routes and IPv6 static routes into OSPFv3.

Procedure

1. Enter Privileged EXEC mode:
enable
2. View the current configuration:
show ipv6 ospf redistribute

Example

```
Switch:1#show ipv6 ospf redistribute
```

```
=====
                        OSPF Redistribute List
=====
direct                   : disabled
static                   : disabled
bgp                      : disabled
isis                    : disabled
rip                     : disabled
=====
```

Disabling Helper mode for OSPFv3

About this task

By default, OSPF Helper mode is enabled when OSPF is configured. You can disable helper mode by the following command and re-enable it again by using “no” or “default” commands.

Procedure

1. Enter OSPF Router Configuration mode:
enable
configure terminal
router ospf
2. Enter the following command to disable Helper mode:
ipv6 helper-mode-disable
3. Enter the following command to enable Helper mode:
no ipv6 helper-mode-disable
Or

```
default ipv6 helper-mode disable
```

Example

Disabling Helper mode:

```
Switch:1>enable
Switch:1#configure terminal
Switch:1(config)#router ospf
Switch:1(config-ospf)#ipv6 helper-mode-disable
```

Enabling Helper mode:

```
Switch:1>enable
Switch:1#configure terminal
Switch:1(config)#router ospf
Switch:1(config-ospf)#no ipv6 helper-mode-disable
```

OSPFv3 configuration using EDM

Configuring OSPF globally

Configure OSPFv3 globally to enable it on the system and to configure the router ID.

Procedure

1. In the navigation tree, expand the following folders: **Configuration > IPv6**.
2. Click **OSPF**.
3. Click the **Globals** tab.
4. Type the router ID, in the format of an IPv4 address.
5. Select **enabled**.
6. Optionally, select **ASBdrRtrStatus** to make the router an AS boundary router.

Enable the ASBR if the router attaches at the edge of the OSPF network, and has one or more interfaces that run an interdomain routing protocol. The default is disabled.

7. Click **Apply**.

Globals field descriptions

Use the data in the following table to use the Globals tab.

Note:

Different hardware platforms support different port speeds. For more information, see your hardware documentation.

Name	Description
RouterId	Specifies a 32-bit integer that identifies the router in the autonomous system. This value must be unique. The default value will be one of the IPv4 interface addresses.
AdminStat	Enables or disables OSPFv3 on the router. If you disable OSPFv3 globally, you disable it on all interfaces. The default is disabled.
VersionNumber	Shows the OSPF version number, which for IPv6 is version 3.
AreaBdrRtrStatus	Shows if the router is an area border router.
ASBdrRtrStatus	Configures the router as an autonomous system boundary router. The default is disabled (clear).
HelperModeDisable	Disables Graceful Restart Helper Mode feature.
AsScopeLsaCount	Shows the number of AS-external link-state advertisements in the LSDB.
AsScopeLsaChecksumSum	Shows the sum of the checksums for the link-scope LSAs in the LSDB. Use the sum to determine if a change in the LSDB occurs, and to compare the LSDBs of the two routers.
OriginateNewLsas	Shows the number of new link-state advertisements. The number increases each time the router originates a new LSA.
RxNewLsas	Shows the number of new link-state advertisements received. This number does not include new instances of self-originated link-state advertisements.
ExtLsaCount	Shows the number of external (LS type 0x4005) LSAs in the LSDB.
10MbpsPortDefaultMetric	Indicates the default cost applied to 10 Mbps interfaces (ports). The default is 100.
100MbpsPortDefaultMetric	Indicates the default cost applied to 100 Mbps interfaces (ports). The default is 10.
1000MbpsPortDefaultMetric	Indicates the default cost applied to 1 Gbps interfaces (ports). The default is 1.
10000MbpsPortDefaultMetric	Indicates the default cost applied to 10 Gbps interfaces (ports). The default is 1.
25000MbpsPortDefaultMetric	Indicates the default cost applied to 25 Gbps interfaces (channelized 100 Gbps ports). The default is 1.
40000MbpsPortDefaultMetric	Indicates the default cost applied to 40 Gbps interfaces (ports). The default is 1.
100000MbpsPortDefaultMetric	Indicates the default cost applied to 100 Gbps interfaces (ports). The default is 1.

Table continues...

Name	Description
vlanDefaultMetric	Indicates the default cost applied to VLAN interfaces. The default is 10.

Creating an OSPF area

Create an area to subdivide the autonomous system (AS) into areas that group contiguous networks, routers that connect to these networks, and attached hosts. Subdividing the AS into areas significantly reduces the amount of routing protocol traffic compared to treating the entire AS like a single link-state domain.

About this task

A stub area does not receive advertisements for external routes, which reduces the size of the link-state database (LSDB). A stub area uses only one area border router (ABR). Any packets destined for outside the area are routed to the area border exit point, examined by the ABR, and forwarded to a destination.

A not so stubby area (NSSA) prevents the flooding of AS-External link-state advertisements into the area by replacing them with a default route. NSSAs also import small stub (non- OSPF) routing domains into OSPF.

Procedure

1. In the navigation tree, expand the following folders: **Configuration > IPv6**.
2. Click **OSPF**.
3. Click the **Areas** tab.
4. Click **Insert**.
5. Type the area ID.
6. Click **Insert**.

Areas field descriptions

Use the data in the following table to use the **Areas** tab.

Name	Description
Id	Specifies a 32-bit integer to uniquely identify an area. Use 0.0.0.0 for the OSPFv3 backbone.
ImportasExtern	Indicates the support for importing AS-external LSAs:: <ul style="list-style-type: none"> • importExternal—normal area • importNoExternal—stub area • importNssa—not-so-stubby-area

Table continues...

Name	Description
	AS-scope LSAs are not imported into stub areas or NSSAs. NSSAs import AS-External data at Type 7 LSAs, which use area scope. importExternal is the default.
SpfRuns	Shows the number of times the intra-area route table was calculated using the LSDB of this area.
BdrRtrCount	Shows the number of reachable ABRs in this area. The value starts at zero (0). The system calculates this value in each SPF run.
AsBdrRtrCount	Shows the number of reachable ASBRs in this area. The value starts at zero (0). The system calculates this value in each SPF run.
ScopeLsaCount	Shows the number of area-scope LSAs in the LSDB for this area.
ScopeLsaChecksumSum	Shows the sum of the checksums for the area-scope LSAs in the LSDB. Use the sum to determine if a change in the LSDB occurs, and to compare the LSDBs of the two routers.
Summary	Controls the import of inter-area LSAs into a stub area. If the value is noAreaSummary , the router does not originate nor propagate inter-area LSAs into the stub area. If the value is sendAreaSummary (the default), the router both summarizes and propagates inter-area LSAs.
StubMetric	Configures the metric value advertised for the default route to stub and NSSA areas.
NssaTranslatorRole	Indicates if the NSSA border router can perform NSSA translation of Type 7 LSAs to Type 6 LSAs. The possible values are always or candidate. The default is candidate.
NssaTranslatorState	Indicates if and how an NSSA border router translates Type 7 LSAs to Type 5 LSAs. The possible values are <ul style="list-style-type: none"> • enabled—The border router always translates the LSAs. • elected—A candidate border router translates the LSAs. • disabled—A candidate border router does not translate the LSAs.
StubMetricType	Specifies the type of metric advertised as a default route. The possible values are: <ul style="list-style-type: none"> • ospfv3Metric—OSPF metric

Table continues...

Name	Description
	<ul style="list-style-type: none"> • comparableCost—external Type 1 • nonComparable—external Type 2 <p>The default is ospfv3Metric.</p>

Creating OSPF area ranges

Create an area address range on the OSPF router to reduce the number of area border router (ABR) advertisements into other OSPF areas. An area address range is an implied contiguous range of area network addresses for which the ABR advertises a single summary route.

Before you begin

- You must create the OSPF area.

About this task

If you create two ranges, and one range is a subset of the other, the router uses the most specific match.

Procedure

1. In the navigation tree, expand the following folders: **Configuration > IPv6**.
2. Click **OSPF**.
3. Click the **Area Aggregate** tab.
4. Click **Insert**.
5. Select the area ID.
6. Select the type of area.
 - **interAreaPrefixLsa** generates an aggregated summary.
 - **nssaExternalLsa** generates an NSSA link summary.
7. Type the prefix for the IPv6 area address.
8. Type the number of bits from the IPv6 address that you want to advertise.
9. Click **Insert**.

Area Aggregate field descriptions

Use the data in the following table to use the **Area Aggregate** tab.

Name	Description
AreaID	Specifies the area in which the address aggregate exists. Use dotted decimal notation to specify the area name.

Table continues...

Name	Description
AreaLsdbType	Specifies the area LSDB type to which the address aggregate applies. interAreaPrefixLsa generates an aggregated summary. nssaExternalLsa generates an NSSA link summary.
Prefix	Specifies the IPv6 prefix. The prefix and prefix length define the range.
PrefixLength	Specifies the length of the prefix, in bits. The prefix cannot be shorter than 3 bits. The prefix and prefix length define the range.
Effect	Specifies the advertisement mode for prefixes in the range. advertiseMatching advertises the aggregate summary LSA with the same link-state ID. doNotAdvertiseMatching does not advertise networks that fall within the range.
AdvertiseMetric	Specifies a cost value to advertise for the OSPF area range. This value applies to summary LSAs (Type 3). If the value is 0, OSPF uses the cost to the farthest point in the network that is summarized.

Creating an OSPF virtual link

Create a virtual link if the switch does not connect directly to the backbone. The switch can create automatic virtual links or you can perform this procedure to create virtual links manually. Manual virtual links conserve resources and provide specific control over virtual link placement in your OSPF configuration.

Before you begin

- The router must be an ABR to create a virtual router interface.

About this task

Virtual linking is similar to backup redundancy. The switch creates a virtual link for vital traffic paths in your OSPF configuration if traffic is interrupted, such as when an interface cable that provides a connection to the backbone (either directly or indirectly) is disconnected from the switch. Automatic virtual linking ensures that a link is created by using another switch.

OSPF routes cannot be learned through an ABR unless it connects to the backbone directly or through a virtual link.

Procedure

1. In the navigation tree, expand the following folders: **Configuration > IPv6**.
2. Click **OSPF**.
3. Click the **Virtual If** tab.
4. Click **Insert**.

- Specify the ID for the transit area.

The transit area is the common area between two ABRs.

- Specify the router ID for the virtual neighbor.

The neighbor ID is the IP router ID of the ABR through which the other ABR must route traffic destined for the backbone.

- Click **Insert**.

- Click **Refresh** to verify that the virtual link is active.

If the state is point-to-point, the virtual link is active. If the state is down, the virtual link is configured incorrectly.

Virtual If field descriptions

Use the data in the following table to use the **Virtual If** tab.

Name	Description
AreaId	Specifies the ID for the transit area that the virtual link traverses. Do not use 0.0.0.0.
Neighbor	Specifies the router ID of the virtual neighbor.
TransitDelay	Specifies the estimated number of seconds to transmit a link-state update packet over this interface. The default is 1 second.
RetransInterval	Specifies the number of seconds between link-state advertisement retransmissions for adjacencies that belong to this interface. This value also applies to the retransmissions of database description and link-state request packets. The default is 5 seconds.
HelloInterval	Specifies the number of seconds between hello packets that the router sends on this interface. Configure the same value on the virtual neighbor. The default is 10 seconds.
RtrDeadInterval	Specifies the number of seconds after which the neighbor declares the router down if it does not receive hello packets. Configure this value as a multiple of the hello interval. You must configure the same value on the virtual neighbor. The default is 60 seconds.
State	Shows the state of the virtual interface: either down or pointToPoint.
Events	Shows the number of state changes or error events on the virtual link.

Table continues...

Name	Description
LinkScopeLsaCount	Shows the number of link-scope LSAs in the LSDB for the virtual link.
LinkLsaCksumSum	Shows the sum of the checksums for the link-scope LSAs in the LSDB. Use the sum to determine if a change in the LSDB occurs, and to compare the LSDBs of the two routers.

Configuring IPsec for the OSPF virtual link

Use the following procedure to configure and enable IPsec for the OSPF virtual link.

IPsec is disabled by default.

About this task

Until you enable IPsec on both sides of the virtual links, the links cannot exchange OSPFv3 control messages, and the system drops OSPFv3 exchange packets.

You must disable IPsec before you can perform virtual link policy configuration changes.

Before you begin

- Configure the OSPF virtual link.
- Create the IPsec security association.

Procedure

1. In the navigation pane, expand the following folders: **Configuration > Security > Control Panel**.
2. Click **IPSec**.
3. Click the **OSPF Virtual Link** tab.
4. Click **Insert**.
5. Specify the area ID.
6. Specify the neighbor address.
7. Complete the remaining optional configuration.
8. Click **Insert**.

OSPF Virtual Link field descriptions

Use the data in the following table to use the **OSPF Virtual Link** tab.

Name	Description
Areald	Identifies the OSPF virtual link area.
Neighbor	Identifies the OSPF virtual link neighbor.

Table continues...

Name	Description
SAName	Links the security association to the OSPF virtual link.
AdminStatus	Enables the policy. The default is disabled.
Action	Configures the action of the IPsec policy under the OSPF virtual tunnel to one of the following: <ul style="list-style-type: none"> • permit—Permits the IP packets. • drop—Drops the IP packets. The default is permit.
Direction	Specifies the direction you want to protect with IPsec: <ul style="list-style-type: none"> • inBound—Specifies ingress traffic. • outBound—Specifies egress traffic. • bothDirections—Specifies both ingress and egress traffic. The default is bothDirections.
SrcAddress	Shows the address of the source interface to which the policy applies.
DstAddress	Shows the address of the destination interface to which the policy applies.
LinkID	Shows a unique ID for the OSPF virtual link. The default is 0.
IfIndex	Shows the interface index to which OSPF virtual link the policy applies.
OperStatus	Shows the operational status of the link, either up or down. The default is down.

Creating an OSPF interface on a router port

Configure the OSPF protocol on an IPv6 interface to support dynamic routing on the interface. Perform this procedure to create an OSPF interface on a router port.

If you want to modify existing OSPFv3 interfaces, see [Modifying an OSPF interface](#) on page 189. To configure OSPFv3 on an IPv6 VLAN, see [Creating an OSPF VLAN interface](#) on page 179.

Before you begin

- The IPv6 interface must exist.

Procedure

1. In the Device Physical view, select a port.
2. In the navigation pane, expand the **Configuration > Edit > Port** folders.

3. Click **IPv6**.
4. Click the **IPv6 OSPF Interface** tab.
5. Click **Insert**.
6. Select the area ID.
7. Select **enabled**.
8. Click **Insert**.

IPv6 OSPF Interface field descriptions

Use the data in the following table to use the **IPv6 OSPF Interface** tab.

Name	Description
Index	Shows the interface index for the IPv6 interface on which OSPFv3 is configured.
Areald	Specifies the area ID to which the IPv6 interface connects. Use 0.0.0.0 for the OSPFv3 backbone.
Type	Specifies the OSPFv3 interface type as one of the following: <ul style="list-style-type: none"> • broadcast • NBMA • point-to-point • point-to-multipoint
AdminStat	Specifies the administrative status for the OSPFv3 interface. If you enable the status, it is advertised as an internal route to some areas. If you disable the status, the interface is external to OSPFv3. The default is enabled.
RtrPriority	Specifies the priority of this interface. Multiaccess networks use the priority in the designated router election. A higher priority value increases the chance the router becomes the designated router. A value of zero (0) indicates the router cannot become the designated router for the network. If more than one router uses the same priority value, the router ID determines the designated router. The default is 1.
TransitDelay	Specifies the estimated number of seconds to transmit a link-state-update packet over this interface. The default is 1.

Table continues...

Name	Description
RetransInterval	Specifies the number of seconds between retransmission of link-state advertisements for the adjacencies that belong to this interface, and for database description and link-state request packets. The default is 5.
HelloInterval	Specifies the number of seconds between the hello packets that the router sends on this interface. You must configure this field to the same value for all routers attached to a common network. The default is 10.
RtrDeadInterval	Specifies the number of seconds after which to declare a router down if no hello packets are received. You must configure this field to the same value for all routers attached to a common network. The default is 40.
PollInterval	Specifies the number of seconds between hello packets sent to an inactive NBMA neighbor. The default is 120.
State	Shows the state of the OSPFv3 interface as one of the following: <ul style="list-style-type: none"> • down • loopback • waiting • pointToPoint • designatedRouter • backupDesignatedRouter • otherDesignatedRouter
DesignatedRouter	Shows the router ID for the designated router.
BackupDesignatedRouter	Shows the router ID for the backup designated router.
MetricValue	Specifies the cost for the interface. The default value for a brouter port or VLAN is 1. The default value for a tunnel is 100. <p> Note:</p> <p>If you do not specify a cost for the interface, the switch dynamically updates the interface cost with the configured global OSPF default cost. The global OSPF default cost depends on the speed of the interface.</p>
LinkLsaSuppression	Specifies whether Link LSA suppression is enabled.

Creating an OSPF VLAN interface

Configure the OSPF protocol on an IPv6 VLAN to support dynamic routing on the interface.

If you want to modify existing OSPFv3 interfaces, see [Modifying an OSPF interface](#) on page 189.

Before you begin

- The IPv6 interface must exist.

Procedure

1. In the navigation pane, expand the following folders: **Configuration > VLAN**.
2. Click **VLANs**.
3. Click the **Basic** tab.
4. Select a **VLAN**.
5. Click **IPv6**.
6. Click the **IPv6 OSPF Interface** tab.
7. Click **Insert**.
8. Select the area ID.
9. Select **enabled**.
10. Click **Insert**.

IPv6 OSPF Interface field descriptions

Use the data in the following table to use the **IPv6 OSPF Interface** tab.

Name	Description
Index	Shows the interface index for the IPv6 interface on which OSPFv3 is configured.
Areald	Specifies the area ID to which the IPv6 interface connects. Use 0.0.0.0 for the OSPFv3 backbone.
Type	Specifies the OSPFv3 interface type as one of the following: <ul style="list-style-type: none"> • broadcast • NBMA • point-to-point • point-to-multipoint
AdminStat	Specifies the administrative status for the OSPFv3 interface. If you enable the status, it is advertised as an internal route to some areas. If you disable the

Table continues...

Name	Description
	status, the interface is external to OSPFv3. The default is enabled.
RtrPriority	<p>Specifies the priority of this interface. Multiaccess networks use the priority in the designated router election.</p> <p>A higher priority value increases the chance the router becomes the designated router. A value of zero (0) indicates the router cannot become the designated router for the network. If more than one router uses the same priority value, the router ID determines the designated router.</p> <p>The default is 1.</p>
TransitDelay	Specifies the estimated number of seconds to transmit a link-state-update packet over this interface. The default is 1.
RetransInterval	Specifies the number of seconds between retransmission of link-state advertisements for the adjacencies that belong to this interface, and for database description and link-state request packets. The default is 5.
HelloInterval	Specifies the number of seconds between the hello packets that the router sends on this interface. You must configure this field to the same value for all routers attached to a common network. The default is 10.
RtrDeadInterval	Specifies the number of seconds after which to declare a router down if no hello packets are received. You must configure this field to the same value for all routers attached to a common network. The default is 40.
PollInterval	Specifies the number of seconds between hello packets sent to an inactive NBMA neighbor. The default is 120.
State	<p>Shows the state of the OSPFv3 interface as one of the following:</p> <ul style="list-style-type: none"> • down • loopback • waiting • pointToPoint • designatedRouter • backupDesginatedRouter

Table continues...

Name	Description
	• otherDesignatedRouter
DesignatedRouter	Shows the router ID for the designated router.
BackupDesignatedRouter	Shows the router ID for the backup designated router.
MetricValue	Specifies the cost for the interface. The default value for a brouter port or VLAN is 1. The default value for a tunnel is 100. * Note: If you do not specify a cost for the interface, the switch dynamically updates the interface cost with the configured global OSPF default cost. The global OSPF default cost depends on the speed of the interface.
LinkLsaSuppression	Specifies whether Link LSA suppression is enabled.

Creating an OSPF interface on a tunnel

Configure the OSPF protocol on an IPv6 interface to support dynamic routing on the interface. Perform this procedure to create an OSPF interface on a tunnel.

If you want to modify existing OSPFv3 interfaces, see [Modifying an OSPF interface](#) on page 189. To configure OSPFv3 on an IPv6 VLAN, see [Creating an OSPF VLAN interface](#) on page 179.

Before you begin

- The IPv6 interface must exist.

Procedure

1. In the navigation pane, expand the **Configuration > IPv6** folders.
2. Click **Tunnel**.
3. Click the **Tunnel Config** tab.
4. Select a configured tunnel.
5. Click **IPv6 OSPF**.
6. Click **Insert**.
7. Select the area ID.
8. Select **enabled**.
9. Click **Insert**.

OSPF Interface field descriptions

Use the data in the following table to use the OSPF Interface tab.

Name	Description
Index	Shows the interface index for the IPv6 interface on which OSPFv3 is configured.
AreaId	Specifies the area ID to which the IPv6 interface connects. Use 0.0.0.0 for the OSPFv3 backbone.
Type	<p>Specifies the OSPFv3 interface type as one of the following:</p> <ul style="list-style-type: none"> • broadcast • NBMA • point-to-point • point-to-multipoint
AdminStat	Specifies the administrative status for the OSPFv3 interface. If you enable the status, it is advertised as an internal route to some areas. If you disable the status, the interface is external to OSPFv3. The default is enabled.
RtrPriority	<p>Specifies the priority of this interface. Multiaccess networks use the priority in the designated router election.</p> <p>A higher priority value increases the chance the router becomes the designated router. A value of zero (0) indicates the router cannot become the designated router for the network. If more than one router uses the same priority value, the router ID determines the designated router.</p> <p>The default is 1.</p>
TransitDelay	Specifies the estimated number of seconds to transmit a link-state-update packet over this interface. The default is 1.
RetransInterval	Specifies the number of seconds between retransmission of link-state advertisements for the adjacencies that belong to this interface, and for database description and link-state request packets. The default is 5.
HelloInterval	Specifies the number of seconds between the hello packets that the router sends on this interface. You must configure this field to the same value for all routers attached to a common network. The default is 10.
RtrDeadInterval	Specifies the number of seconds after which to declare a router down if no hello packets are received. You must configure this field to the same

Table continues...

Name	Description
	value for all routers attached to a common network. The default is 40.
PollInterval	Specifies the number of seconds between hello packets sent to an inactive NBMA neighbor. The default is 120.
State	Shows the state of the OSPFv3 interface as one of the following: <ul style="list-style-type: none"> • down • loopback • waiting • pointToPoint • designatedRouter • backupDesginatedRouter • otherDesignatedRouter
DesignatedRouter	Shows the router ID for the designated router.
BackupDesignatedRouter	Shows the router ID for the backup designated router.
MetricValue	Specifies the cost for the interface. The default value for a brouter port or VLAN is 1. The default value for a tunnel is 100. <p> Note:</p> <p>If you do not specify a cost for the interface, the switch dynamically updates the interface cost with the configured global OSPF default cost. The global OSPF default cost depends on the speed of the interface.</p>
LinkLsaSuppression	Specifies whether Link LSA suppression is enabled.

Viewing the AS-scope link-state database

View the AS-scope link-state database (LSDB) to see the LSAs that are flooded through the routing domain. The AS scope is used for AS external-LSAs.

Procedure

1. In the navigation tree, expand the following folders: **Configuration > IPv6**.
2. Click **OSPF**.
3. Click the **AS-scope LSDB** tab.

AS-scope LSDB field descriptions

Use the data in the following table to use the **AS-scope LSDB** tab.

Name	Description
Type	Shows the type of the link-state advertisement. Each link state type has a separate advertisement format. AS-scope LSAs not recognized by the router may be stored in the database.
RouterId	Shows the 32 bit number that uniquely identifies the originating router in the autonomous system.
Lsid	Identifies the piece of the routing domain that is being described by the advertisement.
Sequence	Shows a signed 32-bit integer that detects old and duplicate link-state advertisements. The larger the sequence number, the more recent the advertisement.
Age	Shows the age of the link-state advertisement in seconds.
Checksum	Indicates the checksum of the complete contents of the advertisement, except the age field. The age field is not affected so that the advertisement age value increments without updating the checksum. The checksum used is the same for ISO connectionless datagrams, the Fletcher checksum.

Viewing the area-scope LSDB

View the area-scope LSDB to see the LSAs that are flooded in a single OSPF area. Area scope is used in router LSAs, network LSAs, Inter-Area-Prefix-LSAs, Inter-Area-Router LSAs, and Intra-Area-Prefix-LSAs.

Procedure

1. In the navigation tree, expand the following folders: **Configuration > IPv6**.
2. Click **OSPF**.
3. Click the **Area-scope LSDB** tab.

Area-scope LSDB field descriptions

Use the data in the following table to use the **Area-scope LSDB** tab.

Name	Description
Areald	Identifies the area ID from which the LSA is received. Area ID 0.0.0.0 is the OSPF backbone.

Table continues...

Name	Description
Type	Identifies the type of the link-state advertisement. Each link-state type has a separate advertisement format. Area-scope LSAs unrecognized by the router are also stored in this database.
RouterId	Identifies the originating router in the autonomous system.
Lsid	Identifies the piece of the routing domain that is described by the advertisement.
Sequence	Shows a signed 32-bit integer that detects old and duplicate link-state advertisements. The larger the sequence number, the more recent the advertisement.
Age	Shows the age of the link-state advertisement in seconds.
Checksum	Indicates the checksum of the complete contents of the advertisement, except the age field. The age field is not affected so that the advertisement age value increments without updating the checksum. The checksum used is the same for ISO connectionless datagrams, the Fletcher checksum.

Viewing the link-scope LSDB

View the link-scope LSDB to view the LSAs that are not flooded beyond the local link.

Procedure

1. In the navigation tree, expand the following folders: **Configuration > IPv6**.
2. Click **OSPF**.
3. Click the **Link-scope LSDB** tab.

Link-scope LSDB field descriptions

Use the data in the following table to use the **Link-scope LSDB** tab.

Name	Description
IfIndex	Shows the identifier of the link from which the LSA was received.
Type	Shows the type of the link-state advertisement. Each link state type has a separate advertisement format. Link-scope LSAs not recognized by the router may be stored in the database.

Table continues...

Name	Description
RouterId	Shows the 32 bit number that uniquely identifies the originating router in the autonomous system.
Lsid	Identifies the piece of the routing domain that is being described by the advertisement.
Sequence	Shows a signed 32-bit integer that detects old and duplicate link-state advertisements. The larger the sequence number, the more recent the advertisement.
Age	Shows the age of the link-state advertisement in seconds.
Checksum	Indicates the checksum of the complete contents of the advertisement, except the age field. The age field is not affected so that the advertisement age value increments without updating the checksum. The checksum used is the same for ISO connectionless datagrams, the Fletcher checksum.

Adding an NBMA neighbor

Add an NBMA neighbor for each interface that is eligible to become the DR.

An NBMA interface with a positive nonzero router priority is eligible to become the DR for the NBMA network and is configured with the identification of all attached routers, IPv6 addresses, and router priorities.

Before you begin

- Identify the following information:
 - specific interfaces to include in the NBMA network
 - the IPv6 address for each interface
 - the router priority for each interface
 - the hello interval for the network
 - the router dead interval for the network
 - the poll interval for the network

About this task

In contrast to a broadcast network where switches multicast (send to AllSPFRouters and AllDRouters) certain OSPF protocol packets, switches replicate and send NBMA packets to each neighboring router as unicast. NBMA networks drop all OSPF packets with destination addresses AllSPFRouters and AllDRouters. Because the NBMA network does not broadcast, you must manually configure a list of neighbors and priorities for all routers in the network that can become the DR. Potential DRs use a positive nonzero router priority.

Procedure

1. In the navigation tree, expand the following folders: **Configuration > IPv6**.
2. Click **OSPF**.
3. Click the **NBMA Neighbors** tab.
4. Click **Insert**.
5. Select the IPv6 port or VLAN interface.
6. Specify the IPv6 address for the neighbor.
7. Specify the priority for the neighbor.
8. Click **Insert**.

NBMA Neighbors field descriptions

Use the data in the following table to use the **NBMA Neighbors** tab.

Name	Description
IfIndex	Specifies the link ID for the link over which the switch reaches the neighbor.
Address	Specifies the IPv6 address of the neighbor.
Priority	Specifies the priority to use for this neighbor in the designated router election process. A value of 0 indicates the neighbor cannot become the designated router. The higher the priority value, the higher chance the switch will win the election process. The default is 1.
RtrId	Identifies the neighboring router in the autonomous system. The value is 0.0.0.0 until the switch receives a hello message from the neighbor.
State	Identifies the state of the relationship with the neighbor. The state can be one of the following: <ul style="list-style-type: none"> • down • attempt • init • twoWay • exchangeStart • exchange • loading • full

Enabling OSPF route redistribution

Enable redistribution to announce routes of a certain source protocol type into the OSPFv3 domain.

You can redistribute directly connected routes, IPv6 static routes, IPv6 BGP routes, IPv6 IS-IS routes, and RIPng routes into OSPFv3.

About this task

If you do not configure a redistribution entry, the switch generates external LSAs for non-OSPF routes.

You can also redistribute directly connected routes, IPv6 static routes, and IPv6 OSPFv3 routes into BGP.

For information about BGP for IPv6, see *Configuring BGP Services*.

Procedure

1. In the navigation pane, expand the following folders: **Configuration > IPv6**.
2. Click **OSPF**.
3. Click the **Redistribute** tab.
4. For the type of route source, double-click the cell in the **Enable** column to change the value.
5. Select **enable**.
6. Click **Apply**.

Redistribute field descriptions

Use the data in the following table to use the **Redistribute** tab.

Name	Description
DstVrflid	Shows the ID of the destination virtual router and forwarder (VRF). Because IPv6 is not virtualized, the value is 0 for the Global Router.
Protocol	Shows the routing protocol that receives the external routing information. In this case, the routing protocol is OSPFv3.
SrcVrflid	Shows the ID of the source VRF. Because IPv6 is not virtualized, the value is 0 for the Global Router.
RouteSource	Shows the source protocol from which to receive routes to insert into the OSPFv3 domain.
Enable	Configures the status of route redistribution. The default is disable.

Modifying an OSPF interface

Configure the OSPF protocol on IPv6 interface to support dynamic routing on the interface. An IPv6 interface can be a tunnel, port or VLAN.

Before you begin

- The OSPF interface must exist.

Procedure

1. In the navigation pane, expand the following folders: **Configuration > IPv6**.
2. Click **OSPF**.
3. Click the **Interfaces** tab.
4. Double-click a cell to edit the value.
5. Click **Apply**.

Interfaces field descriptions

Use the data in the following table to use the **Interfaces** tab.

Name	Description
Index	Shows the interface index for the IPv6 interface on which OSPFv3 is configured.
Areald	Specifies the area ID to which the IPv6 interface connects. Use 0.0.0.0 for the OSPFv3 backbone.
Type	Specifies the OSPFv3 interface type as one of the following: <ul style="list-style-type: none"> • broadcast • NBMA • point-to-point • point-to-multipoint
AdminStat	Specifies the administrative status for the OSPFv3 interface. If you enable the status, it is advertised as an internal route to some areas. If you disable the status, the interface is external to OSPFv3. The default is enabled.
RtrPriority	Specifies the priority of this interface. Multiaccess networks use the priority in the designated router election. A higher priority value increases the chance the router becomes the designated router. A value of zero (0) indicates the router cannot become the

Table continues...

Name	Description
	designated router for the network. If more than one router uses the same priority value, the router ID determines the designated router. The default is 1.
TransitDelay	Specifies the estimated number of seconds to transmit a link-state-update packet over this interface. The default is 1.
RetransInterval	Specifies the number of seconds between retransmission of link-state advertisements for the adjacencies that belong to this interface, and for database description and link-state request packets. The default is 5.
HelloInterval	Specifies the number of seconds between the hello packets that the router sends on this interface. You must configure this field to the same value for all routers attached to a common network. The default is 10.
RtrDeadInterval	Specifies the number of seconds after which to declare a router down if no hello packets are received. You must configure this field to the same value for all routers attached to a common network. The default is 40.
PollInterval	Specifies the number of seconds between hello packets sent to an inactive NBMA neighbor. The default is 120.
State	Shows the state of the OSPFv3 interface as one of the following: <ul style="list-style-type: none"> • down • loopback • waiting • pointToPoint • designatedRouter • backupDesginatedRouter • otherDesignatedRouter
DesignatedRouter	Shows the router ID for the designated router.
BackupDesignatedRouter	Shows the router ID for the backup designated router.
MetricValue	Specifies the cost for the interface. The default value for a brouter port or VLAN is 1. The default value for a tunnel is 100.

Table continues...

Name	Description
	<p> Note:</p> <p>If you do not specify a cost for the interface, the switch dynamically updates the interface cost with the configured global OSPF default cost. The global OSPF default cost depends on the speed of the interface.</p>
LinkLsaSuppression	Specifies whether Link LSA suppression is enabled.

Viewing OSPF neighbors

View OSPF neighbors to see routers with interfaces to a common network.

The OSPF hello protocol maintains and dynamically discovers neighbor relationships.

The exception is an NBMA network; you manually configure permanent neighbors on each router eligible to become the designated router (DR).

Procedure

1. In the navigation tree, expand the following folders: **Configuration > IPv6**.
2. Click **OSPF**.
3. Click the **Neighbors** tab.

Neighbors field descriptions

Use the data in the following table to use the **Neighbors** tab.

Name	Description
Ifindex	Displays the local-link ID of the link over which the neighbor can be reached.
RtrId	<p>Identifies the neighboring router in the Autonomous System.</p> <p>The value is the router ID of the neighboring router, which in OSPF uses the same format as an IPv6 address but identifies the router independent of IPv6 address.</p>
Address	Displays the IPv6 address for the neighbor associated with the local link.
Options	Displays the bit mask that corresponds to the options field on the neighbor.
State	Displays the state of the relationship with the neighbor.

Table continues...

Name	Description
	<p>The value can be one of the following:</p> <ul style="list-style-type: none"> • down • attempt • init • twoWay • exchangeStart • exchange • loading • full
NbrIfId	Displays the interface ID that the neighbor advertises in its hello packets on this link.
DeadIntCnt	<p>Displays the Dead interval Count or TTL (time to live) field that indicates how many seconds remain before the system declares the Neighbor down.</p> <p>The starting value is the Router Dead Interval value and it decrements to 0 if no Hello is received for that neighbor within the interval. If no Hello is received within the interval, then the system declares the neighbor down.</p> <p>When a hello is received for the neighbor, the system resets the value to the Router Dead Interval value.</p>

Viewing virtual neighbors

View information about the neighbors on the virtual link to the OSPF backbone.

Procedure

1. In the navigation tree, expand the following folders: **Configuration > IPv6**.
2. Click **OSPF**.
3. Click the **Virtual Neighbors** tab.

Virtual Neighbors field descriptions

Use the data in the following table to use the **Virtual Neighbors** tab.

Name	Description
Area	Shows the ID for the transit area.

Table continues...

Name	Description
RtrId	Shows the ID for the neighboring router in the autonomous system.
LocalIndex	Shows the local interface ID for the virtual link over which the switch can reach the neighbor.
AddressType	Shows the type of address as one of the following: <ul style="list-style-type: none"> • ipv4 • ipv6 • ipv4z • ipv6z • dns ipv4z and ipv6z indicate a scope zone.
Address	Shows the IPv6 address that this virtual neighbor advertises. This value must be a global scope address.
Options	Shows a bit mask that corresponds to the OSPF options field of the neighbor.
State	Shows the state of the virtual neighbor relationship. The value can be one of the following: <ul style="list-style-type: none"> • down • attempt • init • twoWay • exchangeStart • exchange • loading • full

Chapter 8: RIPng

This chapter provides concepts and procedures to complete RIPng configuration.

RIPng fundamentals

Routing Information Protocol next generation (RIPng) allows routers to exchange information for computing routes through an IPv6–based network. You should implement RIPng only on routers. IPv6 provides neighbor router information required by RIPng protocol to function as intended. A RIPng router is assumed to have interfaces in several networks and the protocol relies primarily on the metric of each network to compute routes using the distance vector algorithm.

RIP identifies network reachability based on cost, and cost is defined as hop count. One hop is the distance from one router to the next. This cost, or hop count, is the metric.

RIPng-enabled routers use UDP port 521 (the RIPng port) to exchange routing information. RIPng responds to a request by sending a message to the port from which the request originates. Specific queries can be sent from ports other than the RIPng port, but they must be directed to the RIPng port on the target machine.

Each router advertises routing information by sending an update every 30 seconds (one interval). If RIPng does not receive information about a network for 180 seconds, the metric associated with the network rises to infinity (U); that is, the metric resets to 16, which means the network becomes unreachable. If RIP does not receive information about a network for 120 seconds, it removes the network from the routing table.

*** Note:**

These time interval values are default values which are configurable by the user.

Each router that implements RIPng contains a routing table. This table contains one entry for every destination that is reachable throughout the system operating RIPng. At a minimum, each routing table entry contains the following information:

- The IPv6 prefix of the destination.
- A metric that represents the total cost of getting a datagram from the router to that destination. The metric is the sum of the costs of traversing the networks to arrive at the destination.
- The IPv6 address of the next router in the path to the destination (the next hop). The next-hop IPv6 address is a linklocal address.

- The VLAN or brouter port on which the RIPng routes were learned.
- The age of the RIPng route.

RIPng protocol implementation is specified in IETF document RFC 2080.

RIPng messages and packet format

RIPng-enabled routers use UDP port 521 (the RIPng port) to send and receive datagrams.

The following figure shows the RIPng packet format:

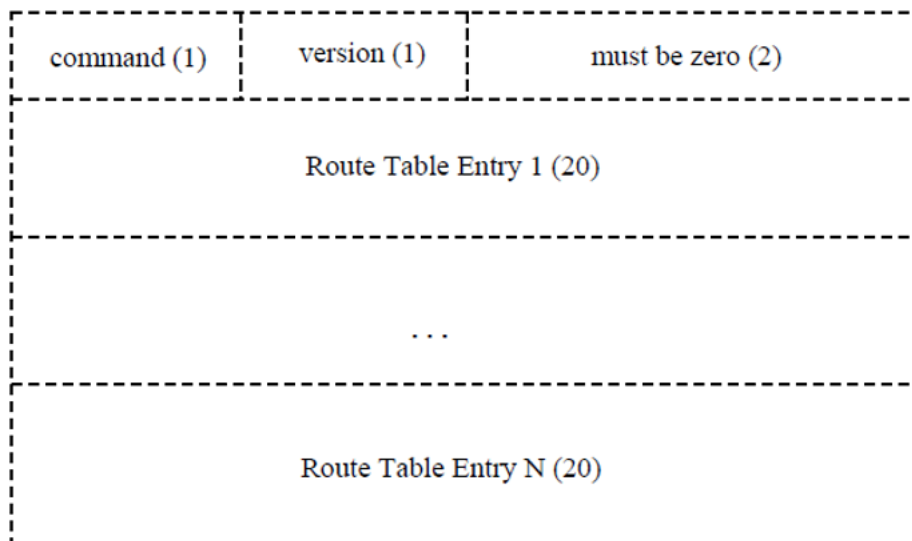

Figure 10: RIPng packet format

A RIPng packet header consists of the following components:

- **command**: Specifies the purpose of the message.
- **version**: The version of RIPng.

Originate Default route

Generally you use a default route when it is not convenient to list every possible network in RIPng updates, and one or more routers in the system are able to handle traffic to networks that RIPng does not explicitly list.

RIPng is enabled with the default route only option. When you enable default route only on an interface, it suppresses all other routes in the update sent for the interface, and advertises only the default route.

Timers

RIPng states four different timer intervals for protocol operation:

- **Update timer**: The RIPng process sends a complete routing table to each neighboring router every 30 seconds. To prevent collisions on broadcast networks, the process adds an offset value to the timer.
- **Timeout time interval**: This is a 180 second time interval associated with every route. If the time interval expires, the metric for this route updates to the value of infinity (16) and the route is no longer valid. However, the routing table retains the value for another 120 seconds.

- **Garbage collection time interval:** After the timeout time interval expires and the route becomes invalid, it remains in the routing table until the garbage collection time interval expires. The garbage collection time interval is 120 seconds. Until the garbage collection time interval expires all updates sent by this router include the invalid route. When the garbage collection timer expires, the process removes the route from the routing table.
- **Triggered update time interval:** The triggered update time interval is set to a random value between 1 and 5 seconds after a triggered update is sent. A single update is sent even if multiple triggered updates occur before the timer expires.

Configuration of timers or time intervals is supported only at the CLI/SNMP/EDM level. Configuration of timers or time intervals is not supported at the interface/port level.

RIPng configuration using the CLI

Configuring RIPng globally

Configure RIPng parameters on the router so you can control RIPng behavior on the system.

Before you begin

You can configure RIPng only on a global router. You cannot configure RIPng on a VRF instance.

Procedure

1. Enter Global Configuration mode:

```
enable
configure terminal
```

2. Enable RIPng globally:

```
router rip ipv6-enable
```

Configuring RIPng on an interface

Configure RIPng on Ethernet ports and VLANs so that they can participate in RIPng routing.

About this task

RIPng does not operate on a port or VLAN until you enable it both globally and on the port or VLAN.

Before you begin

- Assign an IP address to the port or VLAN.
- Configure RIPng and enable it globally.

Procedure

1. Enter Interface Configuration mode:

```
enable

configure terminal

interface GigabitEthernet {slot/port[/sub-port] [-slot/port[/sub-
port]][,...]} or interface vlan <1-4059>
```

*** Note:**

If your platform supports channelization and the port is channelized, you must also specify the sub-port in the format slot/port/sub-port.

2. Create a RIPng interface:

```
ipv6 rip
```

3. Enable the RIPng interface:

```
ipv6 rip enable
```

4. Verify the operational status of the RIPng interface:

```
show ipv6 rip interface
```

Example

```
Switch:1>enable
Switch:1#configure terminal
Enter configuration commands, one per line. End with CNTL/Z.
Switch:1(config)#interface vlan 22
Switch:1(config-if)#ipv6 rip
Switch:1(config-if)#ipv6 rip enable
Switch:1(config-if)#show ipv6 rip interface
```

```
Total RIPng interfaces: 2
```

```
=====
RIPng Interface - GlobalRouter
=====
IFINDX      COST      POISON      SEND      ADMIN      OPER
STATUS      STATUS      DEFAULT     STATUS     STATUS
-----
257 (2/2 )  2         disable     disable    enable     enable
2070 (22 )  5         disable     disable    enable     disable
```

```
2 out of 2 Total Num of RIPng interfaces displayed
```

Variable definitions

Use the data in the following table to use the **ipv6 rip** command.

Variable	Value
<1-4059>	Specifies the VLAN ID in the range of 1 to 4059. By default, VLAN IDs 1 to 4059 are configurable and the system reserves VLAN IDs 4060 to 4094 for internal use. On switches that support the vrf-scaling

Table continues...

Variable	Value
	and spbm-config-mode boot configuration flags, if you enable these flags, the system also reserves VLAN IDs 3500 to 3998. VLAN ID 1 is the default VLAN and you cannot create or delete VLAN ID 1. This variable applies only to VLAN interfaces, not ports.
{slot/port[/sub-port][/-slot/port[/sub-port]][,...]}	Identifies the slot and port in one of the following formats: a single slot and port (slot/port), a range of slots and ports (slot/port-slot/port), or a series of slots and ports (slot/port,slot/port,slot/port). If your platform supports channelization and the port is channelized, you must also specify the sub-port in the format slot/port/sub-port.

Configuring RIPng custom values

Configure custom values for RIPng parameters to replace default values.

Before you begin

- Configure RIPng and enable it globally.

Procedure

1. Enter Interface Configuration mode:

```
enable
```

```
configure terminal
```

```
interface GigabitEthernet {slot/port[/sub-port][/-slot/port[/sub-port]][,...]} or interface vlan <1-4059>
```

Note:

If your platform supports channelization and the port is channelized, you must also specify the sub-port in the format slot/port/sub-port.

2. Enable RIPng poison:

```
ipv6 rip poison enable
```

3. Specify the RIPng cost:

```
ipv6 rip cost <1-15 Cost>
```

4. Access router RIPng configuration mode:

```
router rip
```

5. Specify the RIPng holddown timer value:

```
ipv6 timers basic holddown <0-360>
```

6. Specify the RIPng timeout timer value:

```
ipv6 timers basic timeout <15-259200>
```

7. Specify the RIPng update timer value:

```
ipv6 timers basic update <1-360>
```

8. Specify the default route metric value:

```
ipv6 default-information metric <1-15>
```

9. Enable default information globally:

```
ipv6 default-information enable
```

10. Ensure the configuration is correct:

```
show ipv6 rip
```

Example

Configure custom values for RIPng.

```
Switch:1>enable
Switch:1#configure terminal
Enter configuration commands, one per line. End with CNTL/Z.
Switch:1(config)#router rip
Switch:1(config-rip)#ipv6 default-information metric 1
Switch:1(config-rip)#ipv6 default-information enable
Switch:1(config-rip)#ipv6 timers basic update 30
Switch:1(config-rip)#ipv6 timers basic timeout 180
Switch:1(config-rip)#ipv6 timers basic holddown 120
Switch:1(config-rip)#router rip ipv6-enable
Switch:1(config)#show ipv6 rip
```

```
=====
RIPng Global - GlobalRouter
=====
```

```

Rip : Enabled
HoldDown Time : 120
Timeout Interval : 180
Update Time : 30
Default Info Metric : 1
Default Info State : Enabled
Default Import Metric : 1
```

Variable definitions

Use the data in the following table to use the **ipv6 rip poison**, **ipv6 default-information** and **ipv6 timers basic** commands.

Variable	Value
<1-4059>	Specifies the VLAN ID in the range of 1 to 4059. By default, VLAN IDs 1 to 4059 are configurable and the system reserves VLAN IDs 4060 to 4094 for internal use. On switches that support the vrf-scaling and spbm-config-mode boot configuration flags, if you enable these flags, the system also reserves VLAN IDs 3500 to 3998. VLAN ID 1 is the default VLAN and you cannot create or delete VLAN ID 1. This variable applies only to VLAN interfaces, not ports.

Table continues...

Variable	Value
port {slot/port[/sub-port] [-slot/port[/sub-port]] [,...]}	Identifies the slot and port in one of the following formats: a single slot and port (slot/port), a range of slots and ports (slot/port-slot/port), or a series of slots and ports (slot/port,slot/port,slot/port). If your platform supports channelization and the port is channelized, you must also specify the sub-port in the format slot/port/sub-port.
poison enable	Enables Poison Reverse. If you disable Poison Reverse (no poison enable), Split Horizon is enabled. By default, Split Horizon is enabled. If you enable Split Horizon, the interface does not advertise IP routes learned from an immediate neighbor back to the neighbor. If you enable Poison Reverse, the RIP updates sent to a neighbor from which a route is learned are poisoned with a metric of 16. Therefore, the receiver neighbor ignores this route because the metric 16 indicates infinite hops in the network These mechanisms prevent routing loops.
<1-15 Cost>	Configures the RIPng cost for this port (link).
holddown <0-360>	Configures the RIPng holddown timer value, the length of time (in seconds) that RIPng continues to advertise a network after it determines that the network is unreachable. The default is 120.
timeout <15-259200>	Configures the RIPng timeout interval. The default is 180.
update <1-360>	Configure the RIPng update timer. The update time is the time interval between RIPng updates.
default-information <1-15>	Configure the default route metric value.

Configuring RIPng route distribution

Configure a redistribute entry to announce certain routes into the RIPng domain, including static routes, direct routes, Open Shortest Path First (OSPFv3), IS-IS, or Border Gateway Protocol (BGP+).

Before you begin

- Enable RIPng globally.

Procedure

1. Enter Global Configuration mode:

```
enable
configure terminal
```

2. Access router RIP configuration mode:

```
router rip
```

3. Enable the redistribution:

```
ipv6 redistribute {direct|isis|static|ospf|bgp} enable
```

4. Ensure the configuration is correct:

```
show ipv6 rip redistribute
```

Example

Enable the redistribution instance.

```
Switch:1#enable
Switch:1#configure terminal
Switch:1(config)#router rip
Switch:1(config-rip)#ipv6 redistribute bgp enable
Switch:1(config-rip)#ipv6 redistribute direct enable
Switch:1(config-rip)#ipv6 redistribute isis enable
Switch:1(config-rip)#ipv6 redistribute ospf enable
Switch:1(config-rip)#ipv6 redistribute static enable
Switch:1(config-rip)#show ipv6 rip redistribute
```

```
=====
                        RIPng Redistribute List
=====
      direct                : enabled
      static                 : enabled
      ospf                   : enabled
      bgp                    : enabled
      isis                   : enabled
=====
```

Variable definitions

Use the data in the following table to use the `ipv6 redistribute` command.

Variable	Value
<bgp direct isis ospf static>	Specifies the type of routes to redistribute (the protocol source). Valid options are bgp, isis, direct, ospf, or static.

RIPng Configuration using EDM

Configuring RIPng globally

Configure RIPng global parameters on the switch so you can control RIPng behavior on the system.

About this task

All router interfaces that use RIPng use the RIPng global parameters. Both brouter ports and VLAN virtual routing interfaces use the same RIPng global parameters.

You can configure RIPng on interfaces while RIPng is globally disabled. This way, you can configure all interfaces before you enable RIPng for the switch

Procedure

1. In the navigation tree, expand the following folders: **Configuration > IPv6**.

2. Click **IPv6 RIPng**.
3. Click the **Globals** tab.
4. Select the **enable** option button.
5. Configure other global RIPng parameters as required.
6. Click **Apply**.

Globals field descriptions

Use the data in the following table to use the Globals tab.

Name	Description
AdminState	Enables or disables RIPng globally. The default is disabled.
UpdateTime	Specifies the time interval between RIPng updates for all interfaces. The default is 30 seconds, and the range is 1–360.
GlobalHoldDownTime	Configures the length of time that RIPng continues to advertise a network after the network is unreachable. The range is 0–360 seconds. The default is 120 seconds.
GlobalTimeOutInterval	Configures the RIPng timeout interval. The range is 15–259200 seconds. The default is 180 seconds.
DefaultInfoMetric	RIPng default-information metric.
DefaultInfoState	Default-information enable or disable at the global level
DefaultImportMetric	Specifies the RIPng default import metric.

Configuring an IPv6 RIPng interface

Configure RIPng parameters on an interface so you can control RIPng behavior on the interface.

About this task

RIPng does not operate on an interface until you enable it globally and on the interface.

You can also configure an IPv6 RIPng interface for a brouter port by selecting **Device Physical View**, selecting a port, and following the **Edit > Port > IPv6** navigation path. You can configure an IPv6 RIPng interface for a VLAN through the **VLAN > VLANs > Basic > IPv6** navigation path. This procedure uses the main IPv6 RIPng navigation path where you can create both types of interfaces.

Before you begin

- Configure a routing interface (either a brouter port or a virtual routing interface).
- Assign an IP address to the interface.
- Enable RIPng globally.

Procedure

1. In the navigation tree, expand the following folders: **Configuration > IPv6**.
2. Click **IPv6 RIPng**.

3. Click the **Interfaces** tab.
4. Click **Insert**.
5. In the **IfIndex** box, type a value to identify the IPv6 interface.
6. In the **RipAdminStatus** option box, select **enable**.
7. Configure other parameters as required.
8. Click **Insert**.

Interfaces field descriptions

Use the data in the following table to use the **Interfaces** tab.

Name	Description
IfIndex	RIPng interface index.
RipAdminStatus	Enable or disable RIPng on an interface.
DefaultInfoState	Enable or disable default information at the interface level.
Cost	Specifies the RIPng metric cost.
Poison	Enable or disable poison reverse on an RIPng interface.
RipOperStatus	Enable or disable the RIPng operational state on an interface.

Configuring an IPv6 RIPng VLAN interface

Configure RIPng parameters on a VLAN interface so you can control RIPng behavior on the interface.

About this task

RIPng does not operate on an interface until you enable it globally and on the interface.

You can also configure an IPv6 RIPng interface for a brouter port by selecting **Device Physical View**, selecting a port, and following the **Edit > Port > IPv6** navigation path.

Before you begin

- Configure a routing interface (either a brouter port or a virtual routing interface).
- Assign an IP address to the interface.
- Enable RIPng globally.

Procedure

1. In the navigation pane, expand the following folders: **Configuration >VLAN**.
2. Click **VLANs**.
3. Click the **Basic** tab.
4. Select a row, and click **IPv6**.
5. Click **Insert**.

6. Configure other parameters, as required.
7. Click **Insert**.
8. Click **Apply**.

IPv6 Interfaces VLAN field descriptions

Use the data in the following table to use the **IPv6 Interfaces** tab.

Name	Description
Interface	Specifies the port or VLAN.
Identifier	Shows the IPv6 address interface identifiers. This value is a binary string of up to 8 octets in network byte-order.
IdentifierLength	Shows the length of the identifier, in bits.
Descr	Specifies a description of the interface. The network management system also configures this string.
VlanId	Specifies the VLAN ID in the range of 1 to 4059. By default, VLAN IDs 1 to 4059 are configurable and the system reserves VLAN IDs 4060 to 4094 for internal use. On switches that support the vrf-scaling and spbm-config-mode boot configuration flags, if you enable these flags, the system also reserves VLAN IDs 3500 to 3998. VLAN ID 1 is the default VLAN and you cannot create or delete VLAN ID 1. This value corresponds to the lower 12 bits of the IEEE 802.1Q VLAN tag.
Type	Shows the interface type.
ReasmMaxSize(MTU)	Specifies the maximum size of the MTU of this IPv6 interface. This value must be the same for all the IP addresses defined on this interface. The default value is 1500.
PhysAddress	Specifies the media-dependent physical address. For Ethernet, this is a MAC address.
AdminStatus	Specifies if IPv6 is active on this interface. The default is false (disabled).
OperStatus	Specifies the current operational status of the interface.
ReachableTime	Specifies the time, in milliseconds, that a neighbor is considered reachable after receiving a reachability confirmation. The default is 30000.
RetransmitTimer	Specifies the time, in milliseconds, between retransmissions of neighbor solicitation messages to a neighbor when resolving the address, or when

Table continues...

Name	Description
	probing the reachability of a neighbor. The default is 1000.
CurHopLimit	Specifies the current hop limit field sent in router advertisements from this interface. The value must be the current diameter of the Internet. A value of zero indicates that the advertisement does not specify a value for CurHopLimit. The default is 64.
MulticastAdminStatus	The option to select MulticastAdminStatus is disabled. You cannot configure the administrative status for multicast in this context.
MacOffset	Requests a particular MAC for an IPv6 VLAN. You can specify a MAC offset when you configure IPv6 on a VLAN, or the system can assign a MAC address from within the available range. Different hardware platforms support different MAC offset ranges.
ForwardingEnabled	Indicates whether IPv6 forwarding is enabled. The default is enabled.
RSMLTEnable	Shows whether RSMLT is enabled on the interface. The default value is disabled (false).

Configuring an IPv6 RIPng router port interface

Configure RIPng parameters on an interface so you can control RIPng behavior on the interface.

About this task

RIPng does not operate on an interface until you enable it globally and on the interface.

Before you begin

- Configure a routing interface (either a router port or a virtual routing interface).
- Assign an IP address to the interface.
- Enable RIPng globally and on the interface.

Procedure

1. In the Device Physical View, select a port.
2. In the navigation pane, expand the **Configuration** > **EditPort** folders.
3. Click **IPv6**.
4. Click the **RIPng** tab.
5. In the **RipAdminStatus** option box, select **enable**.
6. Configure other parameters as required.

- Click **Apply**.

RIPng field descriptions

Use the data in the following table to use the **RIPng** tab.

Name	Description
RipAdminStatus	Enable or disable RIPng on an interface.
DefaultInfoState	Enable or disable default information at the interface level. The default is disable.
Cost	Specifies the RIPng metric cost. The default is 1.
Poison	Enable or disable poison reverse on an RIPng interface. The default is disable.
RipOperStatus	Shows the RIPng operational state on an interface.

Graphing IPv6 RIPng statistics

Use the following procedure to graph RIPng statistics for monitoring RIPng behavior on the interface.

About this task

RIPng does not operate on an interface until you enable it globally and on the interface.

Before you begin

- Configure a routing interface (either a brouter port or a virtual routing interface).
- Assign an IP address to the interface.
- Enable RIPng globally and on the interface.

Procedure

1. In the navigation pane, expand the **Configuration >Ipv6** folders.
2. Click the **IPv6 RIPng**.
3. Click the **Stats** tab.
4. Select an interface row.
5. Click **Graph**.
6. Click **Apply**.

Configuring route redistribution to RIPng

Configure a redistribute entry to announce routes of a certain source protocol type into the RIPng domain, for example, static, RIP, or direct. Use a route policy to control the redistribution of routes.

Before you begin

- Enable RIP globally.
- Configure a route policy.

Procedure

1. In the navigation tree, expand the following folders: **Configuration > IPv6**.
2. Click **IPv6 RIPng**.
3. Click the **Redistribute** tab.
4. Double-click the value in the **Enable** column that corresponds with the source protocol type you want to enable or disable.
5. Select **enable** or **disable** from the list.
6. Click **Apply**.

Redistribute field descriptions

Use the data in the following table to use the **Redistribute** tab.

Name	Description
DstVrfiled	Specifies the destination VRF ID used in the redistribution.
Protocol	Specifies the dynamic routing protocol that receives the external routing information.
SrcVrfiled	Specifies the source VRF ID used in the redistribution.
RouteSource	Specifies the route source protocol for the redistribution entry.
Enable	Enables (or disables) a RIPng redistribute entry for a specified source type.

Viewing stats for RIPng interfaces

View statistics for RIPng interfaces.

Procedure

1. In the navigation tree, expand the following folders: **Configuration > IPv6**.
2. Click **IPv6 RIPng**.
3. Click the **Stats** tab.

Stats field descriptions

Use the data in the following table to use the **Stats** tab.

Name	Description
IfIndex	Shows the unique value to identify an IPv6 interface.
RcvBadPackets	The number of RIPng response packets received by the RIP process that were subsequently discarded for any reason (examples: a version 0 packet or an unknown command type).
RcvBadRoutes	The number of routes, in valid RIPng packets, that were ignored for any reason (examples: unknown address family or invalid metric).
SentUpdates	The number of triggered RIPng updates actually sent on this interface.
RcvUpdates	The number of triggered RIPng updates actually received on this interface. This explicitly does not include full updates received containing new information.

Chapter 9: VRRP

This chapter provides concepts and procedures to complete IPv6 Virtual Router Redundancy Protocol (VRRP) configuration.

VRRP

For IPv6 hosts on a LAN to learn about one or more default routers, IPv6-enabled routers send router advertisements using the IPv6 ND protocol. The routers multicast these router advertisements every few minutes.

The ND protocol uses a mechanism called neighbor unreachability detection to detect the failure of a neighbor node (router or host) or the failure of the forwarding path to a neighbor. Nodes can monitor the health of a forwarding path by sending unicast ND neighbor solicitation messages to the neighbor node. To reduce traffic, nodes only send neighbor solicitations to neighbors to which they actively send traffic and only after the node receives no positive indication that the neighbors are up for a period of time. A host takes a minimum of 5 seconds to learn that a router is unreachable before it switches to another default router, but this minimum value increases ND traffic. This delay can cause service disruption.

VRRP for IPv6 provides a faster switchover to an alternate default router than is possible using the ND protocol. With VRRP for IPv6, a backup router can take over for a failed default router in approximately three seconds (using default parameters). The switchover is accomplished without interaction with the hosts and with a minimum amount of VRRP traffic.

The IPv6 VRRP implementation is similar to the existing IPv4 VRRP operation, including support for holddown timer, critical IP, fast advertisements, and backup master. With backup master enabled, the backup switch routes all traffic according to its routing table. The backup master switch does not perform Layer 2 switching for the traffic to the VRRP master.

You must specify a link-local address to associate with the virtual router. Optionally, you can also assign global unicast IPv6 addresses to associate with the virtual router. Network prefixes for the virtual router are derived from the global IPv6 addresses assigned to the virtual router.

One active master switch exists for each IPv6 network prefix. All other VRRP interfaces in a network are in backup mode.

VRRP for IPv6 operation

VRRP uses a virtual IP address shared between two or more routers connecting the common network prefix to the enterprise network. With the virtual IP address as the default gateway on end hosts, VRRP provides dynamic default gateway redundancy in the event of failover.

The VRRP router with higher priority is called the master router. In case of equal priority the router with higher link-local address becomes the master router. The master router forwards packets sent to the virtual router IP addresses.

The following figure shows the minimum VRRP topology.

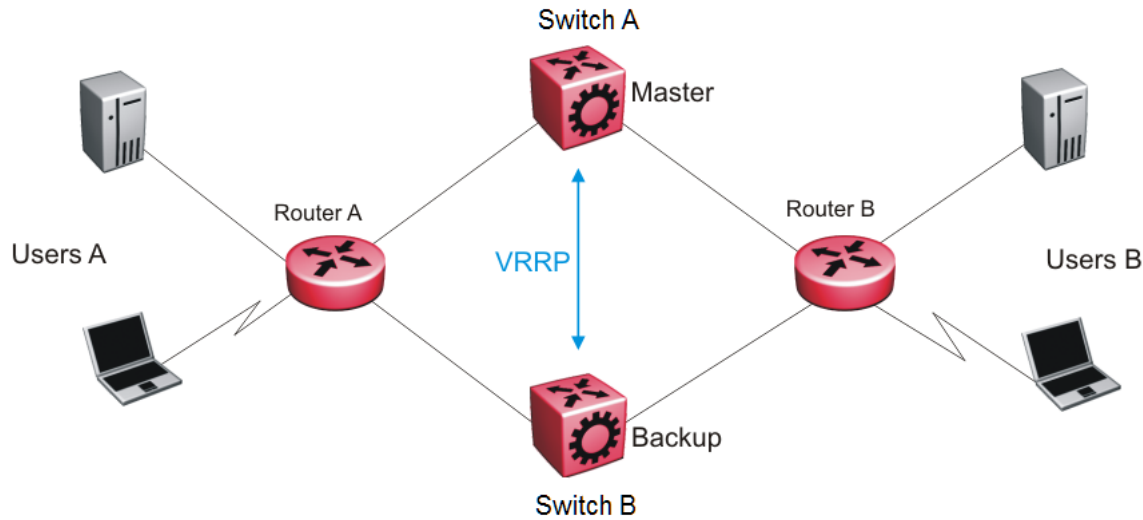

Figure 11: VRRP network topology

Traffic flows between users A and users B.

Router A uses VRRP global addresses as next hops for users B, and Router B for users A.

The VRRP master forwards the traffic and sends VRRP advertisements in the VLAN to announce to the backups that it is the master. If the master is no longer available, the backup takes over and becomes master. The only change occurs to the state of VRRP.

The VRRP router then transitions to the controlling state.

* Note:

The VRRP virtual IP address cannot be same as the local IP address of the port or VLAN on which VRRP is enabled.

In the controlling state, the VRRP router functions as the forwarding router for the IP addresses associated with the virtual router. The router responds to ND neighbor solicitation and ND router solicitation messages for these IP addresses, forwards packets with a destination MAC address equal to the virtual router MAC address, and accepts packets addressed to IP addresses associated with the virtual router.

If you initialize the VRRP router and the priority is not 255, the router transitions to the backup state to ensure that all Layer 2 switches in the downstream path relearn the new origin of the VRRP MAC addresses.

In the backup state, a VRRP router monitors the availability and state of the master router. The backup does not respond to ND neighbor solicitation and ND router solicitation messages for virtual router IP addresses and discards packets with a MAC address equal to the virtual router MAC address. The backup does not accept packets addressed to IP addresses associated with the virtual router. If a shutdown occurs, it transitions back to the initialize state. If the master router goes down, the backup router sends the VRRP advertisement and unsolicited ND neighbor advertisements and ND router advertisements described in the preceding paragraphs and transitions to the controlling state.

VRRP advertisements and master router failover

When you initialize a VRRP router, the master router continues to send advertisement messages at the advertisement interval period.

*** Note:**

The VRRP virtual IP address cannot be same as the local IP address of the port or VLAN on which VRRP is enabled.

The other VRRP routers transition to the backup state in the following situations:

- if the priority in the received advertisement is greater than the local priority
- if the priority in the received advertisement is the same as the local priority and the primary IP address of the sender is greater than the local primary IP address

The backup routers use the advertisements from the master router as a keepalive to monitor the health of the master router. If the backup router does not receive an advertisement during the master downtime interval, calculated as $3 * \text{advertisement interval}$, then the master router is declared down.

If a shutdown occurs, the master router sends a VRRP advertisement with a priority of 0 and transitions to the initialize state

The priority value 0 indicates that the master router has stopped participating in VRRP. This value triggers the backup router to transition to the master state without waiting for the current master to time out.

Critical IPv6 address and holddown timer

The critical IPv6 address is an interface that has primary impact on VRRP. If you enable critical IPv6 and the status of the critical IP changes, the master and backup relationship also changes.

If you configure and enable critical IPv6 address, the master transitions to backup if the critical IPv6 is down, and the backup becomes the master. After the critical IPv6 address of the original master resumes, if the hold-down timer is configured to 0, it becomes the master immediately. Otherwise, the original master transitions to the master state after the hold-down timer time out.

You can specify the local router IP interface uplink from the VRRP router to the network as the critical IP address. This ensures that, if the local uplink interface fails, VRRP initiates a master router failover to one of the backup routers.

The critical address can be one of the global unicast IPv6 addresses assigned to any local IPv6 interfaces.

The holddown timer is a proprietary enhancement to VRRP.

After a master transitions to backup by critical IP changing, one of the backup routers will be elected as the master router. After the critical IPv6 of the original master is restored, the original master

remains in the backup state for a period of time that you configure by using the `holddown-timer` parameter. The router becomes the master immediately if you use the command `ipv6 vrrp <1-255> action preempt`.

The holddown timer allows the master router enough time to detect and update the dynamic routes. The timer delays the preemption of the master over the backup, when the master becomes available. If the hold-timer is configured to 0, it becomes the master router immediately. Otherwise, it transitions to the master state only after the holddown timer times out.

The holddown timer does not apply during failovers caused by VRRP router priority change. The holddown timer applies only to failovers caused by a critical IP failure.

Configure all of your routers to use identical values for the holddown timer.

Important:

Do not use VRRP backup master and critical IP at the same time. Use one or the other. The critical IP address must be a local address.

VRRP backup master with triangular SMLT

The standard implementation of VRRP supports one active master switch for each IPv6 subnet. All other VRRP interfaces in a network are in backup mode.

A deficiency occurs when VRRP-enabled switches use SMLT. If VRRP switches are aggregated into two SMLT switches, the end host traffic is load-shared on all uplinks to the aggregation switches (based on the Multilink Trunk [MLT] traffic distribution algorithm).

However, VRRP usually has only one active routing interface enabled. All other VRRP routers are in backup mode. Therefore, all traffic that reaches the backup VRRP router is forwarded over Virtual Inter-Switch Trunk (vIST) toward the master VRRP router. In this case, vIST potentially does not have enough bandwidth to carry all the aggregated traffic.

To resolve this issue, assign the backup router as the backup master router. The backup master router can actively load-share the routing traffic with a master router.

Because the two VRRP peer nodes exchange MAC address tables, the VRRP backup master can forward traffic directly, on behalf of the master router. The switch in the backup master state routes all traffic received on the backup master IP interface according to its routing table. The backup master switch does not perform Layer 2 switching for the traffic to the VRRP master.

If you enable SMLT on the backup master router, the incoming host traffic is forwarded over the SMLT links as usual.

Important:

Do not use VRRP backup master and critical IP at the same time. Use one or the other.

Fast advertisement

You can configure the advertisement time interval (in seconds) between sending advertisement messages. This interval permits fast network convergence with standardized VRRP failover. However, losing connections to servers for more than a second can result in missing critical failures. Customer network uptime in many cases requires faster network convergence, which means network problems must be detected within hundreds of milliseconds.

To meet these requirements, the fast advertisement interval are provided.

The fast advertisement interval is similar to the advertisement interval parameter except for the unit of measure and the range. The fast advertisement interval is expressed in milliseconds and the range is from 200 to 1,000 milliseconds. This unit of measure must be in multiples of 200 milliseconds.

To configure fast advertisement, you must specify a fast advertisement interval and explicitly enable the fast advertisement option. After you enable fast advertisement, the fast advertisement interval is used instead of the advertisement interval.

If you enable fast advertisement, VRRP can only communicate with other products that have the same configuration.

Accept-mode

When you configure VRRP for IPv6 on an interface you can configure the accept-mode parameter, which controls whether the VRRP master or backup master accepts packets destined for the IPv6 address associated with the virtual router.

By default, accept-mode is disabled. The accept-mode parameter does not affect the Neighbor Discovery packets. The master router forwards packets with a destination link-layer MAC address that matches the virtual MAC address, and accepts packets forwarded over the virtual interswitch trunk (vIST) toward the master router, if accept-mode is enabled. If you disable accept-mode, you cannot ping the virtual IPv6 address. If you enable accept-mode, the master router accepts packets addressed to the IPv6 address that is associated with the virtual router.

When you configure VRRP for IPv6 on an interface, you can configure the accept-mode parameter. By default, accept-mode is disabled. If you disable accept-mode, the master router does not drop neighbor solicitations or neighbor advertisements. The master router forwards packets with a destination link-layer MAC address that matches the virtual MAC address. If you disable accept-mode, you cannot ping the virtual IPv6 address.

* Note:

The VRRP virtual IP address cannot be same as the local IP address of the port or VLAN on which VRRP is enabled.

VRRPv3

VRRPv3 is a combined protocol for both IPv4 and IPv6. It specifies an election protocol that dynamically assigns responsibility for a virtual router to one of the VRRP routers on a LAN. The VRRP router that controls the IPv4 or IPv6 addresses associated with a virtual router is called the Master, and it forwards packets sent to these IPv4 or IPv6 addresses. VRRP Backups wait for a Master and take ownership when the Master is no longer detected.

The election protocol provides dynamic failover in the forwarding responsibility when the Master is unavailable. VRRP for IPv4 gains a higher-availability default path without configuring dynamic routing or router discovery protocols on every end-host. VRRP for IPv6 gains a quick switch-over to Backup routers compared to the standard IPv6 Neighbor Discovery mechanisms.

The software supports VRRPv3 for IPv4 and VRRPv3 for IPv6. VRRPv3 for IPv6 is compliant to RFC 5798. The software also supports VRRPv2 for IPv4.

VRRPv3 guidelines

The switch also supports VRRPv2 for IPv4. If you configure VRRP IPv6 on an interface, it runs independently of the IPv4 version. Configure the version of the VRRP IPv4 on the interface before you configure any other IPv4 VRRP attributes. By default, the version is not configured to a particular value. However, when sourcing older configuration files that do not have the version saved, the router configures the version to VRRPv2 by default. If you change the version, all IPv4 configuration under that interface is automatically removed, and you are prompted for a confirmation before this operation.

Perform the CLI configuration through `ip vrrp` or `ipv6 vrrp` nodes; CLI commands for IPv4 are common for version 2 and version 3.

The following list identifies the features that make both IPv4 and IPv6 VRRPv3 features compliant to RFC 5798:

- Advertisement vs Fast-advertisement — Prior to RFC 5798, the minimum advertisement interval was 1 second, with Fast-advertisement a sub-second interval could be configured. When this feature is enabled, the VRRP ADVERTISEMENT packets are sent with type 7 instead of 1. With RFC 5798 the sub-second interval is standardised, and the switch sends all packets for VRRPv3 with type 1. The use of Fast-advertisement remains the same. VRRPv2 packets send with type 7, if Fast-advertisement is enabled.
- Add Master-advertisement-interval — Prior to RFC 5798 compliance, all virtual routers on the same VLAN had the same Advertisement-Interval configured. RFC 5798 states that you can use different Advertisement Intervals on the Master and Backup. On the Master, the Master-advertisement-interval and the Advertisement-Interval have the same value. On the Backup, the Master-advertisement-interval is used to calculate the timers, and the locally configured Advertisement-Interval is ignored until the Backup transitions to Master. The Master-advertisement-interval value is put in the advertisement packet type sent by the Master
- Transition to master as specified in RFC 5798 — Prior to RFC 5798, if a Backup receives an advertisement with a lower priority (or same priority but lower IP), it immediately sends its own advertisement and transitions to Master. However, RFC 5798 states that such packets must be discarded, which means it will transition to Master after the Master_Down_Timer expires
- Add skew-time — RFC 5798 states that skew-time is calculated depending on the priority, and Master-advertisement-interval assures that the Backup with highest priority sends the first advertisement when the Master goes down

Skew time is calculated using the formula: $((256 - \text{priority}) * \text{Master_Adver_Interval}) / 256$.

- Add preempt-mode — Preempt-mode is different from the `ipv6 vrrp <vrid> action preempt` command, which is an operational command issued when you want to stop the hold-down timer. RFC 5798 states that preempt-mode should be set to false when you do not want a higher priority Backup to transition to Master. By default, it is set to true

*** Note:**

Accept-mode is not fully implemented for IPv4 VRRPv3. You can only ping the virtual IP address, the same way as it is for IPv4 VRRPv2.

VRRP configuration using the CLI

Configuring the VRRP interface

Configure VRRP to provide fast failover of a default router for IPv6 LAN hosts, in order to create a VRRP instance.

Before you begin

- Assign an IPv6 address to the interface.
- Enable routing globally.
- Do not configure RSMLT on the VLAN.
- You must specify a link-local address to associate with the virtual router.

About this task

VRRP supports a virtual IPv6 address shared between two or more routers that connect the common subnet to the enterprise network.

VRRP for IPv6 provides a faster switchover to an alternate default router than is possible using the ND protocol.

Perform this procedure to also configure the additional addresses for which the virtual router acts as a backup.

Procedure

1. Enter Interface Configuration mode:

```
enable

configure terminal

interface GigabitEthernet {slot/port[/sub-port] [-slot/port[/sub-
port]] [, ...]} or interface vlan <1-4059>
```

* Note:

If your platform supports channelization and the port is channelized, you must also specify the sub-port in the format slot/port/sub-port.

2. Associate an address with the virtual router for either link-local or global:

- `ipv6 vrrp address <1-255> link-local WORD <0-127>`
- `ipv6 vrrp address <1-255> global WORD <0-255>`

* Note:

You must configure the link-local address before you configure the global address.

3. Enable VRRP for the interface:

```
ipv6 vrrp <1-255> enable
```

Example

Associate a link-local address with the virtual router ID 12:

```
Switch:1(config-if)#ipv6 vrrp address 12 link-local fe80::1234
```

Associate a global address with the virtual router ID 12

```
Switch:1(config-if)#ipv6 vrrp address 12 global 3333::1234/64
```

Enable VRRP for the interface:

```
Switch:1(config-if)#ipv6 vrrp 12 enable
```

Variable definitions

Use the data in the following table to use the **ipv6 vrrp address** command.

Variable	Value
<1-255>	Specifies the virtual router ID. The virtual router acts as the default router for one or more associated addresses.
enable	Enables IPv6 VRRP. The default is disabled.
global WORD <0-255>	Specifies a global IPv6 address and mask to associate with the virtual router.
link-local WORD <0-127>	Specifies a link-local IPv6 address to associate with the virtual router.

Use the data in the following table to use the **interface** command.

Variable	Value
<1-4059>	Specifies the VLAN ID in the range of 1 to 4059. By default, VLAN IDs 1 to 4059 are configurable and the system reserves VLAN IDs 4060 to 4094 for internal use. On switches that support the vrf-scaling and spbm-config-mode boot configuration flags, if you enable these flags, the system also reserves VLAN IDs 3500 to 3998. VLAN ID 1 is the default VLAN and you cannot create or delete VLAN ID 1.
{slot/port[/sub-port][/-slot/port[/sub-port]][,...]}	Identifies the slot and port in one of the following formats: a single slot and port (slot/port), a range of slots and ports (slot/port-slot/port), or a series of slots and ports (slot/port,slot/port,slot/port). If your platform supports channelization and the port is channelized, you must also specify the sub-port in the format slot/port/sub-port.

Viewing VRRP information

Display VRRP port or VLAN information to verify your configuration. Show VRRP information by IPv6 address or virtual router ID. If you enter a virtual router ID or an IPv6 address when you view VRRP information, the information applies only to that virtual router ID or for that interface.

Procedure

1. Enter Privileged EXEC mode:

```
enable
```

2. View the configuration information for all interfaces:

```
show ipv6 vrrp interface [verbose] [vrf WORD<1-16> | vrfids WORD<0-512>]
```

3. View the configuration information for one or more ports:

```
show ipv6 vrrp interface gigabitethernet {slot/port[/sub-port] [-slot/port[/sub-port]] [,...]} [verbose] [vrf WORD<1-16> | vrfids WORD<0-512>]
```

4. View the configuration information for one or more VLANs:

```
show ipv6 vrrp interface vlan [<1-4059>] [verbose] [vrf WORD<1-16> | vrfids WORD<0-512>]
```

5. View the configuration information for one or more virtual router IDs:

```
show ipv6 vrrp interface vrid <1-255> [verbose] [vrf WORD<1-16> | vrfids WORD<0-512>]
```

6. View VRRP address information:

```
show ipv6 vrrp address [vrf WORD<1-16> | vrfids WORD<0-512>]
```

7. View VRRP address information for a link-local address:

```
show ipv6 vrrp address link-local WORD<0-127> [verbose] [vrf WORD<1-16> | vrfids WORD<0-512>]
```

8. View VRRP address information for a virtual router ID:

```
show ipv6 vrrp address vrid <1-255> [vrf WORD<1-16> | vrfids WORD<0-512>]
```

Example

```
Switch:1>show ipv6 vrrp address
```

```
=====
                        VRRP Info - GlobalRouter
=====
VRID P/V   IP                               MAC                               STATE   CONTROL
-----
12    1/1   fe80:0:0:0:0:0:0:1234             00:00:5e:00:02:0c                Init   Disabled
```

VRRP

VRID	P/V	MASTER			PRIO	ADV	UP TIME	
12	1/1	0:0:0:0:0:0:0:0			100	1	0 day(s), 00:00:00	
VRID	P/V	CRITICAL IP			CRITICAL IP ENABLED		ACCEPT MODE	
12	1/1	0:0:0:0:0:0:0:0			No		disable	
VRID	P/V	BACKUP MASTER	BACKUP-MASTER STATE	FAST ADV	(ENABLED)	ACTION	HLD DWN	REM
12	1/1	disable	down	400	(YES)	none	30	0
VRID	P/V	GLOBAL ADDRESS						
12	1/1	1111::2222/64						

Flags Legend:
HLD DWN: Configured hold-down timer value, REM: REMaining hold-down timer value
--More-- (q = quit)

Switch:1#show ipv6 vrrp interface verbose

=====

Vlan Vrrp for IPv6 Extended

=====

VLAN	VRF	VRRP					
MASTER ID	NAME	ID	STATE	CONTROL	PRIORITY	IPADDR	
40	GlobalRouter	1	init	disable	100	0:0:0:0:0:0:0:0	
40	GlobalRouter	2	init	disable	100	0:0:0:0:0:0:0:0	

All 2 Vlan Vrrp Extended Entries out of 18 Total Num of Vrrp displayed

VLAN	VRF	VRRP			HOLDDWN	ACTION	CRITICAL
CRITICAL ID	NAME	ID	TIME	IP	ENABLE	IP ADDR	
40	GlobalRouter	1	0	none	disable	0:0:0:0:0:0:0:0	
40	GlobalRouter	2	0	none	disable	0:0:0:0:0:0:0:0	

All 2 Vlan Vrrp Extended Entries out of 18 Total Num of Vrrp displayed

VLAN	VRF	VRRP		BACKUP	ADVERTISE	FAST ADV	FAST ADV	MASTER ADV
PREEMPT ID	NAME	ID	MASTER	MASTER	INTERVAL	INTERVAL	ENABLE	INTERVAL
MODE			STATE	(s)	(ms)	(ms)		(ms)
40	GlobalRouter	1	disable	down	1	200	disable	1000
40	GlobalRouter	2	disable	down	1	200	disable	1000

All 2 Vlan Vrrp Extended Entries out of 18 Total Num of Vrrp displayed

```

=====
Port Vrrp for IPv6 Extended
=====
PORT VRF          VRRP
MASTER
NUM  NAME          ID  STATE  CONTROL PRIORITY
IPADDR
-----
1/23 GlobalRouter   1   init   disable 100      0:0:0:0:0:0:0
1/23 GlobalRouter   2   init   disable 100      0:0:0:0:0:0:0

```

All 2 Port Vrrp Extended Entries out of 18 Total Num of Vrrp displayed

```

PORT VRF          VRRP HOLDDWN ACTION  CRITICAL
CRITICAL
NUM  NAME          ID      TIME  IP ENABLE
IPADDR
-----
1/23 GlobalRouter   1    0     none  disable  0:0:0:0:0:0:0
1/23 GlobalRouter   2    0     none  disable  0:0:0:0:0:0:0

```

All 2 Port Vrrp Extended Entries out of 18 Total Num of Vrrp displayed

```

PORT VRF          VRRP BACKUP  BACKUP  ADVERTISE  FAST ADV  FAST ADV  MASTER ADV
PREEMPT
NUM  NAME          ID  MASTER  MASTER  INTERVAL  INTERVAL  ENABLE  INTERVAL
MODE
                                         STATE  (s)      (ms)
-----
1/23 GlobalRouter   1  disable down    1         200      disable  1000
enable
1/23 GlobalRouter   2  disable down    1         200      disable  1000
enable

```

All 2 Port Vrrp Extended Entries out of 18 Total Num of Vrrp displayed

Variable definitions

Use the data in the following table to use the **show ipv6 vrrp** commands.

Variable	Value
{slot/port[/sub-port][/-slot/port[/sub-port]][,...]}	Identifies the slot and port in one of the following formats: a single slot and port (slot/port), a range of slots and ports (slot/port-slot/port), or a series of slots and ports (slot/port,slot/port,slot/port). If your platform supports channelization and the port is channelized, you must also specify the sub-port in the format slot/port/sub-port.
link-local WORD<0-127>	Displays information by link-local IPv6 address.
verbose	Displays extended information.

Table continues...

Variable	Value
vlan [<i><1-4059></i>]	Specifies the VLAN ID in the range of 1 to 4059. By default, VLAN IDs 1 to 4059 are configurable and the system reserves VLAN IDs 4060 to 4094 for internal use. On switches that support the vrf-scaling and spbm-config-mode boot configuration flags, if you enable these flags, the system also reserves VLAN IDs 3500 to 3998. VLAN ID 1 is the default VLAN and you cannot create or delete VLAN ID 1.
vrid <i><1-255></i>	Displays information by virtual router ID.
vrf <i>WORD<1-16></i>	Specifies the VRF name.
vrfids <i>WORD<0-512></i>	Specifies the VRF ID.

Configuring VRRP notification control

Perform this procedure to configure VRRP notification control.

Before you begin

- Assign an IPv6 address to the interface.
- Enable routing globally.

About this task

By default, generation of SNMP traps for VRRP events is enabled.

Procedure

1. Enter VRRP Router Configuration mode:

```
enable
configure terminal
router vrrp
```
2. Enable the VRRP-router to generate SNMP traps for events:

```
ipv6 send-trap enable
```

Example

Disable generation of SNMP traps for VRRP events:

```
Switch:1(config-vrrp)#no ipv6 send-trap enable
```

Configuring additional VRRP parameters for an interface

Configure VRRP to provide fast failover of a default router for IPv6 LAN hosts. VRRP supports a virtual IPv6 address shared between two or more routers that connect the common subnet to the

enterprise network. VRRP for IPv6 provides a faster switchover to an alternate default router than is possible using the ND protocol.

Configure the parameters in this procedure if the default values do not meet your requirements.

Before you begin

- Assign an IPv6 address to the interface.
- Enable routing globally.
- Do not configure RSMLT on the VLAN.

About this task

A switch that acts as a VRRP master does not reply to SNMP get requests to the VRRP virtual interface address. The switch will, however, respond to SNMP get requests to the physical IP address.

Procedure

1. Enter Interface Configuration mode:

```
enable
configure terminal
interface GigabitEthernet {slot/port[/sub-port] [-slot/port[/sub-port]] [, ...]} or interface vlan <1-4059>
```

Note:

If your platform supports channelization and the port is channelized, you must also specify the sub-port in the format slot/port/sub-port.

2. Configure the accept mode of the master router:

```
ipv6 vrrp <1-255> accept-mode enable
```

3. Determine if the router overrides the holddown timer:

```
ipv6 vrrp <1-255> action <none|preempt>
```

4. Configure the interval between advertisement messages:

```
ipv6 vrrp <1-255> adver-int <1-40>
```

5. Enable the backup VRRP switch for traffic forwarding:

```
ipv6 vrrp <1-255> backup-master enable
```

6. Configure the IP interface on the local router:

```
ipv6 vrrp <1-255> critical-ipv6-addr WORD<0-46> [critical-ipv6 enable]
```

7. Configure the fast advertisement interval:

```
ipv6 vrrp <1-255> fast-adv enable [fast-adv-int <200-1000>]
```

8. Configure the holddown timer:

```
ipv6 vrrp <1-255> holddown-timer <0-21600>
```

9. Configure the priority for the VRRP router:

```
ipv6 vrrp <1-255> priority <1-255>
```

Example

Configure the fast advertisement interval:

```
Switch:1(config-if)#ipv6 vrrp 12 fast-adv enable fast-adv-int 400
```

Configure the holddown timer:

```
Switch:1(config-if)#ipv6 vrrp 12 holddown-timer 30
```

Variable definitions

Use the data in the following table to use the `ipv6 vrrp` command.

Variable	Value
<1-255>	Specifies a number that uniquely identifies a virtual router on a VRRP router. The virtual router acts as the default router for one or more assigned addresses.
accept-mode enable	Controls whether the VRRP master or backup master accepts packets (other than neighbor discovery packets) destined to the IPv6 address associated with the virtual router. The default value is disable.
action <none preempt>	Lists options to override the holddown timer manually and force preemption: <ul style="list-style-type: none"> • none does not override the timer. • preempt preempts the timer. This parameter applies only if the holddown timer is active.
adver-int <1-40>	Specifies the time interval, in seconds, between sending advertisement messages. The default is 1 second. Only the master router sends advertisements.
backup-master enable	Uses the backup VRRP switch for traffic forwarding. This option reduces the traffic on the v1ST. The default is disabled.
critical-ipv6 enable	Enables or disables the use of critical IP. When disabled, the VRRP ignores the availability of the address configured as critical IP. This address must be a local address. The default is disabled.
critical-ipv6-addrr WORD<0-46>	Specifies an IP interface on the local router configured so that a change in its state causes a role

Table continues...

Variable	Value
	switch in the virtual router (for example, from master to backup) in case the interface stops responding.
fast-adv enable	Enables or disables the fast advertisement interval. When disabled, the regular advertisement interval is used. The default is disable.
fast-adv-int <200-1000>	Configures the interval between VRRP advertisement messages. You must configure the same value on all participating routers. This unit of measure must be in multiples of 200 milliseconds. The default is 200.
holddown-timer <0-21600>	Configures the amount of time, in seconds, to wait before preempting the current VRRP master. The default is 0.
priority <1-255>	Specifies the priority value used by this VRRP router. The value 255 is reserved for the router that owns the IP addresses associated with the virtual router. The default is 100.

Enabling IPv6 VRRP preempt-mode

You can configure IPv6 VRRP to preempt the existing router. If a new VRRP router is added to the network with a higher priority than the existing routers, then the new router becomes the master. If preempt-mode is disabled, then the new router does not become a master, it transitions to master only when the current master is down. By default, preempt-mode is enabled.

Procedure

1. Enter Interface Configuration mode:

```
enable
configure terminal
interface GigabitEthernet {slot/port[/sub-port] [-slot/port[/sub-port]] [, ...]} or interface vlan <1-4059>
```

*** Note:**

If your platform supports channelization and the port is channelized, you must also specify the sub-port in the format slot/port/sub-port.

2. Enter the following command:

```
ipv6 vrrp <vrid> preempt-mode enable
```

3. Use the following command to set the IPv6 VRRP preempt-mode to its default value:

```
default ipv6 vrrp <vrid> preempt-mode
```

- Use the following command to disable the IPv6 VRRP preempt-mode:

```
no ipv6 <vrid> preempt-mode enable
```

Example

```
Switch:1> enable
Switch:1# configure terminal
Switch:1(config)# interface gigabitethernet 1/2
```

Enabling IPv6 VRRP preempt-mode for interface 1/2

```
Switch:1(config-if)# ipv6 vrrp 1 preempt-mode enable
```

Variable definitions

Use the data in the following table to use the `ipv6 vrrp <vrid>` command.

Variable	Value
enable	Enables preempt-mode for VRRPv3 for IPv6.
vrid <1–255>	Specifies the virtual router ID.

VRRP configuration using EDM

Configuring VRRP for an interface

Configure VRRP to provide fast failover of a default router for IPv6 LAN hosts. VRRP supports a virtual IPv6 address shared between two or more routers that connect the common subnet to the enterprise network. VRRP for IPv6 provides a faster switchover to an alternate default router than is possible using the ND protocol.

Perform this procedure to configure VRRP on either a brouter port or a VLAN.

Before you begin

- Assign an IPv6 address to the interface.
- Enable routing globally.
- Do not configure RSMLT on the VLAN.
- Change the VRF instance as required to configure a VRRP for an interface on a specific VRF instance. Not all parameters are configurable on non-default VRFs.

Procedure

- In the navigation pane, expand the following folders: **Configuration > IPv6**.
- Click **VRRP**.
- Click the **Interface** tab.
- Click **Insert**.

5. Beside the **IfIndex** field, click **Port** or **VLAN**.
6. In the Port Editor: IfIndex dialog box, select a port or VLAN.
7. Click **OK**.
8. Type the virtual router ID.
9. To control the packets sent to the IPv6 address associated to the virtual router, select the **AcceptMode** check box.
10. Type the primary IP address.
11. Click **Insert**.

Interface field descriptions

Use the data in the following table to use the **Interface** tab.

Name	Description
IfIndex	Shows the index value that uniquely identifies the interface to which this entry applies.
InetAddrType	Specifies the address type for the VRRP interface.
VrId	Specifies a number that uniquely identifies a virtual router on a VRRP router.
PrimaryIpAddr	Specifies the link-local address assigned to the VRRP.
VirtualMacAddr	Specifies the MAC address of the virtual router interface.
State	Shows the state of the virtual router interface. The possible states are <ul style="list-style-type: none"> • initialize—waiting for a startup event • backup—monitoring availability and state of the master router • master—functioning as the forwarding router for the virtual router IP addresses
Control	Displays whether VRRP is enabled or disabled for the port or VLAN.
Priority	Specifies the priority value used by this VRRP router. The value 255 is reserved for the router that owns the IP addresses associated with the virtual router. The default is 100.
AdvInterval	Specifies the time interval, in seconds, between sending advertisement messages. The default is 1 second.
MasterIpAddr	Specifies the IP address of the physical interface of the Master's virtual router.

Table continues...

Name	Description
UpTime	Indicates the time interval since this virtual router exited the INIT state.
CriticalIpAddr	Indicates the IP address of the interface that is critical to VRRP. If that IP interface is down, the VRRP state will transition to Backup, even if it has higher priority.
CriticalIpAddrEnabled	Enables or disables the use of critical IP. When disabled, the VRRP ignores the availability of the address configured as critical IP. This address must be a local address. The default is disabled.
BackUpMaster	Uses the backup VRRP switch for traffic forwarding. This option reduces the traffic on the v1ST. The default is disabled.
BackUpMasterState	Indicates if the Backup-Master is up. If the switch is in Master state, but Backup-Master is enabled, then the BACKUP MASTER STATE will be down.
FasterAdvIntervalEnabled	Enables or disables the fast advertisement interval. When disabled, the regular advertisement interval is used. The default is disable.
FasterAdvInterval	Configures the interval between VRRP advertisement messages. The default is 200. Enter the values in multiples of 200 milliseconds.
AcceptMode	Controls whether the VRRP master or backup master accepts packets (other than neighbor discovery packets) destined to the IPv6 address associated with the virtual router. The default value is disable.
PreemptMode	Issued to preempt the existing router. If a new router is added to the network with its priority higher than the existing routers, then the new router becomes the master. The default is enabled.
Action	Lists options to override the hold-down timer manually and force preemption: <ul style="list-style-type: none"> • none does not override the timer. • preemptHoldDownTimer preempts the timer. This parameter applies only if the holddown timer is active.
HoldDownTimer	Configures the amount of time, in seconds, to wait before preempting the current VRRP master. The default is 0.
HoldDownTimeRemaining	Indicates the amount of time, in seconds, left before the HoldDownTimer expires.

Table continues...

Name	Description
MasterAdvInterval	On the VRRP master, the master advertisement interval is same as the advertisement interval. On the VRRPv3 Backup, the master advertisement interval is set to the Advertisement configured on the Master (received in the packet).

Configuring VRRP notification control

Perform this procedure to configure VRRP notification control.

Before you begin

- Assign an IPv6 address to the interface.
- Enable routing globally.
- Change the VRF instance as required to configure VRRP notification control on a specific VRF instance. Not all parameters are configurable on non-default VRFs.

Procedure

1. In the navigation tree, expand the following folders: **Configuration > IPv6**.
2. Click **VRRP**.
3. Click the **Globals** tab.
4. Select **enabled**.
5. Click **Apply**.

Globals field descriptions

Use the data in the following table to use the **Globals** tab.

Name	Description
NotificationCntrl	Indicates whether the VRRP-enabled router generates SNMP traps for events. <ul style="list-style-type: none"> • enabled: Generate SNMP traps. • disabled: Do not generate SNMP traps. The default is enabled.

Configuring additional addresses on the VRRP router port

Perform this procedure to configure the additional addresses for which the virtual router acts as a back up.

Before you begin

- Assign an IPv6 address to the interface.
- Enable routing globally.

Procedure

1. In the navigation pane, expand the following folders: **Configuration > Edit > Port**.
2. Click **IPv6**.
3. Click the **VRRP** tab.
4. Click **AssociatedIPAddr**.
5. Click **Insert**.
6. Type the address.
7. Type the prefix length.
8. Click **Insert**.

Configuring additional addresses on the VRRP interface

Perform this procedure to configure the additional addresses for which the virtual router acts as a back up.

Before you begin

- Assign an IPv6 address to the interface.
- Enable routing globally.
- Do not configure RSMLT on the VLAN.
- Change the VRF instance as required to configure additional addresses on the VRRP interface on a specific VRF instance. Not all parameters are configurable on non-default VRFs.

Procedure

1. In the navigation tree, expand the following folders: **Configuration > IPv6**.
2. Click **VRRP**.
3. Click the **Interface** tab.
4. Select an interface.
5. Click **AssociatedIPAddr**.
6. Click **Insert**.
7. Type the address.
8. Type the prefix length.
9. Click **Insert**.

Address List field descriptions

Use the data in the following table to use the **Address List** tab.

Name	Description
IpAddr	Specifies an IP address that is associated with a virtual router. The number of rows on this tab equals the number of IP addresses associated (backed up) by the virtual router
IpAddrPrefixLength	Specifies the length of the prefix in bits.

Chapter 10: RSMLT

This chapter provides concepts and procedures to complete IPv6 Routed Split MultiLink Trunking (RSMLT) configuration.

RSMLT

Routed Split Multi-Link Trunking (RSMLT) is an enhancement to SMLT that enables the exchange of Layer 3 information between peer nodes in a switch cluster. RSMLT provides two main advantages over SMLT:

- provides backup for the peer after the peer goes down
- routes traffic on behalf of the peer to prevent Virtual Inter-Switch Trunk (vIST) overload

IPv6 RSMLT enables the subsecond failover for IPv6 forwarding.

The overall model for IPv6 RSMLT is essentially identical to that of IPv4 RSMLT. In short, RSMLT peers exchange their IPv6 configuration and track their states by using vIST messages. An RSMLT node always performs IPv6 forwarding on the IPv6 packets destined to the MAC addresses of the peer. If an RSMLT node detects that the RSMLT peer is down, the node forwards IPv6 traffic destined to the IPv6 addresses of the peer.

With RSMLT enabled, an SMLT switch performs IP forwarding on behalf of the SMLT peer, which prevents IP traffic from being sent over the vIST.

IPv6 RSMLT supports the full set of topologies and features supported by IPv4 RSMLT, including SMLT triangles, squares, and SMLT full-mesh topologies, with routing enabled on the core VLANs.

Because you configure RSMLT on a VLAN, not at the IP layer, the configuration applies to both IPv4 and IPv6. You cannot enable or disable RSMLT on a VLAN for IPv6 but not IPv4; or for IPv4 but not IPv6.

With IPv6, you must configure the RSMLT peers to use the same set of IPv6 prefixes.

Supported routing protocols include the following:

- IPv6 static routes
- OSPFv3

For more information about the IPv4 RSMLT model, see *Configuring IPv4 Routing*. This section focuses on the differences between the IPv4 and IPv6 models.

IPv6 differences

The following list identifies ways in which the IPv6 implementation of RSMLT differs from the IPv4 implementation of RSMLT.

- After the switch begins to forward traffic on behalf of the peer, duplicate address detection (DAD) is not executed for the IPv6 address of the peer. The implementation assumes that the peer IPv6 address is already known to be unique.
- An RSMLT switch installs a neighbor entry for the peer IPv6 address immediately after the peer disappearance is detected, possibly while a route for the peer still exists. This action can result in packets destined to the peer IPv6 address being delivered to the CP for a short period of time.
- You cannot configure a vIST with IPv6 peer address
- In a dual-stack VLAN, adding or deleting IPv4 or IPv6 does not affect the RSMLT functionality of one another. If you add IPv4 or IPv6 to an existing IPv6 or IPv4 RSMLT VLAN, the RSMLT state for the protocol you add second will be the same as the previous RSMLT state.

RSMLT configuration using the CLI

Configuring RSMLT on a VLAN

Configure RSMLT on a VLAN to exchange Layer 3 information between peer nodes in a switch cluster. This configuration applies to both IPv4 and IPv6.

Before you begin

- An IP routing protocol is enabled on VLAN Layer 3 interfaces.
- VLANs with Layer 3 interfaces participate in Split MultiLink Trunking (SMLT).

About this task

The VLAN can be either IPv4 or IPv6, or both. RSMLT configuration on a VLAN simultaneously affects both IPv4 and IPv6. By default, RSMLT is disabled on a VLAN.

Procedure

1. Enter VLAN Interface Configuration mode:

```
enable
configure terminal
interface vlan <1-4059>
```

2. Configure the holddown timer:

```
ip rsmlt holddown-timer <0-3600>
```

3. Configure the holdup timer:

```
ip rsmlt holdup-timer <0-9999>
```

4. Enable RSMLT on the VLAN:

```
ip rsmlt
```

Example

Configure the holddown timer:

```
Switch:1(config-if)#ip rsmlt holddown-timer 100
```

Configure the holdup timer:

```
Switch:1(config-if)#ip rsmlt holdup-timer 200
```

Enable RSMLT on the VLAN:

```
Switch:1(config-if)#ip rsmlt
```

Variable definitions

Use the data in the following table to use the `ip rsmlt` command.

Variable	Value
holddown-timer <0-3600>	<p>Defines how long the recovering or restarting system remains in a non-Layer 3 forwarding mode for the peer router MAC address. The default is 60.</p> <p>If you disable RSMLT on a VLAN, non default values for this variable do not save across restarts.</p>
holdup-timer <0-3600 9999>	<p>Defines how long the RSMLT system maintains forwarding for its peer. The value is a range from 0 to 3600 seconds or 9999. 9999 means infinity. The default is 1800.</p> <p>If you disable RSMLT on a VLAN, non default values for this variable do not save across restarts.</p>

Use the data in the following table to use the `interface` command.

Variable	Value
<1-4059>	<p>Specifies the VLAN ID in the range of 1 to 4059. By default, VLAN IDs 1 to 4059 are configurable and the system reserves VLAN IDs 4060 to 4094 for internal use. On switches that support the vrf-scaling and spbm-config-mode boot configuration flags, if you enable these flags, the system also reserves VLAN IDs 3500 to 3998. VLAN ID 1 is the default VLAN and you cannot create or delete VLAN ID 1.</p>

Enabling RSMLT Edge support

Enable RSMLT Edge support to store the RSMLT peer MAC and IP address-pair in the local configuration file and restore the configuration if the peer does not restore after a simultaneous restart of both RSMLT peer systems.

About this task

RSMLT Edge support configuration applies to both IPv4 and IPv6. You do not configure IPv4 and IPv6 separately.

The RSMLT Edge support default is disabled.

Procedure

1. Enter Global Configuration mode:

```
enable
configure terminal
```

2. Enable RSMLT Edge support:

```
ip rsmlt edge-support
```

Example

If you have enabled RSMLT Edge Support, disable the feature as follows:

```
Switch:1(config)#no ip rsmlt edge-support
```

Viewing RSMLT information

Show RSMLT information to view data about all RSMLT interfaces. The output of the command includes IPv6 information for the local and peer nodes.

Procedure

1. Enter Privileged EXEC mode:

```
enable
```

2. Show RSMLT information about the interface:

```
show ip rsmlt [local|peer] [vrf WORD<1-16>] [vrfids WORD<0-512>]
```

3. View the status of the switch to act as a peer forwarder:

```
show ip rsmlt edge-support
```

Example

```
Switch:1>show ip rsmlt
```

```
=====
Ip Rsmlt Local Info - GlobalRouter
=====
```

RSMLT

VID	IP	MAC	ADMIN	OPER	HDTMR	HUTMR
101	101.1.1.32	00:24:7f:9e:da:01	Enable	Up	100	200
102	102.1.1.32	00:24:7f:9e:da:02	Enable	Up	60	180

VID	SMLT ID
101	101
102	102

VID	IPv6	MAC	ADMIN	OPER	HDTMR	HUTMR
101	1010:0:0:0:0:0:0:0/64 1010:0:0:0:0:0:0:32/64 fe80:0:0:0:224:7fff:fe9e:da01/128	00:24:7f:9e:da:01	Enable	Up	100	200
102	1020:0:0:0:0:0:0:0/64 1020:0:0:0:0:0:0:32/64 fe80:0:0:0:224:7fff:fe9e:da02/128	00:24:7f:9e:da:02	Enable	Up	60	180

VID	SMLT ID
101	101
102	102

Ip Rsmлт Peer Info - GlobalRouter

VID	IP	MAC	ADMIN	OPER	HDTMR	HUTMR
101	101.1.1.33	00:24:7f:9e:ea:01	Enable	Up	100	200
102	102.1.1.33	00:24:7f:9e:ea:00	Enable	Up	60	180

VID	HDT REMAIN	HUT REMAIN	SMLT ID
101	60	180	101
102	60	180	102

VID	IPv6	MAC	ADMIN	OPER	HDTMR	HUTMR
101	1010:0:0:0:0:0:0:0/64 1010:0:0:0:0:0:0:33/64 fe80:0:0:0:224:7fff:fe9e:ea01/128	00:24:7f:9e:ea:01	Enable	Up	100	200
102	1020:0:0:0:0:0:0:0/64 1020:0:0:0:0:0:0:33/64 fe80:0:0:0:224:7fff:fe9e:ea00/128	00:24:7f:9e:ea:00	Enable	Up	60	180

VID	HDT REMAIN	HUT REMAIN	SMLT ID
101	60	180	101
102	60	180	102

```
Switch:1>show ip rsmlt edge-support
RSMLT Peer Info:
  rsmlt-peer-forwarding : disable
```

Variable definitions

Use the data in the following table to use the `show ip rsmlt` command.

Variable	Value
local	Shows local RSMLT information.
peer	Shows RSMLT information for the peer.
vrf <i>WORD</i> <1-16>	Shows information for a specific VRF name.
vrfids <i>WORD</i> <0-512>	Shows information for a specific VRF ID.

RSMLT configuration using EDM

Configuring RSMLT on a VLAN

Configure RSMLT on a VLAN to exchange Layer 3 information between peer nodes in a switch cluster. This configuration applies to both IPv4 and IPv6.

Before you begin

- Enable an IP routing protocol on VLAN Layer 3 interfaces.
- Ensure VLANs with Layer 3 interfaces participate in Split MultiLink Trunking (SMLT).

About this task

The VLAN can be either IPv4 or IPv6, or both. RSMLT configuration on a VLAN simultaneously affects both IPv4 and IPv6.

Procedure

1. In the navigation tree, expand the following folders: **Configuration > VLAN**.
2. Click **VLANs**.
3. Click the **Basic** tab.
4. Select a VLAN.
5. Click **IP**.
6. Click the **RSMLT** tab.
7. Select **Enable**.

8. In the **HoldDownTimer** field, type a hold-down timer value.
9. In the **HoldUpTimer** field, type a holdup timer value.
10. Click **Apply**.

RSMLT field descriptions

Use the data in the following table to use the **RSMLT** tab.

Name	Description
Enable	Enables RSMLT. The default is disabled.
HoldDownTimer	<p>Defines how long the recovering or restarting system remains in a non-Layer 3 forwarding mode for the peer router MAC address.</p> <p>The range of this value is from 0 to 3600 seconds. The default is 60.</p> <p>If you disable RSMLT on a VLAN, non default values for this field do not save across restarts.</p>
HoldUpTimer	<p>Defines how long the RSMLT system maintains forwarding for its peer. The value is a range from 0 to 3600 seconds or 9999. 9999 means infinity. The default is 1800.</p> <p>If you disable RSMLT on a VLAN, non default values for this field do not save across restarts.</p>

Enabling RSMLT Edge support

Enable RSMLT Edge support to store the RSMLT peer MAC and IP address-pair in the local configuration file and restore the configuration if the peer does not restore after a simultaneous restart of both RSMLT peer systems.

The default is disabled.

About this task

RSMLT Edge support configuration applies to both IPv4 and IPv6.

Procedure

1. In the navigation pane, expand the following folders: **Configuration > IP**.
2. Click **RSMLT**.
3. Click the **Globals** tab.
4. Select **EdgeSupportEnable**.
5. Click **Apply**.

Modifying the RSMLT local information

Edit the existing RSMLT configuration for the local node in the cluster.

Procedure

1. In the navigation tree, expand the following folders: **Configuration > IPv6**.
2. Click **RSMLT**.
3. Click the **Local** tab.
4. Double-click a cell to change the value.
5. Click **Apply**.

Local field descriptions

Use the data in the following table to use the **Local** tab.

Name	Description
IfIndex	Shows the route SMLT operation index.
Ipv6Addr	Configures the IPv6 address of the RSMLT interface.
Ipv6PrefixLength	Configures the IPv6 prefix length.
Enable	Enables or disables RSMLT. The default is disabled.
HoldDownTimer	Defines how long the recovering/rebooting switch remains in a non-Layer 3 forwarding mode for the peer router MAC address. The default is 60.
HoldUpTimer	Defines how long the RSMLT switch maintains forwarding for its peer. The value is a range from 0 to 3600 seconds or 9999. 9999 means infinity. The default is 1800.
OperStatus	Displays the RSMLT operating status as either up or down.
SmltId	Specifies the ID range for the SMLT.
VlanId	Configures the VLAN ID.
MacAddr	Configures the MAC address of the VLAN.
VrfId	Indicates the virtual router ID to which the local RSMLT instance belongs.
VrfName	Indicates the virtual router name to which the local RSMLT instance belongs.

Modifying RSMLT peer information

Edit the existing configuration for the RSMLT peer node in the cluster.

Procedure

1. In the navigation tree, expand the following folders: **Configuration > IPv6**.
2. Click **RSMLT**.
3. Click the **Peer** tab.
4. Double-click a cell to change the value.
5. Click **Apply**.

Peer field descriptions

Use the data in the following table to use the **Peer** tab.

Name	Description
IfIndex	Shows the route SMLT operation index.
Ipv6Addr	Configures the IPv6 address of the RSMLT interface.
Ipv6PrefixLength	Configures the IPv6 prefix length.
AdminStatus	Shows the administrative status of RSMLT on the peer.
HoldDownTimer	Defines how long the recovering/rebooting switch remains in a non-Layer 3 forwarding mode for the peer router MAC address. The default is 0.
HoldDownTimeRemaining	Indicates the time remaining in the HoldDownTimer.
HoldUpTimer	Defines how long the RSMLT switch maintains forwarding for its peer. The value is a range from 0 to 3600 seconds or 9999. 9999 means infinity. The default is 0.
HoldUpTimeRemaining	Indicates the time remaining in the HoldUpTimer.
OperStatus	Displays the RSMLT operating status as either up or down.
SmltId	Specifies the ID range for the SMLT.
VlanId	Specifies the VLAN ID in the range of 1 to 4059. By default, VLAN IDs 1 to 4059 are configurable and the system reserves VLAN IDs 4060 to 4094 for internal use. On switches that support the vrf-scaling and spbm-config-mode boot configuration flags, if you enable these flags, the system also reserves VLAN

Table continues...

Name	Description
	IDs 3500 to 3998. VLAN ID 1 is the default VLAN and you cannot create or delete VLAN ID 1.
MacAddr	Configures the MAC address of the VLAN.
VrfId	Indicates the virtual router ID to which the peer belongs.
VrfName	Indicates the virtual router name to which the peer belongs.

Viewing RSMLT Edge peers

View the RSMLT peers for which the switch acts as a peer forwarder.

Procedure

1. In the navigation tree, expand the following folders: **Configuration > IPv6**.
2. Click **RSMLT**.
3. Click the **Edge Peers** tab.

Edge Peers field descriptions

Use the data in the following table to use the **Edge Peers** tab.

Name	Description
PeerVlanId	Specifies the ID of the VLAN associated with this entry.
PeerIpv6Address	Specifies the IPv6 address of the peer RSMLT interface.
PeerIpv6PrefixLength	Specifies the peer IPv6 address prefix.
PeerMacAddress	Specifies the peer MAC address.

Chapter 11: Viewing IPv6 connections

This chapter provides procedures you can use to view IPv6 connection information.

You can establish network connectivity with the following protocols:

- Transmission Control Protocol (TCP), for connection-oriented sessions
- User Datagram Protocol (UDP), for connectionless sessions

When you view TCP information you can

- check the health of the connections, from the switch perspective, as they traverse the network
- detect intermittent connectivity
- detect attacks on resources
- determine which applications are active by checking the port numbers

UDP endpoint information tells you about local and remote UDP activity.

When you view UDP information you can

- determine which applications are active by checking the local and remote port numbers
- identify processes within a UDP session to allow multiplexing of a port mapping for UDP

Viewing IPv6 connections using CLI

Viewing TCP and UDP information

Perform this procedure to view the TCP and UDP configuration information for IPv6.

Procedure

1. Enter Privileged EXEC mode:

```
enable
```

2. Display IPv6 TCP connection information:

```
show ipv6 tcp connections [vrf WORD<1-16> | vrfids WORD<0-512>]
```

3. Display IPv6 TCP listener information for the specified IPv6 address:

```
show ipv6 tcp listener [vrf WORD<1-16> | vrfids WORD<0-512>]
```

4. Display IPv6 TCP properties

```
show ipv6 tcp properties [vrf WORD<1-16> | vrfids WORD<0-512>]
```

5. Display IPv6 TCP statistics

```
show ipv6 tcp statistics [vrf WORD<1-16> | vrfids WORD<0-512>]
```

6. Display IPv6 UDP information:

```
show ipv6 udp endpoints [vrf WORD<1-16> | vrfids WORD<0-512>]
```

Example

```
Switch:1>show ipv6 tcp connections
```

```
=====
                        TCP connection table info - GlobalRouter
=====
LOCALPORT    LOCALADDR      REMOTEPORT     REMOTEADDR     STATE
-----
21           0:0:0:0:0:0:0  0              0:0:0:0:0:0:0  listen
23           0:0:0:0:0:0:0  0              0:0:0:0:0:0:0  listen
```

```
Switch:1>show ipv6 tcp listener
```

```
=====
                        TCP listener table info - GlobalRouter
=====
LOCALPORT    LOCALADDR
-----
21           0:0:0:0:0:0:0
23           0:0:0:0:0:0:0
80           0:0:0:0:0:0:0
443          0:0:0:0:0:0:0
513          0:0:0:0:0:0:0
```

```
Switch:1#show ipv6 tcp properties
```

```
=====
                        TCP Global Properties - GlobalRouter
=====
RtoAlgorithm    constant
RtoMin           5002 milliseconds
RtoMax           60128 milliseconds
MaxConn         127
```

```
Switch:1#show ipv6 tcp statistics
```

```
=====
                        TCP Global Statistics - GlobalRouter
=====
ActiveOpens:    0
PassiveOpens:   5
AttemptFails:   0
EstabResets:    0
CurrEstab:      0
InSegs:         0
OutSegs:        0
RetransSegs:    0
InErrs:         0
OutRsts:        0
```

Viewing IPv6 connections

```
HCInSegs:      0
HCOutSegs:     0
```

```
Switch:1>show ipv6 udp endpoints
```

```
=====
                        UDP endpoint table info - GlobalRouter
=====
LOCALPORT   LOCALADDR
REMOTEPORT  REMOTEADDR          INSTANCE
PROCESS
-----
69          0:0:0:0:0:0:0:0
0           0:0:0:0:0:0:0:0    1220866096 0
161        0:0:0:0:0:0:0:0
0           0:0:0:0:0:0:0:0    1220867644 0
```

Viewing IPv6 connections using EDM

Viewing TCP global information

View TCP and UDP information to view the current configuration.

Before you begin

Change the VRF instance as required to view TCP global information on a specific VRF instance. Not all parameters are configurable on non-default VRFs.

About this task

The fields on the TCP global tab provide information about the handshake (SYN) configuration and the maximum number of TCP connections you can create on your system.

When you initiate a TCP connection, both end points send handshake information to create the channel.

The retransmission algorithm and fields display the configured timeout value and minimum and maximum retransmission times that your system uses to terminate a connection attempt that falls outside your specified parameters.

Procedure

1. In the navigation pane, expand the **Configuration > IPv6** folders
2. Click **TCP/UDP**.
3. Click the **TCP Globals** tab.

TCP Global field descriptions

Use the data in the following table to use the **TCP Globals** tab.

Name	Description
RtoAlgorithm	Determines the timeout value used for retransmitting unacknowledged octets.
RtoMin	Displays the minimum time (in milliseconds) permitted by a TCP implementation for the retransmission timeout.
RtoMax	Displays the maximum time (in milliseconds) permitted by a TCP implementation for the retransmission timeout.
MaxConn	Displays the maximum connections for the device.

Viewing TCP connections information

View information about TCP connections.

Before you begin

Change the VRF instance as required to view TCP connections information on a specific VRF instance. Not all parameters are configurable on non-default VRFs.

About this task

Among other things, the fields on the TCP connections tab provide important information about the health of connections that traverse your switch.

In particular, the state column lets you know the state of each TCP connection. Of these, synSent, synReceived, and established indicate whether or not a channel is established and listen indicates when an end system is waiting for a returning handshake (SYN).

Procedure

1. In the navigation pane, expand the **Configuration > IPv6** folders.
2. Click **TCP/UDP**.
3. Click the **TCP Connections** tab.

TCP Connections field descriptions

Use the data in the following table to use the **TCP Connections** tab.

Name	Description
LocalAddressType	Displays the type (IPv6 or IPv4) for the address in the LocalAddress field.
LocalAddress	Displays the IPv6 address for the TCP connection.
LocalPort	Displays the local port number for the TCP connection.
RemAddressType	Displays the type (IPv6 or IPv4) for the remote address of the TCP connection.

Table continues...

Name	Description
RemAddress	Displays the IPv6 address for the remote TCP connection.
RemPort	Displays the remote port number for the TCP connection.
State	Displays an integer that represents the state for the connection: <ul style="list-style-type: none"> • closed • listen • synSent • synReceived • established • finWait1 • finWait2 • closeWait • lastAck(9) • closing • timeWait • deleteTCB
Process	Displays the process ID for the system process associated with the TCP connection.

Viewing TCP listeners information

View TCP listener information.

Before you begin

Change the VRF instance as required to view TCP listeners information on a specific VRF instance. Not all parameters are configurable on non-default VRFs.

About this task

The TCP listeners table provides a detailed list of systems that are in the listening state.

When a connection is in the listen state an end point system is waiting for a returning handshake (SYN). The normal listening state should be very transient, changing all of the time.

Two or more systems going to a common system in an extended listening state indicates the need for further investigation.

End systems in an extended listening state can indicate a broken TCP connection or a DOS attack on a resource.

This type of DOS attack, known as a SYN attack, results from the transmission of SYNs with no response to return replies.

While many systems can detect a SYN attack, the TCP listener statistics can provide additional forensic information.

Procedure

1. In the navigation pane, expand the **Configuration > IPv6** folders.
2. Click **TCP/UDP**.
3. Click the **TCP Listeners** tab.

TCP Listeners field descriptions

Use the data in the following table to use the **TCP Listeners** tab.

Name	Description
LocalAddressType	Displays the type (IPv6 or IPv4) for the address in the LocalAddress field.
LocalAddress	Displays the IPv6 address for the TCP connection.
LocalPort	Displays the local port number for the TCP connection.
Process	Displays the process ID for the system process associated with the TCP connection.

Viewing UDP endpoint information

View UDP Endpoints to confirm correct configuration.

Before you begin

Change the VRF instance as required to view UDP endpoint information on a specific VRF instance. Not all parameters are configurable on non-default VRFs.

About this task

You can use UDP endpoint information to display local and remote UDP activity.

Since UDP is a protocol used to establish connectionless network sessions, you need to monitor local and remote UDP activity and to know which applications are running over UDP.

You can determine which applications are active by checking the port number.

Processes are further identified with a UDP session to allow for the multiplexing of a port mapping for UDP.

Procedure

1. In the navigation pane, expand the **Configuration > IPv6** folders.
2. Click **TCP/UDP**.
3. Click the **UDP Endpoints** tab.

UDP Endpoints field descriptions

Use the data in the following table to use the **UDP Endpoints** tab.

Name	Description
LocalAddressType	Displays the local address type (IPv6 or IPv4).
LocalAddress	Displays the local IPv6 address.
LocalPort	Displays the local port number.
RemoteAddressType	Displays the remote address type (IPv6 or IPv4).
RemoteAddress	Displays the remote IPv6 address.
RemotePort	Displays the remote port number.
Instance	Distinguishes between multiple processes connected to the UDP endpoint.
Process	Displays the ID for the UDP process.

Chapter 12: IPv6 Alternative Routes

This chapter provides concepts and procedures to complete IPv6 alternative routes configuration using the CLI.

Alternative routes

To avoid traffic interruption, you can globally enable the alternative routes feature so the router can use the next-best route, also known as an alternative route, if the best route becomes unavailable.

Routers learn routes to a destination through routing protocols. Routers maintain a routing table of the learned alternative routes sorted in order by route preference, route costs, and route sources. The first route on the list is the best route and the route that the router prefers to use.

The alternative route concept also applies between routing protocols. For example, if an OSPFv3 route becomes unavailable and an alternative RIPng route is available, the system activates the RIPng route without waiting for the update interval to expire.

Route preference

On the switch, all standard routing protocols have default preference values that determine the routing priority of the protocol. The router uses default preferences to select the best route when a clash exists in preference between the protocols.

You can modify the global preference for a protocol to give the protocol a higher or lower priority than other protocols. If you change the global preference for a static route and all best routes remain best routes, only the local route tables change. However, if the protocol preference change causes best routes to no longer be best routes, the change affects neighboring route tables.

Important:

Changing route preferences is a process-intensive operation that can affect system performance and network reach while you perform route preference procedures. It is recommended that if you want to change preferences for static routes or routing protocols, do so when you configure routes or during a maintenance window.

If a router learns a route with the same network mask and cost values from multiple sources, the router uses the route preferences to select the best route to add to the forwarding database.

Note:

To modify the preference for a route, you do *not* need to disable a route before you edit the configuration.

Preferences for static routes

When you configure a static route on the switch, you can specify a global preference for the route. You can also specify an individual route preference that overrides the global static route preference. The preference value can be between 0 and 255, with 0 reserved for local routes and 255 representing an unreachable route.

Preferences for dynamic routes

You can modify the preference value for dynamic routes through route filtering and IP policies, and this value overrides the global preference for the protocol.

The following table shows the default preferences for routing protocols and route types. Use this table to help you modify the global preference value.

Table 8: Routing protocol default preferences

Protocol	Default preference
Local	0
Static	5
SPBM_L1	7
OSPF intra-area	20
OSPF inter-area	25
Exterior BGP	45
RIP/RIPng	100
OSPF external type 1	120
OSPF external type 2	125
IBGP	175
Staticv6	5
OSPFv3 intra-area	20
OSPFv3 inter-area	25
OSPFv3 external type 1	120
OSPFv3 external type 2	125

Configuring IPv6 alternative routes

Use this procedure to configure IPv6 alternative routes and view the configuration on the switch.

Procedure

1. Enter either Global Configuration mode or VRF Router Configuration mode for a specific VRF context:

```
enable
```



```
configure terminal
router vrf WORD<1-16>
```

2. Configure an IPv6 alternative route:

```
ipv6 alternative-route
```

* Note:

IPv6 alternative routes are enabled by default.

3. Verify the configuration of the IPv6 alternative route:

```
show ipv6 global [vrf WORD<1-16> | vrfids WORD<0-512>]
show ipv6 route alternative [vrf WORD<1-16> | vrfids WORD<0-512>]
```

Example:

```
Switch:1>enable
Switch:1#configure terminal
Switch:1(config)#router vrf globalRouter
Switch:1(router-vrf)#ipv6 alternative-route
```

```
Switch:1#show ipv6 global
```

```
=====
                        IPv6 Global Information - GlobalRouter
=====
forwarding                : enable
default-hop-cnt           : 64
number-of-interfaces      : 0
icmp-error-interval       : 1000
icmp-error-quota          : 50
icmp-unreach-msg          : disable
icmp-addr-unreach-msg     : enable
icmp-port-unreach-msg     : enable
icmp-echo-multicast-request : enable
static-route-admin-status : enable
alternative-route         : enable
ecmp                       : disable
ecmp-max-path             : 1
source-route              : disable
host-autoconfig           : disable
```

```
Switch:1#show ipv6 route alternative
```

```
=====
                        IPv6 Routing Table Information - GlobalRouter
=====
Destination Address/PrefixLen  NEXT HOP                VID/BID/TID  PROTO  COST  AGE  TYPE  PREF
-----
0:0:0:0:0:ffff:301:a02/128    0:0:0:0:0:0:0:0:0      T-10        STATIC  1    0    B    5
2910:0:0:1:0:0:0:0/64        fe80:0:0:0:b2ad:aaff:fe42:dd00  V-3         OSPF   2    0    B    20
2912:0:0:1:0:0:0:0/64        0:0:0:0:0:0:0:0:0      V-1001      LOCAL  1    0    B    0
2912:0:0:1:0:0:0:0/64        0:0:0:0:0:0:0:0:0      T-10        BGP    1    0    A    45
2912:0:0:1:0:0:12:1/128     0:0:0:0:0:0:0:0:0      V-1001      LOCAL  1    0    B    0
3000:0:0:1:0:0:0:0/64        0:0:0:0:0:0:0:0:0      V-3         LOCAL  1    0    B    0
3000:0:0:1:0:0:12:1/128     0:0:0:0:0:0:0:0:0      V-3         LOCAL  1    0    B    0
4001:0:0:1:0:0:0:0/64        0:0:0:0:0:0:0:0:0      T-10        LOCAL  1    0    B    0
4001:0:0:1:0:0:0:1/128     0:0:0:0:0:0:0:0:0      T-10        LOCAL  1    0    B    0
5910:0:0:1:0:0:0:0/64        0:0:0:0:0:0:0:0:0      T-10        BGP    1    0    B    45
5910:0:0:1:0:0:0:0/64        fe80:0:0:0:b2ad:aaff:fe42:dd00  V-3         OSPF   2    0    A    120
5910:0:0:2:0:0:0:0/64        0:0:0:0:0:0:0:0:0      T-10        BGP    1    0    B    45
5910:0:0:2:0:0:0:0/64        fe80:0:0:0:b2ad:aaff:fe42:dd00  V-3         OSPF   2    0    A    120
=====
```

IPv6 Alternative Routes

13 out of 13 Total Num of Route Entries displayed.

TYPE Legend:

A=Alternative Route, B=Best Route, E=Ecmp Route

Chapter 13: IPv6 configuration examples

The following sections show configuration examples for IPv6 deployment options.

IPv6 tunnels

This section shows examples of manually configured tunnels between router ports and VLANs.

Between router ports

The following figure shows the tunnel configuration between router ports.

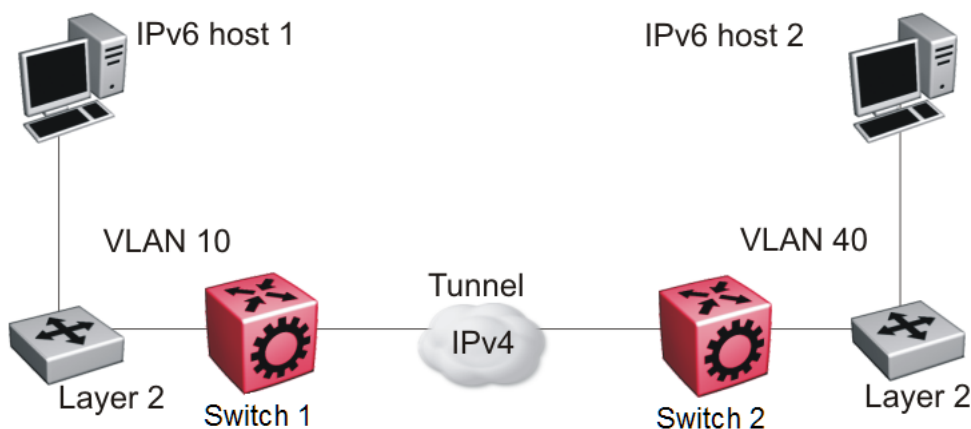

Figure 12: Tunnel configuration between router ports

You must configure static routes, RIP, or OSPF on both the source (Switch 1) and destination (Switch 2) IPv4 interfaces to communicate on the IPv4 network. You must configure IPv4 addresses on the source and destination.

On the source device:

Create an IPv6 VLAN and add ports to the VLAN.

```
vlan create 10 type port-mstprstp 0
vlan mlt 10 4
vlan members 10 1/1 portmember
interface vlan 10
ipv6 interface
ipv6 interface enable
```

IPv6 configuration examples

```
ipv6 interface address 4000:0:0:0:0:0:0:1/64
exit
```

Create an IPv4 router port and enable OSPF on the port.

```
interface GigabitEthernet 1/30
brouter port 1/30 vlan 1000 subnet 172.21.80.1/255.255.255.0 mac-offset
6
```

Create the tunnel from the source to the destination.

```
ipv6 tunnel 1 source 172.21.80.1 address 2500:0000:0000:0000:0000:0000:0000:0001/64
destination 192.168.20.1
```

Configure a static route on the source.

```
ipv6 route 4000:0:0:0:0:0:0:2/64 cost 1 tunnel 1
```

Optionally, you can create an OSPFv3 interface through the tunnel.

```
router ospf ipv6-enable
router ospf
ipv6 tunnel 1 area 0.0.0.0
ipv6 tunnel 1 enable
exit
```

On the destination device:

Create an IPv6 VLAN and add ports to the VLAN.

```
vlan create 40 type port-mstprstp 0
vlan mlt 40 4
vlan members 40 1/2 portmember
interface vlan 40
ipv6 interface
ipv6 interface enable
ipv6 interface address 4000:0:0:0:0:0:0:2/64
exit
```

Create an IPv4 router port and enable OSPF on the port.

```
interface GigabitEthernet 1/30
brouter port 1/30 vlan 2000 subnet 192.168.20.1/255.255.255.0 mac-offset 6
```

Create the tunnel from the destination to the source.

```
ipv6 tunnel 1 source 192.168.20.1 address 2500:0000:0000:0000:0000:0000:0000:0002/64
destination 172.21.80.1
```

Configure a static route on the destination.

```
ipv6 route 4000:0:0:0:0:0:0:1/64 cost 1 tunnel 1
```

Optionally, you can create an OSPFv3 interface through the tunnel.

```
router ospf ipv6-enable
router ospf
ipv6 tunnel 1 area 0.0.0.0
ipv6 tunnel 1 enable
exit
```

Between VLANs

The following figure shows the tunnel configuration between VLANs.

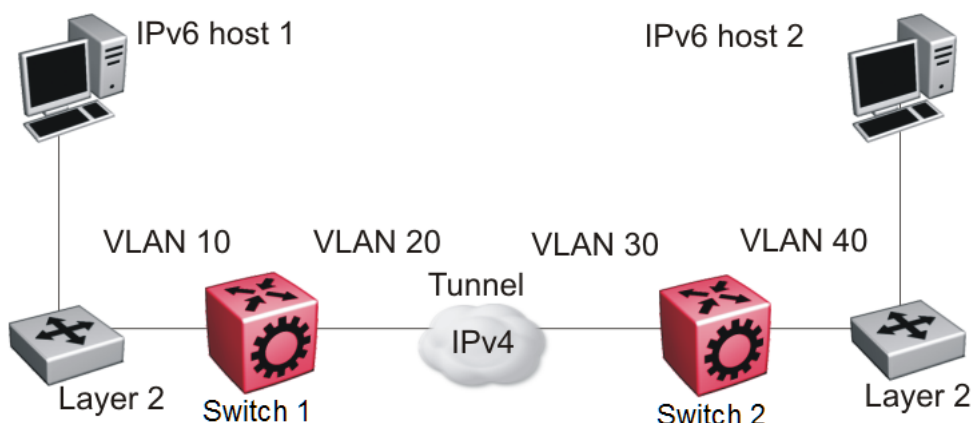

Figure 13: Tunnel configuration between VLANs

You must configure static routes, and either RIP or OSPF on both the source (Switch 1) and destination (Switch 2) IPv4 interfaces to communicate on the IPv4 network. You must configure IPv4 addresses on the VLANs.

On the source device:

Create an IPv6 VLAN and add ports to the VLAN.

```
vlan create 10 type port-mstprstp 0
vlan mlt 10 4
vlan members 10 1/1 portmember
interface vlan 10
ipv6 interface
ipv6 interface enable
ipv6 interface address 4000:0:0:0:0:0:0:1/64
exit
```

Create an IPv4 VLAN, add ports to the VLAN, and enable OSPF on the VLAN.

```
vlan create 20 type port-mstprstp 0
vlan mlt 20 4
vlan members 20 1/30 portmember
interface vlan 20
ip address 172.21.80.1 255.0.0.0
ip ospf enable
exit
```

Create the tunnel from the source to the destination.

```
ipv6 tunnel
1 source 172.21.80.1 address 2500:0000:0000:0000:0000:0000:0000:0001/64
destination 192.168.20.1
```

On the destination device:

Create an IPv6 VLAN and add ports to the VLAN.

```
vlan create 40 type port-mstprstp 0
vlan mlt 40 4
vlan members 40 1/2 portmember
interface vlan 40
ipv6 interface
ipv6 interface enable
```

IPv6 configuration examples

```
ipv6 interface address 4000:0:0:0:0:0:0:2/64
exit
```

Create an IPv4 VLAN , add ports to the VLAN, and enable OSPF on the VLAN.

```
vlan create 30 type port-mstprstp 0
vlan mlt 30 4
vlan members 30 1/30 portmember
interface vlan 30
ip address 192.168.20.1 255.0.0.0
ip ospf enable
exit
```

Create the tunnel from the destination to the source.

```
ipv6 tunnel 1 source 192.168.20.1 address 2500:0000:0000:0000:0000:0000:0002/64
destination 172.21.80.1
```

Verification

On the source device:

```
Switch:1(config)#show ipv6 tunnel 1 detail
=====
Tunnel Interface Information
=====
ID          LOCAL ADDRESS  REMOTE ADDRESS  OPER STATUS  TYPE
-----
1           172.21.80.1   192.168.20.1   active       manual
-----
1 out of 1 Total number of entries displayed.
-----

=====
Address Information
=====
IPV6 ADDRESS                                TYPE  ORIGIN  STATUS
-----
2500:0:0:0:0:0:0:1                          UNICAST MANUAL  PREFERRED
fe80:0:0:0:0:0:0:ac15:5001                  UNICAST LINKLAYER PREFERRED
-----
2 out of 2 Total number of entries displayed.
```

On the destination device:

```
Switch:1(config)#show ipv6 tunnel 1 detail
=====
Tunnel Interface Information
=====
ID          LOCAL ADDRESS  REMOTE ADDRESS  OPER STATUS  TYPE
-----
1           192.168.20.1  172.21.80.1   active       manual
-----
1 out of 1 Total number of entries displayed.
-----

=====
Address Information
=====
IPV6 ADDRESS                                TYPE  ORIGIN  STATUS
-----
```

```
-----
2500:0:0:0:0:0:0:2          UNICAST MANUAL    PREFERRED
fe80:0:0:0:0:0:0:c0a8:1401 UNICAST LINKLAYER PREFERRED
```

2 out of 2 Total number of entries displayed.

OSPFv3

This section shows an example of OSPFv3 configuration. The following figure shows the network.

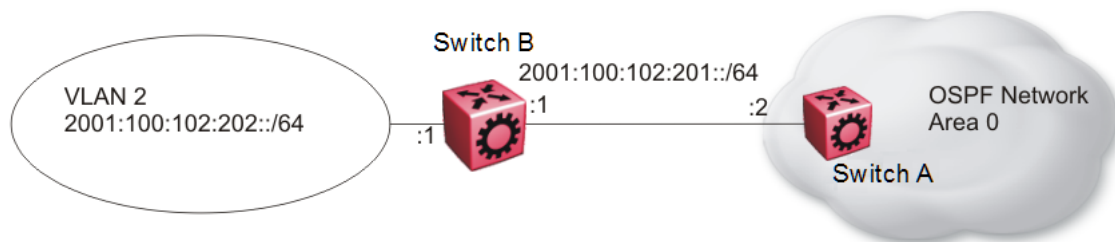

Figure 14: OSPFv3 configuration

To complete the configuration, you must perform the following actions:

- Configure an IPv6 VLAN (VLAN 2) with port member 1/1.
- Configure an IPv6 brouter port (1/2).
- Use IPv6 address 2001:100:102::/64.

Configure VLAN 2 and add port members.

```
vlan create 2 type port-mstprstp 0
vlan mlt 2 4
vlan members 2 1/1 portmember
interface vlan 2
ipv6 interface
ipv6 interface enable
ipv6 interface address 2001:100:102:202:0:0:0:1/64
exit
```

Enable OSPFv3 on VLAN 2.

```
# IPV6 OSPF VLAN CONFIGURATION
interface vlan 2
ipv6 ospf area 0.0.0.0
ipv6 ospf poll-interval 0
ipv6 ospf enable
exit
```

Create brouter port 1/2 with IPv6 and OSPFv3.

```
interface gigabitethernet 1/2
ipv6 interface vlan 3999
ipv6 interface enable
ipv6 interface address 2001:100:102:201:0:0:0:1/64
ipv6 ospf area 0.0.0.0
```

IPv6 configuration examples

```
ipv6 ospf enable
exit
```

Verification:

```
Switch:1#show ipv6 ospf area
```

```
=====
                        OSPF Area
=====
AREA_ID          STUB_AREA  NSSA   IMPORT_SUM  TRANS_ROLE  TRANS_STATE
-----
0.0.0.0          false     false true        always      disabled
STUB_METRIC STUB_METRIC_TYPE  SPF_RUNS  BDR_RTR_CNT  ASBDR_RTR_CNT  LSA_CNT  LSACK_SUM
-----
10              ospfv3Metric     0         0             0             0         0
=====
```

```
Switch:1#show ipv6 interface vlan 2
```

```
=====
                        Vlan Ipv6 Interface
=====
IF   VLAN  PHYSICAL  ADMIN  OPER  TYPE  MTU  HOP  REACH  RETRAN  MCAST  IPSEC  RPC  RPC
INDX          ADDRESS  STATE  STATE                LMT  TIME  TIME  STATUS
-----
2070 2 00:24:7f: enable up  ETHER 1500 64  30000 1000  disable disable exist
      al:7a:06                                     only
=====
                        Vlan Ipv6 Address
=====
IPV6 ADDRESS                                VLAN-ID  TYPE  ORIGIN  STATUS
-----
2001:100:102:202:0:0:0:1                    V-2     UNICAST  MANUAL  PREFERRED
fe80:0:0:0:224:7fff:feal:7a06              V-2     UNICAST  LINKLAYER  PREFERRED

1 out of 2 Total Num of Interface Entries displayed.
2 out of 5 Total Num of Address Entries displayed.
=====
```

IPv6 alternative routes configuration example

To avoid traffic interruption, you can enable alternative routes globally to replace the best route with the next-best route, if the best route becomes unavailable.

The concept of alternative route applies between routing protocols. For example, if an OSPFv3 route becomes unavailable and an alternative RIPng route is available, the system activates the RIPng route immediately without waiting for an update interval to expire.

By default, the alternative routes feature is globally enabled on the switch.

The following example demonstrates this behavior.

In this example, you configure OSPFv3 and RIPng routes on two switches Switch-1 and Switch-2, as shown in the following figure.

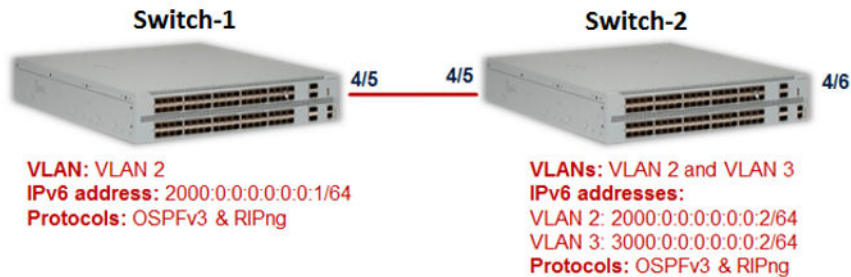

Configuration on Switch-1

VLAN configuration:

On Switch-1, configure VLAN 2 and the IPv6 interface address 2000:0:0:0:0:0:1/64.

```
Switch1:1:1>enable
Switch1:1#configure terminal
Enter configuration commands, one per line.  End with CNTL/Z.

Switch1:1(config)#vlan create 2 type port-mstprstp 0
Switch1:1(config)#vlan members 2 4/5
Switch1:1(config)#interface vlan 2
Switch1:1(config-if)#ipv6 interface address 2000:0:0:0:0:0:1/64
Switch1:1(config-if)#ipv6 interface enable
Switch1:1(config-if)#exit
```

```
Switch1:1(config)#show vlan basic
```

```
=====
                        Vlan Basic
=====
VLAN          NAME          TYPE          MSTP
ID            NAME          TYPE          INST_ID  PROTOCOLID  SUBNETADDR    SUBNETMASK    VRFID
-----
1             Default    byPort        0         none         N/A           N/A           0
2             VLAN-2     byPort        0         none         N/A           N/A           0
=====
```

All 2 out of 2 Total Num of Vlans displayed

```
Switch1:1(config)#show vlan members
```

```
=====
                        Vlan Port
=====
VLAN PORT          ACTIVE          STATIC          NOT_ALLOW
ID   MEMBER          MEMBER          MEMBER          MEMBER
-----
1    1/1-1/16,1/17/1-  1/1-1/16,1/17/1-
    1/17/4,1/18/1-  1/17/4,1/18/1-
    1/18/4,2/1-2/16,  1/18/4,2/1-2/16,
    2/17/1-2/17/4,  2/17/1-2/17/4,
    2/18/1-2/18/4,3/1- 2/18/1-2/18/4,3/1-
    3/6,4/1-4/4,4/6  3/6,4/1-4/4,4/6
2    4/5              4/5
=====
```

All 2 out of 2 Total Num of Port Entries displayed

```
Switch1:1(config)#show ipv6 interface vlan 2
```

```
=====
                        Vlan Ipv6 Interface
=====
```

IPv6 configuration examples

```
=====
IFINDEX VLAN PHYSICAL      ADMIN  OPER  TYPE  MTU  HOP REACHABLE RETRANSMIT MCAST  IPSEC  RPC  RPCMODE
INDX      ADDRESS             STATE  STATE                LMT  TIME  TIME      STATUS
-----
2050    2    b0:ad:aa:4e:59:00 enable  up    ETHER 1500 64  30000    1000    disable disable disable existonly
=====
                                Vlan Ipv6 Address
=====
IPV6 ADDRESS                                VLAN-ID  TYPE  ORIGIN  STATUS
-----
2000:0:0:0:0:0:0:1/64                       V-2    UNICAST MANUAL  PREFERRED
fe80:0:0:0:b2ad:aaff:fe4e:5900/64          V-2    UNICAST LINKLAYER PREFERRED

1 out of 1 Total Num of Interface Entries displayed.
2 out of 2 Total Num of Address Entries displayed.
```

Port configuration:

```
Switch1:1(config)#interface gigabitEthernet 4/5
Switch1:1(config-if)#encapsulation dot1q
Switch1:1(config-if)#no shutdown
Switch1:1(config-if)#exit
```

IPv6 global configuration:

```
Switch1:1(config)#ipv6 forwarding

Switch1:1(config)#show ipv6 forwarding
  Ipv6 forwarding - GlobalRouter : enable
  ecmp                : disable
  ecmp-max-path       : 1
```

IPv6 OSPFv3 VLAN configuration:

```
Switch1:1(config)#interface vlan 2
Switch1:1(config-if)#ipv6 ospf area 0.0.0.0
Switch1:1(config-if)#ipv6 ospf enable

Switch1:1(config-if)#show ipv6 ospf interface vlan 2
  admin-status      : enable
  area              : 0.0.0.0
  dead-interval    : 40
  hello-interval   : 10
  metric           : 1
  poll-interval    : 120
  priority         : 1
  retransmit-interval : 5
  transit-delay    : 1
  type             : BROADCAST
```

IPv6 OSPFv3 router configuration:

```
Switch1:1(config-if)#exit
Switch1:1(config)#router ospf ipv6-enable
Switch1:1(config)#show ipv6 ospf
```

OSPFv3 Global Information

```
=====
router-id                : 170.78.88.0
admin-state              : ENABLED
version                  : 3
area-bdr-rtr-state      : FALSE
as-bdr-rtr-state        : FALSE
helper-mode              : ENABLED
as-scope-lsa-count      : 0
lsa-checksum             : 0
=====
```

```

originate-new-lsas      : 22
rx-new-lsas            : 11
ext-lsa-count          : 0

```

```
Switch1:1(config)#show ipv6 ospf neighbor
```

```

=====
                        OSPF Neighbor
=====
IFINDX(VID/BRT)  NBRROUTERID      NBRIPADDR                                STATE      TTL
-----
2050   (2)      170.78.84.0      fe80:0:0:0:b2ad:aaff:fe4e:5500          Full       31

```

```
1 out of 1 Total Num of Neighbor Entries displayed.
```

```

=====
                        OSPF Virtual Neighbor
=====
NBRAREAID      NBRROUTERID      VIRTINTFID  NBRIPV6ADDR                                STATE
-----

```

```
0 out of 0 Total Num of Virtual Neighbor Entries displayed.
```

```

=====
                        OSPF NBMA Neighbor
=====
INTERFACE  NBRROUTERID      NBRIPADDR                                STATE
-----

```

```
0 out of 0 Total Num of NBMA Neighbor Entries displayed.
```

```
H = Helping a Restarting neighbor
```

```
Switch1:1(config-if)#exit
```

IPv6 RIPng configuration on VLAN:

```

Switch1:1(config)#interface vlan 2
Switch1:1(config-if)#ipv6 rip
Switch1:1(config-if)#ipv6 rip enable

```

```
Switch1:1(config-if)#show ipv6 rip interface
```

```
Total RIPng interfaces: 1
```

```

=====
                        RIPng Interface - GlobalRouter
=====
IFINDX      COST      POISON      SEND      ADMIN      OPER
-----
                STATUS      DEFAULT      STATUS      STATUS
-----
2050 (2 )  1        disable    disable    enable     enable

```

```
1 out of 1 Total Num of RIPng interfaces displayed
```

IPv6 RIPng global router configuration:

```
Switch1:1(config)#router rip ipv6-enable
Switch1:1(config)#router rip
```

```
Switch1:1(config)#show ipv6 rip
```

```
=====
                        RIPng Global - GlobalRouter
=====
                        Rip : Enabled
                        HoldDown Time : 120
                        Timeout Interval : 180
                        Update Time : 30
                        Default Info Metric : 1
                        Default Info State : Disabled
                        Default Import Metric : 1
```

Configuration on Switch-2

On Switch-2, configure VLAN 2 and VLAN 3 with the IPv6 interfaces 2000:0:0:0:0:0:0:2/64 and 3000:0:0:0:0:0:0:2/64 respectively.

VLAN configuration:

```
Switch2:1>enable
Switch2:1#configure terminal
Enter configuration commands, one per line. End with CNTL/Z.
```

```
Switch2:1(config)#vlan create 2 type port-mstprstp 0
Switch2:1(config)#vlan members 2 4/5 portmember
Switch2:1(config)#interface vlan 2
```

```
Switch2:1(config-if)#ipv6 interface address 2000:0:0:0:0:0:0:2/64
Switch2:1(config-if)#ipv6 interface enable
Switch2:1(config-if)#ipv6 forwarding
Switch2:1(config-if)#exit
```

```
Switch2:1(config)#vlan create 3 type port-mstprstp 0
Switch2:1(config)#vlan members 3 4/6 portmember
Switch2:1(config)#interface vlan 3
```

```
Switch2:1(config-if)#ipv6 interface address 3000:0:0:0:0:0:0:2/64
Switch2:1(config-if)#ipv6 interface enable
Switch2:1(config-if)#ipv6 forwarding
Switch2:1(config-if)#exit
```

```
Switch2:1(config)#show vlan basic
```

```
=====
                        Vlan Basic
=====
VLAN ID      NAME      TYPE      MSTP INST_ID  PROTOCOLID  SUBNETADDR  SUBNETMASK  VRFID
-----
1           Default  byPort    0         none      N/A         N/A         0
2           VLAN-2   byPort    0         none      N/A         N/A         0
3           VLAN-3   byPort    0         none      N/A         N/A         0
```

```
All 3 out of 3 Total Num of Vlans displayed
```

```
Switch2:1(config)#show vlan members
```

```
=====
```

Vlan Port			
VLAN ID	PORT MEMBER	ACTIVE MEMBER	STATIC MEMBER
1	1/1-1/16,1/17/1-1/17/4,1/18/1-1/18/4,2/1-2/16,2/17/1-2/17/4,2/18/1-2/18/4,3/1-3/6,4/1-4/4	1/1-1/16,1/17/1-1/17/4,1/18/1-1/18/4,2/1-2/16,2/17/1-2/17/4,2/18/1-2/18/4,3/1-3/6,4/1-4/4	
2	4/5	4/5	
3	4/6	4/6	

All 3 out of 3 Total Num of Port Entries displayed

```
Switch2:1(config)#show ipv6 interface vlan
```

```
=====
```

```
                        Vlan Ipv6 Interface
```

```
=====
```

IFINDX	VLAN	PHYSICAL ADDRESS	ADMIN STATE	OPER STATE	TYPE	MTU	HOP LMT	REACHABLE TIME	RETRANSMIT TIME	MCAST STATUS	IPSEC	RPC	RPCMODE
2050	2	b0:ad:aa:4e:55:00	enable	up	ETHER	1500	64	30000	1000	disable	disable	disable	existonly
2051	3	b0:ad:aa:4e:55:01	enable	up	ETHER	1500	64	30000	1000	disable	disable	disable	existonly

```
=====
```

```
                        Vlan Ipv6 Address
```

```
=====
```

IPV6 ADDRESS	VLAN-ID	TYPE	ORIGIN	STATUS
2000:0:0:0:0:0:2/64	V-2	UNICAST	MANUAL	PREFERRED
fe80:0:0:0:b2ad:aaff:fe4e:5500/64	V-2	UNICAST	LINKLAYER	PREFERRED
3000:0:0:0:0:0:2/64	V-3	UNICAST	MANUAL	PREFERRED
fe80:0:0:0:b2ad:aaff:fe4e:5501/64	V-3	UNICAST	LINKLAYER	PREFERRED

```
=====
```

2 out of 2 Total Num of Interface Entries displayed.
4 out of 4 Total Num of Address Entries displayed.

Port configuration:

```
Switch2:1(config)#interface GigabitEthernet 4/5
Switch2:1(config)#encapsulation dot1q
Switch2:1(config)#no shutdown

Switch2:1(config)#interface GigabitEthernet 4/6
Switch2:1(config)#encapsulation dot1q
Switch2:1(config)#no shutdown
```

IPv6 global configuration:

```
Switch1:1(config)#ipv6 forwarding

Switch1:1(config)#show ipv6 forwarding
  Ipv6 forwarding - GlobalRouter : enable
  ecmp              : disable
  ecmp-max-path    : 1
```

IPv6 OSPFv3 VLAN configuration:

```
Switch2:1(config)#interface vlan 2
Switch2:1(config-if)#ipv6 ospf area 0.0.0.0
Switch2:1(config-if)#ipv6 ospf enable

Switch2:1(config)#interface vlan 3
```

IPv6 configuration examples

```
Switch2:1(config-if)#ipv6 ospf area 0.0.0.0
Switch2:1(config-if)#ipv6 ospf enable
```

```
Switch2:1(config-if)#show ipv6 ospf
```

```
=====
                        OSPFv3 Global Information
=====
router-id                : 170.78.84.0
admin-state              : ENABLED
version                  : 3
area-bdr-rtr-state      : FALSE
as-bdr-rtr-state        : FALSE
helper-mode              : ENABLED
as-scope-lsa-count      : 0
lsa-checksum             : 0
originate-new-lsas      : 56
rx-new-lsas              : 62
ext-lsa-count            : 0
```

```
Switch2:1(config-if)#show ipv6 ospf interface
```

```
Total ospf areas: 1
```

```
Total ospf interfaces: 2
```

```
=====
                        OSPF Interface
=====
IFINDX(VID/BRT)  AREAID      ADM IFSTATE  METRIC  PRI  DR/BDR      IFTYPE
-----
2050 (2)         ) 0.0.0.0     ena BDR     1       1   170.78.88.0  BROADCAST
                )                   170.78.84.0
2051 (3)         ) 0.0.0.0     ena DR      1       1   170.78.84.0  BROADCAST
                )                   0.0.0.0
```

```
2 out of 2 Total Num of ospf interfaces displayed
```

```
Total ospf virtual interfaces: 0
```

```
=====
                        OSPF Virtual Interface
=====
```

```
AREAID          NBRIPADDR      STATE
-----
```

```
0 out of 0 Total Num of ospf virtual interfaces displayed
```

```
Switch2:1(config-if)#show ipv6 ospf neighbor
```

```
=====
                        OSPF Neighbor
=====
IFINDX(VID/BRT)  NBRROUTERID    NBRIPADDR      STATE      TTL
-----
2050 (2)         170.78.88.0    fe80:0:0:0:b2ad:aaff:fe4e:5900 Full       30

1 out of 1 Total Num of Neighbor Entries displayed.
```

```

=====
                                OSPF Virtual Neighbor
=====
NBRAREAID      NBRROUTERID    VIRTINTFID  NBRIPV6ADDR    STATE
-----
0 out of 0 Total Num of Virtual Neighbor Entries displayed.
=====
                                OSPF NBMA Neighbor
=====
INTERFACE  NBRROUTERID    NBRIPADDR    STATE
-----
0 out of 0 Total Num of NBMA Neighbor Entries displayed.

H = Helping a Restarting neighbor

```

IPv6 OSPFv3 global router configuration:

```

Switch2:1(config-if)#exit
Switch2:1(config)#router ospf ipv6-enable
Switch1:1(config)#show ipv6 ospf

```

```

=====
                                OSPFv3 Global Information
=====
router-id      : 170.78.88.0
admin-state    : ENABLED
version        : 3
area-bdr-rtr-state : FALSE
as-bdr-rtr-state : FALSE
helper-mode    : ENABLED
as-scope-lsa-count : 0
lsa-checksum   : 0
originate-new-lsas : 22
rx-new-lsas    : 11
ext-lsa-count  : 0

```

IPv6 RIPng configuration:

```

Switch2:1(config)#interface vlan 2
Switch2:1(config-if)#ipv6 rip
Switch2:1(config-if)#ipv6 rip enable
Switch2:1(config-if)#exit

Switch2:1(config)#interface vlan 3
Switch2:1(config-if)#ipv6 rip
Switch2:1(config-if)#ipv6 rip enable
Switch2:1(config-if)#exit
Switch2:1(config)#

Switch2:1(config)#show ipv6 rip interface

Total RIPng interfaces: 2

=====
                                RIPng Interface - GlobalRouter
=====

```

IPv6 configuration examples

```
=====
IFINDEX          COST      POISON          SEND            ADMIN           OPER
STATUS          STATUS          DEFAULT        STATUS          STATUS
-----
2050 (2   )    1        disable        disable        enable         enable
2051 (3   )    1        disable        disable        enable         enable

2 out of 2 Total Num of RIPng interfaces displayed
```

IPv6 RIPng global router configuration:

```
Switch2:1(config)#router rip ipv6-enable
Switch2:1(config)#router rip
```

```
Switch2:1(config)#show ipv6 rip
```

```
=====
                        RIPng Global - GlobalRouter
=====

                Rip : Enabled
            HoldDown Time : 120
        Timeout Interval : 180
            Update Time : 30
    Default Info Metric : 1
        Default Info State : Disabled
    Default Import Metric : 1
```

Viewing route and alternative route configuration on the switches

On Switch-1 and Switch-2, the route 3000:0:0:0:0:0:0:2/64 is learned using the protocols RIPng and OSPFv3. The OSPFv3 route is learned as the best route because of its route preference value of 20. The RIPng route is added as alternative route as it has the route preference 100, which is greater than the OSPFv3 route preference of 20. On Switch-2, the route 3000:0:0:0:0:0:0:2/64 is a local route.

Viewing route and alternative route configuration on Switch-1:

```
Switch1:1(config)#show ipv6 route alternative
```

```
=====
                        IPv6 Routing Table Information
=====
Destination Address/PrefixLen  NEXT HOP                VID/BID/TID  PROTO  COST  AGE  TYPE  PREF
-----
2000:0:0:0:0:0:0:1/64         0:0:0:0:0:0:0:0        V-2          LOCAL  1     0    B    0
2000:0:0:0:0:0:0:1/128       0:0:0:0:0:0:0:0        V-2          LOCAL  1     0    B    0
3000:0:0:0:0:0:0:2/64        fe80:0:0:0:b2ad:aaff:fe4e:5500  V-2          OSPF   2     0    B    20
3000:0:0:0:0:0:0:2/64        fe80:0:0:0:b2ad:aaff:fe4e:5500  V-2          RIP    2     0    A    100
```

```
4 out of 4 Total Num of Route Entries displayed.
```

```
TYPE Legend:
A=Alternative Route, B=Best Route, E=Ecmp Route
```

```
Switch1:1(config)#show ipv6 route
```

```
=====
                        IPv6 Routing Table Information
=====
Destination Address/PrefixLen  NEXT HOP                VID/BID/TID  PROTO  COST  AGE  TYPE  PREF
-----
2000:0:0:0:0:0:0:1/64         0:0:0:0:0:0:0:0        V-2          LOCAL  1     0    B    0
2000:0:0:0:0:0:0:1/128       0:0:0:0:0:0:0:0        V-2          LOCAL  1     0    B    0
3000:0:0:0:0:0:0:2/64        fe80:0:0:0:b2ad:aaff:fe4e:5500  V-2          OSPF   2     0    B    20
```

```
3 out of 3 Total Num of Route Entries displayed.
```

```
TYPE Legend:
A=Alternative Route, B=Best Route, E=Ecmp Route
```

Viewing route and alternative route configuration on Switch-2:

```
Switch2:1(config)#show ipv6 route alternative
=====
IPv6 Routing Table Information
=====
Destination Address/PrefixLen  NEXT HOP                VID/BID/TID  PROTO  COST  AGE  TYPE  PREF
-----
2000:0:0:0:0:0:0:2/64         0:0:0:0:0:0:0:0        V-2          LOCAL  1     0    B     0
2000:0:0:0:0:0:0:1/128       0:0:0:0:0:0:0:0        V-2          LOCAL  1     0    B     0
3000:0:0:0:0:0:0:2/64         fe80:0:0:0:b2ad:aaff:fe4e:5500  V-2          LOCAL  2     0    B     20
3000:0:0:0:0:0:0:2/64         fe80:0:0:0:b2ad:aaff:fe4e:5500  V-2          LOCAL  2     0    A     100
=====
4 out of 4 Total Num of Route Entries displayed.
=====
TYPE Legend:
A=Alternative Route, B=Best Route, E=Ecmp Route
```

```
Switch2:1#show ipv6 route
=====
IPv6 Routing Table Information
=====
Destination Address/PrefixLen  NEXT HOP                VID/BID/TID  PROTO  COST  AGE  TYPE  PREF
-----
2000:0:0:0:0:0:0:2/64         0:0:0:0:0:0:0:0        V-2          LOCAL  1     0    B     0
2000:0:0:0:0:0:0:2/128       0:0:0:0:0:0:0:0        V-2          LOCAL  1     0    B     0
3000:0:0:0:0:0:0:2/64         0:0:0:0:0:0:0:0        V-3          LOCAL  1     0    B     20
3000:0:0:0:0:0:0:2/128       0:0:0:0:0:0:0:0        V-3          LOCAL  1     0    B     100
=====
4 out of 4 Total Num of Route Entries displayed.
=====
TYPE Legend:
A=Alternative Route, B=Best Route, E=Ecmp Route
```

Changing the route preference on Switch-1

On the switch, default preferences are assigned to all standard routing protocols. You can modify the global preference for a protocol to give it a higher or lower priority than other protocols. When you change the preference for a static route, if all best routes remain best routes, only the local route tables change. However, if changing the protocol preference causes best routes to no longer be best routes, neighboring route tables can be affected.

In the following example scenario, you configure a different routing preference for the RIPng protocol on Switch-1 and observe the learning of best and alternative routes. The existing route preference for RIPng is 100.

```
Switch1:1#show ipv6 route alternative
=====
IPv6 Routing Table Information
=====
Destination Address/PrefixLen  NEXT HOP                VID/BID/TID  PROTO  COST  AGE  TYPE  PREF
-----
2000:0:0:0:0:0:0:1/64         0:0:0:0:0:0:0:0        V-2          LOCAL  1     0    B     0
2000:0:0:0:0:0:0:1/128       0:0:0:0:0:0:0:0        V-2          LOCAL  1     0    B     0
3000:0:0:0:0:0:0:2/64         fe80:0:0:0:b2ad:aaff:fe4e:5500  V-2          OSPF   2     0    B     20
3000:0:0:0:0:0:0:2/64         fe80:0:0:0:b2ad:aaff:fe4e:5500  V-2          RIP    2     0    A     100
=====
4 out of 4 Total Num of Route Entries displayed.
=====
TYPE Legend:
A=Alternative Route, B=Best Route, E=Ecmp Route

Switch1:1(config)#show ipv6 route
=====
IPv6 Routing Table Information
=====
Destination Address/PrefixLen  NEXT HOP                VID/BID/TID  PROTO  COST  AGE  TYPE  PREF
-----
2000:0:0:0:0:0:0:1/64         0:0:0:0:0:0:0:0        V-2          LOCAL  1     0    B     0
2000:0:0:0:0:0:0:1/128       0:0:0:0:0:0:0:0        V-2          LOCAL  1     0    B     0
3000:0:0:0:0:0:0:2/64         fe80:0:0:0:b2ad:aaff:fe4e:5500  V-2          OSPF   2     0    B     20
=====
3 out of 3 Total Num of Route Entries displayed.
=====
```

IPv6 configuration examples

TYPE Legend:
A=Alternative Route, B=Best Route, E=Ecmp Route

Configure a different route preference for the RIPng protocol, for example, 19:

```
Switch1:1#configure terminal
Enter configuration commands, one per line. End with CNTL/Z.
Switch1:1(config)#ipv6 route preference protocol ripng 19
Switch1:1(config)#exit
```

Verify the route preference configuration:

```
Switch1:1#show ipv6 route preference
```

```
=====
                        IPv6 Route Preference
=====
```

PROTOCOL	DEFAULT	CONFIG
LOCAL	0	0
STATIC	5	5
SPBM_L1	7	7
OSPFv3_INTRA	20	20
OSPFv3_INTER	25	25
EBGP	45	45
RIPNG	100	19
OSPFv3_E1	120	120
OSPFv3_E2	125	125
IBGP	175	175

View the updated route preference (for RIPng) on Switch-1. The RIPng route is now learnt as the best route as it has lesser value of route preference (19) than that of OSPFv3 (20), as shown below.

```
Switch1:1(config)#show ipv6 route
```

```
=====
                        IPv6 Routing Table Information
=====
```

Destination Address/PrefixLen	NEXT HOP	VID/BID/TID	PROTO	COST	AGE	TYPE	PREF
2000:0:0:0:0:0:0:1/64	0:0:0:0:0:0:0:0	V-2	LOCAL	1	0	B	0
2000:0:0:0:0:0:0:1/128	0:0:0:0:0:0:0:0	V-2	LOCAL	1	0	B	0
3000:0:0:0:0:0:0:2/64	fe80:0:0:0:b2ad:aaff:fe4e:5500	V-2	RIP	2	0	B	19

3 out of 3 Total Num of Route Entries displayed.

TYPE Legend:
A=Alternative Route, B=Best Route, E=Ecmp Route

```
Switch1:1#show ipv6 route alternative
```

```
=====
                        IPv6 Routing Table Information
=====
```

Destination Address/PrefixLen	NEXT HOP	VID/BID/TID	PROTO	COST	AGE	TYPE	PREF
2000:0:0:0:0:0:0:1/64	0:0:0:0:0:0:0:0	V-2	LOCAL	1	0	B	0
2000:0:0:0:0:0:0:1/128	0:0:0:0:0:0:0:0	V-2	LOCAL	1	0	B	0
3000:0:0:0:0:0:0:2/64	fe80:0:0:0:b2ad:aaff:fe4e:5500	V-2	RIP	2	0	B	19
3000:0:0:0:0:0:0:2/64	fe80:0:0:0:b2ad:aaff:fe4e:5500	V-2	OSPF	2	0	A	20

4 out of 4 Total Num of Route Entries displayed.

TYPE Legend:
A=Alternative Route, B=Best Route, E=Ecmp Route

Disable alternative route learning on Switch-1

The following example demonstrates disabling alternative route learning on Switch-1.

View the alternative routes on Switch-1.

```
Switch1:1(config)#show ipv6 route alternative
=====
IPv6 Routing Table Information
=====
Destination Address/PrefixLen  NEXT HOP                               VID/BID/TID  PROTO  COST  AGE  TYPE  PREF
-----
2000:0:0:0:0:0:0:1/64         0:0:0:0:0:0:0:0                       V-2          LOCAL  1     0    B    0
2000:0:0:0:0:0:0:1/128       0:0:0:0:0:0:0:0                       V-2          LOCAL  1     0    B    0
3000:0:0:0:0:0:0:2/64        fe80:0:0:0:b2ad:aaff:fe4e:5500        V-2          OSPF   2     0    B    20
3000:0:0:0:0:0:0:2/64        fe80:0:0:0:b2ad:aaff:fe4e:5500        V-2          RIP    2     0    A    100
=====
4 out of 4 Total Num of Route Entries displayed.
=====
TYPE Legend:
A=Alternative Route, B=Best Route, E=Ecmp Route
```

Disable IPv6 alternative routes on Switch-1.

```
Switch1:1#configure terminal
Enter configuration commands, one per line.  End with CNTL/Z.
Switch1:1(config)#no ipv6 alternative-route
Switch1:1(config)#exit
```

Verify that alternative route learning is disabled.

```
Switch1:1#show ipv6 global
forwarding                : enable
default-hop-cnt           : 64
number-of-interfaces      : 1
icmp-error-interval       : 1000
icmp-error-quota          : 50
icmp-unreach-msg          : disable
icmp-echo-multicast-request : enable
static-route-admin-status : enable
alternative-route         : disable
ecmp                      : disable
ecmp-max-path             : 1
source-route              : disable

Switch1:1(config)#show ipv6 route
=====
IPv6 Routing Table Information
=====
Destination Address/PrefixLen  NEXT HOP                               VID/BID/TID  PROTO  COST  AGE  TYPE  PREF
-----
2000:0:0:0:0:0:0:1/64         0:0:0:0:0:0:0:0                       V-2          LOCAL  1     0    B    0
2000:0:0:0:0:0:0:1/128       0:0:0:0:0:0:0:0                       V-2          LOCAL  1     0    B    0
3000:0:0:0:0:0:0:2/64        fe80:0:0:0:b2ad:aaff:fe4e:5500        V-2          OSPF   2     0    B    20
=====
3 out of 3 Total Num of Route Entries displayed.
=====
TYPE Legend:
A=Alternative Route, B=Best Route, E=Ecmp Route
```

Note that the alternative route (RIPng) is not learnt.

```
Switch1:1(config)#show ipv6 route alternative
=====
IPv6 Routing Table Information
=====
Destination Address/PrefixLen  NEXT HOP                               VID/BID/TID  PROTO  COST  AGE  TYPE  PREF
-----
2000:0:0:0:0:0:0:1/64         0:0:0:0:0:0:0:0                       V-2          LOCAL  1     0    B    0
2000:0:0:0:0:0:0:1/128       0:0:0:0:0:0:0:0                       V-2          LOCAL  1     0    B    0
3000:0:0:0:0:0:0:2/64        fe80:0:0:0:b2ad:aaff:fe4e:5500        V-2          OSPF   2     0    B    20
=====
3 out of 3 Total Num of Route Entries displayed.
=====
TYPE Legend:
A=Alternative Route, B=Best Route, E=Ecmp Route
```

Chapter 14: VRF Lite

VRF Lite fundamentals

Use the concepts described in this section to understand and use the Virtual Routing and Forwarding (VRF) Lite feature. Use VRF Lite to provide secure customer data isolation.

Overview

The switch supports what is termed as VRF Lite. Lite conveys the fact that the switch does not use Multiprotocol Label Switching (MPLS) for VRF; VRF Lite is a device virtualization feature, not a network-wide virtualization feature.

Use VRF Lite to offer networking capabilities and traffic isolation to customers that operate over the same node (router). Each virtual router emulates the behavior of a dedicated hardware router; the network treats each virtual router as a separate physical router. In effect, you can perform the functions of many routers using a single platform that runs VRF Lite. The result is a substantial reduction in the cost associated with providing routing and traffic isolation for multiple clients.

With multicast virtualization for IPv4, the switch can function as multiple virtual multicast routers.

The following figure shows one platform acting as multiple virtual routers, each serving a different customer network.

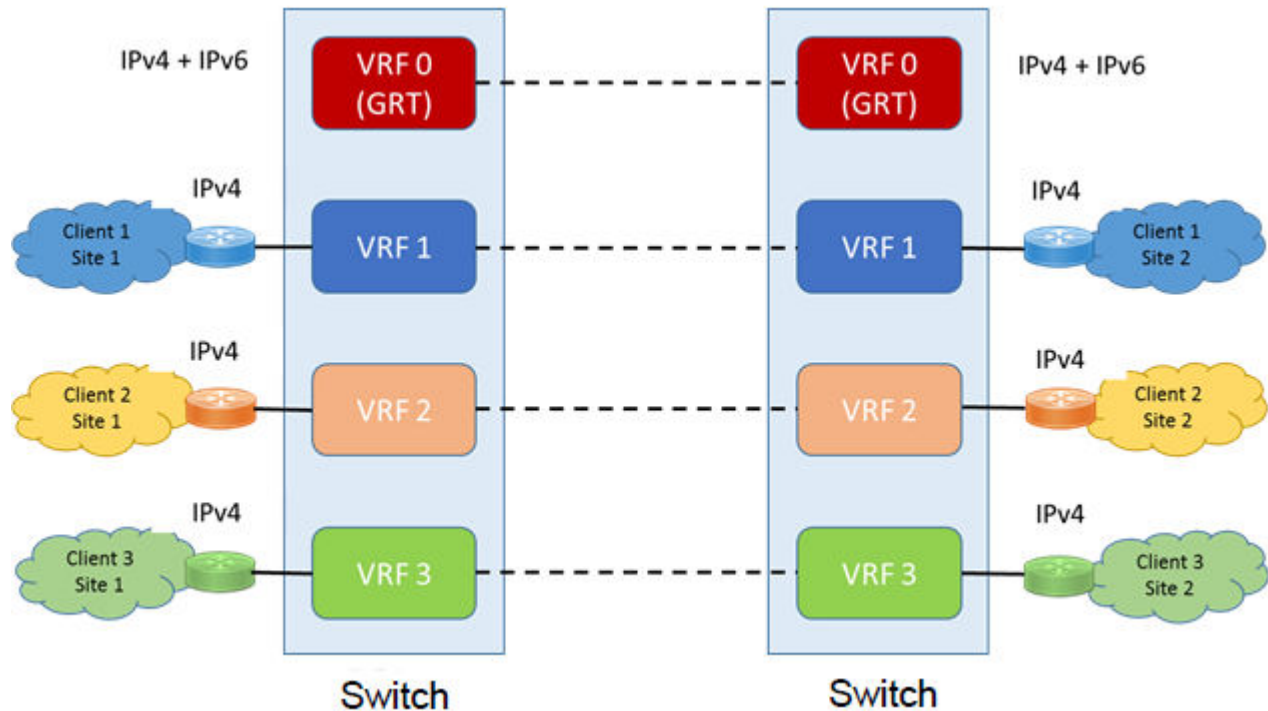

Figure 15: Multiple virtual routers in one system

A switch can support many virtual routers. Each virtual router instance is called a VRF instance. A VRF represents a single instance of a virtual router. Each instance maintains its own routing table. The term Multiple Virtual Router (MVR) is sometimes used to represent a router that contains many VRF instances.

The IPv6 Virtualization functionality adds IPv6 support on VRFs and Layer 3 VSNs. Each VRF instance has its own IPv6 interfaces, IPv6 address space, IPv6 routing table, and IPv6 global parameters. For more information on Layer 3 VSN, see *Configuring Fabric Layer 3 Services*.

The Global Router, VRF 0, is the first instance of the router. When the system starts, it creates VRF 0 by default. VRF 0 provides all non-virtual and traditional routing services. You cannot delete this instance. You can create and configure other VRF instances, if required.

VRF 0 is the only VRF that you can log into through CLI. CLI requires you to specify the VRF when you enter commands.

You can associate one VRF instance with many IPv4 or IPv6 interfaces. These interfaces are unique for each VRF instance. An interface is an entity with an IPv4 or IPv6 address that has the following characteristics:

- A unique association with a VLAN.
- A unique association with a brouter, if not associated with a VLAN
- A unique association with a circuit

A VLAN can only be associated with a single VRF instance.

*** Note:**

- You cannot associate a VLAN or port and a VRF instance if the VLAN or port has an IPv4 or IPv6 address. You must first associate the port and VRF instance and then you can configure the IPv4 or IPv6 address.
- Use command `boot config flag vrf-scaling` to increase total VRFs. You must have a premier license to increase the total VRF count on the switch. For more information on route scaling, see *Release Notes*.

Management VRF

The following sections detail Management VRF features.

Management port

The management port is a 10/100/1000 Mb/s Ethernet port that you can use for an out-of-band management connection to the switch.

*** Note:**

Not all hardware platforms provide a dedicated, physical management interface. For more information, see your hardware documentation.

Management Router VRF

The switch has a separate VRF called Management Router (MgmtRouter) reserved for the management port and the Virtual Management IP address. The configured IP subnet has to be globally unique because the management protocols, for example, SNMP, Telnet, and FTP, can go through in-band or out-of-band ports. The VRF ID for the Management Router is 512.

The switch never switches or routes transit packets between the Management Router VRF port and the Global Router VRF, or between the Management Router VRF and other VRF ports.

The switch honors the VRF of the ingress packet; however, in no circumstance does the switch allow routing between the Management VRF and Global Router VRF. The switch does not support the configuration if you have an out-of-band management network with access to the same networks present in the GRT routing table.

*** Note:**

IPv6 is not supported on MgmtRouter.

Non-virtualized client management applications

Ensure that you do not define a default route in the Management Router VRF. A route used for non-virtualized client management applications, such as Telnet, Secure Shell (SSH), and FTP, originating from the switch, will always match a default route defined in the Management Router VRF.

If you want out-of-band management, it is recommended that you define a specific static route in the Management Router VRF to the IP subnet where your management application resides.

When you specify a static route in the Management Router VRF, it enables the client management applications originating from the switch to perform out-of-band management without affecting in-

band management. This enables in-band management applications to operate in the Global Router VRF.

Non-virtualized client management applications originating from the switch, such as Telnet, SSH, and FTP, follow the behavior listed below:

1. Look at the Management Router VRF route table.
2. If no route is found, the applications will proceed to look in the Global Router VRF table.

Non-virtualized client management applications include:

- DNS
- FTP client with the copy command
- NTP
- rlogin
- RADIUS authentication and accounting
- SSH
- SNMP clients in the form of traps
- SYSLOG
- TACACS+
- Telnet
- TFTP client

For management applications that originate outside the switch, the initial incoming packets establish a VRF context that limits the return path to the same VRF context.

Virtualized management applications

Virtualized management applications, such as ping and traceroute, operate using the specified VRF context. To operate ping or traceroute you must specify the desired VRF context. If not specified, ping defaults to the Global Router VRF. For example, if you want to ping a device through the out-of-band management port you must select the Management Router VRF. For example, if you want to ping a device through the out-of-band management port you must select the Management Router VRF.

Note:

IPv6 is not supported on MgmtRouter.

```
Switch:1(config)#ping 192.0.2.1 vrf MgmtRouter
192.0.2.1 is alive
```

Ping test for IPv6:

```
Switch:1(config)#ping 2001:db8::1 vrf vrfRED
2001:db8::1 is alive
```

Traceroute test for IPv4:

```
Switch:1#traceroute 192.0.2.1 vrf MgmtRouter
```

Traceroute test for IPv6:

```
Switch:1#traceroute 2001:db8::1 vrf vrfRED
```

VRF Lite configuration rules

You must select the VRF for global IPv4 or IPv6 options before entering commands.

Not all Global Router parameters are configurable on other VRF instances.

For instructions about how to configure a VRF instance, see the following paragraphs.

Layer 1 and Layer 2 information (including VLAN information) is global and is not maintained for each VRF instance. However, you can associate a set of VLANs with a VRF instance.

One VLAN cannot belong to more than one VRF instance at one time. When you create a VLAN, more than one physical port can belong to it. You can associate a VRF instance with more than one IPv4 or IPv6 interface (a physical Ethernet port or a VLAN).

Perform physical port assignment at the VLAN and brouter port level. A VRF instance inherits all the ports assigned to its VLANs and brouter ports. You cannot directly assign a physical port to a VRF instance, but it is implicitly assigned when you associate the VRF with VLANs or brouter ports.

For IPv4, after you configure interVRF route redistribution between two VRF instances, avoid overlapping IP addresses between these two VRF instances.

When you configure VRF Lite, remember the following rules:

- You can connect two VRFs from the same system with an external cable.
- An IPv4 or IPv6 routable VLAN can become a member of a VRF.
- An IPv4 or IPv6 interface can belong to only one VRF.
- A VRF can exist even if no interfaces are assigned to it.
- Routing policies apply to VRFs on an individual basis.
- Multiple VRFs on the same node can function in different autonomous systems.

Following rules apply to IPv4 interfaces specifically:

- If you configure an IPv4 interface without specifying the VRF instance, it is mapped to VRF 0 by default.
- VRF Lite supports SMLT and RSMLT
- VRF Lite supports RIP in and out policies
- VRF Lite supports OSPF in and out (accept and redistribute) policies
- Before you delete a VRF instance, disable OSPF. Deleting a VRF instance deletes the OSPF instance if OSPF is disabled
- When you create a VRF instance, an OSPF instance is not automatically created. To activate OSPF on a VRF instance, first create an OSPF instance, and then enable OSPF
- You can configure a VRF so it can have IP interfaces with OSPF, RIP, static routes, and policies simultaneously
- Every IPv4 interface is a member of VRF 0 unless explicitly defined to belong to another VRF.

Virtualized protocols

VRF Lite supports virtualization of the following IPv4 and IPv6 protocols and features. Use this table to find applicable VRF command and procedure information.

Table 9: Virtualized IPv4 protocols and documentation

Virtualized IPv4 protocol or feature	Where to find information
ARP	<i>Configuring IPv4 Routing</i>
BGP	<i>Configuring BGP Services</i>
Circuitless IP	<i>Configuring IPv4 Routing</i>
DHCP	<i>Configuring IPv4 Routing</i>
IGMP	<i>Configuring IP Multicast Routing Protocols</i>
OSPF	<i>Configuring OSPF and RIP</i>
RIP	<i>Configuring OSPF and RIP</i>
Route policies	<i>Configuring IPv4 Routing</i>
Route preferences	<i>Configuring IPv4 Routing</i>
Router Discovery	<i>Configuring IPv4 Routing</i>
Static routes	<i>Configuring IPv4 Routing</i>
User Datagram Protocol (UDP)	<i>Configuring IPv4 Routing</i>
VLAN	<i>Configuring VLANs, Spanning Tree, and NLB.</i>
VRRP	<i>Configuring IPv4 Routing</i>

Table 10: Virtualized IPv6 protocols and documentation

Virtualized IPv6 protocol or feature	Where to find information
IPv6 Interfaces and IPv6 Static Routes	<i>Configuring IPv6 Routing</i>
ECMP and Alternative Route	<i>Configuring IPv6 Routing</i>
Route redistribution for static and direct routes	<i>Configuring IPv6 Routing</i>
VRRPv3	<i>Configuring IPv6 Routing</i>
DHCP Relay	<i>Configuring IPv6 Routing</i>
IPv6 Reverse Path Forwarding	<i>Configuring IPv6 Routing</i>
ICMP Ping & Traceroute	<i>Configuring IPv6 Routing</i>

VRF Lite configuration using CLI

Creating a VRF instance

About this task

Create a VRF instance to provide a virtual routing interface for a user.

For more information on route scaling, see *Release Notes*.

*** Note:**

Different hardware platforms support different parameter ranges. Use the CLI Help to see the available range.

Procedure

1. Enter Global Configuration mode:

```
enable
configure terminal
```

2. Create a VRF instance and specify a VRF name:

```
ip vrf WORD<1-16>
```

3. Configure the maximum number of routes:

- For IPv4:

```
ip vrf WORD<1-16> max-routes <0-15744 | 0-15488 | 0-256000>
```

- For IPv6:

```
ip vrf WORD<1-16> ipv6-max-routes <0-7744 | 0-7872>
```

4. Enable max-routes traps:

- For IPv4:

```
ip vrf WORD<1-16> max-routes-trap enable
```

- For IPv6:

```
ip vrf WORD<1-16> ipv6-max-routes-trap enable
```

*** Note:**

The maximum number of IPv6 routes for the Global Router are fixed and cannot be changed.

5. Enter VRF Router Configuration mode:

```
router vrf WORD<1-16>
```

6. Configure the IPv4 routing protocol triggers for the VRF:

Use one of the following commands on your switch:

- ip bgp
- ip ospf
- ip rip

*** Note:**

You cannot configure BGP, OSPF, or RIP on a VRF instance unless you first configure the routing protocol trigger.

7. Ensure that the instance is configured correctly:

```
show ip vrf WORD<1-16>
```

Example

Create a VRF instance:

```
Switch:1>enable
Switch:1#configure terminal
Switch:1(config)#ip vrf vrfRED
```

Configure the maximum number of IPv4 routes and enable max-routes traps.

```
Switch:1(config)#ip vrf vrfRED max-routes 12000
Switch:1(config)#ip vrf vrfRED max-routes-trap enable
```

Enter Router Configuration mode and configure the routing protocol triggers for the VRF:

```
Switch:1(config)#router vrf vrfRED
Switch:1(router-vrf)#ip bgp
Switch:1(router-vrf)#ip ospf
Switch:1(router-vrf)#ip rip
```

Exit to Global configuration mode:

```
Switch:1(router-vrf)#exit
```

Configure the maximum number of IPv6 routes and enable IPv6 max-routes traps.

```
Switch:1(config)#ip vrf vrfRED ipv6-max-routes 7700
Switch:1(config)#ip vrf vrfRED ipv6-max-routes-trap enable
```

Ensure that the instance is configured correctly:

```
Switch:1#show ip vrf vrfRED
```

```
=====
                        VRF INFORMATION
=====
VRF      OSPF      RIP      BGP      PIM      ARP      PIM6
COUNT  COUNT    COUNT    COUNT    COUNT    COUNT    COUNT
-----
1         1         1         1         1         7         1

VRF      VRF      VLAN  ARP      PIM6
NAME     ID      COUNT COUNT    COUNT
-----
vrfRED   3      TRUE  TRUE    TRUE    TRUE    0     7     TRUE

1 out of 1 Total Num of VRF Entries displayed.
```

Variable definitions

Use the data in the following table to use the `ip vrf` command.

*** Note:**

Different hardware platforms support different parameter ranges. Use the CLI Help to see the available range.

Table 11: Variable definitions

Variable	Value
Depending on your hardware platform: <code>max-routes <0-15488 0-15744 0-252000></code>	Configures the maximum number of IPv4 routes allowed for the VRF, which is 15488, 15744, or 252000, depending on your hardware platform. The default value is 10000, except for the GlobalRouter, which is 15488, 15744, or 252000, depending on your hardware platform.
<code>ipv6-max-routes <0-7744 0-7872></code>	Configures the maximum number of IPv6 routes allowed for the VRF, which is 7744 or 7872, depending on your hardware platform. The default value is 5000.
<code>max-routes-trap enable</code>	Enables SNMP traps after the maximum number of IPv4 routes are reached.
<code>ipv6-max-routes-trap enable</code>	Enables SNMP trap generation based on the configured number of maximum IPv6 routes. The default is enabled.
<code>name WORD<0-16></code>	Renames the VRF instance.
<code>vrf-trap</code>	Enables the device to send VRF-related traps.

Use the data in the following table to use the `show ip vrf` command.

Table 12: Variable definitions

Variable	Value
<code>max-routes [vrfids WORD<0-512>] [WORD <1-16>]</code>	Displays the maximum number of routes for the specified VRFs. <ul style="list-style-type: none"> <code>vrfids WORD<0-512></code> specifies a list of VRFs by VRF IDs. <code>WORD<1-16></code> specifies a VRF by name.
<code>vrfids WORD<0-512></code>	Specifies a list of VRFs by VRF IDs.
<code>WORD<1-16></code>	Specifies a VRF by name.

Creating an IPv6 VPN instance

Before you begin

The VRF must exist.

About this task

Create an IPv6 VPN instance to advertise IPv6 routes from a VRF to Shortest Path Bridging MAC (SPBM) network. For more information about Layer 3 Virtual Services Networks (VSNs) and SPBM, see *Configuring Fabric Layer 3 Services*.

Procedure

1. Enter VRF Router Configuration mode for a specific VRF context:

```
enable
configure terminal
router vrf WORD<1-16>
```

2. Create an IPv6 VPN instance:

```
ipv6 ipvpn
```

3. Assign a service instance identifier (I-SID) to the IPv6 VPN:

```
i-sid <0-16777215>
```

4. Enable IPv6 VPN:

```
ipv6 ipvpn enable
```

5. Display all IPv6 VPNs:

```
show ipv6 ipvpn [vrf WORD<1-16> | vrfids WORD<0-512>]
```

Example

Create and enable IPv6 VPN instance:

```
Switch:1>enable
Switch:1#configure terminal
Switch:1(config)#router vrf vrfred
Switch:1(router-vrf)#ipv6 ipvpn
Switch:1(router-vrf)#i-sid 100
Switch:1(router-vrf)#ipv6 ipvpn enable
Switch:1(router-vrf)#show ipv6 ipvpn
Switch:1(router-vrf)#show ipv6 ipvpn
  VRF Name           : vrfred
  Ipv6 Ipvpn-state   : enabled
  Ipv4 Ipvpn-state   : disabled
  I-sid              : 5555

Total active Ipv6 L3 VSN : 1

1 out of 3 Total Num of VRF Entries displayed.
```

Variable definitions

Use the data in the following table to configure the `ipv6 ipvpn` command.

Variable	Value
enable	Enables IPv6 IPVPN. The default is disabled.

Use the data in the following table to configure the `i-sid` command.

Variable	Value
<code><0-16777215></code>	Assigns an I-SID to the VRF being configured.

Use the data in the following table to configure the `show ipv6 ipvpn` command.

Variable	Value
<code>vrf WORD<1-16></code>	Specifies the VRF name.
<code>vrfids WORD<0-512></code>	Specifies the VRF ID.

Enabling IPv6 trap notifications

About this task

Perform this procedure to enable SNMP traps when maximum number of IPv6 routes are reached.

* Note:

Different hardware platforms support different parameter ranges. Use the CLI Help to see the available range.

Procedure

1. Enter Global Configuration mode:

```
enable
configure terminal
```

2. Enable max-routes trap:

```
ip vrf WORD<1-16> ipv6-max-routes-trap enable
```

Example

```
Switch:1>enable
Switch:1#configure terminal
Switch:1(config)#ip vrf vrfRED ipv6-max-routes-trap enable
```

Variable definitions

Use the data in the following table to use the `ipv6-max-routes-trap` command.

Variable	Value
<code>enable</code>	Enables SNMP trap generation based on the configured number of maximum IPv6 routes. The default is enabled.

Displaying IPv6 max-routes information

About this task

Perform this procedure to display the maximum IPv6 routes configured.

Procedure

1. Enter Privileged EXEC mode:
enable
2. Display max-routes information:
show ip vrf ipv6-max-routes [vrfids WORD<0-512> | WORD<1-16>]

Example

```
Switch:1#show ip vrf ipv6-max-routes
```

```
=====
                          VRF Specific Configuration
=====
VRF-ID      VRF-NAME  CONTEXT-NAME  IPV6-MAX-ROUTES  IPV6-MAX-ROUTES-TRAP  VRF-TRAP
-----
0           GlobalRouter                8000                enable                NA
1           vrfred          vrf1              5000                enable                enable
2           vrfblue         vrf2              5000                enable                enable
```

```
3 out of 3 Total Num of VRF Entries displayed.
```

VRF Lite configuration using EDM

Configuring a VRF instance

About this task

Configure a VRF instance to provide a virtual routing interface for a user.

Procedure

1. In the navigation tree, expand the following folders: **Configuration > VRF**.
2. Click **VRF**.
3. Click the **VRF** tab.
4. Click **Insert**.
5. Specify the VRF ID.
6. Name the VRF instance.

7. Configure VRF Lite-related traps.
8. Configure the other parameters as required.
9. Click **Insert**.

VRF field descriptions

Use the data in the following table to help you use the VRF tab.

Name	Description
Id	Specifies the ID number of the VRF instance. VRF ID 0 is reserved for the GlobalRouter.
Name	Names the VRF instance.
ContextName	Identifies the VRF. The SNMPv2 Community String or SNMPv3 contextName denotes the VRF context and is used to logically separate the MIB port management.
TrapEnable	Enables the VRF to send VRF Lite-related traps (VrfUp and VrfDown). The default is enabled.
MaxRoutes	Configures the maximum number of routes allowed for the VRF, which is 15488 or 15744, depending on your hardware platform. The default value is 10000, except for the GlobalRouter, which is 15488 or 15744, depending on your hardware platform.
RpTrigger	Specifies the Routing Protocol (RP) triggers for the VRF. The triggers are used to initiate or shutdown routing protocols on a VRF. You can act upon multiple RPs simultaneously. You can also use this option to bring individual RPs up in steps.
MaxRoutesTrapEnable	Enables the generation of the VRF Max Routes Exceeded traps. The default is enabled.
Ipv6MaxRoutes	Configures the maximum number of IPv6 routes allowed for the VRF, which is 7744 or 7872, depending on your hardware platform. The default value is 5000.
Ipv6MaxRoutesTrapEnable	Enables SNMP trap generation after the maximum number of IPv6 routes are reached. The default is enabled.

Selecting and launching a VRF context view

About this task

Use this procedure to switch to another VRF context view when you use the embedded EDM. GlobalRouter is the default view at log in. You can configure both Global Router (GRT) and Virtual Routing and Forwarding (VRF) instances when you launch a VRF context view. You can open only five tabs for each EDM session.

! **Important:**

If you log out from the GRT view, the system generates a warning: all tabs close and your session terminates. If you close a VRF view tab, you close only that view.

***** **Note:**

The Set VRF Context view function is not available to users in a service provider deployment where only a tenant VRF view is assigned. If you use a tenant VRF view, it is recommended to use the applicable EDM plugin with COM to access EDM. COM provides VRF mapping and Role-Based Access Control.

Procedure

1. In the navigation pane, expand the following folders: **Configuration > VRF Context View**.
2. Click **Set VRF Context View**.
3. Click the **VRF** tab.
4. Select a context to view.
5. Click **Launch VRF Context view**.

A new browser tab opens containing the selected VRF view

VRF field descriptions

Use the descriptions in the following table to use the **VRF** tab.

Name	Description
Id	Shows the unique VRF ID.
Name	Shows the name of the virtual router.
ContextName	Shows the SNMPv3 context name that denotes the VRF context and logically separates the MIB port management.

Creating an IPv6 VPN instance on a VRF

Create an IPv6 VPN instance to advertise IPv6 routes from a VRF to Shortest Path Bridging MAC (SPBM) network.

For more information about Layer 3 Virtual Services Networks (VSNs) and SPBM, see *Configuring Fabric Layer 3 Services*.

Before you begin

- You must configure the required SPBM IS-IS infrastructure.
- The VRF must exist.

Procedure

1. In the navigation tree, expand the following folders: **Configuration > IPv6**.

2. Click **IPv6-VPN**.
3. Click the **VPN** tab.
4. Click **Insert**.
5. Click the ellipsis [...], and select a VRF from the list.
6. Click **OK**.
7. Click **Insert**.
8. In the **IsidNumber** column, double-click the **0** value, and then enter the service instance identifier (I-SID) to assign to the IPv6-VPN.
9. In the **Enable** column, double-click the value and select **true** or **false** from the drop-down list.
10. Click **Apply**.

VPN field descriptions

Use the data in the following table to use the **VPN** tab.

Name	Description
Vrflid	Specifies the ID of the VRF to configure.
Enable	Enables or disables the IPv6 VPN instance on the VRF. The default is disabled.
IsidNumber	Specifies the I-SID to associate with the IPv6 VPN. By default, no I-SID is assigned.

Appendix A: ICMPv6 type and code

The Internet Control Message Protocol (ICMPv6) uses many messages identified by a type and code field (see RFC 4443). Error messages use message types 0 to 127. Informational messages use message types 128 to 255. The following table provides the type and code reference.

Table 13: ICMPv6 type and code details

Type	Name	Code	Reference
1	Destination Unreachable	0—no route to destination 1—communication with destination administratively prohibited 2—(not assigned) 3—address unreachable 4—port unreachable	RFC 4443
2	Packet Too Big	N/A	RFC 4443
3	Time Exceeded	0—hop limit exceeded in transit 1—fragment reassembly time exceeded	RFC 4443
4	Parameter Problem	0—erroneous header field encountered 1—unrecognized Next Header type encountered 2—unrecognized IPv6 option encountered	RFC 4443
128	Echo Request	N/A	RFC 4443
129	Echo Reply	N/A	RFC 4443
130	Multicast Listener Query	N/A	
131	Multicast Listener Report	N/A	
132	Multicast Listener Done	N/A	
133	Router Solicitation	N/A	RFC 4861

Table continues...

ICMPv6 type and code

Type	Name	Code	Reference
134	Router Advertisement	N/A	RFC 4861
135	Neighbor Solicitation	N/A	RFC 4861
136	Neighbor Advertisement	N/A	RFC 4861
137	Redirect Message	N/A	RFC 4861
138	Router Renumbering	0—router renumbering command 1—router renumbering result 255—sequence number reset	
139	ICMP Node Information Query	N/A	
140	ICMP Node Information Response	N/A	
141	Inverse neighbor discovery Solicitation Message	N/A	RFC 3122
142	Inverse neighbor discovery Advertisement Message	N/A	RFC 3122
143	Version 2 Multicast Listener Report	N/A	RFC 3810
144	Home Agent Address Discovery Request Message	N/A	RFC 3775
145	Home Agent Address Discovery Reply Message	N/A	RFC 3775
146	Mobile Prefix Solicitation	N/A	RFC 3775
147	Mobile Prefix Advertisement	N/A	RFC 3775

Glossary

All_DHCP_Relay_Agents_and_Servers (FF02::1:2)	A link-scoped multicast address used by a client to communicate with neighboring relay agents and servers. All servers and relay agents are members of this multicast group.
Dual stack	Supports both the IPv4 and IPv6 protocol.
Extended Unique Identifier (EUI)	A 64-bit format used in assigning addresses automatically to IPv6 interfaces.
route table manager (RTM)	Determines the best route to a destination based on reachability, route preference, and cost.
Spanning Tree Group (STG)	A collection of ports in one spanning-tree instance.
stateless address autoconfiguration (SLAAC)	Uses a mathematical equation to automatically configure and assign IPv6 addresses to hosts or nodes on a network. RFC 4862 describes SLAAC.