



Configuring Fabric Basics and Layer 2 Services on VSP Operating System Software

Release 6.2 (VSP 8600)
9035580
September 2018

© 2018, Extreme Networks, Inc.
All Rights Reserved.

Notice

While reasonable efforts have been made to ensure that the information in this document is complete and accurate at the time of printing, Extreme Networks, Inc. assumes no liability for any errors. Extreme Networks, Inc. reserves the right to make changes and corrections to the information in this document without the obligation to notify any person or organization of such changes.

Documentation disclaimer

"Documentation" means information published in varying mediums which may include product information, operating instructions and performance specifications that are generally made available to users of products. Documentation does not include marketing materials. Extreme Networks shall not be responsible for any modifications, additions, or deletions to the original published version of Documentation unless such modifications, additions, or deletions were performed by or on the express behalf of Extreme Networks. End User agrees to indemnify and hold harmless Extreme Networks, Extreme Networks' agents, servants and employees against all claims, lawsuits, demands and judgments arising out of, or in connection with, subsequent modifications, additions or deletions to this documentation, to the extent made by End User.

Link disclaimer

Extreme Networks is not responsible for the contents or reliability of any linked websites referenced within this site or Documentation provided by Extreme Networks. Extreme Networks is not responsible for the accuracy of any information, statement or content provided on these sites and does not necessarily endorse the products, services, or information described or offered within them. Extreme Networks does not guarantee that these links will work all the time and has no control over the availability of the linked pages.

Warranty

Extreme Networks provides a limited warranty on Extreme Networks hardware and software. Refer to your sales agreement to establish the terms of the limited warranty. In addition, Extreme Networks' standard warranty language, as well as information regarding support for this product while under warranty is available to Extreme Networks customers and other parties through the Extreme Networks Support website: www.extremenetworks.com/support/ under the link "Policies" or such successor site as designated by Extreme Networks. Please note that if You acquired the product(s) from an authorized Extreme Networks Channel Partner outside of the United States and Canada, the warranty is provided to You by said Extreme Networks Channel Partner and not by Extreme Networks.

"Hosted Service" means an Extreme Networks hosted service subscription that You acquire from either Extreme Networks or an authorized Extreme Networks Channel Partner (as applicable) and which is described further in Hosted SAS or other service description documentation regarding the applicable hosted service. If You purchase a Hosted Service subscription, the foregoing limited warranty may not apply but You may be entitled to support services in connection with the Hosted Service as described further in your service description documents for the applicable Hosted Service. Contact Extreme Networks or Extreme Networks Channel Partner (as applicable) for more information.

Hosted Service

THE FOLLOWING APPLIES ONLY IF YOU PURCHASE AN EXTREME NETWORKS HOSTED SERVICE SUBSCRIPTION FROM EXTREME NETWORKS OR AN EXTREME NETWORKS CHANNEL PARTNER (AS APPLICABLE), THE TERMS OF USE FOR HOSTED SERVICES ARE AVAILABLE ON THE EXTREME NETWORKS WEBSITE, <https://extremeportal.force.com/> OR SUCH SUCCESSOR SITE AS DESIGNATED BY EXTREME NETWORKS, AND ARE APPLICABLE TO ANYONE WHO ACCESSES OR USES THE HOSTED SERVICE. BY ACCESSING OR USING THE HOSTED SERVICE, OR AUTHORIZING OTHERS TO DO SO, YOU, ON BEHALF OF YOURSELF AND THE ENTITY FOR WHOM YOU ARE DOING SO (HEREINAFTER REFERRED TO INTERCHANGEABLY AS "YOU" AND "END USER"), AGREE TO THE TERMS OF USE. IF YOU ARE ACCEPTING THE TERMS OF USE ON BEHALF A COMPANY OR OTHER LEGAL ENTITY, YOU

REPRESENT THAT YOU HAVE THE AUTHORITY TO BIND SUCH ENTITY TO THESE TERMS OF USE. IF YOU DO NOT HAVE SUCH AUTHORITY, OR IF YOU DO NOT WISH TO ACCEPT THESE TERMS OF USE, YOU MUST NOT ACCESS OR USE THE HOSTED SERVICE OR AUTHORIZE ANYONE TO ACCESS OR USE THE HOSTED SERVICE.

Licenses

THE SOFTWARE LICENSE TERMS AVAILABLE ON THE EXTREME NETWORKS WEBSITE, <https://extremeportal.force.com/> OR SUCH SUCCESSOR SITE AS DESIGNATED BY EXTREME NETWORKS, ARE APPLICABLE TO ANYONE WHO DOWNLOADS, USES AND/OR INSTALLS EXTREME NETWORKS SOFTWARE, PURCHASED FROM EXTREME NETWORKS, INC., ANY EXTREME NETWORKS AFFILIATE, OR AN EXTREME NETWORKS CHANNEL PARTNER (AS APPLICABLE) UNDER A COMMERCIAL AGREEMENT WITH EXTREME NETWORKS OR AN EXTREME NETWORKS CHANNEL PARTNER. UNLESS OTHERWISE AGREED TO BY EXTREME NETWORKS IN WRITING, EXTREME NETWORKS DOES NOT EXTEND THIS LICENSE IF THE SOFTWARE WAS OBTAINED FROM ANYONE OTHER THAN EXTREME NETWORKS, AN EXTREME NETWORKS AFFILIATE OR AN EXTREME NETWORKS CHANNEL PARTNER; EXTREME NETWORKS RESERVES THE RIGHT TO TAKE LEGAL ACTION AGAINST YOU AND ANYONE ELSE USING OR SELLING THE SOFTWARE WITHOUT A LICENSE. BY INSTALLING, DOWNLOADING OR USING THE SOFTWARE, OR AUTHORIZING OTHERS TO DO SO, YOU, ON BEHALF OF YOURSELF AND THE ENTITY FOR WHOM YOU ARE INSTALLING, DOWNLOADING OR USING THE SOFTWARE (HEREINAFTER REFERRED TO INTERCHANGEABLY AS "YOU" AND "END USER"), AGREE TO THESE TERMS AND CONDITIONS AND CREATE A BINDING CONTRACT BETWEEN YOU AND EXTREME NETWORKS, INC. OR THE APPLICABLE EXTREME NETWORKS AFFILIATE ("EXTREME NETWORKS").

Extreme Networks grants You a license within the scope of the license types described below. Where the order documentation does not expressly identify a license type, the applicable license will be a Designated System License as set forth below in the Designated System(s) License (DS) section as applicable. The applicable number of licenses and units of capacity for which the license is granted will be one (1), unless a different number of licenses or units of capacity is specified in the documentation or other materials available to You. "Software" means computer programs in object code, provided by Extreme Networks or an Extreme Networks Channel Partner, whether as stand-alone products, pre-installed on hardware products, and any upgrades, updates, patches, bug fixes, or modified versions thereto. "Designated Processor" means a single stand-alone computing device. "Server" means a set of Designated Processors that hosts (physically or virtually) a software application to be accessed by multiple users. "Instance" means a single copy of the Software executing at a particular time: (i) on one physical machine; or (ii) on one deployed software virtual machine ("VM") or similar deployment.

License type(s)

Designated System(s) License (DS). End User may install and use each copy or an Instance of the Software only: 1) on a number of Designated Processors up to the number indicated in the order; or 2) up to the number of Instances of the Software as indicated in the order, Documentation, or as authorized by Extreme Networks in writing. Extreme Networks may require the Designated Processor(s) to be identified in the order by type, serial number, feature key, Instance, location or other specific designation, or to be provided by End User to Extreme Networks through electronic means established by Extreme Networks specifically for this purpose.

Copyright

Except where expressly stated otherwise, no use should be made of materials on this site, the Documentation, Software, Hosted Service, or hardware provided by Extreme Networks. All content on this site, the documentation, Hosted Service, and the product provided by Extreme Networks including the selection, arrangement and design of the content is owned either by Extreme Networks or its licensors and is protected by copyright and other intellectual property laws including the sui generis rights relating to the protection of databases. You may not modify, copy, reproduce, republish, upload, post, transmit or distribute in any way any content, in whole or in part,

including any code and software unless expressly authorized by Extreme Networks. Unauthorized reproduction, transmission, dissemination, storage, and/or use without the express written consent of Extreme Networks can be a criminal, as well as a civil offense under the applicable law.

Virtualization

The following applies if the product is deployed on a virtual machine. Each product has its own ordering code and license types. Note, unless otherwise stated, that each Instance of a product must be separately licensed and ordered. For example, if the end user customer or Extreme Networks Channel Partner would like to install two Instances of the same type of products, then two products of that type must be ordered.

Third Party Components

"Third Party Components" mean certain software programs or portions thereof included in the Software or Hosted Service may contain software (including open source software) distributed under third party agreements ("Third Party Components"), which contain terms regarding the rights to use certain portions of the Software ("Third Party Terms"). As required, information regarding distributed Linux OS source code (for those products that have distributed Linux OS source code) and identifying the copyright holders of the Third Party Components and the Third Party Terms that apply is available in the products, Documentation or on Extreme Networks' website at: <https://extremeportal.force.com/ExtrLicenseLanding> or such successor site as designated by Extreme Networks. The open source software license terms provided as Third Party Terms are consistent with the license rights granted in these Software License Terms, and may contain additional rights benefiting You, such as modification and distribution of the open source software. The Third Party Terms shall take precedence over these Software License Terms, solely with respect to the applicable Third Party Components to the extent that these Software License Terms impose greater restrictions on You than the applicable Third Party Terms.

The following applies only if the H.264 (AVC) codec is distributed with the product. THIS PRODUCT IS LICENSED UNDER THE AVC PATENT PORTFOLIO LICENSE FOR THE PERSONAL USE OF A CONSUMER OR OTHER USES IN WHICH IT DOES NOT RECEIVE REMUNERATION TO (i) ENCODE VIDEO IN COMPLIANCE WITH THE AVC STANDARD ("AVC VIDEO") AND/OR (ii) DECODE AVC VIDEO THAT WAS ENCODED BY A CONSUMER ENGAGED IN A PERSONAL ACTIVITY AND/OR WAS OBTAINED FROM A VIDEO PROVIDER LICENSED TO PROVIDE AVC VIDEO. NO LICENSE IS GRANTED OR SHALL BE IMPLIED FOR ANY OTHER USE. ADDITIONAL INFORMATION MAY BE OBTAINED FROM MPEG LA, L.L.C. SEE [HTTP://WWW.MPEGLA.COM](http://WWW.MPEGLA.COM).

Service Provider

THE FOLLOWING APPLIES TO EXTREME NETWORKS CHANNEL PARTNER'S HOSTING OF EXTREME NETWORKS PRODUCTS OR SERVICES. THE PRODUCT OR HOSTED SERVICE MAY USE THIRD PARTY COMPONENTS SUBJECT TO THIRD PARTY TERMS AND REQUIRE A SERVICE PROVIDER TO BE INDEPENDENTLY LICENSED DIRECTLY FROM THE THIRD PARTY SUPPLIER. AN EXTREME NETWORKS CHANNEL PARTNER'S HOSTING OF EXTREME NETWORKS PRODUCTS MUST BE AUTHORIZED IN WRITING BY EXTREME NETWORKS AND IF THOSE HOSTED PRODUCTS USE OR EMBED CERTAIN THIRD PARTY SOFTWARE, INCLUDING BUT NOT LIMITED TO MICROSOFT SOFTWARE OR CODECS, THE EXTREME NETWORKS CHANNEL PARTNER IS REQUIRED TO INDEPENDENTLY OBTAIN ANY APPLICABLE LICENSE AGREEMENTS, AT THE EXTREME NETWORKS CHANNEL PARTNER'S EXPENSE, DIRECTLY FROM THE APPLICABLE THIRD PARTY SUPPLIER.

WITH RESPECT TO CODECS, IF THE EXTREME NETWORKS CHANNEL PARTNER IS HOSTING ANY PRODUCTS THAT USE OR EMBED THE G.729 CODEC, H.264 CODEC, OR H.265 CODEC, THE EXTREME NETWORKS CHANNEL PARTNER ACKNOWLEDGES AND AGREES THE EXTREME NETWORKS CHANNEL PARTNER IS RESPONSIBLE FOR ANY AND ALL RELATED FEES AND/OR ROYALTIES. THE G.729 CODEC IS LICENSED BY SIPRO LAB TELECOM INC. SEE WWW.SIPRO.COM/CONTACT.HTML. THE H.264 (AVC) CODEC IS LICENSED UNDER THE AVC PATENT PORTFOLIO LICENSE FOR

THE PERSONAL USE OF A CONSUMER OR OTHER USES IN WHICH IT DOES NOT RECEIVE REMUNERATION TO: (I) ENCODE VIDEO IN COMPLIANCE WITH THE AVC STANDARD ("AVC VIDEO") AND/OR (II) DECODE AVC VIDEO THAT WAS ENCODED BY A CONSUMER ENGAGED IN A PERSONAL ACTIVITY AND/OR WAS OBTAINED FROM A VIDEO PROVIDER LICENSED TO PROVIDE AVC VIDEO. NO LICENSE IS GRANTED OR SHALL BE IMPLIED FOR ANY OTHER USE. ADDITIONAL INFORMATION FOR H.264 (AVC) AND H.265 (HEVC) CODECS MAY BE OBTAINED FROM MPEG LA, L.L.C. SEE [HTTP://WWW.MPEGLA.COM](http://WWW.MPEGLA.COM).

Compliance with Laws

You acknowledge and agree that it is Your responsibility for complying with any applicable laws and regulations, including, but not limited to laws and regulations related to call recording, data privacy, intellectual property, trade secret, fraud, and music performance rights, in the country or territory where the Extreme Networks product is used.

Preventing Toll Fraud

"Toll Fraud" is the unauthorized use of your telecommunications system by an unauthorized party (for example, a person who is not a corporate employee, agent, subcontractor, or is not working on your company's behalf). Be aware that there can be a risk of Toll Fraud associated with your system and that, if Toll Fraud occurs, it can result in substantial additional charges for your telecommunications services.

Security Vulnerabilities

Information about Extreme Networks' security support policies can be found in the Global Technical Assistance Center Knowledgebase at <https://gtacknowledge.extremenetworks.com/>.

Downloading Documentation

For the most current versions of Documentation, see the Extreme Networks Support website: www.extremenetworks.com/documentation/, or such successor site as designated by Extreme Networks.

Contact Extreme Networks Support

See the Extreme Networks Support website: www.extremenetworks.com/support/ for product or Hosted Service notices and articles, or to report a problem with your Extreme Networks product or Hosted Service. For the support phone number in your country, visit: www.extremenetworks.com/support/contact (or such successor site as designated by Extreme Networks), scroll to the bottom of the page, and select Contact Extreme Networks Support.

Trademarks

The trademarks, logos and service marks ("Marks") displayed in this site, the Documentation, Hosted Service(s), and product(s) provided by Extreme Networks are the registered or unregistered Marks of Extreme Networks, Inc., its affiliates, its licensors, its suppliers, or other third parties. Users are not permitted to use such Marks without prior written consent from Extreme Networks or such third party which may own the Mark. Nothing contained in this site, the Documentation, Hosted Service(s) and product(s) should be construed as granting, by implication, estoppel, or otherwise, any license or right in and to the Marks without the express written permission of Extreme Networks or the applicable third party.

Extreme Networks is a registered trademark of Extreme Networks, Inc.

All non-Extreme Networks trademarks are the property of their respective owners. Linux[®] is the registered trademark of Linus Torvalds in the U.S. and other countries.

For additional information on Extreme Networks trademarks, please see: www.extremenetworks.com/company/legal/

Contents

Chapter 1: Preface	8
Purpose.....	8
Training.....	8
Providing Feedback to Us.....	8
Getting Help.....	9
Documentation and Training.....	10
Subscribing to Service Notifications.....	10
Chapter 2: New in this Document	12
Notice about Feature Support.....	12
Chapter 3: SPBM and IS-IS configuration workflow	13
Chapter 4: SPBM and IS-IS infrastructure configuration	14
SPBM and IS-IS infrastructure fundamentals.....	14
spbm-config-mode boot flag.....	17
vxlan-gw-full-interworking-mode boot flag.....	18
MAC-in-MAC encapsulation.....	18
I-SID.....	18
BCBs and BEBs.....	19
VLANs without member ports.....	20
Basic SPBM network topology.....	20
E-Tree and Private VLAN topology.....	21
IS-IS.....	23
Standard TLVs.....	24
IS-IS hierarchies.....	26
IS-IS PDUs.....	27
IS-IS configuration parameters.....	27
SPBM B-VLAN.....	30
Pre-populated FIB.....	31
RPFC.....	31
SPBM FIB.....	31
SPBM restrictions and limitations.....	32
Network Load Balancing (NLB)	35
SPBM script.....	35
Layer 2 Video Surveillance install script.....	36
Fabric Extend.....	37
Fabric Attach.....	55
IS-IS external metric.....	72
SPB Ethertype	72
Zero Touch Fabric configuration.....	72
Dynamic Nickname Assignment.....	75

MSTP-Fabric Connect Multi Homing.....	78
SPBM and IS-IS infrastructure configuration using CLI.....	78
Running the SPBM script.....	79
Removing existing SPBM configuration.....	80
Configuring the IS-IS port interfaces using SPBM script.....	81
Removing specific IS-IS and MLT interfaces.....	82
Configuring minimum SPBM and IS-IS parameters.....	83
Configuring minimum SPBM and IS-IS parameters using auto-nni command.....	88
Configuring I-SIDs for private VLANs.....	91
Displaying global SPBM parameters.....	92
Displaying global IS-IS parameters.....	94
Displaying IS-IS areas.....	96
Configuring SMLT parameters for SPBM.....	97
Configuring optional SPBM parameters.....	99
Configuring optional IS-IS global parameters.....	101
Configuring optional IS-IS interface parameters.....	106
Displaying IS-IS interface parameters.....	108
Displaying the IP unicast FIB, multicast FIB, unicast FIB, and unicast tree.....	111
Displaying IS-IS LSDB and adjacencies.....	116
Displaying IS-IS Statistics and Counters.....	119
Running the Layer 2 Video Surveillance install script.....	122
Fabric Extend configuration using the CLI.....	124
Fabric Attach configuration using the CLI.....	132
IS-IS external metric configuration using the CLI.....	162
Suspending duplicate system ID detection when replacing a switch.....	166
Configuring a Dynamic Nickname Assignment nickname allocation range.....	166
Displaying Dynamic Nickname Assignment.....	167
Enabling MSTP-Fabric Connect Multi Homing.....	168
SPBM and IS-IS infrastructure configuration using EDM.....	169
Configuring required SPBM and IS-IS parameters.....	169
Displaying SPBM and IS-IS summary information.....	174
Displaying the SPBM I-SID information.....	176
Displaying Level 1 Area information.....	176
Configuring SMLT parameters for SPBM.....	177
Enabling or disabling SPBM at the global level.....	178
Configuring SPBM parameters.....	178
Displaying SPBM nicknames.....	180
Configuring interface SPBM parameters.....	180
Configuring SPBM on an interface.....	181
Displaying the IP unicast FIB.....	182
Displaying the IPv6 unicast FIB.....	183
Displaying the unicast FIB.....	184
Displaying LSP summary information.....	185

Displaying IS-IS adjacencies.....	185
Configuring IS-IS global parameters.....	186
Configuring system-level IS-IS parameters.....	188
Displaying IS-IS system statistics.....	189
Configuring IS-IS interfaces.....	190
Configuring IS-IS interface level parameters.....	192
Displaying IS-IS interface counters.....	193
Displaying IS-IS interface control packets.....	194
Graphing IS-IS interface counters.....	195
Graphing IS-IS interface sending control packet statistics.....	196
Graphing IS-IS interface receiving control packet statistics.....	197
Configuring an IS-IS Manual Area.....	198
Fabric Extend configuration using EDM.....	198
Fabric Attach configuration using the EDM.....	204
Configuring Dynamic Nickname Assignment.....	220
SPBM configuration examples.....	221
Basic SPBM configuration example.....	221
Ethernet and MLT configuration.....	222
IS-IS SPBM global configuration.....	222
IS-IS SPBM Interface Configuration.....	224
Verifying SPBM operations.....	225
Fabric Extend configuration examples.....	227
Fabric Extend over IP using the GRT.....	227
Fabric Extend over IP using a VRF.....	230
Fabric Extend over VPLS.....	233
Fabric Extend over Layer 2 Pseudowire.....	236
Fabric Extend with ONAs in the core and branches.....	238
Fabric Attach configuration examples.....	241
Configuring a Fabric Attach solution.....	241
Configuring Fabric Attach in an SMLT.....	246
Chapter 5: Layer 2 VSN configuration.....	256
Layer 2 VSN configuration fundamentals.....	256
SPBM L2 VSN.....	256
SPBM sample operation—L2 VSN.....	263
Layer 2 VSN configuration using the CLI.....	269
Configuring SPBM Layer 2 VSN.....	269
Displaying C-VLAN I-SID information.....	270
Configuring an SPBM Layer 2 Transparent Port UNI.....	274
Viewing all Configured I-SIDs.....	277
Viewing C-MACs Learned on T-UNI Ports for an I-SID.....	280
Viewing I-SID maximum MAC-limit.....	283
Configuring an SPBM Layer 2 Switched UNI on an MLT.....	284
Configuring an SPBM Layer 2 Switched UNI on a Port.....	286

Viewing all configured Switched UNI I-SIDs.....	288
Displaying C-VLAN and Switched UNI I-SID information.....	292
Layer 2 VSN configuration using EDM.....	295
Configuring SPBM Layer 2 VSN.....	295
Displaying the remote MAC table for a C-VLAN.....	296
Configuring UNI.....	297
Associating a port and MLT with an ISID for Elan Transparent.....	299
Viewing the ISID forwarding database.....	300
Associating a port and MLT with an I-SID for Elan.....	301
Viewing the I-SID interface.....	302
Layer 2 VSN configuration examples.....	302
Layer 2 VSN configuration example.....	303
Verifying Layer 2 VSN operation.....	303
Layer 2 VSN example with VLAN ID translation.....	305
Chapter 6: Inter-VSN routing configuration.....	307
Inter-VSN routing configuration fundamentals.....	307
Inter-VSN routing.....	307
Inter-VSN routing configuration using the CLI.....	308
Configuring SPBM Inter-VSN Routing.....	308
Inter-VSN routing configuration using EDM.....	311
Configuring BEBs for Inter-VSN routing.....	311
Configuring BCBs for Inter-VSN routing.....	315
Inter-VSN routing configuration example.....	321
Inter-VSN routing with SPBM configuration example.....	321
Verifying Inter-VSN Routing operation.....	323
Appendix A: SPBM reference architectures.....	325
Reference architectures.....	325
Solution-specific reference architectures.....	334
Glossary.....	340

Chapter 1: Preface

Purpose

This document provides information on features in VSP Operating System Software (VOSS). VOSS runs on the following product families:

- Extreme Networks Virtual Services Platform 4000 Series
- Extreme Networks Virtual Services Platform 7200 Series
- Extreme Networks Virtual Services Platform 8000 Series (includes VSP 8200 and VSP 8400 Series)
- Extreme Networks Virtual Services Platform 8600

This document provides information and instructions to configure Fabric basics and Layer 2 services on the switch.

Training

Ongoing product training is available. For more information or to register, you can access the Web site at www.extremenetworks.com/education/.

Providing Feedback to Us

Quality is our first concern at Extreme Networks, and we have made every effort to ensure the accuracy and completeness of this document. We are always striving to improve our documentation and help you work better, so we want to hear from you! We welcome all feedback but especially want to know about:

- Content errors or confusing or conflicting information.
- Ideas for improvements to our documentation so you can find the information you need faster.
- Broken links or usability issues.

If you would like to provide feedback to the Extreme Networks Information Development team, you can do so in two ways:

- Use our short online feedback form at <https://www.extremenetworks.com/documentation-feedback/>.
- Email us at documentation@extremenetworks.com.

Please provide the publication title, part number, and as much detail as possible, including the topic heading and page number if applicable, as well as your suggestions for improvement.

Getting Help

If you require assistance, contact Extreme Networks using one of the following methods:

- **GTAC (Global Technical Assistance Center) for Immediate Support**
 - **Phone:** 1-800-998-2408 (toll-free in U.S. and Canada) or +1 408-579-2826. For the support phone number in your country, visit: www.extremenetworks.com/support/contact
 - **Email:** support@extremenetworks.com. To expedite your message, enter the product name or model number in the subject line.
- **Extreme Portal** — Search the GTAC knowledge base, manage support cases and service contracts, download software, and obtain product licensing, training, and certifications.
- **The Hub** — A forum for Extreme Networks customers to connect with one another, answer questions, and share ideas and feedback. This community is monitored by Extreme Networks employees, but is not intended to replace specific guidance from GTAC.

Before contacting Extreme Networks for technical support, have the following information ready:

- Your Extreme Networks service contract number and/or serial numbers for all involved Extreme Networks products
- A description of the failure
- A description of any action(s) already taken to resolve the problem
- A description of your network environment (such as layout, cable type, other relevant environmental information)
- Network load at the time of trouble (if known)
- The device history (for example, if you have returned the device before, or if this is a recurring problem)
- Any related RMA (Return Material Authorization) numbers

Subscribing to Service Notifications

You can subscribe to email notifications for product and software release announcements, Vulnerability Notices, and Service Notifications.

1. Go to www.extremenetworks.com/support/service-notification-form.
2. Complete the form with your information (all fields are required).
3. Select the products for which you would like to receive notifications.

*** Note:**

You can modify your product selections or unsubscribe at any time.

4. Click **Submit**.

Documentation and Training

To find Extreme Networks product guides, visit our documentation pages at:

Current Product Documentation	www.extremenetworks.com/documentation/
Archived Documentation (for earlier versions and legacy products)	www.extremenetworks.com/support/documentation-archives/
Release Notes	www.extremenetworks.com/support/release-notes
Hardware/Software Compatibility Matrices	https://www.extremenetworks.com/support/compatibility-matrices/
White papers, data sheets, case studies, and other product resources	https://www.extremenetworks.com/resources/

Open Source Declarations

Some software files have been licensed under certain open source licenses. More information is available at: www.extremenetworks.com/support/policies/open-source-declaration/.

Training

Extreme Networks offers product training courses, both online and in person, as well as specialized certifications. For more information, visit www.extremenetworks.com/education/.

Subscribing to Service Notifications

Subscribe to receive an email notification for product and software release announcements, Vulnerability Notices, and Service Notifications.

About this task

You can modify your product selections at any time.

Procedure

1. In an Internet browser, go to <http://www.extremenetworks.com/support/service-notification-form/>.
2. Type your first and last name.
3. Type the name of your company.
4. Type your email address.
5. Type your job title.
6. Select the industry in which your company operates.
7. Confirm your geographic information is correct.
8. Select the products for which you would like to receive notifications.
9. Click **Submit**.

Chapter 2: New in this Document

The following sections detail what is new in *Configuring Fabric Basics and Layer 2 Services*.

IP Multicast over Fabric Connect

This release introduces support for IP Multicast over Fabric Connect.

Extreme Networks is leading the industry with a unique approach for IP multicast routing using IP Multicast over Fabric Connect. IP Multicast over Fabric Connect greatly simplifies multicast deployment, with no need for any multicast routing protocols such as Protocol Independent Multicast-Sparse Mode (PIM-SM) or Protocol Independent Multicast-Source Specific Multicast (PIM-SSM). A BEB can forward a multicast stream anywhere in an SPBM network where IS-IS advertises the stream to the rest of the fabric.

For more information, see *Configuring Fabric Multicast Services*.

Notice about Feature Support

This document includes content for multiple hardware platforms across different software releases. As a result, the content can include features not supported by your hardware in the current software release.

If a documented command, parameter, tab, or field does not appear on your hardware, it is not supported.

For information about feature support, see *Release Notes*.

For information about physical hardware restrictions, see your hardware documentation.

Chapter 3: SPBM and IS-IS configuration workflow

The following section describes the generic work flow to configure SPBM and IS-IS infrastructure and services on your network.

 **Note:**

This section is an overview. For further details on the SPBM and IS-IS infrastructure and configuration, see the documents described in the Documentation sources section below.

1. Infrastructure configuration:

As a first step, you must configure your basic infrastructure for Shortest Path Bridging MAC (SPBM).

2. Services configuration:

After you complete the infrastructure configuration, you configure the appropriate services for your network to run on top of your base architecture. This includes:

- Layer 2 and Layer 3 VSNs
- IP Shortcuts
- Inter-VSN routing

3. Operations and Management:

To debug connectivity issues and isolate network faults in the SPBM network, you can use Connectivity Fault Management (CFM).

Chapter 4: SPBM and IS-IS infrastructure configuration

This chapter provides concepts and procedures to configure the basic infrastructure for Shortest Path Bridging MAC (SPBM).

SPBM and IS-IS infrastructure fundamentals

Shortest Path Bridging MAC (SPBM) is a next generation virtualization technology that revolutionizes the design, deployment, and operations of carriers and service providers, along with enterprise campus core networks and the enterprise data center. SPBM provides massive scalability while at the same time reducing the complexity of the network.

SPBM eliminates the need for multiple overlay protocols in the core of the network by reducing the core to a single Ethernet based link-state protocol that provides all virtualization services in an integrated model. In addition, by relying on endpoint service provisioning only, the idea of building your network once and not touching it again becomes a true reality. This technology provides all the features and benefits required by carrier-grade, enterprise and service provider deployments without the complexity of alternative technologies, for example, Multiprotocol Label Switching (MPLS).

SPBM simplifies deployments by eliminating the need to configure multiple points throughout the network. When you add new connectivity services to an SPBM network you do not need intrusive core provisioning. The simple endpoint provisioning is done where the application meets the network, with all points in between automatically provisioned through the robust link-state protocol, Intermediate-System-to-Intermediate-System (IS-IS).

Most Ethernet based networks use 802.1Q tagged interfaces between the routing switches. SPBM uses two Backbone VLANs (BVLANS) that are used as the transport instance. A B-VLAN is not a traditional VLAN in the sense that it does not flood unknown, broadcast or multicast traffic, but only forwards based on IS-IS provisioned backbone MAC (B-MAC) tables. After you configure the B-VLANs and the IS-IS protocol is operational, you can map the services to service instances.

SPBM uses IS-IS to discover and advertise the network topology, which enables it to compute the shortest path to all nodes in the SPBM network. SPBM uses IS-IS shortest path trees to populate forwarding tables for the individual B-MAC addresses of each participating node.

To forward customer traffic across the core network backbone, SPBM uses IEEE 802.1ah Provider Backbone Bridging (PBB) MAC-in-MAC encapsulation, which hides the customer MAC (C-MAC) addresses in a backbone MAC (B-MAC) address pair. MAC-in-MAC encapsulation defines a B-MAC destination address (BMAC-DA) and a B-MAC source address (BMAC-SA). Encapsulating customer

MAC addresses in B-MAC addresses improves network scalability (no end-user C-MAC learning is required in the core) and also significantly improves network robustness (loops have no effect on the backbone infrastructure.)

The SPBM B-MAC header includes a Service Instance Identifier (I-SID) with a length of 32 bits with a 24-bit ID. I-SIDs identify and transmit virtualized traffic in an encapsulated SPBM frame. You can use I-SIDs in a Virtual Services Network (VSN) for VLANs or VRFs across the MAC-in-MAC backbone:

- **Unicast**

- For a Layer 2 VSN, the device associates the I-SID with a customer VLAN, which the device then virtualizes across the backbone. Layer 2 VSNs associate one VLAN per I-SID.
- With Layer 3 VSN, the device associates the I-SID with a customer VRF, which the device virtualizes across the backbone. Layer 3 VSNs associate one VRF per I-SID.
- With Inter-VSN routing, Layer 3 devices, routers, or hosts connect to the SPBM cloud using the SPBM Layer 2 VSN service. The Backbone Core Bridge can transmit traffic between different VLANs with different I-SIDs.
- With IP shortcuts, no I-SID is required, forwarding for the Global Routing Table (GRT) is done using IS-IS based shortest path B-MAC reachability.

For more information on Fabric Layer 3 services, see *Configuring Fabric Layer 3 Services*.

- **Multicast**

- With Layer 2 VSN with IP multicast over Fabric Connect, the BEB associates a data I-SID with the multicast stream and the scope I-SID is based on the Layer 2 VSN I-SID.
- With Layer 3 VSN with IP multicast over Fabric Connect, the BEB associates a data I-SID with the multicast stream and the scope I-SID is based on the Layer 3 VSN I-SID.
- With IP Shortcuts with IP multicast over Fabric Connect, the BEB associates a data I-SID with the multicast stream, but there is no I-SID for the scope, which is the Global Routing Table (GRT).

For more information on IP multicast over Fabric Connect, see *Configuring Fabric Multicast Services*.

- **Note:**

Inter-VSN routing for IP multicast over Fabric Connect is not supported.

The switch supports the IEEE 802.1aq standard of SPBM, which allows for larger Layer 2 topologies and permits faster convergence.

Multiple tenants using different SPBM services

The following figure shows multiple tenants using different services within an SPBM metro network. In this network, you can use some or all of the SPBM implementation options to meet the needs of the community while maintaining the security of information within VLAN members.

Large
Campus/
Multi-tenant

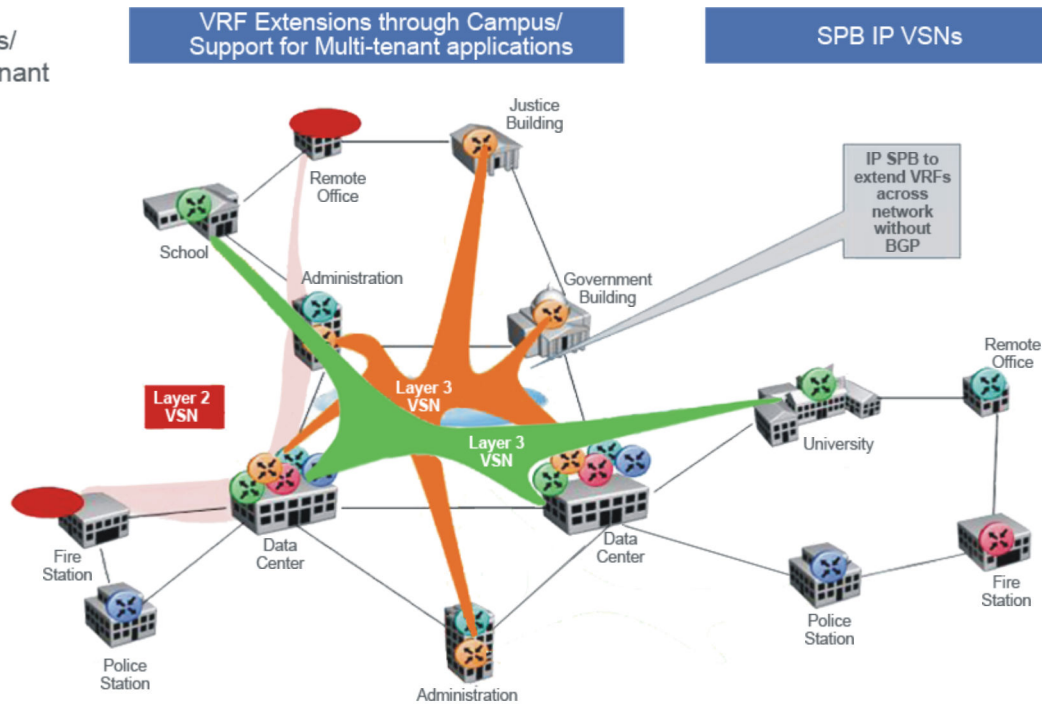

Figure 1: Multi-tenant SPBM metro network

To illustrate the versatility and robustness of SPBM even further, the following figure shows a logical view of multiple tenants in a ring topology. In this architecture, each tenant has its own domain where some users have VLAN requirements and are using Layer 2 VSNs and others have VRF requirements and are using Layer 3 VSNs. In all three domains, they can share data center resources across the SPBM network.

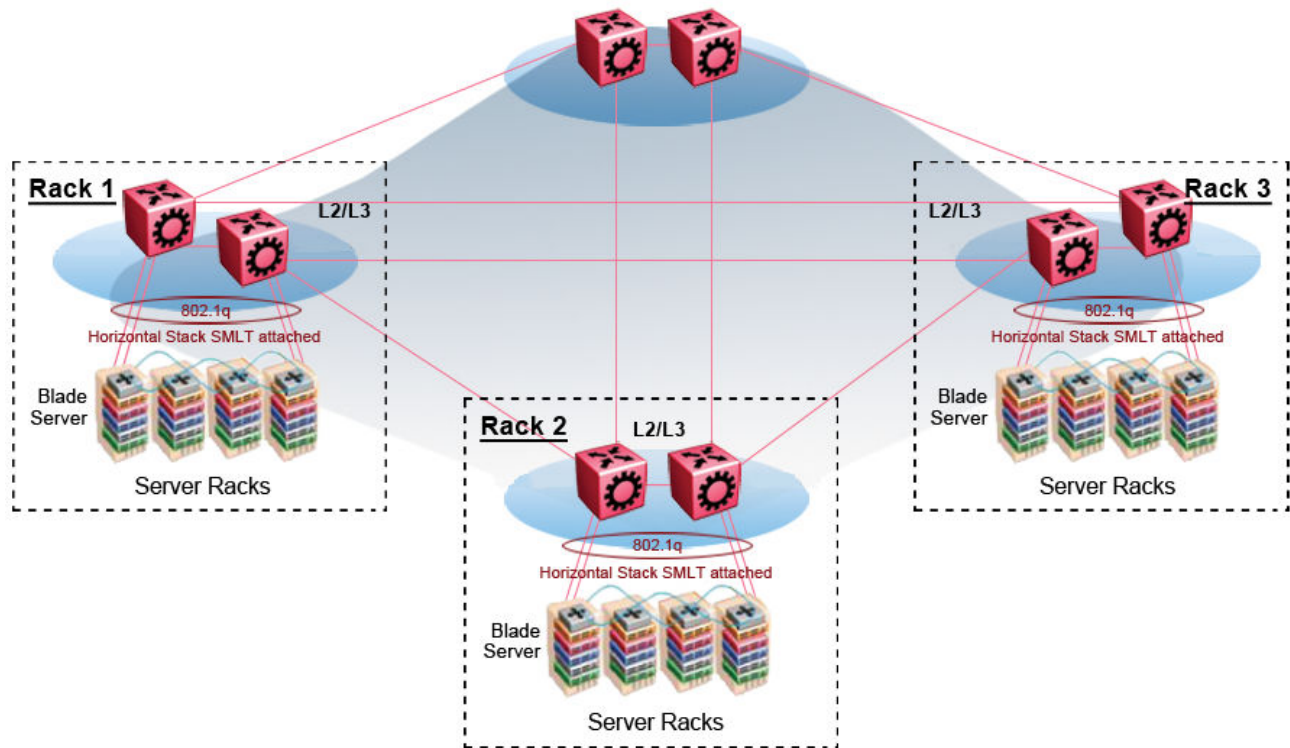

Figure 2: SPBM ring topology with shared data centers

spbm-config-mode boot flag

Shortest Path Bridging (SPB) and Protocol Independent Multicast (PIM) cannot interoperate with each other on the switch at the same time. The boot flag called `spbm-config-mode` ensures that SPB and PIM stay mutually exclusive.

- The `spbm-config-mode` boot flag is enabled by default. This enables you to configure SPB and IS-IS, but you cannot configure PIM either globally or on an interface.
- If you disable the boot flag, save the configuration and reboot with the saved configuration. After you enable the flag, you can configure PIM and IGMP Snooping, but you cannot configure SPB or IS-IS.

! Important:

- Any change to the `spbm-config-mode` boot flag requires a reboot for the change to take effect.
- If you disable the boot flag, save the configuration and reboot with the saved configuration. After you disable the flag, you can configure PIM and IGMP Snooping, but you cannot configure SPB or IS-IS.

For more information, see *Configuring IP Multicast Routing Protocols*.

vxlan-gw-full-interworking-mode boot flag

The VXLAN Gateway implementation is available in the following modes:

- **Base Interworking Mode** – This is the default mode. In this mode, VXLAN Gateway supports Layer 2 gateway communication between VXLAN and traditional VLAN environments.
- **Full Interworking Mode** – This mode supports the Base mode communication between VXLAN and traditional VLAN environments as well as VXLAN-to-VXLAN communication and all SPB functionality including vIST and SMLT. To enter this mode, you must enable the `vxlan-gw-full-interworking-mode` boot configuration flag.

 **Note:**

Changing the mode requires a reboot for the change to take effect.

For complete information about this feature, see *Configuring VXLAN Gateway*.

MAC-in-MAC encapsulation

To forward customer traffic across the core network backbone, SPBM uses IEEE 802.1ah Provider Backbone Bridging (PBB) MAC-in-MAC encapsulation, which hides the customer MAC (C-MAC) addresses in a backbone MAC (B-MAC) address pair. MAC-in-MAC encapsulation defines a B-MAC source address (BMAC-SA) and a B-MAC destination address (BMAC-DA) to identify the backbone source and destination addresses.

The originating node creates a MAC header that is used for delivery from end to end. As the MAC header stays the same across the network, there is no need to swap a label or do a route lookup at each node, allowing the frame to follow the most efficient forwarding path end to end.

Encapsulating customer MAC addresses in B-MAC addresses improves network scalability (no end-user C-MAC learning is required in the core) and also significantly improves network robustness (loops in access networks do not impact forwarding results in the backbone infrastructure.)

I-SID

SPBM introduces a service instance identifier called I-SID. SPBM uses I-SIDs to separate services from the infrastructure. After you create an SPBM infrastructure, you can add additional services (such as VLAN extensions or VRF extensions) by provisioning the endpoints only. The SPBM endpoints are Backbone Edge Bridges (BEBs), which mark the boundary between the core MAC-in-MAC SPBM domain and the edge customer 802.1Q domain. I-SIDs are provisioned on the BEBs to be associated with a particular service instance. In the SPBM core, the bridges are Backbone Core Bridges (BCBs). BCBs forward encapsulated traffic based on the BMAC-DA.

The SPBM B-MAC header includes a Service Instance Identifier (I-SID) with a length of 32 bits with a 24-bit ID. I-SIDs identify a service instance for virtualized traffic in an encapsulated SPBM frame.

You can use I-SIDs in a Virtual Services Network (VSN) for VLANs or VRFs across the MAC-in-MAC backbone:

- For a Layer 2 VSN, the I-SID is associated with a customer VLAN, which is then virtualized across the backbone. Layer 2 VSNs offer an any-any LAN service type. Layer 2 VSNs associate one VLAN per I-SID.
- For a Layer 2 VSN with IP multicast over Fabric Connect, the BEB associates a data I-SID with the multicast stream and a scope I-SID that defines the scope as Layer 2 VSN. A multicast stream with a scope of Layer 2 VSN can only transmit a multicast stream for the same Layer 2 VSN.
- For a *Transparent Port UNI*, the I-SID is associated with a port or MLT, which is then virtualized across the backbone. *Transparent Port UNI* associates multiple ports or MLT to an I-SID.
- For a Layer 3 VSN, the I-SID is associated with a customer VRF, which is also virtualized across the backbone. Layer 3 VSNs are always full-mesh topologies. Layer 3 VSNs associate one VRF per I-SID.
- For a Layer 3 VSN with IP multicast over Fabric Connect, the BEB associates a data I-SID with the multicast stream and a scope I-SID that defines the scope as Layer 3 VSN. A multicast stream with a scope of Layer 3 VSN can only transmit a multicast stream for the same Layer 3 VSN.
- For IP Shortcuts with IP multicast over Fabric Connect, the BEB associates a data I-SID with the multicast stream and defines the scope as Layer 3 GRT. A multicast stream with a scope of Layer 3 GRT can only transmit a multicast stream for a Layer 3 GRT.

For more information, see *Configuring Fabric Multicast Services* and *Configuring Fabric Layer 3 Services*.

*** Note:**

I-SID configuration is required only for virtual services such as Layer 2 VSN and Layer 3 VSN. With IP Shortcuts with unicast, no I-SID is required, forwarding for the Global Routing table is done using IS-IS based shortest path B-MAC reachability.

*** Note:**

I-SID to VLAN binding is used to automatically determine the path between client and server in order to attach network devices to FA Zero touch services.

BCBs and BEBs

The boundary between the core MAC-in-MAC SPBM domain and the edge customer 802.1Q domain is handled by Backbone Edge Bridges (BEBs). I-SIDs are provisioned on the BEBs to be associated with a particular service instance.

In the SPBM core, the bridges are referred to as Backbone Core Bridges (BCBs). BCBs forward encapsulated traffic based on the B-MAC-DA.

! Important:

SPBM separates the payload from the transport over the SPBM infrastructure. Configure all virtualization services on the BEBs at the edge of the network. There is no provisioning required on the core SPBM switches. This provides a robust carrier grade architecture where configuration on the core switches never needs to be touched when adding new services.

A BEB performs the same functionality as a BCB, but it also terminates one or more Virtual Service Networks (VSN). A BCB does not terminate any VSNs and is unaware of the VSN traffic it transports. A BCB simply knows how to reach any other BEB in the SPBM backbone.

VLANs without member ports

If a VLAN is attached to an I-SID there must be another instance of that same I-SID in the SPBM network.

- If another instance of that I-SID exists, the device designates that VLAN as operationally up regardless of whether it has a member port or not.

When the VLAN is operationally up, the IP address of the VLAN will be in the routing table.

- If no matching instance of the I-SID exists in the SPBM network, then that VLAN has no reachable members and does not act as an NNI interface.

The VLAN does not act as a UNI interface because it does not have a member port.

Therefore, the device does not designate the VLAN as operationally up because the VLAN does not act as a UNI or an NNI interface.

If the device acts as a BCB with two VLANs configured and two I-SIDs, there must be a UNI side with the corresponding I-SID existing in the network.

If the device acts as both BEB and BCB, then there must be a member port in that VLAN to push out the UNI traffic.

Basic SPBM network topology

The following figure shows a basic SPBM network topology, specifically a Layer 2 VSN. Switches A and D are the Backbone Edge Bridges (BEB) that provide the boundary between the customer VLANs (C-VLAN) and the Backbone. Switches B and C are the Backbone Core Bridges (BCB) that form the core of the SPBM network.

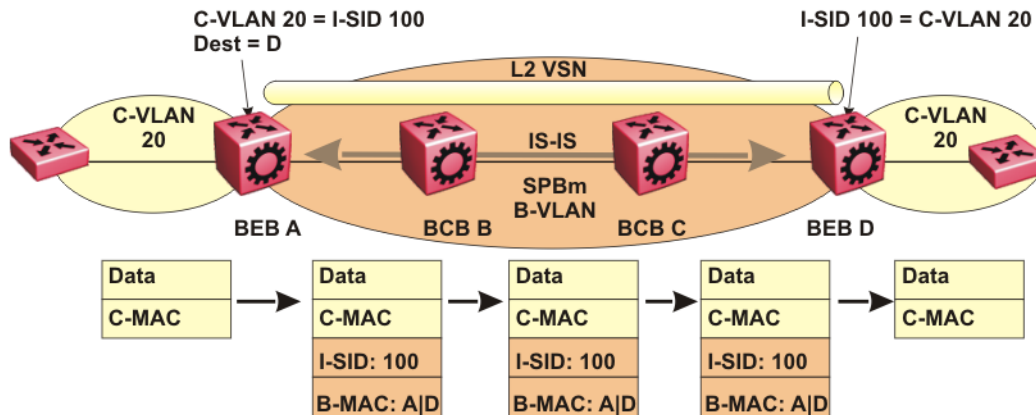

Figure 3: SPBM L2 VSN

SPBM uses IS-IS in the core so that all BEBs and BCBs learn the IS-IS System-ID (B-MAC) of every other switch in the network. For example, BEB-A uses IS-IS to build an SPBM unicast forwarding table containing the B-MAC of switches BCB-B, BCB-C, and BEB-D.

The BEBs provide the boundary between the SPBM domain and the virtualized services domain. For a Layer 2 VSN service, the BEBs map a C-VLAN to an I-SID based on local service provisioning. Any BEB in the network that has the same I-SID configured can participate in the same Layer 2 VSN.

In this example, BEB A and BEB D are provisioned to associate C-VLAN 20 with I-SID 100. When BEB A receives traffic from C-VLAN 20 that must be forwarded to the far-end location, it performs a lookup and determines that C-VLAN 20 is associated with I-SID 100 and that BEB D is the destination for I-SID 100. BEB A then encapsulates the data and C-MAC header into a new B-MAC header, using its own nodal B-MAC: A as the source address and B-MAC: D as the destination address. BEB A then forwards the encapsulated traffic to BCB B.

To forward traffic in the core toward the destination node D, BCB B and BCB C perform Ethernet switching using the B-MAC information only.

At BEB D, the node strips off the B-MAC encapsulation, and performs a lookup to determine the destination for traffic with I-SID 100. BEB D identifies the destination on the C-VLAN header as C-VLAN 20 and forwards the packet to the appropriate destination VLAN and port.

E-Tree and Private VLAN topology

Ethernet Private Tree (E-Tree) extends Shortest Path Bridging MAC (SPBM) to Private VLANs (PVLAN).

Transport within the SPBM network is achieved by associating the private VLAN with an I-SID. Flooded traffic from both promiscuous and isolated devices is transported over the same I-SID multicast tree and suppression for spoke-to-spoke traffic is done on the egress SPB Backbone Edge Bridge (BEB). This means the Private VLAN IDs are globally significant and must be the same on all BEBs

The following list provides details for E-Tree and Private VLAN topology:

- E-Tree associates a Private VLAN with an I-SID.

*** Note:**

The same I-SID could be attached to a regular VLAN. In that case, all ports on the regular VLAN behave like Promiscuous ports on the PVLAN.

- Other SPB BEBs can associate a regular CVLAN to the same I-SID that E-Tree uses.

*** Note:**

The CVLAN ID must match the primary PVLAN ID.

- CVLAN devices assigned to the same I-SID that E-Tree uses have Promiscuous connectivity within the segment.

The following figure shows a basic E-Tree network topology consisting of groups of private VLANs connected by the SPBM core network.

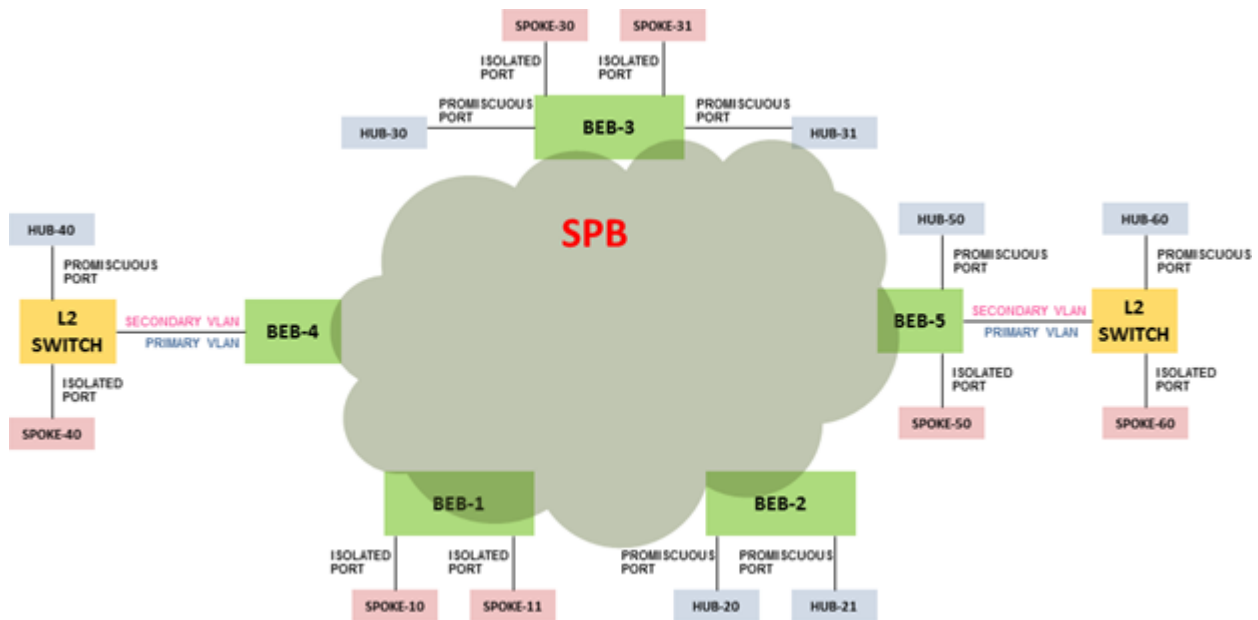

Figure 4: Sample E-Tree configuration

Private VLAN port types

The private VLAN port type is isolated, promiscuous, or trunk. If the port is a member of an MLT, then the port inherits the private VLAN type of the MLT.

In terms of network topology, the isolated port is considered a spoke. The isolated port, or spoke, does not communicate with any other isolated port in the network. The isolated port only communicates with the promiscuous ports, or hubs.

E-Tree and Private VLAN limitations

The following limitations apply to E-Tree and Private VLAN topology:

- A port that is of Private VLAN type trunk must be tagged. Isolated and Promiscuous Private VLAN ports can be either tagged or untagged.
- When a port or MLT that has a Private VLAN type set to Isolated or Promiscuous is added to a private VLAN, if that port is used by other non private VLANs, then those non private VLANs are removed.
- A port which is Private VLAN type Isolated and is tagged can belong to only one Private VLAN.

IS-IS

SPBM eliminates the need for multiple overlay protocols in the core of the network by reducing the core to a single Ethernet-based, link-state protocol (IS-IS). IS-IS provides virtualization services using a pure Ethernet technology base. SPBM also uses IS-IS to discover and advertise the network topology, which enables it to compute the shortest path to all nodes in the SPBM network.

IS-IS is a link-state, interior gateway protocol that was developed for the International Organization for Standardization (ISO). ISO terminology refers to routers as Intermediate Systems (IS), hence the name Intermediate System-to-Intermediate System (IS-IS).

To provide a loop-free network and to learn and distribute network information, SPBM uses the Intermediate-System-to-Intermediate-System (IS-IS) link state routing protocol. IS-IS is designed to find the shortest path from any one destination to any other in a dynamic fashion. IS-IS creates any-to-any connectivity in a network in an optimized, loop-free manner, without the long convergence delay experienced with the Spanning Tree Protocol. IS-IS does not block ports from use, but rather employs a specific path. As such, all links are available for use.

IS-IS dynamically learns the topology of a network and constructs unicast and multicast mesh connectivity. IS-IS parallel adjacency support allows you to configure multiple IS-IS links between the two nodes. Each node in the network calculates a shortest-path tree to every other network node based on System-IDs (B-MAC addresses). Only one adjacency with the shortest path is selected as an active adjacency.

* Note:

Only an active interface with an active adjacency is added into local SPF calculations. This mechanism ensures the local node selects the shortest path and has the same view as the rest of the SPB network.

In the SPBM environment for Layer 2 VSNs, IS-IS carries only pure Layer 2 information with no requirement for an underlying IP control plane or forwarding path. IS-IS runs directly over Layer 2.

* Note:

SPBM carries Layer 3 information for Layer 3 VSNs.

In SPBM networks, IS-IS performs the following functions:

- Discovers the network topology
- Builds shortest path trees between the network nodes:
 - Forwards unicast traffic
 - Determines the forwarding table for multicast traffic
- Communicates network information in the control plane:
 - Service Instance Identifier (I-SID) information

SPBM can distribute I-SID service information to all SPBM nodes, as the I-SIDs are created. SPBM includes I-SID information in the IS-IS Link State protocol data units (PDUs). When a new service instance is provisioned on a node, its membership is flooded throughout the topology using an IS-IS advertisement.

Standard TLVs

IS-IS uses Type-Length-Value (TLV) encoding. SPBM employs IS-IS as the interior gateway protocol and implements additional TLVs to support additional functionality. The switch also supports Sub-TLVs. TLVs exist inside IS-IS packets and Sub-TLVs exist as additional information in TLVs.

The switch supports and is in full compliance with standard 802.1aq TLVs. The IEEE ratified the 802.1aq standard that defines SPBM and the Type-Length-Value (TLV) encoding that IS-IS uses to support SPBM services. The following table lists all the TLVs that the switch supports.

Table 1: Standard TLVs

TLV	Description	Usage
1	Area addresses — The Area Addresses TLV contains the area addresses to which the IS-IS is connected.	IS-IS area
22	Extended IS reachability — The Extended IS Reachability TLV contains information about adjacent neighbors.	IS-IS adjacencies Sub-TLV 29: SPBM link metric is carried within this TLV.
129	Protocols supported — The Protocol supported TLV carries the Network Layer Protocol Identifiers (NLPID) for the Network Layer protocols where the IS-IS can be used.	SPBM in addition to existing NLPID (IPV4 0xCC, IPV6 0x*E..), IEEE 802.1aq defined SPBM NLPID as 0xC1.
135	Extended IP reachability — The Extended IP Reachability TLV 135 is used to distribution IP reachability between IS-IS peers.	SPBM uses this existing IS-IS TLV to carry IP Shortcut routes in the Global Routing Table (GRT).

Table continues...

TLV	Description	Usage
143	<p>Multi-topology port aware capability (MT-Port-Capability) TLV</p> <p>This TLV carries the SPB instance ID in a multiple SPB instances environment. This TLV is carried within IS-IS Hello Packets (IIH), only when parallel links exist.</p>	<p>This TLV carries the following SPBM Sub TLV:</p> <ul style="list-style-type: none"> • Sub-TLV 6: SPB B-VID Sub TLV indicates the mapping between a VLAN and its equal cost tree (ECT) algorithm. To form an adjacency, both nodes must have a matching primary (BVLAN, ECT) pair, and secondary (BVLAN, ECT) pair, the number of B-VLANs must be equal, B-VLAN values must match, ECT values for the B-VLANs must match. Used in IS-IS Hellos only. • MCID Sub TLV: The MCID is a digest of the VLANs and MSTI. Neighboring SPBM nodes must agree on the MCID to form an adjacency. The MCID is set to all zeros (0). <p>After the switch receives a non-zero MCID Sub TLV, it reflects content back to the neighbor.</p> <ul style="list-style-type: none"> • Link L1 Metric Sub-TLV 7: Contains L1 metric of the link
144	<p>Multi-topology Capability (MT-Capability) TLV.</p> <p>This TLV carries the SPB instance ID in a multiple SPB instance environment. This TLV is carried within LSPs.</p> <p>In multicast over Fabric Connect, TLV 144 on the BEB bridge, where the sender is located, has the transmit (Tx) bit set. On the BEB bridge, where the receiver is located the receive (Rx) bit is set.</p>	<p>TLV 144 is the service identifier TLV. TLV 144 advertizes B-MAC and I-SID information.</p> <p>This TLV carries the following Sub TLVs:</p> <p>Sub-TLV 1: SPB instance Sub TLV contains a unique SPSourceID (nickname) to identify the SPBM node within this SPB topology.</p> <p>Sub-TLV 3: SPB Service ID (I-SID) is stored in TLV 144 sub-TLV 3. Sub-TLV 3 carries service group membership (I-SIDs) for a particular SPBM B-VLAN.</p>
184	<p>SPBM IP VPN reachability — IS-IS TLV 184 is used to advertise SPBM L3 VSN route information across the SPBM cloud.</p>	<p>IP reachability for Layer 3 VSNs</p>

Table continues...

TLV	Description	Usage
185	IPVPN multicast TLV with IPMC sub TLV — The IPVPN multicast TLV contains information about the scope I-SID.	<p>TLV 185 on the BEB bridge, where the source is located, displays the multicast source and group addresses and has the transmit (Tx) bit set. Each multicast group has its own data I-SID that maps to the source and group addresses.</p> <p>As part of the IPVPN TLV, sub-TLVs define IPv4 unicast, IPv6 unicast and IPv4 multicast information.</p> <p>Layer 2 VSN IP multicast over Fabric Connect and Layer 3 VSN IP multicast over Fabric Connect (using VRF) use TLV 185.</p>
186	IP multicast TLV (GRT) — TLV 186 on the BEB bridge, where the source is located, displays the multicast source and group addresses and has the transmit (Tx) bit set. Each multicast group has its own data I-SID that maps to the source and group addresses.	<p>IP Shortcuts with IP multicast over Fabric Connect use TLV 186.</p> <p>All multicast streams are constrained within the level in which they originate, which is called the scope level.</p>
236	IPv6 Reachability — The IPv6 reachability TLV 236 is used to distribute IPv6 network reachability between IS-IS peers.	SPBM uses the existing IS-IS TLV to carry IPv6 shortcut routes through the SPBM core.

For more information on IP multicast over Fabric Connect, see *Configuring Fabric Multicast Services*.

IS-IS hierarchies

IS-IS is a dynamic routing protocol that operates within an autonomous system (or domain). IS-IS provides support for hierarchical routing, which enables you to partition large routing domains into smaller areas. When used separately from SPBM, IS-IS uses a two-level hierarchy, dividing the domain into multiple Level 1 areas and one Level 2 area. When used separately from SPBM, the Level 2 area serves as backbone of the domain, connecting to all the Level 1 areas. SPBM currently uses only Level 1 areas.

Important:

The IEEE 802.1aq standard currently only defines the use of one hierarchy, Level 1. Level 2 function is disabled.

IS-IS PDUs

Intermediate System to Intermediate System Hello (IIH) packets discover IS-IS neighbors and establish and maintain IS-IS adjacencies. An IIH is sent in every Hello-interval to maintain the established adjacency. If a node has not heard IIHs from its neighbor for (hello-interval x hello-multiple) seconds, the node tears down the adjacency. IIH carries TLV 143 and SPB-B-VLAN Sub-TLV (among other sub-TLVs). For two nodes to form an adjacency the B-VLAN pairs for primary B-VLAN and secondary B-VLAN must match.

Link State Packets (LSP) advertise link state information. The system uses the link state information to compute the shortest path. LSP also advertises MT-capability TLV 144 and SPB instance Sub-TLV, and SPB I-SIDs Sub-TLV.

Complete Sequence Number Packets (CSNP) contain the most recent sequence numbers of all LSPs in the database. CSNP notifies neighbors about the local LSDB. After a neighbor receives a CSNP, it compares the LSPs in the CSNP with the LSP in the local LSDB. If the neighbor is missing LSPs, it sends a Partial Sequence Number Packets (PSNP) to request the missing LSPs. This process synchronizes the LSDBs among neighbors. A synchronized LSDB among all nodes in the network is crucial to producing a loop-free shortest path.

IS-IS configuration parameters

IS-IS system identifiers

The IS-IS system identifiers consist of three parts:

- **System ID** — The system ID is any 6 bytes that are unique in a given area or level. The system ID defaults to the baseMacAddress of the chassis but you can configure a non-default value. The system ID must use a unicast MAC address; do not use a multicast MAC address. A MAC address that has the low order bit 1 set in the highest byte is a multicast MAC address. For example, the following are multicast MAC addresses: x1xx.xxxx.xxxx, x3xx.xxxx.xxxx, x5xx.xxxx.xxxx, x7xx.xxxx.xxxx, x9xx.xxxx.xxxx, xBxx.xxxx.xxxx, xDxx.xxxx.xxxx, and xFxx.xxxx.xxxx.
- **Manual area** — The manual area or area ID is up to 13 bytes long. The first byte of the area number (for example, 49) is the Authority and Format Indicator (AFI). The next bytes are the assigned domain (area) identifier, which is up to 12 bytes (for example, 49.0102.0304.0506.0708.0910.1112). IS-IS supports a maximum of three manual areas, but the switch software only supports one manual area.
- **NSEL** — The last byte (00) is the n-selector. In this implementation, this part is automatically attached. There is no user input accepted.

The Network Entity Title (NET) is the combination of all three global parameters.

All routers have at least one manual area. Typically, a Level 1 router does not participate in more than one area.

The following are the requirements for system IDs:

- All IS-IS enabled routers must have one manual area and a unique system ID.
- All routers in the same area must have the same area ID.

- All routers must have system IDs of the same length (6 bytes).
- All IS-IS enabled routers must have a unique nickname.

PSNP interval

You can change the PSNP interval rate. A longer interval reduces overhead, while a shorter interval speeds up convergence.

CSNP periodic and interval rate

You can configure the CSNP periodic and interval rate. A longer interval reduces overhead, while a shorter interval speeds up convergence.

Parameters for the link state packet (LSP)

LSPs contain vital information about the state of adjacencies, which must be exchanged with neighboring IS-IS systems. Routers periodically flood LSPs throughout an area to maintain synchronization. You can configure the LSP to reduce overhead or speed up convergence.

The following list describes IS-IS parameters related to LSPs:

- The `max-lsp-gen-interval` is the time interval at which the generated LSP is refreshed. The default is 900 seconds with a range of 30 to 900.
- The `retransmit-lsp-interval` is the minimum amount of time between retransmission of an LSP. When transmitting or flooding an LSP an acknowledgement (ACK) is expected. If the ack is not received within `retransmit-lsp-interval`, the LSP is re-transmitted. The default is 5 seconds with a range of 1 to 300.

Point-to-point mode

All SPBM links are point-to-point links. The switch does not support broadcast links.

IS-IS interface authentication

Configure IS-IS interface authentication to improve security and to guarantee that only trusted routers are included in the IS-IS network. Interface level authentication only checks the IIH PDUs. If the authentication type or key in a received IIH does not match the locally-configured type and key, the IIH is rejected. By default, authentication is disabled.

You can use either one of the following authentication methods:

- Simple password authentication — Uses a text password in the transmitted packet. The receiving router uses an authentication key (password) to verify the packet.
- MD5 authentication — Creates a Message Digest (MD5) key.
- SHA-256 — Adds a Hash-based Message Authentication Code (HMAC) digest to each IS-IS Hello packet.

Password considerations

To reset the authentication password type, you must set the type to none.

The switch software supports only interface level authentication. The switch software does not support area level or domain level authentication.

SHA-256 considerations

IS-IS Hello packets are sent periodically to discover IS-IS neighbors, and to establish and maintain IS-IS adjacencies. If you enable SHA-256 authentication, the switch adds an HMAC-SHA256 digest to each Hello packet.

* Note:

The interfaces used to make the adjacencies must have SPBM configured.

The switch that receives the Hello packet computes the digest of the packet and compares it with the received digest. If the digests match, the packet is accepted. If the digests do not match, the receiving switch discards the packet.

Directly connected switches must share the same key (secret), which can have a maximum length of 16 characters.

Hellos

To update the identities of neighboring routers, you can configure the:

- Interface Hello interval
- Interface Hello multiplier

Interface Hello interval

IS-IS uses Hello packets to initialize and maintain adjacencies between neighboring routers.

You can configure the interface level Hello interval to change how often Hello packets are sent out from an interface level.

Hello multiplier

You can configure the Hello multiplier to specify how many Hellos the switch must miss before it considers the adjacency with a neighboring switch down. By default, the hold (wait) time is the Hello interval multiplied by the Hello multiplier. By default, if the Hello interval is 9 and the Hello multiplier is 3, the hold time is 27. If the Hello multiplier is increased to 10, the hold time is increased to 90.

Link metric

You can configure the link metric to overwrite the default metric value. By configuring the metric, you can specify a preferred path. Low cost reflects high-speed media, and high cost reflects slower media. For the wide metric, the value ranges from 1 to 16,777,215.

- The switch only supports the wide metric.
- The total cost of a path equals the sum of the cost of each link.
- The default value for wide metrics is 10.

* Note:

When multiple paths exist to reach a node, the path with the lowest sum of metrics of the individual links is chosen. If the sum of the paths are the same, the one with the lowest number of hops is chosen. If the number of hops is the same as well, then the tie-breaking is done by the system ID.

For the primary BVLAN, the path that has a node with the lowest system ID is chosen. Whereas, for the secondary BVLAN, the path that has a node with the highest system ID is chosen.

Disabling IS-IS

You can disable IS-IS globally or at the interface level. If IS-IS is globally disabled, then all IS-IS functions stop. If IS-IS is enabled at the global level and disabled at one of the interface levels, then IS-IS continues on all other interfaces.

Overload bit

The overload bit is sent by a node in LSP updates to inform other devices, whether to use that node to pass transit traffic. For example, when an LSP with an overload bit is received, the device ignores that LSP in its SPF calculation to avoid sending transit traffic through the overloaded node; however the overloaded node can still receive traffic destined to itself.

The overload bit is turned on by default on bootup, and cleared after 20 seconds. You can use the `overload-on-startup` parameter to control the time before the overload bit is cleared after bootup, as this setting is user configurable.

You can permanently set the overload bit using the `overload` parameter. If this is configured, the overload bit will not be cleared after bootup and it will be sent in all LSP updates. If the overload bit is set permanently, other devices do not include this node for use as a transit node in IS-IS computations. By default, the `overload` parameter is set to false.

The `overload` and `overload-on-startup` parameters are two independent settings and are configured under the `router isis` configuration mode in the CLI.

SPBM B-VLAN

Each SPBM network instance is associated with at least one backbone VLAN (B-VLAN) in the core SPBM network.

* Note:

SPB internally uses spanning tree group (STG) 63 or Multiple Spanning Tree Instance (MSTI) 62. STG 63 or MSTI 62 cannot be used by another VLAN or MSTI. For non-SPB customer networks, if you use STG 63 or MSTI 62 in the configuration, you must delete STG 63 or MSTI 62 before you can configure SPBM.

This VLAN is used for both control plane traffic and dataplane traffic.

* Note:

Always configure two B-VLANs in the core to allow load distribution over both B-VLANs.

SPBM alters the behavior of the VLAN. When a B-VLAN is associated with an SPBM network the following VLAN attributes and behaviors are modified for the B-VLAN:

- Flooding is disabled
- Broadcasting is disabled
- Source address learning is disabled
- Unknown MAC discard is disabled

You cannot add ports to a B-VLAN manually, IS-IS enabled ports are automatically added to the B-VLAN.

Essentially the B-MAC addresses are programmed into the B-VLAN Forwarding Information Bases (FIBs) by IS-IS instead of the traditional VLANs flooding and learning approach.

Modification of the VLAN behavior is necessary to ensure proper control over the SPBM traffic.

Pre-populated FIB

An Ethernet network usually learns MAC addresses as frames are sent through the switch. This process is called reverse learning and is accomplished through broadcast.

SPBM does not allow any broadcast flooding of traffic on the B-VLAN in order to prevent looping accomplished through flooding packets with unknown destinations (although multicast traffic is supported). As such, MAC addresses must be distributed within SPBM. This is accomplished by carrying the necessary B-MAC addresses inside the IS-IS link state database. To that end, SPBM supports an IS-IS TLV that advertises the I-SID and B-MAC information across the network. This functionality enables the powerful end-point-provisioning of SPBM.

These Backbone MAC addresses are populated into the SPBM VLAN Forwarding Information Base (FIB) to maximize efficiency and to allow Reverse Path Forwarding Check (RPFC) to operate properly.

RPFC

A loop prevention mechanism is required at Layer 2 to stop wayward traffic from crippling the network. Reverse Path Forwarding Check (RPFC) is the chosen method of suppressing loop traffic with SPBM. RPFC was originally designed for IP traffic at Layer 3 where it checks the source address of the packet against the routing entry in the routing table. The source address must match the route for the port it came in on otherwise the packet is illegitimate and therefore dropped.

With SPBM, the node matches the source B-MAC address against the ingress port to establish validity. If the frame is not supposed to come in that port, it is immediately suppressed imposing a guaranteed loop control. If there is no VLAN FDB entry to the source MAC address with the outgoing port as the ingress port, the frame will be dropped.

SPBM FIB

This section describes the SPBM unicast and multicast FIBs.

Unicast FIB

The unicast computation runs a single Dijkstra (unlike all pair Dijkstras for multicast). SPBM produces only one Shortest Path First (SPF) tree and the tree is rooted on the computing node.

The unicast computation generates an entry for each node in the network. The Destination Address (DA) for that entry is the system-id of the node. In addition, if a node advertises MAC addresses other than the system-id, each MAC address has an entry in the unicast FIB table, and the shortest path to that MAC should be exactly the same as the path to the node.

Unicast FIB entries are installed to the vlan-fdb table.

The following text shows an example of the unicast FIB.

```
Switch:1# show isis spbm unicast-fib
=====
                        SPBM UNICAST FIB ENTRY INFO
=====
DESTINATION          BVLAN  SYSID          HOST-NAME          OUTGOING          COST
ADDRESS             
-----
00:80:2d:35:93:df   10     0080.2d35.93df  86-10              MLT-32            0
00:80:2d:35:93:df   11     0080.2d35.93df  86-10              MLT-32            0
00:80:86:10:86:20   11     0080.2d35.93df  86-10              MLT-32            0
00:e0:7b:84:57:df   10     00e0.7b84.57df  86-30              1/12              0
00:e0:7b:84:57:df   11     00e0.7b84.57df  86-30              1/12              0
=====
```

Multicast FIB

SPBM runs all pair Dijkstras to produce the multicast FIB. The computing node loops through each node to run Dijkstra using that node as the root, and then prunes paths to only keep the shortest paths. The computing node then computes the intersection of the set of I-SIDs for which the root node transmits, with the set of I-SIDs for which the path endpoints receive.

The multicast addresses are built out of two pieces: the SPBM Node Nickname and the I-SID ID converted to hexadecimal format to form the multicast MAC address.

```
|-----|-----|
| nickname|0x30000          hexadecimal I-SID          |
|-----|-----|
```

For example, if the nickname is 0.00.10 and the I-SID is 100 (0x64), the multicast address is 03:00:10:00:00:64.

The following text shows an example of the multicast FIB.

```
Switch:1(config)#show isis spbm multicast-fib
=====
                        SPBM MULTICAST FIB ENTRY INFO
=====
MCAST DA            ISID      BVLAN SYSID      HOST-NAME      OUTGOING-INTERFACES      INCOMING
                                                                INTERFACE
-----
03:00:07:e4:e2:02   15000066  1001  0077.0077.0077  Switch-25      1/33                    MLT-2
03:00:08:e4:e2:02   15000066  1001  0088.0088.0088  Switch-33      1/50,1/33              40.40.40.40
03:00:41:00:04:4d   1101      4058  00bb.0000.4100  Switch-1(*)    1/3,1/49,0.0.0.0      Tunnel_to_HQ
03:00:41:00:04:4f   1103      4058  00bb.0000.4100  Switch-1(*)    1/3,1/49,0.0.0.0      cpp
=====
Total number of SPBM MULTICAST FIB entries 4
=====
```

SPBM restrictions and limitations

This section describes the restrictions and limitations associated with SPBM.

RSTP and MSTP

The following list identifies restrictions and limitations associated with RSTP and MSTP:

- RSTP mode does not support SPBM.

- A C-VLAN-level loop across SPBM NNI ports cannot be detected and needs to be resolved at the provisional level.
- SPBM NNI ports are not part of the Layer 2 VSN C-VLAN, and BPDUs are not transmitted over the SPBM tunnel. SPBM can only guarantee loop-free topologies consisting of the NNI ports. You should always use Simple Loop Prevention Protocol (SLPP) in an SMLT environment.

*** Note:**

Deploy SLPP on C-VLANs to detect loops created by customers in their access networks. However, SLPP is not required on B-VLANs, and it is not supported. The B-VLAN active topology is controlled by IS-IS that has loop mitigation and prevention capabilities built into the protocol.

- SPB internally uses spanning tree group (STG) 63 or Multiple Spanning Tree Instance (MSTI) 62. STG 63 or MSTI 62 cannot be used by another VLAN or MSTI. For non-SPB customer networks, if you use STG 63 or MSTI 62 in the configuration, you must delete STG 63 or MSTI 62 before you can configure SPBM.
- You must configure SPBM B-VLANs on all devices in the same MSTP region. MSTP requires this configuration to generate the correct digest.
- Configure the SPBM B-VLANs to use matching VLAN IDs.

Best practices for SPB regarding MSTP

Use NNI ports exclusively to transport traffic for SPB-based services and not be configured as members of any VLANs other than SPB B-VLANs. In releases that do not support `nni-mstp`, when an SPBM IS-IS interface is created on an NNI port or an MLT, MSTP is automatically disabled for MSTI-62 on the port/MLT. However, MSTP is not automatically disabled on NNI ports for the CIST (default MSTI). In releases that support the `boot config flags nni-mstp` command, the default behavior of the MSTP NNI ports is that CIST is disabled automatically on the NNI and the NNI ports cannot be members of any VLANs other than B-VLANs. The default `boot config flags nni-mstp` must be set to `false` (which is the default). The following example shows the command to disable the MSTP on the NNI ports.

```
Switch:1(config)#interface gigabitEthernet 1/8
Switch:1(config-if)#no spanning-tree mstp
```

Coexistence of MSTP and SPB based services on NNI ports:

In releases that do not support `nni-mstp` boot configuration, you can support the coexistence of non-SPB based services on the NNI ports, by adding NNI ports as members of VLANs, except for B-VLANs. These other VLANs rely on the use of MSTP for Loop prevention. The network operator must carefully consider the implications of keeping MSTP enabled on the NNI ports because any MSTP topology changes detected on the NNI ports impacts all services and causes most dynamically learned information on the UNI side to be flushed and relearned. This includes, but is not limited to, all customer MAC and ARP records. This can also cause all the UNI ports on a BEB to be temporarily put into a spanning-tree blocking state before transitioning to a forwarding state again. The net result is that MSTP topology changes on the NNI ports adversely impact traffic for SPB-based services. Therefore, it is recommended that the NNI ports be used exclusively for SPB traffic.

SPBM IS-IS

The following list identifies restrictions and limitations associated with SPBM IS-IS:

- The switch does not support IP over IS-IS as defined by RFC 1195. IS-IS protocol is only to facilitate SPBM.

- The switch uses level 1 IS-IS. The switch does not support level 2 IS-IS. The CLI command `show isis int-12-cont1-pkts` is not supported because the IEEE 802.1aq standard currently only defines the use of one hierarchy, Level 1.
- The IS-IS standard defines wide (32bit) metrics and narrow (8 bits) metrics. The switch supports the wide metric.
- IS-IS enabled ports cannot be added to an MLT. The switch does not support this configuration.

SPBM NNI SMLT

The switch does not support NNI on SMLT links.

VLACP

VLACP is generally used when a repeater or switch exists between connected switches to detect when a connection is down even when the link LED is lit. If you configure VLACP on an SPBM link that is also an IST link, during a connection fail over (where the link LED stays lit) the IS-IS hellos time out first (after 27 seconds, using default values) and take down the IS-IS adjacency. IS-IS then calculates the new shortest path and fails over the SPBM traffic. 90 seconds after the connection failure (using default values), VLACP goes down but the IST link was already taken down by IS-IS.

In this scenario, there is no data traffic impact because IS-IS can find another path in the SPBM network before VLACP goes down.

SNMP traps

On each SPBM peer, if you configure the SPBM B-VLANs to use different VLAN IDs, for example, VLAN 10 and 20 on one switch, and VLAN 30 and 40 on the second, the system does not generate a trap message to alert of the mismatch because the two switches cannot receive control packets from one another. Configure the SPBM B-VLANs to use matching VLAN IDs.

System MTU

Do not change the system MTU to less than the default value of 1950 bytes. The system MTU must be 1950 or jumbo because of the header size increase when transmitting packets over the SPBM cloud.

IP multicast over Fabric Connect

IP multicast over Fabric Connect cannot connect to existing Protocol Independent Multicast (PIM) networks that connect to SPB originated streams or that add PIM network streams into the SPB network. SPB-PIM Gateway (SPB-PIM GW), however, provides multicast interdomain communication between an SPB network and a PIM network. SPB-PIM GW accomplishes this interdomain communication across a special Gateway VLAN. The Gateway VLAN communicates with the PIM network through the PIM protocol messaging and translates the PIM network requirements into SPB language, and vice versa. For more information about SPB-PIM GW, see *Configuring Fabric Multicast Services*.

Other

The following list identifies other restrictions and limitations:

- You cannot use 3.33.33 as the SPB nickname because of a conflict with reserved IPv6 Ethernet multicast address 33:33:xx:xx:xx:xx.
- The software does not support I-SID filters.
- You cannot enable C-VLAN and B-VLAN on the same port.

Network Load Balancing (NLB)

SPBM supports Network Load Balancing (NLB) Unicast and Multicast modes.

*** Note:**

This feature is not supported on all hardware platforms. If you do not see this command in the command list or EDM, the feature is not supported on your hardware. For more information about feature support, see *Release Notes*.

NLB is a clustering technology available with Microsoft Windows 2000, Microsoft Windows 2003, Microsoft Windows 2008, and Microsoft Windows 2012 server family of operating systems. You can use NLB to share the workload among multiple clustering servers. NLB uses a distributed algorithm to load balance TCP/IP network traffic across a number of hosts, enhancing the scalability and availability of mission critical, IP based services, such as Web, VPN, streaming media, and firewalls. NLB also provides high availability by detecting host failures and automatically redistributing traffic to remaining operational hosts.

For more information on NLB, see *Configuring VLANs, Spanning Tree, and NLB*.

SPBM script

You can use a CLI script to quickly configure the SPB and IS-IS infrastructure to enable Fabric Connect on a switch. You can use the SPB script, rather than manually configure the minimum SPBM and IS-IS parameters.

You can use the command `run spbm` to quickly configure the following:

- Configure the SPB Ethertype.
- Create an SPB instance.
- Create an SPBM backbone VLAN and associate it to the SPB instance.
- Create an SPBM secondary backbone VLAN and associate it to the SPB instance.
- Add an SPB nickname.
- Create a manual area.
- Enable IS-IS on one of the switch interfaces.
- Enable IS-IS globally.
- Configure the IS-IS system name.
- Configure the IS-IS system ID.

The following table displays the default values applied if you use the `run spbm` command. The SPB script creates some of the default values based on the MAC address of the switch, including the nickname and System ID value.

Parameter	Default values
Ethertype	0x8100
Primary BVLAN	4051
Secondary BVLAN	4052
Manual area	49.0000
Nickname	Derived from the chassis MAC
System name	Derived from the command line prompt
System ID value	Derived from the chassis MAC, using a different algorithm from that for the Nickname

*** Note:**

The SPB script only creates the SPBM instance, VLAN, or other parameters if they do not already exist. For example, if the SPBM instance and VLAN already exist, the SPB script does not create them. If the SPB script cannot create one of the parameters because the parameter is already configured, the script stops and an error message displays.

Layer 2 Video Surveillance install script

*** Note:**

This feature is not supported on all hardware platforms. See *Release Notes* for more information about feature support.

The Layer 2 Video Surveillance install script pre-configures configuration parameters for video surveillance solutions. With this script, a technician can quickly and easily deploy a typical video surveillance network that supports up to 2000 IP cameras, a recording solution, systems management, and viewing stations.

The install script uses best practices for converged solutions and provides redundant paths for all video traffic. The script configures the basic deployment of Shortest Path Bridging and uses Layer 2 VSNs to enable full multicast capabilities between all IP subnets and VLANs.

Configuration parameters

The syntax of the install script command is `run vms layer-2 switch <5-99>` where the switch value (between 5 and 99) is a user-defined variable. The install script uses this switch value to set the camera IP zone for the switch and to specify a unique SPB nickname, system-id, and IP source value.

The install script configures the following major parameters and populates the xx with the user-defined variable for the switch value:

- IP Loopback Interface Address: 192.0.2.xx (Management IP address on the switch.)
- IP-Source Address: 192.0.2.xx (IS-IS source IP address for the switch.)
- VLAN ID: 200 (On hardware platforms that only have NNI links, there is no need to create a surveillance VLAN.)

- System ID: 0011.0011.07xx (SPB system-id of switch)
- Nickname: 0.07.xx (SPB Nickname for switch)
- SPB Manual Area ID: 49.0001
- Backbone VLAN IDs: 4051 and 4052 (with 4051 as Primary)
- SPB Multicast: enabled
- SFP and SFP+ ports: (Define all ports as NNI links.)

*** Note:**

The install script does not configure DHCP Relay parameters.

Optional syntax parameter

The install script requires that the switch be in the factory default state. The script prompts you to confirm this, but it does not check if you did so. The script continues executing commands even if some of the commands in the script fail, and the failure of script commands is not evident by the script execution completion message.

The complete syntax of the install script command is: `run vms layer-2 switch <5-99> [syntax]`. The optional `syntax` parameter prints out all the commands run by the script onto the console. If you do not use the `syntax` parameter, you will not see an error message when a command fails to run.

! Important:

Use the `syntax` parameter to display all the commands run by the script and show any errors that the script encounters. This is the only way to ensure that all configurations are configured without error.

Configuration filename

Upon successful completion of the install script, the switch configuration is saved with a filename based on the *switch value* used when the script was run. The switch primary boot config file flags are updated with the new filename.

For example, if you use 6 as the switch value, the command `run vms layer-2 switch 6` results in a switch configuration filename of `vms-layer2-switch-6.cfg`.

If you run the install script with the `syntax` parameter, you will see the pre-install command output:

- `save config file pre_vms_layer2_install.cfg`
- `Save config to file /intflash/pre_vms_layer2_install.cfg successful.`

and the completed install script output:

- `save config file vms-layer2-switch-6.cfg`
- `Save config to file /intflash/vms-layer2-switch-6.cfg successful.`

Fabric Extend

Fabric Extend enables Enterprises to extend the Fabric Connect technology over Layer 2 or Layer 3 core networks. The *logical IS-IS interface*, which is discussed in detail later in this chapter, is the

mechanism that enables Fabric Extend to connect SPB fabric nodes. Logical IS-IS interfaces create virtual tunnels and encapsulate SPB traffic by adding a Virtual Extensible LAN (VXLAN) header to SPB packets.

The following figure illustrates two Fabric Connect “islands” separated by a third-party core IP network. The IP network could be third-party equipment in an enterprise or a service provider’s infrastructure such as an MPLS VPN service.

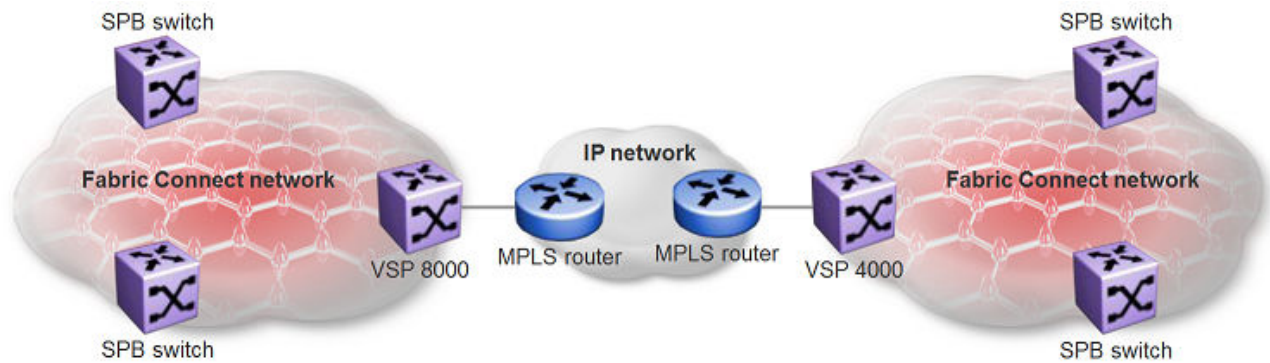

Figure 5: Fabric Connect networks connected by an IP network

The following figure illustrates how Fabric Extend enables you to connect the fabric islands to create ONE Fabric Connect network. This figure shows a layer 3 core network where Fabric Extend uses IP tunneling by adding a VXLAN header to the SPBM packets. This can be over a third party IPv4 transport network such as MPLS IP-VPN or in a Campus IP backbones.

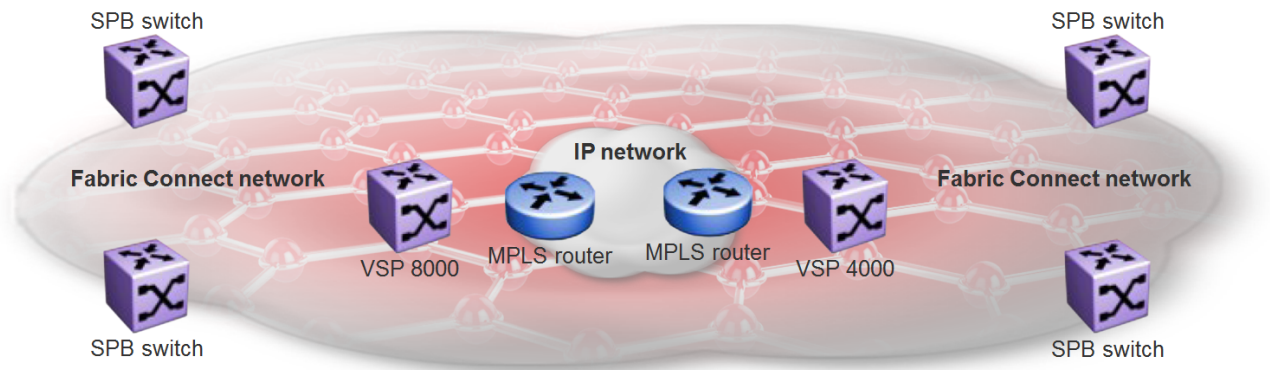

Figure 6: Single Fabric Connect Domain realized using Fabric Extend

The following figure shows a layer 2 core network where Fabric Extend can transport SPBM packets over a layer 2 MPLS VPLS or PBB E-LINE service by creating layer 3 tunnels over a layer 2 third party network.

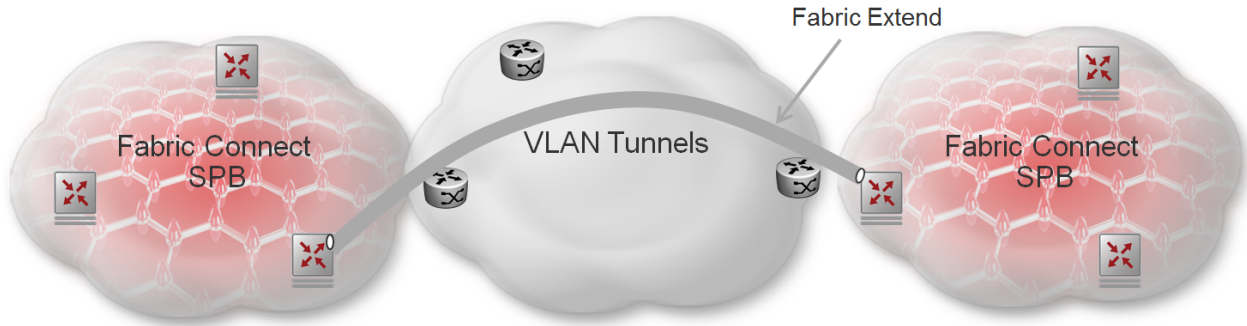

Figure 7: Fabric Extend over VLAN tunnels

What are the advantages of connecting Fabric Connect networks?

Fabric Connect is an Ethernet-based, industry-standard (IEEE 802.1aq) networking virtualization solution. With Fabric Connect, you can have thousands of virtualized service instances at any point in the network. Other Fabric Connect advantages include rapid time to service, Layer 2 and Layer 3 Unicast and IP Multicast virtualization, and scalable IP multicast. But the most significant advantage of Fabric Connect is that you provision services at the network edge **only**, not the core.

The **Fabric Extend** feature enables you to *extend* the Fabric Connect model. This allows Enterprises to extend Fabric Connect technology over Layer 2 and Layer 3 core networks. The interconnection of Fabric Connect deployments can be over any IP-based network whether it's a campus backbone, Data Center, or a MAN/WAN IP MPLS network.

What devices support Fabric Extend?

The VSP 7200 and the VSP 8000 Series support Fabric Extend natively. You can use these switches in a main office of a hub and spoke deployment or to connect one Data Center to another Data Center.

The VSP 4000 also supports Fabric Extend, but the switch must be connected to an Open Networking Adapter (ONA) because the VSP 4000 does not support Fabric Extend natively. The ONA enables the VSP 4000 to support Fabric Extend. The VSP 4000 uses the ONA to encapsulate Fabric Connect traffic. For example, you can use the VSP 4000 in a branch office of a hub and spoke deployment.

* Note:

In a Layer 2 core Fabric Extend solution, the VSP 4000 does not require an ONA because the tunnels are point-to-point VLAN connections, not VXLAN. Therefore, there is no need for an ONA to encapsulate a VXLAN header to SPB packets.

For more information on which switches support ONAs, see the feature overview in *Release Notes*.

Fabric Extend licensing

The Fabric Extend solution operates with a base license.

For more information about licensing, see *Administering*.

Fabric Extend and ONA

The VSP 7200 and the VSP 8000 Series support Fabric Extend natively on any of its physical ports. However, the VSP 4000 requires an Open Networking Adapter (ONA) to enable this functionality. The ONA is the Fabric Extend packet encapsulation engine for the VSP 4000. The ONA / VSP 4000 combination can also provide enhanced features such as IP fragmentation and reassembly on Fabric Extend tunnels.

*** Note:**

In a Layer 2 core Fabric Extend solution, the VSP 4000 does not require an ONA because the tunnels are point-to-point VLAN connections, not VXLAN. Therefore, there is no need for an ONA to encapsulate a VXLAN header to SPB packets.

The VSP 4000 manages the ONA in the following ways:

- Controls and provisions the ONA.
- If PoE capable, the VSP 4000 supplies power to the ONA. (The ONA also supports an optional wall unit power adapter.)
- Transports traffic to and from the ONA over 1 GbE ports and sets QoS appropriately to the ONA's.
 - The ONA 1101GT can support basic Fabric Extend at line rate 1G traffic from the VSP 4000 at 1500 byte packet sizes.
 - Oversubscription of the ONA's packet engine may result if packets are smaller than 1500 bytes or if you enable enhanced features such as fragmentation and reassembly of packets. This results in packet drop starting with lower QoS queued packets consistent with PCP and DSCP markings on packets received from the VSP 4000. For more details on the ONA 1101GT forwarding performance, see [ONA considerations](#) on page 50.

The ONA can operate in different modes. Fabric Extend is Operational Mode 1. To enable Fabric Extend, use the ONA's Manual Configuration menu to change the Operational Mode parameter to 1. For more information, refer to the manual that ships with the ONA.

In the following figure, the VSP 8000 is in a Fabric Connect network and is configured with Fabric Extend (FE). The VSP 4000 is also in a Fabric Connect network and is configured with SPB. The VSP 8000 and the VSP 4000 use industry-standard VXLAN tunnels to create a flow for FE traffic between the VSP 8000 and the ONA attached to the VSP 4000.

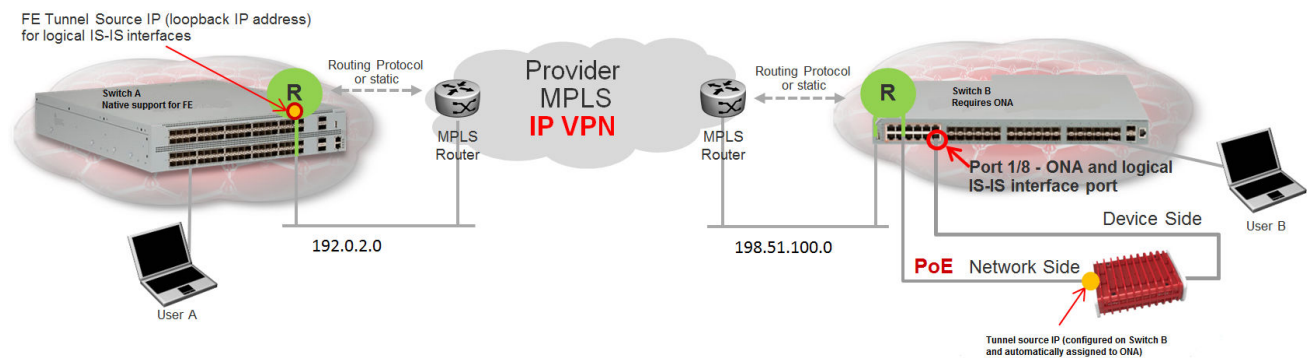

Figure 8: Fabric Extend traffic flow

The following flow occurs when User A sends a packet to User B:

- The VSP 8000 receives the packet and encapsulates it with a MAC-in-MAC header.
- The VSP 8000 sends the MAC-in-MAC-encapsulated packet over the VXLAN tunnel to the VSP 4000.
- The VSP 4000 receives the packet and sends it to the ONA network port.
- The ONA decapsulates the packet by removing the VXLAN header and sends the MAC-in-MAC packet header out the ONA device port back to the VSP 4000.
- The VSP 4000 decapsulates the MAC-in-MAC header and forwards the packet to User B.

The following flow occurs when User B sends a packet to User A:

- The VSP 4000 receives the packet and sends it to the ONA over the ONA device port with MAC-in-MAC encapsulation.
- The ONA encapsulates the packet with a VXLAN header.
- The ONA then sends the packet out the ONA network port and back to the VSP 4000.
- The VSP 4000 sends the VXLAN-encapsulated packet over the Routed IP network to the VSP 8000.

*** Note:**

To interoperate with the VSP 8000, you must set the MTU on the VSP 4000/ONA combination to 1950 bytes.

- The VSP 8000 decapsulates the packet by removing the VXLAN header and the MAC-in-MAC header, and then forwards it to User A.

*** Note:**

Connect the ONA as shown with two ports to the VSP 4000. You cannot connect the ONA directly to the IP core infrastructure.

Logical IS-IS interface

The *logical IS-IS interface* is the mechanism that enables Fabric Extend to connect SPB fabric nodes.

Logical IS-IS interfaces perform the following functions depending on the type of core network:

- In a Layer 3 core network, logical IS-IS interfaces create virtual IP tunnels and encapsulate SPB traffic by adding a Virtual Extensible LAN (VXLAN) header to SPB packets.
- In a Layer 2 core network, logical IS-IS interfaces do not use VXLAN. The tunnels are point-to-point VLAN connections so there is no need to encapsulate a VXLAN header to SPB packets. The logical IS-IS interfaces translate the Backbone VLAN IDs (B-VIDs) and maps them to each of the branch provider VIDs.

Fabric Extend uses virtual tunnels in Layer 3 core solutions to connect SPB fabric nodes. These nodes can stretch over IP routed campus networks, service provider Layer 2 core networks, or service provider Layer 3 core networks such as IP MPLS VPNs.

*** Note:**

VLACP cannot be used on logical IS-IS interface connections.

Layer 2 core network

If the service provider has a Layer 2 core network, note the following points:

- The syntax for configuring a logical interface is:

```
logical-intf isis <id> vid <list of vlans> primary-vid <vlanId> port
<slot/port> Mlt <mltId> [name <name>]
```

- vid <list of vlans> should have two VLANs, not more than two or less than two. The VID range is <2-4059>. You do not have to configure the VIDs as platform VLANs.
- primary-vid should be included in vid <list of vlans>.
- Each logical interface must have a unique set of VIDs for each port or MLT. The same VIDs however, can be reused across a different set of ports or MLTs.
- Logical interface VIDs and BVLANS cannot be the same.
- Configuring the same VIDs as primary and secondary is not allowed.
- The port/MLT on which the Layer 2 core IS-IS logical interface is configured cannot be part of any other user configured VLANs.
- Cannot delete an MLT that is configured as a logical interface tunnel MLT.
- A logical interface consists of a port/MLT and a list of VLANs, where port/MLT is the physical connectivity to the Layer 2 core network and VLANs are the list of VLANs used to transport/bridge IS-IS control packets and Mac-in-Mac data traffic.
- VXLAN headers are not used in Layer 2 core Fabric Extend solutions.
- IS-IS control packets are not encapsulated before they are sent over a logical interface. Instead, the VLAN in the outer Ethernet header (SPB primary bvid) is replaced by the user configured logical interface VLAN.
- Spanning tree is disabled by default on port/MLT on which a Layer 2 core logical IS-IS interface is configured.

Layer 3 core network

If the service provider has a Layer 3 core network, note the following points:

- The syntax for configuring a logical interface is:

```
logical-intf isis <id> dest-ip <destIpAddr> [name <name>]
```

- A logical IS-IS interface points to a remote BEB destination IP address.
- Port and VlanId are not needed to create a logical IS-IS interface, instead they can be retrieved from the next hop of destination IP address.
- IS-IS control packets (IS-IS hello, LSDB, CSNP, PSNP) are encapsulated with a VXLAN header and sent over a logical IS-IS interface.

Types of Fabric Extend Deployments

As the number of Fabric Connect networks increased, the need to connect those networks became more and more desirable. Fabric Extend solves the problem of going beyond the Ethernet Fabric

Connect connections to include the following IP routed wide area network (WAN) and campus solutions:

1. SPB Fabric over an MPLS IP-VPN provider WAN
2. SPB Fabric over an MPLS Virtual Private LAN Service (VPLS) or Provider Backbone Bridging (PBB) Ethernet LAN (ELAN) provider network
3. SPB Fabric over an IP campus network
4. SPB Fabric over an MPLS Pseudo-Wire or Ethernet Virtual Private Line (E-Line) provider network

SPB Fabric over an MPLS IP-VPN provider WAN

The most common Fabric Extend deployment is a hub and spoke topology that connects the Main office over a service provider's MPLS IP VPN to multiple Branch offices. The following figure illustrates how the hub device on the main site establishes virtual tunnels with all of the spoke devices in the same domain. In this scenario, the traffic flows are bidirectional: from hub-to-spoke and spoke-to-hub.

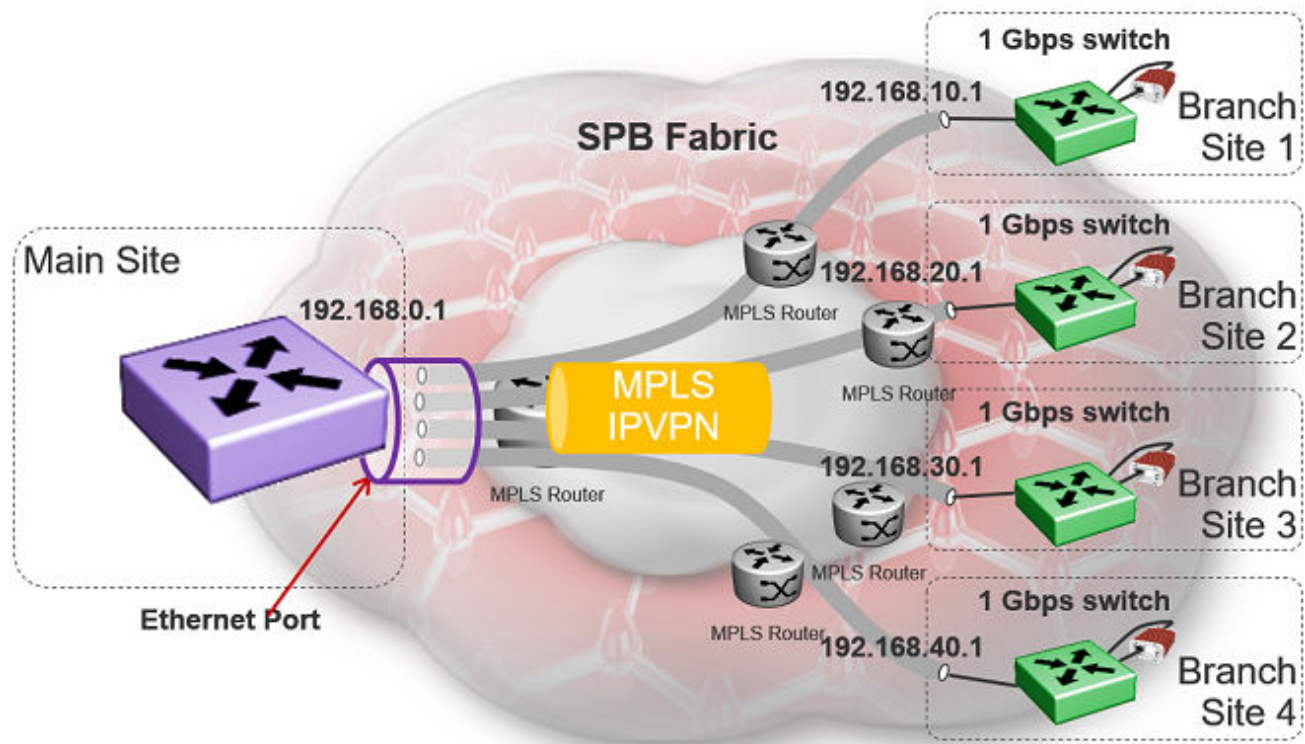

Figure 9: Fabric Extend IP VPN Deployment Option

*** Note:**

If fragmentation and reassembly is required, you must have a 1 Gbps switch/ONA combination on the main site as well.

SPB Fabric over an MPLS VPLS/P2P-VPLS/E-LINE/P2P-VLAN provider network

Where the above hub and spoke deployment is over a Layer 3 MPLS IP-VPN, the following VPLS deployment is over a Layer 2 segment. This type of hub and spoke deployment extends the fabric over an MPLS Virtual Private LAN Service (VPLS) or Provider Backbone Bridging (PBB) Ethernet LAN (E-LINE) network. In this scenario, the SPB nodes are connected with a point-to-point Ethernet link.

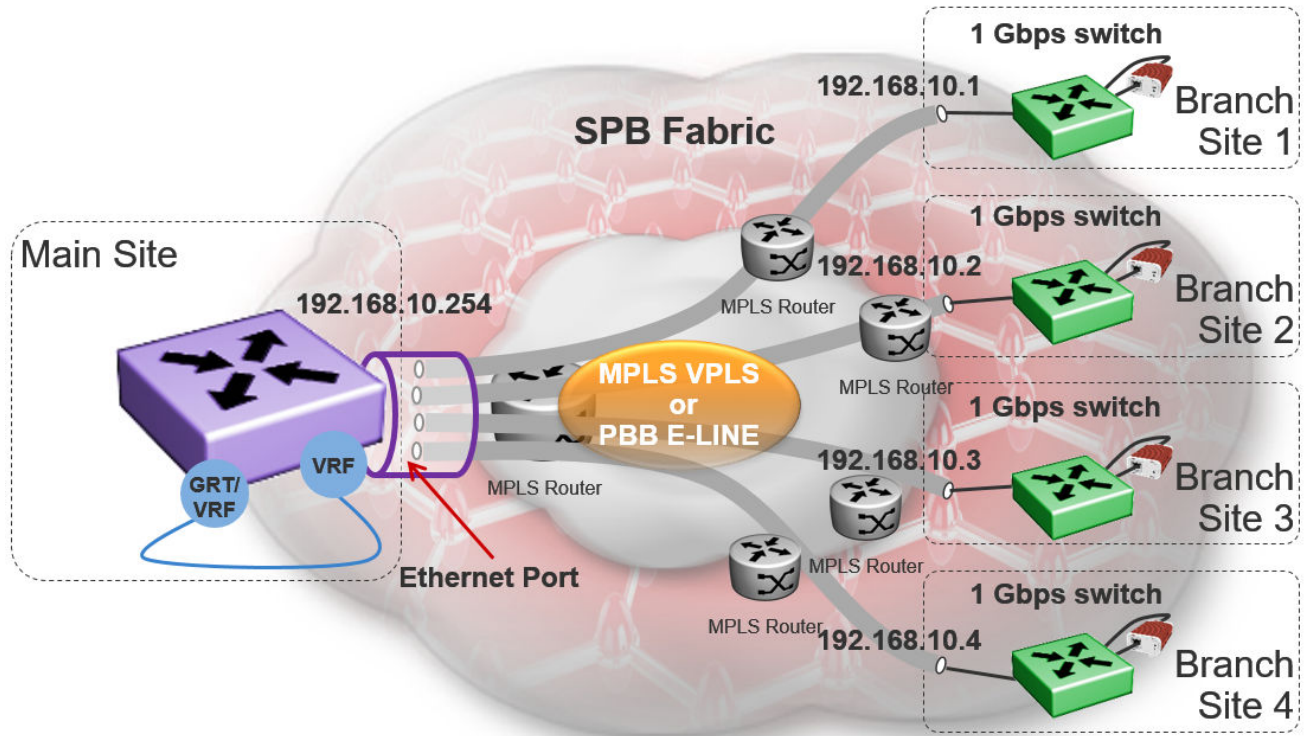

Figure 10: Fabric Extend VPLS Deployment Option

SPB Fabric over an IP campus network

Some customers do not want to migrate their infrastructures to SPB immediately. They want to keep their existing IP core network and deploy SPB on the edge. In this scenario, Fabric Extend supports a fabric overlay on top of the existing campus infrastructure.

The following figure illustrates how this deployment supports any-to-any traffic with full-mesh tunnels between fabric nodes. The fabric nodes serve as campus switches, support routing into the IP infrastructure, and provide an overlay fabric that enables all fabric benefits.

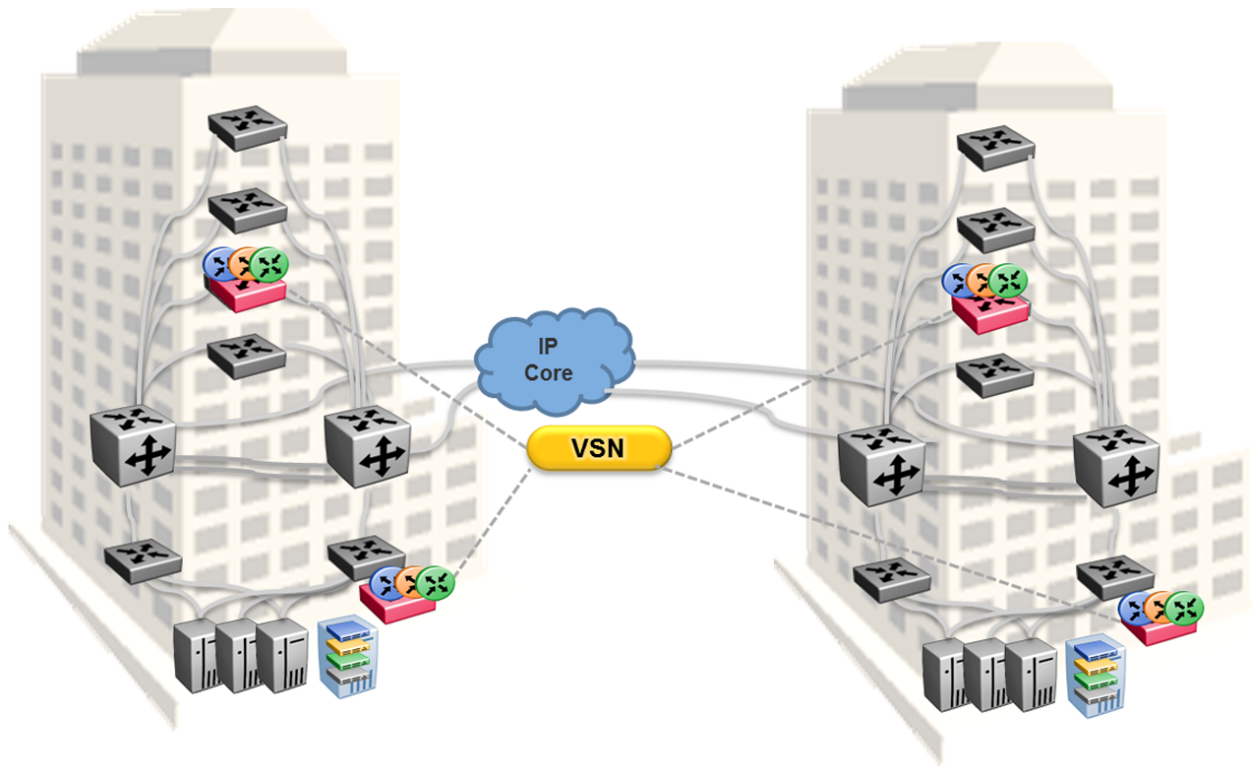

Figure 11: Fabric Extend Full Mesh Campus Deployment Option

SPB Fabric over an MPLS PWE3/E-Line provider network

The following hub and spoke deployment over an MPLS Pseudowire or Ethernet Virtual Private Line (E-Line) uses service provider VLAN tunnels. Because you can map many (VID, port/mlt list) sets to an I-SID, this gives Service Providers the flexibility to let more than one customer use the same VLAN with different I-SIDs.

*** Note:**

The VSP 4000s in this type of deployment do not require an ONA because the tunnels are point-to-point VLAN connections, not VXLAN. Therefore, there is no need for an ONA to encapsulate a VXLAN header to SPB packets.

The following figure illustrates how two dedicated Backbone VLAN IDs (B-VIDs) are mapped from the hub to spoke sites. Logical IS-IS interfaces translate the B-VIDs and maps them to each of the branch provider VIDs.

For a detailed configuration example showing logical interfaces using B-VID translation to two different logical VLAN IDs, see *Shortest Path Bridging (802.1aq) Technical Configuration Guide*.

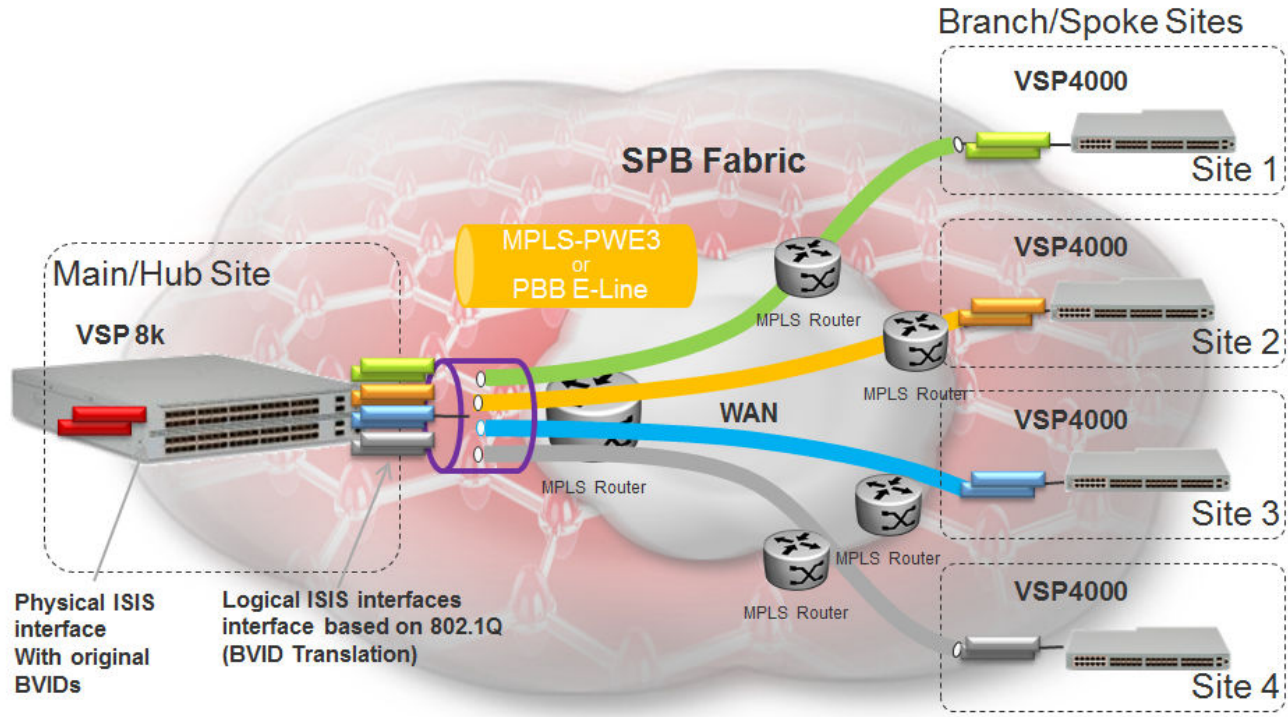

Figure 12: Fabric Extend Pseudowire Deployment Option

Fabric Extend view in EFO

The Fabric Extend view within Extreme Fabric Orchestrator (EFO) provides a graphical management interface for administrators to configure and monitor fabric extensions.

*** Note:**

Although the Fabric Extend view is not required, it is strongly recommended that you include this element in your Fabric Extend solution.

Every Fabric Extend network deployment involves creating numerous bidirectional tunnels. The Fabric Extend view in EFO automates the provisioning of these tunnels by creating *Fabric Extend domains*. When you add nodes to a Fabric Extend domain, the Fabric Extend view automatically creates tunnels between the nodes belonging to the same domain. The Fabric Extend view also ensures error-free bidirectional tunnel provisioning and decommissioning, if required.

Fabric Extend view functions

Fabric Extend view provides the following functions:

- Graphically represents the Fabric Connect “islands”
- Identifies Fabric Extend capable switches
- Graphically represents virtual Fabric Extend links and status
- Provides an easy way to group a set of switches into a Fabric Extend domain
- Provides an easy way to configure point-to-point fabric extensions

Fabric Extend domains

There are two types of Fabric Extend domains:

- **Mesh** – This type of domain creates full-mesh tunnels between all nodes. If you add a switch to a mesh domain, the Fabric Extend view automatically builds Fabric Extend tunnels to all the other switches in the domain.
- **Hub-and-Spoke** – This type of domain identifies each node as either a hub or a spoke.
 - Hub nodes automatically establish bidirectional tunnels with all spoke nodes in the domain.
 - Spoke nodes automatically establish bidirectional tunnels only with the hub nodes in the domain.

Point-to-Point tunnels

You can use Fabric Extend view to provision your own tunnels between Fabric Extend-capable nodes. You must specify the tunnel configuration for both ends of the tunnels.

Fabric Extend considerations

Review the following restrictions, limitations, and behavioral characteristics that are associated with Fabric Extend.

* Note:

If your Fabric Extend configuration includes a VSP 4000/ONA combination, see [ONA considerations](#) on page 50 for more information.

- **Extreme Fabric Orchestrator (EFO)**—The Fabric Extend view within Extreme Fabric Orchestrator (EFO) is not required, but it is highly recommended.
- **Tunnel failover time**—With IS-IS interface default values, tunnel failure detection can take up to 27 seconds. You can reduce the IS-IS interface hello timers to speed up logical link failure detection, but be careful to avoid link flapping due to values that are too low.

* Note:

If the number of IS-IS interfaces on a node is greater than 100, it is a good practice to set the hello timer not lower than 5 seconds.

- **ACL Filters over VXLAN**—IP filters configured to match IP header fields in the headers of VXLAN encapsulated packets, work only when the switch acts as a transit router and does not participate in the initiation or termination of VXLAN traffic.
- **VLACP**—VLACP is not supported over logical IS-IS interfaces.
- **CFM CCM**—CFM Continuity Check Messages are not supported over logical IS-IS interfaces.
- **CFM traceroute and tracemroute**—If CFM packets transit over a layer 3 tunnel (that is the CFM packets ingress a Fabric Extend layer 3 core tunnel and egress through another layer 3 core tunnel), the transit SPBM nodes do not display as intermediate hops in the output for CFM `12 traceroute` and `12 tracemroute`.

This is because the CFM packets are encapsulated in the outer layer 3 header as part of VXLAN encapsulation, and the transit SPBM nodes cannot look into the payload of the VXLAN packet and send a copy of the CFM packet to local CPU for processing.

- **CFM L2 ping**—CFM L2 ping to MCoSPB source mac is not supported and may fail if they are reachable via Fabric Extend tunnel.
- **MACsec**—Switch-based MAC Security (MACsec) encryption is Layer 2 so it cannot be used with Fabric Extend IP, which is Layer 3.
- **MTU minimum in Layer 2 Pseudowire core networks**—Service provider Layer 2 connections must be at least 1544 bytes. In this type of deployment the tunnels are point-to-point VLAN connections that do not require VXLAN encapsulation. The default MTU value is 1950.
- **Logical IS-IS interfaces**—Layer 2 core and Layer 3 core logical IS-IS interfaces are not supported on the same switch at the same time.
- **Fragmentation/reassembly**—There is no fragmentation/reassembly support in Layer 2 core solutions.

If a tunnel was initially UP between a VSP 4000 and a VSP 7200 or VSP 8000 with MTU 1950 and then the VSP 4000 was later configured for fragmentation, the following behavior occurs:

- If the ONA MTU is less than 1594, the tunnel to the VSP 7200 (or VSP 8000) will go DOWN.
- If the ONA MTU is 1594 and above, the tunnel will stay UP, but any fragmented packets received from the VSP 4000 will be lost at the VSP 7200 (or VSP 8000) site.

Fragmented traffic can only be sent with a VSP 4000/ONA combination on both ends with the same MTU configured on each end.

- **RFC4963 and RFC4459 considerations:**

The ONA 1101GT provides for the IP MTU of the Network port to be reduced from the default setting of 1950 bytes to 1500 bytes or lower. The MTU reduction feature with Fabric Extend is provided to facilitate the connection of two Fabric Connect networks over an IP network with any MTU without requiring end stations on the networks to reduce their MTU. The ONA 1101GT with the IP MTU of the network port set to 1500 bytes will fragment Fabric Extend VXLAN tunnel packets exceeding 1500 bytes. The ONA 1101GT will also reassemble fragmented Fabric Extend VXLAN tunnel packets at the tunnel termination point. The IP fragmentation and reassembly RFC 791 describes the procedure for IP fragmentation, and transmission and reassembly of datagrams and RFC4963 and RFC4459 detail limitations and network design considerations when using fragmentation to avoid out of order packets and performance degradation.

Factors that can impact performance are —

- The link speed per VXLAN IP address should be slower than 1G to avoid reassembly context exhaustion.
- ECMP and link aggregation algorithms in the IP core should be configured not to use UDP port hashing that could send IP fragments after the first fragment on different paths causing out of order packets. This is due to the fact that subsequent fragments do not have UDP port information.

! Important:

Different MTU sizes on each end can result in traffic drops.

- **Layer 2 logical IS-IS interfaces**—Layer 2 logical IS-IS interfaces are created using VLANs. Different Layer 2 network Service Providers can share the same VLAN as long as they use different ports or MLT IDs.
- **MTU minimum in Layer 3 core networks**—Service provider IP connections must be at least 1594 bytes to establish IS-IS adjacency over FE tunnels. The 1594 bytes includes the actual maximum frame size with MAC-in-MAC and VXLAN headers. If this required MTU size is not available, a log message reports that the IS-IS adjacency was not established. MTU cannot be auto-discovered over an IP tunnel so the tunnel MTU will not be automatically set. The default MTU value is 1950.

If the maximum MTU size has to be fewer than 1594 bytes, then you require fragmentation and reassembly of packets. The VSP 4000/ONA combination supports fragmentation and reassembly, but you must have VSP 4000s with ONAs at BOTH ends of the IP WAN connection.

- **IP Shortcuts**—The tunnel destination IP cannot be reachable through an IP Shortcuts route.

*** Note:**

If you enable IP Shortcuts and you are using the GRT as the tunnel source VRF, you must configure an IS-IS accept policy or exclude route-map to ensure that tunnel destination IP addresses are not learned through IS-IS.

If you enable IP Shortcuts and you are using a VRF as the tunnel source VRF, this is not an issue.

- **Layer 3 over Layer 2 Limitation**—The VSP 7200 and VSP 8000 require a single next hop (default gateway) for all tunnels.
 - Over a layer 3 core network, on a given outgoing port or MLT, there is no issue as the one router next hop can support multiple VXLAN tunnels to one or more remote sites.
 - For layer 3 tunneling over a layer 2 core, the VSP 7200 or VSP 8000 without any specific configuration supports only one Fabric Extend tunnel to one remote site. The workaround for this single next hop issue is to create an additional VRF, VLAN, and loopback interface.

For a configuration example of this workaround, see *Shortest Path Bridging (802.1aq) Technical Configuration Guide*.

*** Note:**

This is a VSP 8000 and VSP 7200 limitation; it is not a limitation of the VSP 4000.

- You cannot establish a Virtual IST (vIST) session over a logical IS-IS interface. IST hellos cannot be processed or sent over a logical IS-IS interface if that is the only interface to reach BEBs in vIST pairs.

Assume that vIST is established over a regular NNI interface and the NNI interface goes down. If the vIST pairs are reachable through a logical IS-IS interface, then the vIST session goes down in up to 240 seconds (based on the IST hold down timer). During this time, the error

message IST packets cannot be sent over Fabric Extend tunnels, vist session may go down is logged.

 **Caution:**

Expect traffic loss when the vIST session is down or when the error message is being logged.

• **Port Mirroring Resources:**

Port mirroring resources are limited to four ports simultaneously (where each mirroring direction counts as one). For example, if two mirroring ports are designated to mirror both ingress and egress traffic then all four mirroring ports are consumed.

Port mirroring shares these four resources with other applications such as port mirroring RSPAN, Fabric Extend, Application Telemetry, and ACL with mirror action. Each one of these applications consumes at least one port mirroring resource. (RSPAN consumes two if you configure both Ingress and Egress modes.)

 **Important:**

- To enable any one of the above applications, you must have at least one free mirroring resource. If all four port mirroring resources are already in use, the switch displays a `Resource not available` error message when you try to enable the application.
- The VSP 8600 uses the four reserved resources for port mirroring and ACLs that have a mirroring action. For the other applications, this restriction does not apply because the VSP 8600 uses mirroring resources that do not come out of the four reserved port mirroring resources.

ONA considerations

 **Note:**

Review the following restrictions, limitations, and behavioral characteristics that are associated with the ONA.

ONA Network port requirements

The following are **Network** port mandatory requirements for configuring Fabric Extend on the VSP 4000:

- The ONA Network port should not be part of any static/LACP MLT configurations.
- The ONA Network port should be part of a VLAN that belongs to the GRT.
- The ONA Network port that is configured on the switch cannot be tagged. It must be an Access port.

ONA Device port requirements

The following are **Device** port mandatory requirements for configuring Fabric Extend on the VSP 4000:

- The ONA Device port should not be part of any static/LACP MLT, VLAN, or brouter configurations.

- The ONA Device port should not be configured as an access port. It is automatically configured as a trunk port when the `ip-tunnel-source-address` command is configured.
- The ONA Device port has to be connected directly to the VSP 4000 node where the FE tunnels originate.

Layer 3 and Layer 2 ONA requirements

An ONA is required for Fabric Extend Layer 3 core solutions. An ONA is *not* required in Layer 2 core solutions because the tunnels are point-to-point VLAN connections, not VXLAN. Therefore, there is no need for an ONA to encapsulate a VXLAN header to SPB packets.

DHCP server

ONAs require access to a local DHCP server to automatically configure IP addresses. Configure an untagged ONA management VLAN to where the ONA is connected with its network side interface. If DHCP is used, a DHCP relay configuration needs to be added to the ONA network side port in order for the ONA to get an IP address assigned from a DHCP server. Alternatively, you can manually configure its IP address and other required settings with the ONA Manual Configuration menu.

IP tunnel source address

Before the ONA can get an IP tunnel source address from the VSP 4000, the following steps must be taken:

- Connect the Device and Network ports on the ONA to the VSP 4000.
- Make sure that the ONA is connected to a DHCP server. If a DHCP server is unavailable, statically configure an IP tunnel source address on the ONA.
- Create a Management VLAN on the ONA that includes the Network port.
- Designate the Device port for the IP tunnel source address in the configuration file.

The syntax for the IP tunnel source address is: `ip-tunnel-source-address <A.B.C.D> port <slot/port> [mtu <750-1950>] [vrf WORD<1-16>]`.

Automatic routing of VXLAN packets on the VSP 4000

If you configure an IP tunnel source address in a VRF instead of a GRT, then the VSP 4000 automatically routes VXLAN packets from the ONA network port into the VRF configured as part of the IP tunnel source. Although the ONA network port is a part of the management VLAN that is in the GRT, for VXLAN encapsulated packets, the VSP 4000 automatically routes the packets into the VRF in which the tunnel source IP address is configured. This is done using a filter rule that the VSP 4000 software automatically sets up that filters based on whether the incoming port is equal to the ONA network port and the packet has a VXLAN header.

The Management VLAN on the VSP 4000 that is used to communicate with the ONA must always be in a GRT and must not be a part of the IP tunnel source VRF.

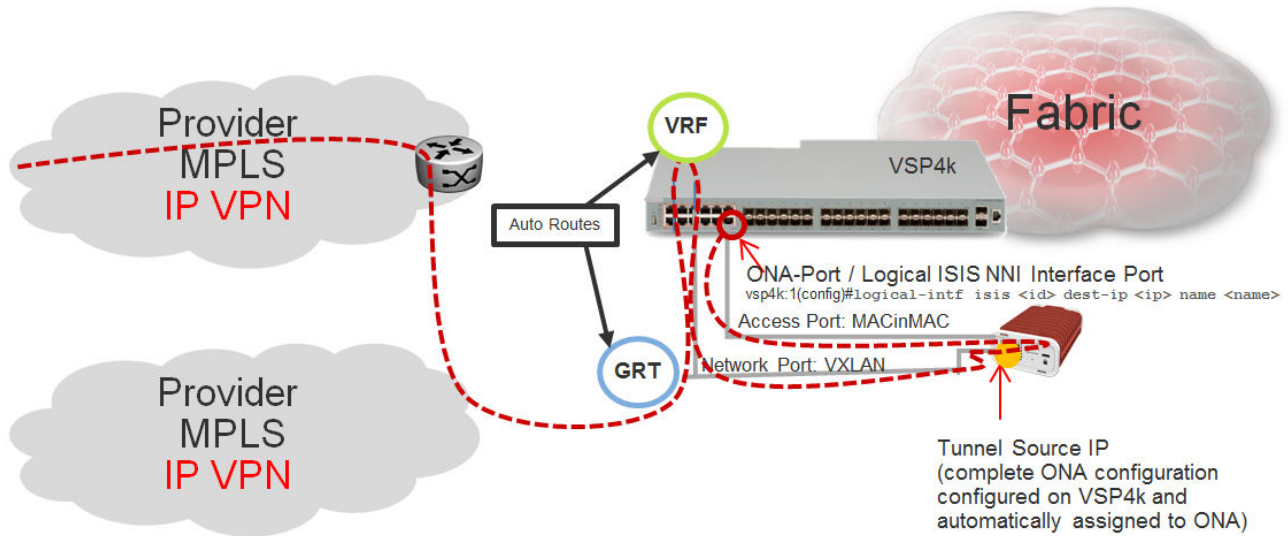

Figure 13: Autorouting between GRT and VRF

ONA Gateway

The ONA gateway has to be a local IP address on the ONA Management VLAN. The ONA gateway IP address must be the same as the local IP address of the VSP 4000 connected to the ONA.

*** Note:**

Extreme does not support ONA gateway IP addresses that are not local to the VSP 4000. For example, you cannot use a VRRP IP address configured in a switch cluster for the ONA gateway.

Maximum MTU

The ONA supports a maximum transmission unit (MTU) size of 1950 bytes. For the VSP 4000 to work with a VSP 8000 or VSP 7200, the MTU size must be left at the default setting of 1950. If the core network does not support jumbo frames, the VSP 4000 with ONA must be used on all sites.

Fragmentation and reassembly

If the maximum MTU size has to be fewer than 1594 bytes, then you require fragmentation and reassembly of packets. The VSP 4000s with ONAs support fragmentation and reassembly, but you must have VSP 4000s with ONAs at BOTH ends of the IP WAN connection.

QoS priority queues

The ONA 1101GT implements both Layer 2 and Layer 3 QoS. Specifically, it implements IEEE 802.1Q VLAN TCI PCP (Priority Code Point) and IETF IPv4 DSCP (Differentiated Services Code Point). These are implemented in hardware with the limitation that there are four Weighted Random Early Detection (WRED) priority queues, numbered 4 (highest) to 7 (lowest). The following tables show the mappings from the PCP and DSCP values in the packet to the priority queue.

The hardware puts each packet in 1 of the 4 HW queues in the following order:

1. If a packet is a tagged VLAN packet, the PCP field determines the priority queue. (Ethertypes 0x8100 and 0x88a8 identify tagged VLAN packets.)

2. If the packet is an IPv4 packet, the DSCP field determines the priority queue.
3. Use the highest priority queue (4).

The HW QoS is always enabled, and the CP to priority queue mappings are static.

The following table defines the 3 bit VLAN PCP value to queue number mapping. The queues are numbered 4..7 with 4 being the highest priority and 7 the lowest priority.

Table 2: VLAN PCP to queue mapping

VLAN PCP	Queue Number
0	7
1	7
2	6
3	6
4	5
5	5
6	4
7	4

The following table defines the 6 bit IPv4 DSCP value to queue number mapping. The queues are numbered 4..7 with 4 being the highest priority and 7 the lowest.

Table 3: IPv4 DSCP to queue mapping

IPv4 DSCP	VLAN PCP	Queue Number
0	1	7
1	1	7
2	1	7
3	1	7
4	1	7
5	1	7
6	1	7
7	1	7
8	2	6
9	1	7
10	2	6
11	1	7
12	2	6
13	1	7
14	2	6

Table continues...

IPv4 DSCP	VLAN PCP	Queue Number
15	1	7
16	3	6
17	1	7
18	3	6
19	1	7
20	3	6
21	1	7
22	3	6
23	1	7
24	4	5
25	1	7
26	4	5
27	4	5
28	4	5
29	1	7
30	4	5
31	1	7
32	5	5
33	1	7
34	5	5
35	5	5
36	5	5
37	1	7
38	5	5
39	1	7
40	6	4
41	5	5
42	1	7
43	1	7
44	1	7
45	1	7
46	6	4
47	6	4
48	7	4
49	1	7

Table continues...

IPv4 DSCP	VLAN PCP	Queue Number
50	1	7
51	1	7
52	1	7
53	1	7
54	1	7
55	1	7
56	7	4
57	1	7
58	1	7
59	1	7
60	1	7
61	1	7
62	1	7
63	1	7

Fabric Attach

With Fabric Attach, network edge devices that do not support Shortest Path Bridging (SPB), MAC-in-MAC encapsulation (802.1ah) or service identifiers (I-SIDs) can take advantage of SPB infrastructure. To attach to an SPB network, edge devices signal an SPB-aware FA Server to automatically configure the I-SIDs. The edge devices can then utilize existing SPB features across the fabric and leverage SPB infrastructure capabilities without manual configuration. Fabric Attach uses the IEEE 802.1AB Logical Link Discovery Protocol (LLDP) to signal a desire to join the SPB network.

FA uses the client-server model. An initial handshake occurs between the FA Server and the FA Client. After the discovery phase is complete, the FA Server accepts requests (from FA Clients) to add the C-VID (VLAN ID) and I-SID elements in the SPB network, and also automatically configures the necessary C-VID and I-SID. The FA Server then responds with an acknowledgement of whether the request succeeded. FA Clients can also be aggregated into a proxy device that handles the handshakes and requests on behalf of many clients, to the server. All of the discovery handshakes and I-SID mapping requests are then transferred using LLDP Type, Length, Value (TLV) fields.

FA leverages LLDP to discover directly connected FA peers and to exchange information associated with FA between those peers. Based on the LLDP standard, FA information is transmitted using organizational TLVs within LLDP Protocol Data Units (PDU).

FA Zero Touch Client Attachment

FA Zero Touch Client Attachment eases the configuration process on FA-capable devices by automating specific configuration tasks required for FA functionality.

*** Note:**

Only the base functionality of Zero Touch Client Attachment is supported.

After you initially configure Zero Touch Client Attachment on the FA Server, the settings are exported to receiving FA devices, where the required configuration tasks are automatically performed.

Base Zero Touch Client Attachment operation is tightly coupled with FA operation. Although you can enable or disable Zero Touch Client Attachment separately from FA, the feature is dependant on data that is only available during exchanges between the FA Server and FA Proxies, after a primary FA Server has been selected. By default, base Zero Touch Client Attachment support is *enabled*.

Base Zero Touch Client Attachment operation, when enabled, extracts management VLAN data from the primary FA Server advertisements and uses this data to update the in-use management VLAN if applicable. An FA Client can also utilize FA-provided management VLAN data after the FA Proxy or Server is discovered.

Zero Touch is active when the following criteria are met:

- On an FA Proxy:
 - Zero Touch Client Attachment is enabled
 - Fabric Attach is enabled
 - A primary FA Server is discovered and selected
- On an FA Server:
 - Zero Touch Client Attachment is enabled
 - FA is enabled
 - FA Proxies or FA Clients are discovered

The switch supports configurable VLANs in the range of 1 to 4059. VLAN 0 is invalid. VLAN ID 1 is the default VLAN and you cannot create or delete VLAN ID 1. VLAN IDs on the switch range from 2 to 4084 but, by default, the system reserves VLAN IDs 4060 to 4094 for internal use. On switches that support the vrf-scaling and spbm-config-mode boot configuration flags, if you enable these flags, the system also reserves VLAN IDs 3500 to 3998.

*** Note:**

You must enable Base Zero Touch **auto-client attach** and define the target Fabric Attach client in order to initiate Zero Touch Client Attachment processing.

FA Signaling generated by an FA Proxy or Server contains management VLAN data. If the management VLAN advertised by the primary FA Server differs from the management VLAN currently configured on the FA Proxy, Zero Touch Client Attachment initiates the following:

- VLAN creation — If the FA Server-specified management VLAN does not exist on the FA Proxy, Zero Touch Client Attachment creates a port-based VLAN.
- Management VLAN update — The created port-based VLAN becomes the designated management VLAN for the FA Proxy. No operations related to the previous management VLAN, such as port membership updates or VLAN deletion, are performed.

- Port VLAN membership update (FA Proxy/Server) — If required, Zero Touch Client Attachment updates the port VLAN membership to ensure that the uplink port through which the primary FA Server is accessed is a member of the management VLAN, for network accessibility.
- Port Default VLAN (PVID) update — The port-based PVID is automatically updated based on the VLAN ID value.
- Port Default Priority update — The default 802.1p user priority for the port is updated based on the specified port priority value of the Zero Touch client (range is 0–7).
- Zero Touch Client Specification removal — All Zero Touch client-related settings are updated based on the FA client discovery. Deleting a Zero Touch client specification or disabling any related Zero Touch option does not result in the immediate removal of any previously applied settings.

*** Note:**

The FA Proxy does not update the acquired management VLAN if the primary FA Server is lost. This data is updated if the management VLAN advertised by the current primary FA Server changes or if another primary FA Server is selected and new management VLAN data is advertised by the server.

Management VLAN and port membership updates performed by Zero Touch are maintained in non-volatile storage and are restored following a system reset. You must remove or update these configuration settings if they are deemed unnecessary at a later time.

- IP Address Source Mode Update — Updates the IP address source mode of the receiving device to *DHCP-When-Needed*, to initiate DHCP-based IP address acquisition if necessary.
- Automation of the FA Client Port Mode — Automates the configuration of EAP port modes based on the type of discovered FA Clients. Applies to FA Proxy and FA Server devices. Automated configuration is applied only to FA-enabled ports.
- ZTC Installation — Initiates ZTC installation on applicable ports on the receiving device. Applies to FA Proxy and, in a limited manner, to FA Server devices. Automated configuration is applied only to FA-enabled ports.
- Auto Trusted FA Client Port Mode — Initiates automatic QoS interface class update based on the type of discovered FA clients. Applies to FA Proxy and FA Server devices. Automated configuration is applied only to FA-enabled ports.
- Auto PVID FA Client Port Mode — Initiates automatic port PVID, port management VLAN membership and post tagging mode based on the type of discovered FA device. Applies to FA Proxy and FA Server devices. Automated configuration is applied only to FA-enabled ports. This configuration is incompatible with the automatic FA Client Port Mode and ZTC Automatic attach options.

Fabric Attach licensing

The Fabric Attach solution operates with a Base License.

For more information about licensing, see *Administering*.

Fabric Attach components

FA components dynamically communicate with each other using FA signaling.

FA signaling

FA has defined organizational specific TLVs within the standard LLDP protocol, to exchange messages and data amongst components of an FA solution. The FA TLVs facilitate handshaking and authentication, processing of requests for the creation of services, and providing responses on whether the requests succeeded. In addition, these services are deleted when the service requests are terminated, or when the authentication criteria are no longer valid. All components that participate in FA must be able to send, receive, and interpret the FA TLVs.

FA components

FA includes the following network elements as components:

- FA Server:

An SPB-capable switch at the edge of a Fabric Connect cloud.

An FA Server receives requests from FA Clients or FA Proxies to create services with specific I-SID-to-VLAN bindings. The FA Server completes the association between conventional networks and fabric-based virtual service networks. For more details on the operation of an FA Server, see [Fabric Attach Server](#) on page 58.

- FA Proxy:

A network switch that supports the definition of I-SID-to-VLAN assignments and has the ability to advertise these assignments for possible use by an FA Server. FA Proxy switches also support the client mode for directly attached users or end devices. Typically, FA Proxies support downstream FA Client devices, while being directly connected to an upstream FA Server device.

- FA Client:

A network attached end-point device that advertises I-SID-to-VLAN binding requests for service creation, to an FA Proxy or an FA Server. FA Clients use FA signaling to automatically attach to fabric services.

What network devices support Fabric Attach?

FA component	Network devices
FA Server	Virtual Services Platform 4000, 7200 Series and 8000 Series switches.
FA Proxy	Access switches such as the ERS 4800 and ERS 5900.
FA Client	<ul style="list-style-type: none"> • WLAN 9100 Access Points • IP Phones, Hypervisors supporting FA Client functionality on an Open vSwitch, or other third party devices

Fabric Attach Server

FA Server operation

In an FA solution, the FA Server performs the role of connecting FA Clients and FA Proxies to the SPB fabric, with minimal configuration. As part of the discovery handshake between the FA Server and client or proxy devices, LLDP PDUs are exchanged. Using standard LLDP, the FA Server learns neighbors, that include the proxy and client devices. In addition, the FA Server transmits

organizational-specific element-discovery TLVs that are used by the client or proxy device to recognize its attachment to the FA Server.

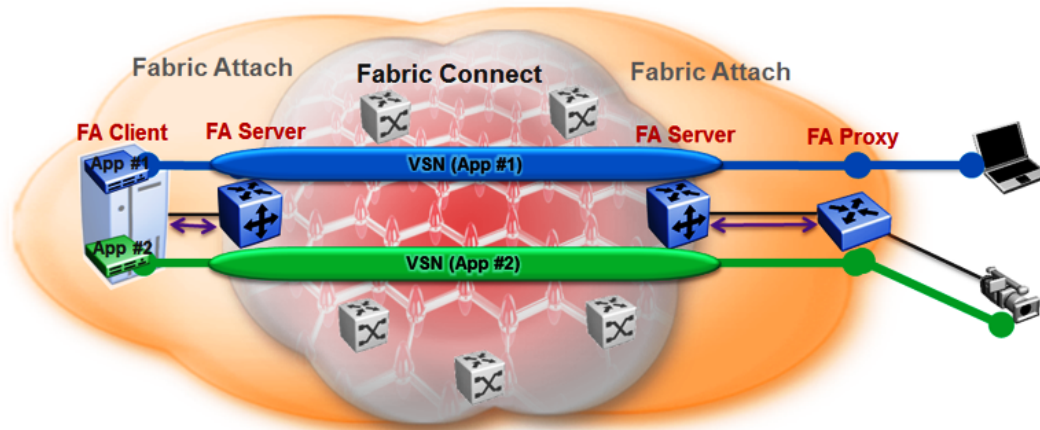

Figure 14: Fabric Attach Server connecting client or proxy devices to the Fabric network

After the initial discovery handshake is complete, the client or proxy device transmits I-SID-to-VLAN assignment mapping requests to the FA Server to join the SPB fabric. These requests include the C-VID (VLAN ID) and the I-SID that the client or proxy device needs to join. The FA Server then creates the requested C-VID and I-SID on its device. It then responds with a PDU (containing the FA-specific TLV) to indicate whether the request succeeded. The I-SID thus created is a ELAN I-SID with endpoints of type Switched UNI. After I-SID creation, the I-SID is also advertised to the SPB network by IS-IS.

The traffic that is sent to or received from the SPB cloud is MAC-in-MAC (MiM) encapsulated. The FA Server, being SPB-capable, decapsulates the MiM traffic. If the I-SID matches the I-SID created on behalf of the client or proxy, the FA Server sends the traffic to that client or proxy and passes it on the C-VID that it expects.

FA Server configuration

An FA Server can be configured at two levels—global and interface.

Configuration at the global level enables or disables FA on the entire switch. However, for attachment of clients or proxy devices, you must also configure FA at the interface level. Interfaces can be ports (including channelized ports), MLTs, SMLT or LACP MLTs. Enabling FA on an interface also enables transmission of LLDP packets that contain the FA-specific TLVs.

When you disable FA on an interface, LLDP transmission automatically stops on that interface.

⚠ Caution:

Disabling FA or IS-IS triggers a flush of FA information on the switch. Disabling FA at the global level flushes *all* FA element-discovery information and mappings. Disabling at the interface level flushes element-discovery information and mappings associated with that interface.

! Important:

The only provisioning mode supported on the FA Server is SPB.

FA Proxies and FA Clients

The configuration mode of FA Proxies and FA Clients is not supported. However, in an FA solution, the FA Server interacts with FA Proxies and FA Clients by accepting LLDP PDUs (containing FA TLVs) and using them to automatically create Switched UNI I-SIDs and endpoints, based on the mapping requests contained in those TLVs. For more information, see [FA TLVs](#) on page 60.

Fabric Attach operation

The following sections detail FA operation.

FA TLVs

FA leverages LLDP to discover directly connected FA peers and to exchange information associated with FA amongst those peers. FA information is transmitted using company-specific proprietary organizational Type, Length, Value (TLV) fields within LLDP Protocol Data Units (PDU). The following section describes the TLVs for FA.

FA uses two TLVs:

- FA Element TLV
- FA Assignment TLV

FA Element TLV

The FA Element TLV is used by FA elements to advertise Fabric Attach capabilities. This data forms the basis for FA element discovery and is used in the initial handshake between the FA Server and a client or proxy device.

TLV Type [127]	TLV Length [50 octets]	OUI [00-04-00]	Subtype [11]	HMAC-SHA Digest	Element Type	State	Mgmt VLAN	Rsvd	System ID
7 bits	9 bits	3 octets	1 octet	32 octets	6 bits	6 bits	12 bits	1 octet	10 octets

Figure 15: FA Element TLV format

Table 4: FA Element TLV field descriptions

Field	Description
TLV Type	Indicates whether the discovered element is a client or a proxy device.
OUI and Subtype	The information in these fields is used in LLDP packet handling.
HMAC-SHA Digest	<p>Data integrity and source validation is supported through the use of the HMAC-SHA256 message authentication. This field supports a digest exchange between the source and destination devices. Symmetric private keys are used for digest generation. The HMAC-SHA256 generated digest size is 32 octets.</p> <p>The HMAC-SHA256 digest is computed starting with the Element Type data, that is, it starts at zero-based byte 38 of the TLV. The digest is then placed in the HMAC-SHA256 Digest field in the TLV prior to transmission. Upon receipt, the digest is again computed and the resulting digest is compared against the received digest. If the received digest is the same as the newly computed digest, the TLV is considered</p>

Table continues...

Field	Description
	<p>valid and processing commences. If the comparison fails, the TLV is discarded and processing is terminated.</p> <p> Caution:</p> <p>If FA communication occurs between non-secure systems, the HMAC-SHA256 Digest data must always be zero. If one system operates in secure mode and the other operates in non-secure mode, the FA Element TLV is discarded before it is processed by the system operating in secure mode.</p>
Element Type	<p>Indicates the supported element type. The primary element types are the FA Server, FA Proxy and FA Client.</p> <p>An FA Server is an SPB capable device that accepts externally generated I-SID-to-VLAN assignments. An FA Proxy is a non-SPBM device that supports I-SID-to-VLAN assignment definitions and advertises these assignments for possible use by an FA Server. An FA Client, also a non-SPBM device, advertises I-SID-to-VLAN assignments to a directly connected FA Proxy or an FA Server. Both tagged and untagged FA Client connections are supported.</p> <p>The list of supported element types and their values are:</p> <ul style="list-style-type: none"> • FA Element Type - Other (1) • FA Server (2) • FA Proxy (3) • FA Server No Authentication (4) • FA Proxy No Authentication (5) • FA Client - Wireless Access Point Type 1, which directly attaches to the SPBM network. • FA Client - Wireless Access Point Type 2, which is tunneled to a controller. • FA Client - Switch (8) • FA Client - Router (9) • FA Client - IP Phone (10) • FA Client - IP Camera (11) • FA Client - IP Video (12) • FA Client - Security Device (13) • FA Client – Virtual Switch (14) • FA Client – Server/Endpoint (15)
State	<p>Indicates the link tagging requirements in FA Client-sourced frames. This field also indicates the current provisioning mode.</p> <p>The Link VLAN Tagging bit (bit 1) has one of the following values:</p> <ul style="list-style-type: none"> • 0 — indicates that all traffic on the link is tagged. In this case, all discovered FA Clients are treated as tagged.

Table continues...

Field	Description
	<ul style="list-style-type: none"> • 1 — indicates that traffic on the link is either tagged or untagged. Here, all discovered FA Clients are treated as untagged. <p>The automatic provisioning mode bits (bits 2 and 3) always have the value 1 for SPB provisioning. The switch only supports the SPB provisioning mode.</p>
Mgmt VLAN	When you configure a management VLAN on the FA Server, it is included in this field in FA Server or FA Proxy sourced frames, and is used to support management VLAN auto-configuration on the downstream proxy and client devices.
System ID	<p>This field contains connection information that a TLV recipient can use to enforce connectivity restrictions.</p> <p>It contains the system MAC address (6 octets) for MLT configurations and the virtual BMAC address for vIST and SMLT configurations. It also contains information on the connection type such as MLT or SMLT.</p>

Limitations

- The FA Element TLV exists only once in an LLDP PDU and is included in all PDUs when the FA service is enabled.
- The maximum length of the FA Element TLV is 56 bytes.

FA I-SID-to-VLAN Assignment TLV

The FA I-SID-to-VLAN Assignment TLV is used by FA Clients to distribute I-SID-to-VLAN assignments that need to be supported by an FA Proxy or an FA Server.

TLV Type [127]	TLV Length [41-506 octets]	OUI [00-04-0D]	Subtype [12]	HMAC-SHA Digest	Assignment Status	VLAN	I-SID
7 bits	9 bits	3 octets	1 octet	32 octets	4 bits	12 bits	3 octets



Figure 16: FA Assignment TLV format

FA I-SID-to-VLAN Assignment TLV fields

Some fields are common to both the FA Element and FA Assignment TLVs. The following fields are specific only to the FA Assignment TLV.

TLV Field	Description
HMAC-SHA Digest	The HMAC-SHA256 digest is computed for the series 1 to 94 of I-SID-to-VLAN assignments, that is, the data for the digest computation starts at zero-based byte 38 of the TLV. The digest is then placed in the HMAC-SHA256 Digest field in the TLV prior to transmission. Upon receipt, the digest is again computed for the series 1 to 94 of I-SID-to-VLAN assignments in the received TLV and the resulting digest is compared against the received digest. If the received digest is the same as the newly computed digest, the TLV is considered valid and processing can commence. If the comparison fails, the TLV is discarded and processing is terminated.

Table continues...

TLV Field	Description
	 Caution: If FA communication occurs between non-secure systems, the HMAC-SHA256 Digest data must always be zero. If one system operates in secure mode and the other operates in non-secure mode, the FA I-SID-to-VLAN Assignment TLV is discarded before it is processed by the system operating in secure mode.
Assignment status	Indicates whether the FA Server accepted or rejected the I-SID-to-VLAN mapping request from a client or proxy device.
VLAN	Indicates the C-VID value advertised by the client or proxy device in the FA I-SID-to-VLAN mapping request.
I-SID	Indicates the I-SID that is advertised by a client or proxy device in the FA I-SID-to-VLAN mapping request. This I-SID is used to create a Switched UNI (ELAN) I-SID.  Note: This I-SID <i>cannot</i> be used by IPVPN, MVPN, SPBM dynamic multicast range, or Transparent Port UNI.

Limitations

- The FA I-SID-to-VLAN Assignment TLV is included in an LLDP PDU only if the FA Server and proxy or client devices are directly connected to each other.
- This TLV can exist only once in an LLDP PDU.
- The size limit of this TLV is 511 bytes. This limits the maximum number of I-SID-to-VLAN assignments supported in an LLDP PDU to 94.
- For an FA I-SID-to-VLAN Assignment TLV to be processed, the FA Element TLV must also be present in the LLDP PDU.

FA Element Discovery

The first stage of establishing FA connectivity is element discovery.

On an FA Server, FA is enabled globally by default. However, you must explicitly enable FA on a desired port or MLT interface. After FA is enabled, the FA Server begins transmitting LLDP PDUs that contain the element discovery TLVs. This information is received by FA Client and FA Proxy devices which in turn also transmit their FA capabilities and settings. After the element handshake completes, the FA Server receives I-SID-to-VLAN assignment mappings from the connected client or proxy devices.

An FA Server can communicate with multiple different FA Client and FA Proxy devices.

FA data processing

In the following FA deployment, a client device (Client 1) attaches to the FA Server (FA Server 1) using a proxy device. Another client device (Client 2) attaches to the FA Server (FA Server 2) at the other edge of the network. The following section describes how data is processed when data traffic is transmitted from Client 1 to Client 2.

When Client 1 successfully attaches to FA Server 1, FA Server 1 creates a unique I-SID-to-VLAN mapping for Client 1 on its device. This mapping contains the I-SID and C-VID advertised by Client

1, using the FA Assignment TLV. For example, assume that Client 1 advertises I-SID 200 and C-VID 250.

Similarly, when Client 2 attaches to FA Server 2, FA Server 2 creates an I-SID-to-VLAN mapping for Client 2 on its device with, for example, I-SID 200 and C-VID 100. This is depicted in the following figure.



Figure 17: Learning of I-SID-to-VLAN mappings

When data traffic ingresses FA Server 1 at the FA-enabled port 1/1, it contains the C-VID of Client 1, which is, 250. The data is VLAN-encapsulated at this stage. As traffic egresses FA Server 1 into the SPB cloud, it is encapsulated with the ELAN I-SID created on FA Server 1 on behalf of Client 1, that is I-SID 200. The traffic is now MiM encapsulated with I-SID 200.

The following figure depicts VLAN encapsulation of data traffic from the FA Client to the FA Server (at either end of the SPB cloud) and its MiM encapsulation as it traverses the SPB cloud.

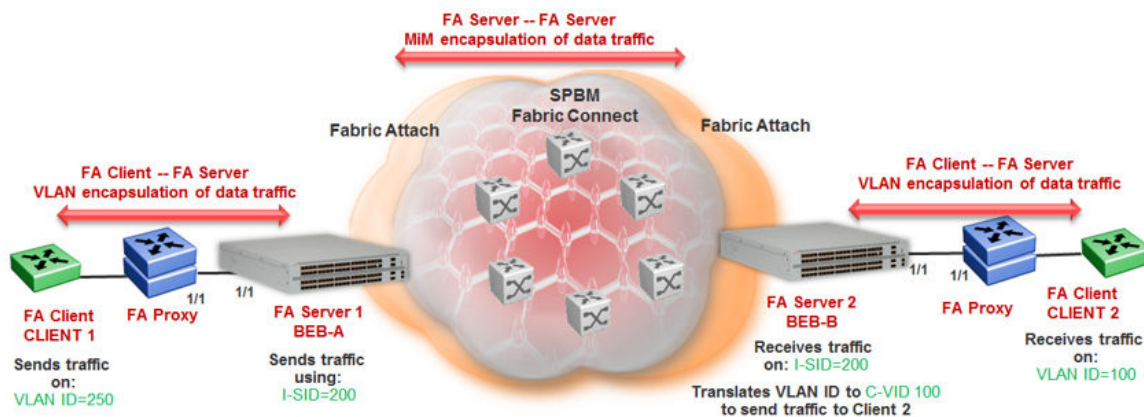

Figure 18: Data encapsulation — VLAN encapsulation and MiM encapsulation

As traffic exits the SPB cloud and ingresses the remote FA Server 2, it continues to be MiM encapsulated with I-SID 200.

At FA Server 2, the MiM traffic is decapsulated. Since the I-SID in the data packet matches the I-SID created on its device on behalf of Client 2, FA Server 2 prepares to send traffic to Client 2. At this stage, to successfully transmit the data traffic to Client 2, FA Server 2 must additionally know the C-VID that Client 2 expects traffic on. This information is obtained from the I-SID-to-VLAN mapping on FA Server 2 created on behalf of Client 2, which is C-VID 100. Thus FA Server 2 translates the C-VID in its data packets to this VLAN ID, and then passes it on to Client 2.

The following figure depicts the typical MiM encapsulation of a data packet. The B-DA and B-SA components indicated the system ID of the FA Server running SPB.

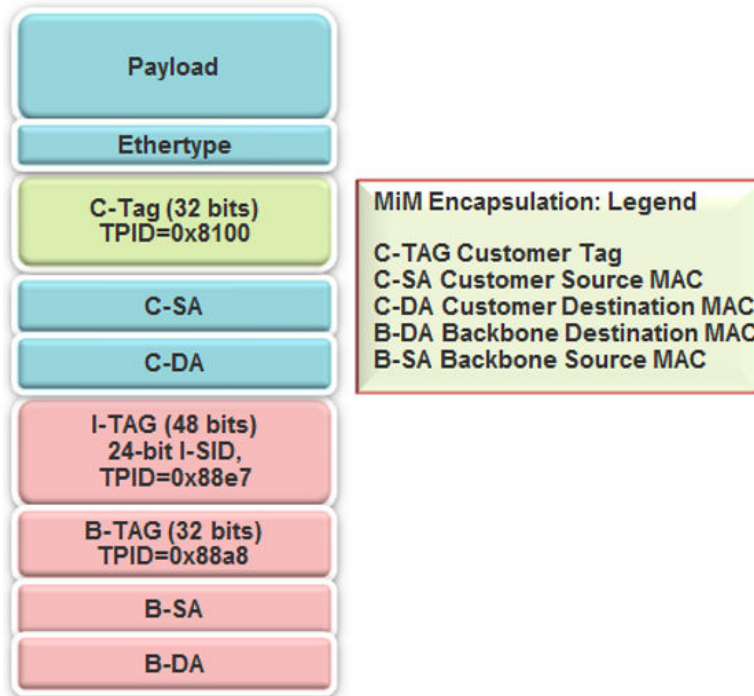

Figure 19: MiM encapsulation

FA Server and I-SID-to-VLAN assignments

FA Client or FA Proxy devices advertise I-SID-to-VLAN assignments to be supported on the FA Server. These assignments can be accepted or rejected by the FA Server. All communication between FA Proxies or Clients and the FA Server is using LLDP. Successful assignments result in the creation of a Switched UNI I-SIDs and endpoints based on the mapping requests.

The FA Server rejects I-SID-to-VLAN assignment requests if:

- FA is not configured properly on the port or MLT.
- Router IS-IS is disabled.

*** Note:**

For Fabric Attach to operate properly and for the FA Server to accept I-SID-to-VLAN assignment requests, IS-IS *must* be enabled.

The following error message is logged immediately after IS-IS is disabled, and appears *only once* in the log file. It does not appear again when an assignment request is made from the FA Proxy.

```
CP1 [12/04/15 00:33:49.733:UTC] 0x00374589 00000000 GlobalRouter FA
INFO Fabric Attach Assignments will be rejected since ISIS is
disabled.
```

- The C-VID and I-SID are not within the supported range.

The supported range of C-VIDs is from 1 to 4094. The value 4095 is not supported. The value 4096 indicates that the port is untagged. An I-SID value of 0 is not supported on the FA Server.

- The I-SID is already assigned to an IP VPN.

The system displays the error message `I-SID is already assigned to an IPVPN`.

- The I-SID is already in use for SPB multicast.

The system displays the error message `SPB Multicast is enabled, ISID 16000000 and greater reserved for dynamic data-isid's used to carry Multicast traffic over SPB`.

- The I-SID has a value that is reserved for internal use.
- The I-SID cannot be used in an IS-IS accept policy.
- The I-SID is associated with a platform VLAN and that VLAN is used as a private VLAN (that is, has a secondary VLAN specified).
- The I-SID is already in use for Transparent Port UNI.
- The port that receives the I-SID-to-VLAN assignment is a member of an MLT, but FA is not successfully enabled on that MLT interface.
- There is a resource error on the FA Server system, such as lack of memory.
- The number of I-SID-to-VLAN assignments on a port exceeds the maximum limit which is 94.
- The number of I-SIDs on the switch exceeds the maximum limit.
- The same endpoint is configured on more than one I-SID.
- The port or MLT is associated with more than one C-VID in the same I-SID.

When the FA Server rejects I-SID-to-VLAN assignments, aside from viewing the log file, you can use *trace* to troubleshoot the cause of rejection.

For an example on troubleshooting rejection of I-SID-to-VLAN assignments on the FA Server and for more information on using *trace*, see *Troubleshooting*.

FA management

You can configure a management I-SID on an FA-enabled port or MLT. This I-SID includes an optional C-VID parameter, which is a VLAN ID that is locally significant to the port or MLT and does **not** represent a platform VLAN.

Depending on whether the C-VID value is specified, the behavior is as follows:

- If the C-VID value is specified, the FA Server transmits this VLAN ID as the management VLAN in the FA Element TLV. A client or proxy receiving this TLV uses this VLAN ID for management traffic on the FA Server uplink.

The range for C-VID values is from 1 to 4094.

- If the C-VID value is *not* specified, the FA Server transmits a management VLAN with a VLAN ID value of 4095 in the FA Element TLV. A client or proxy receiving this TLV uses **untagged** traffic for network management on the FA Server uplink.

If you do not configure a management I-SID, the FA Server transmits a management VLAN ID value of 0 in the FA Element TLV. A client/proxy that receives the FA Element TLV retains the initial management configuration (if any) on its device.

Limitations of FA management I-SIDs

- A management I-SID value of 0 is not supported on the FA Server.
- You cannot enable BPDU on a management I-SID.

FA management configuration considerations

A Switched UNI I-SID that is created when an FA assignment is learned on a port or MLT, is uniquely identified by a tuple comprising of one of the combinations of (port, I-SID and C-VID) or (MLT ID, I-SID and C-VID). When you configure FA management, similar tuples are used. You can configure FA management on an FA-enabled port or MLT on which FA assignment mappings are learned, as long as the FA management tuple *exactly* matches the tuple created by the learned FA mapping.

The following scenarios describe the behavior when you configure FA management on a port or MLT that also receives learned FA mappings, but the tuples do not match.

- **Scenario 1:** You attempt to configure FA management on a port or MLT where an FA assignment mapping is already learned.

For example, consider an FA-enabled port 1/1 on which an assignment mapping is learned, with I-SID 100 and C-VID 20. You can configure FA management on port 1/1 as long as the I-SID and C-VID values exactly match that of the learned FA mapping. However, if you attempt to configure FA management on the port with a different I-SID and C-VID value, the configuration is not successful and an error message displays.

- **Scenario 2:** An FA assignment mapping is learned on a port or MLT that already has FA management configured.

For example, consider that FA management is configured on port 1/1. If an FA assignment mapping is learned on the port with the same I-SID and C-VID values as that of the FA management configuration, then the mapping is accepted. Otherwise the mapping is rejected.

FA message authentication and integrity protection

For the security of FA communication in terms of data integrity and authenticity, a keyed-hash message authentication code can be transmitted within every FA TLV.

It protects the I-SID-to-VLAN assignment exchanges between the FA Server and FA Proxy. The standard HMAC-SHA256 algorithm calculates the message authentication code (digest) involving a cryptographic hash function (SHA-256) in combination with a shared secret key. The key is symmetric, that is, it is known by both the source and destination parties.

By default, on the FA Server, message authentication is enabled at the interface level and a default key is defined to provide secure communication.

You can configure a different authentication key on an interface (port or MLT) on the FA Server, to authenticate a client on that interface. The authentication key is stored in encrypted form when you save configuration on the FA Server. For an FA Client to authenticate and attach to the FA Server, the authentication key must match on both the client and the server. In general, the FA authentication key must match between two FA components exchanging FA TLVs through LLDP.

When you enable FA message authentication, the message authentication key (default or configured) generates a Hash-based Message Authentication Code (HMAC) digest that is included in FA I-SID-to-VLAN Assignment TLV. Upon receipt, the HMAC digest is recomputed for the TLV

data and compared against the digest included in the TLV. If the digests are the same, the data is valid. If the digests are not the same, the data is considered invalid and is ignored.

The FA secure communication setting (enabled/disabled) and the symmetric key data are maintained across resets and restored during FA initialization.

Fabric Attach and Switched UNI

With the C-VLAN UNI feature, I-SID-to-VLAN mappings must be unique across the network. With the Transparent Port UNI (ELAN Transparent) feature, you can map an entire port or MLT to an I-SID.

With the Switched UNI feature, you can associate many different C-VID/port or C-VID/MLT list combinations to a single I-SID.

Switched UNI and FA

FA brings the capability of automatically creating Switched UNI I-SIDs on a switch, without manual intervention. The I-SIDs thus created are ELAN I-SIDs with endpoints of type Switched UNI, and are by default for Layer 2. MAC learning takes place and there is an any-to-any relationship. For Layer 3 participation, you must configure a platform VLAN with the same I-SID value as that of the I-SID in a learned FA mapping.

Note:

The number of Switched UNI I-SIDs created are different for different product families. For more information, see *Release Notes*.

Limitations of FA-created Switched UNI I-SIDs

- An FA-created Switched UNI I-SID is always ELAN.
- You cannot enable BPDU on an FA-created Switched UNI I-SID.
- The ELAN I-SIDs created are by default for Layer 2. For Layer 3 participation, you must *manually* configure a platform VLAN with the same I-SID value as that of the I-SID in a learned FA mapping. You can configure the platform VLAN with the same VLAN ID as that of the C-VID, or use a different value.
- The Switched UNI (ELAN) I-SID cannot be used by IPVPN, MVPN, SPBM dynamic multicast range, or a T-UNI.
- You cannot change from one UNI type to another dynamically. The I-SID must be deleted and created with the new UNI type (Customer VLAN (C-VLAN), Transparent Port user-network-interface (T-UNI), ELAN).
- If the port is a member of an MLT, you must add the entire MLT to the C-VID.
- The port is always in the forwarding state.
- You cannot associate a port or MLT with more than one C-VID in the same I-SID.
- The same C-VID, port or MLT cannot be a member of more than one I-SID. The supported range of C-VIDs is from 1 to 4094. The value 4095 is not supported and cannot be configured. The value 4096 indicates that the port is untagged.
- An I-SID value of 0 is not supported on the FA Server.

Fabric Attach deployment scenarios

Fabric Attach is typically deployed in the access layer(s) of a Fabric Connect network.

Fabric Attach, when used with a Fabric Connect solution, provides the same capabilities at the access layer, but those services and policies are now mapped across the entire network end-to-end. FA makes user and end device attachment simple and creates network configuration and sets up resources only when needed.

An FA Server can be connected to FA Client or FA Proxy devices on three types of interfaces, namely, a port, MLT or an SMLT. The following sections discuss FA in SMLT and non-SMLT deployments.

FA and Switched UNI in non-SMLT deployments

The following deployment shows an SPBM network in which one edge has *manually* configured Switched UNI I-SIDs and the other edge has Fabric Attach (FA). At the FA edge, the I-SIDs are learned using FA TLVs and are automatically created on the FA Server as ELAN I-SIDs with Switched UNI endpoints.

This deployment demonstrates that the FA-created I-SIDs can communicate with any other I-SID (manually created Switched UNI or a C-VLAN with an I-SID), on the local switch or across the SPBM fabric, as long as the I-SID values are the same.

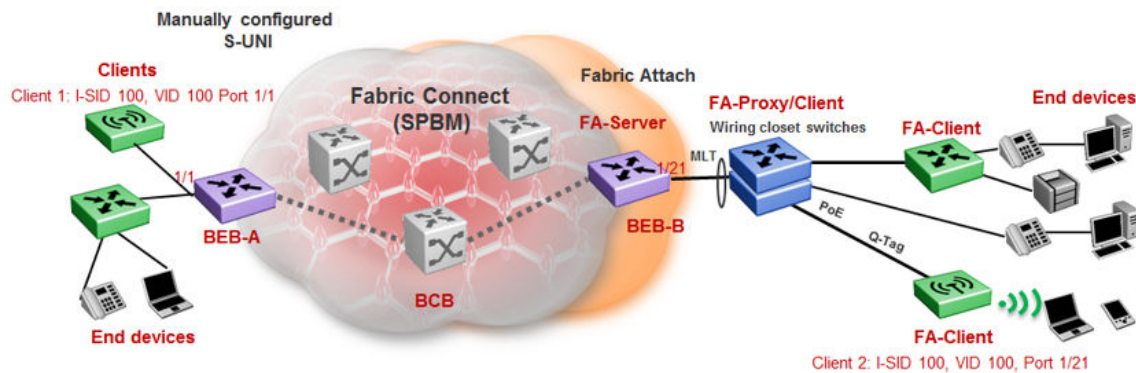

BEB-B is a switch acting as the FA Server with an NNI interface to the SPBM cloud. FA Client and FA Proxy devices send I-SID-to-VLAN mapping requests to the FA Server on the respective FA-enabled ports, using LLDP TLVs. This enables the I-SID endpoints to communicate with the SPB cloud.

If several clients are aggregated in an MLT, at least one of the ports must send the mapping requests for the FA Server to create the I-SID endpoints for that MLT. For example, let Client 2 be a wireless FA Client (such as a WLAN 9100 AP device) on port 1/21, that sends an FA mapping request for I-SID 100 and C-VID (VLAN ID) 100. The FA Server (BEB-B) creates the requested I-SID 100 on its device, and advertises it to the SPB cloud.

BEB-A has manually configured Switched UNI endpoints, one of which is Client 1 (connected at port 1/1) using the *same* I-SID value 100.

With this setup, data traffic can freely flow between Client 1 and Client 2 through the two BEBs and the BCB.

Thus the Switched UNI I-SIDs learned using FA TLVs on one edge of the Fabric Connect (SPBM) network can communicate with the manually created I-SIDs on the other edge, as long as they both have the same value.

FA and Switched UNI in SMLT deployments

The following examples discuss FA in dual-homed and single-homed SMLT deployments.

Fabric Attach in a dual-homed SMLT deployment

The following section describes FA in a dual-homed SMLT deployment. A pair of switches that operate as IST peers act as the FA Server. An FA Proxy (typically a wiring closet switch or an access switch) is connected to FA Clients and in turn to end devices. The FA Clients or FA Proxies advertise I-SID-to-VLAN mappings namely the interface C-VID and the I-SID to the FA Server switches. Both switches receive the mapping information using LLDP TLVs. The switch that learns the mapping first from the LLDP TLV considers the I-SID endpoint to be discovered *locally*, and creates the I-SID on its device. It then sends the mapping information to its peer switch. When the peer switch receives the mapping across IST in a new SMLT message, it too creates the I-SID and endpoint on its device. This I-SID however, is considered to be discovered *remotely*, because the data was synchronized from its peer.

*** Note:**

- For the peer switches acting as the FA Server to transmit the same FA System ID (based on the virtual MAC), SMLT configuration *must* be the same on both peers.
- For successful FA operation, configuration of FA message authentication and the authentication key *must* be the same on both peers.
- For successful operation in Layer 3, a platform VLAN must be configured on both peers. This is necessary for proper MAC learning.

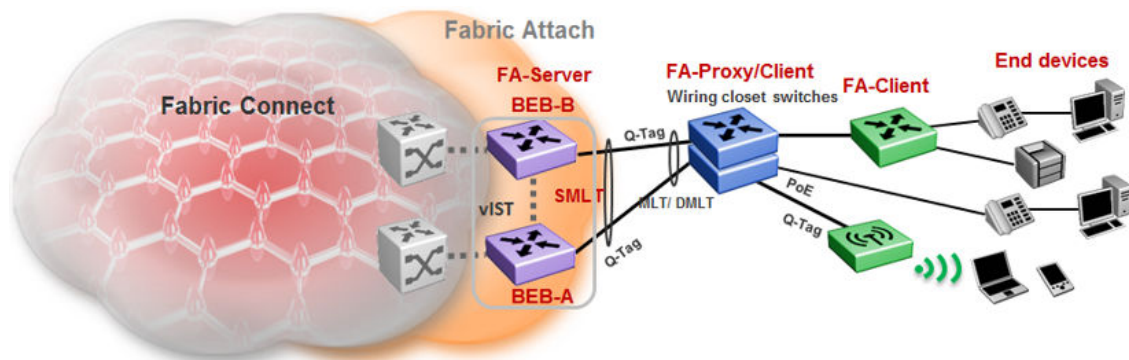

Figure 20: FA in a dual-homed SMLT deployment

In the above example deployment, BEB-A and BEB-B are IST peers collectively acting as the FA Server. FA TLVs sent from the clients (through the proxy) are learned on FA-enabled ports on BEB-A and BEB-B. When BEB-A learns the mapping for the first time on its port, it creates an I-SID on its device. This is considered *locally* discovered. In addition, it sends an SMLT message to its peer BEB-B, which also creates the I-SID on its device. This time, the I-SID is considered *remotely* discovered. Similarly, if BEB-B receives a mapping from a client for the first time, it creates an I-SID (locally discovered) and also sends an IST message to its peer to create an I-SID (remotely discovered).

Irrespective of whether the I-SID creation on the FA peers is triggered by a local TLV event or by messaging from the IST peer, they can both receive data traffic. Thus in a dual-homed SMLT

deployment, any I-SID can be learned irrespective of whether it is discovered locally, discovered remotely or both.

*** Note:**

On the IST peers, if an FA TLV is learned on a port or normal MLT (instead of the admin SMLT), only the I-SID is sent to the peer switch.

Fabric Attach in a single-homed SMLT deployment

In the single-homed SMLT, as shown in the following deployment, the FA Server creates either a locally discovered I-SID (if received from a client using FA TLVs) or a remotely discovered I-SID (if synchronized from its IST peer), but not both.

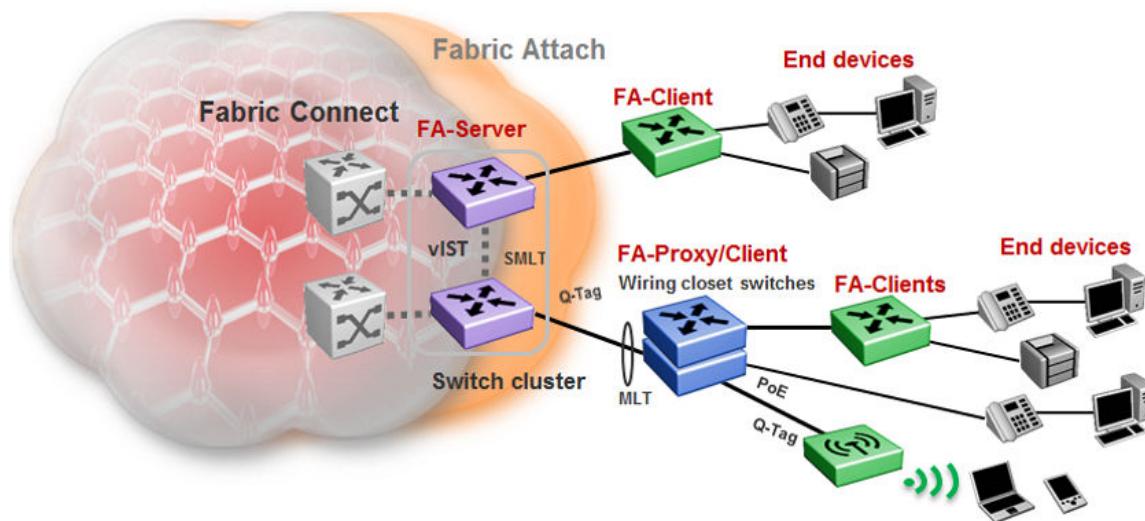

Figure 21: Fabric Attach in a single-homed SMLT deployment

Fabric Attach considerations

Review the following restrictions, limitations, and behavioral characteristics for Fabric Attach.

- IS-IS and FA must be globally enabled on the FA Server, for FA to operate successfully.
- Static MAC, Static ARP and configuration of a static IGMP group are not supported on FA-enabled ports.
- An FA port cannot be a BROUTER port.
- You cannot enable FA on an existing Flex UNI, Transparent Port UNI, or a C-VLAN UNI port.
- FA I-SID-to-VLAN assignment mapping requests from a client or proxy device can be accepted or rejected by the FA Server.
- On an FA-enabled port or MLT, you must first disable LACP before you change the LACP key.
- On VLACP enabled ports, FA and LLDP signaling run independent of the VLACP state. Therefore, requests and responses are exchanged between the FA Server and client or proxy devices even if VLACP is operationally *down*. However, forwarding of data traffic is dependent on VLACP being operationally *up* on the port.

For example, if VLACP is enabled on the FA Server side of the link but not on the proxy or the client side, the FA Server learns the I-SID-to-VLAN assignment mappings and creates the

required I-SIDs on its device. However, data traffic is not forwarded on the port until VLACP is operationally *up*.

- You cannot use a port designated as a Fabric Extend tunnel source (configured using the command `ip-tunnel-source-address`), for Fabric Attach. This limitation applies to the VSP 4000 Series only.
- FA uses the virtual MAC to create the FA system ID when the FA is on an SMLT. If you delete the SPBM instance, then this information is no longer available. Therefore, you must delete the FA on SMLT before deleting the SPBM instance.

IS-IS external metric

The software supports the IS-IS external metric to differentiate between internal and external routes with Accept Policies.

With this feature you can use IS-IS to:

- change the external metric-type of a route when redistributing it from another protocol to IS-IS through route redistribution using a route-map.
- change the external metric-type of a route when accepting a remote IS-IS route with the help of IS-IS accept policies using a route-map.
- match the external metric-type when redistributing IS-IS routes into other protocols using the match option in the route-map.
- match the external metric-type when accepting a remote IS-IS route with the help of IS-IS accept policies by using a route-map
- process the external metric-type in the route selection process.

The IS-IS metric type can also be set using the base redistribute command without using the route-map.

SPB Ethertype

The switch aligns the SPB ethertype to BCB's locally configured SPB ethertype. The BCBs mark the BTAG Ethertype of a transit MAC-in-MAC packet to match its locally configured value when it exits on a different NNI port, even if the BTAG Ethertype on the incoming packet (CFM or SPB) does not match its configured value.

*** Note:**

ISIS Hello packets are always marked with 0x8100 ethertype, and do not change according to the BCB's locally configured values.

Zero Touch Fabric configuration

Zero Touch Fabric configuration automatically configures the SPBM/IS-IS parameters on a switch without user intervention when the `boot config flag factorydefaults` command is set to

fabric. After starting up in fabric mode, the switch can join the SPBM network through connected Fabric Area Network (FAN) ports.

To enable Zero Touch Fabric configuration, you must boot the switch in the factory default fabric mode with the `boot config flag factorydefaults fabric` command. For more information on boot configuration flags, see *Administering*.

Supported platforms and reserved FAN ports

When a switch starts up in the factory default fabric mode setting, Zero Touch Fabric configuration automatically creates the IS-IS interfaces on designated FAN ports and initializes the SPBM/IS-IS parameters to default values. The platform type determines the designated FAN ports. These ports are enabled by default while other ports are disabled by default.

Platform	FAN ports
VSP 4000	1/47, 1/48, 1/49, 1/50
VSP 7200	1/47, 1/48, 2/1, 2/2, 2/3, 2/4, 2/5, 2/6
VSP 8200	1/40, 1/41, 1/42, 2/40, 2/41, 2/42
VSP 8400	All ports on the highest numbered operational slot in the chassis

Zero Touch Fabric configuration does not recognize channelized ports. For example, the 10 Gbps port must be connected to the 10 Gbps port on the other end to have Zero Touch Fabric configuration bring the port to operational UP state. If the FAN port is 40 Gbps and it connects to a 10 Gbps interface on the other end, you must channelize the 40-Gbps FAN port to 10 Gbps to bring the port to operational UP state.

If the FAN ports are on a slot that is not populated during startup, Zero Touch Fabric configuration is lost. You need to insert a module in the slot and reboot the switch.

Default IS-IS parameters

The Zero Touch Fabric configuration automatically configures the SPB and IS-IS infrastructure to enable Fabric Connect on a switch. The system initializes the following when the switch is started up in factory default fabric mode:

- Enable SPBM.
- Configure the SPBM Ethertype.
- Create an SPBM instance.
- Create an SPBM backbone VLAN and associate it to the SPBM instance.
- Create an SPBM secondary backbone VLAN and associate it to the SPBM instance.
- Configure the IS-IS system ID.
- Initializes the IS-IS manual area to 00.0000.0000.
- Assigns a nickname of 0.00.00.
- Configure the FAN ports admin state to UP.
- If not in nniMstp mode, remove the FAN ports from default VLAN 1.

- Create and enable the IS-IS interfaces on the FAN ports.
- Enable IS-IS globally.
- Enable CFM.

Parameter	Default value
Ethertype	0x8100
SPBM instance	1
Primary B-VLAN	4051
Secondary B-VLAN	4052
System ID value	Derived from the hardware chassis MAC
Manual area	Initialize to 00.0000.0000
Nickname	0.00.00

At this point, the IS-IS adjacencies are not yet established and the manual area and nickname are set to 0.

Establishing IS-IS adjacencies

When nodes are started up in the factory default fabric mode, the platform can enable IS-IS without a configured nickname or manual area. The Zero Touch Fabric configuration nodes listen for Hello PDUs on their NNI interfaces. Because the IS-IS manual area on the local node is NULL, it does not send Hello PDUs. As a result, if the SPB network consists of all defaulted nodes, the IS-IS adjacency is not created.

To create the IS-IS adjacencies, you must configure the IS-IS manual area on at least one SPBM node that is physically connected to the SPB network. This node is considered the seed node. The IS-IS manual area is derived from the IS-IS Hello PDU that originates from the seed node and then is dynamically learned by the other nodes. This learned area is referred to as the Dynamically Learned Area. The node uses the Dynamically Learned Area to send Hello PDUs on all active IS-IS interfaces and forms adjacencies if the IS-IS parameters match.

If you add a new node to a network where SPB is already configured and is connected by way of the FAN port to the node on its IS-IS interface, the adjacency with that node is established if the node uses the same default B-VLANs (4051 and 4052).

Fabric Area Network (FAN)

Fabric Area Network (FAN) provides a Layer 2 domain over which applications running on the SPB switches can communicate. It also provides a transit service for FAN traffic that originates on other switches. The SPB switches signal their interest in joining the FAN and the IS-IS SPF uses an internal reserved I-SID (16777001) to create a multicast domain for these switches to communicate with each other. The FAN requires no user configuration.

The Zero Touch Fabric configuration feature uses the FAN to dynamically learn nicknames. The seed node distributes this information to the newly added fabric nodes.

A node is a member of the FAN only if there are applications running on the node that require FAN transport. Dynamic Nickname Assignment server and client are currently the only applications that

require FAN transport. The FAN membership changes when the state changes for these applications. A node that is not a member of the FAN still acts as a BCB for the FAN (16777001) communication.

Zero Touch Fabric configuration and nicknames

When a node is started up in factory default fabric mode to enable Zero Touch Fabric configuration, the nickname is set to 0. Because the nickname is not yet configured, the node becomes a nickname client. The node joins the FAN and starts advertising FAN membership using TLV 147.

To deploy Dynamic Nickname Assignment, select a node and enable the nickname server on that node. When the nickname client detects that a nickname server exists in the network, the nickname client sends a request to the nickname server for a nickname. The nickname server assigns the nickname and the client node learns the nickname.

Important:

When a switch is operating without a nickname, the SPBM services do not function which may cause a disruption to the network. Only the FAN transport is operational. Make sure to have a nickname server active in the SPB network that is reachable from the nickname client by way of a path of SPB nodes that all support the FAN transport. Otherwise, the client is not able to reach the nickname server and get a nickname. When the client obtains a nickname from the server, the SPB services start.

If you do not want to use Dynamic Nickname Assignment, configure static nicknames on all of the nodes.

Dynamic Nickname Assignment

Dynamic Nickname Assignment is a service that provides unique nicknames to compatible switches across a Fabric Area Network (FAN).

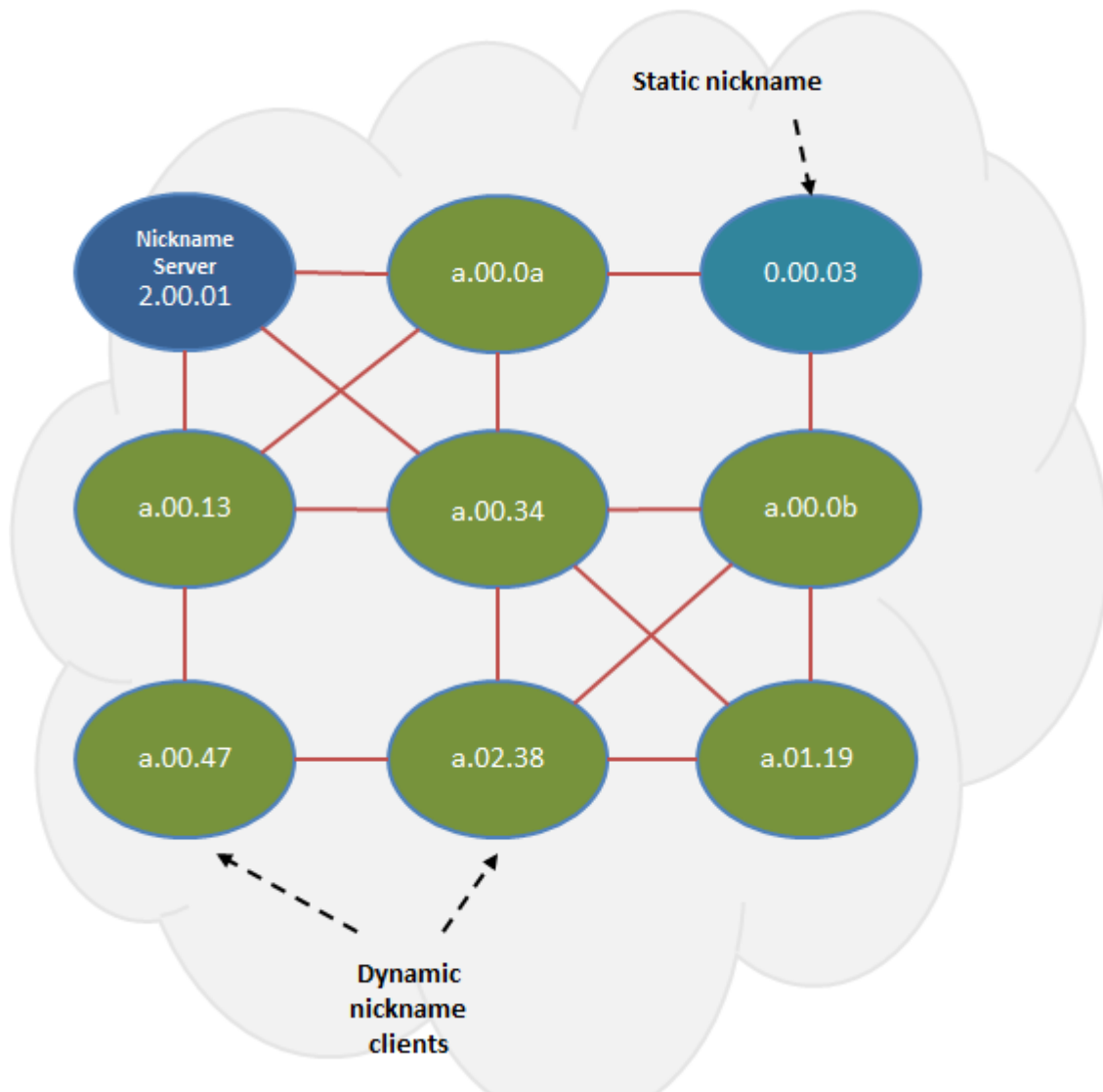

You can configure a node in a FAN as a nickname server. You must configure the nickname server with a static nickname from the nickname allocation range 0.00.01 - 9.FF.FF. The nickname server cannot be started until it is configured with a static nickname. It is recommended that a FAN contain at least two nickname servers to provide redundancy.

*** Note:**

The nickname allocation range A.00.00 to F.FF.FF is reserved for dynamic nicknames. If you configure a static nickname, it must be from the allocation range 0.00.01 - 9.FF.FF.

The nickname server interrogates FAN nodes that have been assigned a dynamic nickname to avoid nickname duplication.

A client joining the dynamic FAN in factory default mode initially does not have a nickname, and issues a broadcast soliciting a valid nickname assignment. The nickname server receives the

request and responds with a nickname assignment offer. The client then explicitly requests the particular nickname offered and the nickname server sends an acknowledgement.

The client maintains the nickname in persistent memory regardless of whether the active nickname server is the same server that originally provided the nickname. The client generates a trap and notifies the user if it is unable to receive a nickname from the server. When IS-IS starts up, it issues a trap if a client does not have a nickname and clears the trap when the client receives a nickname from the nickname server.

A client rebooting or reconnecting to the FAN requests the same nickname assignment it had before reboot. If the requested nickname is within the nickname server's configured range of nicknames and is still available, the server acknowledges the nickname. If the requested nickname is outside of the nickname server's configured range or if the nickname has been assigned to another client, the request is denied by the nickname server and the client must request a new nickname.

Static and dynamic nickname servers

You can use static nickname assignment and Dynamic Nickname Assignment in the same FAN.

It is recommended that you do not use nicknames in the dynamic nickname range if you are assigning nicknames statically. However, if there are existing nodes in the network with static nicknames in the dynamic nickname range, it is not a requirement to change their nickname assignment. If a node is assigned a dynamic nickname that is being used in the network, duplicate nickname protection is initiated. If the node that has the dynamic nickname loses the nickname election, it requests a different nickname from the nickname server. If a node with static nickname loses the nickname election, IS-IS is disabled on that node and you must manually re-assign the nickname and re-enable IS-IS.

To help prevent nickname duplication, nickname ranges are partitioned as follows:

- 0.00.01 - 9.FF.FF for static nickname assignment.
- A.00.00 - F.FF.FF for dynamic nickname assignment.

Nickname allocation ranges for Dynamic Nickname Assignment are as follows:

Range value	Range for nickname allocation
A	A.00.00 to A.FF.FF
B	B.00.00 to B.FF.FF
C	C.00.00 to C.FF.FF
D	D.00.00 to D.FF.FF
E	E.00.00 to E.FF.FF
F	F.00.00 to F.FF.FF

You can configure nicknames from a dynamic range if the nickname server is not started.

Note:

You must disable Dynamic Nickname Assignment before you can change the nickname allocation range.

Debugging

A node must be a member of a FAN to host Dynamic Nickname Assignment applications. FAN connectivity enables the exchange of information between nickname clients and servers, such as nickname requests or nickname assignments. You can use Connectivity Fault Management (CFM) to debug connectivity issues or isolate faults. For more information about CFM, see the *CFM fundamentals* chapter in *Troubleshooting*.

Dynamic Nickname Assignment considerations

Consider the following information when implementing this feature:

- You must configure a nickname server to attribute unique nicknames to clients based on established policies.
- You can configure multiple nickname servers in a FAN to provide resiliency. If you configure multiple nickname servers you must ensure that the ranges for nickname allocation do not overlap.
- Dynamic Nickname Assignment is not supported in a FAN that contains ERS4900 or ERS5900 products, or on VSP products running VOSS releases prior to 7.0.

MSTP-Fabric Connect Multi Homing

The MSTP-Fabric Connect Multi Homing feature allows MSTP or RSTP network to be multi-homed into a Fabric Connect network, providing a loop-free topology. MSTP-Fabric Connect Multi Homing enables an MSTP network to be multihomed into the SPB Fabric network through single node-to-multiple nodes or multiple nodes-to-multiple nodes.

! Important:

You must enable MSTP-Fabric Connect Multi Homing before you establish multihoming with an MSTP network.

* Note:

- MSTP-Fabric Connect Multi Homing uses I-SID 16777003. The switch creates this I-SID automatically and it cannot be modified.
- MSTP-Fabric Connect Multi Homing is supported on SPBM mode only.

SPBM and IS-IS infrastructure configuration using CLI

This section provides procedures to configure SPBM and IS-IS using Command Line Interface (CLI).

! Important:

The `spbm-config-mode` boot flag must be enabled (default) before you can configure SPBM or IS-IS. To verify the setting, enter `show boot config flags` in Privileged EXEC mode.

Running the SPBM script

Use the following procedure to run the SPBM script to automate the minimum required SPBM and IS-IS parameters to allow Fabric Connect to operate on the switch.

Before you begin

- Enable SPBM before running the SPBM script.
- Delete existing IS-IS interfaces before running this script. See [Removing specific IS-IS and MLT interfaces](#) on page 82 for information on removing IS-IS interfaces.

About this task

You can use this procedure to quickly configure the minimum SPBM and IS-IS parameters. However, a manual procedure is available instead of using this script. The default values are given in square brackets. You may input your values at the prompt or if you wish to accept the default values, press `Enter`. This command first accepts all values and then removes existing SPBM configurations before configuring the entered values.

* Note:

This process causes the SPBM traffic to flap temporarily.

Procedure

1. Enter Global Configuration mode:

```
enable
configure terminal
```

2. Run the SPBM script:

```
run spbm
```

* Note:

If the script causes a configuration conflict or cannot execute a command, an error message displays and the script stops.

Example

Run the SPBM script:

```
Switch:1(config)# run spbm
```

```
*****
*** This script will guide you through configuring the          ***
*** switch for optimal operation SPB.                          ***
*** -----                                                  ***
*** The values in [] are the default values, you can           ***
*** input alternative values at any of the prompts.            ***
*** If you wish to terminate or exit this script              ***
*** enter ^C <control-C> at any prompt.                        ***
*** NOTE: THE COMMAND WILL TEMPORARILY FLAP IS-IS,SPBM        ***
*****
SPB Ethertype <0x8100,0x88a8> [0x8100]:
SPB primary BVLAN 2-4059 [4051]:300
```

SPBM and IS-IS infrastructure configuration

```
SPB secondary BVLAN 2-4059 [4052]:400
ISIS system id <xxxx.xxxx.xxxx> [a051.c6eb.7c65]:0200.0000.0100
SPB nickname <x.xx.xx> [b.7c.65]:0.02.02
SPB Manual Area <xx.xxxx.xxxx...xxxx> [49.0000]:50
ISIS System Name [Switch]:BEB1
Enable SPBM multicast (y/n) [n]:y
Enable IP shortcuts (y/n) [n]:y
Loopback interface ID <1-256> [1]:1
Loopback interface IP and subnet <a.b.c.d/x>:20.1.1.1/24
Configure SPBM SMLT? (y/n) [n]:y
Peer system id <xxxx.xxxx.xxxx>:0200.0000.0200
SMLT virtual BMAC <0x00:0x00:0x00:0x00:0x00:0x00>:02:00:00:10:00:10
ISIS MLT interface <MLT ID LIST>[:]:1
Enable CFM SPBM (y/n) [n]:y
Enter CFM SPBM MEPID <1-8191> [1]:2
Enter CFM SPBM level <0-7> [4]:4

****CONFIGURATION IN PROGRESS****
*SPBM enabled globally*
*SPBM instance 1 configured*
*SPBM BVLANS configured*
*SPBM SMLT configured*
*SPBM multicast enabled globally*
*IP shortcuts configured*
*SPBM SMLT configured*
*IS-IS enabled*
*IS-IS on port 1/5 configured*
*IS-IS on port 1/6 configured*
*IS-IS on MLT 1 configured*
*CFM SPBM configured*
****SCRIPT EXECUTION COMPLETE****
```

Removing existing SPBM configuration

Use the following procedure to remove existing SPBM configurations, disable CFM, and return the CFM MEP-ID and level configurations to default values.

Before you begin

Enable SPBM before running this script.

Procedure

1. Enter Global Configuration mode:

```
enable
configure terminal
```

2. Run the script:

```
run spbm clean
```

Note:

If the script causes a configuration conflict or cannot execute a command, an error message appears and the script stops.

Example

Run the script:

```
Switch:1(config)#run spbm clean
The following will delete all SPBM and interfaces and default the CFM configurations. Do
you want to continue? <y/n>[n]:y

Switch:1(config)#no router isis enable
Switch:1(config)#interface gigabitethernet 1/10
Switch:1(config-if)#no isis
Switch:1(config-if)#interface gigabitethernet 1/11
Switch:1(config-if)#no isis
Switch:1(config-if)#configure terminal
Enter configuration commands, one per line.  End with CNTL/Z.
Switch:1(config)#no vlan 4051
Switch:1(config)#no vlan 4052
Switch:1(config)#router isis
Switch:1(config-isis)#no spbm 1
Switch:1(config-isis)#router isis
Switch:1(config-isis)#no ip-source-address
Switch:1(config-isis)#no system-id
Switch:1(config-isis)#no manual-area 49.0000
Switch:1(config-isis)#no cfm spbm enable
Switch:1(config)#cfm spbm level 4
Switch:1(config)#cfm spbm mepid 1
Switch:1(config)#configure terminal
Enter configuration commands, one per line.  End with CNTL/Z.
Switch:1(config)#

**SPBM configurations have been removed**
```

Configuring the IS-IS port interfaces using SPBM script

Use the following procedure to run the SPBM script to configure the IS-IS port interfaces. As this command does not flap IS-IS or SPBM, it is particularly effective to use this command when SPBM is already configured and you require to configure additional ports or MLTs. Running the run spbm interface command does not alter existing IS-IS or SPBM configurations.

About this task

You can use this procedure to quickly configure the minimum SPBM and IS-IS parameters. However, a manual procedure is available instead of using this script.

Note:

You must enable SPBM before running the SPBM script.

Procedure

1. Enter Global Configuration mode:

```
enable
configure terminal
```

2. Run the SPBM script:

```
run spbm interface
```

*** Note:**

If the script causes a configuration conflict or cannot execute a command, an error message displays and the script stops.

Example

Run the SPBM script:

```
Switch:1(config)# run spbm interface
*****
*** This script will guide you through configuring the          ***
*** switch for optimal operation SPB.                          ***
*** -----                                                  ***
*** The values in [] are the default values, you can          ***
*** input alternative values at any of the prompts.           ***
*** If you wish to terminate or exit this script              ***
*** enter ^C <control-C> at any prompt.                        ***
*****
ISIS port interfaces <a/b,c/d> []:1/2,1/4,1/8
ISIS MLT interface <MLT ID LIST> []:1
*IS-IS on port 1/2 configured*
*IS-IS on port 1/4 configured*
*IS-IS on port 1/8 configured*
*IS-IS on MLT-1 configured*
```

Removing specific IS-IS and MLT interfaces

Use the following procedure to remove specific IS-IS ports and MLT interfaces when you get the error IS-IS SPBM interfaces have been configured. Please delete these interfaces.

About this task

This procedure removes existing IS-IS ports and MLT interfaces. You can choose which port and MLT interfaces need to be removed. This command does not alter the other SPBM or IS-IS configurations.

*** Note:**

You must enable SPBM before running the SPBM script.

Procedure

1. Enter Global Configuration mode:

```
enable
configure terminal
```
2. Run the script:

```
run spbm interface clean
```

*** Note:**

If the script causes a configuration conflict or cannot execute a command, an error message displays and the script stops.

Example

Run the spbm interface clean script:

```
Switch:1(config)# run spbm interface clean
```

```
*****
*** This script will guide you through deleting the          ***
*** IS-IS SPBM interfaces.                                  ***
*** -----                                                ***
*** The values in [] are the default values.                ***
*** If you wish to terminate or exit this script           ***
*** enter ^C <control-C> at any prompt.                    ***
*****
ISIS port interfaces to be deleted <a/b,c/d>[:1/2,1/4,1/8
ISIS MLT interface <MLT ID LIST> [:1
IS-IS port 1/2 deleted
IS-IS port 1/4 deleted
IS-IS port 1/8 deleted
** 3 IS-IS port interfaces deleted **
MLT 1 deleted
** 1 IS-IS MLTs deleted **
```

Configuring minimum SPBM and IS-IS parameters

Use the following procedure to configure the minimum required SPBM and IS-IS parameters to allow SPBM to operate on the switch.

Procedure

1. Enter Global Configuration mode:

```
enable
configure terminal
```

2. Enable SPBM globally:

```
spbm
```

3. Enter IS-IS Router Configuration mode:

```
router isis
```

4. Create the SPBM instance (only one SPBM instance is supported):

```
spbm <1-100>
```

5. Add the SPBM B-VLAN to the SPBM instance:

```
spbm <1-100> b-vid {<vlan-id [-vlan-id][, ...]} [primary <1-4059>]
```

6. Configure the system nickname (2.5 bytes in the format <x.xx.xx>):

```
spbm <1-100> nick-name <x.xx.xx>
```

*** Note:**

Although it is not strictly required for SPBM operation, you should change the IS-IS system ID from the default B-MAC value to a recognizable address to easily identify a switch (Log on to IS-IS Router configuration mode and use the `system-id <xxxx.xxxx.xxxx>` command). This helps to recognize source and destination addresses for troubleshooting purposes.

7. Configure an IS-IS manual area (1-13 bytes in the format <xx.xxxx.xxxx...xxxx>. Only one manual area is supported.):

```
manual-area <xx.xxxx.xxxx...xxxx>
```

8. Exit IS-IS Router Configuration mode to Global Configuration mode:

```
exit
```

9. Create the SPBM backbone VLAN (B-VLAN):

```
vlan create <2-4059> type spbm-bvlan
```

10. Enter Interface Configuration mode, by specifying the ports or MLTs that are going to link to the SPBM network:

```
interface {GigabitEthernet {slot/port[/sub-port] [-slot/port[/sub-port]] [,...]} | mlt <1-512> }
```

11. Configure an IS-IS interface on the selected ports or MLTs:

- a. Create an IS-IS circuit and interface on the selected ports or MLTs:

```
isis
```

- b. Enable the SPBM instance on the IS-IS interfaces:

```
isis spbm <1-100>
```

- c. Enable the IS-IS circuit/interface on the selected ports or MLTs:

```
isis enable
```

12. Enable interface.

13. Exit Interface Configuration mode:

```
exit
```

14. Enable IS-IS globally:

```
router isis enable
```

15. Display the SPBM configurations:

```
show isis spbm
```

16. Display the global IS-IS configuration:

```
show isis
```

17. Display the interface IS-IS configuration:

```
show isis interface
```

Example

```
Switch> enable
Switch# configure terminal
Switch(config)# spbm
Switch(config)# router isis
Switch(config-isis)# spbm 1
Switch(config-isis)# spbm 1 b-vid 4051,4052 primary 10
Switch(config-isis)# spbm 1 nick-name 1.11.16
Switch(config-isis)# manual-area c0.2000.000.00
Switch(config-isis)# exit
Switch(config)# interface GigabitEthernet 1/21
Switch(config-if)# isis
Switch(config-if)# isis spbm 1
Switch(config-if)# isis enable
Switch(config-if)# exit
Switch(config)# vlan create 4051 type spbm-vlan
Switch(config)# vlan create 4052 type spbm-vlan
Switch(config)# router isis enable
Switch(config)# show isis spbm
```

```
Switch:1(config)#show isis spbm
```

```
=====
ISIS SPBM Info
=====
SPBM      B-VID      PRIMARY   NICK      LSDB      IP        IPV6      MULTICAST  SPB-PIM-GW  STP-MULTI
INSTANCE  INSTANCES  VLAN     NAME     TRAP      disable  disable  disable  enable  disable  enable
-----
1         4051-4052  4051     1.11.16  disable  disable  disable  enable  disable  disable  enable
=====
ISIS SPBM SMLT Info
=====
SPBM      SMLT-SPLIT-BEB      SMLT-VIRTUAL-BMAC      SMLT-PEER-SYSTEM-ID
INSTANCE
-----
1         primary              00:00:00:00:00:00
=====
Total Num of SPBM instances: 1
=====
```

```
Switch(config)# show isis
```

```
=====
ISIS General Info
=====
```

```

AdminState : enabled
RouterType : Level 1
System ID : 0014.c7e1.33df
Max LSP Gen Interval : 900
Metric : wide
Overload-on-startup : 20
Overload : false
Csnp Interval : 10
PSNP Interval : 2
Rxmt LSP Interval : 5
spf-delay : 100
Router Name : Switch1
ip source-address : 41.41.41.100
ipv6 source-address : 41:0:0:0:0:0:100
ip tunnel source-address : 11.11.12.11
Tunnel vrf : spboip
ONA Port : 1/15
ip tunnel mtu : 1950
Num of Interfaces : 2
Num of Area Addresses : 1
inband-mgmt-ip :
backbone : disabled
Dynamically Learned Area : 00.0000.0000
FAN Member : No
    
```

*** Note:**

The ONA Port : 1/15 parameter in the preceding example is applicable only to the Virtual Services Platform 4000 Series.

Switch(config)# show isis interface

Switch# show isis interface

```

=====
ISIS Interfaces
=====
IFIDX      TYPE      LEVEL    OP-STATE  ADM-STATE  ADJ    UP-ADJ    SPBM-L1-METRIC
-----
Mlt2       pt-pt    Level 1  UP        UP          1      1         10
Port1/21   pt-pt    Level 1  UP        UP          1      1         10
    
```

Variable definitions

Use the data in the following table to use the `isis` command.

Variable	Value
enable	Enables or disables the IS-IS circuit/interface on the specified port or MLT. The default is disabled. Use the no option to disable IS-IS on the specified interface.
spbm <1-100>	Enable the SPBM instance on the IS-IS interfaces.

Use the data in the following table to use the `manual-area` command.

Variable	Value
<xx.xxx.xxx...xxx>	Specifies the IS-IS manual-area (1-13 bytes in the format <xx.xxx.xxx...xxx>). Only one manual area is

Variable	Value
	supported. For IS-IS to operate, you must configure at least one area. Use the no option to delete the manual area.

Use the data in the following table to use the **spbm** command.

Variable	Value
<1-100>	Creates the SPBM instance. Only one SPBM instance is supported.
b-vid {<vlan-id [-vlan-id] [,...]}	Sets the IS-IS SPBM instance data VLANs. Use the no option to remove the specified B-VLAN from the SPBM instance.
nick-name <x.xx.xx>	Specifies a nickname for the SPBM instance globally. The value is 2.5 bytes in the format <x.xx.xx>. Use the no or default options to delete the configured nickname.
primary <1-4059>	Sets the IS-IS instance primary data B-VLAN.

Use the data in the following table to use the **vlan create** command.

Variable	Value
<2-4059>	Specifies the VLAN ID. Creates an SPBM Backbone VLAN (B-VLAN). You can optionally specify a name for the SPBM B-VLAN.
type {port-mstprstp protocol-mstprstp spbm-bvlan}	Specifies the type of VLAN created. <ul style="list-style-type: none"> port-mstprstp — Create a VLAN by port. protocol-mstprstp — Create a VLAN by protocol. spbm-bvlan — Create an SPBM-BVLAN.

Job aid

Important:

After you have configured the SPBM nickname and enabled IS-IS. To maintain the same nickname with a different system ID, perform the following steps:

1. Disable IS-IS.
2. Change the system ID.
3. Change the nickname to a temporary one.
4. Enable IS-IS.
5. Wait up to 20 minutes for the LSPs with the original system ID to age out.

*** Note:**

To check the age out time, use the `show isis lsdb sysid <original-sys-id>` command on any of the other SPB nodes in the network. When there is no output from this command, proceed to the next step. The time left (in seconds) for the LSPs to age out is shown under the column LIFETIME.

6. Disable IS-IS.
7. Change the nickname to the original nickname.
8. Enable IS-IS.

Configuring minimum SPBM and IS-IS parameters using auto-nni command

Use the following procedure to configure the minimum required SPBM and IS-IS parameters using the `auto-nni` command to have the node create an IS-IS interface, attach the interface to an SPBM instance, and then enable IS-IS on the port interface.

This procedure is only for the port interface. The `auto-nni` command is not supported on the MLT interface and the Fabric Extend Logical Interface.

About this task

The `auto-nni` command provides a quick and simple way to configure the IS-IS interface. You can use the `auto-nni` command instead of the following existing IS-IS commands on the physical (port) interface:

- `isis`
- `isis spbm instance`
- `isis enable`

The existing commands are still available and you have the option to use the new command or the three existing commands. If you need to modify any of the default parameters under `isis` or `isis spbm instance`, use `isis` and `isis spbm instance` constructs even if you created the interface with the `auto-nni` command.

Procedure

1. Enter Global Configuration mode:

```
enable
configure terminal
```
2. Enable SPBM globally:

```
spbm
```
3. Enter IS-IS Router Configuration mode:

```
router isis
```

4. Create the SPBM instance (only one SPBM instance is supported):

```
spbm <1-100>
```

5. Add the SPBM B-VLAN to the SPBM instance:

```
spbm <1-100> b-vid {<vlan-id [-vlan-id][, ...]} [primary <1-4059>]
```

6. Configure the system nickname (2.5 bytes in the format <x.xx.xx>):

```
spbm <1-100> nick-name <x.xx.xx>
```

*** Note:**

Although it is not strictly required for SPBM operation, you should change the IS-IS system ID from the default B-MAC value to a recognizable address to easily identify a switch (Log on to IS-IS Router configuration mode and use the `system-id <xxxx.xxxx.xxxx>` command). This helps to recognize source and destination addresses for troubleshooting purposes.

7. Configure an IS-IS manual area (1-13 bytes in the format <xx.xxxx.xxxx...xxx>. Only one manual area is supported.):

```
manual-area <xx.xxxx.xxxx...xxx>
```

8. Exit IS-IS Router Configuration mode to Global Configuration mode:

```
exit
```

9. Create the SPBM backbone VLAN (B-VLAN):

```
vlan create <2-4059> type spbm-bvlan
```

10. Enter Interface Configuration mode, by specifying the ports or MLTs that are going to link to the SPBM network:

```
interface {GigabitEthernet {slot/port[/sub-port] [-slot/port[/sub-port]] [, ...]} | mlt <1-512> }
```

11. Configure an IS-IS interface on the selected ports.

```
auto-nni
```

12. Enable interface.

13. Exit Interface Configuration mode:

```
exit
```

14. Enable IS-IS globally:

```
router isis enable
```

15. Display the SPBM configurations:

```
show isis spbm
```

16. Display the global IS-IS configuration:

```
show isis
```

17. Display the interface IS-IS configuration:

```
show isis interface
```

Example

```
Switch> enable
Switch# configure terminal
Switch(config)# spbm
Switch(config)# router isis
Switch(config-isis)# spbm 1
Switch(config-isis)# spbm 1 b-vid 10,20 primary 10
Switch(config-isis)# spbm 1 nick-name 1.11.16
Switch(config-isis)# manual-area c0.2000.000.00
Switch(config-isis)# exit
Switch(config)# interface GigabitEthernet 1/21
Switch(config-if)# auto-nni
Switch(config-if)# exit
Switch(config)# vlan create 10 type spbm-vlan
Switch(config)# vlan create 20 type spbm-vlan
Switch(config)# router isis enable
Switch(config)# show isis spbm
```

```
Switch:1(config)#show isis spbm
=====
ISIS SPBM Info
=====
SPBM      B-VID      PRIMARY    NICK      LSDB      IP      IPV6      MULTICAST  SPB-PIM-GW  STP-MULTI
INSTANCE  B-VID      VLAN      NAME      TRAP      TRAP      TRAP      TRAP      TRAP      HOMING
-----
1         4051-4052  4051      1.11.16   disable   disable  disable   enable     disable     enable
-----
ISIS SPBM SMLT Info
=====
SPBM      SMLT-SPLIT-BEB      SMLT-VIRTUAL-BMAC      SMLT-PEER-SYSTEM-ID
INSTANCE
-----
1         primary              00:00:00:00:00:00
-----
Total Num of SPBM instances: 1
=====
```

```
Switch(config)# show isis
```

```
=====
ISIS General Info
=====
AdminState : enabled
RouterType : Level 1
System ID  : 0014.c7e1.33df
Max LSP Gen Interval : 900
=====
```

```

Metric : wide
Overload-on-startup : 20
Overload : false
Csnp Interval : 10
PSNP Interval : 2
Rxmt LSP Interval : 5
spf-delay : 100
Router Name : Switch1
ip source-address : 41.41.41.100
ipv6 source-address : 41:0:0:0:0:0:0:100
ip tunnel source-address : 11.11.12.11
Tunnel vrf : spboip
ONA Port : 1/15
ip tunnel mtu : 1950
Num of Interfaces : 2
Num of Area Addresses : 1
inband-mgmt-ip :
backbone : disabled
Dynamically Learned Area : 00.0000.0000
FAN Member : No

```

*** Note:**

The ONA Port : 1/15 parameter in the preceding example is applicable only to the Virtual Services Platform 4000 Series.

```
Switch(config)# show isis interface
```

```
Switch# show isis interface
```

```

=====
ISIS Interfaces
=====
IFIDX      TYPE      LEVEL      OP-STATE  ADM-STATE  ADJ      UP-ADJ      SPBM-L1-METRIC
-----
Mlt2       pt-pt     Level 1     UP        UP          1        1          10
Port1/21   pt-pt     Level 1     UP        UP          1        1          10

```

Configuring I-SIDs for private VLANs

Before you begin

- A private VLAN must be created. For more information about creating private VLANs, see *Configuring VLANs, Spanning Tree, and NLB*.

About this task

There is one I-SID per private VLAN.

Procedure

1. Enter Global Configuration mode:

```
enable
```

```
configure terminal
```

2. Assign the I-SID to the primary and secondary VLAN.

```
vlan i-sid <1-4059> <0-16777215>
```

Example

```
Switch:1> enable
Switch:1# configure terminal
Switch:1(config)# vlan i-sid 5 75
```

Display private VLAN I-SID assignment:

```
Switch:1(config)# show vlan private-vlan
```

```
=====
PRIVATE VLAN
=====
Primary      Primary      Secondary     Secondary
VLAN         ISID         VLAN          ISID
-----
5            75          6            75
```

Variable definitions

Use the data in the following table to use the `vlan i-sid` command.

Variable	Value
<1-4059>	Primary VLAN ID. Specifies the VLAN ID in the range of 1 to 4059. By default, VLAN IDs 1 to 4059 are configurable and the system reserves VLAN IDs 4060 to 4094 for internal use. On switches that support the vrf-scaling and spbm-config-mode boot configuration flags, if you enable these flags, the system also reserves VLAN IDs 3500 to 3998. VLAN ID 1 is the default VLAN and you cannot create or delete VLAN ID 1.
<0-16777215>	I-SID value, this value is same for primary and secondary VLANs.

Displaying global SPBM parameters

Use the following procedure to verify the proper global SPBM configuration.

Procedure

1. Display the SPBM configuration:

```
show isis spbm
```

2. You can also use the following command to identify SPBM VLANs. For `spbm-bvlan`, the attribute `TYPE` displays `spbm-bvlan` instead of `byport`. For private VLANs, the attribute `TYPE` displays `private` instead of `byport`.

```
show vlan basic
```

Example

```
Switch# show isis spbm
```

```

=====
                        ISIS SPBM Info
=====
SPBM      B-VID      PRIMARY  NICK     LSDB     IP       IPV6     MULTICAST  SPB-PIM-GW  STP-MULTI
INSTANCE  ID              VLAN     NAME     TRAP     IP       IPv6     MCAST     PIM-GW      HOMING
-----
1         4051-4052      4051                    disable  disable  disable  enable     disable     enable
=====
                        ISIS SPBM SMLT Info
=====
SPBM      SMLT-SPLIT-BEB  SMLT-VIRTUAL-BMAC  SMLT-PEER-SYSTEM-ID
INSTANCE
-----
1         primary                00:00:00:00:00:00
=====
Total Num of SPBM instances: 1
=====

```

Switch# show vlan basic

```

=====
                        Vlan Basic
=====
VLAN      INST
ID        NAME          TYPE          ID  PROTOCOLID  SUBNETADDR      SUBNETMASK      VRFLD
-----
1         Default        byPort        0   none        N/A             N/A             0
10        VLAN-10        spbm-bvlan    62  none        N/A             N/A             0
20        VLAN-20        spbm-bvlan    62  none        N/A             N/A             0
100       VLAN-100       byPort        0   none        N/A             N/A             0
All 5 out of 5 Total Num of Vlans displayed

```

Job aid

The following table describes the fields in the output for the **show isis spbm** command.

Parameter	Description
SPBM INSTANCE	Indicates the SPBM instance identifier. You can only create one SPBM instance.
B-VID	Indicates the SPBM B-VLAN associated with the SPBM instance.
PRIMARY VLAN	Indicates the primary SPBM B-VLAN.
NICK NAME	Indicates the SPBM node nickname. The nickname is used to calculate the I-SID multicast MAC address.
LSDB TRAP	Indicates the status of the IS-IS SPBM LSDB update trap on this SPBM instance. The default is disable.
IP	Indicates the status of SPBM IP shortcuts on this SPBM instance. The default is disable.
IPv6	Indicates the status of SPBM IPv6 shortcuts on this SPBM instance. The default is disable.
MULTICAST	Indicates if SPBM multicast is enabled. The default is disabled.
SPB-PIM-GW	Indicates if SPB PIM Gateway is enabled. The default is disabled.
STP-MULTI HOMING	Indicates if MSTP-Fabric Connect Multi Homing is enabled. The default is disabled.
SMLT-SPLIT-BEB	Specifies whether the switch is the primary or secondary vIST peer.
SMLT-VIRTUAL-BMAC	Specifies a virtual MAC address that can be used by both peers.
SMLT-PEER-SYSTEM-ID	Specifies the vIST peer system ID.

Displaying global IS-IS parameters

Use the following procedure to display the global IS-IS parameters.

Procedure

1. Display IS-IS configuration information:

```
show isis
```

2. Display the IS-IS system-id:

```
show isis system-id
```

3. Display IS-IS net info:

```
show isis net
```

Example

```
Switch# show isis
=====
                        ISIS General Info
=====
                        AdminState : enabled
                        RouterType  : Level 1
                        System ID   : 0014.c7e1.33df
Max LSP Gen Interval : 900
                        Metric     : wide
Overload-on-startup  : 20
                        Overload    : false
Csnp Interval       : 10
PSNP Interval       : 2
Rxmt LSP Interval   : 5
                        spf-delay  : 100
Router Name         : Switch1
ip source-address   : 192.0.2.0
ipv6 source-address : 41:0:0:0:0:0:100
ip tunnel source-address : 192.0.2.10
                        Tunnel vrf : spboip
                        ONA Port   : 1/15
ip tunnel mtu       : 1950
Num of Interfaces   : 2
Num of Area Addresses : 1
inband-mgmt-ip      :
                        backbone   : disabled
Dynamically Learned Area : 00.0000.0000
FAN Member          : No
```

* Note:

The ONA Port : 1/15 parameter in the preceding example is applicable only to the Virtual Services Platform 4000 Series.

* Note:

```
Switch# show isis system-id
=====
                        ISIS System-Id
```

```

=====
SYSTEM-ID
-----
0014.c7e1.33df

Switch# show isis net
=====
                        ISIS Net Info
=====
NET
-----
c0.2000.0000.0000.14c7.e133.df00

```

Job aid



The following sections describe the fields in the outputs for the global IS-IS show commands.

show isis

The following table describes the fields in the output for the **show isis** command.

Parameter	Description
AdminState	Indicates the administrative state of the router.
RouterType	Indicates the router Level: L1, L2, or L1/2.
System ID	Indicates the system ID.
Max LSP Gen Interval	Indicates the maximum time between LSP updates in seconds.
Metric	Indicates if the metric is narrow or wide.
Overload-on-startup	Indicates the IS-IS overload-on-startup value in seconds. The overload-onstartup value is used as a timer to control when to send out Link State Packets (LSPs) with the overload bit cleared after IS-IS startup. The default value is 20 seconds.
Overload	Indicates if there is an overload condition.
Csnp Interval	Indicates the interval between CSNP updates in seconds.
PSNP Interval	Indicates the interval between PSNP updates in seconds.
Rxmt LSP Interval	Indicates the received LSP time interval.
spf-delay	Indicates an SPF delay in milliseconds. The default value is 100 milliseconds.
Router Name	Indicates the IS-IS name of the router.
ip source-address	Indicates the IP source address used for SPBM IP shortcuts.
ipv6 source-address	Indicates the IPv6 source address used for SPBM IP shortcuts.
ip tunnel source-address	Indicates the IP tunnel source address used for SPBM Fabric Extend.
Tunnel vrf	Indicates the name of the vrf that contains the tunnel endpoints.
ONA Port	Indicates the port to which the ONA device is attached.

Table continues...

Parameter	Description
	<p> Note: The ONA port parameter is applicable only to the Virtual Services Platform 4000 Series.</p> <p> Note:</p>
ip tunnel mtu	Indicates the maximum size of a packet that can be transmitted through the IP tunnel.
Num of Interfaces	Indicates the number of interfaces on the router.
Num of Area Addresses	Indicates the number of area addresses on the router.
Num of Summary Address	Indicates the summary of the addresses on router.
inband-mgmt-ip	Indicates the DvR management IP address for this node, in the DvR domain.
backbone	Indicates whether this node is part of the DvR backbone.
Dynamically Learned Area	For Fabric Area Network (FAN) members, specifies the IS-IS area that is dynamically learned from the neighbor's Hello PDU if the node does not have the IS-IS manual area configured.
FAN Member	Indicates whether the node is a member of the FAN.

show isis system-id

The following table describes the fields in the output for the `show isis system-id` command.

Parameter	Description
SYSTEM-ID	Shows the system ID. Output from this show command is from the global IS-IS configuration of the system ID. There is one system ID configured. The system ID is 6 bytes in length.

show isis net

The following table describes the fields in the output for the `show isis net` command.

Parameter	Description
NET	Shows the NET address. Output from this command is from the global IS-IS configuration of the manual area and the configuration of the system ID. There is only one manual areas defined and only one system ID. The manual area is from 1-13 bytes in length. The system ID is 6 bytes in length.

Displaying IS-IS areas

Use the following procedure to display IS-IS areas.

Procedure

Use the following procedure to display IS-IS areas.

```
show isis manual-area
```

Example

```
Switch# show isis manual-area
```

```

=====
                        ISIS Manual Area Address
=====
AREA ADDRESS
-----
c0.2000.0000.00

```

Job aid

The following table describes the fields in the output for the `show isis manual-area` command.

Parameter	Description
AREA ADDRESS	Shows the manual areas defined. There can only be one area. Use the same manual area across the entire SPBM cloud. The manual area can be from 1-13 bytes in length.

Configuring SMLT parameters for SPBM

Use the following procedure to configure the required Split MultiLink Trunking (SMLT) parameters to allow SPBM to interoperate with SMLT on the switch.

* Note:

- The assignment of primary and secondary roles to the vIST peers is automatic. The switch with the lower system ID (between the two vIST peers) is primary, and the switch with the higher system ID is secondary when default system-id values are being used.
- SMLT peer system ID is part of the required configuration. You must configure the SMLT peer system ID as the nodal MAC of the peer device. In the IS-IS network, the nodal MAC of devices should be eight apart from each other.
- When using the default hardware assigned system-id value, the SMLT Virtual BMAC is automatically derived by comparing the system-id values of the two vIST peers. A value of 0x01 plus the lower of the two system-id values is used as the SMLT Virtual BMAC.

When using a manually configured system-id value, the SMLT Virtual BMAC must also be manually configured.

- An I-SID must be assigned to every VLAN that is a member of a Layer 2 VSN. Also, if a Layer 2 VSN is created on one vIST Peer, it must also be created on the other vIST peer.

Procedure

1. Enter Global Configuration mode:

```
enable
```

SPBM and IS-IS infrastructure configuration

- ```
configure terminal
```
2. Disable IS-IS on the switch:

```
no router isis enable
```
  3. Enter IS-IS Router Configuration mode:

```
enable
```

```
configure terminal
```

```
router isis
```
  4. Specify the system ID of the vIST peer, so that if it goes down, the local peer can take over forwarding for the failed peer:

```
spbm <1-100> smlt-peer-system-id <xxxx.xxxx.xxxx>
```
  5. Configure the virtual B-MAC, which is shared and advertised by both peers:

```
spbm <1-100> smlt-virtual-bmac <0x00:0x00:0x00:0x00:0x00:0x00>
```
  6. Exit to Global Configuration mode:

```
exit
```
  7. Enable IS-IS on the switch:

```
router isis enable
```
  8. Display the SPBM SMLT configuration:

```
show isis spbm
```

### Example

```
Switch:1>enable
Switch:1#configure terminal
```

#### Disable IS-IS on the switch:

```
Switch:1(config)#no router isis enable
```

#### Enter the IS-IS Router Configuration mode:

```
Switch:1(config)#router isis
Switch:1(config-isis)#spbm 1 smlt-peer-system-id 0018.b0bb.b3df
Switch:1(config-isis)#spbm 1 smlt-virtual-bmac 00:14:c7:e1:33:e0
Switch:1(config-isis)#router isis enable
```

```
Switch:1(config-isis)#show isis spbm
```

```
=====
```

| ISIS SPBM Info   |           |                 |              |              |         |         |           |            |                     |
|------------------|-----------|-----------------|--------------|--------------|---------|---------|-----------|------------|---------------------|
| SPBM<br>INSTANCE | B-VID     | PRIMARY<br>VLAN | NICK<br>NAME | LSDB<br>TRAP | IP      | IPV6    | MULTICAST | SPB-PIM-GW | STP-MULTI<br>HOMING |
| 1                | 4051-4052 | 4051            |              | disable      | disable | disable | enable    | disable    | enable              |

```
=====
```

| ISIS SPBM SMLT Info |                |                   |                     |
|---------------------|----------------|-------------------|---------------------|
| SPBM<br>INSTANCE    | SMLT-SPLIT-BEB | SMLT-VIRTUAL-BMAC | SMLT-PEER-SYSTEM-ID |
| 1                   | primary        | 00:00:00:00:00:00 |                     |

```
=====
```

Total Num of SPBM instances: 1

-----

## Variable definitions

Use the data in the following table to use the `spbm` command.

| Variable                                                             | Value                                                                                                                                                                                                                                                                                                                                                                                                                                                                                                                                                                                                                                                                                                                                         |
|----------------------------------------------------------------------|-----------------------------------------------------------------------------------------------------------------------------------------------------------------------------------------------------------------------------------------------------------------------------------------------------------------------------------------------------------------------------------------------------------------------------------------------------------------------------------------------------------------------------------------------------------------------------------------------------------------------------------------------------------------------------------------------------------------------------------------------|
| <code>smlt-peer-system-id &lt;xxxx.xxxx.xxxx&gt;</code>              | <p>Specifies the IS-IS SPBM peer system ID.</p> <p>SMLT peer system ID is part of the required configuration. You must configure the SMLT peer system ID as the nodal MAC of the peer device. In the IS-IS network, the nodal MAC of devices should be eight apart from each other.</p>                                                                                                                                                                                                                                                                                                                                                                                                                                                       |
| <code>smlt-virtual-bmac &lt;0x00:0x00:0x00:0x00:0x00:0x00&gt;</code> | <p>Specifies a virtual MAC address that can be used by both peers. SMLT virtual B-MAC is an optional configuration.</p> <p><b>* Note:</b></p> <ul style="list-style-type: none"> <li>If SMLT virtual B-MAC is not configured, the system derives SMLT virtual B-MAC from the configured SMLT peer system ID and the nodal MAC of the device (IS-IS system ID). The system compares the nodal MAC of the device with the SMLT peer system ID configured and takes the small one, plus 0x01, as the SMLT virtual B-MAC.</li> <li>The system also derives SMLT split BEB from the SMLT peer system ID and nodal MAC of the device. The device with the lower system ID is primary, the device with the higher system ID is secondary.</li> </ul> |

## Configuring optional SPBM parameters

Use the following procedure to configure optional SPBM parameters.

### Procedure

- Enter Global Configuration mode:
 

```
enable
configure terminal
```
- Configure the SPBM ethertype:
 

```
spbm ethertype {0x8100 | 0x88a8}
```
- Configure the optional link-state database (LSDB) trap global parameter. To configure this parameter, you must globally disable IS-IS on the switch:
  - Disable IS-IS on the switch:

- ```
no router isis enable
```
- b. Enter IS-IS Router Configuration mode:

```
router isis
```
 - c. Enable a trap when the SPBM LSDB changes:

```
spbm <1-100> lsdb-trap enable
```
 - d. Enable IS-IS on the switch:

```
router isis enable
```
 - e. Exit IS-IS Router Configuration mode:

```
exit
```
4. Configure the optional SPBM interface parameters. To configure these parameters, you must disable IS-IS on the interface:
- a. Specify an SPBM interface to configure:

```
interface {GigabitEthernet {slot/port[/sub-port] [-slot/port[/sub-port]][,...]} | mlt <mltid> }
```
 - b. Disable IS-IS on the interface:

```
no isis enable
```
 - c. Configure SPBM instance interface-type on IS-IS interface. SPBM supports only pt-pt:

```
isis spbm <1-100> interface-type {broadcast|pt-pt}
```
 - d. Configure the SPBM instance level 1 metric on the IS-IS interface:

```
isis spbm <1-100> ll-metric <1-16777215>
```
 - e. Enable IS-IS on the switch:

```
isis enable
```

Example

```
Switch> enable
Switch# configure terminal
Switch(config)# spbm ethertype 0x8100
Switch(config-isis)# no router isis enable
Switch(config)# router isis
Switch(config-isis)# spbm 1 lsdb-trap enable
Switch(config-isis)# router isis enable
Switch(config-isis)# exit
Switch(config)# interface gigabitethernet 1/7
Switch(config-if)# no isis enable
```

```
Switch(config-if)# isis spbm 1 interface-type pt-pt
Switch(config-if)# isis spbm 1 l1-metric 500
Switch(config-if)# isis enable
```

Variable definitions

Use the data in the following table to use the **spbm** command.

Variable	Value
ethertype {0x8100 0x88a8}	Configures the SPBM ethertype. The default value is 0x8100.
<1-100> lsdb-trap enable	Configures whether to enable or disable a trap when the SPBM LSDB changes. The default is disabled. Use the no or default options to disable LSDB traps.

Use the data in the following table to use the **isis spbm** command.

Variable	Value
<1-100> interface-type {broadcast pt-pt}	Configures the SPBM instance interface-type on the IS-IS interface located on the specified port or MLT. SPBM only supports the point-to-point (pt-pt) interface type. The default is pt-pt. Use the no or default options to set this parameter to the default value of pt-pt.
<1-100> l1-metric <1-16777215>	Configures the SPBM instance l1-metric on the IS-IS interface located on the specified port or MLT. The default value is 10. Use the no or default options to set this parameter to the default.

Configuring optional IS-IS global parameters

Use the following procedure to configure optional IS-IS global parameters.

Procedure

1. Enter IS-IS Router Configuration mode:

```
enable
configure terminal
router isis
```
2. Configure optional IS-IS global parameters:
 - a. Specify the Complete Sequence Number Packet (CSNP) interval in seconds:

```
csnp-interval <1-600>
```

- b. Configure the router type globally:

```
is-type {l1|l12}
```

- c. Configure the maximum level, in seconds, between generated LSPs by this Intermediate System:

```
max-lsp-gen-interval <30-900>
```

- d. Configure the IS-IS metric type:

```
metric {narrow|wide}
```

- e. Set or clear the overload condition:

```
overload
```

- f. Configure the overload-on-startup value in seconds:

```
overload-on-startup <15-3600>
```

- g. Configure the Partial Sequence Number Packet (PSNP) in seconds:

```
psnp-interval <1-120>
```

- h. Configure the minimum time between retransmission of an LSP:

```
retransmit-lsp-interval <1-300>
```

- i. Configure the SPF delay in milliseconds:

```
spf-delay <0-5000>
```

- j. Configure the name for the system:

```
sys-name WORD<0-255>
```

- k. Configure the IS-IS system ID for the switch:

```
system-id <xxxx.xxxx.xxxx>
```

Example

```
Switch> enable
Switch# configure terminal
Switch(config)# router isis
Switch(config-isis)# csnp-interval 10
Switch(config-isis)# is-type l1
Switch(config-isis)# max-lsp-gen-interval 800
Switch(config-isis)# metric wide
Switch(config-isis)# overload
Switch(config-isis)# overload-on-startup 30
Switch(config-isis)# psnp-interval 10
```

```
Switch(config-isis)# retransmit-lsp-interval 10
Switch(config-isis)# default sys-name
Switch(config-isis)# spf-delay 200
Switch(config-isis)# default system-id
```

Variable definitions

Use the data in the following table to use the **csnp-interval** command.

Variable	Value
<1-600>	Specifies the CSNP interval in seconds. This is a system level parameter that applies for level 1 CSNP generation on all interfaces. A longer interval reduces overhead, while a shorter interval speeds up convergence. The default value is 10. Use the no or default options to set this parameter to the default value of 10.

Use the data in the following table to configure the **is-type** command.

Variable	Value
{1 12}	Sets the router type globally: <ul style="list-style-type: none"> • 11: Level-1 router type • 112: Not valid. The default value is 11. Use the no or default options to set this parameter to the default value of 11.

Use the data in the following table to configure the **max-lsp-gen-interval** command.

Variable	Value
<30-900>	Specifies the maximum interval, in seconds, between generated LSPs by this Intermediate System. The default value is 900 seconds. Use the no or default options to set this parameter to the default value of 900.

Use the data in the following table to configure the **metric** command.

Variable	Value
{narrow wide}	Specifies the IS-IS metric type. Only wide is supported. The default value is wide. Use the no or default options to set this parameter to the default value of wide.

Use the data in the following table to configure the **overload** command.

Variable	Value
overload	Sets or clears the overload condition. The default value is disabled. Use the no or default options to set this parameter to the default value of disabled.

Use the data in the following table to configure the **overload-on-startup** command.

Variable	Value
<15-3600>	Specifies the IS-IS overload-on-startup value in seconds. The overload-on-startup value is used as a timer to control when to send out LSPs with the overload bit cleared after IS-IS startup. The default value is 20. Use the no or default options to set this parameter to the default value of 20.

Use the data in the following table to configure the **psnp-interval** command.

Variable	Value
<1-120>	Specifies the PSNP interval in seconds. This is a system level parameter that applies for level 1 PSNP generation on all interfaces. A longer interval reduces overhead, while a shorter interval speeds up convergence. The default value is 2. Use the no or default options to set this parameter to the default value of 2.

Use the data in the following table to configure the **retransmit-lsp-interval** command.

Variable	Value
<1-300>	Specifies the minimum time between retransmission of an LSP. This defines how fast the switch resends the same LSP. This is a system level parameter that applies for Level1 retransmission of LSPs. The default value is 5 seconds. Use the no or default options to set this parameter to the default value of 5.

Use the data in the following table to configure the **spf-delay** command.

Variable	Value
<0-5000>	Configures the delay, in milliseconds, to pace successive Shortest Path First (SPF) runs. The timer prevents more than two SPF runs from being scheduled back-to-back. The mechanism for pacing SPF allows two back-to-back SPF runs.

Variable	Value
	The default value is 100 milliseconds. Use the no or default options to set this parameter to the default value of 100 milliseconds.

Use the data in the following table to configure the **sys-name** command.

Variable	Value
<code>WORD<0–255></code>	<p>Specifies a name for the system. This may be used as the host name for dynamic host name exchange in accordance with RFC 2763.</p> <p>By default, the system name comes from the host name configured at the system level.</p> <p>Use the no or default options to set this parameter to the default value (host name).</p> <p> Note:</p> <p>No consistency checks appear when you edit sys-name.</p>

Use the data in the following table to configure the **system-id** command.

Variable	Value
<code><XXXX.XXXX.XXXX></code>	<p>Specifies the IS-IS system ID for the switch.</p> <p>Use the no or default options to set this parameter to the default value (node BMAC).</p>

Job aid

Important:

After you have configured the SPBM nickname and enabled IS-IS. To maintain the same nickname with a different system ID, perform the following steps:

1. Disable IS-IS.
2. Change the system ID.
3. Change the nickname to a temporary one.
4. Enable IS-IS.
5. Wait up to 20 minutes for the LSPs with the original system ID to age out.

Note:

To check the age out time, use the **show isis lsdb sysid <original-sys-id>** command on any of the other SPB nodes in the network. When there is no output from this command, proceed to the next step. The time left (in seconds) for the LSPs to age out is shown under the column LIFETIME.

6. Disable IS-IS.
7. Change the nickname to the original nickname.
8. Enable IS-IS.

Configuring optional IS-IS interface parameters

Use the following procedure to configure optional IS-IS interface parameters.

Important:

Save your configuration using `save config` for the updates to be available after reboot. Saving the configuration also ensures that any authentication keys (passwords) specified during the configuration are properly encrypted.

Procedure

1. Enter Interface Configuration mode:

```
enable
configure terminal
interface GigabitEthernet {slot/port[/sub-port] [-slot/port[/sub-
port]] [, ...]} or interface mlt <1-512>
```

Note:

If your platform supports channelization and the port is channelized, you must also specify the sub-port in the format slot/port/sub-port.

2. Configure optional IS-IS interface parameters:

- a. Specify the authentication type used for IS-IS hello packets on the interface:

```
isis hello-auth type {none|simple|hmac-md5|hmac-sha-256}
```

- b. If you select `simple` as the `hello-auth` type, you must also specify a key value but the key-id is optional:

```
isis hello-auth type simple key WORD<1-16> [key-id <1-255>]
```

- c. If you select `hmac-md5` or `hmac-sha-256`, you must also specify a key value. The key-id is optional:

```
isis hello-auth type hmac-md5 key WORD<1-16> [key-id <1-255>]]
```

```
isis hello-auth type hmac-sha-256 key WORD<1-16> [key-id <1-
255>]]
```

- d. Configure the level 1 IS-IS designated router priority:

```
isis [l1-dr-priority <0-127>]
```

*** Note:**

This parameter is not used for SPBM because SPBM only runs on point-to-point interfaces. This parameter is for designated router election on a broadcast LAN segment, which is not supported.

- e. Configure the level 1 hello interval:

```
isis [l1-hello-interval <1-600>]
```

- f. Configure the level 1 hello multiplier:

```
isis [l1-hello-multiplier <1-600>]
```

Example

```
Switch:1> enable
Switch:1# configure terminal
Switch(config):1# interface gigabitethernet 1/1
Switch(config-if):1# isis
Switch(config-if):1# isis hello-auth type hmac-md5 key test
Switch(config-if):1# isis l1-dr-priority 100
Switch(config-if):1# isis l1-hello-interval 20
Switch(config-if):1# isis l1-hello-multiplier 10
Switch(config):1# save config
```

Variable definitions

Use the data in the following table to configure the `isis` command.

Variable	Value
hello-auth type {none simple hmac-md5 hmac-sha-256}][key [key WORD<1-16>] [key-id <1-255>]	<p>Specifies the authentication type used for IS-IS hello packets on the interface. type can be one of the following:</p> <ul style="list-style-type: none"> • none • simple: If selected, you must also specify a key value but the key id is optional. Simple password authentication uses a text password in the transmitted packet. The receiving router uses an authentication key (password) to verify the packet. • hmac-md5: If selected, you must also specify a key value but the key-id is optional. MD5 authentication creates an encoded checksum in the transmitted packet. The receiving router uses an authentication key (password) to verify the MD5 checksum of the packet. There is an optional key ID. • hmac-sha-256: If selected, you must also specify a key value but the key-id is optional. With SHA-256 authentication, the switch adds an hmac-sha-256 digest to each Hello packet.

Table continues...

Variable	Value
	<p>The switch that receives the Hello packet computes the digest of the packet and compares it with the received digest. If the digests match, the packet is accepted. If the digests do not match, the receiving switch discards the packet. There is an optional key ID.</p> <p>* Note:</p> <p>Secure Hashing Algorithm 256 bits (SHA-256) is a cipher and a cryptographic hash function of SHA2 authentication. You can use SHA-256 to authenticate IS-IS Hello messages. This authentication method uses the SHA-256 hash function and a secret key to establish a secure connection between switches that share the same key.</p> <p>This feature is in full compliance with RFC 5310.</p> <p>The default is none. Use the no or default options to set the hello-auth type to none.</p>
l1-dr-priority <0–127>	<p>Configures the level 1 IS-IS designated router priority to the specified value. The default value is 64.</p> <p>Use the no or default options to set this parameter to the default value of 64.</p> <p>* Note:</p> <p>This parameter is not used for SPBM because SPBM only runs on point-to-point interfaces. This parameter is for designated router election on a broadcast LAN segment, which is not supported.</p>
l1-hello-interval <1–600>	<p>Configures the level 1 hello interval. The default value is 9 seconds.</p> <p>Use the no or default options to set this parameter to the default value of 9 seconds.</p>
l1-hello-multiplier <1–600>	<p>Configures the level 1 hello multiplier. The default value is 3 seconds.</p> <p>Use the no or default options to set this parameter to the default value of 3 seconds.</p>

Displaying IS-IS interface parameters

Use the following procedure to display the IS-IS interface parameters.

Procedure

1. Enter Privileged EXEC mode:

```
enable
```

2. Display IS-IS interface configuration and status parameters (including adjacencies):

```
show isis interface [l1|l2|l12]
```

3. Display IS-IS interface authentication configuration:

```
show isis int-auth
```

4. Display IS-IS interface timers:

```
show isis int-timers
```

5. Display IS-IS circuit level parameters:

```
show isis int-ckt-level
```

Example

```
Switch:1# show isis interface
```

```
=====
                        ISIS Interfaces
=====
IFIDX      TYPE      LEVEL      OP-STATE  ADM-STATE  ADJ      UP-ADJ      SPBM-L1-METRIC
-----
Mlt2       pt-pt    Level 1    UP        UP         1        1          10
Port1/21   pt-pt    Level 1    UP        UP         1        1          10
=====
```

```
Switch:1# show isis int-auth
```

```
=====
                        ISIS Interface Auth
=====
IFIDX      AUTH-TYPE  AUTH-KEYID  AUTH-KEY
-----
Mlt2       none       0           0
Port1/21   none       0           0
=====
```

```
Switch:1# show isis int-timers
```

```
=====
                        ISIS Interface Timers
=====
IFIDX      LEVEL      HELLO      HELLO      HELLO
           LEVEL    INTERVAL  MULTIPLIER  DR
-----
Mlt2       Level 1    9         3           3
Port1/21   Level 1    9         3           3
=====
```

```
Switch:1# show isis int-ckt-level
```

```
=====
                        ISIS Circuit level parameters
=====
IFIDX      LEVEL      DIS      CKTID
-----
Mlt2       Level 1    1
Port1/21   Level 1    2
=====
```

Variable definitions

Use the data in the following table to use the IS-IS interface show command.

Variable	Value
[I1, I2, I12]	Displays the interface information for the specified level: I1, I2, or I12.

Job aid

The following sections describe the fields in the outputs for the IS-IS interface show commands.

show isis interface

The following table describes the fields in the output for the `show isis interface` command.

Parameter	Description
IFIDX	Indicates the interface index for the Ethernet or MLT interface.
TYPE	Indicates the type of interface configured (only pt-pt is supported).
LEVEL	Indicates the level of the IS-IS interface (Level 1 [default] or Level 2).
OP-STATE	Shows the physical connection state of the interface.
ADM-STATE	Shows the configured state of the interface.
ADJ	Shows how many adjacencies are learned through the interface.
UP-ADJ	Shows how many adjacencies are active through the interface.
SPBM-L1-METRIC	Indicates the SPBM instance Level 1 metric on the IS-IS interface.

show isis int-auth

The following table describes the fields in the output for the `show isis int-auth` command.

Parameter	Description
IFIDX	Shows the interface index for the Ethernet or MLT interface.
AUTH-TYPE	Shows the type of authentication configured for the interface. Types include: <ul style="list-style-type: none"> • none for no authentication. • simple for a simple password. • hmac-md5 for MD5 encryption. • hmac-sha-256 for SHA-256 encryption.
AUTH-KEYID	Shows the authentication password configured for the interface. If the KeyId is not configured, the value is 0.
AUTH-KEY	Shows the HMAC-MD5 key needed for encryption. This is used only for HMAC-MD5.

show isis int-timers

The following table describes the fields in the output for the `show isis int-timers` command.

Parameter	Description
IFIDX	Indicates the interface index for the Ethernet or MLT interface.

Table continues...

Parameter	Description
LEVEL	Indicates the IS-IS interface level.
HELLO INTERVAL	Indicates the interval at which a Hello packet is sent to the IS-IS network.
HELLO MULTIPLIER	Indicates the multiplier that is used in conjunction with the Hello Interval.
HELLO DR	Indicates the interval at which a Hello packet is sent to the IS-IS network if the router is a designated router (DIS).

show isis int-ckt-level

The following table describes the fields in the output for the `show isis int-ckt-level` command.

Parameter	Description
IFIDX	Shows the interface index for the ethernet or MLT interface.
LEVEL	Shows the level of the IS-IS interface (Level 1 [default] or Level 2).
DIS	Shows the Designated Intermediate System (DIS) of the circuit.
CKT ID	Displays the CKT ID.

Displaying the IP unicast FIB, multicast FIB, unicast FIB, and unicast tree

Use the following procedure to display SPBM IP unicast Forwarding Information Base (FIB), SPBM multicast FIB, unicast FIB, and the unicast tree.

In SPBM, Backbone MAC (B-MAC) addresses are carried within the IS-IS link-state database. To do this, SPBM supports an IS-IS Type-Length-Value (TLV) that advertises the Service Instance Identifier (I-SID) and B-MAC information across the network. Each node has a System ID, which also serves as B-MAC of the switch. These B-MAC addresses are populated into the SPBM Forwarding Information Base (FIB).

When the network topology is discovered and stored in the IS-IS link-state database, each node calculates shortest path trees for each source node, so that a unicast path now exists from every node to every other node. With this information, each node populates unicast information received from SPBM into the FIB for forwarding purposes.

I-SIDs are only used for virtual services (Layer 2 VSNs and Layer 3 VSNs). If you only enable IP Shortcuts on the Backbone Edge Bridges, I-SIDs are never exchanged in the network as IP Shortcuts allow Global Routing Table (GRT) IP networks to be transported across IS-IS.

The `show isis spbm ip-unicast-fib` command displays all of the IS-IS routes in the IS-IS LSDB. The IP ROUTE PREFERENCE column in the `show isis spbm ip-unicast-fib` command displays the IP route preference.

Routes within the same VSN are added to the LSDB with a default preference of 7. Inter-VSN routes are added to the LSDB with a route preference of 200. IS-IS accept policies allow you to change the route preference for incoming routes. If the same route is learned from multiple sources with

different route preferences, then the routes are not considered equal cost multipath (ECMP) routes. The route with the lowest route preference is the preferred route. In Layer 2, in the event of a tie-break between routes from multiple sources, the tie-breaking is based on cost and hop count.

Procedure

1. Enter Privileged EXEC mode:

```
enable
```

2. Display the SPBM IP unicast FIB:

```
show isis spbm ip-unicast-fib [all] [id <1-16777215>] [spbm-nh-as-
mac]
```

*** Note:**

To display the IPv6 unicast FIB, use the `show isis spbm ipv6-unicast-fib` command.

3. Display the SPBM multicast FIB:

```
show isis spbm multicast-fib [vlan <1-4059>] [i-sid <1-16777215>]
[nick-name <x.xx.xx>] [summary]
```

4. Display the SPBM unicast FIB:

```
show isis spbm unicast-fib [b-mac <0x00:0x00:0x00:0x00:0x00:0x00>]
[vlan <1-4059>] [summary]
```

5. Display the SPBM unicast tree:

```
show isis spbm unicast-tree <1-4059> [destination <xxxx.xxxx.xxxx>]
```

Example

```
Switch# show isis spbm ip-unicast-fib
```

```
=====
                                SPBM IP-UNICAST FIB ENTRY INFO
=====
```

VRF	ISID	DEST ISID	Destination	NH	BEB	VLAN	OUTGOING INTERFACE	SPBM COST	PREFIX COST	PREFIX TYPE	IP ROUTE PREFERENCE
GRT	-	-	10.133.136.0/24	4K3	(*)	4058	1/3	10	1	Internal	7
GRT	-	-	10.133.136.0/24	4K3	(*)	4059	1/3	10	1	Internal	7
GRT	-	-	10.133.136.0/24	4K4	(*)	4058	to_4k4	10000	1	Internal	7
GRT	-	-	10.133.136.0/24	4K4	(*)	4059	to_4k4	10000	1	Internal	7

```
-----
Total number of SPBM IP-UNICAST FIB entries 4
=====
```

```
Switch# show isis spbm ip-unicast-fib id 10002
```

```
=====
                                SPBM IP-UNICAST FIB ENTRY INFO
=====
```

VRF	ISID	DEST ISID	Destination	NH	BEB	VLAN	OUTGOING INTERFACE	SPBM COST	PREFIX COST	PREFIX TYPE	IP ROUTE PREFERENCE
vrf2	-	10002	65.2.2.0/24	ESS2		1000	1/13	20	20	Internal	7
vrf2	-	10002	65.2.2.0/24	ESS2		1001	1/18	20	20	Internal	7

```
-----
Total number of SPBM IP-UNICAST FIB entries 2
-----
```

```
Switch# show isis spbm ip-unicast-fib all
```

```
=====
SPBM IP-UNICAST FIB ENTRY INFO
=====
```

VRF	DEST ISID	DESTINATION	NH	BEB	VLAN	OUTGOING INTERFACE	SPBM COST	PREFIX COST	PREFIX TYPE	IP ROUTE PREFERENCE
GRT	-	1.0.0.1/32	ESP0		1000	1/13	20	1	Internal	7
GRT	-	1.0.0.1/32	ESP0		1000	1/18	20	1	Internal	7
vrf2	10002	65.2.2.0/24	ESS2		1000	1/13	20	20	Internal	7
vrf2	10002	65.2.2.0/24	ESS2		1001	1/18	20	20	Internal	7

```
-----
Total number of SPBM IP-UNICAST FIB entries 4
-----
```

```
Switch#show isis spbm multicast-fib
```

```
=====
SPBM MULTICAST FIB ENTRY INFO
=====
```

MCAST DA	ISID	BVLAN	SYSID	HOST-NAME	OUTGOING-INTERFACES	INCOMING INTERFACE
03:00:07:e4:e2:02	15000066	1001	0077.0077.0077	Switch-25	1/33	MLT-2
03:00:08:e4:e2:02	15000066	1001	0088.0088.0088	Switch-33	1/50,1/33	40.40.40.40
03:00:41:00:04:4d	1101	4058	00bb.0000.4100	Switch-1(*)	1/3,1/49,0.0.0.0	
Tunnel_to_HQ						
03:00:41:00:04:4f	1103	4058	00bb.0000.4100	Switch-1(*)	1/3,1/49,0.0.0.0	cpp

```
-----
Total number of SPBM MULTICAST FIB entries 4
-----
```

```
Switch# show isis spbm unicast-fib
```

```
=====
SPBM UNICAST FIB ENTRY INFO
=====
```

DESTINATION ADDRESS	BVLAN	SYSID	HOST-NAME	OUTGOING INTERFACE	COST
00:16:ca:23:73:df	1000	0016.ca23.73df	SPBM-1	1/21	10
00:16:ca:23:73:df	2000	0016.ca23.73df	SPBM-1	1/21	10
00:18:b0:bb:b3:df	1000	0018.b0bb.b3df	SPBM-2	MLT-2	10
00:14:c7:e1:33:e0	1000	0018.b0bb.b3df	SPBM-2	MLT-2	10
00:18:b0:bb:b3:df	2000	0018.b0bb.b3df	SPBM-2	MLT-2	10

```
-----
Total number of SPBM UNICAST FIB entries 5
-----
```

Variable definitions

Use the data in the following table to use the `show isis spbm ip-unicast-fib` command.

Variable	Value
all	Displays entries for the Global Routing Table (GRT) and all Virtual Routing and Forwarding (VRF) instances. * Note: If you use the command <code>show isis spbm ip-unicast-fib</code> the device displays only GRT entries. The command shows IP routes from remote Backbone Edge Bridges (BEBs).
id <1-16777215>	Displays IS-IS SPBM IP unicast Forwarding Information Base (FIB) information by Service Instance Identifier (I-SID) ID.
spbm-nh-as-mac	Displays the next hop B-MAC of the IP unicast FIB entry.

Use the data in the following table to use the `show isis spbm multicast-fib` command.

Variable	Value
vlan <1-4059>	Displays the FIB for the specified SPBM VLAN.
i-sid <1-16777215>	Displays the FIB for the specified I-SID.
nick-name <x.xx.xx>	Displays the FIB for the specified nickname.
summary	Displays a summary of the FIB.

Use the data in the following table to use the `show isis spbm unicast-fib` command.

Variable	Value
b-mac <0x00:0x00:0x00:0x00:0x00:0x00>	Displays the FIB for the specified B-MAC.
vlan <1-4059>	Displays the FIB for the specified SPBM VLAN.
summary	Displays a summary of the FIB.

Use the data in the following table to use the `show isis spbm unicast-tree` command.

Variable	Value
<1-4059>	Specifies the SPBM B-VLAN ID.
destination <xxxx.xxxx.xxxx>	Displays the unicast tree for the specified destination.

Job aid

The following sections describe the fields in the outputs for SPBM multicast FIB, unicast FIB, and unicast tree show commands.

show isis spbm ip-unicast-fib

The following table describes the fields in the output for the `show isis spbm ip-unicast-fib` command.

Parameter	Description
VRF	Specifies the VRF ID of the IP unicast FIB entry, 0 indicates NRE.
VRF ISID	Specifies the I-SID of the IP unicast FIB entry.
DEST ISID	Specifies the destination I-SID of the IP unicast FIB entry.
Destination	Specifies the destination IP address of the IP unicast FIB entry.
NH BEB	Specifies the next hop B-MAC of the IP unicast FIB entry.
VLAN	Specifies the VLAN of the IP unicast FIB entry.
OUTGOING INTERFACE	Specifies the outgoing port of the IP unicast FIB.
SPBM COST	Specifies the B-MAC cost of the IP unicast FIB entry.
PREFIX COST	Specifies the prefix cost of the IP unicast FIB entry.
PREFIX TYPE	Specifies the prefix type of the IP unicast FIB entry.
IP ROUTE PREFERENCE	Specifies the IP route preference of the IP unicast FIB entry.

show isis spbm multicast-fib

The following table describes the fields in the output for the `show isis spbm multicast-fib` command.

Parameter	Description
MCAST DA	Indicates the multicast destination MAC address of the multicast FIB entry.
ISID	Indicates the I-SID of the multicast FIB entry.
BVLAN	Indicates the B-VLAN of the multicast FIB entry.
SYSID	Indicates the system identifier of the multicast FIB entry.
HOST-NAME	Indicates the host name of the multicast FIB entry.
OUTGOING INTERFACE	Indicates the outgoing port of the multicast FIB entry.
INCOMING INTERFACE	Indicates the outgoing port of the multicast FIB entry.

show isis spbm unicast-fib

The following table describes the fields in the output for the `show isis spbm unicast-fib` command.

Parameter	Description
DESTINATION ADDRESS	Indicates the destination MAC Address of the unicast FIB entry.
BVLAN	Indicates the B-VLAN of the unicast FIB entry.
SYSID	Indicates the destination system identifier of the unicast FIB entry.
HOST-NAME	Indicates the destination host name of the unicast FIB entry.

Table continues...

Parameter	Description
OUTGOING INTERFACE	Indicates the outgoing interface of the unicast FIB entry.
COST	Indicates the cost of the unicast FIB entry.

Displaying IS-IS LSDB and adjacencies

Use the following procedure to display the IS-IS LSDB and adjacencies.

Procedure

1. Log on to the switch to enter User EXEC mode.
2. Display the IS-IS LSDB:

```
show isis lsdb [level {l1|l2|l12}] [sysid <xxxx.xxxx.xxxx>] [lspid
<xxxx.xxxx.xxxx.xx-xx>] [tlv <l-184>] [detail]
```

3. Display IS-IS adjacencies:

```
show isis adjacencies
```

4. Clear IS-IS LSDB:

```
clear isis lsdb
```

Example

```
Switch:1# show isis lsdb
```

```
=====
                        ISIS LSDB
=====
LSP ID                LEVEL    LIFETIME  SEQNUM    CHKSUM    HOST-NAME
-----
0014.c7e1.33df.00-00    1         545       0xb1      0xed28    NewYork
0016.ca23.73df.00-00    1         1119      0x9f      0x9c9d    Switch-Lab2
0018.b0bb.b3df.00-00    1         708       0xb9      0xcb1a    Switch-Lab1
=====
Level-1 : 3 out of 3 Total Num of LSP Entries
Level-2 : 0 out of 0 Total Num of LSP Entries
```

```
Switch:1# show isis adjacencies
```

```
=====
                        ISIS Adjacencies
=====
INTERFACE    L STATE    UPTIME PRI  HOLDDTIME  SYSID                HOST-NAME    STATUS
-----
Port1/11     1 UP       05:02:18 127    22 beb0.0000.7204    Switch-Lab1  ACTIVE
Port1/12     1 UP       05:00:18 127    25 beb0.0000.7204    Switch-Lab2  BACKUP
Port1/16     1 UP       05:00:25 127    24 beb0.0000.7204    Switch-Lab3  BACKUP
=====
3 out of 3 interfaces have formed an adjacency
=====
```

```
Switch:1> show isis lsdb detail
```

```
=====
                        ISIS LSDB (DETAIL)
=====
```

```

-----
Level-1 LspID: 0001.bcb0.0003.00-001      SeqNum: 0x00000522      Lifetime: 1144
        Chksum: 0x32f7  PDU Length: 312
        Host_name: C0
        Attributes:      IS-Type 1
TLV:1   Area Addresses: 1
        c1.3000.0000.00

TLV:22  Extended IS reachability:
        Adjacencies: 7
        TE Neighbors: 7
          0000.beb1.0007.01 (Switch0)      Metric:10
            SPBM Sub TLV:
              port id: 640 num_port 1
              Metric: 10
          0000.beb1.00b1.01 (Switch1)      Metric:10
            SPBM Sub TLV:
              port id: 643 num_port 1
              Metric: 10
          0000.bcb1.0004.01 (C1)  Metric:10
            SPBM Sub TLV:
              port id: 6144 num_port 1
              Metric: 10
          0000.beb1.00ca.01 (Switch2)      Metric:10
            SPBM Sub TLV:
              port id: 6156 num_port 1
              Metric: 10
          0000.beb1.00a5.01 (VSS0)      Metric:10
            SPBM Sub TLV:
              port id: 651 num_port 1
              Metric: 10
          0000.beb1.00b2.01 (VSS1)      Metric:10
            SPBM Sub TLV:
              port id: 645 num_port 1
              Metric: 10
          0000.beb1.0008.01 (Switch1)      Metric:10
            SPBM Sub TLV:
              port id: 652 num_port 1
              Metric: 10

TLV:129 Protocol Supported: SPBM

```

SPBM and IS-IS infrastructure configuration

```
TLV:137 Host_name: C0#
TLV:144 SUB-TLV 1      SPBM INSTANCE:
                    Instance: 0
                    bridge_pri: 0
                    OUI: 00-33-33
                    num of trees: 2
                    vid tuple : u-bit 1 m-bit 1 ect-alg 0x80c201 base vid 1000
                    vid tuple : u-bit 1 m-bit 1 ect-alg 0x80c202 base vid 1001
TLV:144 SUB-TLV 3      ISID:
                    Instance: 0
                    Metric: 0
                    B-MAC: 00-00-bc-b1-00-03
                    BVID:1000
                    Number of ISID's:8
                    3001 (Both), 3002 (Rx), 3003 (Both), 3004 (Rx), 4001 (Both), 4002 (
Rx), 4003 (Both), 4004 (Rx)

                    Instance: 0
                    Metric: 0
                    B-MAC: 00-00-bc-b1-00-03

--More-- (q = quit)
```

Variable definitions

Use the data in the following table to use the `show isis lsdb` command.

Variable	Value
detail	Displays detailed information.
level {/1 /2 /12}	Displays the LSDB for the specified level: l1, l2, or l12.
local	Displays IS-IS local LSDB information.
sysid <xxxx.xxxx.xxxx>	Displays the LSDB for the specified system ID.
lspid <xxxx.xxxx.xxxx.xx-xx>	Displays the LSDB for the specified LSP ID.
tlv <1-184>	Displays the LSDB by TLV type.

Use the data in the following table to use the `clear isis` command.

Variable	Value
lsdb	Clears the IS-IS Link State Database (LSDB). The command clears learned LSPs only. The command does not clear local generated LSPs. As soon as the platform clears the LSDB the LSP synchronization process starts immediately and the LSDB synchronizes with its neighbors.

Job aid

The following sections describe the fields in the outputs for the IS-IS LSDB and adjacencies show commands.

show isis lsdb

The following table describes the fields in the output for the **show isis lsdb** command.

Parameter	Description
LSP ID	Indicates the LSP ID assigned to external IS-IS routing devices.
LEVEL	Indicates the level of the external router: L1, L2, or L12.
LIFETIME	Indicates the maximum age of the LSP. If the max-lsp-gen-interval is set to 900 (default) then the lifetime value begins to count down from 1200 seconds and updates after 300 seconds if connectivity remains. If the timer counts down to zero, the counter adds on an additional 60 seconds, then the LSP for that router is lost. This happens because of the zero age lifetime, which is detailed in the RFC standards.
SEQNUM	Indicates the LSP sequence number. This number changes each time the LSP is updated.
CHKSUM	Indicates the LSP checksum. This is an error checking mechanism used to verify the validity of the IP packet.
HOST-NAME	Indicates the hostname listed in the LSP. If the host name is not configured, then the system name is displayed.

show isis adjacencies

The following table describes the fields in the output for the **show isis adjacencies** command.

Parameter	Description
INTERFACE	Indicates the interface port, MLT, or logical interface on which IS-IS exists.
L	Indicates the level of the adjacent router.
STATE	Indicates the state of IS-IS on the interface (enabled [UP] or disabled [DOWN]). The state is non-configurable.
UPTIME	Indicates the length of time the adjacency has been up in ddd hh:mm:ss format.
PRI	Indicates the priority of the neighboring Intermediate System for becoming the Designated Intermediate System (DIS).
HOLDTIME	Indicates the calculated hold time for the Hello (hello multiplier x hello interval); if the route is determined to be a designated router, then the product is divided by 3.
SYSID	Indicates the adjacent system ID of the router.
HOST-NAME	Indicates the hostname listed in the LSP. If the host name is not configured, then the system name is displayed.
STATUS	Indicates if the adjacency is active.

Displaying IS-IS Statistics and Counters

Use the following procedure to display the IS-IS statistics and counters.

Procedure

1. Display IS-IS system statistics:

```
show isis statistics
```

2. Display IS-IS interface counters:

```
show isis int-counters
```

3. Display IS-IS level 1 control packet counters:

```
show isis int-l1-ctrl-pkts
```

*** Note:**

The switch uses level 1 IS-IS. The switch does not support level 2 IS-IS. The command **show isis int-l2-ctrl-pkts** is not supported because the IEEE 802.1aq standard currently only defines the use of one hierarchy, Level 1.

4. Clear IS-IS statistics:

```
clear isis stats [error-counters] [packet-counters]
```

Example

```
Switch:1# show isis statistics
```

```
=====
                        ISIS System Stats
=====
```

LEVEL	CORR	AUTH	AREA	MAX SEQ	SEQ NUM	OWN	LSP	BAD ID	PART	LSP	DB
	LSPs	FAILS	DROP	EXCEEDED	SKIPS		PURGE	LEN	CHANGES	OLOAD	
Level-1	0	0	0	0	1	0	0	0	0	0	

```
Switch:1# show isis int-counters
```

```
=====
                        ISIS Interface Counters
=====
```

IFIDX	LEVEL	AUTH	ADJ	INIT	REJ	ID	LEN	MAX	AREA	LAN	DIS
		FAILS	CHANGES		FAILS	ADJ					CHANGES
Mlt2	Level 1-2	0	1		0	0		0	0		0
Port1/21	Level 1-2	0	1		0	0		0	0		0

```
Switch:1# show isis int-l1-ctrl-pkts
```

```
=====
                        ISIS L1 Control Packet counters
=====
```

IFIDX	DIRECTION	HELLO	LSP	CSNP	PSNP
Mlt2	Transmitted	13346	231	2	229
Mlt2	Received	13329	230	1	230
Port1/21	Transmitted	13340	227	2	226
Port1/21	Received	13335	226	1	227

Variable Definitions

Use the data in the following table to use the `clear isis stats` command.

Variable	Value
error-counters	Clears IS-IS stats error-counters.
packet-counters	Clears IS-IS stats packet-counters.

Job Aid

show isis statistics

The following table describes the fields in the output for the `show isis statistics` command.

Parameter	Description
LEVEL	Shows the level of the IS-IS interface.
CORR LSPs	Shows the number of corrupted LSPs detected.
AUTH FAILS	Shows the number of times authentication has failed on the global level.
AREA DROP	Shows the number of manual addresses dropped from the area.
MAX SEQ EXCEEDED	Shows the number of attempts to exceed the maximum sequence number.
SEQ NUM SKIPS	Shows the number of times the sequence number was skipped.
OWN LSP PURGE	Shows how many times the local LSP was purged.
BAD ID LEN	Shows the number of ID field length mismatches.
PART CHANGES	Shows the number of partition link changes.
LSP DB OLOAD	Show the number of times the switch was in the overload state.

show isis int-counters

The following table describes the fields in the output for the `show isis int-counters` command.

Parameter	Description
IFIDX	Shows the interface index for the Ethernet or MLT interface.
LEVEL	Shows the level of the IS-IS interface.
AUTH FAILS	Shows the number of times authentication has failed per interface.
ADJ CHANGES	Shows the number of times the adjacencies have changed.
INIT FAILS	Shows the number of times the adjacency has failed to establish.
REJ ADJ	Shows the number of times the adjacency was rejected by another router.
ID LEN	Shows the ID field length mismatches.
MAX AREA	Shows the maximum area address mismatches.
LAN DIS CHANGES	Shows the number of times the DIS has changed.

show isis int-l1-ctrl-pkts

The following table describes the fields in the output for the `show isis int-l1-ctrl-pkts` command.

Parameter	Description
IFIDX	Shows the interface index for the Ethernet or MLT interface.
DIRECTION	Shows the packet flow (Transmitted or Received).
HELLO	Shows the amount of interface-level Hello packets.
LSP	Shows the amount of LSP packets.
CSNP	Shows the amount of CSNPs.
PSNP	Shows the amount of PSNPs.

Running the Layer 2 Video Surveillance install script

Use the following procedure to run the install script using the `syntax` parameter, which displays the run commands and any errors.

This feature is not supported on all hardware platforms. If you do not see this command in the CLI, the feature is not supported on your hardware. For more information about feature support, see *Release Notes*.

Before you begin

The switch must be in the factory default state before executing the install script. When you start the install script, a prompt appears to remind you to do this.

Procedure

1. Enter Global Configuration mode:

```
enable
configure terminal
```

2. Run the install script:

```
run vms layer-2 switch <5-99> [syntax]
```

The script uses the value that you assign to the switch number (between 5 and 99) to seed unique values in the configuration script.

 **Note:**

If the script causes a configuration conflict or cannot run a command, an error message displays but the script continues to run.

Example

The following example shows the complete output of the install script without the `syntax` parameter. As you can see, there is no indication that the script encountered any errors.

```
Switch:1>enable
Switch:1#config terminal
Enter configuration commands, one per line.  End with CNTL/Z.

Switch:1(config)# run vms layer-2 switch 6

Do you want to execute the run vms layer-2 script? Device needs to be in factory default
state. (y/n) ? y

**Previous configurations stored in pre_vms_layer2_install.cfg**
**New VMS configurations stored in new_primary config file vms-layer2-switch-6.cfg**
*** VMS Layer-2 script execution complete ***
Switch:1(config)#boot config choice primary config-file /intflash/vms-layer2-switch-6.cfg
```

The following displays the output of the script using the `syntax` parameter. This example is only a small sample of the output, but it shows how the script reports warnings and errors it encounters.

```
Switch:1>enable
Switch:1#config terminal
Enter configuration commands, one per line.  End with CNTL/Z.

Switch:1(config)# run vms layer-2 switch 6 syntax

Do you want to execute the run vms layer-2 script? Device needs to be in factory default
state. (y/n) ? y

Switch:1(config)# save config file pre_vms_layer2_install.cfg
File [/intflash/pre_vms_layer2_install.cfg] already existing,CP-1: Save config to file /
intflash/pre_vms_layer2_install.cfg successful.
WARNING: Choice Primary Node Config file is "/intflash/vms-layer2-switch-6.cfg".

Switch:1(config)# spbm
Switch:1(config)# spbm ethertype 0x8100
Switch:1(config)# router isis
Switch:1(config-isis)# spbm 1

Error: ISIS - IS-IS is enabled, runtime change not allowed.

Switch:1(config)# exit

Switch:1(config)# save config file vms-layer2-switch-6.cfg
File [/intflash/vms-layer2-switch-6.cfg] already existing,CP-1: Save config to file /
intflash/vms-layer2-switch-6.cfg successful.

Switch:1(config)# boot config choice primary config-file /intflash/vms-layer2-switch-6.cfg
Switch:1(config)#
**Previous configurations stored in pre_vms_layer2_install.cfg**
**New VMS configurations stored in new_primary config file vms-layer2-switch-6.cfg**
*** VMS Layer-2 script execution complete ***
Switch:1(config)#boot config choice primary config-file /intflash/vms-layer2-switch-6.cfg
```

Variable definitions

Use the data in the following table to use the `run vms layer-2 switch` command.

Variable	Value
<5-99>	<p>Specifies a switch value, which is then used as a common element to configure switch parameters such as nickname, VLAN ID, SPB and IP parameters.</p> <p>This switch value is also used in the name of the saved configuration file. For example, 6 is the switch value in <code>vms-layer2-switch-6.cfg</code>.</p>
syntax	<p>Lists all the commands run by the script.</p> <p>* Note:</p> <p>The script does not stop if it encounters errors. To verify that the script runs without errors, use the <code>syntax</code> parameter to display errors or conflicting configurations on the switch.</p>

Fabric Extend configuration using the CLI

The following sections provide procedural information you can use to configure Fabric Extend (FE) using the Command Line Interface (CLI).

Configuring Fabric Extend

Use the following procedure to configure Fabric Extend (FE) between a VSP 8000 in a Main office to a VSP 4000 in a Branch office. This is a typical deployment. However, if your deployment creates tunnels between two switches that support Fabric Extend natively (VSP 7200 Series and the VSP 8000 Series) then repeat those steps and ignore the steps for switches that require an ONA.

*** Note:**

VRF is an optional parameter. If a VRF is not configured, then FE uses the GRT.

Before you begin

The tunnel source IP address can be either a brouter port interface or a CLIP IP.

If using the tunnel originating address on the **GRT**, Fabric Extend has the following requirements:

- The tunnel source IP address must be on the GRT, not on a VRF.

*** Note:**

A Best Practice is to use separate IP addresses for the SPBM IP Shortcuts `ip-source-address` command and the Fabric Extend `ip-tunnel-source-address` command. However, if you want these IP addresses to be the same, you **MUST** exclude the `ip-source-address` address with an IS-IS accept policy. You cannot use the redistribute command with a route map exclusion.

Specify a CLIP interface to use as the source address for SPBM IP shortcuts.

- If IP Shortcuts is enabled, you must configure an IS-IS accept policy or exclude route-map to ensure that tunnel destination IP addresses are not learned through IS-IS.

If you are using the tunnel originating address on a **VRF**, Fabric Extend has the following requirements:

- Configure a CLIP and tunnel source IP address on the VRF.
- Remote management of the VSP 4000 is only possible after establishing IP Shortcut over IS-IS. (Alternatively, you can enable GRT-VRF redistribution locally.)

About this task

Configuring Fabric Extend consists of two primary tasks: configuring the tunnel source address and configuring the logical interface. These tasks must be completed on both ends of the tunnel.

Note that the VSP 4000 source address command is different than the VSP 7200/VSP 8000/VSP 8600 Series command. Also note that the logical interface commands are different between Layer 2 and Layer 3 networks.

Procedure

The following steps are for platforms that support FE natively.

1. Enter IS-IS Router Configuration mode:

```
enable
configure terminal
router isis
```

2. Configure the IP tunnel source address:

```
ip-tunnel-source-address <A.B.C.D> [vrf WORD<1-16>]
```

3. Enter Global Configuration mode:

```
exit
```

4. Use one of the following commands to create a logical IS-IS interface:

- In a network with a Layer 3 Core, enter `logical-intf isis <1-255> dest-ip <A.B.C.D> [name WORD<1-16>]`
- In a network with a Layer 2 Core, enter `logical-intf isis <1-255> vid <list of vids> primary-vid <2-4059> port <slot/port> mlt <mltId> [name WORD<1-16>]`

*** Note:**

The primary VLAN ID (`primary-vid` must be one of the VIDs in the `vid <list of vids>`.

The following steps are for platforms that require an ONA to support FE.

*** Note:**

The interface VLAN connecting to the ONA network port is always in the GRT and the member port that the VLAN is part of is always an access port.

5. Enter IS-IS Router Configuration mode:

```
enable
configure terminal
router isis
```

6. Configure the IP tunnel source address on the port that connects to the Device side of the ONA:

```
ip-tunnel-source-address <A.B.C.D> port <slot/port> [mtu <750-1950>]
[vrf WORD<1-16>]
```

7. Exit back into Global Configuration mode:

```
exit
```

8. Use one of the following commands to create a logical IS-IS interface:

- In a network with a Layer 3 Core, enter:

```
logical-intf isis <1-255> dest-ip <A.B.C.D> [name WORD<1-16>]
```

- In a network with a Layer 2 Core, enter:

```
logical-intf isis <1-255> vid <list of vids> primary-vid <2-4059>
port <slot/port> mlt <mltId> [name WORD<1-16>]
```

*** Note:**

The primary VLAN ID (**primary-vid**) must be one of the VLANs in the **vid <list of vids>**.

Variable definitions

Use the data in the following tables to use the **ip-tunnel-source-address** command.

To delete an IS-IS IP tunnel source address, use the **no ip-tunnel-source-address** option.

*** Note:**

The **port** parameter is for the VSP 4000 only.

*** Note:**

Variable	Value
<A.B.C.D>	Specifies the IS-IS IPv4 tunnel source address, which can be either a brouter interface IP or a CLIP IP.
port <slot/port>	Specifies the port that is connected to the ONA's Device port.
vrf WORD<1-16>	Specifies the VRF name associated with the IP tunnel.
mtu <750-1950>	Specifies the size of the maximum transmission unit (MTU). The default is 1950. This parameter only applies to an ONA configuration.

Use the data in one of the following tables to use the `logical-intf isis` command, depending on whether you have a Layer 2 or Layer 3 core.

To delete a logical IS-IS interface, use the `no logical-intf isis` option.

Table 5: Layer 2 core

Variable	Value
<1–255>	Specifies the index number that uniquely identifies this logical interface.
port {slot/port[/sub-port] [-slot/port[/sub-port]] [,...]}	Specifies the physical port that the logical interface is connected to in a Layer 2 network.
vid <list of vids>	Specifies the list of VLANs that are associated with this logical interface.
primary-vid <2–4059>	Specifies the primary tunnel VLAN ID associated with this Layer 2 IS-IS logical interface.
mlt <mltid>	Specifies the MLT ID that the logical interface is connected to in a Layer 2 network.
name WORD<1–16>	Specifies the administratively-assigned name of this logical interface, which can be up to 16 characters.

Table 6: Layer 3 core

Variable	Value
<1–255>	Specifies the index number that uniquely identifies this logical interface.
dest-ip <A.B.C.D>	Specifies the tunnel destination IP address of the remote BEB.
name WORD<1–16>	Specifies the administratively-assigned name of this logical interface, which can be up to 16 characters.

Displaying IS-IS logical interfaces

Use the following procedure to display the IS-IS logical interfaces configured on the switch.

Procedure

Display the IS-IS logical interfaces:

```
show isis logical-interface [name]
```

Examples

Example of a Layer 2 Core:

```
Switch:1# show isis logical-interface
=====
ISIS Logical Interfaces
=====
IFIDX  NAME      ENCAP      L2_INFO      TUNNEL      L3_TUNNEL_NEXT_HOP_INFO
      TYPE      PORT/MLT  VIDS (PRIMARY)  DEST-IP      PORT/MLT      VLAN      VRF
=====
```

SPBM and IS-IS infrastructure configuration

```
1      --      L2-P2P-VID      Port2/40  101,201 (101)  --      --      --      --
2      --      L2-P2P-VID      Port1/3   102,202 (102)  --      --      --      --
-----
2 out of 2 Total Num of Logical ISIS interfaces
-----
```

Example of a Layer 3 Core:

```
Switch:1# show isis logical-interface
=====
ISIS Logical Interfaces
=====
IFIDX  NAME      ENCAP      L2_INFO      TUNNEL      L3_TUNNEL_NEXT_HOP_INFO
      TYPE      PORT/MLT  VIDS (PRIMARY)  DEST-IP      PORT/MLT  VLAN  VRF
-----
1      SPBoIP_T1  IP         --           --          41.41.41.41  MLT10  2    vrf24
2      SPBoIP_T2  IP         --           --          42.42.42.42  MLT10  2    vrf24
3      SPBoIP_4K5 IP         --           --          187.187.187.187 MLT10  2    vrf24
-----
3 out of 3 Total Num of Logical ISIS interfaces
-----
```

Display the IS-IS logical interface names.

```
Switch:1# show isis logical-interface name
=====
ISIS Logical Interface name
=====
ID      NAME
-----
1      SPBoIP_T1
2      SPBoIP_T2
3      SPBoIP_4K5
-----
3 out of 3 Total Num of Logical ISIS interfaces
-----
```

The command **show isis logical-interface** truncates the IS-IS logical interface name to the first 16 characters. To view the entire name (up to a maximum of 64 characters), use the command **show isis logical-interface name**.

For example:

```
Switch:1# show isis logical-interface name
=====
ISIS Logical Interface name
=====
ID      NAME
-----
6      This_Is_A_50_Character_ISIS_Logical_Interface_Name
-----
1 out of 1 Total Num of Logical ISIS interfaces
-----
```

Job Aid

The following table describes the fields in the output for the **show isis logical interface** command.

Parameter	Description
IFIDX	Specifies an index value for this logical interface.
NAME	Specifies the administratively-assigned name of this logical interface, which can be up to 16 characters.
ENCAP TYPE	Specifies whether the encapsulation type for the logical interface is Layer 2 (L2-P2P-VID) or Layer 3 (IP).
L2_INFO PORT/MLT	Specifies the port or MLT that the logical interface is connected to in an L2 network.
L2_INFO VLAN	Specifies the list of VLANs that are associated with this L2 logical interface.
TUNNEL DEST-IP	Specifies the destination IP address for the logical interface.
L3_TUNNEL_NEXT_HOP_INFO PORT/MLT	Specifies the outgoing interface (port or MLT) for VXLAN traffic.
L3_TUNNEL_NEXT_HOP_INFO VLAN	Specifies the outgoing VLAN interface for VXLAN traffic.
L3_TUNNEL_NEXT_HOP_INFO VRF	Specifies the name of the VRF that this L3 logical interface is configured on.

Displaying KHI Fabric Extend ONA Status

About this task

* Note:

This feature only applies to platforms that have an Open Networking Adapter (ONA) connected to it.

Use the following command to display the current status of the Fabric Extend ONA, which includes release information.

Procedure

1. Enter Privileged EXEC mode:

```
enable
```

2. Display the ONA status:

```
show khi fe-ona status
```

Example

The following output displays the `show khi fe-ona status` when the ONA is operating normally.

```
Switch:1#show khi fe-ona status
```

```
=====
```

```

=====
                        ONA STATUS
=====
ONA Device Status : UP
Running Release Name : v1.0.0.0int006-3-g9749735-dirty
Last Image Upgrade Status : UPGRADE_SUCCESS
Last Image File Used For Upgrde: gdb-secure_ona.tgz
=====

```

The following examples display the output when communication from the switch to the ONA is disrupted. Note that the ONA Down reason lists the cause of the failure. The reason changes depending on the context of the failure.

The following output displays when the configuration push from the switch to the ONA fails:

```

Switch:1#show khi fe-ona status
=====
                        ONA STATUS
=====
ONA Device Status : DOWN
ONA DOWN reason : ONA_CONFIG_DOWNLOAD_FAILED
Running Release Name :
Image Upgrade Status : UNKNOWN
=====

```

The following output displays when the port connecting to the ONA device port is DOWN:

```

Switch:1#show khi fe-ona status
=====
                        ONA STATUS
=====
ONA Device Status : DOWN
ONA DOWN reason : ONA_DEVICE_PORT_DOWN
Running Release Name :
Image Upgrade Status : UNKNOWN
Image File Is Being Used For Upgrade :
=====

```

The following output displays when the switch is not receiving LLDP packets from the ONA:

```

Switch:1#show khi fe-ona status
=====
                        ONA STATUS
=====
ONA Device Status : DOWN
ONA DOWN reason : ONA_LLDP_TIMEOUT
Running Release Name :
Image Upgrade Status : UNKNOWN
=====

```

*** Note:**

On the switch console, the following log message precedes all three of the above cases:

```

CP1 [03/22/71 09:30:15.336:UTC] 0x00378601 00000000 GlobalRouter ONA
WARNING ONA device status detected down

```

Displaying KHI Fabric Extend ONA Global Information

About this task

* Note:

This feature only applies to platforms that have an Open Networking Adapter (ONA) connected to it.

Use the following command to display Fabric Extend ONA global information such as port numbers, IP addresses, and MTU.

Procedure

1. Enter Privileged EXEC mode:

```
enable
```

2. Display the ONA global information:

```
show khi fe-ona detail
```

Example

```
Switch:1#show khi fe-ona detail
=====
                        ONA RUNTIME INFORMATION
=====
ONA Port Number : 1/15
ONA Management Address : 100.1.1.11
Tunnel Source IP Address : 198.51.100.11
ONA LLDP Port Status : Enabled
ONA Device Port Status : UP
ONA Device Status : UP
MTU : 1000
ONA Network Port Number : 1/35
ONA Mac(ARP) Address : 10:cd:ae:69:b6:50
ONA Source VlanId : 1050
ONA Source VlanIP : 192.0.2.1
ONA Gateway IP : 192.0.2.1
ONA Management IP Mask : 255.255.255.0
ONA Bootmode : 1
ONA Uptime : 0 day(s), 00:00:00
pbit-to-dscp-map p0=16 p1=20 p2=24 p3=30 p4=36 p5=40 p6=48 p7=46
=====
```

* Note:

In the above example, the switch receives LLDP packets with the Management IP address of the ONA over the ONA Port (1/15). The switch extracts the ONA Management IP from the LLDP packet and resolves the ARP of the ONA over the network port (1/35). After the switch resolves the ARP of the ONA IP, the `show khi fe-ona detail` updates the following details:

- ONA Network Port Number
- ONA Mac(ARP) Address
- ONA Source VlanId

Note the following in regard to the `show khi fe-ona detail` output shown above:

- ONA Source VlanIP : 192.0.2.1—This is the IP address of the switch VLAN that switches traffic to the ONA network port. In the above output, this is VLAN 1050.
- ONA Gateway IP : 192.0.2.1—This is the ONA gateway IP address that the switch gets by querying the ONA. The ONA receives this gateway IP from the DHCP server.

 **Important:**

The ONA Source VlanIP, and ONA Gateway IP addresses must be the same for the tunnels to come up and the traffic to switch.

Fabric Attach configuration using the CLI

The following sections provide procedural information you can use to configure Fabric Attach (FA) and Logical Link Discovery Protocol (LLDP) using the Command Line Interface (CLI).

Configuring Fabric Attach globally

For proper operation, FA must be enabled at both the global level and at the interface level on the FA Server. By default, FA is globally enabled. However, FA is disabled by default at the interface level and must be explicitly enabled on each interface.

Use this procedure to enable Fabric Attach globally on a switch.

Procedure

1. Enter Global Configuration mode:

```
enable
configure terminal
```

2. Enable FA:

```
fa enable
```

3. **(Optional)** Disable FA:

```
no fa enable
```

 **Caution:**

Disabling FA flushes all FA element discovery and mappings.

4. View the FA configuration status. Use one of the following commands:

- `show fa`
- `show fa agent`

Example

```
Switch:1>en
Switch:1#conf t
Enter configuration commands, one per line. End with CNTL/Z.
```

```

Switch:1(config)#fa enable
Switch:1(config)#show fa

=====
Fabric Attach Configuration
=====
FA Service : enabled
FA Element Type : server
FA Assignment Timeout : 240
FA Discovery Timeout : 240
FA Provision Mode : spbm

Switch:1(config)#show fa agent

=====
Fabric Attach Configuration
=====
FA Service : enabled
FA Element Type : server
FA Assignment Timeout : 240
FA Discovery Timeout : 240
FA Provision Mode : spbm

```

Configuring Fabric Attach discovery timeout

Use this procedure to configure the Fabric Attach discovery time-out.

Procedure

1. Enter Global Configuration mode:

```
enable
configure terminal
```

2. Configure the FA discovery time-out in seconds:

```
fa discovery-timeout <45-480>
```

*** Note:**

The discovery time-out must be greater than or equal to the assignment time-out.

3. **(Optional)** Configure the default FA discovery time-out:

```
default fa discovery-timeout
```

Example

Configure the FA discovery time-out.

```

Switch:1>en
Switch:1#conf t
Enter configuration commands, one per line. End with CNTL/Z.
Switch:1(config)#fa discovery-timeout 50

```

Verify the configuration.

```

Switch:1(config)#show fa

=====
Fabric Attach Configuration

```

```

=====
                FA Service : enabled
                FA Element Type : server
FA Assignment Timeout : 45
                FA Discovery Timeout : 50
                FA Provision Mode : spbm
=====
    
```

Variable definitions

Use the data in the following table to use the **fa discovery-timeout** command.

Variable	Value
<45-480>	Specifies the Fabric Attach discovery time-out in seconds. The default value is 240 seconds.

Configuring Fabric Attach assignment timeout

Use this procedure to configure the Fabric Attach assignment time-out.

Procedure

1. Enter Global Configuration mode:

```
enable
configure terminal
```
2. Configure the FA assignment time-out in seconds:

```
fa assignment-timeout <45-480>
```

*** Note:**

The assignment time-out must be less than or equal to the discovery time-out.

3. **(Optional)** Configure the default FA assignment time-out value:

```
default fa assignment-timeout
```

Example

Configure the FA assignment time-out:

```

Switch:1>en
Switch:1#conf t
Enter configuration commands, one per line. End with CNTL/Z.
Switch:1(config)#fa assignment-timeout 50
    
```

Verify the configuration:

```

Switch:1(config)#show fa

=====
                Fabric Attach Configuration
=====
                FA Service : enabled
                FA Element Type : server
FA Assignment Timeout : 50
                FA Discovery Timeout : 240
                FA Provision Mode : spbm
    
```

Variable definitions

Use the data in the following table to use the `fa assignment-timeout` command.

Variable	Value
<45-480>	Specifies the Fabric Attach assignment time-out in seconds. The default value is 240 seconds.

Enabling Fabric Attach on an interface

Use this procedure to enable Fabric Attach on an interface (port, static MLT or LACP MLT). Enabling FA on an MLT enables FA on all ports of the MLT. If your platform supports channelization, FA can also be enabled on channelized ports.

Before you begin

Verify that FA is enabled globally on the switch.

About this task

Enabling FA on a port or MLT is necessary for element discovery.

On the FA Server, FA is enabled globally by default. However, you must explicitly enable FA on the desired port or MLT interface. FA is successfully enabled on an MLT only if all ports of the MLT have FA successfully enabled. Enabling FA automatically configures LLDP on all ports. Tagging is configured and spanning tree is disabled.

Procedure

1. Enter Interface Configuration mode:

```
enable
configure terminal
interface GigabitEthernet {slot/port[/sub-port] [-slot/port[/sub-port]][, ...]} or interface mlt <1-512>
```

 **Note:**

If your platform supports channelization and the port is channelized, you must also specify the sub-port in the format slot/port/sub-port.

2. Enable FA on the interface:

```
fa enable
```

3. **(Optional)** Disable FA on the interface:

```
no fa enable
```

 **Caution:**

Disabling FA flushes all FA element discovery and I-SID-to-VLAN mappings associated with the interface.

4. View the FA configuration status:

```
show fa interface [disabled-auth] [enabled-auth] [mlt <1-512>] [port
<{slot/port[/sub-port] [-slot/port[/sub-port]] [,...]}>]
```

Example

Enable FA on a port:

```
Switch:1>en
Switch:1#conf t
Enter configuration commands, one per line. End with CNTL/Z.
Switch:1(config)#interface gigabitethernet 1/2
Switch:1(config-if)#fa enable
Switch:1(config-if)#exit
Switch:1(config)#
```

Enable FA on an MLT:

```
Switch:1>en
Switch:1#conf t
Enter configuration commands, one per line. End with CNTL/Z.
Switch:1(config)#interface mlt 10
Switch:1(config-mlt)#fa enable
Switch:1(config-mlt)#exit
Switch:1(config)#
```

Verify that FA is enabled on the interfaces.

*** Note:**

When FA is enabled, message authentication is enabled by default. The authentication key is set to the default value and appears encrypted on the output.

```
Switch:1(config)#show fa interface
=====
Fabric Attach Interfaces
=====
INTERFACE      SERVER  MGMT    MGMT    MSG AUTH  MSG AUTH
STATUS         ISID    CVID    STATUS    KEY
-----
Port1/1        enabled  0        0        enabled   ****
Port1/2        enabled  0        0        enabled   ****
Mlt1           enabled  0        0        enabled   ****
Mlt10          enabled  0        0        enabled   ****
-----
4 out of 4 Total Num of fabric attach interfaces displayed
=====
```

For example, disable FA on port 1/1 and Mlt1.

```
Switch:1(config)#interface gigabitethernet 1/1
Switch:1(config-if)#no fa enable
Switch:1(config-if)#exit
Switch:1(config)#interface mlt 1
Switch:1(config-mlt)#no fa enable
Switch:1(config-mlt)#exit
```

Verify that FA is disabled on port 1/1 and Mlt1.

```
Switch:1(config)#show fa interface
=====
Fabric Attach Interfaces
=====
```



```
=====
INTERFACE      SERVER  MGMT   MGMT   MSG AUTH  MSG AUTH
                STATUS ISID   CVID   STATUS    KEY
-----
Port1/1        disabled 0      0      enabled   ****
Port1/2        enabled  0      0      enabled   ****
Mlt1           disabled 0      0      enabled   ****
Mlt10          enabled  0      0      enabled   ****
-----
4 out of 4 Total Num of fabric attach interfaces displayed
=====
```

View the FA interfaces that have authentication enabled:

```
Switch:1(config)#show fa interface enabled-auth

=====
                          Fabric Attach Interfaces
=====
INTERFACE      SERVER  MGMT   MGMT   MSG AUTH  MSG AUTH
                STATUS ISID   CVID   STATUS    KEY
-----
Port1/2        enabled 0      0      enabled   ****
Mlt10          enabled 0      0      enabled   ****
-----
2 out of 2 Total Num of fabric attach interfaces displayed
=====
```

Optionally, disable FA message authentication on 1/1 and Mlt1.

```
Switch:1(config)#interface gigabitethernet 1/1
Switch:1(config-if)#no fa message-authentication
Switch:1(config-if)#exit
Switch:1(config)#interface mlt 1
Switch:1(config-mlt)#no fa message-authentication
Switch:1(config-mlt)#exit
```

Verify that both FA and FA message authentication are disabled on 1/1 and Mlt1, as indicated by the SERVER STATUS and MSG AUTH STATUS fields respectively.

```
Switch:1(config)#show fa interface

=====
                          Fabric Attach Interfaces
=====
INTERFACE      SERVER  MGMT   MGMT   MSG AUTH  MSG AUTH
                STATUS ISID   CVID   STATUS    KEY
-----
Port1/1        disabled 0      0      disabled  ****
Port1/2        enabled  0      0      enabled   ****
Mlt1           disabled 0      0      disabled  ****
Mlt10          enabled  0      0      enabled   ****
-----
4 out of 4 Total Num of fabric attach interfaces displayed
=====
```

View the FA interfaces that have authentication disabled:

```
Switch:1(config)#show fa interface disabled-auth

=====
                          Fabric Attach Interfaces
=====
INTERFACE      SERVER  MGMT   MGMT   MSG AUTH  MSG AUTH
                STATUS ISID   CVID   STATUS    KEY
-----
```

```
-----
Port1/1      disabled 0      0      disabled ****
Mlt1        disabled 0      0      disabled ****
-----
2 out of 2 Total Num of fabric attach interfaces displayed
-----
```

Variable definitions

Use the data in the following table to use the `show fa interface` command.

Variable	Value
disabled-auth	Displays the FA interfaces (port or MLT) that have authentication disabled.
enabled-auth	Displays the FA interfaces (port or MLT) that have authentication enabled.
<1-512>	The valid range for MLT ID. Displays FA configuration on the specified MLT interface.
port {slot/port[/sub-port] [-slot/port[/sub-port]] [...]}	Identifies the slot and port in one of the following formats: a single slot and port (slot/port), a range of slots and ports (slot/port-slot/port), or a series of slots and ports (slot/port,slot/port,slot/port). If your platform supports channelization and the port is channelized, you must also specify the sub-port in the format slot/port/sub-port. Displays FA configuration on the specified port.

Configuring FA message authentication on an interface

Use this procedure to configure FA message authentication on an interface (port or MLT).

Procedure

1. Enter Interface Configuration mode:

```
enable
configure terminal
interface GigabitEthernet {slot/port[/sub-port] [-slot/port[/sub-port]] [, ...]} or interface mlt <1-512>
```

*** Note:**

If your platform supports channelization and the port is channelized, you must also specify the sub-port in the format slot/port/sub-port.

2. Configure FA message authentication on a port or MLT:

```
[default] [no] fa message-authentication
```

*** Note:**

When FA is enabled, message authentication is enabled by default. The authentication key is set to the default value and appears encrypted on the output.

Example

```
Switch:1>en
Switch:1#conf t
Enter configuration commands, one per line. End with CNTL/Z.
Switch:1(config)#
```

Enable message authentication on a port.

```
Switch:1(config)#interface gigabitEthernet 1/2

Switch:1(config-if)#fa message-authentication
Switch:1(config-if)#show fa interface port 1/2

=====
                          Fabric Attach Interfaces
=====
INTERFACE      SERVER  MGMT   MGMT   MSG AUTH MSG AUTH
                STATUS ISID   CVID   STATUS   KEY
-----
Port1/2        enabled  0      0      enabled  ****

-----
1 out of 1 Total Num of fabric attach interfaces displayed
-----
Switch:1(config-if)#exit
Switch:1(config)#
```

Enable message authentication on an MLT.

```
Switch:1(config)#interface mlt 10
Switch:1(config-mlt)#fa message-authentication
Switch:1(config-mlt)#show fa interface mlt 10

=====
                          Fabric Attach Interfaces
=====
INTERFACE      SERVER  MGMT   MGMT   MSG AUTH MSG AUTH
                STATUS ISID   CVID   STATUS   KEY
-----
Mlt10          enabled  0      0      enabled  ****

-----
1 out of 1 Total Num of fabric attach interfaces displayed
-----
Switch:1(config-mlt)#exit
Switch:1(config)#
```

The following example demonstrates disabling message authentication on a port or MLT.

```
Switch:1(config)#interface gigabitEthernet 1/2
Switch:1(config-if)#no fa message-authentication
Switch:1(config-if)exit
Switch:1(config)
Switch:1(config)#interface mlt 10
Switch:1(config-mlt)#no fa message-authentication

Switch:1(config-mlt)#show fa interface

=====
                          Fabric Attach Interfaces
=====
INTERFACE      SERVER  MGMT   MGMT   MSG AUTH MSG AUTH
                STATUS ISID   CVID   STATUS   KEY
-----
Port1/2        enabled  0      0      disabled ****
```

```
Mlt10      enabled  0      0      disabled ****
-----
2 out of 2 Total Num of fabric attach interfaces displayed
-----
```

Configuring the FA authentication key on an interface

On the FA Server, you can configure an authentication key on an interface (port, static MLT or LACP MLT), to authenticate a client or proxy device on that interface. The authentication key is stored in encrypted form when you save configuration on the FA Server.

Before you begin

Ensure that:

- On the FA Server, FA is enabled globally and also on the interface.
- FA message authentication is enabled on the interface.

Note:

By default, enabling FA enables message authentication. The authentication key is set to the default value and appears encrypted on the output.

About this task

Use this procedure to configure an FA authentication key on a specified port or on all ports of an MLT, on the switch. If you do not configure an authentication key, the default value is used. If you specify a key, the default value is overridden and is stored in encrypted format in a separate file other than the configuration file, when you execute the `save config` command.

Caution:

For an FA Client or an FA Proxy device to successfully authenticate and attach to the FA Server, the authentication key *must* match on both the client and the server. If the authentication key is changed on the FA Server switch, it must correspondingly be changed on the FA Client or Proxy attached to it, for FA to operate properly.

Procedure

1. Enter Interface Configuration mode:

```
enable
configure terminal
interface GigabitEthernet {slot/port[/sub-port] [-slot/port[/sub-port]] [, ...]} or interface mlt <1-512>
```

Note:

If your platform supports channelization and the port is channelized, you must also specify the sub-port in the format slot/port/sub-port.

2. Configure the FA authentication key:

```
fa authentication-key WORD<0-32>
```

3. **(Optional)** Configure the default FA authentication key:

```
default fa authentication-key
```

Example

```
Switch:1>en
Switch:1#conf t
Enter configuration commands, one per line. End with CNTL/Z.
```

Enable FA and message authentication on a port. Configure the authentication key `phone-network` on the port.

```
Switch:1(config)#interface gigabitEthernet 1/2
Switch:1(config-if)#fa enable
Switch:1(config-if)#fa message-authentication
Switch:1(config-mlt)#fa authentication-key phone-network
Switch:1(config-if)#exit
Switch:1(config)#
```

Enable FA and message authentication on an MLT. Configure the authentication key `client-network` on the MLT.

```
Switch:1(config)#interface mlt 10
Switch:1(config-mlt)#fa enable
Switch:1(config-mlt)#fa message-authentication
Switch:1(config-mlt)#fa authentication-key client-network
```

Verify configuration of the FA authentication key. The authentication key appears encrypted on the output.

```
Switch:1(config-if)#show fa interface

=====
                          Fabric Attach Interfaces
=====
INTERFACE      SERVER  MGMT   MGMT   MSG AUTH  MSG AUTH
                STATUS ISID   CVID   STATUS    KEY
-----
Port1/2        enabled  0      0      enabled   ****
MLT10          enabled  0      0      enabled   ****

-----
2 out of 2 Total Num of fabric attach interfaces displayed
-----
```

Variable Definitions

Use the data in the following table to use the `fa authentication-key` command.

Variable	Value
WORD<0–32>	Specifies the authentication key on the port or MLT.

Configuring FA management on a port or MLT

Use this procedure to configure a management I-SID on an FA enabled port or MLT on the switch.

Before you begin

Ensure that the port or MLT is enabled for Fabric Attach.

About this task

This command applies to all traffic sent or received on a port or MLT, carrying the VLAN ID specified using the `c-vid` parameter. This parameter is optional.

Depending on whether the `c-vid` parameter is specified or not, the behavior is as follows:

- If the `c-vid` parameter is specified, the FA Server transmits this VLAN ID as the management VLAN in the FA Element TLV. A client or proxy receiving this TLV uses this VLAN-ID for management traffic on the FA Server uplink.
- If the `c-vid` parameter is *not* specified, the FA Server transmits a management VLAN with a VLAN ID value of 4095 in the FA Element TLV. A client or proxy receiving this TLV uses **untagged** traffic for network management on the FA Server uplink.

Procedure

1. Enter Interface Configuration mode:

```
enable
configure terminal
interface GigabitEthernet {slot/port[/sub-port] [-slot/port[/sub-port]] [,...]} or interface mlt <1-512>
```

* Note:

If your platform supports channelization and the port is channelized, you must also specify the sub-port in the format slot/port/sub-port.

2. Configure the FA management I-SID:

```
fa management i-sid <1-16777215> [c-vid <1-4094>]
```

! Important:

If you do not specify a C-VID value, the port or MLT is **untagged**.

3. Delete FA management I-SID on a port or MLT using one of the following commands:

- `default fa management i-sid`
- `no fa management i-sid`

4. Verify configuration of FA management on the port or MLT, using the following commands:

- `show i-sid [<1-16777215>]`
- `show interfaces gigabitEthernet i-sid [{slot/port[/sub-port]} [-slot/port[/sub-port]] [,...]]`
- `show mlt i-sid [<1-512>]`

Example

The following example demonstrates configuring FA management on the port 1/2.

Configure FA management on port 1/2:

```
Switch:1>en
Switch:1#conf t
```

```
Enter configuration commands, one per line. End with CNTL/Z.
Switch:1(config)#interface gigabitEthernet 1/2
Switch:1(config-if)#fa management i-sid 101 c-vid 101
```

```
Switch:1(config-if)#show i-sid 101
```

```
=====
Isid Info
=====
```

ISID ID	ISID TYPE	VLANID	PORT INTERFACES	MLT INTERFACES	ORIGIN
101	ELAN	N/A	c101:1/2	-	MANAGEMENT

```
Switch:1(config-if)#show interfaces gigabitEthernet i-sid
```

```
=====
PORT Isid Info
=====
```

PORTNUM	IFINDEX	ISID ID	VLANID	C-VID	ISID TYPE	ORIGIN	BPDU
1/2	193	101	N/A	101	ELAN	MANAGEMENT	

```
1 out of 1 Total Num of i-sid endpoints displayed
```

The following example demonstrates configuring FA management on an MLT.

Configure FA management on MLT 10.

```
Switch:1>en
Switch:1#conf t
Enter configuration commands, one per line. End with CNTL/Z.
Switch:1(config)#interface mlt 10
Switch:1(config-mlt)#fa management i-sid 100
```

Verify configuration of FA management on the MLT. Since the C-VID is not specified, the MLT is displayed as untagged.

```
Switch:1(config-mlt)#show i-sid 100
```

```
=====
Isid Info
=====
```

ISID ID	ISID TYPE	VLANID	PORT INTERFACES	MLT INTERFACES	ORIGIN
100	ELAN	N/A	-	u:10	MANAGEMENT

An FA management I-SID can have a platform VLAN associated with it. For Layer 3 support on the management I-SID, you must create a platform VLAN by port and associate the platform VLAN with the management I-SID. The C-VID can be of the same value or of a different value than that of the platform VLAN.

If the management I-SID matches one of the FA Switched UNI (ELAN) I-SIDs (as displayed by the command `show i-sid elan`), then the platform VLAN is automatically associated with the FA enabled interface (port or MLT).

In the following example, for Layer 3 support, create a platform VLAN 999 and associate it with the management I-SID 101.

```
Switch:1(config-if)#vlan create 999 type port-mstprstp 0
Switch:1(config-if)#vlan i-sid 999 101
```

```
Switch:1(config-if)#show i-sid
=====
Isid Info
=====
ISID      ISID      PORT      MLT      ORIGIN
ID        TYPE      VLANID    INTERFACES  INTERFACES
-----
101      ELAN      999      c101:1/2    -          MANAGEMENT
c: customer vid      u: untagged-traffic
All 1 out of 1 Total Num of i-sids displayed
```

```
Switch:1(config-if)#show vlan i-sid
=====
Vlan I-SID
=====
VLAN_ID  I-SID
-----
999      101
1 out of 1 Total Num of Vlans displayed
```

Since the management I-SID matches one of the FA Switched UNI (ELAN) I-SIDs, the platform VLAN is automatically associated with the FA enabled port 1/2.

```
Switch:1(config-if)#show interfaces gigabitEthernet i-sid
=====
PORT Isid Info
=====
PORTNUM  IFINDEX  ISID      VLANID  C-VID  ISID      ORIGIN      BPDU
-----
1/2      193     101      999     101    ELAN      MANAGEMENT
1 out of 1 Total Num of i-sid endpoints displayed
```

Variable Definitions

Use the data in the following table to use the **fa management** command.

Variable	Value
i-sid <1-16777215>	Specifies the management I-SID
c-vid <1-4094>	Specifies the C-VID value of the port or MLT on the FA Server.  Important: If you do not specify a C-VID value, the port or MLT is untagged .

Viewing Fabric Attach global configuration status

Use this procedure to display the Fabric Attach global configuration status on a switch.

Procedure

1. Enter Privileged EXEC mode:
enable
2. Display the FA configuration status using one of the following commands:
 - show fa
 - show fa agent

Example

Sample output for the **show fa** command:

```
Switch:1#show fa
=====
                        Fabric Attach Configuration
=====
                        FA Service : enabled
                        FA Element Type : server
FA Assignment Timeout : 240
FA Discovery Timeout  : 240
FA Provision Mode     : spbm
```

Sample output for the **show fa agent** command:

```
Switch:1#show fa agent
=====
                        Fabric Attach Configuration
=====
                        FA Service : enabled
                        FA Element Type : server
FA Assignment Timeout : 240
FA Discovery Timeout  : 240
FA Provision Mode     : spbm
```

Viewing Fabric Attach interface configuration

Use this procedure to view FA interface configuration.

Procedure

1. Enter Privileged EXEC mode:
enable
2. View all FA interfaces (ports and MLTs):
show fa interface
3. To view FA interface configuration on ports, use one of the following commands:
 - View FA configuration on all ports:
show fa interface port
 - View FA configuration on a specific port, enter:
show fa interface port [{slot/port[/sub-port]} [-slot/port[/sub-port]] [,...]]

4. To view FA interface configuration on MLTs, use one of the following commands:

- View FA configuration on all MLTs:

```
show fa interface mlt
```

- View FA configuration on a specific MLT:

```
show fa interface mlt [<1-512>]
```

Example

The following example displays sample outputs for the **show fa interface** command.

```
Switch:1>en
Switch:1#show fa interface

=====
Fabric Attach Interfaces
=====
INTERFACE      SERVER  MGMT   MGMT   MSG AUTH  MSG AUTH
                STATUS ISID   CVID   STATUS    KEY
-----
Port2/10       enabled 0      0      enabled   ****
Port4/6        enabled 0      0      enabled   ****
Port4/11       enabled 0      0      enabled   ****
Mlt2           enabled 0      0      enabled   ****

-----
4 out of 4 Total Num of fabric attach interfaces displayed
-----
```

The following is a sample output for the **show fa interface** command for the port 2/10.

```
Switch:1#show fa interface port 2/10

=====
Fabric Attach Interfaces
=====
INTERFACE      SERVER  MGMT   MGMT   MSG AUTH  MSG AUTH
                STATUS ISID   CVID   STATUS    KEY
-----
Port2/10       enabled 0      0      enabled   ****

-----
1 out of 4 Total Num of fabric attach interfaces displayed
-----
```

The following is a sample output for the **show fa interface** command for the MLT 2.

```
Switch:1#show fa interface mlt 2

=====
Fabric Attach Interfaces
=====
INTERFACE      SERVER  MGMT   MGMT   MSG AUTH  MSG AUTH
                STATUS ISID   CVID   STATUS    KEY
-----
Mlt2           enabled 0      0      enabled   ****

-----
1 out of 4 Total Num of fabric attach interfaces displayed
-----
```

Variable definitions

Use the data in the following table to use the `show fa interface port` command.

Variable	Value
<code>{slot/port[/sub-port] [-slot/port[/sub-port]] [,...]}</code>	Identifies the slot and port in one of the following formats: a single slot and port (slot/port), a range of slots and ports (slot/port-slot/port), or a series of slots and ports (slot/port,slot/port,slot/port). If your platform supports channelization and the port is channelized, you must also specify the sub-port in the format slot/port/sub-port.

Use the data in the following table to use the `show fa interface mlt` command.

Variable	Value
<code><1-512></code>	The valid range for MLT ID.

Viewing Fabric Attach Discovered Elements

Use this procedure to view Fabric Attach discovered elements.

About this task

When FA is enabled on an FA Server switch, LLDP PDUs are exchanged between the FA Server and FA Clients or FA Proxies. Standard LLDPs allow neighbors to be learned. With the help of organizational-specific element discovery TLVs, the client or proxy recognizes that it has attached to the FA Server. Only after the discovery handshake is complete, an FA Client or FA Proxy can transmit I-SID-to-VLAN assignments to join the SPB Fabric network through the FA Server.

Procedure

1. Enter Privileged EXEC mode:

```
enable
```

2. Display FA discovered elements:

```
show fa elements
```

3. Display FA discovered elements on a specific port:

```
show fa elements [{slot/port[/sub-port] [-slot/port[/sub-port]] [,...]]
```

Example

The following example displays the sample output for the `show fa elements` command.

```
Switch:1#show fa elements
```

```
=====
Fabric Attach Discovery Elements
=====
PORT      TYPE      MGMT      ELEM ASGN
          VLAN STATE  SYSTEM ID AUTH AUTH
-----
1/5      proxy    710  T / S  50:61:84:ee:8c:00:20:00:00:01  AP  AP
1/6      proxy    710  T / S  50:61:84:ee:8c:00:20:00:00:01  AP  AP
```

```

=====
                          Fabric Attach Authentication Detail
=====
PORT      ELEM OPER                ASGN OPER
          AUTH STATUS        AUTH STATUS
-----
1/5      successAuth              successAuth
1/6      successAuth              successAuth

State Legend: (Tagging/AutoConfig)
T= Tagged,    U= Untagged,    D= Disabled,    S= Spbm,    V= Vlan,    I= Invalid

Auth Legend:
AP= Authentication Pass,  AF= Authentication Fail,
NA= Not Authenticated,  N= None
-----

2 out of 2 Total Num of fabric attach discovery elements displayed

```

Variable definitions

Use the data in the following table to use the `show fa elements` command.

Variable	Value
<code>{slot/port[/sub-port] [-slot/port[/sub-port]] [...]}</code>	Identifies the slot and port in one of the following formats: a single slot and port (slot/port), a range of slots and ports (slot/port-slot/port), or a series of slots and ports (slot/port,slot/port,slot/port). If your platform supports channelization and the port is channelized, you must also specify the sub-port in the format slot/port/sub-port.

Viewing Fabric Attach I-SID-to-VLAN Assignments

Use this procedure to display the I-SID-to-VLAN assignments advertised by an FA Client or an FA Proxy, to be supported on the FA Server. These assignments can be accepted or rejected by the FA Server. An assignment that is successfully accepted by the FA Server results in the creation of a Switched UNI I-SID on the interface.

Before you begin

Verify that IS-IS and SPBM are properly configured on the FA Server switch.

- Verify SPBM configuration using the command `show running-config module spbm`.
- Verify IS-IS configuration using one of the following commands:
 - `show isis`
 - `show isis interface`
 - `show isis adjacency`
 - `show isis lsdb`

Procedure

1. Enter Privileged EXEC mode:

```
enable
```

2. Display FA I-SID-to-VLAN assignments:

```
show fa assignment
```

3. Display FA I-SID-to-VLAN assignments on specific ports:

```
show fa assignment [{slot/port[/sub-port] [-slot/port[/sub-port]]
[,...]]
```

Example

The following example displays a sample output for the `show fa assignment` command.

*** Note:**

The state of I-SID-to-VLAN assignments on a client or proxy device is `pending` until it is changed by the FA Server to `active` or `reject`.

```
Switch:>en
Switch:1#show fa assignment
=====
Fabric Attach Assignment Map
=====
Interface  I-SID      Vlan      State      Origin
-----
1/1         2          2         active     proxy
1/2         3          3         active     proxy
1/2         4          4         active     proxy
1/3         5          5         reject     proxy
-----
4 out of 4 Total Num of fabric attach assignment mappings displayed
-----
```

Variable definitions

Use the data in the following table to use the `show fa assignment` command.

Variable	Value
<code>{slot/port[/sub-port] [-slot/port[/sub-port]] [,...]}</code>	Identifies the slot and port in one of the following formats: a single slot and port (slot/port), a range of slots and ports (slot/port-slot/port), or a series of slots and ports (slot/port,slot/port,slot/port). If your platform supports channelization and the port is channelized, you must also specify the sub-port in the format slot/port/sub-port.

Viewing Fabric Attach Statistics

If FA discovery fails, use this procedure to display FA statistics to determine if FA discovery TLVs were processed. You can also view the FA assignment statistics to determine the number of FA assignments that were accepted or rejected by the FA Server.

You can view the statistics at either the global level or at the port (interface) level.

Procedure

1. Enter Privileged EXEC mode:

enable

2. View global level FA statistics:

show fa statistics [summary]

3. View FA statistics at the slot/port level:

show fa statistics [{slot/port[/sub-port] [-slot/port[/sub-port]]
[,...]]

*** Note:**

If a slot is removed from the switch chassis, the FA statistics are not displayed on the slot ports. When the slot is inserted back again, the statistics counters are reset.

4. (Optional) Clear FA statistics:

clear fa statistics [summary] [{slot/port[/sub-port] [-slot/port[/sub-port]]
[,...]]

Examples

Viewing FA discovery and assignment statistics:

```
Switch:1>en
Switch:1#show fa statistics
```

```
=====
                          Fabric Attach STATISTICS
=====
```

Port	DiscElem Received	DiscElem Expired	DiscElem Deleted	DiscAuth Failed
1/1	3057	0	1	0
1/2	2000	0	1	0

```
=====
                          Fabric Attach ASSIGNMENTS STATISTICS
=====
```

Port	Asgn Received	Asgn Accepted	Asgn Rejected	Asgn Expired	Asgn Deleted	AsgnAuth Failed
1/1	3149	3	1	3	0	0
1/2	1500	0	1	2	0	0

View a summary of the FA discovery and assignment statistics:

```
Switch:1#show fa statistics summary
```

```
=====
                          Fabric Attach STATISTICS SUMMARY
=====
```

Port	DiscElem Received	DiscElem Expired	DiscElem Deleted	DiscAuth Failed
1/1	3057	0	1	0
1/2	2000	0	1	0

```
=====
                          Fabric Attach ASSIGNMENTS STATISTICS SUMMARY
=====
```

Port	Asgn Received	Asgn Accepted	Asgn Rejected	Asgn Expired	Asgn Deleted	AsgnAuth Failed
1/1	3149	3	1	3	0	0
1/2	1500	0	1	2	0	0

Viewing FA statistics on a specific port (port 1/1):

```
Switch:1>en
Switch:1#show fa statistics 1/1
```

```
=====
Fabric Attach STATISTICS
=====
```

Port	DiscElem Received	DiscElem Expired	DiscElem Deleted	DiscAuth Failed
1/1	3057	0	1	0

```
=====
Fabric Attach ASSIGNMENTS STATISTICS
=====
```

Port	Asgn Received	Asgn Accepted	Asgn Rejected	Asgn Expired	Asgn Deleted	AsgnAuth Failed
1/1	3149	3	1	3	0	0

Optionally, clear FA statistics and verify that the statistics are cleared.

```
Switch:1#clear fa statistics
Switch:1#show fa statistics
```

```
=====
Fabric Attach STATISTICS
=====
```

Port	DiscElem Received	DiscElem Expired	DiscElem Deleted	DiscAuth Failed
1/1	0	0	0	0
1/2	0	0	0	0

```
=====
Fabric Attach ASSIGNMENTS STATISTICS
=====
```

Port	Asgn Received	Asgn Accepted	Asgn Rejected	Asgn Expired	Asgn Deleted	AsgnAuth Failed
1/1	0	0	0	0	0	0
1/2	0	0	0	0	0	0

Variable Definitions

Use the data in the following table to use the `show fa statistics` command.

Variable	Value
summary	Displays a summary of Fabric Attach element discovery and assignment statistics at the global level.
{slot/port[/sub-port] [-slot/port[/sub-port]] [...]}	Identifies the slot and port in one of the following formats: a single slot and port (slot/port), a range of slots and ports (slot/port-slot/ [...])

Table continues...

Variable	Value
	port), or a series of slots and ports (slot/port,slot/port,slot/port). If your platform supports channelization and the port is channelized, you must also specify the sub-port in the format slot/port/sub-port.

Configuring global LLDP transmission parameters

Before you begin

- In the GigabitEthernet Interface Configuration mode, specify the LLDP port status as transmit only or transmit and receive.

About this task

Use this procedure to configure global LLDP transmission parameters on the switch. If required, you can also restore these parameters to their default values.

Procedure

1. Enter GigabitEthernet Interface Configuration mode:

```
enable

configure terminal

interface GigabitEthernet {slot/port[/sub-port] [-slot/port[/sub-
port]][, ...]}
```

* Note:

If your platform supports channelization and the port is channelized, you must also specify the sub-port in the format slot/port/sub-port.

2. To configure the LLDP transmission parameters, enter:

```
lldp [tx-interval|tx-hold-multiplier]
```

3. **(Optional)** To restore specific LLDP transmission parameters to their default values, enter:

```
default lldp [tx-interval|tx-hold-multiplier]
```

4. **(Optional)** To restore all LLDP transmission parameters to their default values, enter:

```
default lldp
```

Example

Configure the LLDP transmission interval. The LLDP port status is set to transmit and receive prior to the configuration.

```
Switch:1>enable
Switch:1#configure terminal
Switch:1(config)#interface GigabitEthernet 4/4
Switch:1(config-if)#lldp status txAndRx
Switch:1(config-if)#exit
Switch:1(config)#lldp tx-interval 31
```

Optionally, restore the LLDP transmission interval to its default value:

```
Switch:1>enable
Switch:1#configure terminal
Switch:1(config)#default lldp tx-interval
```

Variable definitions

Use the information in the following table to help you understand the `lldp` command.

Variable	Value
tx-interval<5–32768>	Specifies the global LLDP transmit interval in seconds, that is, the interval in which LLDP frames are transmitted. The default is 30 seconds.
tx-hold-multiplier <2–10>	Configures the multiplier for the transmit interval used to compute the Time To Live (TTL) value in LLDP frames. The default is 4 seconds.

Viewing global LLDP statistics

Use this procedure to view and verify global LLDP statistics.

Procedure

1. Enter Privileged EXEC mode:
`enable`
2. To view LLDP statistics, enter:
`show lldp stats`
3. To view LLDP reception statistics, enter:
`show lldp rx-stats`
4. To view LLDP transmission statistics, enter:
`show lldp tx-stats`
5. **(Optional)** Clear global LLDP statistics:
`clear lldp stats summary`

Example

View LLDP statistics:

```
Switch:1>enable
Switch:1#show lldp stats
```

```
=====
LLDP Stats
=====
Inserts   Deletes   Drops     Ageouts
=====
```

```
0          0          0          0
```

View LLDP transmission statistics:

```
Switch:1#show lldp tx-stats
```

```
=====
                                LLDP Tx-Stats
=====
PORT NUM                FRAMES
-----
1/2                      100
```

View LLDP reception statistics:

```
Switch:1#show lldp rx-stats
```

```
=====
                                LLDP Rx-Stats
=====
Port   Frames   Frames   Frames   TLVs     TLVs     AgeOuts
Num    Discarded Errors   Total   Discarded Unrecognized
-----
1/2    0        0        46      0        0        0
```

Viewing Port-based LLDP Statistics

Use this procedure to verify port-based LLDP statistics.

About this task

LLDP operates at the interface level. Enabling FA on a port automatically enables LLDP transmission and reception on the port. It also enables traffic tagging and disables spanning tree on that port.

Enabling FA on an MLT enables LLDP transmission and reception on *all* ports in the MLT.

* Note:

When FA is enabled on ports in an MLT or LACP MLT, tagging is enabled and spanning tree is disabled on those ports.

When a port is removed from an MLT, LLDP transmission on that port stops and spanning tree is enabled. Any I-SID-to-VLAN mappings on that port are removed, if not already learned on any other port in the MLT. This also causes the Switched UNI I-SID to be deleted from the MLT. If however, the mappings are learned on another port on the MLT, then the Switched UNI I-SID continues to exist for that MLT.

Procedure

1. Enter Privileged EXEC mode:

```
enable
```

2. To verify successful LLDP transmission on a port, enter:

```
show lldp tx-stats port {slot/port[/sub-port] [-slot/port[/sub-
port]] [,...]}
```

- To verify that a port receives LLDP PDUs successfully, enter:

```
show lldp rx-stats port {slot/port[/sub-port] [-slot/port[/sub-port]] [,...]}
```

- (Optional)** To clear LLDP statistics on a port, or ports, enter:

```
clear lldp stats {slot/port[/sub-port] [-slot/port[/sub-port]] [,...]}
```

Example

Verify LLDP transmission statistics on a port:

```
Switch:1>en
Switch:1#show lldp tx-stats port 1/2
=====
LLDP Tx-Stats
=====
PORT NUM          FRAMES
-----
1/2                100
```

Verify that the port is receiving LLDP PDUs:

```
Switch:1#show lldp rx-stats port 1/2
=====
LLDP Rx-Stats
=====
Port Num          Frames Discarded  Frames Errors  Frames Total  TLVs Discarded (Non FA)  TLVs Unsupported (Non FA)  AgeOuts
-----
1/2                0                0                46            0                0                0
```

Variable Definitions

Use the data in the following table to use the `show lldp tx-stats` and the `show lldp rx-stats` commands.

Variable	Value
<code>{slot/port[/sub-port] [-slot/port[/sub-port]] [,...]}</code>	Identifies the slot and port in one of the following formats: a single slot and port (slot/port), a range of slots and ports (slot/port-slot/port), or a series of slots and ports (slot/port,slot/port,slot/port). If your platform supports channelization and the port is channelized, you must also specify the sub-port in the format slot/port/sub-port.

Displaying Learned LLDP Neighbors

Use this procedure to verify details of the LLDP neighbors learned.

Procedure

1. Enter Privileged EXEC mode:

```
enable
```

2. Verify details of LLDP neighbors learned:

```
show lldp neighbor
```

3. Verify details of LLDP neighbors learned on a specific port:

```
show lldp neighbor port {slot/port[/sub-port] [-slot/port[/sub-
port]] [,...]}
```

Example

The following example shows how two switches—an FA Server and an FA Proxy discover each other as LLDP neighbors. Switch A, which is the FA Server is an VSP 7200 Series switch (model 7254XSQ) and switch B which is the proxy device is an ERS 4826GTS switch.

The following examples shows neighbor discovery on non-channelized and channelized ports (if your platform supports channelization).

On the non-channelized port 1/1 on the FA Server, verify neighbor discovery of the proxy switch.

```
SwitchA:1>en
SwitchA:1#show lldp neighbor

=====
                          LLDP Neighbor
=====
Port: 1/1      Index    : 1                Time: 1 day(s), 04:03:52
               ChassisId: MAC Address      70:30:18:5a:05:00
               PortId   : MAC Address      70:30:18:5a:05:07
               SysName  :
               SysCap   : Br / Br
               PortDescr: Port 7
               SysDescr : Ethernet Routing Switch 4826GTS HW:10 FW:5.8.0.1 SW:v6.9.2.027

-----
Total Neighbors : 1

-----
Capabilities Legend: (Supported/Enabled)
B= Bridge,      D= DOCSIS,      O= Other,      R= Repeater,
S= Station,    T= Telephone,    W= WLAN,      r= Router
Switch:1(config)#
```

On the proxy switch, verify discovery of the FA Server switch.

```
SwitchB:1>en
SwitchB:1#show lldp neighbor

-----
                          LLDP neighbor
-----
Port: 7      Index: 71                Time: 12 days, 21:40:30
               ChassisId: MAC address      a4:25:1b:52:70:00
               PortId:   MAC address      a4:25:1b:52:70:04
               SysName:   BEB1-7254XSQ
               SysCap:    rB / rB          (Supported/Enabled)
               PortDesc:  Virtual Services Platform 7254XSQ - Gbic1000BaseT Port

1/1
```

```

SysDescr: VSP-7254XSQ (6.0.0.0_GA)
-----
Sys capability: O-Other; R-Repeater; B-Bridge; W-WLAN accesspoint; r-Router;
T-Telephone; D-DOCSIS cable device; S-Station only.
Total neighbors: 1
    
```

On the channelized port 1/1/1 on the FA Server switch, verify discovery of the proxy switch.

```

SwitchA:1>en
SwitchA:1#show lldp neighbor
-----
LLDP Neighbor
-----
Port: 1/1/1      Index      : 1                Time: 1 day(s), 04:03:52
                  ChassisId: MAC Address  70:30:18:5a:05:00
                  PortId   : MAC Address  70:30:18:5a:05:07
                  SysName   :
                  SysCap    : Br / Br
                  PortDescr : Port 7
                  SysDescr  : FA Proxy 4826GTS HW:10 FW:5.8.0.1 SW:v5.9.2.027
-----
Total Neighbors : 1
-----
Capabilities Legend: (Supported/Enabled)
B= Bridge,      D= DOCSIS,      O= Other,      R= Repeater,
S= Station,    T= Telephone, W= WLAN,      r= Router
Switch:1(config)#
    
```

Verify neighbor discovery on the proxy switch.

```

SwitchB:1>en
SwitchB:1#show lldp neighbor
-----
LLDP neighbor
-----
Port: 7          Index: 71          Time: 12 days, 21:40:30
                  ChassisId: MAC address  a4:25:1b:52:70:00
                  PortId:   MAC address  a4:25:1b:52:70:04
                  SysName:   BEB1-7254XSQ
                  SysCap:    rB / rB      (Supported/Enabled)
                  PortDesc:  Virtual Services Platform 7254XSQ - 40GbCR4-Channel Port
1/1/1
                  SysDescr:  VSP-7254XSQ (6.0.0.0_GA)
-----
Sys capability: O-Other; R-Repeater; B-Bridge; W-WLAN accesspoint; r-Router;
T-Telephone; D-DOCSIS cable device; S-Station only.
Total neighbors: 1
    
```

Variable Definitions

Use the data in the following table to use the `show lldp neighbor` command.

Variable	Value
port {slot/port[/sub-port] [-slot/port[/sub-port]] [...]}	Identifies the slot and port in one of the following formats: a single slot and port (slot/port), a range of slots and ports (slot/port-slot/port), or a series of slots and ports (slot/port,slot/port,slot/port). If your platform supports channelization and the port is

Variable	Value
	channelized, you must also specify the sub-port in the format slot/port/sub-port. Displays LLDP neighbor information on the specified port.

Displaying Switched UNI (ELAN) I-SID Information

Use this procedure to display information on FA-created Switched UNI (ELAN) I-SIDs.

Procedure

1. Enter Privileged EXEC mode:

```
enable
```

2. Display all Switched UNI (ELAN) I-SIDs:

```
show i-sid elan
```

3. Display ELAN I-SID information on an MLT:

```
show mlt i-sid [<1-512>]
```

*** Note:**

Viewing ELAN I-SID information on an MLT is useful to understand the origin of the I-SID when multiple client or proxy devices connecting to the FA Server using SMLT MLT advertise the *same* I-SID-to-VLAN mappings. In the event of a link failure on an MLT, the origin of the I-SID helps determine on which MLT, and thereby from which proxy or client device, the mappings were successfully learnt.

4. Display ELAN I-SID information on ports:

```
show interfaces gigabitEthernet i-sid [{slot/port[/sub-port]} [-slot/port[/sub-port]] [,...]]
```

Example

Display information on all Switched UNI (ELAN) I-SIDs.

The following sample output displays, for example, the I-SID information on one of the peer switches of the FA Server, in a dual-homed SMLT configuration.

```
Switch:1>en
Switch:1#show i-sid elan
```

```
=====
                          Isid Info
=====
```

ISID ID	ISID TYPE	VLANID	PORT INTERFACES	MLT INTERFACES	ORIGIN
2002	ELAN	N/A	c2002:1/10	-	DISC_LOCAL
4000	ELAN	N/A	-	c4000:1	DISC_BOTH
4001	ELAN	N/A	-	c4001:1	DISC_LOCAL
4030	ELAN	N/A	-	c4030:1	DISC_BOTH
4051	ELAN	N/A	-	c4051:1	DISC_BOTH

```

10200      ELAN      N/A      -      c200:1      DISC_REMOTE
c: customer vid      u: untagged-traffic
All 6 out of 6 Total Num of Elan i-sids displayed

```

*** Note:**

The I-SID TYPE field displays once for each I-SID. The I-SID TYPE of an I-SID that is either learned through FA mapping assignments or configured as an FA management I-SID, is always ELAN. If a platform VLAN has the same I-SID value as that of the I-SID in an FA mapping assignment or in an FA management I-SID configuration, then the platform VLAN is associated with the I-SID endpoint and appears in the VLANID column.

*** Note:**

- The ORIGIN field displays once for each I-SID. It indicates the origin of the I-SID and *not* the origin of the I-SID endpoint. To view the origin of the I-SID endpoints, execute either the `show mlt i-sid` or the `show interfaces gigabitEthernet i-sid` command.
 - The origin of I-SID 4000 displays as DISC_BOTH, because it is discovered on both vIST peers.
 - The origin of I-SID 4001 displays as DISC_LOCAL because it is first discovered on the local FA Server switch.
 - The origin of I-SID 10200 displays as DISC_REMOTE because it is first discovered on the peer switch and then synchronized with the local switch.
- If the origin of an I-SID is DISC_LOCAL, DISC_REMOTE, DISC_BOTH or MANAGEMENT, it changes to CONFIG, after you manually configure an endpoint on the I-SID.

Display MLT I-SID information for MLT 1.

In this sample output, the ORIGIN field indicates the origin of the I-SID endpoint.

```

Switch:1#show mlt i-sid 1
=====
MLT Isid Info
=====
MLTID  IFINDEX  ISID      VLANID  C-VID  ISID      ORIGIN      BPDU
      ID      TYPE
-----
1      6144     4000     N/A     4000   ELAN     DISC_BOTH
1      6144     4001     N/A     4001   ELAN     DISC_LOCAL
1      6144     4030     N/A     4030   ELAN     DISC_BOTH
1      6144     4051     N/A     4051   ELAN     DISC_BOTH
1      6144     10200    N/A     200    ELAN     DISC_REMOTE
=====
5 out of 6 Total Num of i-sid endpoints displayed

```

Display I-SID information on the port 1/10:

In this sample output, the ORIGIN field indicates the origin of the I-SID endpoint.

```

Switch:1#show interfaces gigabitEthernet i-sid 1/10

```

```

=====
                                PORT Isid Info
=====
PORTNUM  IFINDEX  ISID      VLANID  C-VID  ISID      ORIGIN      BPDU
         ID
-----
1/10     201      2002     N/A     601    ELAN      DISC_LOCAL
-----
1 out of 6 Total Num of i-sid endpoints displayed

```

Variable Definitions

Use the data in the following table to use the `show i-sid` command.

Variable	Value
elan	Displays all ELAN I-SIDs.

Use the data in the following table to use the `show mlt i-sid` command.

Variable	Value
<1-512>	The valid range for MLT ID.

Use the data in the following table to use the `show interfaces gigabitEthernet i-sid` command.

Variable	Value
<i>{slot/port[/sub-port] [-slot/port[/sub-port]] [,...]}</i>	Identifies the slot and port in one of the following formats: a single slot and port (slot/port), a range of slots and ports (slot/port-slot/port), or a series of slots and ports (slot/port,slot/port,slot/port). If your platform supports channelization and the port is channelized, you must also specify the sub-port in the format slot/port/sub-port.

Enabling or disabling FA Zero Touch Client Attachment

Use this procedure to enable or disable the global FA Zero Touch Client Attachment feature on an FA Proxy or Server. By default, FA Zero Touch Client Attachment support is enabled.

Procedure

1. Enter Global Configuration mode:

```
enable
configure terminal
```

2. Enable an FA Zero Touch client:

```
fa zero-touch-client standard <camera|ona-sdn|ona-spb-over-ip|phone|
router|security-device|srvr-endpt|switch|video|virtual-switch|wap-
type1|wap-type2> i-sid <1-16000000>
```

3. Disable an FA Zero Touch client:

```
no fa zero-touch-client standard <camera|ona-sdn|ona-spb-over-ip|
phone|router|security-device|srvr-endpt|switch|video|virtual-switch|
wap-type1|wap-type2>
```

Example

```
Switch:1(config)# fa zero-touch-client standard camera i-sid 1003
```

```
Switch:1(config)# no fa zero-touch-client standard camera
```

Variable definitions

Use the data in the following table to use the **fa zero-touch-client standard** command.

Variable	Value
camera	Specify element type to match camera.
ona-sdn	Specify element type to match ona-sdn.
ona-spb-over-ip	Specify element type to match ona-spb-over-ip.
phone	Specify element type to match phone.
router	Specify element type to match router.
security-device	Specify element type to match security-device.
srvr-endpt	Specify element type to match srvr-endpt.
switch	Specify element type to match switch.
video	Specify element type to match video.
virtual-switch	Specify element type to match virtual-switch.
wap-type1	Specify element type to match wap-type1.
wap-type2	Specify element type to match wap-type2.

Displaying FA Zero Touch Client Attachment

Use this procedure to display the Zero Touch Client Attachment data you have configured on an FA Server.

Procedure

1. Enter Privileged EXEC mode:

```
enable
```
2. Display Zero Touch Client Attachment data:

```
show fa zero-touch-client
```

Example

The following example displays sample output for the **show fa zero-touch-client** command.

```
Switch:1#show fa zero-touch-client
```

```
=====
Fabric Attach Zero Touch Client
=====
```

Type	Description	I-SID	VLAN
6	wap-type1		11111 123
11	camera		2000 200
17	ona-spb-over-ip	40001	4001

3 out of 3 Total Num of Fabric Attach Zero Touch Client entries displayed

IS-IS external metric configuration using the CLI

This section provides procedures for IS-IS external metric configuration.

Matching metric type for IS-IS routes

About this task

Use this procedure to match the external metric-type by using a route-map for any of the following cases:

- accepting a remote IS-IS route with the help of IS-IS accept policies.
- redistributing IS-IS routes into other protocols.

Before you begin

- You must configure the required SPBM and IS-IS infrastructure.
- You must log on to the route-map configuration mode in the CLI.

Procedure

1. Enter Route-Map Configuration mode:

```
enable
configure terminal
route-map WORD<1-64> <1-65535>
```

2. Match IS-IS metric type:

```
match metric-type-isis {any|internal|external}
```

3. Permit the route policy action:

```
permit
```

4. Enable the route policy

```
enable
```

Example

Match metric type for IS-IS routes:

```
Switch:1> enable
Switch:1# configure terminal
Switch:1(config)# route-map rol 10
Switch:1(route-map)# match metric-type-isis internal
```

```
Switch:1(route-map)# permit
Switch:1(route-map)# enable
```

Match metric type for IS-IS routes in accept policies:

```
Switch:1> enable
Switch:1# configure terminal
Switch:1(config)# route-map rol 10
Switch:1(route-map)# match metric-type-isis internal
Switch:1(route-map)# permit
Switch:1(route-map)# enable
Switch:1(route-map)# exit
Switch:1(config)# router isis
Switch:1(config-isis)# accept route-map rol
Switch:1(config-isis)# exit
Switch:1(config)# isis apply accept
```

Match metric type to redistribute IS-IS routes into some other protocol (OSPF,RIP,BGP)

```
Switch:1> enable
Switch:1# configure terminal
Switch:1(config)# route-map rol 10
Switch:1(route-map)# match metric-type-isis internal
Switch:1(route-map)# permit
Switch:1(route-map)# enable
Switch:1(route-map)# exit
Switch:1(config)# router bgp
Switch:1(router-bgp)# redistribute isis route-map rol
Switch:1(router-bgp)# exit
Switch:1(config)# ip bgp apply redistribute
```

Variable definitions

Use the data in the following table to use the match metric-type-isis command.

Variable	Value
metric-type-isis {any internal external}	<p>Specifies the IS-IS metric type.</p> <ul style="list-style-type: none"> • internal – permits or denies routes that are internal to the IS-IS domain. • external – permits or denies routes that originate from an external routing protocol domain. • any – permits or denies both internal routes as well as external routes.

Setting metric type for IS-IS routes

About this task

Use this procedure to set the IS-IS external metric-type by using a route-map for any of the following cases:

- accepting a remote IS-IS route with the help of IS-IS accept policies.
- redistributing routes from other protocols into IS-IS.

Before you begin

- You must configure the required SPBM and IS-IS infrastructure.
- You must log on to the route-map configuration mode in the CLI.

Procedure

1. Enter Route-Map Configuration mode:

```
enable
configure terminal
route-map WORD<1-64> <1-65535>
```

2. Set IS-IS metric type:

```
set metric-type-isis {any|internal|external}
```

3. Permit the route policy action:

```
permit
```

4. Enable the route policy

```
enable
```

Example**Set metric type for IS-IS routes:**

```
Switch:1> enable
Switch:1# configure terminal
Switch:1(config)# route-map rol 10
Switch:1(route-map)# set metric-type-isis internal
Switch:1(route-map)# permit
Switch:1(route-map)# enable
```

Set metric type for IS-IS routes in accept policies:

```
Switch:1> enable
Switch:1# configure terminal
Switch:1(config)# route-map rol 10
Switch:1(route-map)# set metric-type-isis internal
Switch:1(route-map)# permit
Switch:1(route-map)# enable
Switch:1(route-map)# exit
Switch:1(config)# router isis
Switch:1(config-isis)# accept route-map rol
Switch:1(config-isis)# exit
Switch:1(config)# isis apply accept
```

Set metric type to redistribute routes from other protocols into IS-IS:

```
Switch:1> enable
Switch:1# configure terminal
Switch:1(config)# route-map rol 10
Switch:1(route-map)# match metric-type-isis internal
Switch:1(route-map)# permit
Switch:1(route-map)# enable
Switch:1(route-map)# exit
Switch:1(config)# router isis
Switch:1(config-isis)# redistribute bgp route-map rol
Switch:1(config-isis)# exit
Switch:1(config)# isis apply redistribute
```

Variable definitions

Use the data in the following table to use the set metric-type-isis command.

Variable	Value
metric-type-isis {any internal external}	<p>Specifies the IS-IS metric type.</p> <ul style="list-style-type: none"> • internal – permits or denies routes that are internal to the IS-IS domain. • external – permits or denies routes that originate from an external routing protocol domain. • any – permits or denies both internal routes as well as external routes.

Setting metric type for IS-IS routes using global redistribute command

About this task

Use this procedure to set the IS-IS external metric-type using the global redistribute command for the following cases redistributing routes from other protocols into IS-IS.

Before you begin

- You must configure the required SPBM and IS-IS infrastructure.
- You must log on to the IS-IS router configuration mode in the CLI.

Procedure

1. Enter IS-IS Router Configuration mode:

```
enable
configure terminal
router isis
```

2. Set IS-IS metric type using global redistribute command:

```
redistribute direct metric-type {internal|external}
```

3. Enable the route policy

```
redistribute direct enable
```

Example

Set metric type for IS-IS routes using global redistribute command:

```
Switch:1> enable
Switch:1# configure terminal
Switch:1(config)# router isis
Switch:1(config-isis)# redistribute direct metric-type internal
Switch:1(config-isis)# redistribute direct enable
```

Variable definitions

Use the data in the following table to use the **redistribute direct metric-type** command.

Variable	Value
metric-type {internal external}	<p>Specifies the IS-IS metric type.</p> <ul style="list-style-type: none"> • internal – permits or denies routes that are internal to the IS-IS domain. • external – permits or denies routes that originate from an external routing protocol domain.

Suspending duplicate system ID detection when replacing a switch

When a switch is replaced and the original system ID and nickname is used, you must wait up to 20 minutes for the LSPs with the original system to age out. This is due to duplicate system ID and nickname detection. However, you can suspend duplicate detection on the replacement switch so that you can bring the switch into the network immediately.

About this task

To temporarily disable duplicate detection on the replacement switch, perform the following steps in order:

Procedure

1. Copy the configuration file of the original switch to the replacement switch.
2. Power up the replacement switch while it is not connected to the SPB network, that is, NNI ports are not connected.
3. Disable IS-IS on the original switch, or remove the switch from the network.
4. On the replacement switch, enter the following command to suspend duplicate detection for up to 21 minutes:

```
isis dup-detection-temp-disable
```
5. To check the remaining time, use the `show isis dup-detection-temp-disable remaining time` command.
6. Remove the original switch from the network.
7. Connect the replacement switch to the network.

Configuring a Dynamic Nickname Assignment nickname allocation range

About this task

Use this procedure to specify a nickname allocation range. The default nickname allocation range is a (A.00.00-A.FF.FF).

*** Note:**

You must disable Dynamic Nickname Assignment before you can change the nickname allocation range.

Procedure

1. Enter Global Configuration mode:

```
enable
configure terminal
```

2. Configure the Dynamic Nickname Assignment nickname allocation range.

```
[default] spbm nick-name server range <a-f>
```

3. Verify the configuration.

```
show spbm
```

Example

Configure the nickname allocation range:

```
Switch:1>enable
Switch:1#configure terminal
Enter configuration commands, one per line.  End with CNTL/Z.
Switch:1(config)#spbmnick-name server range b
```

Dynamic Nickname Assignment configuration values and their associated behavior are shown in the following output from the **show spbm** command:

```
Switch:1>show spbm
                spbm : enable
                ethertype : 0x8100
                nick-name server : disable
                nick-name allocation : static
                nick-name server range : B.00.00-B.FF.FF
```

Variable definitions

Use the data in the following table to use the **spbmnick-name server range** command.

Variable	Value
range	Specifies the nickname server allocation range. The default range is a (A.00.00-A.FF.FF).

Displaying Dynamic Nickname Assignment**About this task**

Use this procedure to display the current status and values for Dynamic Nickname Assignment.

Procedure

1. Log on to the switch to enter User EXEC mode.

2. Display Dynamic Nickname Assignment configuration values.

```
show spbm
```

Example

```
Switch:1>show spbm
                spbm : enable
                ethertype : 0x8100
                nick-name server : disable
                nick-name allocation : static
                nick-name server range : B.00.00-B.FF.FF
```

Enabling MSTP-Fabric Connect Multi Homing

About this task

Perform this procedure to enable MSTP-Fabric Connect Multi Homing for a specific SPBM instance.

Before you begin

You must configure a nickname for the specific SPBM instance on which you enable MSTP-Fabric Connect Multi Homing.

Procedure

1. Enter IS-IS Router Configuration mode:

```
enable
configure terminal
router isis
```

2. Enable MSTP-Fabric Connect Multi Homing on a specified SPBM instance:

```
spbm <1-100> stp-multi-homing enable
```

Example

```
Switch:1>enable
Switch:1#configure terminal
Switch:1(config)#router isis
Switch:1(config-isis)#spbm 1 stp-multi-homing enable
```

Variable definitions

Use data in the following table to use the **spbm** command.

Variable	Value
<1-100>	Specifies the IS-IS SPBM instance ID to create an SPBM instance.
stp-multi-homing enable	Enables MSTP-Fabric Connect Multi Homing on the specific SPBM instance. The default is disabled.

SPBM and IS-IS infrastructure configuration using EDM

This section provides procedures to configure basic SPBM and IS-IS infrastructure using Enterprise Device Manager (EDM).

Important:

The **EnableSpbmConfigMode** boot flag must be enabled (default) before you can configure SPBM or IS-IS. To verify the setting, navigate to **Configuration > Edit > Chassis** and click on the **Boot Config** tab.

Configuring required SPBM and IS-IS parameters

About this task

Use the following procedure to configure the minimum required SPBM and IS-IS parameters to allow SPBM to operate on the switch. SPBM uses the Intermediate-System-to-Intermediate-System (IS-IS) link state routing protocol to provide a loop free Ethernet topology that creates a shortest path topology from every node to every other node in the network based on node MAC addresses.

Procedure

1. Configure SBPM B-VLANs:

Note:

Always configure two B-VLANs in the core to allow load distribution over both B-VLANs.

- a. In the navigation pane, expand the **Configuration > VLAN > VLANs** folders.
 - b. Click the **Basic** tab.
 - c. Click **Insert**.
 - d. In the **type** field, click **spb-bvlan**.
 - e. Click **Insert**.
2. Enable SPBM globally:
 - a. In the navigation pane, expand the **Configuration > IS-IS** folders.
 - b. Click **SPBM**.
 - c. Click the **Globals** tab.
 - d. In the **GlobalEnable** field, select **enable** to enable SPBM globally.
 - e. Click **Apply**.
 3. Create an SPBM instance:

*** Note:**

Only one SBPM instance is supported.

- a. In the navigation pane, expand the **Configuration > IS-IS > SPBM** folders.
 - b. Click the **SPBM** tab.
 - c. Click **Insert** to create an SPBM instance.
 - d. In the **Id** field, specify the SPBM instance ID.
 - e. In the **NodeNickName** field, specify the node nickname (valid value is 2.5 bytes in the format <x.xx.xx>).
 - f. In the **Vlans** field, specify the IDs of the SPBM B-VLANs to add to the SPBM instance.
 - g. In the **PrimaryVlan** field, specify which of the SPBM B-VLANs specified in the previous step is the primary B-VLAN.
 - h. Click **Insert**.
4. Create a manual area:

*** Note:**

Only one manual area is supported.

- a. In the navigation pane, expand the **Configuration > IS-IS > IS-IS** folders.
 - b. Click the **Manual Area** tab.
 - c. Click **Insert**.
 - d. Specify the Manual Area address (a valid value is 1–13 bytes in the format <xx.xxxx.xxxx...xxxx>).
 - e. Click **Insert**.
5. Update the default IS-IS system ID to a recognizable address:
- a. In the navigation pane, expand the **Configuration > IS-IS > IS-IS** folders.
 - b. Click the **Globals** tab.
 - c. In the **SystemId** field, update the default B-MAC value to a recognizable address.

*** Note:**

Although it is not strictly required for SPBM operation, you must change the IS-IS system ID from the default B-MAC value to a recognizable address to easily identify a switch. This helps to recognize the source and destination addresses for troubleshooting purposes.

- d. In the **AdminState** field, click **on**.
- e. Click **Apply**.

6. Create an IS-IS circuit and enable SPBM on the circuit:
 - a. In the navigation pane, expand the **Configuration > IS-IS** folders.
 - b. Click the **Interfaces** tab.
 - c. Click **Insert** to create an IS-IS circuit.
 - d. In the **IfIndex** field, specify the port or MLT on which to create the IS-IS circuit.
 - e. Click **Insert**.
 - f. Select the newly created IS-IS circuit entry, and click **SPBM**.
 - g. In the **Interfaces SPBM** tab, click **Insert**.
 - h. In the **State** field, select **enable**.
 - i. Click **Insert**. This enables the SPBM instance on the IS-IS circuit.
 - j. Navigate back to the **Interfaces** tab.
 - k. In the **AdminState** field for the IS-IS circuit entry, select **on** to enable the IS-IS circuit.
 - l. Click **Apply**.

SPBM field descriptions

* Note:

The following tables list the minimum required SPBM and IS-IS parameters to allow SPBM to operate on the switch. For more detailed information on all of the parameters see the procedures that follow. For more information on how to configure VLANs, see *Configuring VLANs, Spanning Tree, and NLB*.

Use the data in the following table to use the **VLANs Basic** tab.

Name	Description
Type	Specifies the type of VLAN: <ul style="list-style-type: none"> • byPort • byProtocolId • spbm-bvlan • private

Use the data in the following table to use the **SPBM Globals** tab.

Name	Description
GlobalEnable	Enables or disables SPBM globally. The default is disabled.
GlobalEtherType	Specifies the global ethertype value as 0x8100 or 0x88a8. The default value is 0x8100.

Table continues...

Name	Description
NicknameServerEnable	Enables or disables the nickname server. The default is disabled.
NicknameDynamicAllocationStatus	Displays the Dynamic Nickname Allocation service operational status. This value is read-only.
NicknameServerRange	Specifies the nickname allocation range for Dynamic Nickname Assignment. The default is rangeA (A.00.00 to A.FF.FF).

Use the data in the following table to use the **SPBM** tab.

Name	Description
Id	Specifies the SPBM instance ID. Only one SPBM instance is supported.
NodeNickName	Specifies a nickname for the SPBM instance globally. Valid value is 2.5 bytes in the format <x.xx.xx>.
PrimaryVlan	Specifies the primary SPBM B-VLANs to add to the SPBM instance.
Vlans	Specifies the SPBM B-VLANs to add to the SPBM instance.
LsdbTrap	Configures whether to enable or disable a trap when the SPBM LSDB changes. The default is disable.
IpShortcut	Enables or disables SPBM IP shortcut state. The default is disable.
SmltSplitBEB	Specifies whether the switch is the primary or secondary vIST peer. The default is primary.
SmltVirtualBmac	Specifies a virtual MAC address that can be used by both peers.
SmltPeerSysId	Specifies the system ID of the SPBM SMLT for this SPBM instance.
Mcast	Specifies if IP multicast over SPBM is enabled. The default is disabled.
McastFwdCacheTimeout	Specifies the global forward cache timeout in seconds. The default is 210 seconds.
Ipv6Shortcut	Enables or disables SPBM IPv6 shortcut state. The default is disable.
McastSpbPimGwControllerEnable	Enables or disables ISIS PLSB Multicast SPB PIM Gateway controller. Disabled by default.
McastSpbPimGwGatewayEnable	Enables or disables ISIS PLSB Multicast SPB PIM Gateway. Disabled by default.
StpMultiHoming	Enables or disables MSTP-Fabric Connect Multi Homing. The default is disabled (false).

Use the data in the following table to use the **IS-IS Manual Area** tab.

Name	Description
AreaAddr	Specifies the IS-IS manual area. Valid value is 1-13 bytes in the format <xx.xxxx.xxxx...xxx>. Only one manual area is supported. Use the same manual area across the entire SPBM cloud. For IS-IS to operate, you must configure at least one manual area.

Use the data in the following table to use the **IS-IS Globals** tab.

Name	Description
AdminState	Specifies the global status of IS-IS on the switch: on or off. The default is off.
SystemId	<p>Specifies the IS-IS system ID for the switch. Valid value is a 6-byte value in the format <xxxx.xxxx.xxxx>.</p> <p> Important:</p> <p>After you have configured the SPBM nickname and enabled IS-IS, if you require a change of the system ID, you must also change the nickname. However, for naming convention purposes or configuration purposes, you may not want to change the nickname. To maintain the same nickname with a different system ID, see Job Aid on page 87.</p>

Use the data in the following table to use the **IS-IS Interfaces** tab.

Name	Description
Index	The identifier of this circuit, unique within the Intermediate System. This value is for SNMP Indexing purposes only and need not have any relation to any protocol value.
AdminState	Specifies the administrative state of the circuit: on or off.

Use the data in the following table to use the **IS-IS Interfaces SPBM** tab.

Name	Description
State	Specifies whether the SPBM interface is enabled or disabled.

Job aid

! Important:

After you have configured the SPBM nickname and enabled IS-IS. To maintain the same nickname with a different system ID, perform the following steps:

1. Disable IS-IS.
2. Change the system ID.
3. Change the nickname to a temporary one.
4. Enable IS-IS.
5. Wait up to 20 minutes for the LSPs with the original system ID to age out.

* Note:

To check the age out time, use the `show isis lsdb sysid <original-sys-id>` command on any of the other SPB nodes in the network. When there is no output from this command, proceed to the next step. The time left (in seconds) for the LSPs to age out is shown under the column LIFETIME.

6. Disable IS-IS.
7. Change the nickname to the original nickname.
8. Enable IS-IS.

Displaying SPBM and IS-IS summary information

Use the following procedure to view a summary of SPBM and IS-IS protocol information.

Procedure

1. In the navigation tree, expand the **Configuration > IS-IS** folders.
2. Click **IS-IS**.
3. Click the **Protocol Summary** tab.

Protocol Summary field descriptions

Use the data in the following table to use the **Protocol Summary** tab.

Name	Description
Globals ISIS	
AdminState	Indicates the global status of IS-IS on the switch.
SystemId	Indicates the IS-IS system ID for the switch. Valid value is a 6-byte value in the format <xxxx.xxxx.xxxx>

Table continues...

Name	Description
HostName	Indicates a name for the system. This may be used as the host name for dynamic host name exchange in accordance with RFC 2763. By default, the system name comes from the host name configured at the system level.
Globals SPBM	
GlobalEnable	Indicates whether SPBM is enabled or disabled at the global level.
NodeNickName	Indicates the nickname for the SPBM instance globally. Valid value is 2.5 bytes in the format <x.xx.xx>.
PrimaryVlan	Indicates the primary VLAN ID for this SPBM instance.
SmltSplitBEB	Indicates whether the switch is the primary or secondary IST peer.
ISIS Interfaces	
Circuit Index	Displays the identifier of this IS-IS circuit, unique within the Intermediate System. This is for SNMP Indexing purposes only and need not have any relation to any protocol value.
IfIndex	Indicates the interface to which this circuit corresponds.
AdminState	Indicates the administrative state of the circuit: on or off.
OperState	Indicates the operational state of the circuit: up or down.
ISIS Adjacency View	
Circuit Index	Displays the identifier of this IS-IS circuit, unique within the Intermediate System. This value is for SNMP Indexing purposes only and need not have any relation to any protocol value.
AdjIndex	Displays a unique value identifying the IS adjacency from all other such adjacencies on this circuit. This value is automatically assigned by the system when the adjacency is created
AdjIfIndex	Indicates the interface to which this circuit corresponds.
AdjState	Indicates the state of the adjacency: <ul style="list-style-type: none"> • down • initializing • up • failed
AdjNeighSysID	Indicates the system ID of the neighboring Intermediate System.
AdjHostName	Indicates the host name listed in the LSP, or the system name if the host name is not configured.

Displaying the SPBM I-SID information

Use the following procedure to display the SPBM Service Instance Identifier (I-SID) information. The SPBM B-MAC header includes an I-SID with a length of 24 bits. This I-SID can be used to identify and transmit any virtualized traffic in an encapsulated SPBM frame.

Procedure

1. In the navigation pane, expand the **Configuration > IS-IS** folders.
2. Click **SPBM**.
3. Click the **I-SID** tab.

I-SID field descriptions

Use the data in the following table to use the **I-SID** tab.

Name	Description
SysId	Indicates the system identifier.
Vlan	Indicates the B-VLAN where this I-SID was configured or discovered.
Isid	Indicates the IS-IS SPBM I-SID identifier.
NickName	Indicates the nickname of the node where this I-SID was configured or discovered.
HostName	Indicates the host name listed in the LSP, or the system name if the host name is not configured.
Type	Indicates the SPBM I-SID type; either configured or discovered.

Displaying Level 1 Area information

Use the following procedure to display Level 1 area information. IS-IS provides support for hierarchical routing, which enables you to partition large routing domains into smaller areas. IS-IS uses a two-level hierarchy, dividing the domain into multiple Level 1 areas and one Level 2 area. The Level 2 area serves as backbone of the domain, connecting to all the Level 1 areas.

Important:

The IEEE 802.1aq standard currently only defines the use of one hierarchy, Level 1. Level 2 function is disabled.

Procedure

1. In the navigation pane, expand the **Configuration > IS-IS** folders.
2. Click **IS-IS**.
3. Click the **L1 Area** tab.

L1 Area field descriptions

Use the data in the following table to use the **L1 Area** tab.

Name	Description
AreaAddr	Specifies an area address reported in a Level 1 link-state packets (LSP) generated or received by this Intermediate System.

Configuring SMLT parameters for SPBM

Use the following procedure to configure the required Split MultiLink Trunking (SMLT) parameters to allow SPBM to interoperate with SMLT on the switch.

* Note:

- The assignment of primary and secondary roles to the vIST peers is automatic. The switch with the lower system ID (between the two vIST peers) is primary, and the switch with the higher system ID is secondary when default system-id values are being used.
- SMLT peer system ID is part of the required configuration. You must configure the SMLT peer system ID as the nodal MAC of the peer device. In the IS-IS network, the nodal MAC of devices should be eight apart from each other.
- When using the default hardware assigned system-id value, the SMLT Virtual BMAC is automatically derived by comparing the system-id values of the two vIST peers. A value of 0x01 plus the lower of the two system-id values is used as the SMLT Virtual BMAC.

When using a manually configured system-id value, the SMLT Virtual BMAC must also be manually configured.

- An I-SID must be assigned to every VLAN that is a member of an L2 VSN. Also if an L2 VSN is created on one vIST Peer, it must also be created on the other vIST peer.

Procedure

1. In the navigation pane, expand the **Configuration > IS-IS > SPBM** folders.
2. Click the **SPBM** tab.
3. Use the **SmltSplitBEB** field to see whether the switch is the primary or secondary vIST peer. This field cannot be modified.
4. Use the **SmltVirtualBmac** field to specify a virtual MAC address that can be used by both peers.
5. Use the **SmltPeerSysid** field to specify the vIST peer B-MAC address.
6. Click **Apply**.

Enabling or disabling SPBM at the global level

Use the following procedure to enable or disable SPBM at the global level. SPBM uses the Intermediate-System-to-Intermediate-System (IS-IS) link state routing protocol to provide a loop free Ethernet topology that creates a shortest path topology from every node to every other node in the network based on node MAC addresses.

Procedure

1. In the navigation pane, expand the **Configuration > IS-IS** folders.
2. Click **SPBM**.
3. Click the **Globals** tab.
4. To enable or disable SPBM, click **enable** or **disable** in the **GlobalEnable** field.
5. To configure the global ethertype value, click the desired option in the **GlobalEtherType** field.
6. Click **Apply**.

Globals field descriptions

Use the data in the following table to use the **Globals** tab.

Name	Description
GlobalEnable	Enables or disables SPBM globally. The default is disabled.
GlobalEtherType	Specifies the global ethertype value as 0x8100 or 0x88a8. The default value is 0x8100.
NicknameServerEnable	Enables or disables the nickname server. The default is disabled.
NicknameDynamicAllocationStatus	Displays the Dynamic Nickname Allocation service operational status. This value is read-only.
NicknameServerRange	Specifies the nickname allocation range for Dynamic Nickname Assignment. The default is rangeA (A.00.00 to A.FF.FF).

Configuring SPBM parameters

Use the following procedure to configure SPBM global parameters. SPBM uses the Intermediate-System-to-Intermediate-System (IS-IS) link state routing protocol to provide a loop free Ethernet topology that creates a shortest path topology from every node to every other node in the network based on node MAC addresses.

Procedure

1. In the navigation pane, expand the **Configuration > IS-IS** folders.
2. Click **SPBM**.
3. Click the **SPBM** tab.
4. To create an SPBM instance, click **Insert**.
5. Configure the SPBM parameters.
6. Click **Apply**.

SPBM field descriptions

Use the data in the following table to use the SPBM tab.

Name	Description
Id	Specifies the SPBM instance ID. Only one SPBM instance is supported.
NodeNickName	Specifies a nickname for the SPBM instance globally. Valid value is 2.5 bytes in the format <x.xx.xx>.
PrimaryVlan	Specifies the primary SPBM B-VLANs to add to the SPBM instance.
Vlans	Specifies the SPBM B-VLANs to add to the SPBM instance.
LsdbTrap	Configures whether to enable or disable a trap when the SPBM LSDB changes. The default is disable.
IpShortcut	Enables or disables SPBM IP shortcut state. The default is disable.
SmltSplitBEB	Specifies whether the switch is the primary or secondary vIST peer. The default is primary.
SmltVirtualBmac	Specifies a virtual MAC address that can be used by both peers.
SmltPeerSysId	Specifies the system ID of the SPBM SMLT for this SPBM instance.
Mcast	Specifies if IP multicast over SPBM is enabled. The default is disabled.
McastFwdCacheTimeout	Specifies the global forward cache timeout in seconds. The default is 210 seconds.
Ipv6Shortcut	Enables or disables SPBM IPv6 shortcut state. The default is disable.
McastSpbPimGwControllerEnable	Enables or disables ISIS PLSB Multicast SPB PIM Gateway controller. Disabled by default.
McastSpbPimGwGatewayEnable	Enables or disables ISIS PLSB Multicast SPB PIM Gateway. Disabled by default.

Table continues...

Name	Description
StpMultiHoming	Enables or disables MSTP-Fabric Connect Multi Homing. The default is disabled (false).

Displaying SPBM nicknames

Use the following procedure to display SPBM nicknames.

Procedure

1. In the navigation pane, expand the **Configuration > IS-IS** folders.
2. Click **SPBM**.
3. Click the **Nick Names** tab.

Nickname field descriptions

Use the data in the following table to use the **NickName** tab.

Name	Description
Level	Indicates the level at which this LSP appears.
ID	Indicates the 8 byte LSP ID, consisting of the SystemID, Circuit ID, and Fragment Number.
LifetimeRemain	Indicates the remaining lifetime in seconds for the LSP.
NickName	Indicates the nickname for the SPBM node.
HostName	Indicates the hostname listed in the LSP, or the system name if the host name is not configured.

Configuring interface SPBM parameters

Use the following procedure to configure SPBM interface parameters.

Procedure

1. In the navigation pane, expand the **Configuration > IS-IS** folders.
2. Click **SPBM**.
3. Click the **Interfaces SPBM** tab.
4. Configure the SPBM interface parameters.
5. Click **Apply**.

SPBM field descriptions

Use the data in the following table to use the Interfaces SPBM tab.

Name	Description
Index	Specifies an Index value for the SPBM interface.
SpbmId	Specifies the SPBM ID.
State	Specifies whether the SPBM interface is enabled or disabled.
Type	Configures the SPBM instance interface-type on the IS-IS interface located on the specified port or MLT: ptpt or bcast. Only the point-to-point (ptpt) interface type is supported.
L1Metric	Configures the SPBM instance l1-metric on the IS-IS interface located on the specified port or MLT. The default value is 10.

Configuring SPBM on an interface

Use the following procedure to configure SPBM on an interface.

Procedure

1. In the navigation pane, expand the **Configuration > IS-IS** folders.
2. Click **IS-IS**.
3. Click the **Interfaces** tab.
4. Click the **SPBM** button.
5. In the **Interfaces SPBM** tab, click **Insert**.
6. Click **Insert**.

Interfaces SPBM field descriptions

Use the data in the following table to use the Interfaces SPBM tab.

Name	Description
Index	Specifies an Index value for the SPBM interface.
SpbmId	Specifies the SPBM instance ID.
State	Specifies whether the SPBM interface is enabled or disabled. The default is disabled.
Type	Configures the SPBM instance interface-type on the IS-IS interface located on the specified port or MLT. Only the pt-pt interface type is supported. The default is pt-pt.

Table continues...

Name	Description
L1Metric	Configures the SPBM instance l1-metric on the IS-IS interface located on the specified port or MLT. The default value is 10.

Displaying the IP unicast FIB

Use the following procedure to display the IP unicast Forwarding Information Base (FIB). The tab shows IP routes from remote Backbone Edge Bridges (BEBs)

In SPBM, each node has a System ID, which also serves as Backbone MAC address (B-MAC) of the switch. These Backbone MAC addresses are populated into the SPBM VLAN Forwarding Information Base (FIB). When the network topology is discovered and stored in the IS-IS link-state database, each node calculates shortest path trees for each source node, so that a unicast path now exists from every node to every other node. With this information, each node populates unicast information received from SPBM into the FIB for forwarding purposes.

I-SIDs are only used for virtual services (Layer 2 VSNs and Layer 3 VSNs). If you only enable IP Shortcuts on the Backbone Edge Bridges, I-SIDs are never exchanged in the network as IP Shortcuts allows for Global Routing Table (GRT) IP networks to be transported across IS-IS.

The **IP Unicast FIB** tab displays all of the IS-IS routes in the IS-IS LSDB. The Preference column in the **IP Unicast FIB** tab displays the IP route preference.

Routes within the same VSN are added to the LSDB with a default preference of 7. Inter-VSN routes are added to the LSDB with a route preference of 200. IS-IS accept policies allow you to change the route preference for incoming routes. If the same route is learned from multiple sources with different route preferences, then the routes are not considered equal cost multipath (ECMP) routes. The route with the lowest route preference is the preferred route. In Layer 2, in the event of a tie-break between routes from multiple sources, the tie-breaking is based on cost and hop count.

Procedure

1. In the navigation pane, expand the **Configuration > IS-IS** folders.
2. Click **SPBM**.
3. Click the **IP Unicast FIB** tab.

IP Unicast FIB field descriptions

Use the data in the following table to use the **IP Unicast FIB** tab.

Name	Description
Vrfid	Specifies the VRF ID of the IP unicast FIB entry, 0 indicates NRE.
DestinationIpAddrType	Specifies the address type of the destination IP address.
DestinationIpAddr	Specifies the destination IP Address of the IP unicast FIB entry.
DestinationMask	Specifies the destination IP mask of the IP unicast FIB entry

Table continues...

Name	Description
NextHopBmac	Specifies the nexthop B-MAC of the IP unicast FIB entry.
DestId	Specifies the destination ISID of the IP unicast FIB entry.
Vlan	Specifies the VLAN of the IP unicast FIB entry.
Isid	Specifies the I-SID of the IP unicast FIB entry.
NextHopName	Specifies the nexthop hostname of the IP unicast FIB entry.
OutgoingPort	Specifies the outgoing port of the IP unicast FIB entry.
PrefixCost	Specifies the prefix cost of the IP unicast FIB entry.
SpbmCost	Specifies the B-MAC cost of the IP unicast FIB entry.
Preference	Specifies the IP Route preference of the IP unicast FIB entry
MetricType	Specifies the IP Metric Type of the IP unicast FIB entry.

Displaying the IPv6 unicast FIB

Use the following procedure to display the IPv6 unicast Forwarding Information Base (FIB). The tab shows IPv6 routes from remote Backbone Edge Bridges (BEBs)

In SPBM, each node has a System ID, which also serves as Backbone MAC address (B-MAC) of the switch. These Backbone MAC addresses are populated into the SPBM VLAN Forwarding Information Base (FIB). When the network topology is discovered and stored in the IS-IS link-state database, each node calculates shortest path trees for each source node, so that a unicast path now exists from every node to every other node. With this information, each node populates unicast information received from SPBM into the FIB for forwarding purposes.

I-SIDs are only used for virtual services (Layer 2 VSNs and Layer 3 VSNs). If you only enable IP Shortcuts on the Backbone Edge Bridges, I-SIDs are never exchanged in the network as IP Shortcuts allows for Global Routing Table (GRT) IP networks to be transported across IS-IS.

Procedure

1. In the navigation pane, expand the **Configuration > IS-IS** folders.
2. Click **SPBM**.
3. Click the **IPv6 Unicast FIB** tab.

IPv6 Unicast FIB field descriptions

Use the data in the following table to use the **IPv6 Unicast FIB** tab.

Name	Description
VrfId	Specifies the VRF ID of the IPv6 unicast FIB entry, 0 indicates NRE.
DestinationIpAddrType	Specifies the address type of the destination IPv6 address.

Table continues...

Name	Description
DestinationIpAddr	Specifies the destination IPv6 Address of the IPv6 unicast FIB entry.
DestinationMask	Specifies the destination IPv6 mask of the IPv6 unicast FIB entry.
NextHopBmac	Specifies the nexthop B-MAC of the IPv6 unicast FIB entry.
DestIsid	Specifies the destination I-SID of the IPv6 unicast FIB entry.
Vlan	Specifies the VLAN of the IPv6 unicast FIB entry.
Isid	Specifies the I-SID of the IPv6 unicast FIB entry.
NextHopName	Specifies the nexthop hostname of the IPv6 unicast FIB entry.
OutgoingPort	Specifies the outgoing port of the IPv6 unicast FIB entry.
SpbmCost	Specifies the B-MAC cost of the IPv6 unicast FIB entry.
PrefixCost	Specifies the prefix cost of the IPv6 unicast FIB entry.

Displaying the unicast FIB

Use the following procedure to display the unicast FIB.

In SPBM, B-MAC addresses are carried within the IS-IS link-state database. To do this, SPBM supports an IS-IS TLV that advertises the I-SID and B-MAC information across the network. Each node has a System ID, which also serves as Backbone MAC address (B-MAC) of the switch. These Backbone MAC addresses are populated into the SPBM VLAN Forwarding Information Base (FIB).

When the network topology is discovered and stored in the IS-IS link-state database, each node calculates shortest path trees for each source node, so that a unicast path now exists from every node to every other node. With this information, each node populates unicast information received from SPBM into the FIB for forwarding purposes.

Procedure

1. In the navigation pane, expand the **Configuration > IS-IS** folders.
2. Click **SPBM**.
3. Click the **Unicast FIB** tab.

Unicast FIB field descriptions

Use the data in the following table to use the **Unicast FIB** tab.

Name	Description
SysId	Specifies the system ID of the node where the unicast FIB entry originated.
Vlan	Specifies the VLAN of the unicast FIB entry.
DestinationMacAddr	Specifies the destination MAC Address of the unicast FIB entry.

Table continues...

Name	Description
OutgoingPort	Specifies the outgoing port of the unicast FIB entry.
HostName	Specifies the host name of the node where unicast FIB entry originated.
Cost	Specifies the cost of the unicast FIB entry.

Displaying LSP summary information

Use the following procedure to display link-state packet (LSP) summary information. Link State Packets (LSP) contain information about the state of adjacencies or defined and distributed static routes. Intermediate System to Intermediate System (IS-IS) exchanges this information with neighboring IS-IS routers at periodic intervals.

Procedure

1. In the navigation pane, expand the **Configuration > IS-IS** folders.
2. Click **IS-IS**.
3. Click the **LSP Summary** tab.

LSP Summary field descriptions

Use the data in the following table to use the **LSP Summary** tab.

Name	Description
Level	Specifies the level at which this LSP appears.
ID	Specifies the 8 byte LSP ID, consisting of the SystemID, Circuit ID, and Fragment Number.
Seq	Specifies the sequence number for this LSP.
Checksum	Specifies the 16 bit Fletcher Checksum for this LSP.
LifetimeRemain	The remaining lifetime in seconds for this LSP.
HostName	The hostname listed in LSP, or the system name if host name is not configured.

Displaying IS-IS adjacencies

Use the following procedure to display IS-IS adjacency information. The platform sends IS-IS Hello (IIH) packets to discover IS-IS neighbors and establish and maintain IS-IS adjacencies. The platform continues to send IIH packets to maintain the established adjacencies. For two nodes to form an adjacency the B-VLAN pairs for the primary B-VLAN and secondary B-VLAN must match.

Procedure

1. In the navigation pane, expand the **Configuration > IS-IS** folders.

2. Click **IS-IS**.
3. Click the **Adjacency** tab.

Adjacency field descriptions

Use the data in the following table to use the **Adjacency** tab.

Name	Description
Interface	Specifies the IS-IS interface on which the adjacency is found.
Level	Indicates the level of the IS-IS interface (Level 1 [default] or Level 2).
State	Specifies the state of the adjacency: <ul style="list-style-type: none"> • down • initializing • up • failed
LastUpTime	Indicates when the adjacency most recently entered the state up , measured in hundredths of a second since the last re-initialization of the network management subsystem. Displays 0 if the adjacency has never been in state up .
NeighPriority	Specifies the priority of the neighboring Intermediate System for becoming the Designated Intermediate System.
HoldTimer	Specifies the holding time in seconds for this adjacency. This value is based on received IS-IS Hello (IIH) PDUs and the elapsed time since receipt.
NeighSysID	Specifies the system ID of the neighboring Intermediate System.
AdjHostName	Specifies the host name listed in the LSP, or the system name if host name is not configured.
ParallelActive	Specifies if the current adjacency among all the parallel adjacencies between two nodes is active. <ul style="list-style-type: none"> • true • false

Configuring IS-IS global parameters

Use the following procedure to configure IS-IS global parameters. SPBM uses IS-IS to discover network topology, build shortest path trees between network nodes, and communicate network information in the control plane.

Procedure

1. In the navigation pane, expand the **Configuration > IS-IS** folders.

2. Click **IS-IS**.
3. From the **Globals** tab, configure the global IS-IS parameters.
4. Click **Apply**.

Globals field descriptions

Use the data in the following table to use the Globals tab.

Name	Description
AdminState	Specifies the global status of IS-IS on the switch: on or off. The default is off.
LevelType	Sets the router type globally: <ul style="list-style-type: none"> • level1: Level-1 router type • level1and2: Level-1/2 router type is not supported. The default value is level1.
SystemId	Specifies the IS-IS system ID for the switch. Valid value is a 6-byte value in the format <xxxx.xxxx.xxxx>. <p>! Important:</p> After you have configured the SPBM nickname and enabled IS-IS, if you require a change of the system ID, you must also change the nickname. However, for naming convention purposes or configuration purposes, you may not want to change the nickname. To maintain the same nickname with a different system ID, see Job Aid on page 87.
MaxLspGenInt	Specifies the maximum interval, in seconds, between generated LSPs by this Intermediate system. The value must be greater than any value configured for RxmtLspInt. <p>The default value is 900 seconds.</p>
Csnplnt	Specifies the Complete Sequence Number Packet (CSNP) interval in seconds. This is a system level parameter that applies for L1 CSNP generation on all interfaces. <p>The default value is 10.</p>
RxmtLspInt	Specifies the minimum time between retransmission of an LSP. This defines how fast the switch resends the same LSP. This is a system level parameter that applies for L1 retransmission of LSPs. <p>The default value is 5 seconds.</p>

Table continues...

Name	Description
PSNPInterval	Specifies the Partial Sequence Number Packet (PSNP) interval in seconds. This is a system level parameter that applies for L1 PSNP generation on all interfaces. The default value is 2.
SpfDelay	Specifies the SPF delay in milliseconds. This value is used to pace successive SPF runs. The timer prevents two SPF runs from being scheduled very closely. The default value is 100 milliseconds.
HostName	Specifies a name for the system. This may be used as the host name for dynamic host name exchange in accordance with RFC 2763. By default, the system name comes from the host name configured at the system level.
IpSourceAddress	Specifies IP source address for SPBM IP shortcuts.
Ipv6SourceAddressType	Click ipv6 to use IPv6 addresses.
Ipv6SourceAddress	Specifies IPv6 source address for SPBM IP shortcuts.
IpTunnelSourceAddress	Specifies the IS-IS IP tunnel source address.
IpTunnelVrf	Specifies the VRF name associated with the IP tunnel.
MgmtIpAddr	Specifies the DvR management IP address for this node, in the DvR domain.
BackboneEnable	Select to enable this node to join the DvR backbone so that it can receive redistributed DvR host routes from all DvR Controllers in the network.
FanMember	Specifies whether the node is a member of the Fabric Area Network (FAN) .
DynamicallyLearnedArea	For FAN members, specifies the IS-IS area that is dynamically learned from the neighbor's Hello PDU if the node does not have the IS-IS manual area configured.

Configuring system-level IS-IS parameters

Use the following procedure to configure system-level IS-IS parameters.

Procedure

1. In the navigation pane, expand the **Configuration > IS-IS > IS-IS** folders.
2. Click the **System Level** tab.

3. Configure the IS-IS system level parameters.
4. Click **Apply**.

System Level field descriptions

Use the data in the following table to use the **System Level** tab.

Name	Description
Index	Specifies the level: I1 or I2. Only I1 is supported.
State	Specifies the state of the database at this level. The value 'off' indicates that IS-IS is not active at this level. The value 'on' indicates that IS-IS is active at this level, and not overloaded. The value 'waiting' indicates a database that is low on an essential resources, such as memory. The administrator may force the state to 'overloaded' by setting the object SetOverload . If the state is 'waiting' or 'overloaded', you originate LSPs with the Overload bit set.
SetOverload	Sets or clears the overload condition. The possible values are true or false. The default value is false.
SetOverloadUntil	Sets the IS-IS overload-on-startup value in seconds. The overload-on-startup value is used as a timer to control when to send out LSPs with the overload bit cleared after IS-IS startup. <div style="display: flex; align-items: flex-start;"> <div style="margin-right: 10px;">* Note:</div> <div> <p>If you configure SetOverloadUntil to a number other than zero, then the overload bit is set at this level when the AdminState variable goes to the state 'on' for this Intermediate System.</p> <p>After the SetOverloadUntil seconds elapse, the overload flag remains set if the implementation runs out of memory or if you configured it manually using SetOverload to true.</p> <p>If SetOverload is false, the system clears the overload bit after SetOverloadUntil seconds elapse, if the system has not run out of memory.</p> </div> </div> The default value is 20.
MetricStyle	Specifies the IS-IS metric type. Available values are narrow, wide or both. Only wide is supported.

Displaying IS-IS system statistics

Use the following procedure to display Intermediate-System-to-Intermediate-System (IS-IS) system statistics.

Procedure

1. In the navigation pane, expand the **Configuration > IS-IS** folders.
2. Click **Stats**.
3. Click the **System Stats** tab.

System Stats field descriptions

Use the data in the following table to use the **System Stats** tab.

Name	Description
CorrLSPs	Indicates the number of corrupted in-memory link-state packets (LSPs) detected. LSPs received from the wire with a bad checksum are silently dropped and not counted.
AuthFails	Indicates the number of authentication key failures recognized by this Intermediate System.
LSPDbaseOloads	Indicates the number of times the LSP database has become overloaded.
ManAddrDropFromAreas	Indicates the number of times a manual address has been dropped from the area.
AtmptToExMaxSeqNums	Indicates the number of times the IS has attempted to exceed the maximum sequence number.
SeqNumSkips	Indicates the number of times a sequence number skip has occurred.
OwnLSPPurges	Indicates the number of times a zero-aged copy of the system's own LSP is received from some other node.
IDFieldLenMismatches	Indicates the number of times a PDU is received with a different value for ID field length to that of the receiving system.
PartChanges	Indicates partition changes.
AbsoluteValue	Displays the counter value.
Cumulative	Displays the total value since you opened the Stats tab.
Average/sec	Displays the average value for each second.
Minimum/sec	Displays the minimum value for each second.
Maximum/sec	Displays the maximum value for each second.
LastVal/sec	Displays the last value for each second.

Configuring IS-IS interfaces

Use the following procedure to configure IS-IS interfaces. SPBM uses IS-IS to discover network topology, build shortest path trees between network nodes, and communicate network information in the control plane.

Procedure

1. In the navigation pane, expand the **Configuration > IS-IS** folders.
2. Click **IS-IS**.
3. Click the **Interfaces** tab.
4. Configure the IS-IS interface parameters.
5. Click **Apply**.

Interfaces field descriptions

Use the data in the following table to use the **Interfaces** tab.

Name	Description
Index	The identifier of this circuit, unique within the Intermediate System. This value is for SNMP Indexing purposes only and need not have any relation to any protocol value.
IfIndex	Specifies the interface on which the circuit is configured (port or MLT).
Type	Specifies the IS-IS circuit type. Only the point-to-point (PtToPt) interface type is supported.
AdminState	Specifies the administrative state of the circuit: on or off.
OperState	Specifies the operational state of the circuit.
AuthType	Specifies the authentication type: <ul style="list-style-type: none"> • none • simple: If selected, you must also specify a key value but the key id is optional. Simple password authentication uses a text password in the transmitted packet. The receiving router uses an authentication key (password) to verify the packet. • hmac-md5: If selected, you must also specify a key value, but the key-id is optional. MD5 authentication creates an encoded checksum in the transmitted packet. The receiving router uses an authentication key (password) to verify the MD5 checksum of the packet. There is an optional key ID. • hmac-sha-256: If selected, you must also specify a key value, but the key-id is optional. With SHA-256 authentication, the switch adds an hmac-sha-256 digest to each Hello packet. The switch that receives the Hello packet computes the digest of the packet and compares it with the received digest. If the digests match, the packet is accepted.

Table continues...

Name	Description
	<p>If the digests do not match, the receiving switch discards the packet. There is an optional key ID.</p> <p>Note:</p> <p>Secure Hashing Algorithm 256 bits (SHA-256) is a cipher and a cryptographic hash function of SHA2 authentication. You can use SHA-256 to authenticate IS-IS Hello messages. This authentication method uses the SHA-256 hash function and a secret key to establish a secure connection between switches that share the same key.</p> <p>This feature is in full compliance with RFC 5310.</p> <p>The default is none.</p>
AuthKey	Specifies the authentication key.
KeyId	Specifies the authentication key ID.
LevelType	<p>Specifies the router type globally:</p> <ul style="list-style-type: none"> • level1: Level-1 router type • level 1and2: Level-1/2 router type. This type is not supported. <p>The default value is level1.</p>
NumAdj	Specifies the number of adjacencies on this circuit.
NumUpAdj	Specifies the number of adjacencies that are up.
AutoNniEnable	<p>Enable to have the node create an IS-IS interface, attach the interface to an SPBM instance, and then enable IS-IS on the port interface.</p> <p>This field appears on the Insert Interfaces dialog box and applies to port interfaces only.</p>

Table continues...

Configuring IS-IS interface level parameters

Use the following procedure to configure IS-IS interface level parameters. SPBM uses IS-IS to discover network topology, build shortest path trees between network nodes, and communicate network information in the control plane.

Procedure

1. In the navigation pane, expand the **Configuration > IS-IS** folders.

2. Click **IS-IS**.
3. Click the **Interfaces Level** tab.
4. Configure the IS-IS interface level parameters.
5. Click **Apply**.

Interfaces field descriptions

Use the data in the following table to use the Interfaces Level tab.

Name	Description
Index	The identifier of this circuit, unique within the Intermediate System. This value is for SNMP Indexing purposes only and need not have any relation to any protocol value.
Level	Specifies the router type globally: <ul style="list-style-type: none"> • I1: Level1 router type • I12: Level1/Level2 router type. This type is not supported. The default value is I1.
ISPriority	Specifies an integer sub-range for IS-IS priority. The default is 64.
HelloTimer	Configures the level 1 hello interval. Specifies the maximum period, in milliseconds, between IS-IS Hello Packets (IIH) PDUs on multiaccess networks at this level for LANs. The value at Level1 is used as the period between Hellos on Level1/Level2 point to point circuits. Setting this value at Level 2 on an Level1/Level2 point-to-point circuit results in an error of InconsistentValue. The default value is 9000 milliseconds or 9 seconds.
HelloMultiplier	Configures the level 1 hello multiplier. The default value is 3 seconds.
DRHelloTimer	Indicates the period, in milliseconds, between Hello PDUs on multiaccess networks when this Intermediate System is the Designated Intermediate System. The default is 3.

Displaying IS-IS interface counters

Use the following procedure to display IS-IS interface counters.

Procedure

1. In the navigation pane, expand the **Configuration > IS-IS** folders.
2. Click **Stats**.
3. Click the **Interface Counters** tab.

Interface Counters field descriptions

Use the data in the following table to use the **Interface Counters** tab.

Name	Description
Index	Shows a unique value identifying the IS-IS interface.
Level	Shows the type of circuit that discovered the interface counters. The point to point Hello PDU includes both L1 and L2, and IS from a single adjacency on point to point links, therefore combining counts on point to point links into one group.
AdjChanges	Shows the number of times an adjacency state change has occurred on this circuit.
InitFails	Shows the number of times initialization of this circuit has failed. This counts events such as PPP NCP failures. Failures to form an adjacency are counted by isisCircRejAdjs.
RejAdjs	Shows the number of times an adjacency has been rejected on this circuit.
IDFieldLenMismatches	Shows the number of times an IS-IS control PDU with an ID field length different to that for this system has been received.
MaxAreaAddrMismatches	Shows the number of times an IS-IS control PDU with a max area address field different to that for this system has been received.
AuthFails	Shows the number of times an IS-IS control PDU with the correct auth type has failed to pass authentication validation.
LANDesISChanges	Shows the number of times the Designated IS has changed on this circuit at this level. If the circuit is point to point, this count is zero.

Displaying IS-IS interface control packets

Use the following procedure to display IS-IS interface control packets.

Procedure

1. In the navigation pane, expand the **Configuration > IS-IS** folders.
2. Click **Stats**.
3. Click the **Interface Control Packets** tab.

Interface Control Packets field descriptions

Use the data in the following table to use the **Interface Control Packets** tab.

Name	Description
Index	Shows a unique value identifying the Intermediate-System-to-Intermediate-System (IS-IS) interface.
Direction	Indicates whether the switch is sending or receiving the PDUs.
Hello	Indicates the number of IS-IS Hello frames seen in this direction at this level.
LSP	Indicates the number of IS-IS LSP frames seen in this direction at this level.
CSNP	Indicates the number of IS-IS Complete Sequence Number Packets (CSNP) frames seen in this direction at this level.
PSNP	Indicates the number of IS-IS Partial Sequence Number Packets (PSNP) frames seen in this direction at this level.

Graphing IS-IS interface counters

Use the following procedure to graph IS-IS interface counters.

Procedure

1. In the navigation pane, expand the **Configuration > IS-IS** folders.
2. Click **IS-IS**.
3. Click the **Interfaces** tab.
4. Select an existing interface.
5. Click the **Graph** button.

Interface Counters field descriptions

The following table describes the fields in the **Interface Counters** tab.

Name	Description
InitFails	Indicates the number of times initialization of this circuit has failed. This counts events such as PPP NCP failures.
RejAdjs	Indicates the number of times an adjacency has been rejected on this circuit.
IDFieldLenMismatches	Indicates the number of times an Intermediate-System-to-Intermediate-System (IS-IS) control PDU with an ID field length different from that for this system has been received.
MaxAreaAddrMismatches	Indicates the number of times an IS-IS control PDU with a max area address field different from that for this system has been received.
AuthFails	Indicates the number of times an IS-IS control PDU with the correct auth type has failed to pass authentication validation.

Table continues...

Name	Description
LANDesISChanges	Indicates the number of times the Designated IS has changed on this circuit at this level. If the circuit is point to point, this count is zero.
AbsoluteValue	Displays the counter value.
Cumulative	Displays the total value since you opened the Stats tab.
Average/Sec	Displays the average value for each second.
Minimum/Sec	Displays the minimum value for each second.
Maximum/Sec	Displays the maximum value for each second.
Last Val/Sec	Displays the last value for each second.

Graphing IS-IS interface sending control packet statistics

Use the following procedure to graph IS-IS interface receiving control packet statistics.

Procedure

1. In the navigation pane, expand the **Configuration > IS-IS** folders.
2. Click **IS-IS**.
3. Click the **Interfaces** tab.
4. Select an existing interface.
5. Click the **Graph** button.
6. Click the **Interface Sending Control Packets** tab.

Interface Sending Control Packets field descriptions

The following table describes the fields in the **Interface Sending Control Packets** tab.

Name	Description
Hello	Indicates the number of IS-IS Hello (IIH) PDUs seen in this direction at this level. Point-to-Point IIH PDUs are counted at the lowest enabled level: at L1 on L1 or L1L2 circuits, and at L2 otherwise.
LSP	Indicates the number of IS-IS LSP frames seen in this direction at this level.
CSNP	Indicates the number of IS-IS Complete Sequence Number Packet (CSNP) frames seen in this direction at this level.
PSNP	Indicates the number of IS-IS Partial Sequence Number Packets (PSNPs) seen in this direction at this level.
AbsoluteValue	Displays the counter value.
Cumulative	Displays the total value since you opened the Stats tab.

Table continues...

Name	Description
Average/Sec	Displays the average value for each second.
Minimum/Sec	Displays the minimum value for each second.
Maximum/Sec	Displays the maximum value for each second.
Last Val/Sec	Displays the last value for each second.

Graphing IS-IS interface receiving control packet statistics

Use the following procedure to graph IS-IS interface sending control packet statistics.

Procedure

1. In the navigation pane, expand the **Configuration > IS-IS** folders.
2. Click **IS-IS**.
3. Click the **Interfaces** tab.
4. Select an existing interface.
5. Click the **Graph** button.
6. Click the **Interface Receiving Control Packets** tab.

Interface Receiving Control Packets field descriptions

The following table describes the fields in the **Interface Receiving Control Packets** tab.

Name	Description
Hello	Indicates the number of IS-IS Hello PDUs seen in this direction at this level. Point-to-Point IIH PDUs are counted at the lowest enabled level: at L1 on L1 or L1L2 circuits, and at L2 otherwise.
LSP	Indicates the number of IS-IS link-state packet (LSP) frames seen in this direction at this level.
CSNP	Indicates the number of IS-IS Complete Sequence Number Packet (CSNP) frames seen in this direction at this level.
PSNP	Indicates the number of IS-IS Partial Sequence Number Packets (PSNPs) seen in this direction at this level.
AbsoluteValue	Displays the counter value.
Cumulative	Displays the total value since you opened the Stats tab.
Average/Sec	Displays the average value for each second.
Minimum/Sec	Displays the minimum value for each second.
Maximum/Sec	Displays the maximum value for each second.
Last Val/Sec	Displays the last value for each second.

Configuring an IS-IS Manual Area

Use the following procedure to configure an IS-IS manual area.

Procedure

1. In the navigation pane, expand the **Configuration > IS-IS** folders.
2. Click **IS-IS**.
3. Click the **Manual Area** tab.
4. Click **Insert**.
5. Specify an Area Address in the **AreaAddr** field, and click **Insert**.

Manual Area field descriptions

Use the data in the following table to use the **Manual Area** tab.

Name	Description
AreaAddr	Specifies the IS-IS manual area. Valid value is 1-13 bytes in the format <xx.xxxx.xxxx...xxx>. Only one manual area is supported. Use the same manual area across the entire SPBM cloud. For IS-IS to operate, you must configure at least one manual area.

Fabric Extend configuration using EDM

The following sections provide procedural information you can use to configure Fabric Extend (FE) using Enterprise Device Manager (EDM).

Configuring Fabric Extend tunnels

Use the following procedure to configure Fabric Extend (FE) between a VSP 8000 in a Main office to a VSP 4000 in a Branch office. This is a typical deployment. However, if your deployment creates tunnels between two switches that support Fabric Extend natively (VSP 7200 Series and the VSP 8000 Series) then repeat the VSP 8000 steps and ignore the VSP 4000 steps.

 **Note:**

VRF is an optional parameter. If a VRF is not configured, then FE uses the GRT.

Before you begin

The tunnel source IP address can be either a router port interface or a CLIP IP.

If using the tunnel originating address on the **GRT**, Fabric Extend has the following requirements:

- The tunnel source IP address must be on the GRT, not on a VRF.

*** Note:**

A Best Practice is to use separate IP addresses for the SPBM IP Shortcuts `ip-source-address` command and the Fabric Extend `ip-tunnel-source-address` command. However, if you want these IP addresses to be the same, you **MUST** exclude the `ip-source-address` address with an IS-IS accept policy. You cannot use the redistribute command with a route map exclusion.

Specify a CLIP interface to use as the source address for SPBM IP shortcuts.

- If IP Shortcuts is enabled, you must configure an IS-IS accept policy or exclude route-map to ensure that tunnel destination IP addresses are not learned through IS-IS.

If you are using the tunnel originating address on a **VRF**, Fabric Extend has the following requirements:

- Configure a CLIP and tunnel source IP address on the VRF.
- Remote management of the VSP 4000 is only possible after establishing IP Shortcut over IS-IS. (Alternatively, you can enable GRT-VRF redistribution locally.)

About this task

! Important:

In this procedure, the Switch A steps are for platforms that support Fabric Extend natively. The Switch B steps are for the 1 Gbps platforms that require an ONA to support Fabric Extend.

Configuring Fabric Extend consists of two primary tasks: configuring the tunnel source address and configuring the logical interface. These tasks must be completed on both ends of the tunnel.

Note that the VSP 4000 source address command is different than the VSP 7200/VSP 8000 Series command. Also note that the logical interface commands are different between Layer 2 and Layer 3 networks.

Procedure

VSP 8000 steps

1. In the navigation pane, expand the **Configuration > IS-IS > IS-IS** folders.
2. Click the Globals tab.
3. In the **IpTunnelSourceAddress** field, enter the IP tunnel source address.
4. If you are using a VRF, select its name from the drop down menu in the **IpTunnelVrf** field.
5. Click **Apply**.

VSP 4000 steps

*** Note:**

The interface VLAN connecting to the ONA network port is always in the GRT and the member port that the VLAN is part of is always an access port.

6. In the navigation pane, expand the **Configuration > IS-IS > IS-IS** folders.
7. Click the Globals tab.

8. In the **IpTunnelSourceAddress** field, enter the IP tunnel source address.
9. In the **IpTunnelPort** field, select from the drop down menu the physical port that the logical interface is connected to in an L2 network.
10. If you are using a VRF, select its name from the drop down menu in the **IpTunnelVrf** field.
11. In the **IpTunnelMtu** field, enter a value between 750 and 1950 to specify the size of the maximum transmission unit (MTU). The default is 1950. This parameter only applies to an ONA configuration.
12. Click **Apply**.

Fabric Extend field descriptions

Use the data in one of the following tables to use the **Globals** command, depending on whether you are configuring a VSP 4000 or a VSP 8000 switch.

Use the data in the following table to use the tab to configure a Fabric Extend tunnel source address.

Table 7: VSP 4000

Name	Description
IpTunnelSourceAddress	Specifies the IS-IS IPv4 tunnel source address.
IpTunnelPort	Specifies the physical port that the logical interface is connected to in an L2 network. The parameter is for the VSP 4000 only.
IpTunnelVrf	Specifies the VRF name associated with the IP tunnel.
IpTunnelMtu	Specifies the size of the maximum transmission unit (MTU). The default is 1950. This parameter only applies to an ONA configuration.

Table 8: VSP 8000

Name	Description
IpTunnelSourceAddress	Specifies the IS-IS IPv4 tunnel source address.
IpTunnelVrf	Specifies the VRF name associated with the IP tunnel.

Configuring Fabric Extend logical interfaces

Use the following procedure to configure Fabric Extend (FE) between a VSP 8000 in a Main office to a VSP 4000 in a Branch office. This is a typical deployment. However, if your deployment creates tunnels between two switches that support Fabric Extend natively (VSP 7200 Series and the VSP 8000 Series) then repeat the VSP 8000 steps and ignore the VSP 4000 steps.

*** Note:**

VRF is an optional parameter. If a VRF is not configured, then FE uses the GRT.

About this task

! Important:

In this procedure, the Switch A steps are for platforms that support Fabric Extend natively. The Switch B steps are for the 1 Gbps platforms that require an ONA to support Fabric Extend.

Configuring Fabric Extend consists of two primary tasks: configuring the tunnel source address and configuring the logical interface. These tasks must be completed on both ends of the tunnel.

Note that the VSP 4000 source address command is different than the VSP 7200/VSP 8000 Series command. Also note that the logical interface commands are different between Layer 2 and Layer 3 networks.

Procedure

VSP 8000 steps

1. In the navigation pane, expand the **Configuration > IS-IS > IS-IS** folders.
2. Click the Logical Interfaces tab.
3. In the **Id** field, enter the index number that uniquely identifies this logical interface.
4. In the **Name** field, enter the name of this logical interface.
5. In the **Type** field, select the type of core network that the tunnel will be traversing. If it's a Layer 2 Core, select **layer2**. If it's a Layer 3 Core, select **ip**.

*** Note:**

Different fields will be available depending on which type of core network you select.

6. For a Layer 2 Core, complete the following fields:
 - a. In the **DestIfIndex** field, click the ellipsis button (...) to select the physical port that the logical interface is connected to or enter the name of the MLT.
 - b. In the **Vids** field, enter the list of VLANs for this logical interface.
 - c. In the **PrimaryVid** field, enter the primary tunnel VLAN ID.

*** Note:**

The primary VLAN ID must be one of the VIDs listed in the **Vids** field.

7. For a Layer 3 Core, complete the following field:

In the **DestIPAddr** field, enter the destination IP address for the logical interface.
8. Click **Insert**.

VSP 4000 steps

*** Note:**

The interface VLAN connecting to the ONA network port is always in the GRT and the member port that the VLAN is part of is always an access port.

9. In the navigation pane, expand the **Configuration > IS-IS > IS-IS** folders.
10. Click the Logical Interfaces tab.
11. In the **Id** field, enter the index number that uniquely identifies this logical interface.
12. In the **Name** field, enter the name of this logical interface.
13. In the **Type** field, select the type of core network that the tunnel will be traversing. If it's a Layer 2 Core, select **layer2**. If it's a Layer 3 Core, select **ip**.

*** Note:**

Different fields will be available depending on which type of core network you select.

14. For a Layer 2 Core, complete the following fields:
 - a. In the **DestIfIndex** field, click the ellipsis button (...) to select the physical port that the logical interface is connected to or enter the name of the MLT.
 - b. In the **Vids** field, enter the list of VLANs for this logical interface.
 - c. In the **PrimaryVid** field, enter the primary tunnel VLAN ID.

*** Note:**

The primary VLAN ID must be one of the VIDs listed in the **Vids** field.

15. For a Layer 3 Core, complete the following field:

In the **DestIPAddr** field, enter the destination IP address for the logical interface.
16. Click **Insert**.

Fabric Extend logical interfaces field descriptions

Use the data in one of the following tables to use the **Logical Interfaces** command. The available fields are different depending on what type of core you select: **layer 2** or **ip**.

Table 9: Layer 2 core

Name	Description
Id	Specifies the index number that uniquely identifies this logical interface. This value is a read-only value.
Name	Specifies the administratively-assigned name of this logical interface, which can be up to 64 characters.
Type	Specify layer 2 for a Layer 2 core network that the tunnel will be traversing.

Table continues...

Name	Description
DestIfIndex	Specifies the physical port or MLT that the logical interface is connected to.
Vids	Specifies the list of VLANs that are associated with this logical interface.
PrimaryVid	Specifies the primary tunnel VLAN ID associated with this L2 IS-IS logical interface.

Table 10: Layer 3 core

Name	Description
Id	Specifies the index number that uniquely identifies this logical interface. This value is a read-only value.
Name	Specifies the administratively-assigned name of this logical interface, which can be up to 64 characters.
Type	Specify ip for a Layer 3 core network that the tunnel will be traversing.
DestIPAddr	Specifies the destination IP address for the logical interface.

Displaying the logical interface next hop

Use the following procedure to display the next hop for the logical interface.

Procedure

1. In the navigation pane, expand the **Configuration > IS-IS > IS-IS** folders.
2. Click the Logical Interfaces NextHop tab.

Logical interfaces next hop field descriptions

Use the data in one of the following tables to view the next hop for the logical Interface.

Name	Description
Id	Shows a unique value that identifies the logical interface tunnel.
Ip	Shows a unique value that identifies the next hop IP address of the logical interface tunnel.
DestIfIndex	Shows the next hop destination interface index to reach the next hop IP of the logical interface tunnel.
DestVid	Shows the next hop destination VLAN ID to reach the next hop IP of the logical interface tunnel.

Fabric Attach configuration using the EDM

The following sections provide procedural information you can use to configure Fabric Attach (FA) and Logical Link Discovery Protocol (LLDP) using Enterprise Device Manager (EDM).

Configuring Fabric Attach Globally

Use this procedure to configure FA globally or view existing FA global configuration.

Procedure

1. In the navigation pane, expand the **Configuration > Edit** folders.
2. Click **Fabric Attach**.
3. Click the **Globals** tab.
4. To enable or disable the Fabric Attach service, click **enabled** or **disabled** in the **Service** field.

 **Caution:**

Disabling FA flushes all FA element discovery and mappings.

5. View the element type in the **ElementType** field.

 **Note:**

The only supported element type is **faServer** (FA Server).

6. To specify the assignment time-out, enter a time-out value in seconds in the **AsgnTimeout** field.
7. View the provision mode in the **ProvisionMode** field.

 **Note:**

The supported provision mode is **spbm**.

8. To specify the discovery time-out, enter a time-out value in seconds in the **DiscTimeout** field.
9. To clear the FA statistics, select the **Clear FA Statistics** checkbox.
10. To clear the error counters, select the check boxes **ClearErrorCounters** and/or **ClearGlobalErrorCounters**.
11. Click **Apply**.

Fabric Attach Globals Field Descriptions

Use the data in the following table to use the **Fabric Attach Globals** tab.

Name	Description
Service	Enables or disables Fabric Attach service globally. The default is enable.
ElementType	Specifies the Fabric Attach element type. The supported element type is Fabric Attach Server.
AsgnTimeout	Specifies the Fabric Attach assignment time-out in seconds. The range is 45 to 480 seconds. The default is 240 seconds.
ProvisionMode	Specifies the Fabric Attach provision mode. The supported provision mode is SPB.
DiscTimeout	Specifies the Fabric Attach discovery time-out in seconds. The range is 45 to 480 seconds. The default is 240 seconds.
Clear FA Statistics	Clears Fabric Attach statistics.
ClearGlobalErrorCounters	Clears Fabric Attach global error counters. Disabled by default.

Configuring Fabric Attach I-SID-to-VLAN Assignments

Use this procedure to view or configure FA I-SID-to-VLAN assignment information.

Procedure

1. In the navigation pane, expand the **Configuration > Edit** folders.
2. Click **Fabric Attach**.
3. Click the **Assignment** tab.
4. If you make configuration changes, click **Apply** to save changes.

Assignments Field Descriptions

Use the data in the following table to use the Assignments tab.

Name	Description
IfIndex	Specifies the interface identifier of the I-SID-to-VLAN assignment.
Isid	Specifies the I-SID value of the I-SID-to-VLAN assignment.
Vlan	Specifies the VLAN ID component of the I-SID-to-VLAN assignment.
State	Specifies the current state of the I-SID-to-VLAN assignment. It can be one of the following values: <ul style="list-style-type: none"> • Other • Pending • Active • Rejected
Origin	Specifies the origin information of the I-SID-to-VLAN assignment.

Configuring Fabric Attach Interface-level Settings

Use this procedure to configure FA interface-level settings or view existing interface-level settings.

You can enable Fabric Attach on a port, static MLT or an LACP MLT. Enabling FA on a port not only enables tagging but also disables spanning tree on that port. Enabling FA on an MLT enables FA on all ports of the MLT. When FA is enabled on ports in an MLT or LACP MLT, tagging is enabled and spanning tree is disabled on all those ports.

Before you begin

Ensure that FA is enabled globally on the switch.

About this task

Enabling FA on a port or MLT is necessary for element discovery. On the FA Server, FA is enabled globally by default. However, you must explicitly enable FA on a desired port or MLT interface, following which the FA Server can begin transmitting LLDP PDUs that contain the element discovery TLVs. This information is received by FA Client and FA Proxy devices which in turn also transmit their FA capabilities and settings. After the element handshake completes, the FA Server receives I-SID-to-VLAN assignment mappings from the connected client or proxy devices, on that port or MLT.

Procedure

1. In the navigation pane, expand the **Configuration > Edit** folders.
2. Click **Fabric Attach**.
3. Click the **Ports** tab.

The FA interface-level settings are displayed.

4. To modify existing settings, double-click on the fields on this window. After making the required changes, click **Apply** to save your changes.
5. To configure FA on a new port or MLT interface:
 - a. Click **Insert**.
The **Insert Ports** dialog box appears.
 - b. To configure FA on a port, enter a port number in the format slot/port[/sub-port], or click **Port** to select from a list of available ports.
 - c. To configure FA on an MLT, enter an MLT ID or click **Mlt** to select from a list of configured MLTs.

Note:

FA is successfully enabled on the MLT, only if all ports of the MLT have FA successfully enabled. Enabling FA enables LLDP on all ports. Tagging is enabled and spanning tree is disabled.

- d. Click **Insert** to save your changes.
6. To remove (delete) FA on a port or MLT:
 - a. In the content pane, select a port or MLT from the list.

- b. Click **Delete**.

 **Caution:**

Removing FA on an interface flushes all FA element discovery and I-SID-to-VLAN mappings associated with that interface.

Ports Field Descriptions

Use the data in the following table to use the Ports tab.

Name	Description
IfIndex	Specifies the interface (port or MLT) on which Fabric Attach is configured.
State	Specifies the current state of the Fabric Attach port. It is either enabled or disabled. This field indicates whether LLDP PDUs (that include FA TLVs) are generated on the port (enabled) or not (disabled).
MsgAuthStatus	Specifies the Fabric Attach message authentication status on the port. It is either enabled or disabled.
MsgAuthKey	Specifies the Fabric Attach message authentication key for the associated port. The maximum length of this key is 32 characters.
Mgmtlsid	Specifies the Fabric Attach management I-SID for the associated port. The range is 0 to 16777215. A zero value indicates that the management I-SID is not specified for the interface.
MgmtCvid	Specifies the Fabric Attach management customer VLAN ID (C-VID) for the interface. A zero value indicates that no C-VID is specified for the interface. A value of 4096 indicates the port is untagged.

Viewing Fabric Attach discovered elements

Use this procedure to view discovered Fabric Attach elements.

About this task

When FA is enabled on an FA Server switch, LLDP PDUs are exchanged between the FA Server and FA Clients or Proxies. Standard LLDPs allow neighbors to be learned. In addition, organizational specific element discovery TLVs allow the Client or Proxy to recognize that it has attached to an FA Server. Only after the discovery handshake is complete, an FA Client or Proxy can transmit I-SID-to-VLAN assignments to join the SPB Fabric through the FA Server.

Procedure

1. In the navigation pane, expand the **Configuration > Edit** folders.
2. Click **Fabric Attach**.
3. In the content pane, click the **Elements** tab.

Elements field descriptions

Use the data in the following table to use the Elements tab.

Name	Description
IfIndex	Specifies the interface (port or MLT) at which the Fabric Attach element was discovered.
ElementType	Specifies the element type of the discovered Fabric Attach element, as advertised using LLDP. The supported element type is the Fabric Attach Server.
ElementVlan	Specifies the VLAN ID of the discovered Fabric Attach element, as advertised using LLDP.
ElementId	Specifies the system ID of the discovered Fabric Attach element, as advertised using LLDP.
ElementState	Specifies the state flag data associated with the discovered Fabric Attach element, as advertised using LLDP.
ElementOperAuthStatus	Specifies the authentication status of the discovered Fabric Attach element.
ElementAsgnsOperAuthStatus	Specifies the authentication status of remote assignments.
ElementAuth	Specifies the discovered element authentication status.
AsgnsAuth	Specifies the assignment authentication status.

Viewing FA statistics

Use this procedure to view FA statistics.

Procedure

1. In the navigation pane, expand the **Configuration > Edit** folders.
2. Click **Fabric Attach**.
3. In the content pane, click the **Stats** tab.

Stats field descriptions

Use the data in the following table to use the Stats tab.

Name	Description
PortIndex	Specifies the port for which the FA statistics are displayed.
DiscElemReceived	Specifies the number of element discoveries received on the port.
AsgnReceived	Specifies the number of remote assignments received on the port.
AsgnAccepted	Specifies the number of remote assignments accepted on the port.
AsgnRejected	Specifies the number of remote assignments rejected on the port.
AsgnExpired	Specifies the number of remote assignments that have expired, on the port.
AuthFailed	Specifies the number of authentications that have failed on the port.

Table continues...

Name	Description
DiscElemExpired	Specifies the number of discovery elements that have expired on the port.
DiscElemDeleted	Specifies the number of discovery elements that are deleted on the port.
AsgnDeleted	Specifies the number of remote assignments deleted on the port.

Configuring LLDP global information

Use this procedure to configure or view LLDP global information.

Procedure

1. In the navigation pane, expand the **Configuration > Edit > Diagnostics > 802_1ab** folders.
2. Click **LLDP**.
3. Click the **Globals** tab.
4. After you make the required configuration changes, click **Apply** to save changes.

Globals field descriptions

Use the data in the following table to use the **Globals** tab.

Field	Description
IldpMessageTxInterval	Specifies the interval at which LLDP messages are transmitted. The default is 30 seconds.
IldpMessageTxHoldMultiplier	Specifies the multiplier used to calculate the time-to-live (TTL) value of an LLDP message. The default value is 4 seconds.
IldpReinitDelay	Specifies the delay in seconds between the time a port is disabled and the time it is re-initialized. The default is 1 second.
IldpTxDelay	Specifies the delay in seconds between successive LLDP transmissions. The default is 1 second. The recommended value is as follows: $1 < \text{IldpTxDelay} < (0.25 \times \text{IldpMessageTxInterval})$
IldpNotificationInterval	Specifies the time interval between successive LLDP notifications. It controls the transmission of notifications. The default is 5 seconds.
Stats	
RemTablesLastChangeTime	Specifies the timestamp of LLDP missed notification events on a port, for example, due to transmission loss.
RemTablesInserts	Specifies the number of times the information advertised by a MAC Service Access Point (MSAP) is inserted into the respective tables.

Table continues...

Field	Description
RemTablesDeletes	Specifies the number of times the information advertised by an MSAP is deleted from the respective tables.
RemTablesDrops	Specifies the number of times the information advertised by an MSAP was not entered into the respective tables.
RemTablesAgeouts	Specifies the number of times the information advertised by an MSAP was deleted from the respective tables.

Viewing the LLDP port information

Use this procedure to view the LLDP port information.

Procedure

1. In the navigation pane, expand the **Configuration > Edit > Diagnostics > 802_1ab** folders.
2. Click **LLDP**.
3. Click the **Port** tab.
4. View the administrative status of the port in the **AdminStatus** field. To modify, double-click on a cell and select a value from the drop-down list.
5. View whether the port is enabled for notifications in the **NotificationEnable** field. To modify, double-click on a cell and select a value from the drop-down list.
6. View the set of TLVs whose transmission using LLDP is always allowed by network management in the **TLVsTxEnable** field.
7. **(Optional)** Modify the TLVs as follows:
 - a. To enable a TLV, select the appropriate check box, and click **Ok**. You can select more than one check box.
 - b. To enable all TLVs, click **Select All**, and click **Ok**.
 - c. To disable all TLVs, click **Disable All**, and click **Ok**.
8. View the CDP administrative status in the **CdpAdminState** field. To modify, double-click on a cell and select a value from the drop-down list.
9. Click **Apply** to save any configuration changes.
10. Click **Refresh** to verify the configuration.

Port field descriptions

Use the data in the following table to use the **Port** tab.

Name	Description
PortNum	Specifies the port number. This is a read-only cell.
AdminStatus	Specifies the administrative status of the port. The options are: <ul style="list-style-type: none"> • txOnly: LLDP frames are only transmitted on this port.

Table continues...

Name	Description
	<ul style="list-style-type: none"> • rxOnly: LLDP frames are only received on this port. • txAndRx: LLDP frames are transmitted and received on this port. • disabled: LLDP frames are neither transmitted or received on this port. Any information received on this port from remote systems before this is disabled, ages out. <p>The default is disabled.</p>
NotificationEnable	<p>Specifies whether the port is enabled or disabled for notifications.</p> <ul style="list-style-type: none"> • true: indicates that the notifications are enabled. • false: indicates that the notifications are disabled. <p>The default is false.</p>
TLVsTxEnable	<p>Specifies the set of TLVs whose transmission using LLDP is always allowed by network management.</p> <p>The following list describes the TLV types:</p> <ul style="list-style-type: none"> • portDesc — indicates that the Port Description TLV is transmitted. • sysName — indicates that the System Name TLV. is transmitted. • sysDesc — indicates that the System Description TLV. is transmitted. • sysCap — indicates that the System Capabilities TLV. is transmitted. <p>The default is an empty set of TLVs.</p>
CdpAdminState	<p>Specifies the CDP administrative status of the port. Configure this field to true to enable the Industry Standard Discovery Protocol (ISDP) on a port. ISDP is CDP-compatible.</p> <ul style="list-style-type: none"> • true: indicates CDP is enabled. • false: indicates CDP is disabled. <p>The default is false.</p> <p>If CDP is enabled, the interface accepts only CDP packets. Similarly, if CDP is disabled but LLDP is enabled, the interface accepts only LLDP packets. To switch a port from CDP mode to LLDP mode, the LLDP status on that port must be txAndRx.</p>

Viewing LLDP Transmission Statistics

Use this procedure to view the LLDP transmission statistics. You can also view the statistics graphically.

About this task

LLDP operates at the port interface level. Enabling FA on a port automatically enables LLDP transmission and reception on that port. It also enables traffic tagging and disables spanning tree on that port.

Enabling FA on an MLT enables LLDP transmission and reception on *all* ports in that MLT.

*** Note:**

When a port is removed from an MLT, LLDP transmission on that port stops and spanning tree is enabled. Any I-SID-to-VLAN mappings on that port are removed, if not already learned on any other port in the MLT. This also causes the Switched UNI I-SID to be deleted from the MLT. If however, the mappings are learned on another port on the MLT, then the Switched UNI I-SID continues to exist for that MLT.

For ports in an LACP MLT, when FA is enabled, tagging is enabled on all ports in the LACP MLT. The consistency check for FA is based on key membership. If all ports with the same key do not support FA, FA is not successfully enabled on those ports.

*** Note:**

If a slot is removed from the switch chassis, the statistics are not displayed on the slot ports. When the slot is inserted back again, the statistics counters are reset.

Procedure

1. In the navigation pane, expand the **Configuration > Edit > Diagnostics > 802_1ab** folders.
2. Click **LLDP**.
3. Click the **TX Stats** tab.

The transmission statistics are displayed.

4. To view the transmission statistics graphically for a port:
 - a. In the content pane (on the right-hand-side), select a row and click the **Graph** button.

The **TX Stats-Graph,<port-number>** tab displays.

You can view a graphical representation of the LLDP frames transmitted (**FramesTotal**), for the following parameters:

- AbsoluteValue
 - Cumulative
 - Average/sec
 - Minimum/sec
 - Maximum/sec
 - LastVal/sec
- b. To view the graph, select one of the above parameters and click the appropriate icon on the top left-hand-side of the menu bar to draw a line chart, area chart, bar chart or a pie chart.
 - c. Click **Clear Counters** to clear the existing counters, and fix a reference point in time to restart the counters.
 - d. Click **Export**, to export the statistical data to a file.
 - e. To fix a poll interval, select an appropriate value from the **Poll Interval** drop-down list.

TX Stats Field Descriptions

Use the data in the following table to use the TX Stats tab.

Name	Description
PortNum	Specifies the port number.
FramesTotal	Specifies the total number of LLDP frames transmitted.

Viewing LLDP Reception Statistics

Use this procedure to view the LLDP reception statistics. You can also view these statistics graphically.

About this task

LLDP operates at the port interface level. Enabling FA on a port automatically enables LLDP transmission and reception on that port. It also enables traffic tagging and disables spanning tree on that port.

Enabling FA on an MLT enables LLDP transmission and reception on *all* ports in that MLT.

* Note:

When a port is removed from an MLT, LLDP transmission on that port stops and spanning tree is enabled. Any I-SID-to-VLAN mappings on that port are removed, if not already learned on any other port in the MLT. This also causes the Switched UNI I-SID to be deleted from the MLT. If however, the mappings are learned on another port on the MLT, then the Switched UNI I-SID continues to exist for that MLT.

For ports in an LACP MLT, when FA is enabled, tagging is enabled on all ports in the LACP MLT. The consistency check for FA is based on key membership. If all ports with the same key do not support FA, FA is not successfully enabled on those ports.

* Note:

If a slot is removed from the switch chassis, the statistics are not displayed on the slot ports. When the slot is inserted back again, the statistics counters are reset.

Procedure

1. In the navigation pane, expand the **Configuration > Edit > Diagnostics > 802_1ab** folders.
2. Click **LLDP**.
3. Click the **RX Stats** tab.
4. To view the reception statistics graphically for a port:
 - a. Select a row and click **Graph**.

The **RX Stats-Graph,<port-number>** tab displays.

You can view a graphical representation of the following data:

- **FramesDiscardedTotal** — Total number of LLDP received frames that were discarded.

- **FramesErrors** — Total number of erroneous LLDP frames received.
 - **FramesTotal** — Total number of frames received.
 - **TLVsDiscardedTotal** — Total number of received TLVs that were discarded.
 - **TLVsUnrecognizedTotal** — Total number of unrecognized TLVs received.
- b. Select one of the above parameters and click the appropriate icon on the top left-hand-side corner of the menu bar to draw a line chart, area chart, bar chart or a pie chart.
 - c. Click **Clear Counters** to clear the existing counters, and fix a reference point in time to restart the counters.
 - d. Click **Export**, to export the statistical data to a file.
 - e. To fix a poll interval, select an appropriate value from the **Poll Interval** drop-down list.

RX Stats Field Descriptions

Use the data in the following table to use the RX Stats tab.

Name	Description
PortNum	Specifies the port number.
FramesDiscardedTotal	Specifies the number of LLDP frames received on the port, but discarded, for any reason. This counter provides an indication of possible LLDP header formatting problems in the sending system, or LLDP PDU validation problems in the receiving system.
FramesErrors	Specifies the number of invalid LLDP frames received on the port.
FramesTotal	Specifies the total number of LLDP frames received on the port.
TLVsDiscardedTotal	Specifies the number of LLDP TLVs discarded on the port, for any reason.
TLVsUnrecognizedTotal	Specifies the number of LLDP TLVs on the port, that are unrecognized on that port. An unrecognized TLV is referred to as the TLV whose type value is in the range of reserved TLV types (000 1001–111 1110). An unrecognized TLV could be, for example, a basic management TLV from a later LLDP version.
AgeoutsTotal	Specifies the number of LLDP age-outs that occur on a specific port. An age-out is the number of times the complete set of information advertised by a particular MSAP is deleted, because the information timeliness interval has expired.

Viewing LLDP local system information

Use this procedure to view the LLDP local system information.

Procedure

1. In the navigation pane, expand the **Configuration > Edit > Diagnostics > 802_1ab** folders.
2. Click **LLDP**.

3. Click the **Local System** tab.

Local System field descriptions

Use the data in the following table to use the **Local System** tab.

Name	Description
ChassisIdSubType	Indicates the encoding used to identify the local system chassis. <ul style="list-style-type: none"> • chassisComponent • interfaceAlias • portComponent • macAddress • networkAddress • interfaceName • local
ChassisId	Indicates the chassis ID of the local system.
SysName	Indicates local system name.
SysDesc	Indicates local system description.
SysCapSupported	Indicates the system capabilities supported on the local system.
SysCapEnabled	Indicates the system capabilities that are enabled on the local system.

Viewing LLDP local port information

Use this procedure to view the LLDP local port information.

Procedure

1. In the navigation pane, expand the **Configuration > Edit > Diagnostics > 802_1ab** folders.
2. Click **LLDP**.
3. Click the **Local Port** tab.

Local port field descriptions

Use the data in the following table to use the **Local Port** tab.

Name	Description
PortNum	Indicates the port number.
PortIdSubType	Indicates the type of port identifier. <ul style="list-style-type: none"> • interfaceAlias • portComponent • macAddress • networkAddress • interfaceName

Table continues...

Name	Description
	<ul style="list-style-type: none"> agentCircuitId local
PortId	Indicates the identifier associated with the port, on the local system.
PortDesc	Indicates the description of the port, on the local system.

Viewing LLDP Neighbor Information

Use this procedure to view the LLDP neighbor information.

Procedure

1. In the navigation pane, expand the **Configuration > Edit > Diagnostics > 802_1ab** folders.
2. Click **LLDP**.
3. Click the **Neighbor** tab.

Neighbor Field Descriptions

Use the data in the following table to use the Neighbor tab.

Name	Description
TimeMark	Indicates the time filter. For more information about TimeFilter, see the TimeFilter textual convention in IETF RFC 2021.
LocalPortNum	Identifies the port on which the remote system information is received.
Index	Indicates a particular connection instance that is unique to the remote system.
ProtocolType	Indicates whether the entry protocol is CDP or LLDP.
SysName	Indicates the name of the remote system.
IpAddress	Indicates the neighbor's IP address.
PortIdSubType	Indicates the type of encoding used to identify the remote port.
PortId	Indicates the remote port ID.
PortDesc	Indicates the remote port description.
ChassisIdSubtype	Indicates the type of encoding used to identify the remote system chassis. <ul style="list-style-type: none"> chassisComponent interfaceAlias portComponent macAddress networkAddress interfaceName local
ChassisId	Indicates the chassis ID of the remote system.

Table continues...

Name	Description
SysCapSupported	Identifies the system capabilities supported on the remote system.
SysCapEnabled	Identifies the system capabilities enabled on the remote system.
SysDesc	Indicates the description of the remote system.

Viewing Global FA Statistics Graphically

Use this procedure to view the global FA statistics graphically.

Procedure

1. In the navigation pane, expand the **Graph > Chassis** folders.
2. Click the **Fabric Attach** tab.
The global FA statistics are displayed.
3. To view a graphical representation of the statistics, select a row and click the appropriate icon on the top left-hand-side of the menu bar to draw a line chart, area chart, bar chart or a pie chart.
4. Click **Clear Counters** to clear the existing counters, and fix a reference point in time to restart the counters.
5. Click **Export**, to export the statistical data to a file.
6. To fix a poll interval, select an appropriate value from the **Poll Interval** drop-down list.

Fabric Attach Field Descriptions

Use the data in the following table to use the Fabric Attach tab.

Name	Description
DiscElemReceived	Specifies the number of discovery elements received globally.
AsgnReceived	Specifies the number of remote I-SID-to-VLAN assignments received globally.
AsgnAccepted	Specifies the number of remote I-SID-to-VLAN assignments accepted globally.
AsgnRejected	Specifies the number of remote I-SID-to-VLAN assignments rejected globally.
AsgnExpired	Specifies the number of remote I-SID-to-VLAN assignments that expired globally.
AuthFailed	Specifies the number of authentications that failed globally.
DiscAuthFailed	Specifies the number of discovery authentications that failed globally.
DiscElemExpired	Specifies the number of discovery elements that expired globally.
DiscElemDeleted	Specifies the number of discovery elements that were deleted globally.
AsgnDeleted	Specifies the number of remote assignments that were deleted globally.

Viewing FA Port Statistics Graphically

Use this procedure to view the FA port statistics graphically.

Before you begin

Ensure that a switch port is selected in the **Device Physical View** tab.

Procedure

1. In the navigation pane, expand the **Graph > Port** folders.
2. Click the **Fabric Attach** tab.
The FA port statistics are displayed.
3. To view a graphical representation of the port statistics, select a row and click the appropriate icon on the top left-hand-side of the menu bar to draw a line chart, area chart, bar chart or a pie chart.
4. Click **Clear Counters** to clear the existing counters, and fix a reference point in time to restart the counters.
5. Click **Export**, to export the statistical data to a file.
6. To fix a poll interval, select an appropriate value from the **Poll Interval** drop-down list.

Fabric Attach Field Descriptions

Use the data in the following table to use the Fabric Attach tab.

Name	Description
DiscElemReceived	Specifies the number of discovery elements received on a given port.
AsgnReceived	Specifies the number of remote I-SID-to-VLAN assignments received on a given port.
AsgnAccepted	Specifies the number of remote I-SID-to-VLAN assignments accepted on a given port.
AsgnRejected	Specifies the number of remote I-SID-to-VLAN assignments rejected on a given port.
AsgnExpired	Specifies the number of remote I-SID-to-VLAN assignments that expired on a given port.
AuthFailed	Indicates the number of received TLVs for which authentication was attempted and failed on the identified port.
DiscElemExpired	Specifies the number of discovery elements that expired on a given port.
DiscElemDeleted	Specifies the number of discovery elements that were deleted on a given port.
AsgnDeleted	Specifies the number of remote assignments that were deleted on a given port.

Inserting a Zero Touch Client

Use this procedure to insert a FA Zero Touch Client.

Procedure

1. In the navigation pane, expand the **Configuration > Edit** folders.
2. Click **Fabric Attach**.
3. Click the **Zero Touch Client Auto Attach** tab.
4. Click **Insert**.

The **Insert Zero Touch Client** dialog box appears.

5. In the **Type** field click the ellipsis and select a client. Click **Ok** to select the client or **Refresh** to update the list.
6. In the **ISID** field enter the ISID value.
The ISID value is between 0 and 16777214.
7. Click **Insert**.

Configuring FA Zero Touch Client auto attach

Use this procedure to configure FA Zero Touch Client auto attach.

Procedure

1. In the navigation pane, expand the **Configuration > Edit** folders.
2. Click **Fabric Attach**
3. Click the **Zero Touch Client Auto Attach** tab.

From the Zero Touch Client Auto Attach tab you can configure a number of auto attach settings.

4. Click **Insert**.
5. In the **Type** field click the ellipsis and select a client.
6. Click **Ok** to select the client or **Refresh** to update the list.
7. In the **ISID** field enter the ISID value.
8. Click **Insert**.
9. **(Optional)** To **Delete** a FA Zero Touch client select it from the auto attach table and click **Delete**.

Zero Touch Client Auto Attach Field Descriptions

Use the data in the following table to use the Zero Touch Client Auto Attach tab

Field	Description
Type	This column describes the type of client assigned to auto attach. Available FA client types are: <ul style="list-style-type: none"> • Wireless AP (Type 1)

Table continues...

Field	Description
	<ul style="list-style-type: none"> • Wireless AP (Type 2) • Switch • Router • IP Phone • IP Camera • IP Video • Security Device • Virtual Switch • Server Endpoint • ONA (SDN) • ONA (spb0IP)
ClientName	FA client name.
Isid	Specifies the I-SID value of the I-SID-to-VLAN assignment.

Configuring Dynamic Nickname Assignment

About this task

Use this procedure to enable Dynamic Nickname Assignment and specify a nickname allocation range. The default status is disabled. The default nickname allocation range is A (A.00.00-A.FF.FF).

 **Note:**

You must disable Dynamic Nickname Assignment before you can change the nickname allocation range.

Procedure

1. In the navigation pane, expand the **Configuration > IS-IS** folders.
2. Click **SPBM**.
3. Click the **Globals** tab.
4. To enable the Nick-name server, click **enable** in the **NicknameServerEnable** field.
5. In the **NicknameServerRange** field, select the nickname server allocation range.

Globals field descriptions

Use the data in the following table to use the **Globals** tab.

Name	Description
GlobalEnable	Enables or disables SPBM globally. The default is disabled.
GlobalEtherType	Specifies the global ether type value as 0x8100 or 0x88a8. The default value is 0x8100.
NicknameServerEnable	Enables or disables the nickname server. The default is disabled.
NicknameDynamicAllocationStatus	Displays the Dynamic Nickname Allocation service operational status. This value is read-only.
NicknameServerRange	Specifies the nickname allocation range for Dynamic Nickname Assignment. The default is rangeA (A.00.00 to A.FF.FF).

SPBM configuration examples

This section provides configuration examples to configure basic SPBM and IS-IS infrastructure.

Examples and network illustrations in this document may illustrate only one of the supported platforms. Unless otherwise noted, the concept illustrated applies to all supported platforms.

Basic SPBM configuration example

The following figure shows a sample greenfield deployment for SPBM.

Figure 22: Greenfield SPBM deployment

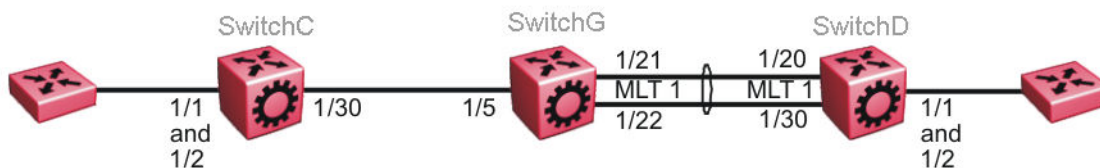

*** Note:**

For migration purposes, SPBM can coexist with existing SMLT configurations.

Ethernet and MLT configuration

The following sections show the steps required to configure the Ethernet and MLT interfaces in this example.

SwitchC

```
PORT CONFIGURATION - PHASE 1
interface GigabitEthernet 1/30
encapsulation dot1q
exit
```

SwitchG

```
PORT CONFIGURATION - PHASE 1
interface GigabitEthernet 1/5
encapsulation dot1q
exit

MLT CONFIGURATION

mlt 1 enable
mlt 1 member 1/21-1/22
mlt 1 encapsulation dot1q
```

SwitchD

```
MLT CONFIGURATION

mlt 1 enable
mlt 1 member 1/20,1/30
mlt 1 encapsulation dot1q
```

IS-IS SPBM global configuration

The following figure shows the IS-IS area information added to the network.

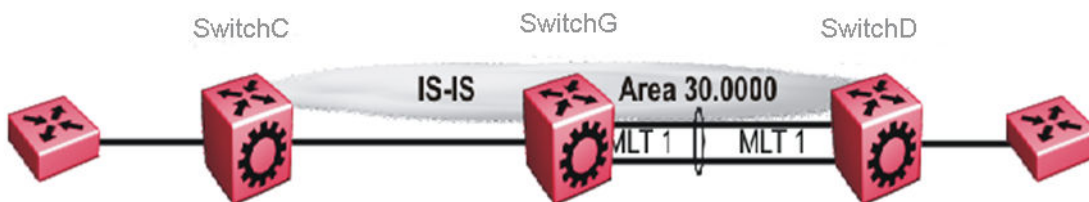

Figure 23: IS-IS SPBM global

The following sections show the steps required to configure the global IS-IS SPBM parameters in this example.

SwitchC

```

enable
configure terminal
prompt SwitchC

BOOT CONFIGURATION

spbm
spbm ethertype 0x8100

ISIS SPBM CONFIGURATION

router isis
spbm 1
spbm 1 nick-name f.30.13
spbm 1 b-vid 20

ISIS CONFIGURATION

is-type 11
manual-area 30.0000
sys-name SwitchC
exit
router isis enable

VLAN CONFIGURATION

vlan create 20 name "B-VLAN" type spbm-bvlan

```

SwitchG

```

enable
configure terminal
prompt SwitchG

BOOT CONFIGURATION

spbm
spbm ethertype 0x8100

ISIS SPBM CONFIGURATION

router isis
spbm 1
spbm 1 nick-name f.30.10
spbm 1 b-vid 20

ISIS CONFIGURATION

is-type 11
manual-area 30.0000
sys-name SwitchG
exit
router isis enable

VLAN CONFIGURATION

vlan create 20 name "B-VLAN" type spbm-bvlan

```

SwitchD

```

enable
configure terminal

```

```

prompt SwitchD

BOOT CONFIGURATION

spbm
spbm ethertype 0x8100

ISIS SPBM CONFIGURATION

router isis
spbm 1
spbm 1 nick-name f.30.14
spbm 1 b-vid 20

ISIS CONFIGURATION

is-type 11
manual-area 30.0000
sys-name SwitchD
exit
router isis enable

VLAN CONFIGURATION

vlan create 20 name "B-VLAN" type spbm-bvlan
    
```

IS-IS SPBM Interface Configuration

The following figure shows the IS-IS area information and interfaces in the network.

Figure 24: IS-IS SPBM interface

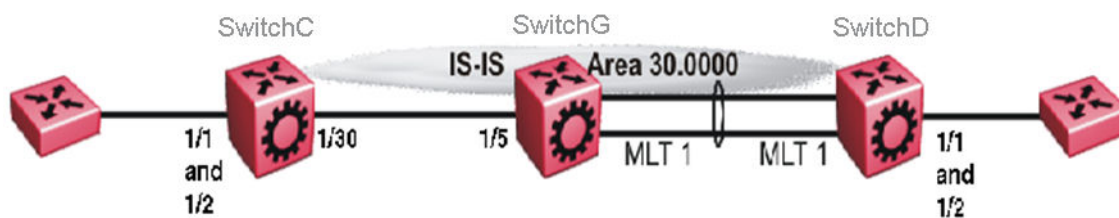

The following sections show the steps required to configure the IS-IS SPBM interfaces in this example.

SwitchC

```

PORT CONFIGURATION - PHASE II

interface GigabitEthernet 1/30
isis
isis spbm 1
isis enable
exit
    
```

SwitchG

```
PORT CONFIGURATION - PHASE II
```

```
interface GigabitEthernet 1/5
isis
isis spbm 1
isis enable
exit
```

```
MLT INTERFACE CONFIGURATION
```

```
interface mlt 1
isis
isis spbm 1
isis enable
exit
```

SwitchD

```
MLT INTERFACE CONFIGURATION
```

```
interface mlt 1
isis
isis spbm 1
isis enable
exit
```

Verifying SPBM operations

The following sections show the output from verifying the sample IS-IS SPBM configuration.

Checking operation — SwitchC

```
SwitchC:1# show isis interface
```

```
=====
                        ISIS Interfaces
=====
IFIDX      TYPE      LEVEL      OP-STATE  ADM-STATE  ADJ      UP-ADJ  SPBM-L1-METRIC
-----
Port1/30   pt-pt    Level 1    UP        UP         1        1        10
```

```
SwitchC:1# show isis adjacencies
```

```
=====
                        ISIS Adjacencies
=====
INTERFACE      L STATE      UPTIME PRI  HOLDDTIME  SYSID      HOST-NAME      STATUS
-----
Port1/30       1 UP         1d 19:19:52  22  beb0.0000.7204  SwitchC      ACTIVE
```

```
-----
1 out of 1 interfaces have formed an adjacency
-----
```

```
SwitchC:1# show isis spbm unicast-fib
```

```
=====
                        SPBM UNICAST FIB ENTRY INFO
=====
DESTINATION      BVLAN  SYSID      HOST-NAME  OUTGOING-INTERFACE  COST
ADDRESS
-----
00:0e:62:25:a3:df  4000   000e.6225.a3df  SwitchG    1/30
00:14:0d:a0:13:df  4000   0014.0da0.13df  SwitchD    1/30
```

```
-----
Total number of SPBM UNICAST FIB entries 2
```

```
SwitchC:1# show isis spbm unicast-tree 4000
Node:000e.6225.a3df.00 (SwitchG) -> ROOT
Node:0014.0da0.13df.00 (SwitchD) -> Node:000e.6225.a3df.00 (SwitchG) ->
ROOT
```

Checking operation — SwitchG

```
SwitchG:1# show isis interface
```

```
=====
                        ISIS Interfaces
=====
```

IFIDX	TYPE	LEVEL	OP-STATE	ADM-STATE	ADJ	UP-ADJ	SPBM-L1-METRIC
Port1/5	pt-pt	Level 1	UP	UP	1	1	10
Mlt1	pt-pt	Level 1	UP	UP	1	1	10

```
SwitchG:1# show isis adjacencies
```

```
=====
                        ISIS Adjacencies
=====
```

INTERFACE	L	STATE	UPTIME	PRI	HOLDTIME	SYSID	HOST-NAME	STATUS
Port1/5	1	UP	1d 19:19:52	127	26	beb0.0000.7204	SwitchC	ACTIVE
Mlt1	1	UP	04:57:34	127	20	0014.0da0.13df	SwitchD	ACTIVE

2 out of 2 interfaces have formed an adjacency

```
SwitchG:1# show isis spbm unicast-fib
```

```
=====
                        SPBM UNICAST FIB ENTRY INFO
=====
```

DESTINATION	ADDRESS	BVLAN	SYSID	HOST-NAME	OUTGOING-INTERFACE	COST
00:14:0d:a0:13:df		4000	0014.0da0.13df	SwitchD	MLT-1	
00:15:e8:9f:e3:df		4000	0015.e89f.e3df	SwitchC	1/5	

```
SwitchG:1# show isis spbm unicast-tree 4000
Node:0015.e89f.e3df.00 (SwitchC) -> ROOT
Node:0014.0da0.13df.00 (SwitchD) -> ROOT
```

Checking operation — SwitchD

```
SwitchD:1# show isis interface
```

```
=====
                        ISIS Interfaces
=====
```

IFIDX	TYPE	LEVEL	OP-STATE	ADM-STATE	ADJ	UP-ADJ	SPBM-L1-METRIC
Mlt1	pt-pt	Level 1	UP	UP	1	1	10

```
SwitchD:1# show isis adjacencies
```

```
=====
                        ISIS Adjacencies
=====
```

INTERFACE	L	STATE	UPTIME	PRI	HOLDTIME	SYSID	HOST-NAME	STATUS
Mlt1	1	UP	05:03:59	127	21	000e.6225.a3df	SwitchG	ACTIVE

1 out of 1 interfaces have formed an adjacency

```
SwitchD:1# show isis spbm unicast-fib
```

```
=====
                        SPBM UNICAST FIB ENTRY INFO
=====
```

DESTINATION	ADDRESS	BVLAN	SYSID	HOST-NAME	OUTGOING-INTERFACE	COST
-------------	---------	-------	-------	-----------	--------------------	------

```

00:0e:62:25:a3:df    4000    000e.6225.a3df SwitchG    MLT-1
00:15:e8:9f:e3:df    4000    0015.e89f.e3df SwitchC    MLT-1

SwitchD:1# show isis spbm unicast-tree 4000
Node:000e.6225.a3df.00 (SwitchG) -> ROOT
Node:0015.e89f.e3df.00 (SwitchC) -> Node:000e.6225.a3df.00 (SwitchG) ->
ROOT

```

Fabric Extend configuration examples

This section provides configuration examples to configure Fabric Extend in the following deployment scenarios.

- [Fabric Extend over IP using the GRT](#) on page 227
- [Fabric Extend over IP using a VRF](#) on page 230
- [Fabric Extend over VPLS](#) on page 233
- [Fabric Extend over Pseudowires](#) on page 236
- [Fabric Extend with ONAs in the core and branches](#) on page 238

For more configuration examples, see *Shortest Path Bridging (802.1aq) Technical Configuration Guide*.

Fabric Extend over IP using the GRT

This example shows a typical Fabric Extend deployment with a 10/40/100 Gbps switch in the core and a 1 Gbps switch in one of the branch offices. The 10/40/100 Gbps switch supports Fabric Extend natively and is connected over an IP network to a 1 Gbps switch, which requires an ONA to encapsulate SPB traffic with a VXLAN header. The ONA sets up a bridge between the ONA device-side port and the ONA network-side port. Fabric Extend uses a VXLAN tunnel to send traffic to and from the 10/40/100 Gbps switch through the 1 Gbps switch to the ONA.

*** Note:**

- This deployment uses the **GRT** so the tunnel source IP address must be on the GRT, not on a VRF.
- If IP Shortcuts is enabled, you must configure an IS-IS accept policy or exclude route-map to ensure that tunnel destination IP addresses are not learned through IS-IS.
- Add any IP address used for setting up the logical tunnel (such as local network and loopback IP addresses) to the IS-IS accept policy or exclude route-map to prevent these addresses from being advertised into IS-IS.

The following figure shows a sample Fabric Extend deployment over IP using the GRT.

SPBM and IS-IS infrastructure configuration

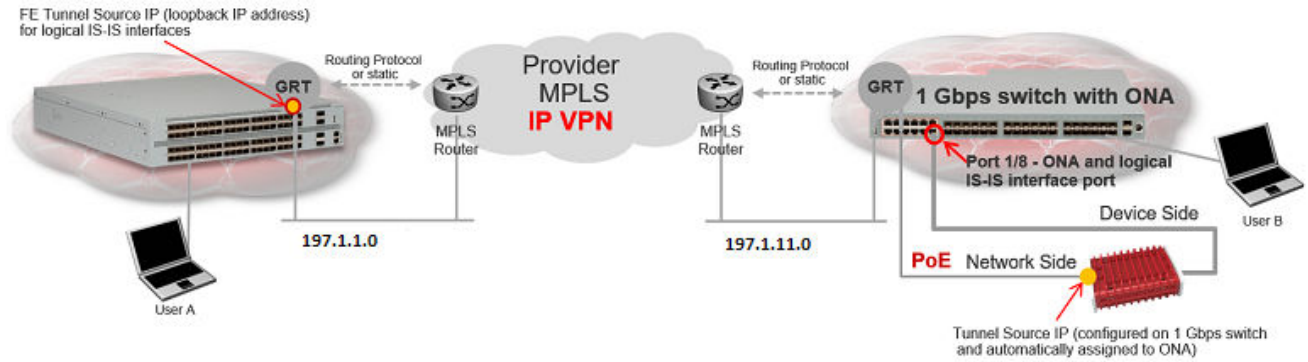

Figure 25: IP using GRT traffic flow

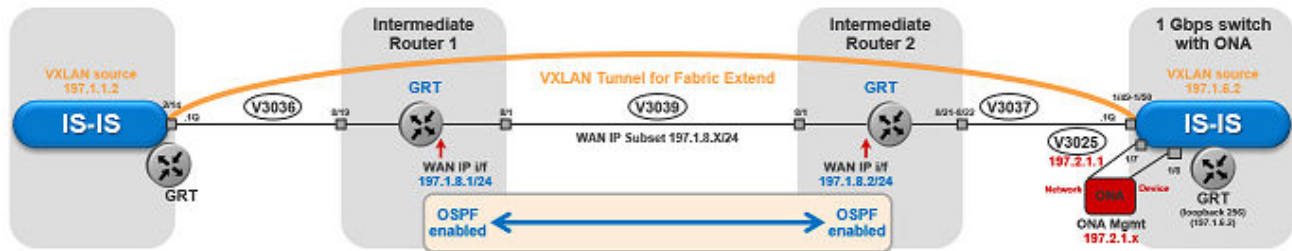

Figure 26: IP (GRT) traffic flow component view

For 10/40/100 Gbps Switches:

(The tunnel source IP address is configured in the GRT.)

```
Switch(config)# interface GigabitEthernet 2/14
Switch(config-if)# no shutdown
Switch(config-if)# default-vlan-id 0
Switch(config-if)# name "ospf-intf-SP-core"
Switch(config-if)# brouter port 2/14 vlan 3036 subnet 197.1.1.2/255.255.255.0
Switch(config-if)# no spanning-tree mstp force-port-state enable
Switch(config-if)# ip ospf enable
Switch(config-if)# exit

Switch(config)# router isis
Switch(config-isis)# ip-tunnel-source-address 197.1.1.2
Switch(config-isis)# exit

Switch(config)# logical-intf isis 255 dest-ip 197.1.6.2 name "Tunnel-to-Branch1"
Switch(config-isis-255-197.1.6.2)# isis
Switch(config-isis-255-197.1.6.2)# isis spbm 1
Switch(config-isis-255-197.1.6.2)# isis enable
Switch(config-isis-255-197.1.6.2)# exit

Switch(config)# ip prefix-list "isis-tunnel-addr" 197.1.0.0/16 ge 16 le 32
Switch(config)# route-map "deny-isis-tunnel-network" 1
Switch(route-map)# no permit
Switch(route-map)# enable
Switch(route-map)# match network "isis-tunnel-addr"
Switch(route-map)# match protocol isis
Switch(route-map)# exit

Switch(config)# router isis
Switch(config-isis)# accept route-map "deny-isis-tunnel-network"
Switch(config-isis)# exit
```

```
Switch(config)# isis apply accept
```

For 1 Gbps Switches:

(The tunnel source address is a CLIP address on the GRT. This address is configured on the 1 Gbps switch and then automatically assigned to the ONA.)

```
Switch(config)# interface loopback 256
Switch(config-if)# ip address 256 197.1.6.2/255.255.255.0
Switch(config-if)# ip ospf 256
Switch(config-if)# exit

Switch(config)# interface GigabitEthernet 1/7-1/8; enables ports to ONA
Switch(config-if)# no shutdown
Switch(config-if)# exit

Switch(config)# vlan create 3037 name "ospf-intf-SP-core" type port-mstprstp 0
Switch(config)# vlan members 3037 1/49-1/50 portmember
Switch(config)# mlt 11
Switch(config)# mlt 11 encapsulation dot1q
Switch(config)# mlt 11 mem 1/49-1/50
Switch(config)# mlt 11 vlan 3037
Switch(config)# interface vlan 3037
Switch(config-if)# ip address 197.1.11.2 255.255.255.0 0
Switch(config-if)# ip ospf enable
Switch(config-if)# exit

Switch(config)# vlan create 3025 name "ONA-Mgmt-vlan" type port-mstprstp 0
Switch(config)# vlan members 3025 1/7 portmember
Switch(config)# interface vlan 3025
Switch(config-if)# ip address 197.2.1.1 255.255.255.0 3
Switch(config-if)# exit

Switch(config)# ip dhcp-relay fwd-path 197.2.1.1 197.10.1.11
Switch(config)# ip dhcp-relay fwd-path 197.2.1.1 197.10.1.11 enable
Switch(config)# ip dhcp-relay fwd-path 197.2.1.1 197.10.1.11 mode bootp_dhcp

Switch(config)# router isis
Switch(config-isis)# ip-tunnel-source-address 197.1.6.2 port 1/8 mtu 1950
Switch(config-isis)# exit
Switch(config)# logical-intf isis 255 dest-ip 197.1.1.2 name "Tunnel-to-HQ"
Switch(config-isis-255-197.1.1.2)# isis
Switch(config-isis-255-197.1.1.2)# isis spbm 1
Switch(config-isis-255-197.1.1.2)# isis enable
Switch(config-isis-255-197.1.1.2)# exit

Switch(config)# ip prefix-list "isis-tunnel-addr" 197.1.0.0/16 ge 16 le 32
Switch(config)# route-map "deny-isis-tunnel-network" 1
Switch(route-map)# no permit
Switch(route-map)# enable
Switch(route-map)# match network "isis-tunnel-addr"
Switch(route-map)# match protocol isis
Switch(route-map)# exit

Switch(config)# router isis
Switch(config-isis)# accept route-map "deny-isis-tunnel-network"
Switch(config-isis)# exit
Switch(config)# isis apply accept
```

Intermediate routers are typically configured by an Internet service provider (ISP). The following configurations are for reference only.

For Intermediate Router 1:

```
Switch(config)# interface GigabitEthernet 8/19
Switch(config-if)# default-vlan-id 0
Switch(config-if)# name "ospf-intf-from-Headoffice"
Switch(config-if)# no shutdown
Switch(config-if)# brouter port 8/19 vlan 3036 subnet 197.1.1.3/255.255.255.0 mac-offset 2
Switch(config-if)# ip ospf enable
Switch(config-if)# exit

Switch(config)# vlan create 3039 name "core-ospf-vlan" type port-mstprstp 0
Switch(config)# vlan members 3039 8/1 portmember
Switch(config)# interface Vlan 3039
Switch(config)# ip address 197.1.8.1 255.255.255.0 2
Switch(config)# ip ospf enable
Switch(config)# exit
```

For Intermediate Router 2:

```
Switch(config)# vlan create 3039 name "core-ospf-vlan" type port-mstprstp 0
Switch(config)# vlan members 3039 8/1 portmember
Switch(config)# interface Vlan 3039
Switch(config)# ip address 197.1.8.2 255.255.255.0 0
Switch(config)# ip ospf enable
Switch(config)# exit

Switch(config)# vlan create 3037 name "ospf-intf-from-branch1" type port-mstprstp 0
Switch(config)# vlan members 3037 8/21-8/22 portmember
Switch(config)# mlt 11
Switch(config)# mlt 11 encapsulation dot1q
Switch(config)# mlt 11 mem 8/21-8/22
Switch(config)# mlt 11 vlan 3037
Switch(config)# interface Vlan 3037
Switch(config)# ip address 197.1.11.1 255.255.255.0 5
Switch(config)# ip ospf enable
Switch(config)# exit
```

Fabric Extend over IP using a VRF

This example is the same as the previous IP example except this Fabric Extend deployment uses a VRF instead of the GRT. Because this deployment is using a **VRF**, Fabric Extend has the following requirements:

- Configure a CLIP and tunnel source IP address on the same VRF.
- Remote management of the 1 Gbps switch is only possible after establishing IP Shortcut over IS-IS. (Alternatively, you can enable GRT-VRF redistribution locally.)

The following figure shows a sample Fabric Extend deployment over IP using a VRF.

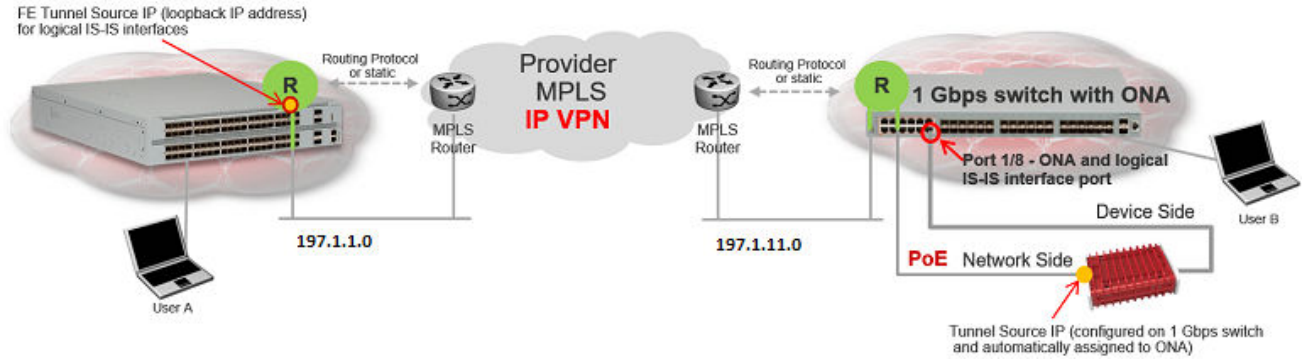

Figure 27: IP using VRF traffic flow

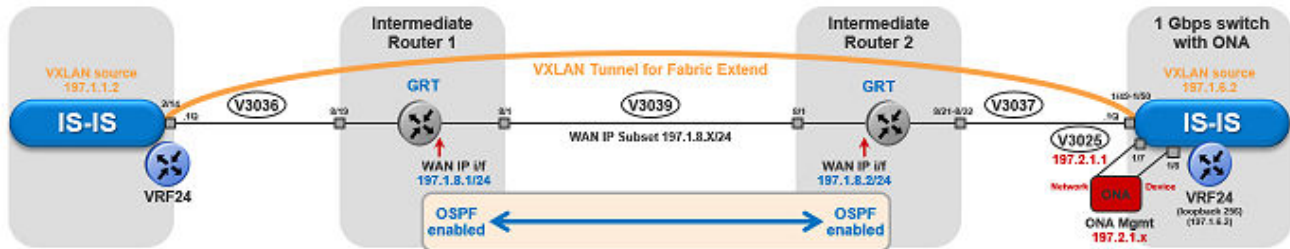

Figure 28: IP (VRF) traffic flow component view

For 10/40/100 Gbps Switches:

(The tunnel source IP address is configured as a brouter address in the VRF.)

```
Switch(config)# ip vrf vrf24
Switch(config)# router vrf vrf24
Switch(router-vrf)# ip ospf
Switch(router-vrf)# ip ospf admin-state
Switch(router-vrf)# exit

Switch(config)# interface GigabitEthernet 2/14
Switch(config-if)# no shutdown
Switch(config-if)# default-vlan-id 0
Switch(config-if)# name "ospf-intf-SP-core"
Switch(config-if)# vrf vrf24
Switch(config-if)# brouter port 2/14 vlan 3036 subnet 197.1.1.2/255.255.255.0 mac-offset 1
Switch(config-if)# no spanning-tree mstp force-port-state enable
Switch(config-if)# ip ospf enable
Switch(config-if)# exit

Switch(config)# router isis
Switch(config-isis)# ip-tunnel-source-address 197.1.1.2 vrf vrf24
Switch(config-isis)# exit

Switch(config)# logical-intf isis 255 dest-ip 197.1.6.2 name "Tunnel-to-Branch1"
Switch(config-isis-255-197.1.6.2)# isis
Switch(config-isis-255-197.1.6.2)# isis spbm 1
Switch(config-isis-255-197.1.6.2)# isis enable
Switch(config-isis-255-197.1.6.2)# exit
```

For 1 Gbps Switches:

(The tunnel source address is a CLIP address on the VRF. This address is configured on the 1 Gbps switch and then automatically assigned to the ONA.)

```
Switch(config)# ip vrf vrf24

Switch(config)# router vrf vrf24
Switch(router-vrf)# ip ospf
Switch(router-vrf)# ip ospf admin-state
Switch(router-vrf)# exit

Switch(config)# interface loopback 256
Switch(config-if)# ip address 197.1.6.2 255.255.255.255 vrf vrf24
Switch(config-if)# ip ospf vrf vrf24
Switch(config-if)# exit

Switch(config)# interface GigabitEthernet 1/7-1/8; enables ports to ONA
Switch(config-if)# no shutdown
Switch(config-if)# exit

Switch(config)# vlan create 3037 name "ospf-intf-SP-core" type port-mstprstp 0
Switch(config)# vlan members 3037 1/49-1/50 portmember
Switch(config)# mlt 11
Switch(config)# mlt 11 encapsulation dot1q
Switch(config)# mlt 11 mem 1/49-1/50
Switch(config)# mlt 11 vlan 3037
Switch(config)# interface vlan 3037
Switch(config-if)# vrf vrf24
Switch(config-if)# ip address 197.1.11.2 255.255.255.0 0
Switch(config-if)# ip ospf enable
Switch(config-if)# exit

Switch(config)# vlan create 3025 name "ONA-Mgmt-vlan" type port-mstprstp 0
Switch(config)# vlan members 3025 1/7 portmember
Switch(config)# interface vlan 3025
Switch(config-if)# ip address 197.2.1.1 255.255.255.0 3
Switch(config-if)# exit

Switch(config)# ip dhcp-relay fwd-path 197.2.1.1 197.10.1.11
Switch(config)# ip dhcp-relay fwd-path 197.2.1.1 197.10.1.11 enable
Switch(config)# ip dhcp-relay fwd-path 197.2.1.1 197.10.1.11 mode bootp_dhcp

Switch(config)# router isis
Switch(config-isis)# ip-tunnel-source-address 197.1.6.2 port 1/8 vrf vrf24 mtu 1950
Switch(config-isis)# exit

Switch(config)# logical-intf isis 255 dest-ip 197.1.1.2 name "Tunnel-to-HQ"
Switch(config-isis-255-197.1.1.2)# isis
Switch(config-isis-255-197.1.1.2)# isis spbm 1
Switch(config-isis-255-197.1.1.2)# isis enable
Switch(config-isis-255-197.1.1.2)# exit
```

Intermediate routers are typically configured by an Internet service provider (ISP). The following configurations are for reference only.

For Intermediate Router 1:

```
Switch(config)# interface GigabitEthernet 8/19
Switch(config-if)# default-vlan-id 0
Switch(config-if)# name "ospf-intf-from-Headoffice"
Switch(config-if)# no shutdown
Switch(config-if)# brouter port 8/19 vlan 3036 subnet 197.1.1.3/255.255.255.0 mac-offset 2
```



```
Switch(config-if)# ip ospf enable
Switch(config-if)# exit

Switch(config)# vlan create 3039 name "core-ospf-vlan" type port-mstprstp 0
Switch(config)# vlan members 3039 8/1 portmember
Switch(config)# interface Vlan 3039
Switch(config)# ip address 197.1.8.1 255.255.255.0 2
Switch(config)# ip ospf enable
Switch(config)# exit
```

For Intermediate Router 2:

```
Switch(config)# vlan create 3039 name "core-ospf-vlan" type port-mstprstp 0
Switch(config)# vlan members 3039 8/1 portmember
Switch(config)# interface Vlan 3039
Switch(config)# ip address 197.1.8.2 255.255.255.0 0
Switch(config)# ip ospf enable
Switch(config)# exit

Switch(config)# vlan create 3037 name "ospf-intf-from-branch1" type port-mstprstp 0
Switch(config)# vlan members 3037 8/21-8/22 portmember
Switch(config)# mlt 11
Switch(config)# mlt 11 encapsulation dot1q
Switch(config)# mlt 11 mem 8/21-8/22
Switch(config)# mlt 11 vlan 3037
Switch(config)# interface Vlan 3037
Switch(config)# ip address 197.1.11.1 255.255.255.0 5
Switch(config)# ip ospf enable
Switch(config)# exit
```

Fabric Extend over VPLS

This example shows a Fabric Extend deployment over MPLS Virtual Private LAN Service (VPLS). In this scenario, VPLS emulates a LAN with full mesh connectivity. The SPB nodes connect with point-to-point Ethernet links and also use MPLS for normal forwarding.

* Note:

On the Core side, the 10/40/100 Gbps switches require a single next hop IP address as a default gateway for all tunnels. To ensure the single next hop, VPLS uses a loopback IP address and an additional VRF.

The following figure shows a sample Fabric Extend deployment over VPLS.

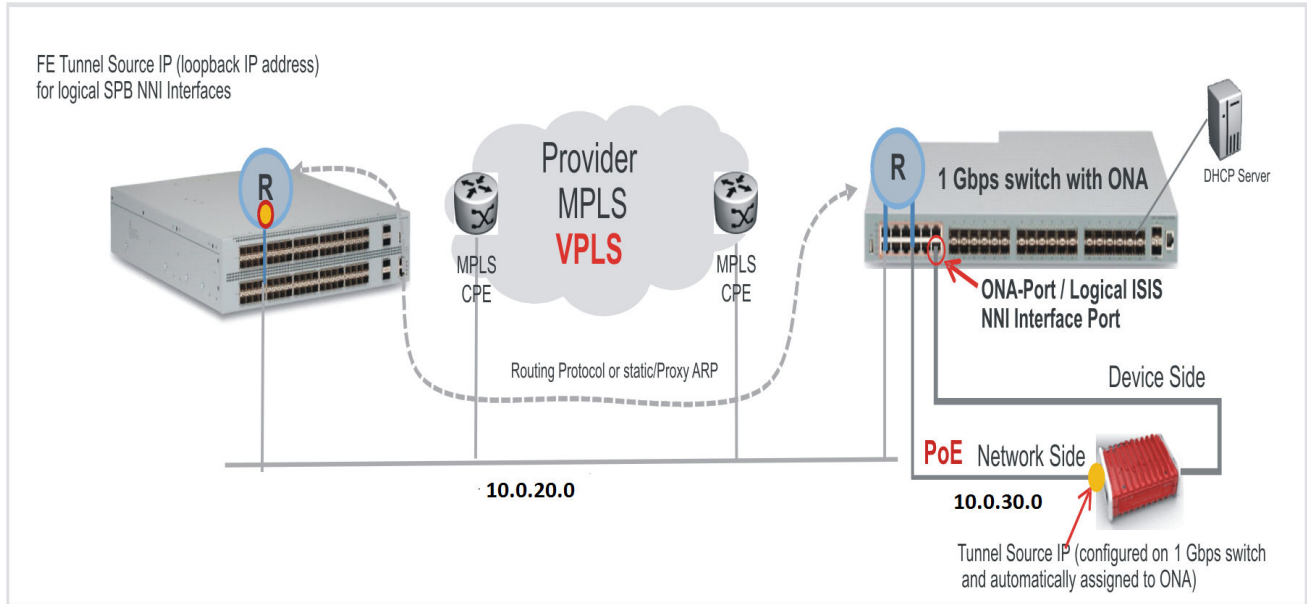

Figure 29: FE over VPLS traffic flow

For 10/40/100 Gbps Switches:

(The tunnel source IP address is configured as a brouter address in the VRF.)

```
Switch(config)# interface GigabitEthernet 2/14
Switch(config-if)# no shutdown
Switch(config-if)# default-vlan-id 0
Switch(config-if)# name "ospf-intf-SP-core"
Switch(config-if)# vrf vrf24
Switch(config-if)# brouter port 2/14 vlan 3036 subnet 197.1.1.2/255.255.255.0 mac-offset 1
Switch(config-if)# no spanning-tree mstp force-port-state enable
Switch(config-if)# ip ospf enable
Switch(config-if)# exit

Switch(config)# router isis
Switch(config-isis)# ip-tunnel-source-address 197.1.1.2 vrf vrf24
Switch(config-isis)# exit
Switch(config)# logical-intf isis 255 dest-ip 197.1.6.2 name "Tunnel-to-Branch1"
Switch(config-isis-255-197.1.6.2)# isis
Switch(config-isis-255-197.1.6.2)# isis spbm 1
Switch(config-isis-255-197.1.6.2)# isis enable
Switch(config-isis-255-197.1.6.2)# exit
```

For 1 Gbps Switches:

(The tunnel source address is a CLIP address on the VRF. This address is configured on the 1 Gbps switch and then automatically assigned to the ONA.)

```
Switch(config)# ip vrf vrf24

Switch(config)# router vrf vrf24
Switch(router-vrf)# ip ospf
Switch(router-vrf)# ip ospf admin-state
Switch(router-vrf)# exit
```

```

Switch(config)# interface loopback 256
Switch(config-if)# ip address 197.1.6.2 255.255.255.255 vrf vrf24
Switch(config-if)# ip ospf vrf vrf24
Switch(config-if)# exit

Switch(config)# interface GigabitEthernet 1/7-1/8; enables ports to ONA
Switch(config-if)# no shutdown
Switch(config-if)# exit

Switch(config)# vlan create 3037 name "ospf-intf-SP-core" type port-mstprstp 0
Switch(config)# vlan members 3037 1/49-1/50 portmember
Switch(config)# mlt 11
Switch(config)# mlt 11 encapsulation dot1q
Switch(config)# mlt 11 mem 1/49-1/50
Switch(config)# mlt 11 vlan 3037
Switch(config)# interface vlan 3037
Switch(config-if)# vrf tunnel
Switch(config-if)# ip address 197.1.11.2 255.255.255.0 0
Switch(config-if)# ip ospf enable
Switch(config-if)# exit

Switch(config)# vlan create 3025 name "ONA-Mgmt-vlan" type port-mstprstp 0
Switch(config)# vlan members 3025 1/7 portmember
Switch(config)# interface vlan 3025
Switch(config-if)# ip address 197.2.1.1 255.255.255.0 3
Switch(config-if)# exit

Switch(config)# ip dhcp-relay fwd-path 197.2.1.1 197.10.1.11
Switch(config)# ip dhcp-relay fwd-path 197.2.1.1 197.10.1.11 enable
Switch(config)# ip dhcp-relay fwd-path 197.2.1.1 197.10.1.11 mode bootp_dhcp

Switch(config)# router isis
Switch(config-isis)# ip-tunnel-source-address 197.1.6.2 port 1/8 vrf vrf24 mtu 1950
Switch(config-isis)# exit
Switch(config)# logical-intf isis 255 dest-ip 197.1.1.2 name "Tunnel-to-HQ"
Switch(config-isis-255-197.1.1.2)# isis
Switch(config-isis-255-197.1.1.2)# isis spbm 1
Switch(config-isis-255-197.1.1.2)# isis enable
Switch(config-isis-255-197.1.1.2)# exit

```

Intermediate routers are typically configured by an Internet service provider (ISP). The following configurations are for reference only.

For Intermediate Router 1:

```

Switch(config)# interface GigabitEthernet 8/19
Switch(config-if)# default-vlan-id 0
Switch(config-if)# name "ospf-intf-from-Headoffice"
Switch(config-if)# no shutdown
Switch(config-if)# brouter port 8/19 vlan 3036 subnet 197.1.1.3/255.255.255.0 mac-offset 2
Switch(config-if)# ip ospf enable
Switch(config-if)# exit

Switch(config)# vlan create 3039 name "core-ospf-vlan" type port-mstprstp 0
Switch(config)# vlan members 3039 8/1 portmember
Switch(config)# interface Vlan 3039
Switch(config)# ip address 197.1.8.1 255.255.255.0 2
Switch(config)# ip ospf enable
Switch(config)# exit

```

For Intermediate Router 2:

```
Switch(config)# vlan create 3039 name "core-ospf-vlan" type port-mstprstp 0
Switch(config)# vlan members 3039 8/1 portmember
Switch(config)# interface Vlan 3039
Switch(config)# ip address 197.1.8.2 255.255.255.0 0
Switch(config)# ip ospf enable
Switch(config)# exit

Switch(config)# vlan create 3037 name "ospf-intf-from-branch1" type port-mstprstp 0
Switch(config)# vlan members 3037 8/21-8/22 portmember
Switch(config)# mlt 11
Switch(config)# mlt 11 encapsulation dot1q
Switch(config)# mlt 11 mem 8/21-8/22
Switch(config)# mlt 11 vlan 3037
Switch(config)# interface Vlan 3037
Switch(config)# ip address 197.1.11.1 255.255.255.0 5
Switch(config)# ip ospf enable
Switch(config)# exit
```

Fabric Extend over Layer 2 Pseudowire

This example shows a Fabric Extend deployment using service provider VLAN tunnels over MPLS Pseudowire. In this scenario, you map two dedicated VLAN IDs (VIDs) from the Hub to the Spoke sites. Then the logical IS-IS interfaces translate the BVIDs to map them to the per branch provider VIDs. Because the tunnels are point-to-point VLAN connections, not VXLAN, there is no need to encapsulate a VXLAN header to SPB packets. Therefore, the 1 Gbps switches in this type of deployment do not require ONAs.

! Important:

10/40/100 Gbps switch — — — — — Core — — — — — 1 Gbps switch

- You cannot have IS-IS in the Core.
- Do not create the two VLANs represented in the logical interface connection on the BEBs. If you do, you will not be able add any Fabric Extend ports to be members of those VLANs. One links the port that is facing the core and those VLANs in the logical interface connection.

The following figure shows a sample Fabric Extend deployment over Pseudowire.

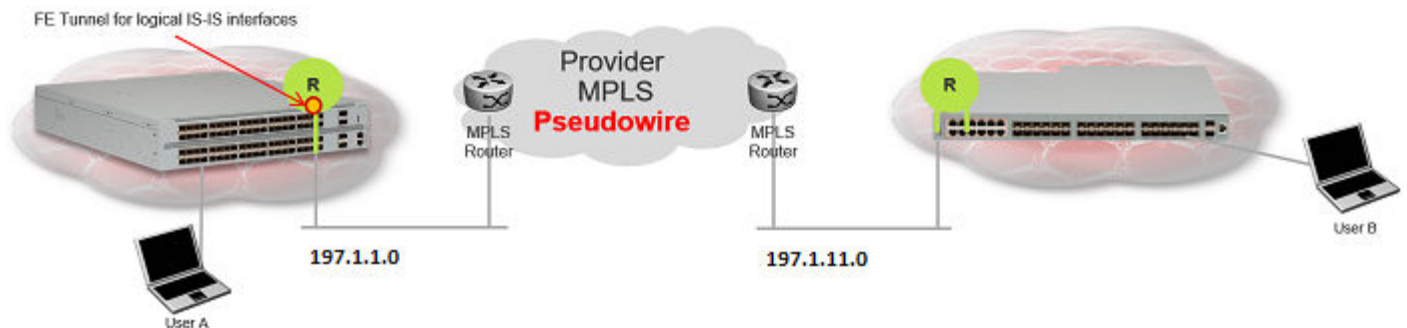

Figure 30: FE over Pseudowire traffic flow



Figure 31: FE over Pseudowire traffic flow component view

For 10/40/100 Gbps Switches:

*** Note:**

Logical interface VLANs cannot be the same as the SPBM B-VLANs and you cannot create these VLANs locally. Use these VLANs for configuring the logical interface only. Once a port is being used for a logical interface it cannot be added to any platform VLAN and spanning tree is automatically disabled on the port.

```
Switch(config)# logical-intf isis 255 vid 200,300 primary-vid 200 port 2/14 name
fe_to_Switch
Switch(config-isis-255)# isis
Switch(config-isis-255)# isis spbm 1
Switch(config-isis-255)# isis enable
Switch(config-isis-255)# exit
```

For 1 Gbps Switches:

*** Note:**

Logical interface VLANs cannot be the same as the SPBM B-VLANs and you cannot create these VLANs locally. Use these VLANs for configuring the logical interface only. Once a port is being used for a logical interface it cannot be added to any platform VLAN and spanning tree is automatically disabled on the port.

```
Switch(config)# mlt 11
Switch(config)# mlt 11 encapsulation dot1q
Switch(config)# mlt 11 mem 1/49-1/50
Switch(config)# router isis enable

Switch(config)# logical-intf isis 255 vid 200,300 primary-vid 200 mlt 11 name fe_to_Switch
Switch(config-isis-255)# isis
Switch(config-isis-255)# isis spbm 1
Switch(config-isis-255)# isis enable
Switch(config-isis-255)# exit
```

Intermediate routers are typically configured by an Internet service provider (ISP). The following configurations are for reference only.

For Intermediate Router 1:

```
Switch(config)# vlan create 200 type port-mstprstp 1
Switch(config)# vlan create 300 type port-mstprstp 1
Switch(config)# vlan member add 200 8/1,8/19
Switch(config)# vlan member add 300 8/1,8/19
```

For Intermediate Router 2:

```
Switch(config)# mlt 11
Switch(config)# mlt 11 encapsulation dot1q
Switch(config)# mlt 11 mem 8/21-8/22
```

```
Switch(config)# vlan create 200 type port-mstprstp 1
Switch(config)# vlan create 300 type port-mstprstp 1
Switch(config)# vlan member add 200 8/1
Switch(config)# vlan mlt 200 11
Switch(config)# vlan member add 300 8/1
Switch(config)# vlan mlt 300 11
```

Fabric Extend with ONAs in the core and branches

This example shows a Fabric Extend deployment with 1 Gbps switches in the core of the network and in the branch sites. This type of deployment is not only a lower cost Fabric Extend solution, it also addresses situations where large MTU sizes (over 1594 bytes) are a problem for the Service Provider.

MTU sizes less than 1594 bytes require fragmentation and reassembly of packets and the 1 Gbps switch with ONA supports fragmentation and reassembly. However, you must have 1 Gbps switches with ONAs at BOTH ends of the IP WAN connection.

! Important:

There is no fragmentation/reassembly support in Layer 2 core solutions.

The following figure shows a sample Fabric Extend deployment using VRFs with both switches.

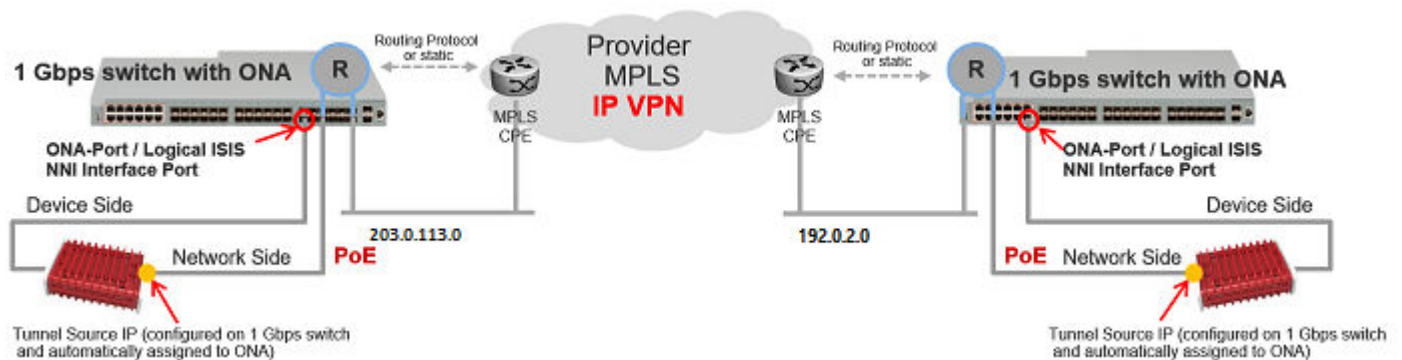

Figure 32: Fabric Extend traffic flow

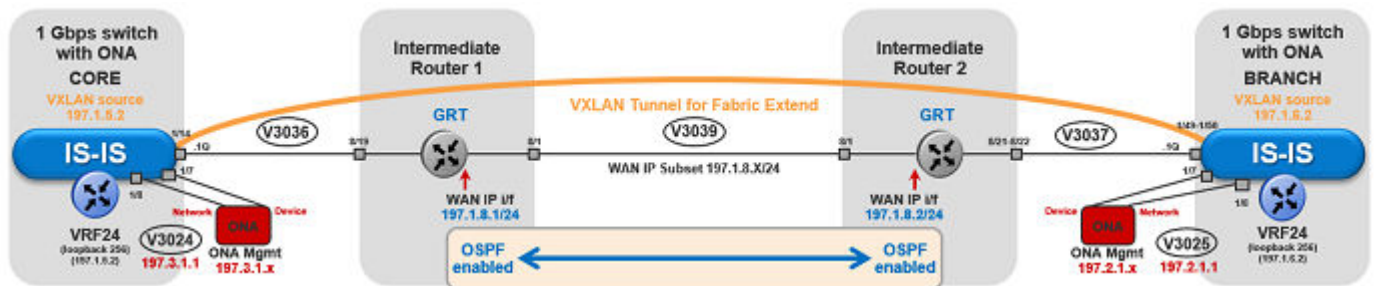

Figure 33: Fabric Extend traffic flow component view

Core switch configuration:

(The tunnel source address is a CLIP address on the VRF. This address is configured on the switch and then automatically assigned to the ONA.)

```
Switch(config)# ip vrf vrf24
Switch(config)# router vrf vrf24
Switch(router-vrf)# ip ospf
Switch(router-vrf)# ip ospf admin-state
Switch(router-vrf)# exit

Switch(config)# interface loopback 256
Switch(config-if)# ip address 197.1.5.2 255.255.255.255 vrf vrf24
Switch(config-if)# ip ospf vrf vrf24
Switch(config-if)# exit

Switch(config)# interface GigabitEthernet 1/7-1/8; enables ports to ONA
Switch(config-if)# no shutdown
Switch(config-if)# exit

Switch(config)# vlan create 3036 name "ospf-intf-SP-core" type port-mstprstp 0
Switch(config)# vlan members 3036 1/14 portmember
Switch(config)# interface vlan 3036
Switch(config)# vrf vrf24
Switch(config-if)# ip address 197.1.1.2 255.255.255.0 0
Switch(config-if)# ip ospf enable
Switch(config-if)# exit

Switch(config)# vlan create 3024 name "ONA-Mgmt-vlan" type port-mstprstp 0
Switch(config)# vlan members 3024 1/8 portmember
Switch(config)# interface vlan 3024
Switch(config-if)# ip address 197.3.1.1 255.255.255.0 3
Switch(config-if)# exit

Switch(config)# ip dhcp-relay fwd-path 197.3.1.1 197.10.1.11
Switch(config)# ip dhcp-relay fwd-path 197.3.1.1 197.10.1.11 enable
Switch(config)# ip dhcp-relay fwd-path 197.3.1.1 197.10.1.11 mode bootp_dhcp

Switch(config)# router isis
Switch(config-isis)# ip-tunnel-source-address 197.1.5.2 port 1/7 vrf vrf24 mtu 1950
Switch(config-isis)# exit
Switch(config)# logical-intf isis 255 dest-ip 197.1.6.2 name "Tunnel-to-Branch1"
Switch(config-isis-255-197.1.6.2)# isis
Switch(config-isis-255-197.1.6.2)# isis spbm 1
Switch(config-isis-255-197.1.6.2)# isis enable
Switch(config-isis-255-197.2.1.1)# exit
```

Branch switch configuration:

(The tunnel source address is a CLIP address on the VRF. This address is configured on the switch and then automatically assigned to the ONA.)

```
Switch(config)# ip vrf vrf24

Switch(config)# router vrf vrf24
Switch(router-vrf)# ip ospf
Switch(router-vrf)# ip ospf admin-state
Switch(router-vrf)# exit

Switch(config)# interface loopback 256
Switch(config-if)# ip address 197.1.6.2 255.255.255.255 vrf vrf24
Switch(config-if)# ip ospf vrf vrf24
Switch(config-if)# exit
```

SPBM and IS-IS infrastructure configuration

```
Switch(config)# interface GigabitEthernet 1/7-1/8; enables ports to ONA
Switch(config-if)# no shutdown
Switch(config-if)# exit

Switch(config)# vlan create 3037 name "ospf-intf-SP-core" type port-mstprstp 0
Switch(config)# vlan members 3037 1/49-1/50 portmember
Switch(config)# interface vlan 3037
Switch(config-if)# vrf vrf24
Switch(config-if)# ip address 197.1.11.2 255.255.255.0 0
Switch(config-if)# ip ospf enable
Switch(config-if)# exit

Switch(config)# vlan create 3025 name "ONA-Mgmt-vlan" type port-mstprstp 0
Switch(config)# vlan members 3025 1/8 portmember
Switch(config)# interface vlan 3025
Switch(config-if)# ip address 197.2.1.1 255.255.255.0 3
Switch(config-if)# exit

Switch(config)# ip dhcp-relay fwd-path 197.2.1.1 197.10.1.11
Switch(config)# ip dhcp-relay fwd-path 197.2.1.1 197.10.1.11 enable
Switch(config)# ip dhcp-relay fwd-path 197.2.1.1 197.10.1.11 mode bootp_dhcp

Switch(config)# router isis
Switch(config-isis)# ip-tunnel-source-address 197.1.6.2 port 1/7 vrf vrf24 mtu 1950
Switch(config-isis)# exit
Switch(config)# logical-intf isis 255 dest-ip 197.1.5.2 name "Tunnel-to-HQ"
Switch(config-isis-255-197.1.1.2)# isis
Switch(config-isis-255-197.1.1.2)# isis spbm 1
Switch(config-isis-255-197.1.1.2)# isis enable
Switch(config-isis-255-197.1.1.2)# exit
```

Intermediate routers are typically configured by an Internet service provider (ISP). The following configurations are for reference only.

Intermediate Router 1 configuration:

```
Switch(config)# interface GigabitEthernet 8/19
Switch(config-if)# default-vlan-id 0
Switch(config-if)# name "ospf-intf-from-Headoffice"
Switch(config-if)# no shutdown
Switch(config-if)# brouter port 8/19 vlan 3036 subnet 197.1.1.3/255.255.255.0 mac-offset 2
Switch(config-if)# ip ospf enable
Switch(config-if)# exit

Switch(config)# vlan create 3039 name "core-ospf-vlan" type port-mstprstp 0
Switch(config)# vlan members 3039 8/1 portmember
Switch(config)# interface Vlan 3039
Switch(config)# ip address 197.1.8.1 255.255.255.0 2
Switch(config)# ip ospf enable
Switch(config)# exit
```

Intermediate Router 2 configuration:

```
Switch(config)# vlan create 3039 name "core-ospf-vlan" type port-mstprstp 0
Switch(config)# vlan members 3039 8/1 portmember
Switch(config)# interface Vlan 3039
Switch(config)# ip address 197.1.8.2 255.255.255.0 0
Switch(config)# ip ospf enable
Switch(config)# exit
```



```
Switch(config)# vlan create 3037 name "ospf-intf-from-branch1" type port-mstprstp 0
Switch(config)# vlan members 3037 8/21-8/22 portmember
Switch(config)# mlt 11
Switch(config)# mlt 11 encapsulation dot1q
Switch(config)# mlt 11 mem 8/21-8/22
Switch(config)# mlt 11 vlan 3037
Switch(config)# interface Vlan 3037
Switch(config)# ip address 197.1.11.1 255.255.255.0 5
Switch(config)# ip ospf enable
Switch(config)# exit
```

Fabric Attach configuration examples

This section provides configuration examples to configure Fabric Attach.

Configuring a Fabric Attach solution

The following section describes a simple configuration example to configure Fabric Attach (FA) at the edge of a Fabric Connect network. This is a typical deployment at its simplest level and is powerful because of its use in conjunction with a Fabric Connect core.

About this task

Configuring FA primarily consists of configuring the FA Server. The FA Server in turn *discovers* neighboring FA component devices (like the FA Proxies and FA Clients) using FA TLVs within the LLDP PDUs.

In the following deployment, the switch at the edge of the Fabric Connect cloud is configured as the FA Server. On this switch, FA is enabled globally and at the interface (port) level. Another switch, functioning as the FA Proxy connects to the FA enabled port (1/3) on the FA Server. User A is an end user device that needs to send and receive data traffic from User B (another end user device) across the network.

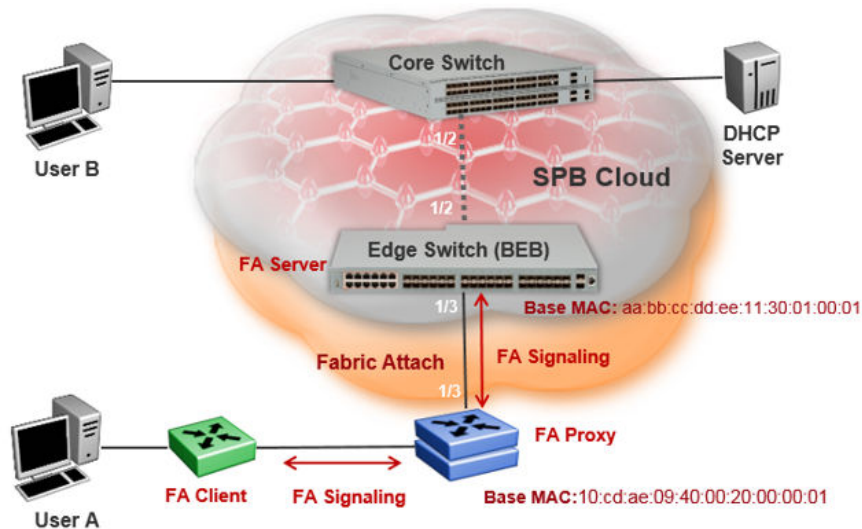

Before you begin

Configure SPBM and IS-IS on the edge and core switches. For more information, see [Configuring minimum SPBM and IS-IS parameters](#) on page 83.

Procedure

Configure the edge switch (BEB) as the FA Server:

1. Enter Global Configuration mode:

```
enable
configure terminal
```

2. Enable FA globally:

```
fa enable
```

3. Enter port interface configuration mode:

```
interface GigabitEthernet {slot/port[/sub-port] [-slot/port[/sub-port]] [,...]}
```

4. Enable FA on the port:

```
fa enable
```

*** Note:**

Enabling FA automatically enables message authentication. Also, the authentication key is set to the default value and appears encrypted on the output.

*** Note:**

Enabling FA on a port not only enables tagging but also disables spanning tree on that port.

Verify global and interface level FA configuration:

5. Verify global configuration of FA using one of the following commands:

- show fa
- show fa agent

6. Verify interface level configuration of FA:

```
show fa interface
```

7. Verify the discovery of clients attaching to the FA Server:

```
show fa elements
```

8. Display the FA I-SID-to-VLAN assignments:

```
show fa assignment
```

To verify I-SID-to-VLAN assignments on a specific port, enter:

```
show fa assignment {slot/port[/sub-port] [-slot/port[/sub-port]]
[,...]}
```

9. Verify creation of Switched UNI (ELAN) I-SIDs:

```
show i-sid elan
```

Example**SPBM and IS-IS configuration on the core and edge switches:****SPBM configuration:**

```
Switch:1>en
Switch:1#conf t
Enter configuration commands, one per line. End with CNTL/Z.
Switch:1(config)#spbm
Switch:1(config)#spbm ethertype 0x8100
```

IS-IS SPBM configuration:

```
Switch:1(config)#router isis
Switch:1(config)#spbm 1
Switch:1(config-isis)#spbm 1 nick-name 1.00.01
Switch:1(config-isis)#spbm 1 b-vid 41-42 primary 41
Switch:1(config-isis)#spbm 1 ip enable
```

IS-IS router configuration:

```
Switch:1(config-isis)#router isis
Switch:1(config-isis)#sys-name BEB-Switch
Switch:1(config-isis)#ip-source-address 3.3.3.3
Switch:1(config-isis)#is-type ll
Switch:1(config-isis)#system-id 0001.0001.0001
Switch:1(config-isis)#manual-area c0.2000.000.00
Switch:1(config-isis)#exit
```

Interface (port-level) configuration

```
Switch:1(config)#interface GigabitEthernet 1/2
Switch:1(config-if)#no shutdown
Switch:1(config-if)#isis
Switch:1(config-if)#isis spbm 1
Switch:1(config-if)#isis enable
Switch:1(config-isis)#exit
```

```
Switch(config)#vlan create 41 type spbm-vlan
Switch(config)#vlan create 42 type spbm-vlan
Switch(config)#router isis enable
Switch(config)#show isis spbm
```

Configuration of the edge switch as the FA Server.

Enable FA globally.

```
Switch:1(config)#fa enable
Switch:1(config)#show fa
```

```
=====
                          Fabric Attach Configuration
=====
                          FA Service : enabled
                          FA Element Type : server
                          FA Assignment Timeout : 240
                          FA Discovery Timeout : 240
                          FA Provision Mode : spbm
```

Enable FA on the port.

Enabling FA automatically enables message authentication. The authentication key is configured with the default value, which appears in encrypted format in the output.

```
Switch:1(config)#int gigabitEthernet 1/3
Switch:1(config-if)#fa enable
Switch:1(config-if)#show fa interface port 1/3
```

```
=====
                          Fabric Attach Interfaces
=====
INTERFACE      SERVER  MGMT   MGMT   MSG AUTH  MSG AUTH
                STATUS ISID   CVID   STATUS    KEY
-----
Port1/3        enabled  0      0      enabled   ****

1 out of 1 Total Num of fabric attach interfaces displayed
```

```
Switch:1(config-if)#exit
Switch:1(config)#exit
```

Verify that the FA Proxy is discovered by the FA Server.

```
Switch:1(config)#show fa elements
```

```
=====
                          Fabric Attach Discovery Elements
=====
PORT   TYPE           MGMT          ELEM ASGN
      TYPE           VLAN STATE   SYSTEM ID   AUTH AUTH
-----
1/3    proxy          2    T / S    10:cd:ae:09:40:00:20:00:00:01   AP   AP

=====
                          Fabric Attach Authentication Detail
=====
PORT   ELEM OPER          ASGN OPER
      AUTH STATUS      AUTH STATUS
-----
1/3    successAuth       successAuth
```

```
State Legend: (Tagging/AutoConfig)
T= Tagged,    U= Untagged,    D= Disabled,    S= Spbm,    V= Vlan,    I= Invalid
```

```
Auth Legend:
AP= Authentication Pass,  AF= Authentication Fail,
NA= Not Authenticated,  N= None
```

```
-----
2 out of 2 Total Num of fabric attach discovery elements displayed
```

Verify the FA I-SID-to-VLAN assignment. An `active` state indicates that the FA (ELAN) I-SID is successfully created with endpoint of type Switched UNI. By default, this I-SID is created for Layer 2.

```
Switch:1#show fa assignment
```

```
=====
                          Fabric Attach Assignment Map
=====
Interface  I-SID      Vlan      State      Origin
-----
1/3        44         2         active     proxy
-----
1 out of 1 Total Num of fabric attach assignment mappings displayed
-----
```

For Layer 3 support, you must configure a platform VLAN. The platform VLAN can have the same value as that of the C-VID or it can have a different value.

In this example, the platform VLAN has the same value as the C-VID.

```
Switch:1(config)#vlan create 2 type port-mstprstp 0
Switch:1(config)#vlan i-sid 2 44
```

```
Switch:1#show i-sid elan
```

```
=====
                          Isid Info
=====
ISID      ISID      PORT      MLT      ORIGIN
ID        TYPE      VLANID    INTERFACES  INTERFACES
-----
44        ELAN      2         c2:1/3    DISC_LOCAL
```

```
c: customer vid    u: untagged-traffic
```

```
All 1 out of 1 Total Num of Elan i-sids displayed
```

Verify neighbor discovery on the FA Proxy switch:

Note that the edge switch (BEB) is discovered as the FA Server by the FA Proxy.

```
Switch:2(config)#show fa agent
```

```
Fabric Attach Service Status: Enabled
Fabric Attach Element Type: Proxy
Fabric Attach Zero Touch Status: Enabled
Fabric Attach Auto Provision Setting: Proxy
Fabric Attach Provision Mode: SPBM
Fabric Attach Client Proxy Status: Enabled
```

```
Fabric Attach Standalone Proxy Status: Disabled
Fabric Attach Agent Timeout: 50 seconds
Fabric Attach Extended Logging Status: Enabled
Fabric Attach Primary Server Id: aa:bb:cc:dd:ee:11:30:01:00:01 (SPBM)
Fabric Attach Primary Server Descr: BEB-Switch (6.0.0.0_GA)
```

```
Switch:2(config)#show fa elements
```

Unit/ Port	Element Type	Element Subtype	Element VLAN	Auth	System ID
1/3	Server	Server (Auth)	0	AP	aa:bb:cc:dd:ee:11:30:01:00:01

```
Switch:2(config)#show fa i-sid
```

I-SID	VLAN	Source	Status
44	2	Proxy	Active

Configuring Fabric Attach in an SMLT

The following example describes FA configuration and behavior in a dual-homed SMLT deployment.

The following figure shows a simple FA solution in a dual-homed SMLT deployment. In this deployment, a pair of BEB switches (BEB A and BEB B) operating as IST peers are configured as the FA Server. An access switch or a wiring closet switch configured as an FA Proxy connects to the FA Server. The FA Proxy advertises I-SID-to-VLAN assignment mappings to the FA Server. Both BEB switches receive the mapping information using LLDP PDUs containing assignment TLVs. The switch that learns the mapping first considers the I-SID to be discovered locally and creates the I-SID on its device. The mapping information is then shared with its IST peer switch. When the peer switch receives the mapping across IST in a new SMLT message, it too creates the I-SID on its device. This I-SID however, is considered to be discovered remotely because it is learnt from synchronization with the peer switch. The mappings can also be learned on the FA Server from *both* LLDP PDUs and from IST synchronization.

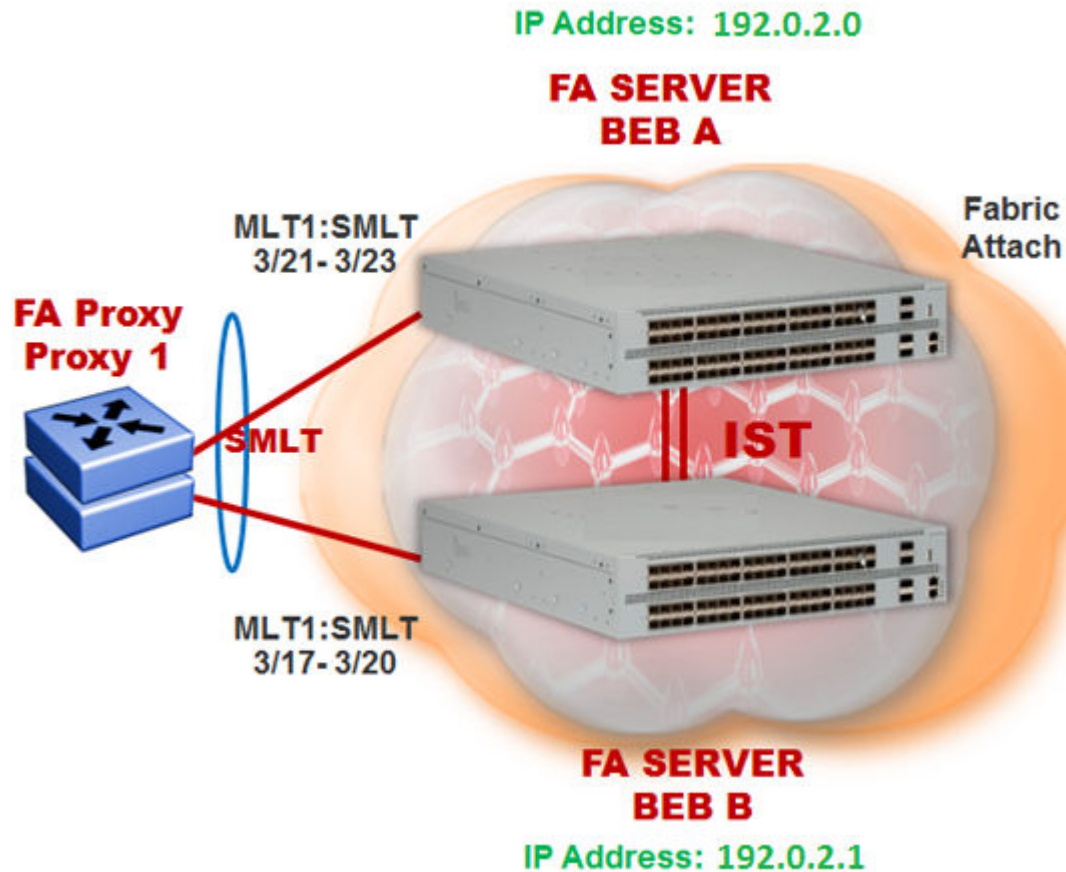

Figure 34: FA configuration in dual-homed SMLT

Before you begin

Ensure that the proxy device (for example, an access switch) is properly configured for FA. See the corresponding product documentation for information on how to configure FA on the switch.

Procedure

1. Configure SMLT and vIST on switches BEB A and BEB B.

Caution:

For the IST peer switches acting as the FA Server to transmit the same FA System ID (based on the virtual MAC), SMLT configuration on both the switches *must* be the same.

For detailed information on configuring SMLT and vIST, see *Configuring Link Aggregation, MLT, SMLT, and vIST*.

Configure BEB A and BEB B as the FA Server

Perform the following configuration on each switch.

2. Enter Global Configuration mode:

```
enable
```

```
configure terminal
```

3. Enable FA globally:

```
fa enable
```

4. Enter MLT interface configuration mode:

```
interface mlt <1-512>
```

5. Enable FA on the MLT:

```
fa enable
```

 **Note:**

Enabling FA automatically enables message authentication. Also, the authentication key is set to the default value and appears encrypted on the output.

6. **(Optional)** Configure an FA authentication key with a value different from that of the default value:

```
fa authentication-key [WORD<0-32>]
```

 **Caution:**

When you configure the FA authentication key, you *must* configure the same value on both BEB switches in the SMLT.

Verify global and MLT-level FA configuration on BEB A and BEB B:

7. Verify global configuration of FA using one of the following commands:

- show fa
- show fa agent

8. Verify MLT-level (interface-level) configuration of FA:

```
show fa interface
```

Verify FA discovery on BEB A and BEB B:

9. Verify discovery of the FA Proxy.

```
show fa elements
```

View FA I-SID-to-VLAN assignments on BEB A and BEB B:

10. View the FA I-SID-to-VLAN assignments:

```
show fa assignment
```

To view FA I-SID-to-VLAN assignments on specific ports, enter:

```
show fa assignment {slot/port[/sub-port] [-slot/port[/sub-port]]  
[,...]}
```

Verify creation of Switched UNI I-SIDs on BEB A and BEB B:

11. Verify creation of Switched UNI (ELAN) I-SIDs. Use the following commands:

- View ELAN I-SID information using `show i-sid elan`.
- View ELAN I-SID information on a specific MLT using `show mlt i-sid [<1-512>]`.

Note:

Viewing ELAN I-SID information on an MLT is very useful to understand the origin of the I-SID, when multiple client or proxy devices connecting to the FA Server using SMLT MLT advertise the *same* I-SID-to-VLAN mappings. In the event of a link failure on an MLT, the origin of the I-SID helps determine on which MLT, and thereby from which proxy or client device, the mappings were successfully learnt.

Example

SMLT configuration on BEB A and BEB B:

On BEB A:

```
Switch:1>en
Switch:1#conf t
Enter configuration commands, one per line. End with CNTL/Z.
Switch:1(config)#interface mlt 1
Switch:1(config)#smlt
```

On BEB B:

```
Switch:2>en
Switch:2#conf t
Enter configuration commands, one per line. End with CNTL/Z.
Switch:2(config)#interface mlt 1
Switch:2(config)#smlt
```

vIST configuration on BEB A and BEB B:

On BEB A:

```
Switch:1(config)#vlan create 2261 type port-mstprstp 0
Switch:1(config)#vlan i-sid 2261 1502261
Switch:1(config)#interface vlan 2261
Switch:1(config)#ip address 192.0.2.0 255.255.255.0 2
```

Configure BEB B (IP address 192.0.2.1) as the IST peer.

```
Switch:1(config)#virtual-ist peer-ip 192.0.2.1 vlan 2261
Switch:1(config)#show virtual-ist
Switch:1(config)#exit
```

On BEB B:

```
Switch:2(config)#vlan create 2261 type port-mstprstp 0
Switch:2(config)#vlan i-sid 2261 1502261
Switch:2(config)#interface vlan 2261
Switch:2(config)#ip address 192.0.2.1 255.255.255.0 2
```

Configure BEB A (IP address 192.0.2.1) as the IST peer.

```
Switch:2(config)#virtual-ist peer-ip 192.0.2.1 vlan 2261
Switch:2(config)#show virtual-ist
Switch:2(config)#exit
```

FA configuration on BEB A:

Enable FA globally and on the MLT:

```
Switch:1(config)#fa enable
Switch:1(config)#show fa
=====
Fabric Attach Configuration
=====
FA Service : enabled
FA Element Type : server
FA Assignment Timeout : 240
FA Discovery Timeout : 240
FA Provision Mode : spbm
```

Optionally, configure an FA authentication key with the value `dual-homed-smlt`. Ensure that you configure the **same** value on both switches BEB A and BEB B.

```
Switch:1(config)#interface mlt 1
Switch:1(config-mlt)#fa authentication-key dual-homed-smlt
```

Enable FA on the MLT:

```
Switch:1(config-mlt)#fa enable
Switch:1(config-mlt)#exit
Switch:1(config)#show fa interface
=====
Fabric Attach Interfaces
=====
INTERFACE      SERVER  MGMT    MGMT    MSG AUTH  MSG AUTH
                STATUS ISID     CVID     STATUS    KEY
-----
Mlt1           enabled  0       0       enabled   ****
-----
1 out of 1 Total Num of fabric attach interfaces displayed
-----
```

Verify discovery of the FA Proxy:

```
Switch:1(config)#show fa elements
=====
Fabric Attach Discovery Elements
=====
PORT  TYPE      MGMT  MGMT  SYSTEM ID  ELEM ASGN
      TYPE      VLAN STATE  ID        AUTH AUTH
-----
3/21  proxy     2     T / S  10:cd:ae:09:40:00:20:00:00:01  AP  AP
3/22  proxy     2     T / S  10:cd:ae:09:40:00:20:00:00:01  AP  AP
3/23  proxy     2     T / S  10:cd:ae:09:40:00:20:00:00:01  AP  AP
-----
Fabric Attach Authentication Detail
=====
PORT  ELEM OPER  ASGN OPER
      AUTH STATUS  AUTH STATUS
-----
3/21  successAuth  successAuth
3/22  successAuth  successAuth
3/23  successAuth  successAuth

State Legend: (Tagging/AutoConfig)
T= Tagged,    U= Untagged,    D= Disabled,    S= Spbm,    V= Vlan,    I= Invalid

Auth Legend:
```

AP= Authentication Pass, AF= Authentication Fail,
NA= Not Authenticated, N= None

3 out of 3 Total Num of fabric attach discovery elements displayed

The FA Proxy advertises I-SID-to-VLAN assignment mappings to BEB A, on MLT ports 3/21 to 3/23. View the FA I-SID-to-VLAN assignments on BEB-A:

All ports in the MLT receive the FA assignment mappings, as shown in the following output.

```
Switch:1(config)#show fa assignment
```

```
=====
                        Fabric Attach Assignment Map
=====
Interface  I-SID      Vlan      State      Origin
-----
3/21       2          2         active     proxy
3/21       3          3         active     proxy
3/21       4          4         active     proxy
3/22       2          2         active     proxy
3/22       3          3         active     proxy
3/22       4          4         active     proxy
3/23       2          2         active     proxy
3/23       3          3         active     proxy
3/23       4          4         active     proxy
=====
```

FA configuration on BEB B:

Enable FA globally and on the MLT:

```
Switch:2(config)#fa enable
Switch:2(config)#show fa
```

```
=====
                        Fabric Attach Configuration
=====
                        FA Service : enabled
                        FA Element Type : server
                        FA Assignment Timeout : 240
                        FA Discovery Timeout : 240
                        FA Provision Mode : spbm
=====
```

Configure the FA authentication key `dual-homed-smlt`. Ensure that you configure the **same** value as on BEB A.

```
Switch:2(config)#interface mlt 1
Switch:2(config-mlt)#fa authentication-key dual-homed-smlt
```

Enable FA on the MLT:

```
Switch:2(config-mlt)#fa enable
Switch:2(config-mlt)#exit
Switch:2(config)#show fa interface
```

```
=====
                        Fabric Attach Interfaces
=====
INTERFACE      SERVER  MGMT    MGMT    MSG AUTH  MSG AUTH
                STATUS  ISID    CVID    STATUS    KEY
-----
```

SPBM and IS-IS infrastructure configuration

```
Mlt1          enabled 0          0          enabled ****
```

```
-----  
1 out of 1 Total Num of fabric attach interfaces displayed  
-----
```

Verify discovery of FA Proxy:

```
Switch:2(config)#show fa elements
```

```
=====
Fabric Attach Discovery Elements
=====
PORT      TYPE          MGMT          ELEM ASGN
          VLAN STATE    SYSTEM ID    AUTH AUTH
-----
3/17     proxy        2    T / S    10:cd:ae:09:40:00:20:00:00:01    AP    AP
3/18     proxy        2    T / S    10:cd:ae:09:40:00:20:00:00:01    AP    AP
3/19     proxy        2    T / S    10:cd:ae:09:40:00:20:00:00:01    AP    AP
3/20     proxy        2    T / S    10:cd:ae:09:40:00:20:00:00:01    AP    AP
=====
```

```
=====
Fabric Attach Authentication Detail
=====
PORT      ELEM OPER          ASGN OPER
          AUTH STATUS      AUTH STATUS
-----
3/17     successAuth          successAuth
3/18     successAuth          successAuth
3/19     successAuth          successAuth
3/20     successAuth          successAuth
=====
```

State Legend: (Tagging/AutoConfig)

T= Tagged, U= Untagged, D= Disabled, S= Spbm, V= Vlan, I= Invalid

Auth Legend:

AP= Authentication Pass, AF= Authentication Fail,
NA= Not Authenticated, N= None

```
-----  
4 out of 4 Total Num of fabric attach discovery elements displayed
```

The FA Proxy device advertises I-SID-to-VLAN assignment mapping requests to BEB B on MLT ports 3/17 to 3/20.

View FA I-SID-to-VLAN assignments on BEB-B:

```
Switch:2(config)#show fa assignment 3/17
```

```
=====
Fabric Attach Assignment Map
=====
Interface  I-SID    Vlan    State    Origin
-----
3/17       2        2       active   proxy
3/17       3        3       active   proxy
3/17       4        4       active   proxy
=====
```

Verify creation of FA Switched UNI (ELAN) I-SIDs on BEB A and BEB B:

Verify the creation of FA Switched UNI (ELAN) I-SIDs on BEB A and BEB B. Note that the ORIGIN of the I-SIDs displays as DISC_BOTH

Since the I-SID-to-VLAN mappings are learnt from both LLDP PDUs (containing the Assignment TLVs) and from IST synchronization between the peers, the origin displays as DISC_BOTH.

On BEB A:

```
Switch:1(config)#show i-sid elan
=====
                        Isid Info
=====
```

ISID ID	ISID TYPE	VLANID	PORT INTERFACES	MLT INTERFACES	ORIGIN
2	ELAN	N/A	-	c2:1	DISC_BOTH
3	ELAN	N/A	-	c3:1	DISC_BOTH
4	ELAN	N/A	-	c4:1	DISC_BOTH

View the I-SID information for MLT 1 on BEB A.

```
Switch:1(config)#show mlt i-sid 1
=====
                        MLT Isid Info
=====
```

MLTID	IFINDEX	ISID ID	VLANID	C-VID	ISID TYPE	ORIGIN	BPDU
1	6144	2	N/A	2	ELAN	DISC_BOTH	
1	6144	3	N/A	3	ELAN	DISC_BOTH	
1	6144	4	N/A	4	ELAN	DISC_BOTH	

3 out of 3 Total Num of i-sid endpoints displayed

On BEB B:

```
Switch:2(config)#show i-sid elan
=====
                        Isid Info
=====
```

ISID ID	ISID TYPE	VLANID	PORT INTERFACES	MLT INTERFACES	ORIGIN
2	ELAN	N/A	-	c2:1	DISC_BOTH
3	ELAN	N/A	-	c3:1	DISC_BOTH
4	ELAN	N/A	-	c4:1	DISC_BOTH

View the I-SID information for MLT 1 on BEB B.

```
Switch:1(config)#show mlt i-sid 1
=====
                        MLT Isid Info
=====
```

MLTID	IFINDEX	ISID ID	VLANID	C-VID	ISID TYPE	ORIGIN	BPDU
1	6144	2	N/A	2	ELAN	DISC_BOTH	
1	6144	3	N/A	3	ELAN	DISC_BOTH	
1	6144	4	N/A	4	ELAN	DISC_BOTH	

3 out of 3 Total Num of i-sid endpoints displayed

The following section describes the behavior if, for example, a link failure occurs between the FA Proxy and BEB B, as shown in the following figure.

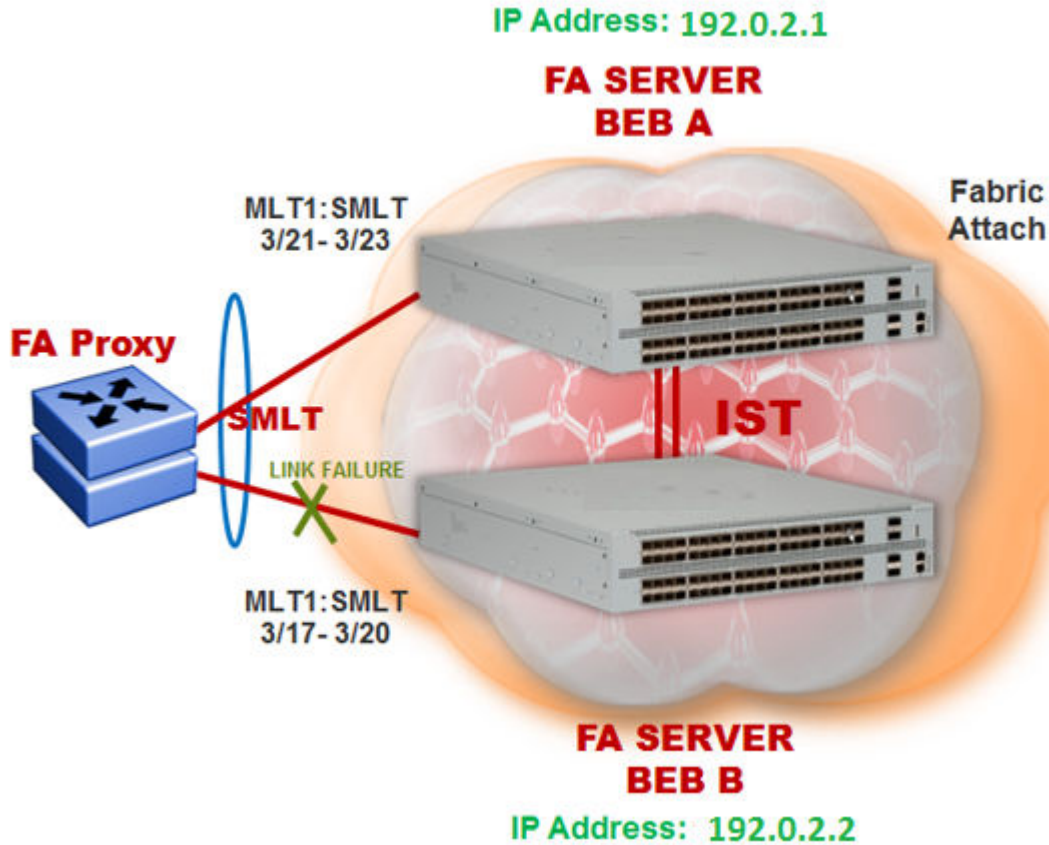

Figure 35: FA behavior in dual-homed SMLT during a link failure

View the I-SID-to-VLAN assignments on BEB A:

```
Switch:1(config)#show fa assignment 3/21
=====
Fabric Attach Assignment Map
=====
Interface  I-SID    Vlan    State    Origin
-----
3/21       2        2        active   proxy
3/21       3        3        active   proxy
3/21       4        4        active   proxy
```

View the Switched UNI (ELAN) I-SIDs created on BEB A.

Since BEB A first learns the mappings from the LLDP PDUs (containing the Assignment TLVs), the origin of the I-SIDs displays as DISC_LOCAL.

```
Switch:1(config)#show i-sid elan
=====
Isid Info
=====
```

ISID ID	ISID TYPE	VLANID	PORT INTERFACES	MLT INTERFACES	ORIGIN
2	ELAN	N/A	-	c2:1	DISC_LOCAL
3	ELAN	N/A	-	c3:1	DISC_LOCAL
4	ELAN	N/A	-	c4:1	DISC_LOCAL

View the I-SID information for MLT 1 on BEB A.

```
Switch:1(config)#show mlt i-sid 1
```

```
=====
```

```
MLT Isid Info
```

```
=====
```

MLTID	IFINDEX	ISID ID	VLANID	C-VID	ISID TYPE	ORIGIN	BPDU
1	6144	2	N/A	2	ELAN	DISC_LOCAL	
1	6144	3	N/A	3	ELAN	DISC_LOCAL	
1	6144	4	N/A	4	ELAN	DISC_LOCAL	

```
=====
```

```
3 out of 3 Total Num of i-sid endpoints displayed
```

View the Switched UNI (ELAN) I-SIDs created on BEB B.

Since BEB B learns the mappings only through IST peer synchronization, the origin of the I-SIDs displays as DISC_REMOTE.

```
BEB-B:1(config-mlt)#show i-sid elan
```

```
=====
```

```
Isid Info
```

```
=====
```

ISID ID	ISID TYPE	VLANID	PORT INTERFACES	MLT INTERFACES	ORIGIN
2	ELAN	N/A	-	c2:1	DISC_REMOTE
3	ELAN	N/A	-	c3:1	DISC_REMOTE
4	ELAN	N/A	-	c4:1	DISC_REMOTE

```
=====
```

View the I-SID information for MLT 1 on BEB B.

```
Switch:1(config)#show mlt i-sid 1
```

```
=====
```

```
MLT Isid Info
```

```
=====
```

MLTID	IFINDEX	ISID ID	VLANID	C-VID	ISID TYPE	ORIGIN	BPDU
1	6144	2	N/A	2	ELAN	DISC_REMOTE	
1	6144	3	N/A	3	ELAN	DISC_REMOTE	
1	6144	4	N/A	4	ELAN	DISC_REMOTE	

```
=====
```

```
3 out of 3 Total Num of i-sid endpoints displayed
```

Chapter 5: Layer 2 VSN configuration

This section provides concepts and procedures to configure Layer 2 Virtual Services Networks (VSNs).

Layer 2 VSN configuration fundamentals

This section provides fundamentals concepts for Layer 2 VSN.

SPBM L2 VSN

SPBM supports Layer 2 VSN functionality where customer VLANs (C-VLANs) are bridged over the SPBM core infrastructure.

At the Backbone Edge Bridges (BEBs), customer VLANs (C-VLAN) are mapped to I-SIDs based on the local service provisioning. Outgoing frames are encapsulated in a MAC-in-MAC header, and then forwarded across the core to the far-end BEB, which strips off the encapsulation and forwards the frame to the destination network based on the I-SID-to-C-VLAN provisioning.

In the backbone VLAN (B-VLAN), Backbone Core Bridges (BCBs) forward the encapsulated traffic based on the B-MAC-DA, using the shortest path topology learned using IS-IS.

The following figure shows a sample campus SPBM Layer 2 VSN network.

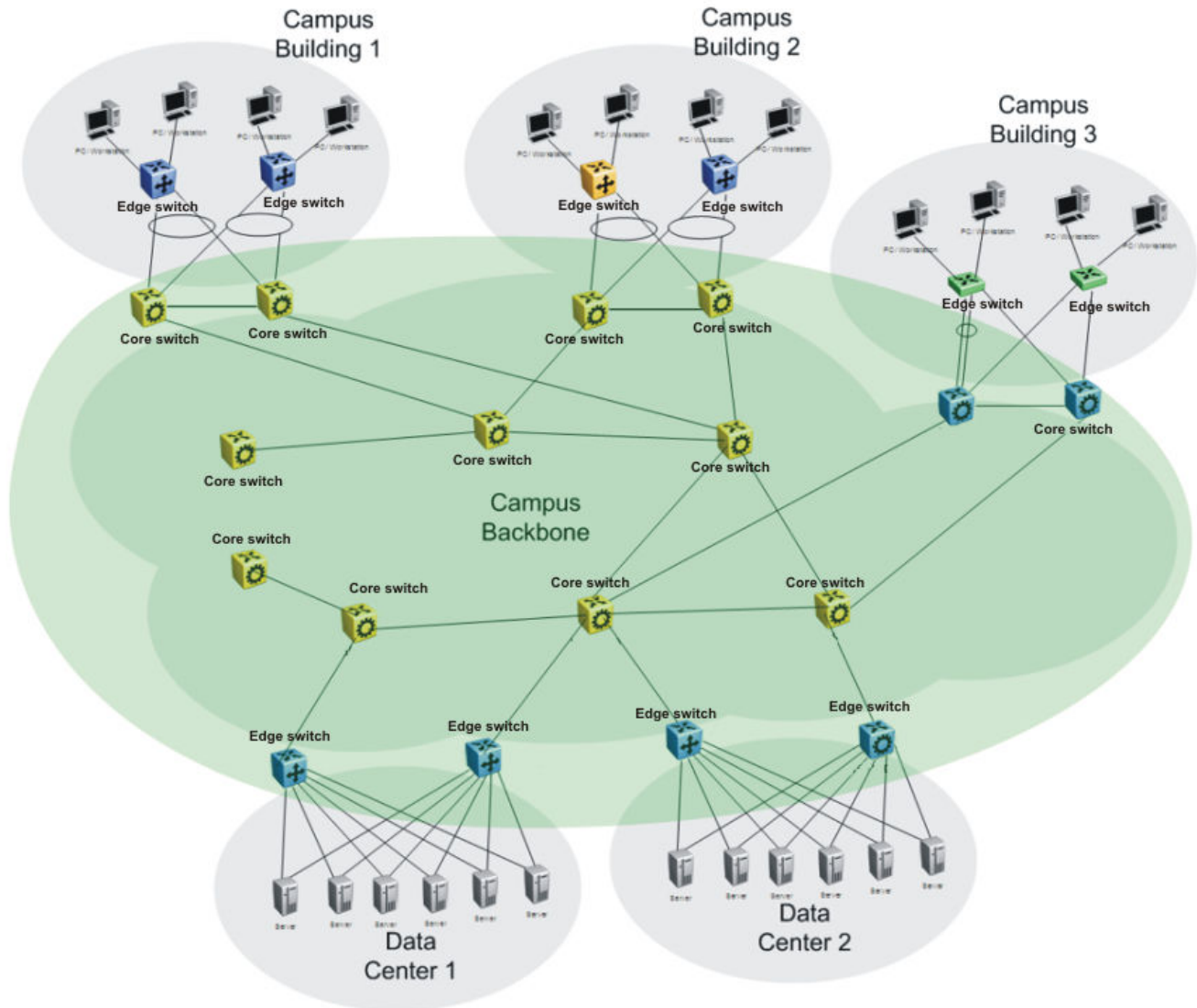

Figure 36: SPBM L2 VSN in a campus

One of the key advantages of the SPBM Layer 2 VSN is that network virtualization provisioning is achieved by configuring only the edge of the network (BEBs). As a result, the intrusive core provisioning that other Layer 2 virtualization technologies require is not needed when new connectivity services are added to the SPBM network. For example, when new virtual server instances are created and need their own VLAN instances, they are provisioned at the network edge only and do not need to be configured throughout the rest of the network infrastructure.

Based on its I-SID scalability, this solution can scale much higher than any 802.1Q tagging based solution. Also, due to the fact that there is no need for Spanning Tree in the core, this solution does not need any core link provisioning for normal operation.

Redundant connectivity between the C-VLAN domain and the SPBM infrastructure can be achieved by operating two SPBM switches in switch clustering (SMLT) mode. This allows the dual homing of any traditional link aggregation capable device into an SPBM network.

Configuration difference from ERS 8800

One major difference between these VSP switches and the ERS 8800 is how they connect to two SMLT devices.

The ERS 8800 uses an interswitch trunk (IST). The IST connects directly to two SMLT devices with a dedicated MLT and runs IS-IS over it. The dedicated MLT carries the IST control traffic and data traffic during an SMLT failover. This feature dramatically improves resiliency over other methods. However, if the dedicated MLT breaks, then there is no way to communicate between the IST peers, which causes traffic loss.

These VSP switches use a virtual IST (vIST) that eliminates this single point of failure. The vIST feature creates a virtualized IST channel in the SPBM cloud. With vIST, the IST tunnel is always up as long as there is SPBM connectivity between the vIST peers. vIST also interoperates between any two devices that support vIST, and the devices do not have to be the same type of device.

Before you can create a vIST, you must do the following:

- Enable SPBM and IS-IS globally.
- Configure SPBM and IS-IS.
- Create a VLAN (that is not used anywhere else) for each peer.
- Create an I-SID that is not used anywhere else.
- Configure an IP address for the vIST VLAN.
- Configure an L2 VSN by assigning an I-SID to the C-VLAN, which is used by the vIST.

Important:

- An I-SID must be assigned to every VLAN that is a member of an L2 VSN.
- For proper traffic flow, if an L2 VSN is created on one vIST peer, it must also be created on the other vIST peer.
- For Simplified vIST deployment, if a VLAN is part of an SMLT it must be configured on both the IST peers.

For information about vIST, see *Configuring Link Aggregation, MLT, SMLT, and vIST*.

Fabric Connect Service Types

The Fabric Connect technology delivers Layer 2 and Layer 3 virtualization. These virtualized Layer 2 and Layer 3 instances are referred to as Virtual Service Networks (VSNs). A Service Identifier (I-SID) is used to uniquely distinguish these service instances network-wide, and a User Network Interface (UNI) is the boundary or demarcation point between the “service layer” of traditional networks, that is VLANs and VRFs, and the Fabric Connect “service layer”, that is Layer 2 & Layer 3 VSNs.

- Layer 2 VSNs are virtual broadcast domains interconnecting UNI members that share the same Layer 2 VSN I-SID. MAC learning/aging is applied to all Layer 2 VSNs.
- Layer 3 VSNs are virtual routed Layer 3 networks (Layer 3 VPN) leveraging IS-IS as the routing protocol between VRFs that share the same Layer 3 VSN I-SID.

Fabric Connect uses the User-Network-Interface (UNI) to denote the capabilities and attributes of the service interfaces. Fabric connect devices support the following UNI types:

- *VLAN UNI (C-VLAN)* — a device-specific VLAN-ID maps to a Layer 2 VSN I-SID – all device physical ports that are associated with the VLAN are therefore associated with the UNI.
- *Flex UNI* — it has the following sub-types:
 - *Switched UNI* — a VLAN-ID and a given port (VID, port) maps to a Layer 2 VSN I-SID. With this UNI type, VLAN-IDs can be reused on other ports and therefore mapped to different I-SIDs.
 - *Transparent Port UNI* — a physical port maps to a Layer 2 VSN I-SID (all traffic through that port, 802.1Q tagged or untagged, ingress and egress is mapped to the I-SID). Note: All VLANs on a Transparent Port UNI interface now share the same single MAC learning table of the Transparent Port UNI I-SID.
- *E-Tree UNI* — it extends Private VLANs beyond one Switch to form a network-wide E-Tree service infrastructure. An E-Tree UNI is a Layer 2 VSN where broadcast traffic flows from Hub sites to Spokes sites, and from Spokes to Hubs, but not between Spoke sites. E-Tree Hubs can be formed with any VLAN UNI, while E-Tree Spokes must be configured as Private VLAN UNIs.
- *Layer 3 VSN UNI* — a device-specific VRF maps to an I-SID, and the control plane exchanges the Layer 3 routes belonging to the same I-SID. All VRFs in a network sharing the same Layer 3 I-SID effectively form an Layer 3 VPN. Layer 3 VSNs can be configured to simultaneously support both IP Unicast and IP Multicast.

For more information on Layer 3 VSN, see *Configuring Fabric Layer 3 Services*.

Transparent Port UNI

The Transparent port user-network-interface (T-UNI) feature enables you to map an entire port or an MLT to an I-SID. CMAC learning is done against the I-SID. Transparent Port UNI configures a transparent port where all traffic is MAC switched on an internal virtual port using the assigned I-SID. No VLAN is involved in this process. Devices switch tagged and untagged traffic in the assigned I-SID regardless of the VLAN ID. The T-UNI port or MLT can be either static or LACP and is not a member of any VLAN or Spanning Tree Group (STG). The T-UNI port or MLT is always in the forwarding state.

You can map multiple ports to a T-UNI I-SID. Multiple ports on the same switch and on other BEBs can use the common I-SID to switch traffic.

Transparent Port UNI is a point to point service and all traffic that ingress the UNI egress from the remote UNI end-point.

Transparent

Transparent Port UNI is transparent because the MAC learning occurs within the I-SID, and packets that ingress from any CVLAN are processed in an identical manner. Devices switch tagged and untagged traffic in the assigned I-SID. Devices switch control protocols, such as BPDU, LACP, LLDP, and others, in the assigned I-SID, rather than forwarding to the CP.

The service classification of packets that are received on a T-UNI port, is independent of the VLAN ID values present in those packets. All data packets received on a T-UNI port are classified into the

same service. When data packets enter and exit the T-UNI service, no VLAN tag modifications are performed on the data packets.

T-UNI based MAC learning

When a packet ingresses a port or MLT associated with a T-UNI I-SID, the system performs MAC lookup based on the I-SID. A packet that ingresses a T-UNI port on a BEB can transfer through the SPB network, or can egress out another T-UNI port configured to the same I-SID.

When a packet ingresses an NNI port, before egressing a T-UNI port, the system performs a MAC Destination Address (DA) lookup based on the I-SID. If the DA lookup fails, the packet floods to all T-UNI ports.

Considerations

Consider the following when you configure a Transparent Port UNI:

- You cannot configure a Transparent Port UNI on the same I-SID as a C-VLAN.
- A Transparent Port UNI port or MLT is not a member of any VLAN and does not belong to any STG.
- Ensure that you always associate a T-UNI LACP MLT with a VLAN (even if it is the default VLAN) before adding it to a T-UNI ISID. Otherwise, traffic is not forwarded on the T-UNI LACP MLT.
- No Layer 3 processing takes place on packets ingressing on a T-UNI port.
- Pause frames do not switch through the T-UNI I-SID.
- You can map more than one Transparent Port UNI port to same ISID.
- A T-UNI port can be a part of only one ISID.
- Static MAC is not supported for a T-UNI port.
- An ISID mapped to a T-UNI service must not be mapped to any other service, such as L2 VSN and L3 VSN, on any of the remote BEBs in the SPBM network.

Use Transparent Port UNI when either of the following apply:

- All tagged and untagged traffic on a port must be classified into the same broadcast domain.
- You want to offer a transparent provider solution.

An example of an application for Transparent Port UNI is a typical Ethernet provider deployment with port-based classification and transparent forwarding.

QoS re-marking on a Transparent Port UNI

A Transparent Port UNI port is normally configured as a Layer 2 trusted port. The T-UNI port honors incoming customer 802.1p bits and derives an internal QoS level. The 802.1p bit marking of the Backbone VLAN (BVLAN) is derived from the internal QoS level. If the T-UNI port is set as a Layer 2 untrusted port, a best-effort queue is assigned. Customer packet headers are not modified.

The T-UNI port QoS configurations are:

- DiffServ = disable
- Layer3Trusted = access (for EDM configuration)

- access-diffserv enable (for CLI configuration)

QoS considerations when a port is associated with a T-UNI I-SID

- You cannot configure `access-diffserv` and `enable diffserv` on a T-UNI port.
- When a port is associated with a T-UNI ISID, the T-UNI QoS configuration automatically takes effect.
- When the port is removed from the T-UNI ISID, the default port QoS configuration takes effect.

QoS considerations when an MLT is associated with a T-UNI I-SID

- When an MLT, static or LACP, is added to a T-UNI ISID, the T-UNI QoS configuration take effect on all the ports of the MLT.
- When an MLT, static or LACP, is removed from a T-UNI ISID, the port default QoS configuration is configured on all the member ports of the MLT.
- If a port is added dynamically to a T-UNI MLT, static or LACP, the port inherits the QoS properties of the T-UNI MLT ports.
- If a port is dynamically removed from a T-UNI MLT, static or LACP, the port retains the QoS configuration inherited from the MLT.

Transparent Port UNI over vIST

Virtual IST (vIST) provides the ability to dual-home hosts, servers and other network devices to a pair of Multi-Chassis Link Aggregation (MC-LAG) enabled devices. The MC-LAG nodes appear to the connected devices as one link-aggregated group. So, although the physical connection is spread between two individual network nodes, logically they appear as a single connection.

Transparent Port UNI (T-UNI) over vIST peers extends the capability of dual-home hosts on the SPB cloud to achieve higher network resiliency. The MACs learnt on the T-UNI interface of any one vIST peer is synchronized with the other peer through MAC synchronization.

In the following figure, the T-UNI access switch ACCESS-1 is dual-homed into vIST peer hosts VIST-PEER 1 and VIST-PEER 2. At ACCESS-1, a link aggregation is created to connect to the SPBM cluster. On the VIST peers, an SMLT is created towards ACCESS-1. Depending on the link aggregation hashing logic, traffic is hashed on to VIST-PEER 1 and VIST-PEER 2. The MACs learnt on the T-UNI interfaces of either host is synchronized with the other host.

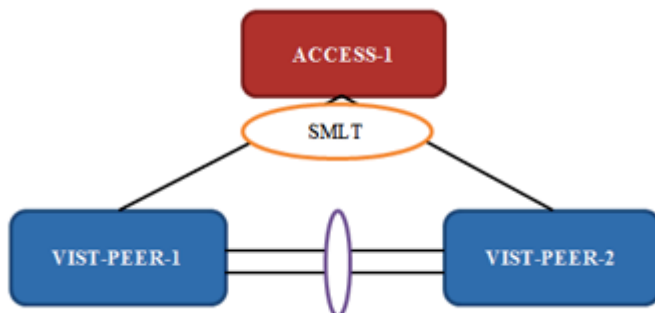

Figure 37: Example of Transparent Port UNI over vIST

If one of the links between ACCESS-1 and the vIST cluster goes down, all traffic is serviced through the other link. The same applies when any of the vIST peers go down. Since MAC learning on both peers are synchronized, both peers can switch traffic with the same efficiency.

Single-homed T-UNI service on a vIST-enabled node

If you configure a T-UNI service as a single-homed service on a vIST-enabled node, you must configure the same ISID service without port/MLT being mapped to ISID, on the other vIST peer node. Failure to perform this configuration on the vIST peer node can result in the loss of traffic to the single-homed T-UNI service in various scenarios.

Switched UNI

Switched User Network Interface (S-UNI) allows the association of local endpoints to I-SIDs based on local port and VLAN together. With switched UNI, the same VLAN can be used on one port to create an endpoint to one I-SID, and on another port to create an endpoint to another I-SID.

Switched UNI summary:

- S-UNI is a VLAN and ports associated with I-SIDs.
- Local significance on the ports.
- You can re-use the same VLAN to associate different ports with different I-SIDs.
- You can use a different VLAN to the same ports, or you can assign different ports to the same I-SID.
- Supports VLAN mapping on the local switch.
- To accept untagged traffic, the port needs to be configured as untagged-traffic in the I-SID.

Use Switched UNI when either of the following apply:

- Vlan ID (VID) reuse is required. The same VID is used on different broadcast domains (multi-tenant applications).
- Multiple VLANs must be part of the same broadcast domain.
- VID translation is required.

An example of an application for Switched UNI is a typical host and provider deployment, with a port and VID-based classification.

S-UNI based MAC learning

MAC learning is done on I-SID MAC. When a packet ingresses on a port or MLT which is associated with S-UNI I-SID, the system performs MAC look up based on the I-SID. S-UNI operates on Any-To-Any (ELAN) mode, there can be one or more ports associated to a S-UNI I-SID. A packet that ingresses to a S-UNI port on a BEB can transfer through the SPBM cloud, or can egress out another S-UNI port configured to the same I-SID.

When a packet ingresses an NNI port, before egressing a S-UNI port, the system performs a MAC Destination Address (DA) lookup based on the I-SID. If the DA lookup fails, the packet floods to all S-UNI ports in the I-SID.

Considerations

Consider the following when you configure a Switched UNI:

- The VLAN tag is removed before the traffic egresses out on the untagged-traffic port or MLT.
- VLAN priority received on the packet is maintained across VLAN IDs.
- Spanning tree is disabled on all S-UNI ports, and the ports remain in forwarding state.
- The S-UNI I-SID is advertised to the SPBM cloud.
- The Broadcast and unknown Unicast packets are flooded to all ports in the I-SID.

Limitations

- You cannot change from one UNI type to another dynamically. The I-SID has to be deleted and created with new UNI type (Customer VLAN (C-VLAN), Transparent port user-network-interface (T-UNI), ELAN).
- I-SID cannot be used by IPVPN, MVPN, SPBM dynamic multicast range, or *Transparent Port UNI*.
- If the port is a member of MLT, the entire MLT has to be added to the VID.
- The port is always in the forwarding state.
- The same VID, port, or MLT cannot be member of more than one I-SID.
- Static MAC, Static ARP and static IGMP group are not supported on S-UNI enabled ports.

SPBM sample operation—L2 VSN

The following section shows how a SPBM network is established, in this case, a Layer 2 VSN.

1. *Discover network topology*

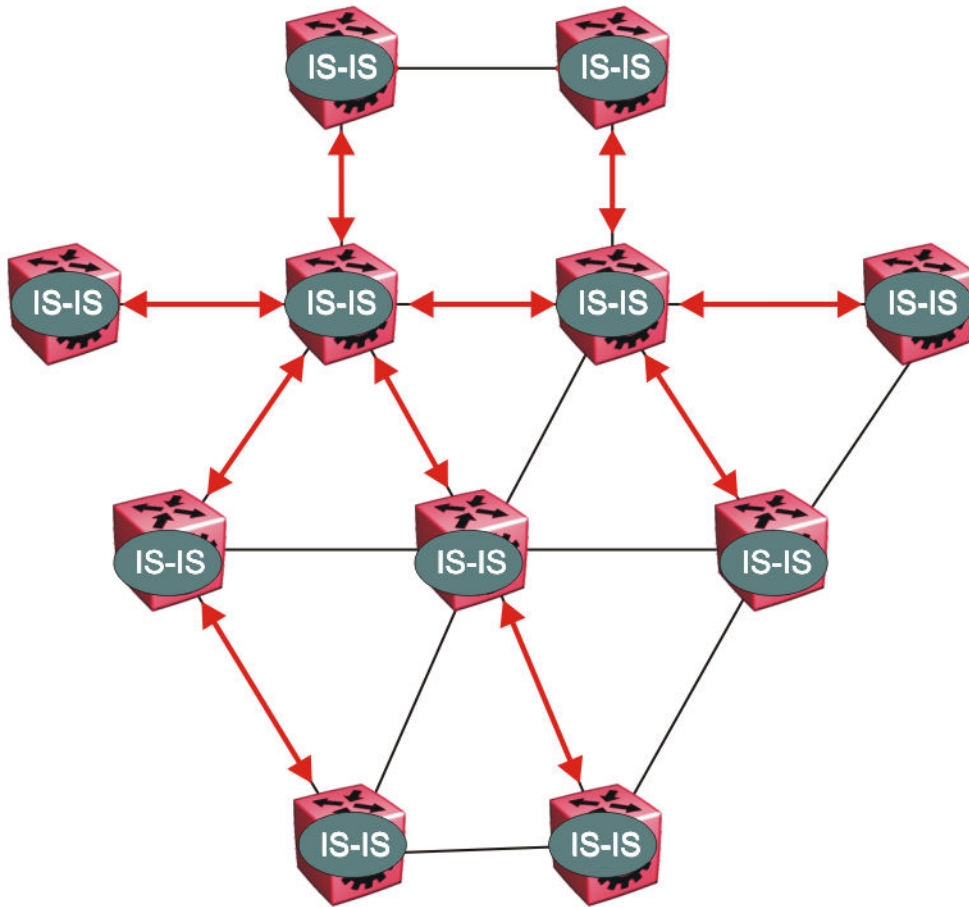

Figure 38: SPBM topology discover

IS-IS runs on all nodes of the SPBM domain. Since IS-IS is the basis of SPBM, the IS-IS adjacency must be formed first. After the neighboring nodes see hellos from each other they look for the same Level (Level 1) and the same area (for example, Area 2f.8700.0000.00). After the hellos are confirmed both nodes send Link State Protocol Data Units, which contain connectivity information for the SPBM node. These nodes also send copies of all other LSPs they have in their databases. This establishes a network of connectivity providing the necessary information for each node to find the best and proper path to all destinations in the network.

Each node has a system ID, which is used in the topology announcement. This same System ID also serves as the switch Backbone MAC address (B-MAC), which is used as the source and destination MAC address in the SPBM network.

2. *Each IS-IS node automatically builds trees from itself to all other nodes*

When the network topology is discovered and stored in the IS-IS link state database (LSDB), each node calculates shortest path trees for each source node. A unicast path now exists from every node to every other node

With this information, each node populates unicast information received from SPBM into the FIB for forwarding purposes. Multicast FIB is not produced until Layer 2 VSN services are configured and learned.

3. IS-IS advertises new service communities of interest

When a new service is provisioned, its membership is flooded throughout the topology with an IS-IS advertisement.

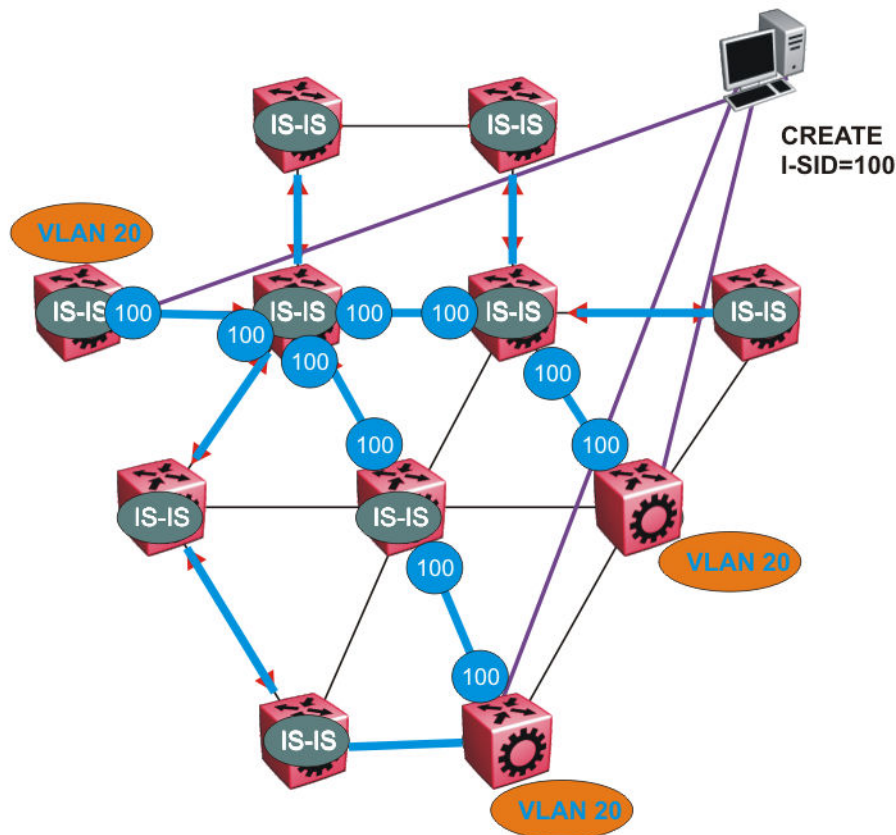

Figure 39: SPBM BMAC and I-SID population

BMAC and I-SID information is flooded throughout the network to announce new I-SID memberships. In this case, VLAN 20 is mapped to I-SID 100.

* Note:

I-SIDs are only used for virtual services (Layer 2 and Layer 3 VSNs). If IP Shortcuts only is enabled on the BEBs, I-SIDs are never exchanged in the network as IP Shortcuts allow for IP networks to be transported across IS-IS.

Each node populates its FDB with the BMAC information derived from the IS-IS shortest path tree calculations. Thus there is no traditional flooding and learning mechanism in place for the B-VLAN, but FDBs are programmed by the IS-IS protocol.

4. When a node receives notice of a new service AND is on the shortest path, it updates the FDB

In this scenario, where there are three source nodes having a membership on I-SID 100, there are three shortest path trees calculated (not counting the Equal Cost Trees (ECTs)).

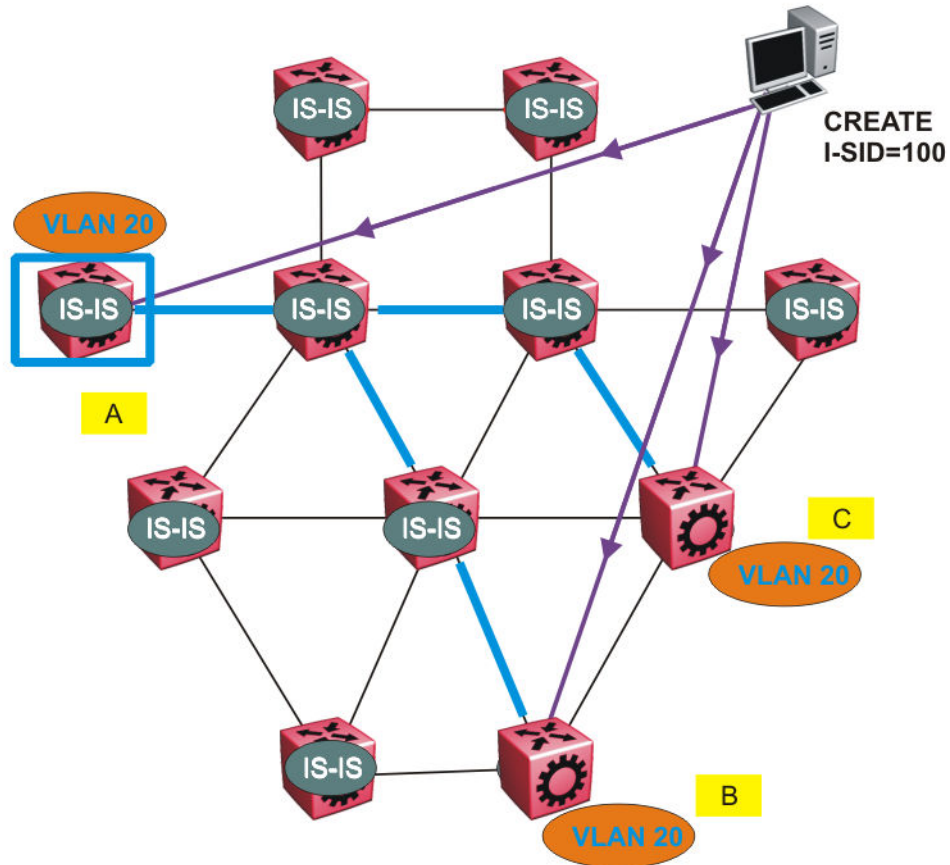

Figure 40: Shortest path tree for source node A

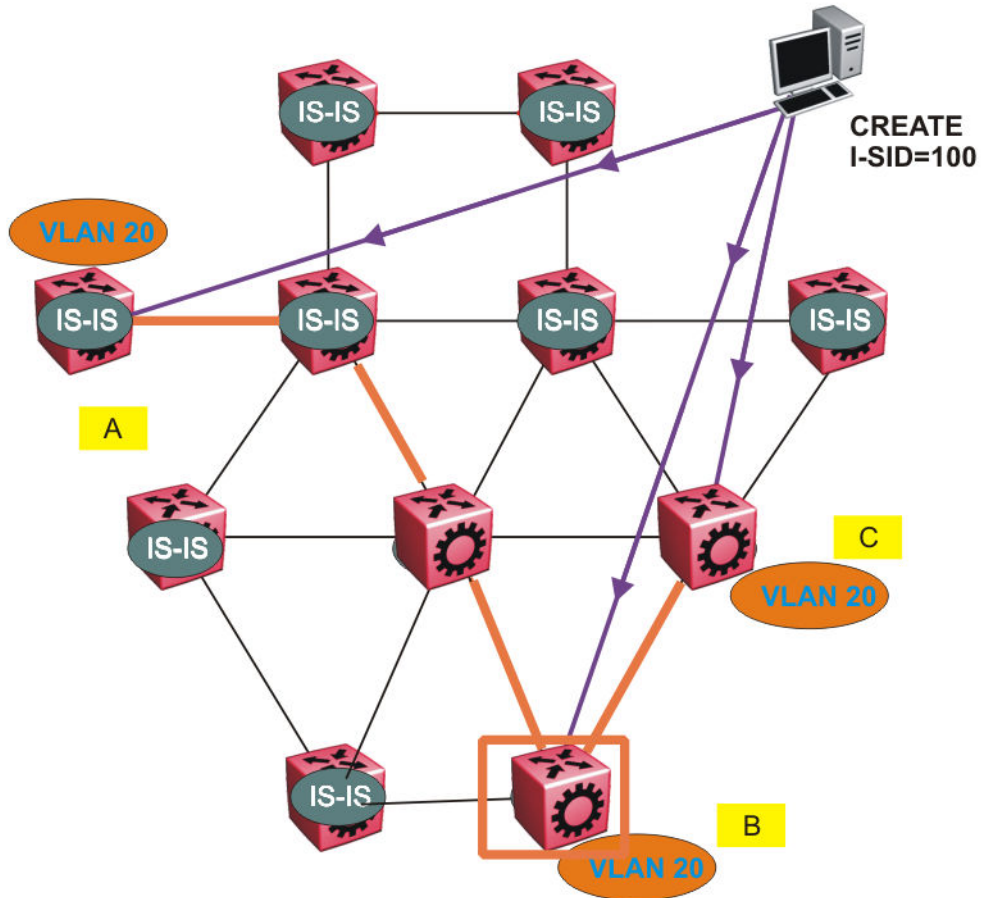

Figure 41: Shortest path tree for source node B

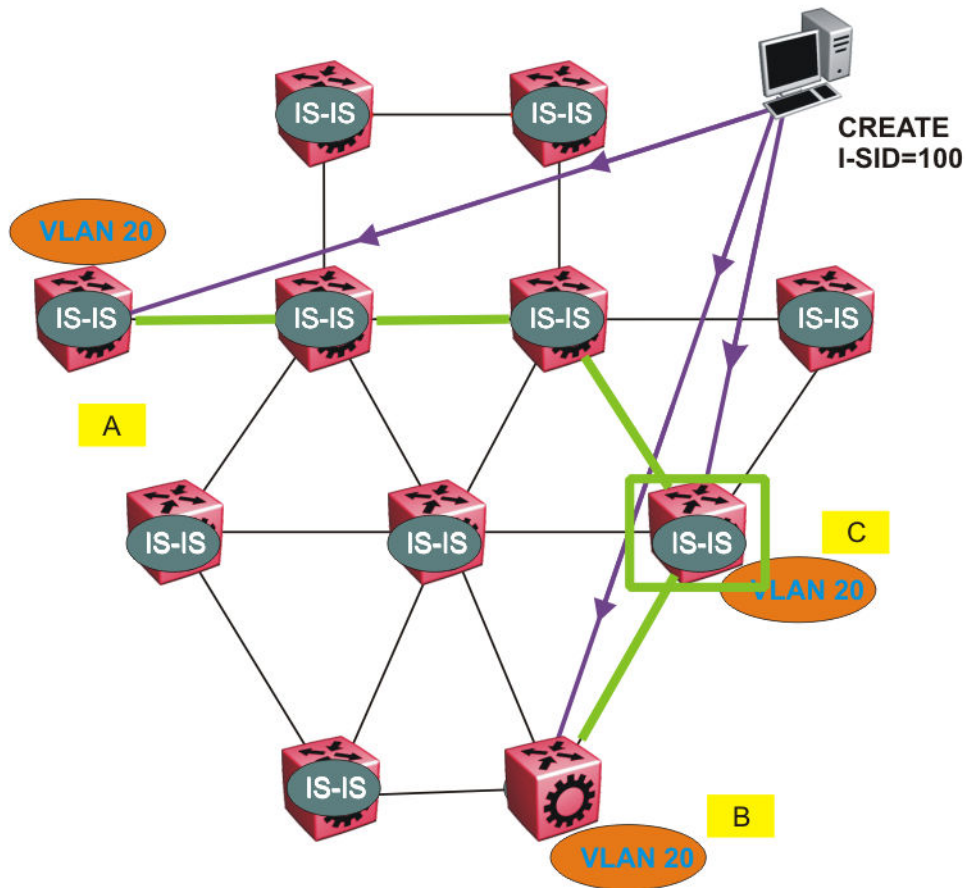

Figure 42: Shortest path tree for source node C

The paths between any two nodes are always the shortest paths. Also, the paths in either direction are congruent, thus a bidirectional communication stream can be monitored easily by mirroring ingress and egress on a link to a network analyzer.

VLAN traffic arriving on switch A and VLAN 20 is forwarded following the blue path, traffic arriving on switch B and VLAN 20 the orange path and on switch C VLAN 20 traffic is following the green path.

If the destination CMAC is unknown at the SPBM ingress node or the traffic is of type broadcast or multicast, then it is flooded to all members of the topology which spans VLAN 20. If the destination CMAC is already known, then the traffic is only forwarded as a unicast to the appropriate destination. In the SPBM domain, the traffic is switched on the BMAC header only. The bridge filtering database (FDB) at the VLAN to I-SID boundary (backbone edge bridge BEB), maintains a mapping between CMACs and corresponding BMACs.

For example, Switch B learns all CMACs which are on VLAN 20 connected to switch A with the BMAC of A in its FDB and the CMACs which are behind C are learned with the BMAC of C.

Layer 2 VSN configuration using the CLI

This section provides procedures to configure Layer 2 VSNs using the CLI.

Configuring SPBM Layer 2 VSN

SPBM supports Layer 2 Virtual Service Network (VSN) functionality where customer VLANs (C-VLANs) are bridged over the SPBM core infrastructure.

At the BEBs, customer VLANs (C-VLAN) are mapped to I-SIDs based on the local service provisioning. Outgoing frames are encapsulated in a MAC-in-MAC header, and then forwarded across the core to the far-end BEB, which strips off the encapsulation and forwards the frame to the destination network based on the I-SID-to-C-VLAN provisioning.

Before you begin

- You must configure the required SPBM and IS-IS infrastructure, which includes the creation of SPBM BVLANS.
- You must create the customer VLANs (C-VLANs) and add slots/ports.

Procedure

1. Enter Global Configuration mode:

```
enable
configure terminal
```

2. Map a customer VLAN (C-VLAN) to a Service Instance Identifier (I-SID):

```
vlan i-sid <1-4059> <0-16777215>
```

Important:

When a protocol VLAN is created, all ports are added to the VLAN including SPBM ports. To configure a protocol-based VLAN as a C-VLAN, you must first remove the SPBM-enabled ports from the protocol based VLAN, and then configure the protocol-based VLAN as a C-VLAN.

The switch reserves I-SID 0x00ffffff. The switch uses this I-SID to advertise the virtual B-MAC in a SMLT dual-homing environment. The platform clears the receive and transmit bit of this I-SID, therefore I-SID 0x00ffffff cannot be used for any other service.

3. Display C-VLAN information:

```
show vlan i-sid
```

Example

```
Switch> enable
Switch# configure terminal
Switch:1(config)# vlan i-sid 5 5
```

```
Switch:1(config)# show vlan i-sid
```

```
=====
                        Vlan I-SID
=====
VLAN_ID    I-SID
-----
1           2
5           5
10          20
```

Variable definitions

Use the data in the following table to use the `vlan i-sid` command.

Variable	Value
<code>vlan i-sid <1-4059> <0-1677215></code>	<p>Specifies the customer VLAN (CVLAN) to associate with the I-SID.</p> <p>Use the <code>no</code> or <code>default</code> options to remove the I-SID from the specified VLAN.</p> <p>* Note:</p> <p>The switch reserves I-SID 0x00ffff. The switch uses this I-SID to advertise the virtual B-MAC in a SMLT dual-homing environment. The platform clears the receive and transmit bit of this I-SID, therefore I-SID 0x00ffff cannot be used for any other service.</p>

Displaying C-VLAN I-SID information

Use the following procedure to display C-VLAN I-SID information.

Procedure

1. Display the C-VLAN to I-SID associations:

```
show vlan i-sid <1-4059>
```

2. Display the IS-IS SPBM multicast-FIB calculation results by I-SID:

```
show isis spbm i-sid {all|config|discover} [vlan <1-4059>] [id <1-16777215>] [nick-name <x.xx.xx>]
```

3. Discover where entries are learned:

```
show vlan mac-address-entry [spbm-tunnel-as-mac]
```

4. Display the VLAN remote MAC table for a C-VLAN:

```
show vlan remote-mac-table <1-4059>
```

Example

```
Switch# show vlan i-sid
=====
```

```

=====
Vlan I-SID
=====
VLAN_ID    I-SID
-----
1
2
5          5
10
20

```

```

Switch# show isis spbm i-sid all
=====
SPBM ISID INFO
=====
ISID    SOURCE NAME    VLAN    SYSID          TYPE          HOST_NAME
-----
200     1.11.16        1000    0014.c7e1.33df config        SwitchA
300     1.11.16        1000    0014.c7e1.33df config        SwitchA
400     1.11.16        1000    0014.c7e1.33df config        SwitchA
200     1.11.16        2000    0014.c7e1.33df config        SwitchA
300     1.11.16        2000    0014.c7e1.33df config        SwitchA
400     1.11.16        2000    0014.c7e1.33df config        SwitchA
200     1.12.45        1000    0016.ca23.73df discover     SwitchA
300     1.12.45        1000    0016.ca23.73df discover     SwitchA
-----
Total number of SPBM ISID entries configed: 6
-----
Total number of SPBM ISID entries discovered: 2
-----
Total number of SPBM ISID entries: 8
-----

```

```

Switch:# show vlan mac-address-entry
=====
Vlan Fdb
=====
VLAN ID    STATUS    MAC ADDRESS          INTERFACE          SMLT REMOTE TUNNEL
-----
1          learned  00:1d:42:6b:10:03   Port-1/9          false SwitchB
1          learned  00:80:2d:22:ac:46   Port-1/15         false SwitchB
2          self     a4:25:1b:51:48:84   103.103.103.103   false -
2          self     02:01:03:ff:ff:ff   Tunnel_to_HQ      false -
5          learned  00:00:00:00:00:1a   access            false SwitchB
10         self     00:00:00:00:49:50   Port-1/9          false -
10         self     00:00:00:00:50:50   Port-1/9          false -

```

```

Switch# show vlan remote-mac-table 100
=====
Vlan Remote Mac Table
=====
VLAN STATUS  MAC-ADDRESS          DEST-MAC          BVLAN DEST-SYSNAME PORTS          SMLTREMOTE
-----
100 learned 00:15:40:af:d2:00 00:74:00:00:00:00 20     Switch-6005   MLT-2          false
100 learned b4:a9:5a:04:c8:83 b4:a9:5a:04:c8:65 3       Switch-174    103.103.103.103 true
100 learned b4:a9:5a:04:c8:84 b4:a9:5a:04:c8:66 3       Switch-175    Tunnel_to_HQ   true
-----
3 of 3 matching entries out of total of 3 Remote Mac entries in all fdb(s) displayed.
-----

```

Variable definitions

Use the data in the following table to use the **show vlan** commands.

Variable	Value
i-sid <1-4059>	Displays I-SID information for the specified C-VLAN.
mac-address-entry [spbm-tunnel-as-mac]	Displays the bridging forwarding database. Use the optional parameter, spbm-tunnel-as-mac to display the BMAC in the TUNNEL column. If you do not use this optional parameter, the TUNNEL column displays the host name. If an entry is not learned in the SPBM network, the TUNNEL column will be empty (-).
remote-mac-table <1-4059>	Displays C-VLAN remote-mac-table information.

Use the data in the following table to use the **show isis** commands.

Variable	Value
spbm i-sid {all config discover}	<ul style="list-style-type: none"> • all: displays all I-SID entries • config: displays configured I-SID entries • discover: displays discovered I-SID entries
vlan <1-4059>	Displays I-SID information for the specified SPBM VLAN.
id <1-16777215>	Displays I-SID information for the specified I-SID.
nick-name <x.xx.xx>	Displays I-SID information for the specified nickname.

Job aid

The following sections describe the fields in the outputs for the C-VLAN I-SID show commands.

show vlan i-sid

The following table describes the fields in the output for the **show vlan i-sid** command.

Parameter	Description
VLAN_ID	Indicates the VLAN IDs.
I-SID	Indicates the I-SIDs associated with the specified C-VLANs.

show isis spbm i-sid

The following describes the fields in the output for the **show isis spbm i-sid** command.

Parameter	Description
ISID	Indicates the IS-IS SPBM I-SID identifier.
SOURCE NAME	Indicates the nickname of the node where this I-SID was configured or discovered.  Note: SOURCE NAME is equivalent to nickname.

Table continues...

Parameter	Description
VLAN	Indicates the B-VLAN where this I-SID was configured or discovered.
SYSID	Indicates the system identifier.
TYPE	Indicates the SPBM I-SID type as either configured or discovered.
HOST_NAME	Indicates the host name of the multicast FIB entry.

show vlan mac-address-entry

The following table describes the fields in the output for the `show vlan mac-address-entry` command.

Parameter	Description
VLAN ID	Indicates the VLAN for this MAC address.
STATUS	Indicates the status of this entry: <ul style="list-style-type: none"> • other • invalid • learned • self • mgmt
MAC ADDRESS	Indicates the MAC address.
INTERFACE	Displays the network-to-network (NNI) interface.
SMLT REMOTE	Indicates the MAC address entry for the remote vIST peer.
TUNNEL	Indicates the host name of the remote Backbone Edge Bridge (BEB).

show vlan remote-mac-table

The following table describes the fields in the output for the `show vlan remote-mac-table` command.

Parameter	Description
VLAN	Indicates the VLAN ID for this MAC address.
STATUS	Indicates the status of this entry: <ul style="list-style-type: none"> • other • invalid • learned • self • mgmt

Table continues...

Parameter	Description
MAC-ADDRESS	Indicates the customer MAC address for which the bridge has forwarding and/or filtering information.
DEST-MAC	Indicates the provide MAC address for which the bridge has forwarding and/or filtering information.
BVLAN	Indicates the B-VLAN ID for this MAC address.
DEST-SYSNAME	Indicates the system name of the node where the MAC address entry comes from.
PORTS	Either displays the value 0 or indicates the port in which a frame comes from.
SMLT REMOTE	Indicates the MAC address entry for the remote vIST peer.

Configuring an SPBM Layer 2 Transparent Port UNI

Transparent Port UNI (T-UNI) maps a port or an MLT to an I-SID. T-UNI configures a transparent port where all traffic is MAC switched on an internal virtual port using the assigned I-SID. Multiple ports on the same unit and on other Backbone Edge Bridges (BEBs) are switched on a common I-SID. No VLAN is involved in this process. The T-UNI port is not a member of any VLAN or STG.

Consider the following design requirements when implementing this feature:

- Only E-LAN based T-UNI is supported. All T-UNI I-SID end points become members of the same shared E-LAN service. If an E-LINE type of service is required, provision T-UNI at the two end points comprising the point-to-point service.
- A port or MLT associated with a T-UNI I-SID cannot be part of any VLAN.
- Any Spanning Tree Protocol implementation is disabled on the port or MLT associated with the T-UNI I-SID. The port will always be in a Forwarding state.
- MACs are learned against the combination of the I-SID and port or MLT.
- Multiple ports or MLTs can be associated with same T-UNI I-SID.
- One port or MLT cannot be part of multiple T-UNI I-SIDs.
- No additional IS-IS TLVs are added to advertise or withdraw T-UNI I-SID services. Extreme Networks makes use of the existing IS-IS TLV-144 and sub TLV-3 to carry I-SID information.
- The MAC address limit is supported on a per-I-SID basis. For example, the MAC addresses learned on the T-UNI I-SID can be limited.
- IP traffic and control packets are transparently bridged over T-UNI endpoints.
- Untagged traffic ingressing on the T-UNI port will use port QoS. B-TAG and I-TAG priorities are derived from the port QoS.
- The 802.1p bits of the incoming traffic are used to derive the B-TAG and I-TAG priorities for tagged traffic.

- LACP and VLACP PDUs are extracted to the CP and all other control packets are transparently bridged over the T-UNI port or MLT.

This feature handles control PDUs in the following manner:

- All the Layer 2 and Layer 3 control packets are transparently bridged over the T-UNI port or MLT with the exception of LACP and VLACP PDUs. LACP PDUs and VLACP PDUs are not transparently bridged over the T-UNI port or MLT if LACP or VLACP is enabled on the port or MLT.
 - If an LACP MLT is associated with a T-UNI I-SID, LACP PDUs are extracted to CP and processed locally.
 - If LACP is not enabled globally and LACP MLT is not associated with the T-UNI I-SID, LACP PDUs are transparently bridged across the T-UNI port or MLT.
 - If a VLACP enabled port is added to a T-UNI I-SID, VLACP PDUs are extracted to the CP for local processing. If a port that is not VLACP enabled is added to the T-UNI I-SID, VLACP PDUs are transparently bridged across T-UNI port.
- The following list of control packet types are transparently bridged across the T-UNI I-SID:
 - SLPP
 - VRRP
 - OSPF
 - RIP
 - BGP
 - ISIS
 - CFM
 - STP
 - SONMP

*** Note:**

If you are configuring a T-UNI to terminate on a port or MLT on a switch in a vIST switch cluster, you must also configure the T-UNI I-SID on the other switch of the vIST switch cluster. You must configure the T-UNI I-SID on both switches of a vIST pair. It is not necessary to assign an actual port or MLT to the T-UNI on the second switch.

Use this procedure to configure a Transparent Port UNI or Elan-Transparent based service.

Before you begin

- You must configure the required SPBM and IS-IS infrastructure, which includes creating the SPBM BVLANS.
- You must associate a T-UNI LACP MLT with a VLAN before mapping the LACP MLT to a T-UNI I-SID.

⚠ Caution:

In the case of T-UNI LACP SMLT, before you configure SMLT on switch peers, ensure that the T-UNI LACP MLT on each peer is always associated with a VLAN, even if it is the default VLAN, and that it is added to a T-UNI I-SID. Otherwise, traffic is not forwarded on the T-UNI LACP MLT.

About this task

You can configure Transparent Port UNI when either of the following apply:

- You want all tagged and untagged traffic on a port to be classified into the same broadcast domain.
- You want to offer a transparent provider solution.

Procedure

1. Enter Global Configuration mode:

```
enable
configure terminal
```

2. Configure a Transparent Port UNI (Elan-Transparent based service). Enter:

```
i-sid <1-16777215> elan-transparent
```

This command automatically takes you to the Elan-Transparent I-SID Configuration mode.

3. Add ports to the Elan-Transparent based service. Enter:

```
port {slot/port[/sub-port] [-slot/port[/sub-port]] [, ...]}
```

A warning message displays indicating that adding a port to a T-UNI I-SID removes the port from all VLANs. Click **y** when prompted, to continue.

4. Add an MLT to the Elan-Transparent based service. Enter:

```
mlt <1-512>
```

A warning message displays indicating that adding an MLT to a Transparent Port UNI I-SID removes the MLT from all VLANs. Click **y** when prompted, to continue.

5. To verify the Transparent Port UNI configuration, enter:

```
show i-sid <1-16777215>
```

6. To remove ports or MLT from the Elan-Transparent based service, enter one of the following commands:

```
no port {slot/port[/sub-port] [-slot/port[/sub-port]] [, ...]}
```

OR

```
no mlt <1-512>
```

7. To delete the Elan-Transparent based service, enter:

```
no i-sid <1-16777215>
```

Example

Configure a Transparent Port UNI I-SID (elan-transparent based service).

```
Switch:1(config)#i-sid 300 elan-transparent

Switch:1(elan-tp:300)#port 1/25
Adding Ports to Transparent UNI i-sid removes it from all VLANs.
Do you wish to continue (y/n) ? y
Switch:1(elan-tp:300)#

Switch:1(elan-tp:300)#mlt 1
Adding MLTs to Transparent UNI i-sid removes it from all VLANs.
Do you wish to continue (y/n) ? y
Switch:1(elan-tp:300)#
```

Verify Transparent Port UNI or Elan-Transparent based service configuration.

```
Switch:1(elan-tp:300)#show i-sid 300
=====
Isid Info
=====
ISID      ISID      VLANID    PORT      MLT
ID        TYPE                               INTERFACES INTERFACES
-----
200       CVLAN     200       1/25     1
300       ELAN_TR   N/A       1/25     1
```

Variable definitions

Use the data in the following table to use the `i-sid` command.

*** Note:**

When SPB is enabled, ISID IDs 16000000 (0xF42400) and greater, up to 16,777,215 (0xFFFFF), are reserved for dynamic i-sid allocation and used to support IP Multicast traffic over SPB and other advanced Fabric services.

Variable	Value
i-sid <1–16777215> elan-transparent	Creates an Elan-Transparent based service. The service interface identifier (I-SID) range is 1 to 16777215.
port {slot/port[/sub-port][/-slot/port[/sub-port]][,...]}	Add ports to the Elan-Transparent based service.
mlt<1–512>	Add MLTs to the Elan-Transparent based service. The MLT range is 1 to 512.

Viewing all Configured I-SIDs

Perform this procedure to view all the configured I-SIDs including their types, ports, and MLTs.

About this task

View all configured I-SIDs (both CVLAN and T-UNI). View also the I-SID types and the ports or MLTs that are assigned to each I-SID.

Procedure

1. Enter Privileged EXEC mode:
enable
2. View all configured I-SIDs. This command displays both CVLAN and T-UNI based I-SIDs.
show i-sid
3. View all T-UNI (Elan-Transparent) I-SIDs.
show i-sid [elan-transparent]
4. View information for a particular T-UNI I-SID.
show i-sid [<1-16777215>]
5. View all IS-IS SPBM I-SID information by I-SID ID:
show isis spbm i-sid {all|config|discover} [vlan <2-4059>] [id <1-16777215>] [nick-name <x.xx.xx>]

Example

View all configured I-SIDs.

```
Switch:1(config)#show i-sid
```

```
=====
                        Isid Info
=====
```

ISID ID	ISID TYPE	VLANID	PORT INTERFACES	MLT INTERFACES
6	ELAN_TR	N/A	1/2	6
12	CVLAN	11	1/7	
34	ELAN_TR	4450	1/17	
100	ELAN_TR	7254	1/12	

```
All 4 out of 4 Total Num of i-sids displayed
Switch(config)#
```

View T-UNI (ELAN Transparent) I-SIDs.

```
Switch:1(config)#show i-sid elan-transparent
```

```
=====
                        Isid Info
=====
```

ISID ID	ISID TYPE	VLANID	PORT INTERFACES	MLT INTERFACES
100	ELAN_TR	N/A	1/12	
6	ELAN_TR	N/A	1/2	

```
All 2 out of 2 Total Num of elan-tp i-sids displayed
```

View MLT or port information for a particular T-UNI I-SID.

```
Switch:1(config)#show i-sid 6
```

```
=====
                        Isid Info
=====
```

ISID	ISID	PORT	MLT
6	ELAN_TR	1/2	6

ID	TYPE	VLANID	INTERFACES	INTERFACES
6	ELAN_TR	N/A	1/2	6

View all IS-IS SPBM I-SID information:

```
Switch:1#show isis spbm i-sid all

=====
                        SPBM ISID INFO
=====
ISID      SOURCE NAME  VLAN  SYSID                TYPE      HOST_NAME
-----
100       1.11.16     20    0014.c7e1.33df      config    Switch1
6         1.11.20     10    0014.c723.67df      discover  Switch2

Total number of SPBM ISID entries configured: 1
Total number of SPBM ISID entries discovered: 1
Total number of SPBM ISID entries: 2
=====
```

View all IS-IS SPBM I-SID information by I-SID ID:

```
Switch:1#show isis spbm i-sid all id 300

=====
                        SPBM ISID INFO
=====
ISID      SOURCE NAME  VLAN  SYSID                TYPE      HOST_NAME
-----
300       7.15.16     20    a425.1b51.9484      config    Switch1
300       4.01.18     10    b4a9.5a2a.d065      discover  Switch2

Total number of SPBM ISID entries configured: 1
Total number of SPBM ISID entries discovered: 1
Total number of SPBM ISID entries: 2
=====
```

Variable Definitions

Use the data in the following table to use the **show i-sid** command.

*** Note:**

When SPB is enabled, I-SID IDs 16777216 and greater are reserved for dynamic data I-SIDs, used to carry Multicast traffic over SPB.

Variable	Value
<1-16777215>	Specifies the service interface identifier (ISID).
elan-transparent	Displays only all the Elan-Transparent (T-UNI based) ISIDs.
spbm i-sid {all config discover}	<ul style="list-style-type: none"> all: displays all I-SID entries config: displays configured I-SID entries

Table continues...

Variable	Value
	• discover: displays discovered I-SID entries
vlan <2-4059>	Displays I-SID information for the specified SPBM VLAN.
id <1-16777215>	Displays I-SID information for the specified I-SID.
nick-name <x.xx.xx>	Displays I-SID information for the specified nickname.

Job Aid

The following table describes the fields in the output for the `show i-sid` command.

Table 11: show i-sid

Field	Description
ISID ID	Specifies the service interface identifier (I-SID)
ISID TYPE	Specifies the type of I-SID
VLANID	Specifies the backbone VLAN
PORT INTERFACES	Specifies the port that is assigned to the I-SID
MLT INTERFACES	Specifies the mlt that is assigned to the I-SID

The following describes the fields in the output for the `show isis spbm i-sid` command.

Table 12: show isis spbm i-sid

Field	Description
ISID	Indicates the IS-IS SPBM I-SID identifier.
SOURCE NAME	Indicates the nickname of the node where this I-SID was configured or discovered.  Note: SOURCE NAME is equivalent to nickname.
VLAN	Indicates the B-VLAN where this I-SID was configured or discovered.
SYSID	Indicates the system identifier.
TYPE	Indicates the SPBM I-SID type as either configured or discovered.
HOST_NAME	Indicates the host name of the multicast FIB entry.

Viewing C-MACs Learned on T-UNI Ports for an I-SID

Perform this procedure to view the I-SID bridge forwarding database.

About this task

The `show i-sid mac-address-entry` command displays the C-MACs learned on T-UNI I-SIDs. It also displays the C-MACs learned on T-UNI I-SIDs for a specific I-SID, MAC address, port or port list or remote MAC address.

Procedure

1. Log on to the switch to enter User EXEC mode.
2. View C-MACs learned on the T-UNI I-SIDs:

```
show i-sid mac-address-entry [<1-16777215>] [mac
<0x00:0x00:0x00:0x00:0x00:0x00>] [port {slot/port[/sub-port]} [-slot/
port[/sub-port]] [,...]] [remote]
```

Example

View C-MACs learned on all T-UNI I-SIDs.

```
Switch:1#show i-sid mac-address-entry
```

```
=====
I-SID Fdb Table
=====
I-SID  STATUS  MAC-ADDRESS  INTERFACE  TYPE  DEST-MAC  BVLAN  DEST-SYSNAME
-----
100    learned  cc:f9:54:ae:28:81  Port-1/16  LOCAL  00:00:00:00:00:00  0
4      learned  cc:f9:54:ae:2c:18  mlt-6      LOCAL  00:00:00:00:00:00  0
252    learned  cc:f9:54:ae:38:64  Port-1/15  REMOTE  00:13:0a:0c:d3:e0  128  DIST-1B
```

All 3 out of 3 Total Num of i-sid FDB Entries displayed

View C-MACs learned on a specific T-UNI I-SID.

```
Switch:1#show i-sid mac-address-entry 100
```

```
=====
I-SID Fdb Table
=====
I-SID  STATUS  MAC-ADDRESS  INTERFACE  TYPE  DEST-MAC  BVLAN  DEST-SYSNAME
-----
100    learned  cc:f9:54:ae:28:81  Port-1/16  LOCAL  00:00:00:00:00:00  0
```

All 1 out of 1 Total Num of i-sid FDB Entries displayed

```
Switch:1#show i-sid mac-address-entry 252
```

```
=====
I-SID Fdb Table
=====
I-SID  STATUS  MAC-ADDRESS  INTERFACE  TYPE  DEST-MAC  BVLAN  DEST-SYSNAME
-----
252    learned  cc:f9:54:ae:38:64  Port-1/15  REMOTE  00:13:0a:0c:d3:e0  128  DIST-1B
```

All 1 out of 1 Total Num of i-sid FDB Entries displayed

View C-MACs learned on a T-UNI I-SID for a specific MAC address.

```
Switch:1#show i-sid mac-address-entry mac cc:f9:54:ae:38:64
```

```
=====
I-SID Fdb Table
=====
I-SID  STATUS  MAC-ADDRESS  INTERFACE  TYPE  DEST-MAC  BVLAN  DEST-SYSNAME
-----
252    learned  cc:f9:54:ae:38:64  Port-1/15  REMOTE  00:13:0a:0c:d3:e0  128  DIST-1B
```

All 1 out of 1 Total Num of i-sid FDB Entries displayed

View C-MACs learned on aT-UNI I-SID for a specific port.

```
Switch:1#show i-sid mac-address-entry port 1/15
```

```

=====
I-SID Fdb Table
=====
I-SID STATUS MAC-ADDRESS INTERFACE TYPE DEST-MAC BVLAN DEST-SYSNAME
-----
252 learned cc:f9:54:ae:38:64 Port-1/15 REMOTE 00:13:0a:0c:d3:e0 128 DIST-1B
    
```

All 1 out of 1 Total Num of i-sid FDB Entries displayed

View C-MACs learned on a T-UNI I-SID as a remote MAC address.

```
Switch:1#show i-sid mac-address-entry remote
```

```

=====
I-SID Fdb Table
=====
I-SID STATUS MAC-ADDRESS INTERFACE TYPE DEST-MAC BVLAN DEST-SYSNAME
-----
252 learned cc:f9:54:ae:38:64 Port-1/15 REMOTE 00:13:0a:0c:d3:e0 128 DIST-1B
    
```

All 1 out of 1 Total Num of i-sid FDB Entries displayed

Variable Definitions

Use the data in the following table to use the `show i-sid mac-address-entry` command.

Variable	Value
<1-16777215>	Displays the MAC address learned on the service interface identifier (ISID).
mac <0x00:0x00:0x00:0x00:0x00:0x00>	Displays the I-SID FDB details for the specified MAC address.
port {slot/port[/sub-port] [-slot/port[/sub-port]] [...]}	Displays the MAC address learned on the specified port or port list.
remote	Displays the remote MAC address learned on the I-SID.

Job Aid

The following table describes the fields in the output for the `show i-sid mac-address-entry` command.

Table 13: show i-sid

Field	Description
I-SID	Specifies the service interface identifier (I-SID).
STATUS	Specifies the learning status of the associated MAC.

Table continues...

Field	Description
MAC-ADDRESS	Specifies the MAC address of the port assigned to the specific I-SID or MAC learned on the specific I-SID.
INTERFACE	Specifies the port or MLT on which the MAC is learned for the specific I-SID.
TYPE	Specifies whether the MAC is a Local or IST PEER or a Remote MAC.
DEST-MAC	Specifies the virtual BMAC address or system ID, in MAC format, of the destination node.
BVLAN	Specifies the BVLAN on which the destination node is discovered for the I-SID.
DEST-SYSNAME	Specifies the destination system name.

Viewing I-SID maximum MAC-limit

Perform this procedure to view the maximum MAC learning limit information for an I-SID.

! Important:

The command `show i-sid limit-fdb-learning` is supported only on the Virtual Services Platform 4000 Series.

About this task

The total MAC learning limit per switch is 32000. MAC learning on I-SID stops when the maximum limit is reached.

Procedure

View the maximum MAC learning limit configured for an I-SID:

```
show i-sid limit-fdb-learning <1-16777215>
```

Example

View maximum MAC learning limit for all I-SIDs.

```
Switch:1#show i-sid limit-fdb-learning
```

```
=====
          Isid MAC-Limit Info
=====
ISID      MAC-LIMIT  MAXMAC
ID        STATUS    COUNT
-----
10         disabled   32000
11         disabled   32000
12         disabled   32000
15         disabled   32000
101        disabled   32000
```

```
All 5 out of 5 Total Num of i-sid Info displayed
```

View maximum MAC learning limit for a specific I-SID.

```
Switch:1#show i-sid limit-fdb-learning 10
=====
Isid MAC-Limit Info
=====
ISID      MAC-LIMIT  MAXMAC
ID        STATUS     COUNT
-----
10        disabled   32000
All 1 out of 1 Total Num of i-sid Info displayed
```

Variable definitions

Use the data in the following table to use the `show i-sid limit-fdb-learning` command.

! Important:

The command `show i-sid limit-fdb-learning` is supported only on the Virtual Services Platform 4000 Series.

Variable	Value
limit-fdb-learning	Displays the I-SID-based maximum MAC limit information.
<1-6777215>	Displays the service interface identifier (ISID). The ISID range is 1 to 16777215.

Job aid

The following table describes the fields in the output of the `show i-sid limit-fdb-learning` command.

! Important:

The command `show i-sid limit-fdb-learning` is supported only on the Virtual Services Platform 4000 Series.

Table 14: show i-sid limit-fdb-learning

Field	Description
ISID ID	Specifies the service interface identifier (ISID)
MAC-LIMIT STATUS	Specifies whether the MAC learning limit is enabled or disabled
MAXMAC COUNT	Specifies the MAC learning limit

Configuring an SPBM Layer 2 Switched UNI on an MLT

Shortest Path Bridging MAC (SPBM) supports Layer 2 Virtual Service Network (VSN) functionality where Switched UNIs are bridged over the SPBM core infrastructure.

Switched User Network Interface (S-UNI) allows the association of local endpoints to I-SIDs based on local port and VLAN together. With switched UNI, the same VLAN can be used on one port to create an endpoint to one I-SID, and on another port to create an endpoint to another I-SID.

Before you begin

- You must configure the required SPBM and IS-IS infrastructure.

About this task

To configure a Switched UNI on an MLT, you must create a Switched UNI I-SID, and map an MLT to the Switched UNI I-SID.

Procedure

1. Enter MLT Interface Configuration mode:

```
enable
configure terminal
interface mlt <1-512>
```

2. Enable S-UNI on MLT:

```
flex-uni enable
```

*** Note:**

Spanning tree is disabled on all the Switched UNI ports.

*** Note:**

You cannot enable Switched UNI on EAPoL enabled interface.

3. Configure a Switched UNI Service Instance Identifier (I-SID):

```
i-sid <1-16777215> [elan]
```

This command automatically takes you to the Elan I-SID Configuration mode.

4. Add an MLT to a Switched UNI I-SID:

```
c-vid <1-4094> mlt <1-512>
```

C-VID is customer VLAN ID. This command maps a VLAN ID to an MLT.

*** Note:**

You can run this command again to map a Switched UNI MLT to multiple I-SIDs.

5. Add untagged traffic to a Switched UNI I-SID:

```
untagged-traffic mlt <1-512> [bpdu enable]
```

6. Display the Switched UNI information:

```
show mlt i-sid
```

Example

```
Switch> enable
Switch# configure terminal
Switch(config)# mlt 10
Switch(config)# interface mlt 10
Switch(config-mlt)# flex-uni enable
Switch(config-mlt)# i-sid 100
Switch(elan:100)# c-vid 20 mlt 10
Switch(elan:100)# untagged-traffic mlt 10 bpdu enable
Switch(elan:100)# show mlt i-sid
```

```
=====
                                MLT Isid Info
=====
MLTID   IFINDEX  ISID      VLANID  C-VID   ISID     ORIGIN      BPDU
        ID
-----  -
10      6153    100      N/A     20      ELAN     CONFIG
-----  -
1 out of 1 Total Num of i-sid endpoints displayed
```

Variable definitions

Use the data in the following table to use the `i-sid` command to configure a Switched UNI.

Variable	Value
<code>i-sid <1-16777215> elan</code>	Creates an Elan based service. The service interface identifier (I-SID) range is 1 to 16777215.
<code>c-vid <1-4094> mlt <mlt-id></code>	Add MLT to the Elan based service. C-VID is customer VLAN ID. This command maps a VLAN ID to an MLT.
<code>untagged-traffic mlt <mlt-id> [bpdu enable]</code>	Add untagged traffic to the Elan-based service.

Configuring an SPBM Layer 2 Switched UNI on a Port

Shortest Path Bridging MAC (SPBM) supports Layer 2 Virtual Service Network (VSN) functionality where Switched UNIs are bridged over the SPBM core infrastructure.

Switched User Network Interface (S-UNI) allows the association of local endpoints to I-SIDs based on local port and VLAN together. With switched UNI, the same VLAN can be used on one port to create an endpoint to one I-SID, and on another port to create an endpoint to another I-SID.

Before you begin

- You must configure the required SPBM and IS-IS infrastructure.

About this task

To configure a Switched UNI on a port, you must create a Switched UNI I-SID, and map the port to the Switched UNI I-SID.

Procedure

1. Enter GigabitEthernet Interface Configuration mode:

```
enable

configure terminal

interface GigabitEthernet {slot/port[/sub-port] [-slot/port[/sub-
port]] [,...]}
```

*** Note:**

If your platform supports channelization and the port is channelized, you must also specify the sub-port in the format slot/port/sub-port.

2. Enable S-UNI on a port:

```
flex-uni enable
```

*** Note:**

Spanning tree is disabled on all the Switched UNI ports.

*** Note:**

You cannot enable Switched UNI on EAPoL enabled interface.

3. Configure a Switched UNI Service Instance Identifier (I-SID):

```
i-sid <1-16777215> [elan]
```

This command automatically takes you to the Elan I-SID Configuration mode.

4. Add ports to a Switched UNI I-SID:

```
c-vid <1-4094> port {slot/port[/sub-port] [-slot/port[/sub-port]]
[,...]}
```

5. Add untagged traffic to a Switched UNI I-SID:

```
untagged-traffic port {slot/port[/sub-port] [-slot/port[/sub-port]]
[,...]} [bpdu enable]
```

6. Display the Switched UNI information:

```
show interface gigabitethernet i-sid {slot/port[/sub-port] [-slot/
port[/sub-port]] [,...]}
```

Example

```
Switch> enable

Switch# configure terminal
```

Layer 2 VSN configuration

```
Switch(config)# interface gigabitethernet 1/1,1/2
Switch(config-if)# flex-uni enable
Switch(config-if)# i-sid 100
Switch(elan:100)# c-vid 10 port 1/1,1/2
Switch(elan:100)# untagged-traffic port 1/1,1/2 bpdu enable
Switch(elan:100)# show interface gigabitethernet i-sid
```

```
=====
                                PORT Isid Info
=====
PORTNUM   IFINDEX   ISID      VLANID C-VID   ISID      ORIGIN      BPDU
-----
1/1       192       100       N/A    10     ELAN      CONFIG
1/2       193       100       N/A    10     ELAN      CONFIG
-----
2 out of 3 Total Num of i-sid endpoints displayed
```

Variable definitions

Use the data in the following table to use the `i-sid` command to configure a Switched UNI.

Variable	Value
<code>i-sid <1-16777215> elan</code>	Creates an Elan based service. The service interface identifier (I-SID) range is 1 to 16777215.
<code>c-vid <1-4094> port {slot/port[/sub-port] [-slot/port[/sub-port]][, ...]}</code>	Add ports to the Elan-based service.
<code>untagged-traffic < port {slot/port[/sub-port] [-slot/port[/sub-port]][, ...]}> [bpdu enable]</code>	Add untagged traffic to the Elan-based service.

Viewing all configured Switched UNI I-SIDs

Perform this procedure to view all the configured S-UNI I-SIDs including their types, ports, and MLTs.

Procedure

1. Enter Privileged EXEC mode:
`enable`
2. View all configured I-SIDs. This command displays CVLAN, T-UNI, and S-UNI based I-SIDs.
`show i-sid`
3. View all S-UNI I-SIDs.
`show i-sid [elan]`
4. View all associated MLT on the S-UNI I-SID.

```
show mlt i-sid [MLT ID <1-512>]
```

5. View all associated ports on the S-UNI I-SID.

```
show interface gigabitethernet i-sid {slot/port[/sub-port] [-slot/
port[/sub-port]] [, ...]}
```

6. View all IS-IS SPBM multicast FIB entries.

```
show isis spbm multicast-fib detail
```

Example

View all configured I-SIDs.

```
Switch:1# show i-sid
```

```
=====
Isid Info
=====
ISID      ISID      VLANID    PORT      MLT      ORIGIN
ID        TYPE                               INTERFACES INTERFACES
-----
999       ELAN      99        -         c110:100  CONFIG
          99        1/21      -
c: customer vid    u: untagged-traffic
All 1 out of 1 Total Num of i-sids displayed
```

View all S-UNI I-SIDs.

```
Switch:1# show i-sid elan
```

```
=====
Isid Info
=====
ISID      ISID      VLANID    PORT      MLT      ORIGIN
ID        TYPE                               INTERFACES INTERFACES
-----
312       ELAN      N/A       -         c710:1   DISC_BOTH
513       ELAN      N/A       -         c513:1   DISC_BOTH
2000      ELAN      200       c20:1/3   -        CONFIG
2001      ELAN      201       -         c121:1   CONFIG
2002      ELAN      202       -         c222:2   CONFIG
2004      ELAN      204       c420:1/3  -        CONFIG
          -         c421:1
          -         c422:2
3000      ELAN      N/A       c30:1/3   -        CONFIG
          -         c31:1
          -         c32:2
3010      ELAN      N/A       c130:1/3  -        CONFIG
3020      ELAN      N/A       -         -        CONFIG
3030      ELAN      N/A       c330:1/3  -        CONFIG
3040      ELAN      N/A       -         c431:1   CONFIG
          -         u:2
3050      ELAN      N/A       -         c531:1   DISC_BOTH
3070      ELAN      N/A       c730:1/3  -        CONFIG
          -         c731:1
          -         c732:2
4000      ELAN      400       c40:1/3   -        CONFIG
          -         c41:1
          -         c42:2
```

Layer 2 VSN configuration

4011	ELAN	411	c140:1/3	-	CONFIG
4013	ELAN	413	c340:1/3	-	CONFIG
4014	ELAN	414	-	c441:1	CONFIG
				c442:2	
4015	ELAN	415	-	c541:1	DISC_BOTH
4017	ELAN	417	c740:1/3	-	CONFIG
				c741:1	
				c742:2	
5010	ELAN	500	c50:1/3	-	CONFIG
				c51:1	
				c52:2	
5011	ELAN	501	u:1/3	-	CONFIG
5013	ELAN	503	c350:1/3	-	CONFIG
5014	ELAN	504	-	c451:1	CONFIG
				c452:2	
5015	ELAN	505	-	c551:1	CONFIG
				c552:2	
5017	ELAN	507	c750:1/3	-	CONFIG
				c751:1	
				c752:2	
6000	ELAN	600	c60:1/3	-	CONFIG
6001	ELAN	601	-	c161:1	DISC_BOTH
6002	ELAN	602	-	c262:2	CONFIG
6004	ELAN	604	c460:1/3	-	CONFIG
				c461:1	
				c462:2	
7000	ELAN	700	c70:1/3	-	CONFIG
7001	ELAN	701	-	c171:1	DISC_BOTH
7002	ELAN	702	-	c272:2	CONFIG
7004	ELAN	704	c470:1/3	-	CONFIG
				c471:1	
				c472:2	
8000	ELAN	800	c80:1/3	-	CONFIG
8001	ELAN	801	-	c181:1	DISC_BOTH
8002	ELAN	802	-	c282:2	CONFIG
8004	ELAN	804	c480:1/3	-	CONFIG
				c481:1	
				c482:2	
9000	ELAN	900	c90:1/3	-	CONFIG
9001	ELAN	901	-	c191:1	CONFIG
9002	ELAN	902	-	292:2	CONFIG
9004	ELAN	904	c490:1/3	-	CONFIG
				c491:1	
				c492:2	
9005	ELAN	N/A	-	c400:1	DISC_BOTH

c: customer vid u: untagged-traffic

All 42 out of 42 Total Num of Elan i-sids displayed

View all associated MLT on the S-UNI I-SID.

Switch:1# show mlt i-sid

```

=====
MLT Isid Info
=====
MLTID  IFINDEX  ISID      VLANID  C-VID  ISID      ORIGIN      BPDU
-----  -
10     6153     100      N/A     20     ELAN      CONFIG
=====

```

```
1 out of 1 Total Num of i-sid endpoints displayed
```

View all associated ports on the S-UNI I-SID.

```
Switch:1# show interface gigabitethernet i-sid
```

```
=====
                                PORT Isid Info
=====
```

PORTNUM	IFINDEX	ISID ID	VLANID	C-VID	ISID TYPE	ORIGIN	BPDU
1/1	192	100	N/A	10	ELAN	CONFIG	
1/2	193	100	N/A	10	ELAN	CONFIG	

```
-----
```

```
2 out of 3 Total Num of i-sid endpoints displayed
```

View all IS-IS SPBM multicast FIB entries.

```
Switch:1# show isis spbm multicast-fib detail
```

```
=====
                                SPBM MULTICAST FIB ENTRY DETAIL INFO
=====
```

MCAST DA	ISID	BVLAN	SYSID	HOST-NAME	OUTGOING-INTERFACES	INCOMING INTERFACE	CVLAN
03:77:77:00:0b:b8	3000	1001	0000.beb0.0007	BEB-07	MLT-1 c30:1/3 c31:MLT-1 c32:MLT-2	1/2	0
03:77:77:00:0f:a0	4000	1001	0000.beb0.0007	BEB-07	c40:1/3 c41:MLT-1 c42:MLT-2	1/2	400
03:77:77:00:13:92	5010	1001	0000.beb0.0007	BEB-07	c50:1/3 c51:MLT-1 c52:MLT-2	1/2	500
03:88:88:00:0b:b8	3000	1001	0000.beb0.0008	BEB-08	MLT-1 c30:1/3 c31:MLT-1 c32:MLT-2	1/2	0
03:88:88:00:0f:a0	4000	1001	0000.beb0.0008	BEB-08	c40:1/3 c41:MLT-1	1/2	400

```
-----
Total number of SPBM MULTICAST FIB entries 157
-----
```

Variable definitions

Use the data in the following table to use the `i-sid` command.

Variable	Value
elan	Displays only all the Elan (S-UNI based) I-SIDs.
MLT ID <1-512>	Specifies the MLT associated with the Switched UNI I-SID.
{slot/port[/sub-port] [-slot/port[/sub-port]] [,...]}	Specifies the ports associated with the Switched UNI I-SID.

Displaying C-VLAN and Switched UNI I-SID information

Use the following procedure to display C-VLAN I-SID information.

Procedure

1. Log on to the switch to enter User EXEC mode.

2. Display the C-VLAN to I-SID associations:

```
show vlan i-sid <1-4059>
```

3. Display I-SID information and Switched UNI to I-SID associations:

```
show i-sid <1-16777215>
```

4. Display the IS-IS SPBM multicast-FIB calculation results by I-SID:

```
show isis spbm i-sid {all|config|discover} [vlan <1-4059>] [id <1-16777215>] [nick-name <x.xx.xx>]
```

5. Display all elan I-SID:

- show i-sid elan

6. Display I-SID configured on MLT:

- show mlt i-sid

7. Display I-SID configured on port:

- show interfaces gigabitethernet i-sid

Example

```
Switch:1#show vlan i-sid
```

```
=====
                                Vlan I-SID
=====
VLAN_ID    I-SID
-----
1
2
5           5
10
20
```

```
Switch:1#show isis spbm i-sid all
```

```
=====
                                SPBM ISID INFO
=====
ISID      SOURCE NAME    VLAN  SYSID                TYPE        HOST_NAME
-----
200       1.11.16        1000  0014.c7e1.33df       config      Switch1
300       1.11.16        1000  0014.c7e1.33df       config      Switch1
400       1.11.16        1000  0014.c7e1.33df       config      Switch1
200       1.11.16        2000  0014.c7e1.33df       config      Switch1
300       1.11.16        2000  0014.c7e1.33df       config      Switch1
400       1.11.16        2000  0014.c7e1.33df       config      Switch1
200       1.12.45        1000  0016.ca23.73df       discover    Switch2
300       1.12.45        1000  0016.ca23.73df       discover    Switch2
```

```
-----
Total number of SPBM ISID entries configed: 6
-----
```

```
-----
Total number of SPBM ISID entries discovered: 2
-----
```

```
-----
Total number of SPBM ISID entries: 8
-----
```

```
switch:1#show i-sid
```

```
=====
                                Isid Info
=====
ISID      ISID      VLANID    PORT      MLT      ORIGIN
ID        TYPE                               INTERFACES INTERFACES
-----
999       ELAN      99        -         c110:100  CONFIG
          99        1/21      -
```

```
c: customer vid    u: untagged-traffic
```

```
All 1 out of 1 Total Num of i-sids displayed
```

```
switch:1#show mlt i-sid
```

```
=====
                                MLT Isid Info
=====
MLTID  IFINDEX  ISID      VLANID  C-VID  ISID      ORIGIN      BPDU
      ID                               TYPE
-----
10     6153    100      N/A     20     ELAN      CONFIG
```

```
1 out of 1 Total Num of i-sid endpoints displayed
```

```
switch:1#show interfaces gigabitEthernet i-sid
```

```
=====
                                PORT Isid Info
=====
PORTNUM IFINDEX  ISID      VLANID  C-VID  ISID      ORIGIN      BPDU
      ID                               TYPE
-----
1/1     192     100      N/A     10     ELAN      CONFIG
1/2     193     100      N/A     10     ELAN      CONFIG
```

```
2 out of 3 Total Num of i-sid endpoints displayed
```

Variable definitions

Use the data in the following table to use the **show vlan i-sid** commands.

Variable	Value
<1-4059>	Displays I-SID information for the specified C-VLAN. You can specify the VLAN ID.

Use the data in the following table to use the **show i-sid** commands

Variable	Value
<1-16777215>	Displays I-SID information. You can specify the I-SID ID.

Use the data in the following table to use the **show isis** commands.

Variable	Value
spbm i-sid {all config discover}	<ul style="list-style-type: none"> • all: displays all I-SID entries • config: displays configured I-SID entries • discover: displays discovered I-SID entries

Job aid

The following sections describe the fields in the outputs for the C-VLAN I-SID show commands.

show vlan i-sid

The following table describes the fields in the output for the **show vlan i-sid** command.

Parameter	Description
VLAN_ID	Indicates the VLAN IDs.
I-SID	Indicates the I-SIDs associated with the specified C-VLANs.

show i-sid

The following table describes the fields in the output for the **show i-sid** command.

Parameter	Description
I-SID	Indicates the I-SID IDs.
I-SID TYPE	Indicated the I-SID type. <ul style="list-style-type: none"> • T-UNI: Transparent UNI service. • ELAN: any to any service (switched service). • CVLAN: CVLAN based service.
VLANID	Indicates the VLAN IDs.
PORT INTERFACES	Indicated the port interface.
MLT INTERFACES	Indicates the MLT interface.
ORIGIN	Indicates if the I-SID is discovered by Fabric Attach or manually added.

show isis spbm i-sid

The following describes the fields in the output for the **show isis spbm i-sid** command.

Parameter	Description
ISID {all discover config}	Indicates the IS-IS SPBM I-SID identifier. <ul style="list-style-type: none"> • all: display all SPBM I-SID • discover: display discovered SPBM I-SID

Table continues...

Parameter	Description
	<ul style="list-style-type: none"> config: display configured SPBM I-SID
SOURCE_NAME	<p>Indicates the nickname of the node where this I-SID was configured or discovered.</p> <p> Note: SOURCE_NAME is equivalent to nickname.</p>
VLAN	Indicates the B-VLAN where this I-SID was configured or discovered.
SYSID	Indicates the system identifier.
TYPE	Indicates the SPBM I-SID type as either configured or discovered.
HOST_NAME	Indicates the host name of the multicast FIB entry.

Layer 2 VSN configuration using EDM

This section provides procedures to configure Layer 2 Virtual Services Networks (VSNs) using Enterprise Device Manager (EDM).

Configuring SPBM Layer 2 VSN

After you have configured the SPBM infrastructure, you can enable the SPBM Layer 2 Virtual Service Network (VSN) using the following procedure.

SPBM supports Layer 2 VSN functionality where customer VLANs (C-VLANs) are bridged over the SPBM core infrastructure.

At the BEBs, customer VLANs (C-VLAN) are mapped to I-SIDs based on the local service provisioning. Outgoing frames are encapsulated in a MAC-in-MAC header, and then forwarded across the core to the far-end BEB, which strips off the encapsulation and forwards the frame to the destination network based on the I-SID-to-C-VLAN provisioning.

Before you begin

- You must configure the required SPBM and IS-IS infrastructure, which includes the creation of SPBM B-VLANs.
- You must create the customer VLANs (C-VLANs) and add slots/ports.

Procedure

- In the navigation pane, expand the **Configuration > VLAN** folders.
- Click **VLANs**.

3. Click the **Advanced** tab.
4. To map a C-VLAN to a Service instance identifier (I-SID), in the **I-sid** field, specify the I-SID to associate with the specified VLAN.
5. Click **Apply**.

! Important:

- When a protocol VLAN is created, all ports are added to the VLAN including SPBM ports. To configure a protocol-based VLAN as a C-VLAN, you must first remove the SPBM-enabled ports from the protocol based VLAN, and then configure the protocol-based VLAN as a C-VLAN.
- The switch reserves I-SID 0x00ffffff. The switch uses this I-SID to advertise the virtual B-MAC in a SMLT dual-homing environment. The platform clears the receive and transmit bit of this I-SID, therefore I-SID 0x00ffffff cannot be used for any other service.

Displaying the remote MAC table for a C-VLAN

Use the following procedure to view a the remote MAC table for a C-VLAN.

Procedure

1. In the navigation pane, expand the **Configuration > VLAN** folders.
2. Click **VLANs**.
3. Click the **Remote MAC** tab.

Remote MAC field descriptions

Use the data in the following table to use the **Remote MAC** tab.

Name	Description
VlanId	Indicates the VLAN ID for this MAC address.
Addr	Indicates the customer MAC address for which the bridge has forwarding and/or filtering information
DestAddr	Indicates the provider MAC address for which the bridge has forwarding and/or filtering information.
PrimaryBVlanId	Indicates the primary B-VLAN ID for this MAC address.
PrimaryDestSysName	Indicates the primary system name of the node where the MAC address entry comes from.
PrimaryPort	Either displays the value 0, or indicates the primary port on which a frame came from.
SecondaryBVlanId	Indicates the secondary B-VLAN ID for this MAC address

Table continues...

Name	Description
SecondaryDestSysName	Indicates the secondary system name of the node where the MAC address entry comes from.
SecondaryPort	Either displays the value 0, or indicates the secondary port on which a frame came from.
SmltRemote	Indicates the MAC address entry for the remote vIST peer.
Status	Indicates the status of this entry: <ul style="list-style-type: none"> • other • invalid • learned • self • mgmt

Configuring UNI

Use the following procedure to configure a Transparent Port UNI or Switched UNI by mapping an I-SID to a port or MLT and VLAN together.

Consider the following design requirements when implementing Transparent Port UNI (T-UNI):

- Only E-LAN based T-UNI is supported. All T-UNI I-SID end points become members of the same shared E-LAN service. If an E-LINE type of service is required, provision T-UNI at the two end points comprising the point-to-point service.
- A port or MLT associated with a T-UNI I-SID cannot be part of any VLAN.
- Any Spanning Tree Protocol implementation is disabled on the port or MLT associated with the T-UNI I-SID. The port will always be in a Forwarding state.
- MACs are learned against the combination of the I-SID and port or MLT.
- Multiple ports or MLTs can be associated with same T-UNI I-SID.
- One port or MLT cannot be part of multiple T-UNI I-SIDs.
- No additional IS-IS TLVs are added to advertise or withdraw T-UNI I-SID services. The existing IS-IS TLV-144 and sub TLV-3 are made use of to carry the I-SID information.
- The MAC address limit is supported on a per-I-SID basis. For example, the MAC addresses learned on the T-UNI I-SID can be limited.
- IP traffic and control packets are transparently bridged over T-UNI endpoints.
- Untagged traffic ingressing on the T-UNI port will use port QoS. B-TAG and I-TAG priorities are derived from the port QoS.
- The 802.1p bits of the incoming traffic are used to derive the B-TAG and I-TAG priorities for tagged traffic.

- LACP and VLACP PDUs are extracted to the CP and all other control packets are transparently bridged over the T-UNI port or MLT.

T-UNI handles control PDUs in the following manner:

- All the Layer 2 and Layer 3 control packets are transparently bridged over the T-UNI port or MLT with the exception of LACP and VLACP PDUs. LACP PDUs and VLACP PDUs are not transparently bridged over the T-UNI port or MLT if LACP or VLACP is enabled on the port or MLT.
 - If an LACP MLT is associated with a T-UNI I-SID, LACP PDUs are extracted to CP and processed locally.
 - If LACP is not enabled globally and LACP MLT is not associated with the T-UNI I-SID, LACP PDUs are transparently bridged across the T-UNI port or MLT.
 - If a VLACP enabled port is added to a T-UNI I-SID, VLACP PDUs are extracted to the CP for local processing. If a port that is not VLACP enabled is added to the T-UNI I-SID, VLACP PDUs are transparently bridged across T-UNI port.
- The following list of control packet types are transparently bridged across the T-UNI I-SID:
 - SLPP
 - VRRP
 - OSPF
 - RIP
 - BGP
 - ISIS
 - CFM
 - STP
 - SONMP

Note:

If you are configuring a T-UNI to terminate on a port or MLT on a switch in a vIST switch cluster, you must also configure the T-UNI I-SID on the other switch of the vIST switch cluster. You must configure the T-UNI I-SID on both switches of a vIST pair. It is not necessary to assign an actual port or MLT to the T-UNI on the second switch.

About this task

You must first create a type of service instance identifier (I-SID) to create the different types of services available. After you create an I-SID you can add members (ports or MLTs) to the I-SID to create end-points for the service.

Procedure

1. In the navigation pane, expand the **Configuration > IS-IS** folders.
2. Click **ISID**.

3. Click the **Service** tab.
4. To create a Transparent Port UNI service:
 - a. Click **Insert**.
 - b. Select **elan Transparent** in the **Type** field.
 - c. Enter the I-SID in the **Id** field.
5. To create a Switched UNI service:

*** Note:**

Flex UNI must be enabled to create a Switched UNI service.

- a. Click **Insert**.
 - b. Select **elan** in the **Type** field.
 - c. Enter the I-SID in the **Id** field.
6. Click **Insert**.

Service field descriptions

Use the data in the following table to use the **Service** tab.

Name	Description
ID	Specifies a unique value to identify the service associated with this entry.
Type	Specifies the type of service associated with this entry.
MacLimitEnable	Indicates whether the MAC limit is enabled (true) or disabled (false).
MaxMacLimit	Indicates the maximum learned value of the MAC address for each service I-SID.
Action	Specifies I-SID related actions.
Origin	Specifies the origin of the I-SID.

Associating a port and MLT with an ISID for Elan Transparent

Transparent Port UNI (T-UNI) maps a port or MLT to an I-SID. Transparent Port UNI configures a transparent port where all traffic is MAC switched on an internal virtual port using the assigned I-SID. Multiple ports on the same unit and on other Backbone Edge Bridges (BEBs) are switched on a common I-SID. No VLAN is involved in this process. The T-UNI port is not a member of any VLAN or STG.

Use the following procedure to associate a port and MLT with an ISID.

Before you begin

- You must configure Transparent Port UNI. For more information, see [Configuring Transparent UNI](#) on page 297.

- You must associate a T-UNI LACP MLT with a VLAN before mapping the LACP MLT to a T-UNI ISID.

 **Caution:**

Ensure that a T-UNI LACP MLT is always associated with a VLAN (even if it is the default VLAN) before adding it to a T-UNI ISID. Otherwise, traffic is not forwarded on the T-UNI LACP MLT.

Procedure

1. In the navigation pane, expand the **Configuration > IS-IS** folders.
2. Click **ISID**.
3. Click on a row with type configured as elanTransparent.
4. Click **ELAN**.
5. Select port members.
6. Select MLT Ids.
7. Click **Apply**.

Elan Transparent field descriptions

Use the data in the following table to use the Elan Transparent tab.

Name	Description
PortMembers	The set of ports that are members of the elanTransparent service type. From the ports available, you can select single or multiple ports.
MltIds	The set of bits that represent the MLT Ids. From the MLTs available, you can select any, or all of the MLTs to be a part of elan transparent i-sid .

Viewing the ISID forwarding database

View the I-SID forwarding database (FDB).

 **Note:**

To view the T-UNI I-SID FDB entries filtered on a port that is part of an MLT, you must mention the MLT ID in the option for the port.

Procedure

1. In the navigation pane, expand the **Configuration > IS-IS** folders.
2. Click **ISID**.
3. Click the **FDB** tab.
 - Click **Filter** to filter rows based on specific filter criteria.

FDB field descriptions

Use the data in the following table to use the FDB tab.

Name	Description
IsidId	Specifies the service interface identifier (I-SID).
Address	Specifies the MAC address of the port assigned to the specific I-SID or C-MAC learned on the particular I-SID.
Status	Specifies the learning status of the associated MAC.
Port	Specifies the port on which the MAC is learned for the specific I-SID.
PortType	Specifies whether the MAC is a local or IST-peer or a remote MAC.
RemoteMacDestAddr	Specifies the virtual BMAC address or system-ID of the remote destination.
RemoteMacBVlanId	Specifies the BVLAN ID on which the remote destination was discovered.
RemoteMacDestSysName	Specifies the remote destination system name.
Cvid	Specifies the customer VLAN ID of the associated switched uni port.

Associating a port and MLT with an I-SID for Elan

Shortest Path Bridging MAC (SPBM) supports Layer 2 Virtual Service Network (VSN) functionality where Switched UNIs are bridged over the SPBM core infrastructure.

Switched User Network Interface (S-UNI) allows the association of local endpoints to I-SIDs based on local port and VLAN together. With switched UNI, the same VLAN can be used on one port to create an endpoint to one I-SID, and on another port to create an endpoint to another I-SID.

Use the following procedure to associate a port and MLT with an I-SID.

About this task

You must configure Switched UNI.

Procedure

1. In the navigation pane, expand the **Configuration > IS-IS** folders.
2. Click **ISID**.
3. Click the row with type configured as elan.
4. Click **Switched Uni**.
5. Click **Insert**.
6. Enter the VLAN ID in the **Cvid** field.

7. Click **Port** or **Mlt** to update the interface index in the **IfIndex** field.
8. Click **Insert**.

Switched Uni field descriptions

Use the data in the following table to use the **Switched Uni** tab.

Name	Description
Cvid	Specifies the customer VLAN identifier.
IfIndex	Specifies the interface index of the Elan end point.

Viewing the I-SID interface

View the I-SID interface.

Procedure

1. In the navigation pane, expand the **Configuration > IS-IS** folders.
2. Click **ISID**.
3. Click the **Interface** tab.

Click **Filter** to filter rows on specific filter criteria.

Interface field descriptions

Use the data in the following table to use the **Interface** tab.

Name	Description
IfIndex	Specifies the interface index.
Isid	Specifies the service interface identifier (I-SID).
Vlan	Specifies the platform VLAN.
Cvid	Specifies the customer VID.
Type	Specifies the type of service associated with the I-SID interface.
Origin	Specifies the origin of the service associated with the I-SID interface.
Bpdu	Specifies the BPDU forward option for the untagged traffic port.

Layer 2 VSN configuration examples

This section provides configuration examples to configure Layer 2 VSNs.

Examples and network illustrations in this document may illustrate only one of the supported platforms. Unless otherwise noted, the concept illustrated applies to all supported platforms.

Layer 2 VSN configuration example

The following figure shows a sample Layer 2 VSN deployment.

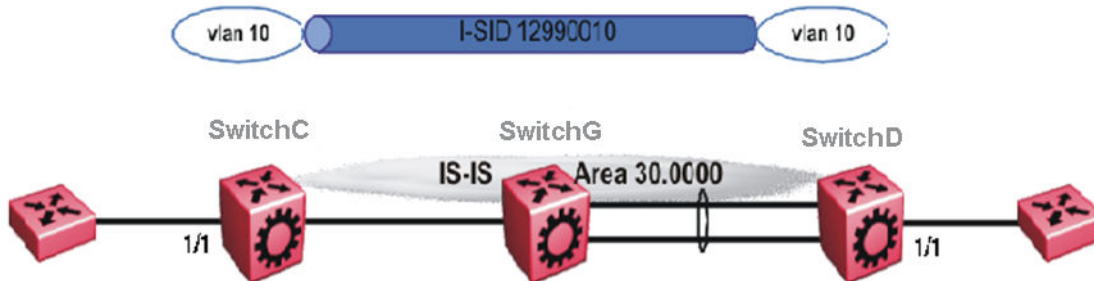

Figure 43: Layer 2 VSN

The following sections show the steps required to configure the Layer 2 VSN parameters in this example. You must first configure basic SPBM and IS-IS infrastructure. For more information, see: [SPBM configuration examples](#) on page 221.

SwitchC

VLAN CONFIGURATION

```
vlan create 10 type port-mstprstp 1
vlan members 10 1/1 portmember
vlan i-sid 10 12990010
```

SwitchD

VLAN CONFIGURATION

```
vlan create 10 type port-mstprstp 1
vlan members 10 1/1 portmember
vlan i-sid 10 12990010
```

Verifying Layer 2 VSN operation

The following sections show how to verify the Layer 2 VSN operation in this example.

SwitchC

```
SwitchC:1# show isis spbm i-sid all
```

```
=====
                        SPBM ISID INFO
=====
ISID   SOURCE NAME   VLAN   SYSID           TYPE           HOST_NAME
-----
12990010 f.30.14       4000   0014.0da0.13df  discover      SwitchD
12990010 f.30.13       4000   0015.e89f.e3df  config        SwitchC
-----
Total number of SPBM ISID entries configured: 1
-----
Total number of SPBM ISID entries discovered: 1
-----
```

Layer 2 VSN configuration

```
-----  
Total number of SPBM ISID entries: 2  
-----
```

```
SwitchC:1# show isis spbm multicast-fib
```

```
=====
                        SPBM MULTICAST FIB ENTRY INFO
=====
MCAST DA          ISID   BVLAN  SYSID                      HOST-NAME  OUTGOING-INTERFACES
-----
f3:30:14:c6:36:3a 12990010 4000   0014.0da0.13df             SwitchD    1/1
f3:30:13:c6:36:3a 12990010 4000   0015.e89f.e3df             SwitchC    1/30,1/1
```

SwitchD

```
SwitchD:1# show isis spbm i-sid all
```

```
=====
                        SPBM ISID INFO
=====
ISID   SOURCE NAME  VLAN  SYSID                      TYPE          HOST_NAME
-----
12990010 f.30.14      4000   0014.0da0.13df             config        SwitchD
12990010 f.30.13      4000   0015.e89f.e3df             discover      SwitchC
```

```
SwitchD:1# show isis spbm multicast-fib
```

```
=====
                        SPBM MULTICAST FIB ENTRY INFO
=====
MCAST DA          ISID   BVLAN  SYSID                      HOST-NAME  OUTGOING-INTERFACES
-----
f3:30:14:c6:36:3a 12990010 4000   0014.0da0.13df             SwitchD    MLT-1,1/1
f3:30:13:c6:36:3a 12990010 4000   0015.e89f.e3df             SwitchC    1/1
```

SwitchC — verifying with CFM

```
SwitchC:1# 12 tracertree 4000 12990010
```

```
Please wait for 12tracertree to complete or press any key to abort
```

```
12tracertree to f3:30:13:c6:36:3a, vlan 4000 i-sid 12990010 nickname f.30.13 hops 64
1  SwitchC          00:15:e8:9f:e3:df -> SwitchG          00:0e:62:25:a3:df
2  SwitchG          00:0e:62:25:a3:df -> SwitchD          00:14:0d:a0:13:df
```

SwitchD — verifying with CFM

```
SwitchD:1# 12 tracertree 4000 12990010
```

```
Please wait for 12tracertree to complete or press any key to abort
```

```
12tracertree to f3:30:14:c6:36:3a, vlan 4000 i-sid 12990010 nickname f.30.14 hops 64
1  SwitchD          00:14:0d:a0:13:df -> SwitchG          00:0e:62:25:a3:df
2  SwitchG          00:0e:62:25:a3:df -> SwitchC          00:15:e8:9f:e3:df
```

SwitchC — verifying FDB

```
SwitchC:1# show vlan mac-address-entry 10
```

```
=====
                        Vlan Fdb
=====
VLAN   STATUS   MAC ADDRESS                INTERFACE    TUNNEL
----
10     learned 00:00:00:00:00:01         Port-1/1    SwitchD
10     learned 00:00:00:00:00:02         Port-1/1    SwitchD

2 out of 4 entries in all fdb(s) displayed.
```



```
SwitchC:1# show vlan remote-mac-table 10
=====
Vlan Remote Mac Table
=====
VLAN STATUS  MAC-ADDRESS          DEST-MAC          BVLAN  DEST-SYSNAME  PORTS
-----
10   learned  00:00:00:00:00:02   00:14:0d:a0:13:df  0014.0da0.13df  SwitchD  1/30
-----
Total number of VLAN Remote MAC entries 1
=====
```

SwitchD — verifying FDB

```
SwitchD:1# show vlan mac-address-entry 10
=====
Vlan Fdb
=====
VLAN  MAC
ID   STATUS  ADDRESS          INTERFACE          TUNNEL
-----
10   learned  00:00:00:00:00:01  Port-1/1          SwitchC
10   learned  00:00:00:00:00:02  Port-1/1          SwitchC

2 out of 4 entries in all fdb(s) displayed.

SwitchD:1# show vlan remote-mac-table 10
=====
Vlan Remote Mac Table
=====
VLAN STATUS  MAC-ADDRESS          DEST-MAC          DEST-SYSID  DEST-SYSNAME  PORTS
-----
10   learned  00:00:00:00:00:01   00:15:e8:9f:e3:df  0015.e89f.e3df  SwitchC  MLT-1
-----
Total number of VLAN Remote MAC entries 1
=====
```

Layer 2 VSN example with VLAN ID translation

The following figure shows a sample Layer 2 VSN deployment where the C- VLAN IDs are different at each end. You must first configure basic SPBM and IS-IS infrastructure. For more information, see [SPBM configuration examples](#) on page 221.

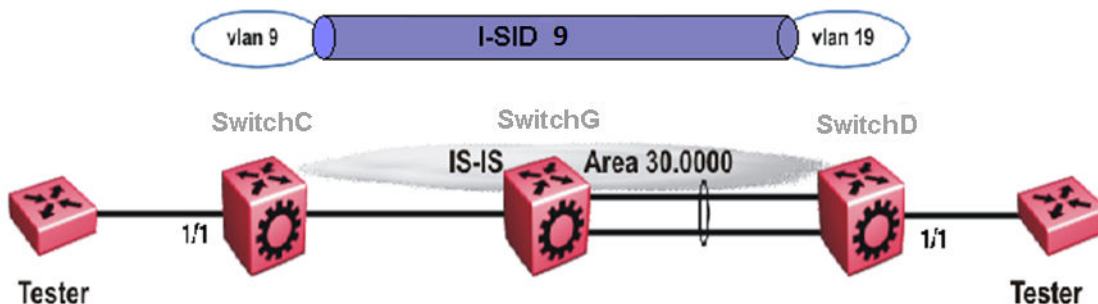

Figure 44: Layer 2 VSN with different VLAN IDs

Layer 2 VSN configuration

The following sections show the steps required to configure the Layer 2 VSN parameters in this example.

SwitchC

VLAN CONFIGURATION

```
vlan create 9 type port 1
vlan members 9 1/1 portmember
vlan i-sid 9 9
```

SwitchD

VLAN CONFIGURATION

```
vlan create 19 type port 1
vlan members 19 1/1 portmember
vlan i-sid 19 9
```

Chapter 6: Inter-VSN routing configuration

This section provides concepts and procedures to configure Inter-Virtual Services Network (VSN) routing.

Inter-VSN routing configuration fundamentals

This section provides fundamental concepts on Inter-VSN Routing.

Inter-VSN routing

Inter-VSN routing with SPBM allows routing between Layer 2 VLANs with different I-SIDs.

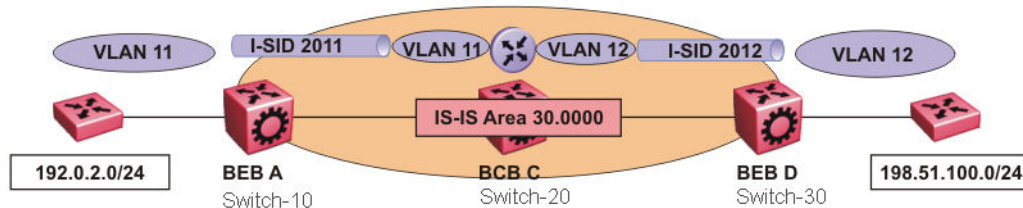

Figure 45: Inter-VSN routing

Inter-VSN routing provides a routing hub for Layer 2 Virtual Services Network edge devices, Layer 3 devices, routers, or hosts connected to the SPBM cloud using the SPBM Layer 2 VSN service. To go between a routed network, a Layer 2 VSN termination point provides the routing services to hop onto another Layer 2 VSN, using I-SID.

*** Note:**

The Layer 2 VLANs must be in the same VRF. You cannot route traffic between two different VRFs with Inter-VSN routing.

In this example, the C-VLANs are associated with I-SIDs on the BEBs using SPBM Layer 2 VSN. With Inter-VSN routing enabled, BCB C can route traffic between VLAN 11 (I-SID 2011) and VLAN 12 (I-SID 2012).

IP interfaces are where the routing instance exists. In this case, on Switch-20.

*** Note:**

The switch does not support IP multicast over Fabric Connect routing on inter-VSN routing interfaces.

Inter-VSN routing configuration using the CLI

This section provides a procedure to configure Inter-VSN routing using the CLI.

Configuring SPBM Inter-VSN Routing

Inter-VSN allows you to route between IP networks on Layer 2 VLANs with different I-SIDs. Inter-VSN routing is typically used only when you have to extend a VLAN as a Layer 2 Virtual Services Network (VSN) for applications such as vMotion. Normally, it is recommended to use IP Shortcuts or Layer 3 VSNs to route traffic. You must configure both the Backbone Edge Bridges (BEBs) and the Backbone Core Bridge (BCB).

*** Note:**

To enable inter-VSN routing, you must configure IP interface where the routing instance exists.

Before you begin

- You must configure the required SPBM and IS-IS infrastructure.

Procedure

1. Enter Global Configuration mode:

```
enable
configure terminal
```

2. Follow the procedures below on the Backbone Edge Bridges (BEBs) containing the VSNs you want to route traffic between.

- a. Create a customer VLAN (C-VLAN) by port:

```
vlan create <2-4059> type port-mstprstp <0-63>
```

- b. Add ports in the C-VLAN:

```
vlan members add <1-4059> {slot/port[/sub-port] [-slot/port[/sub-port]] [, ...]}
```

- c. Map a customer VLAN (C-VLAN) to a Service Instance Identifier (I-SID):

```
vlan i-sid <1-4059> <0-16777215>
```

! Important:

When a protocol VLAN is created, all ports are added to the VLAN including SPBM ports. To configure a protocol-based VLAN as a C-VLAN, you must first remove the SPBM-enabled ports from the protocol based VLAN, and then configure the protocol-based VLAN as a C-VLAN.

3. On the Backbone Core Bridge (BCB), create a VRF and add a VLAN for each VSN:

a. Create a VRF:

```
ip vrf WORD<1-16> vrfid <1-511>
```

b. Create a VLAN to associate with each VSN:

```
vlan create <2-4059> type port-mstprstp <0-63>
```

c. Enter VLAN Interface Configuration mode:

```
interface vlan <1-4059>
```

d. Add a VLAN to the VRF you created in step a:

```
vrf WORD<1-16>
```

e. Associate an I-SID with the VLAN:

```
vlan i-sid <1-4059> <0-16777215>
```

! Important:

When a protocol VLAN is created, all ports are added to the VLAN including SPBM ports. To configure a protocol-based VLAN as a C-VLAN, you must first remove the SPBM-enabled ports from the protocol based VLAN, and then configure the protocol-based VLAN as a C-VLAN.

The switch reserves I-SID 0x00ffffff. The switch uses this I-SID to advertise the virtual B-MAC in a SMLT dual-homing environment. The platform clears the receive and transmit bit of this I-SID, therefore I-SID 0x00ffffff cannot be used for any other service.

f. Configure an IP address for the VLAN:

```
ip address {A.B.C.D/X}
```

g. Repeat steps b to f for every VLAN you want to route traffic between.

Variable definitions

Use the data in the following table to use the `vlan create` command.

Variable	Value
<2-4059>	Specifies the VLAN ID in the range of 2 to 4059. VLAN ID 1 is the default VLAN and you cannot create or delete VLAN ID 1. By default, the system reserves VLAN IDs 4060 to 4094 for internal

Table continues...

Variable	Value
	use. On switches that support the vrf-scaling and spbm-config-mode boot configuration flags, if you enable these flags, the system also reserves VLAN IDs 3500 to 3998.
type port-mstprstp <0-63> [color <0-32>]	Creates a VLAN by port: <ul style="list-style-type: none"> • <0-63> is the STP instance ID. • color <0-32> is the color of the VLAN.

Use the data in the following table to use the `vlan members add` command.

Variable	Value
<1-4059>	Specifies the VLAN ID in the range of 1 to 4059. By default, VLAN IDs 1 to 4059 are configurable and the system reserves VLAN IDs 4060 to 4094 for internal use. On switches that support the vrf-scaling and spbm-config-mode boot configuration flags, if you enable these flags, the system also reserves VLAN IDs 3500 to 3998. VLAN ID 1 is the default VLAN and you cannot create or delete VLAN ID 1.
{slot/port[/sub-port] [-slot/port[/sub-port]] [,...]}	Identifies the slot and port in one of the following formats: a single slot and port (slot/port), a range of slots and ports (slot/port-slot/port), or a series of slots and ports (slot/port,slot/port,slot/port). If your platform supports channelization and the port is channelized, you must also specify the sub-port in the format slot/port/sub-port.

Use the data in the following table to use the `vlan i-sid` command.

Variable	Value
vlan i-sid <1-4059> <0-16777215>	Specifies the customer VLAN (C-VLAN) to associate with the I-SID. Use the no or default options to remove the I-SID from the specified VLAN.

Use the data in the following table to use the `ip vrf` command.

Variable	Value
WORD <1-16>	Create the VRF and specify the name of the VRF instance.
vrfid <1-511>	Specifies the VRF instance by number.

Use the data in the following table to use the `vrf` command.

Variable	Value
WORD <1-16>	Specifies the VRF name. Associates a port to a VRF.

Use the data in the following table to use the `ip address` command.

Variable	Value
{A.B.C.D/X}	Configure an IP address for the VLAN.

Inter-VSN routing configuration using EDM

This section provides procedures to configure Inter-VSN routing using Enterprise Device Manager (EDM).

Configuring BEBs for Inter-VSN routing

Inter-VSN allows you to route between IP networks on Layer 2 VLANs with different I-SIDs. Inter-VSN routing is typically used only when you have to extend a VLAN as a Layer 2 Virtual Services Network (VSN) for applications such as vMotion. Use IP Shortcuts or Layer 3 VSNs to route traffic. You must configure both the Backbone Edge Bridges (BEBs) and the Backbone Core Bridge (BCB).

* Note:

To enable inter-VSN routing, you must configure the IP interface where the routing instance exists.

Before you begin

- You must configure the required SPBM and IS-IS infrastructure.

About this task

Follow the procedures below on the Backbone Edge Bridges (BEBs) that contain the VSNs you want to route traffic between.

Procedure

- Create a customer VLAN (C-VLAN) by port and add ports in the C-VLAN. In the navigation pane, expand the **Configuration > VLAN** folders.
- Click **VLANs**.
- In the **Basic** tab, click **Insert**.
- In the **Id** box, enter an unused VLAN ID, or use the ID provided.
- In the **Name** box, type the VLAN name, or use the name provided.
- In the **Color Identifier** box, click the down arrow and choose a color from the list, or use the color provided.
- In the **Type** box, select **byPort**.
- In the **PortMembers** box, click the (...) button.

9. Click on the ports to add as member ports.

The ports that are selected are recessed, while the nonselected ports are not recessed. Port numbers that appear dimmed cannot be selected as VLAN port members.

10. Click **OK**.

11. Click **Insert**.

12. Collapse the **VLANs** tab.

The VLAN is added to the Basic tab.

13. Map a C-VLAN to an I-SID. In the navigation pane, expand the **Configuration > VLAN** folders.

14. Click **VLANs**.

15. Click the **Advanced** tab.

16. To map a C-VLAN to an I-SID, in the **I-sid** field, specify the I-SID to associate with the specified VLAN.

The switch reserves I-SID 0x00ffffff. The switch uses this I-SID to advertise the virtual B-MAC in a SMLT dual-homing environment. The platform clears the receive and transmit bit of this I-SID, therefore I-SID 0x00ffffff cannot be used for any other service.

17. Click **Apply**.

 **Important:**

When a protocol VLAN is created, all ports are added to the VLAN including SPBM ports. To configure a protocol-based VLAN as a C-VLAN, you must first remove the SPBM-enabled ports from the protocol based VLAN, and then configure the protocol-based VLAN as a C-VLAN.

18. Configure the Backbone Core Bridge (BCB) for Inter-VSN Routing. For more information, see [Configuring BCBs for Inter-VSN routing](#) on page 315.

Advanced field descriptions



Use the data in the following table to use the Advanced tab.

Name	Description
Id	Specifies the VLAN ID in the range of 1 to 4059. By default, VLAN IDs 1 to 4059 are configurable and the system reserves VLAN IDs 4060 to 4094 for internal use. On switches that support the vrf-scaling and spbm-config-mode boot configuration flags, if you enable these flags, the system also reserves VLAN IDs 3500 to 3998. VLAN ID 1 is the default VLAN and you cannot create or delete VLAN ID 1.
Name	Specifies the name of the VLAN.

Table continues...

Name	Description
Ifindex	Specifies the logical interface index assigned to the VLAN.
Type	Specifies the type of VLAN: <ul style="list-style-type: none"> • byPort • byProtocolId • spbm-bvlan • private
I-sid	Specifies the I-SID number assigned to a customer VLAN (C-VLAN). The range is 0 – 16777215. The default value is 0, which indicates that no I-SID is assigned.
ProtocolId	Specifies the network protocol for protocol-based VLANs. If the VLAN type is not protocol-based, None is displayed in the Basic tab ProtocolId field.
AgingTime	Specifies the timeout period for dynamic VLAN membership. A potential VLAN port is made ACTIVE after it receives a packet that matches the VLAN; if no such packet is received for AgingTime seconds, the port is no longer active. The default is 600.
MacAddress	Specifies the MAC address assigned to the virtual router interface for this VLAN. This field is relevant only after the VLAN is configured for routing. This MAC address is used as the Source MAC in routed frames and ARP replies.
Vlan Operation Action	Performs an operation on the VLAN. The values are: <ul style="list-style-type: none"> • none • flushMacFdb: Configures action to flushMacFdb. This action removes the learned MAC addresses from the forwarding database for the selected VLAN. • flushArp: Configures action to flushArp. This action removes the ARP entries from the address table for the selected VLAN. • flushIp: Configures action to flushIp. This action removes the learned IP addresses from the forwarding table for the selected VLAN. • flushDynMemb: Configures action to flushDynMemb. This action removes port members not configured as static from the list of active port members of a policy-based VLAN and removes MAC addresses learned on those ports.

Table continues...

Name	Description
	<ul style="list-style-type: none"> all: Configures action to all. This action performs all the supported actions; it does not perform the Snoop-related actions. <p>The default is none.</p>
Result	Specifies the result code after you perform an action.
NlbMode	Enables or disables Microsoft Network Load Balancing (NLB) operations on the VLAN. The default is disabled.
SpbMulticast	Enables or disables Multicast over Fabric Connect. The default is disabled.
SpbPimGatewayMulticast	Enables or disables SPB-PIM Gateway Multicast on a VLAN. The default is disabled.
RmonEnable	Enables or disables Remote Monitoring (RMON) on the interface. The default is disabled.
Ipv6FhsSnoopDhcpEnable	Enables or disables IPv6 dhcp snooping on a VLAN. The default is disabled.
Ipv6FhsNDInspectionEnable	Enables or disables neighbor discovery (ND) inspection on a VLAN. The default is disabled.
DvrEnable	<p>Enables or disables DvR on a VLAN that is configured on the DvR Controller. The default is disabled.</p> <p> Note:</p> <p>You must enable DvR on every VLAN that is configured on a DvR Controller.</p>
DvrGwIpv4Addr	<p>Specifies the DvR gateway IPv4 address for a VLAN.</p> <p> Important:</p> <p>Ensure that you configure the same gateway IPv4 address on all Controllers in the DvR domain that belong to a VLAN.</p>

Basic field descriptions

Use the data in the following table to use the Basic tab.

Name	Description
Id	Specifies the VLAN ID in the range of 2 to 4059. VLAN ID 1 is the default VLAN and you cannot create or delete VLAN ID 1. By default, the system reserves VLAN IDs 4060 to 4094 for internal use. On switches that support the vrf-scaling and spbm-config-mode boot configuration flags, if you enable these flags, the system also reserves VLAN IDs 3500 to 3998.
Name	Specifies the name of the VLAN.

Table continues...

Name	Description
IfIndex	Specifies the logical interface index assigned to the VLAN.
Color Identifier	Specifies a proprietary color scheme to associate a color with the VLAN. Color does not affect how frames are forwarded.
Type	Specifies the type of VLAN: <ul style="list-style-type: none"> • byPort • byProtocolId • spbm-bvlan • private
MstpInstance	Identifies the MSTP instance.
VrfId	Indicates the Virtual Router to which the VLAN belongs.
VrfName	Indicates the name of the Virtual Router to which the VLAN belongs.
PortMembers	Specifies the slot/port of each VLAN member. The sub-port only appears for channelized ports.
ActiveMembers	Specifies the slot/port of each VLAN member. The sub-port only appears for channelized ports.
StaticMembers	Specifies the slot/port of each static member of a policy-based VLAN. The sub-port only appears for channelized ports.
NotAllowToJoin	Specifies the slot/ports that are never allowed to become a member of the policy-based VLAN. The sub-port only appears for channelized ports.
ProtocolId	Specifies the network protocol for protocol-based VLANs. This value is taken from the Assigned Numbers of remote function call (RFC). If the VLAN type is port-based, none is displayed in the Basic tab ProtocolId field.

*** Note:**

If you or another user changes the name of an existing VLAN using the VLAN **Basic** tab (or using CLI), the new name does not initially appear in EDM. To display the updated name, perform one of the following actions:

- Refresh your browser to reload EDM.
- Log out of EDM and log in again to restart EDM.
- Click **Refresh** in the VLAN **Basic** tab toolbar. If the old VLAN name appears in other tabs, click **Refresh** on those tabs as well.

Configuring BCBs for Inter-VSN routing

Inter-VSN allows you to route between IP networks on Layer 2 VLANs with different I-SIDs. Inter-VSN routing is typically used only when you have to extend a VLAN as a Layer 2 Virtual Services Network (VSN) for applications such as vMotion. Use IP Shortcuts to route traffic. You must configure both the Backbone Edge Bridges (BEBs) and the Backbone Core Bridge (BCB).

*** Note:**

To enable inter-VSN routing, you must configure the IP interface where the routing instance exists.

Before you begin

- You must configure the required SPBM and IS-IS infrastructure.
- You must configure the Backbone Edge Bridges (BEBs) containing the VSNs you want to route traffic between. For more information, see [Configuring BEBs for Inter-VSN routing](#) on page 311.

About this task

Follow the procedures below to configure the Backbone Core Bridge (BCB) for inter-VSN routing.

Procedure

1. On the Backbone Core Bridge (BCB), create a VRF. In the navigation pane, expand the **Configuration > IP** folders.
2. Click **VRF**.
3. Click **Insert**.
4. Specify the VRF ID.
5. Name the VRF instance.
6. Configure the other parameters as required.
7. Click **Insert**.
8. Create a VLAN to associate with each VSN. In the navigation pane, expand the **Configuration > VLAN** folders.
9. Click **VLANs**.
10. In the **Basic** tab, click **Insert**.
11. In the **Id** box, enter an unused VLAN ID, or use the ID provided.
12. In the **Name** box, type the VLAN name, or use the name provided.
13. In the **Color Identifier** box, click the down arrow and choose a color from the list, or use the color provided.
14. In the **Type** box, select **byPort**.
15. In the **PortMembers** box, click the (...) button.
16. Click on the ports to add as member ports.

The ports that are selected are recessed, while the nonselected ports are not recessed. Port numbers that appear dimmed cannot be selected as VLAN port members.
17. Click **OK**.
18. Click **Insert**.

19. Collapse the **VLANs** tab.
The VLAN is added to the **Basic** tab.
20. Associate the VLAN with an I-SID. In the navigation pane, expand the **Configuration > VLAN** folders.
21. Click **VLANs**.
22. In the VLANs tab, click the **Advanced** tab.
23. In the **I-sid** box, specify the I-SID to associate with the VLAN.
24. Click **Apply**.
25. Configure a circuitless IP interface (CLIP). In the navigation pane, expand the **Configuration > IP** folders.
26. Click **IP**.
27. Click the **Circuitless IP** tab.
28. Click **Insert**.
29. In the **Interface** field, assign a CLIP interface number.
30. Enter the IP address.
31. Enter the network mask.
32. Click **Insert**.

VRF field descriptions

Use the data in the following table to help you use the **VRF** tab.

Name	Description
Id	Specifies the ID number of the VRF instance. VRF ID 0 is reserved for the GlobalRouter.
Name	Names the VRF instance.
ContextName	Identifies the VRF. The SNMPv2 Community String or SNMPv3 contextName denotes the VRF context and is used to logically separate the MIB module management.
TrapEnable	Enables the VRF to send VRF Lite-related traps (VrfUp and VrfDown). The default is true.
MaxRoutes	Configures the maximum number of routes allowed for the VRF. The maximum value varies per platform so refer to the <i>Release Notes</i> for platform-specific scaling information. The default value is 10000.
MaxRoutesTrapEnable	Enables the generation of the VRF Max Routes Exceeded traps. The default is true.

Advanced field descriptions

Use the data in the following table to use the **Advanced** tab.

Name	Description
Id	Specifies the VLAN ID in the range of 1 to 4059. By default, VLAN IDs 1 to 4059 are configurable and the system reserves VLAN IDs 4060 to 4094 for internal use. On switches that support the vrf-scaling and spbm-config-mode boot configuration flags, if you enable these flags, the system also reserves VLAN IDs 3500 to 3998. VLAN ID 1 is the default VLAN and you cannot create or delete VLAN ID 1.
Name	Specifies the name of the VLAN.
IfIndex	Specifies the logical interface index assigned to the VLAN.
Type	Specifies the type of VLAN: <ul style="list-style-type: none"> • byPort • byProtocolId • spbm-bvlan • private
I-sid	Specifies the I-SID number assigned to a customer VLAN (C-VLAN). The range is 0 – 16777215. The default value is 0, which indicates that no I-SID is assigned.
ProtocolId	Specifies the network protocol for protocol-based VLANs. If the VLAN type is not protocol-based, None is displayed in the Basic tab ProtocolId field.
AgingTime	Specifies the timeout period for dynamic VLAN membership. A potential VLAN port is made ACTIVE after it receives a packet that matches the VLAN; if no such packet is received for AgingTime seconds, the port is no longer active. The default is 600.
MacAddress	Specifies the MAC address assigned to the virtual router interface for this VLAN. This field is relevant only after the VLAN is configured for routing. This MAC address is used as the Source MAC in routed frames and ARP replies.
Vlan Operation Action	Performs an operation on the VLAN. The values are: <ul style="list-style-type: none"> • none • flushMacFdb: Configures action to flushMacFdb. This action removes the learned MAC addresses

Table continues...



Name	Description
	<p>from the forwarding database for the selected VLAN.</p> <ul style="list-style-type: none"> • flushArp: Configures action to flushArp. This action removes the ARP entries from the address table for the selected VLAN. • flushIp: Configures action to flushIp. This action removes the learned IP addresses from the forwarding table for the selected VLAN. • flushDynMemb: Configures action to flushDynMemb. This action removes port members not configured as static from the list of active port members of a policy-based VLAN and removes MAC addresses learned on those ports. • all: Configures action to all. This action performs all the supported actions; it does not perform the Snoop-related actions. <p>The default is none.</p>
Result	Specifies the result code after you perform an action.
NlbMode	Enables or disables Microsoft Network Load Balancing (NLB) operations on the VLAN. The default is disabled.
SpbMulticast	Enables or disables Multicast over Fabric Connect. The default is disabled.
SpbPimGatewayMulticast	Enables or disables SPB-PIM Gateway Multicast on a VLAN. The default is disabled.
RmonEnable	Enables or disables Remote Monitoring (RMON) on the interface. The default is disabled.
Ipv6FhsSnoopDhcpEnable	Enables or disables IPv6 dhcp snooping on a VLAN. The default is disabled.
Ipv6FhsNDInspectionEnable	Enables or disables neighbor discovery (ND) inspection on a VLAN. The default is disabled.
DvrEnable	<p>Enables or disables DvR on a VLAN that is configured on the DvR Controller. The default is disabled.</p> <p> Note:</p> <p>You must enable DvR on every VLAN that is configured on a DvR Controller.</p>
DvrGwIpv4Addr	Specifies the DvR gateway IPv4 address for a VLAN.

Table continues...

Name	Description
	 Important: Ensure that you configure the same gateway IPv4 address on all Controllers in the DvR domain that belong to a VLAN.

Circuitless IP field descriptions

Use the data in the following table to use the **Circuitless IP** tab.

Name	Description
Interface	Specifies the number assigned to the interface, from 1 to 256.
Ip Address	Specifies the IP address of the CLIP.
Net Mask	Specifies the network mask.

Basic field descriptions

Use the data in the following table to use the Basic tab.

Name	Description
Id	Specifies the VLAN ID in the range of 2 to 4059. VLAN ID 1 is the default VLAN and you cannot create or delete VLAN ID 1. By default, the system reserves VLAN IDs 4060 to 4094 for internal use. On switches that support the vrf-scaling and spbm-config-mode boot configuration flags, if you enable these flags, the system also reserves VLAN IDs 3500 to 3998.
Name	Specifies the name of the VLAN.
IfIndex	Specifies the logical interface index assigned to the VLAN.
Color Identifier	Specifies a proprietary color scheme to associate a color with the VLAN. Color does not affect how frames are forwarded.
Type	Specifies the type of VLAN: <ul style="list-style-type: none"> • byPort • byProtocolId • spbm-bvlan • private
MstpInstance	Identifies the MSTP instance.
VrfId	Indicates the Virtual Router to which the VLAN belongs.
VrfName	Indicates the name of the Virtual Router to which the VLAN belongs.
PortMembers	Specifies the slot/port of each VLAN member. The sub-port only appears for channelized ports.
ActiveMembers	Specifies the slot/port of each VLAN member. The sub-port only appears for channelized ports.

Table continues...

Name	Description
StaticMembers	Specifies the slot/port of each static member of a policy-based VLAN. The sub-port only appears for channelized ports.
NotAllowToJoin	Specifies the slot/ports that are never allowed to become a member of the policy-based VLAN. The sub-port only appears for channelized ports.
ProtocolId	Specifies the network protocol for protocol-based VLANs. This value is taken from the Assigned Numbers of remote function call (RFC). If the VLAN type is port-based, none is displayed in the Basic tab ProtocolId field.

*** Note:**

If you or another user changes the name of an existing VLAN using the VLAN **Basic** tab (or using CLI), the new name does not initially appear in EDM. To display the updated name, perform one of the following actions:

- Refresh your browser to reload EDM.
- Log out of EDM and log in again to restart EDM.
- Click **Refresh** in the VLAN **Basic** tab toolbar. If the old VLAN name appears in other tabs, click **Refresh** on those tabs as well.

Inter-VSN routing configuration example

This section provides a configuration example for Inter-VSN routing.

Examples and network illustrations in this document may illustrate only one of the supported platforms. Unless otherwise noted, the concept illustrated applies to all supported platforms.

Inter-VSN routing with SPBM configuration example

The following figure shows a sample Inter-VSN deployment.

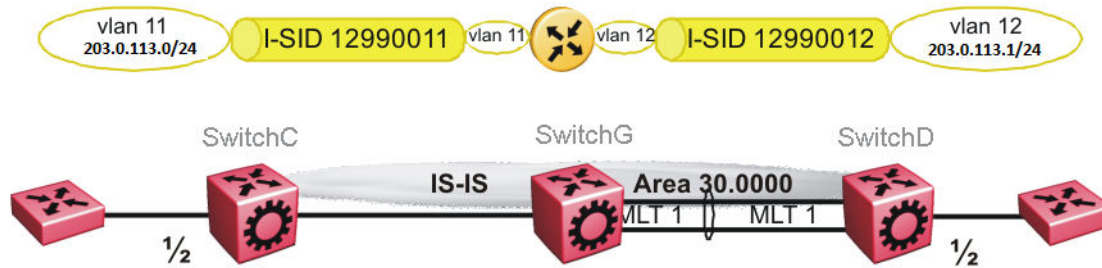

Figure 46: Inter-VSN routing configuration

The following sections show the steps required to configure the Inter-VSN parameters in this example. You must first configure basic SPBM and IS-IS infrastructure. For more information, see: [SPBM configuration examples](#) on page 221.

Note that the IP interfaces are configured where the routing instance exists, namely, on SwitchG.

SwitchC

```
VLAN CONFIGURATION
vlan create 11 type port-mstprstp 1
vlan members 11 1/2 portmember
vlan i-sid 11 12990011
```

SwitchG

```
VRF CONFIGURATION
ip vrf blue vrfid 100

VLAN CONFIGURATION
vlan create 11 type port-mstprstp 1
vlan i-sid 11 12990011
interface Vlan 11
vrf blue
ip address 203.0.113.2 255.255.255.0
exit

VLAN CONFIGURATION
vlan create 12 type port-mstprstp 1
vlan i-sid 12 12990012
interface Vlan 12
vrf blue
ip address 203.0.113.3 255.255.255.0
exit
```

SwitchD

```
VLAN CONFIGURATION
vlan create 12 type port-mstprstp 1
```

```
vlan members 12 1/2 portmember
vlan i-sid 12 12990012
```

Verifying Inter-VSN Routing operation

The following sections show how to verify Inter-VSN Routing operation in this example.

SwitchG

```
SwitchG:1# show ip route vrf blue
```

```
=====
                          IP Route - VRF blue
=====
DST                MASK                NEXT                NH          INTER
VRF                COST  FACE  PROT  AGE  TYPE  PRF
-----
203.0.113.0        255.255.255.0    203.0.113.2        -           1      11      LOC  0   DB   0
203.0.113.1        255.255.255.0    203.0.113.3        -           1      12      LOC  0   DB   0
```

```
SwitchG:1# show ip arp vrf blue
```

```
=====
                          IP Arp - VRF blue
=====
IP_ADDRESS          MAC_ADDRESS          VLAN    PORT    TYPE    TTL(10 Sec)    TUNNEL
-----
203.0.113.2         00:0e:62:25:a2:00    11      -       LOCAL   2160
203.0.113.255      ff:ff:ff:ff:ff:ff    11      -       LOCAL   2160
203.0.113.3         00:0e:62:25:a2:01    12      -       LOCAL   2160
203.0.113.255      ff:ff:ff:ff:ff:ff    12      -       LOCAL   2160
```

```
=====
                          IP Arp Extn - VRF blue
=====
MULTICAST-MAC-FLOODING  AGING(Minutes)  ARP-THRESHOLD
-----
disable                  360              500
```

```
4 out of 50 ARP entries displayed
```

SwitchG

```
SwitchG:1# show vlan mac-address-entry 11
```

```
=====
                          Vlan Fdb
=====
VLAN  STATUS  MAC ADDRESS          INTERFACE          TUNNEL
ID   ID      ADDRESS
-----
11   learned 00:00:00:00:01:02  Port-1/2          SwitchC
11   self    00:0e:62:25:a2:00  Port-cpp          -
```

```
2 out of 4 entries in all fdb(s) displayed.
```

```
SwitchG:1# show vlan mac-address-entry 12
```

```
=====
                          Vlan Fdb
=====
VLAN  STATUS  MAC ADDRESS          INTERFACE          TUNNEL
ID   ID      ADDRESS
-----
12   learned 00:00:00:00:02:02  Port-1/2          SwitchD
12   self    00:0e:62:25:a2:01  Port-cpp          -
```

Inter-VSN routing configuration

2 out of 4 entries in all fdb(s) displayed.

SwitchC

```
SwitchC:1# show vlan mac-address-entry 11
```

```
=====
                        Vlan Fdb
=====
VLAN      MAC
ID  STATUS ADDRESS          INTERFACE          TUNNEL
-----
11   learned 00:00:00:00:01:02  Port-1/2          SwitchD
11   learned 00:0e:62:25:a2:00  Port-1/2          SwitchD
=====
```

2 out of 2 entries in all fdb(s) displayed.

SwitchD

```
SwitchD:1# show vlan mac-address-entry 12
```

```
=====
                        Vlan Fdb
=====
VLAN      MAC
ID  STATUS ADDRESS          INTERFACE          TUNNEL
-----
12   learned 00:00:00:00:02:02  Port-1/2          SwitchC
12   learned 00:0e:62:25:a2:01  Port-1/2          SwitchC
=====
```

2 out of 2 entries in all fdb(s) displayed.

Appendix A: SPBM reference architectures

Reference architectures

SPBM has a straightforward architecture that simply forwards encapsulated C-MACs across the backbone. Because the B-MAC header stays the same across the network, there is no need to swap a label or perform a route lookup at each node. This architecture allows the frame to follow the most efficient forwarding path from end to end.

The following reference architectures illustrate SPBM with multiple switches in a network.

For information about solution-specific architectures like Video Surveillance or Data Center implementation using the VSP switch, see [Solution-specific reference architectures](#) on page 334.

The following figure shows the MAC-in-MAC SPBM domain with BEBs on the boundary and BCBs in the core.

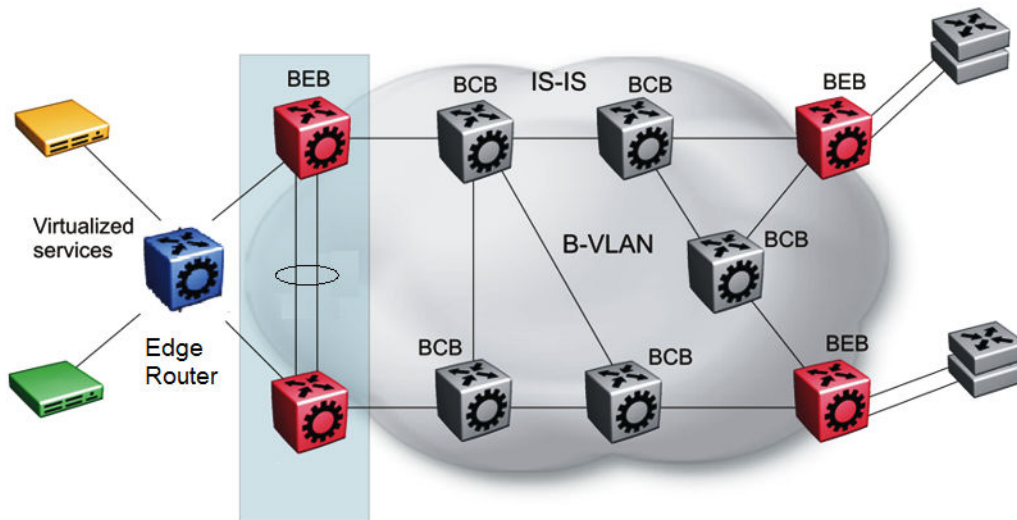

Figure 47: SPBM basic architecture

Provisioning an SPBM core is as simple as enabling SPBM and IS-IS globally on all the nodes and on the core facing links. To migrate an existing edge configuration into an SPBM network is just as simple.

The boundary between the MAC-in-MAC SPBM domain and the 802.1Q domain is handled by the BEBs. At the BEBs, VLANs or VRFs are mapped into I-SIDs based on the local service provisioning.

Services (whether Layer 2 or Layer 3 VSNs) only need to be configured at the edge of the SPBM backbone (on the BEBs). There is no provisioning needed on the core SPBM nodes.

The following figure illustrates an existing edge that connects to an SPBM core.

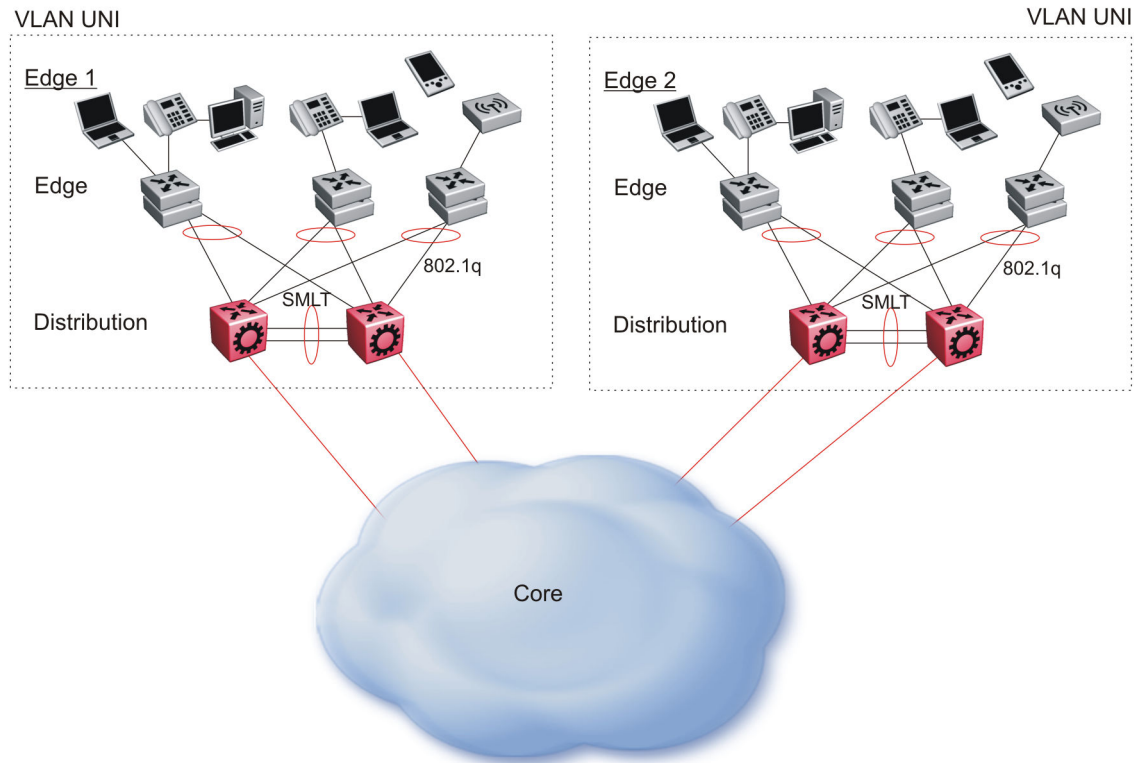

Figure 48: Access to the SPBM Core

For Layer 2 virtualized bridging (Layer 2 VSN), identify all the VLANs that you want to migrate into SPBM and assign them to an I-SID on the BEB.

For Layer 3 virtualized routing (Layer 3 VSN), map IPv4-enabled VLANs to VRFs, create an IP VPN instance on the VRF, assign an I-SID to the VRF, and then configure the desired IP redistribution of IP routes into IS-IS.

All BEBs that have the same I-SID configured can participate in the same VSN. That completes the configuration part of the migration and all the traffic flows return to normal operation.

Campus architecture

For migration purposes, you can add SPBM to an existing network that has SMLT configured. In fact, if there are other protocols already running in the network, such as Open Shortest Path First (OSPF), you can leave them in place too. SPBM uses IS-IS, and operates independently from other protocols. However, it is recommended that you eventually eliminate SMLT in the core and eliminate other unnecessary protocols. This reduces the complexity of the network and makes it much simpler to maintain and troubleshoot.

Whether you configure SMLT in the core, the main point to remember is that SPBM separates services from the infrastructure. For example, in a large campus, a user may need access to other

sites or data centers. With SPBM you can grant that access by associating the user to a specific I-SID. With this mechanism, the user can work without getting access to confidential information of another department.

The following figure depicts a topology where the BEBs in the edge and data center distribution nodes are configured in SMLT clusters. Prior to implementing SPBM, the core nodes would also have been configured as SMLT clusters. When migrating SPBM onto this network design, it is important to note that you can deploy SPBM over the existing SMLT topology without network interruption. After the SPBM infrastructure is in place, you can create VSN services over SPBM or migrate them from the previous end-to-end SMLT-based design.

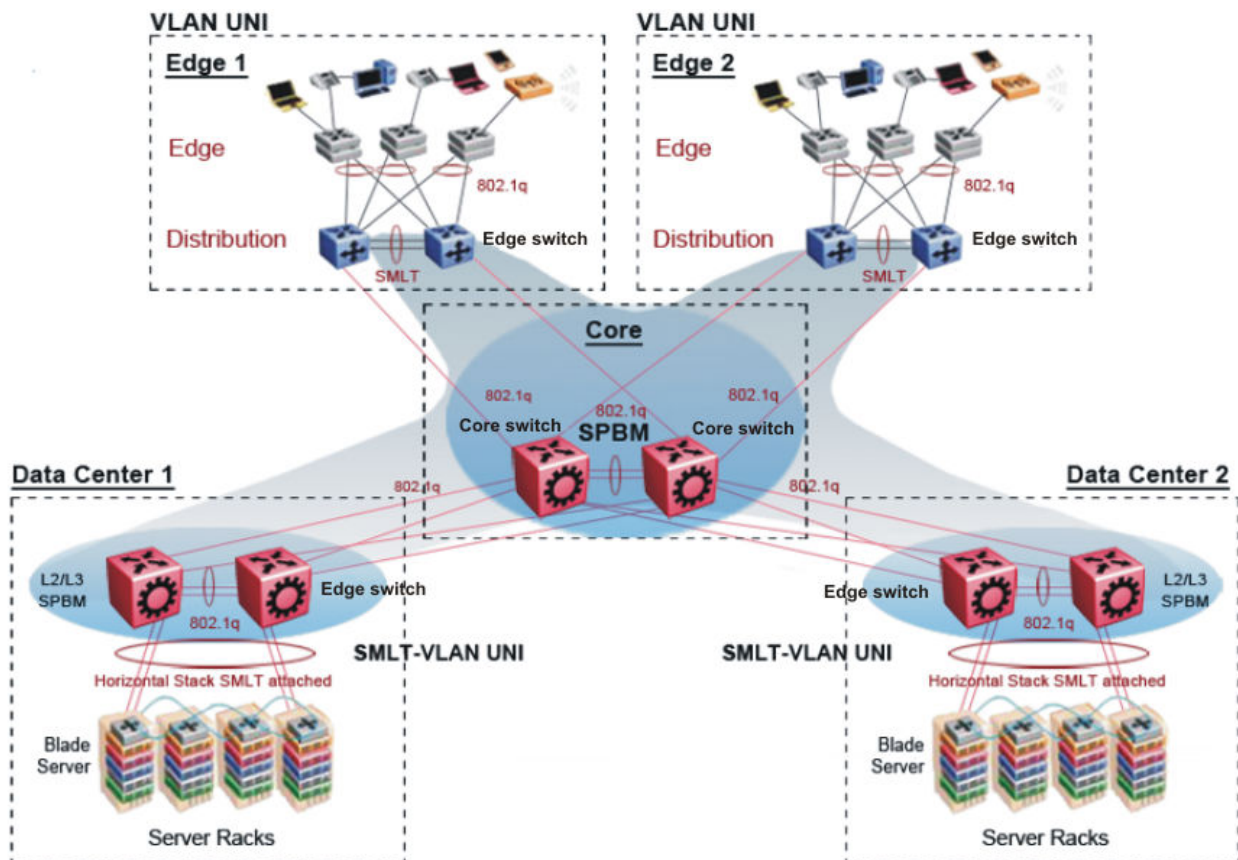

Figure 49: SPBM campus without SMLT

After you migrate all services to SPBM, the customer VLANs (C-VLANs) will exist only on the BEB SMLT clusters at the edge of the SPBM network. The C-VLANs will be assigned to an I-SID instance and then associated with either a VLAN in an Layer 2 VSN or terminated into a VRF in an Layer 3 VSN. You can also terminate the C-VLAN into the default router, which uses IP shortcuts to IP route over the SPBM core.

In an SPBM network design, the only nodes where it makes sense to have an SMLT cluster configuration is on the BEB nodes where VSN services terminate. These are the SPBM nodes where C-VLANs exist and these C-VLANs need to be redundantly extended to non-SPBM devices such as Layer 2 edge stackable switches. On the BCB core nodes where no VSNs are terminated and no Layer 2 edge stackables are connected, there is no longer any use for the SMLT clustering functionality. Therefore, in the depicted SPBM design, the SMLT/vIST configuration can be removed

from the core nodes because they now act as pure BCBs that simply transport VSN traffic and the only control plane protocol they need to run is IS-IS.

Because SMLT BEB nodes exist in this design (the edge BEBs) and it is desirable to use equal cost paths to load balance VSN traffic across the SPBM core, all SPBM nodes in the network are configured with the same two B-VIDs.

Where the above figure shows the physical topology, the following two figures illustrate a logical rendition of the same topology. In both of the following figures, you can see that the core is almost identical. Because the SPBM core just serves as a transport mechanism that transmits traffic to the destination BEB, all the provisioning is performed at the edge.

In the data center, VLANs are attached to Inter-VSNs that transmit the traffic across the SPBM core between the data center on the left and the data center on the right. A common application of this service is VMotion moving VMs from one data center to another.

The following figure uses IP shortcuts that route VLANs. There is no I-SID configuration and no Layer 3 virtualization between the edge distribution and the core. This is normal IP forwarding to the BEB.

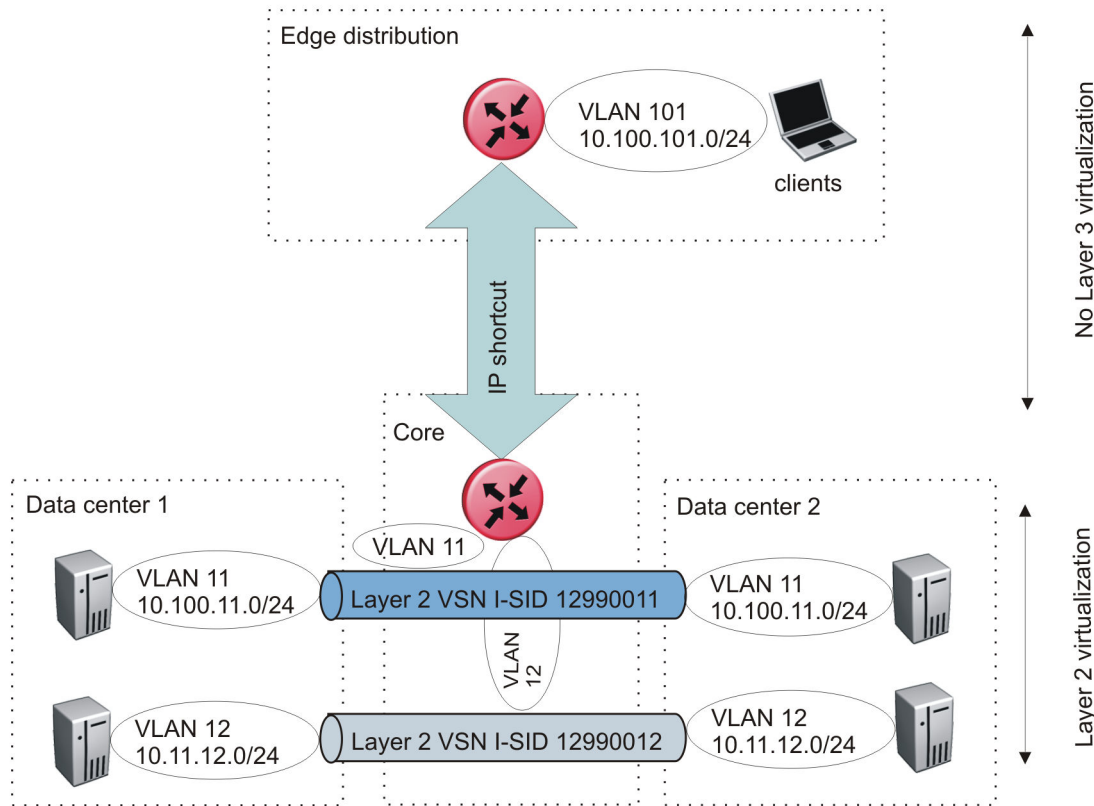

Figure 50: IP shortcut scenario to move traffic between data centers

The following figure uses Layer 3 VSNs to route VRFs between the edge distribution and the core. The VRFs are attached to I-SIDs and use Layer 3 virtualization.

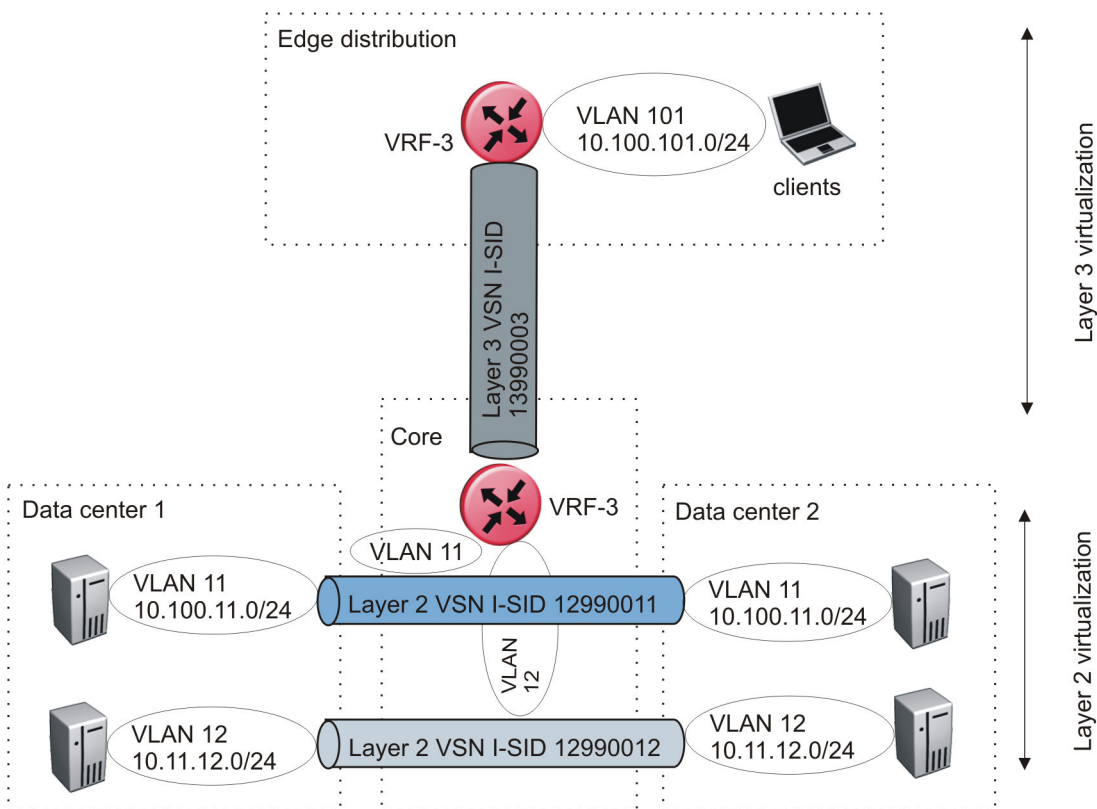

Figure 51: VRF scenario to move traffic between data centers

Large data center architecture

SPBM supports data centers with IP shortcuts, Layer 2 VSNs, or Layer 3 VSNs. If you use vMotion, you must use Layer 2 between data centers (Layer 2 VSN). With Layer 2 VSNs, you can add IP addresses to the VLAN on both data centers and run Virtual Router Redundancy Protocol (VRRP) between them to allow the ESX server to route to the rest of the network.

The following figure shows an SPBM topology of a large data center. This figure represents a full-mesh data center fabric using SPBM for storage over Ethernet. This topology is optimized for storage transport because traffic never travels more than two hops.

* Note:

It is recommended that you use a two-tier, full-mesh topology for large data centers.

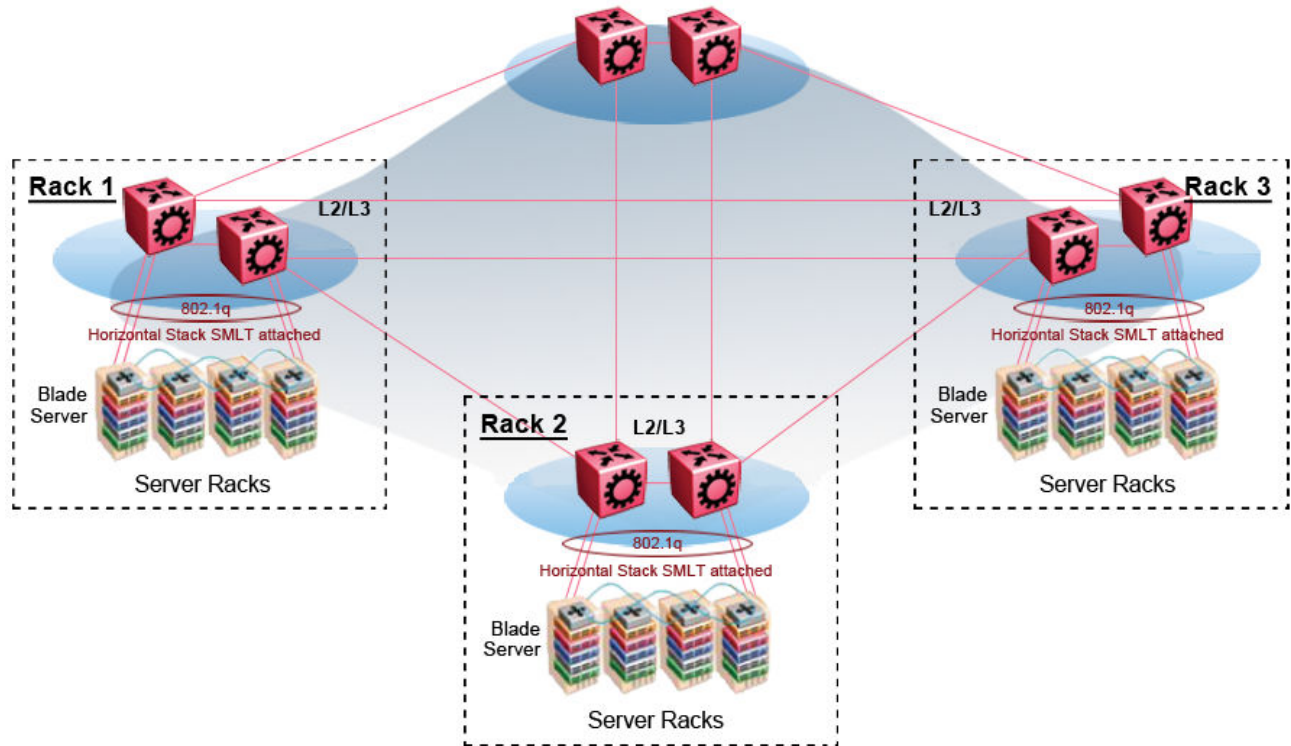

Figure 52: SPBM data center—full mesh

Traditional data center routing of VMs:

In a traditional data center configuration, the traffic flows into the network to a VM and out of the network in almost a direct path.

The following figure shows an example of a traditional data center with VRRP configured. Because end stations are often configured with a static default gateway IP address, a loss of the default gateway router causes a loss of connectivity to the remote networks. VRRP eliminates the single point of failure that can occur when the single static default gateway router for an end station is lost.

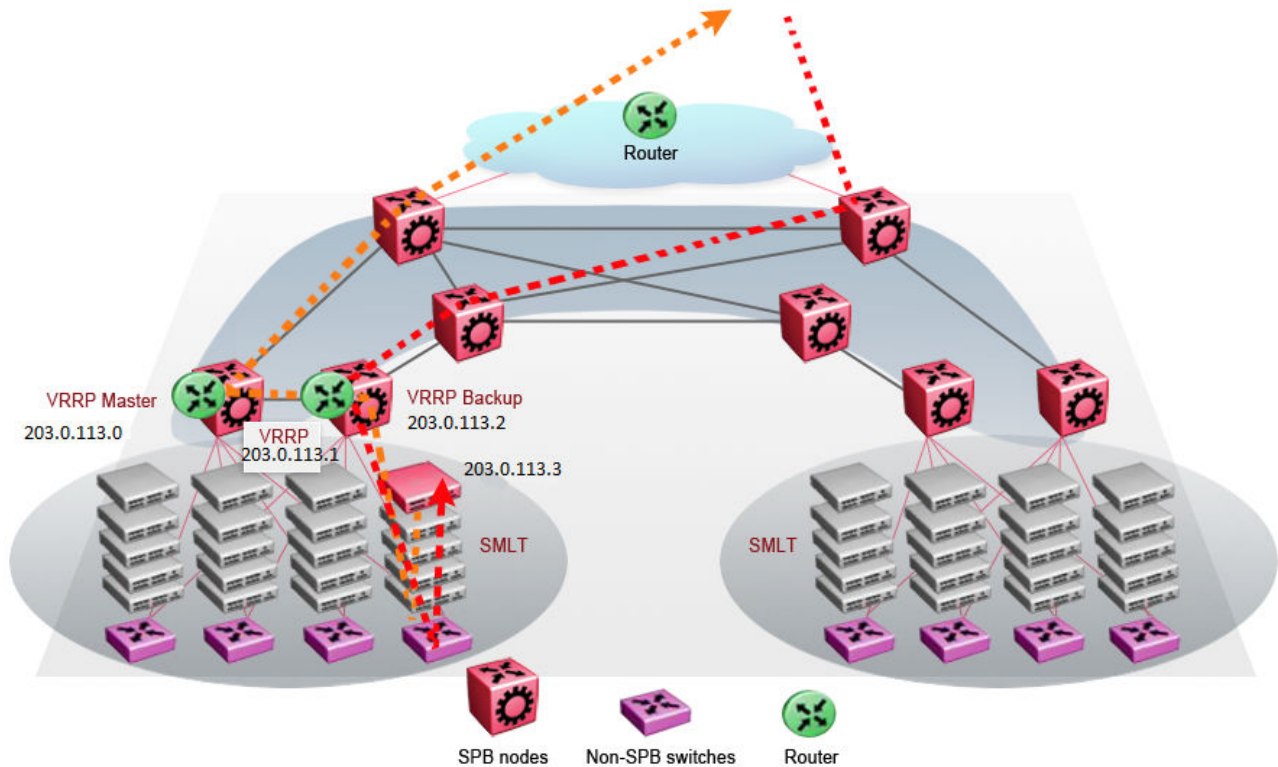

Figure 53: Traditional routing before moving VMs

A VM is a virtual server. When you move a VM, the virtual server is moved as is. This action means that the IP addresses of that server remain the same after the server is moved from one data center to the other. This in turn dictates that the same IP subnet (and hence VLAN) exist in both data centers.

In the following figure, the VM moved from the data center on the left to the data center on the right. To ensure a seamless transition that is transparent to the user, the VM retains its network connections through the default gateway. This method works, but it adds more hops to all traffic. As you can see in the figure, one VM move results in a complicated traffic path. Multiply this with many moves and soon the network look like a tangled mess that is very inefficient, difficult to maintain, and almost impossible to troubleshoot.

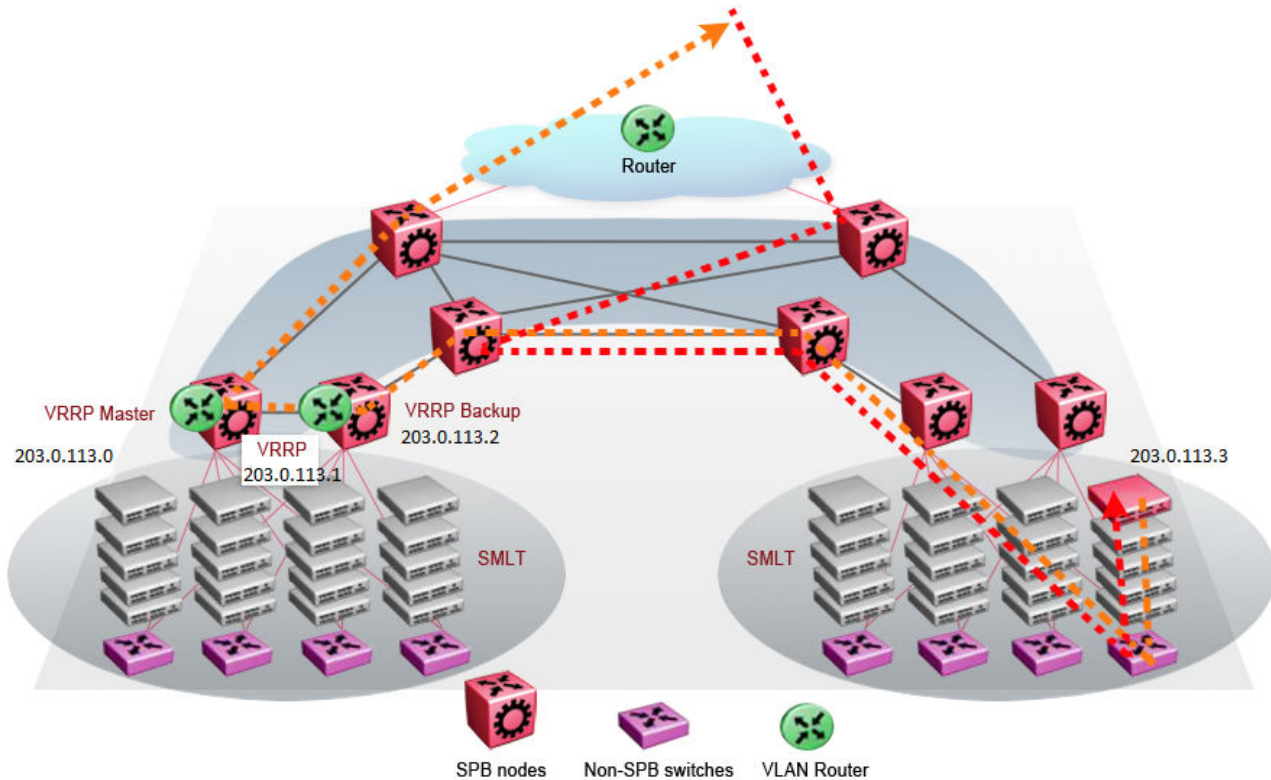

Figure 54: Traditional routing after moving VMs

Optimized data center routing of VMs:

Two features make a data center optimized:

- VLAN routers in the Layer 2 domain (green icons)
- VRRP BackupMaster

The VLAN routers use lookup tables to determine the best path to route incoming traffic (red dots) to the destination VM.

VRRP BackupMaster solves the problem of traffic congestion on the vIST. Because there can be only one VRRP Master, all other interfaces are in backup mode. In this case, all traffic is forwarded over the vIST link towards the primary VRRP switch. All traffic that arrives at the VRRP backup interface is forwarded, so there is not enough bandwidth on the vIST link to carry all the aggregated riser traffic. VRRP BackupMaster overcomes this issue by ensuring that the vIST trunk is not used in such a case for primary data forwarding. The VRRP BackupMaster acts as an IP router for packets destined for the logical VRRP IP address. All traffic is directly routed to the destined subnetwork and not through Layer 2 switches to the VRRP Master. This avoids potential limitation in the available vIST bandwidth.

The following figure shows a solution that optimizes your network for bidirectional traffic flows. However, this solution turns two SPBM BCB nodes into BEBs where MAC and ARP learning will be enabled on the Inter-VSN routing interfaces. If you do not care about top-down traffic flows, you can omit the Inter-VSN routing interfaces on the SPBM BCB nodes. This makes the IP routed paths top-down less optimal, but the BCBs remain pure BCBs, thus simplifying core switch configurations.

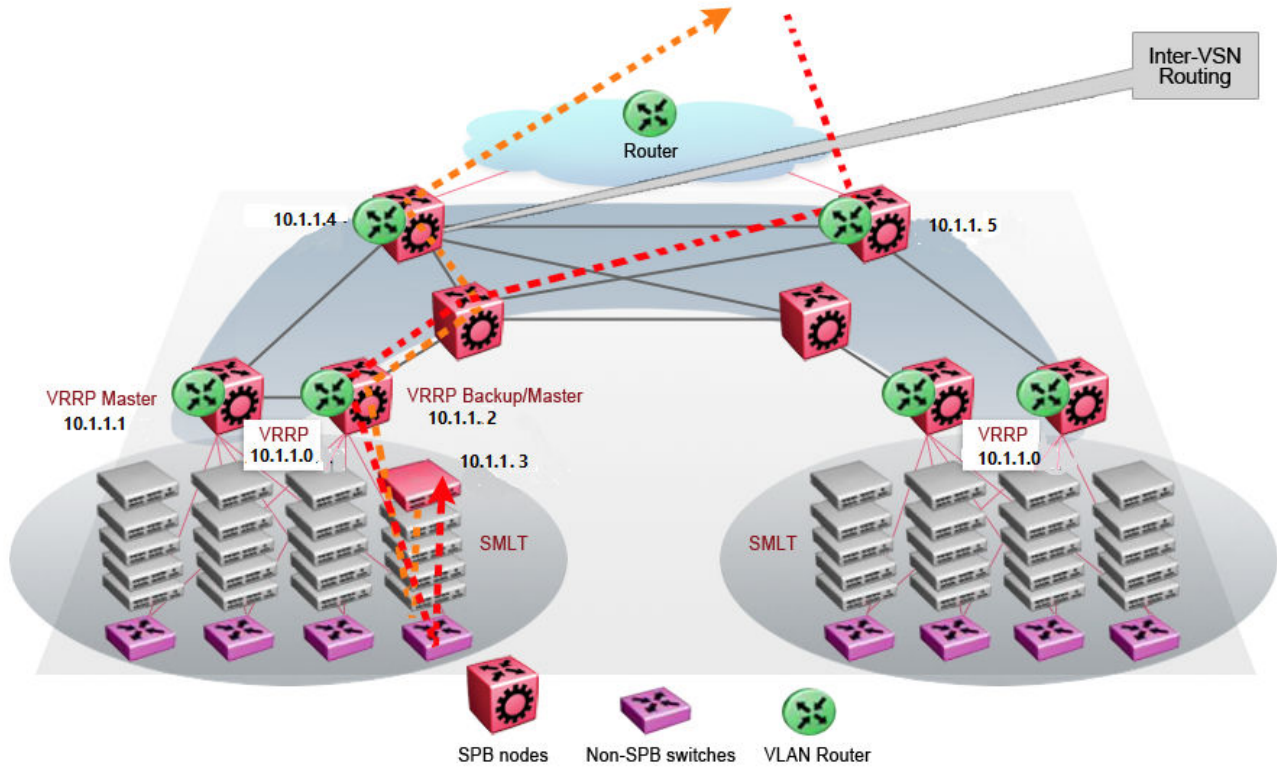

Figure 55: Optimized routing before moving VMs

In the traditional data center, chaos resulted after many VMs were moved. In an optimized data center as shown in the following figure, the incoming traffic enters the Layer 2 domain where an edge switch uses Inter-VSN routing to attach an I-SID to a VLAN. The I-SID bridges traffic directly to the destination. With VRRP BackupMaster, the traffic no longer goes through the default gateway; it takes the most direct route in and out of the network.

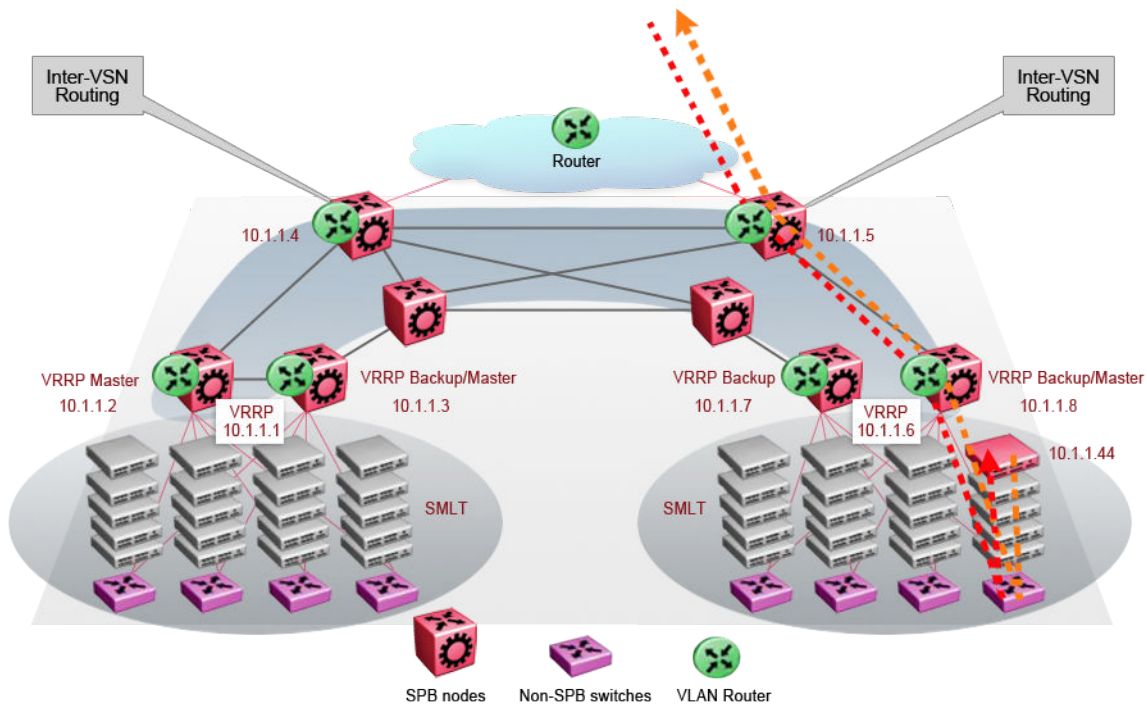

Figure 56: Optimized routing after moving VMs

Solution-specific reference architectures

The following sections describe solution-specific reference architectures, like for example for Video Surveillance or Data Center implementation, using the VSP 4000.

Multi-tenant — fabric connect

This fabric connect-based solution leverages the fabric capabilities of the VSP platforms: a VSP 7000 core and a VSP 4000 edge. This solution provides the ability to run, by default, up to 24 VRFs for each wiring closet and is well suited for multi-tenant applications. The zero-touch core is enabled by the fabric connect endpoint provisioning capabilities.

*** Note:**

You can increase VRF scaling to run more than 24 VRFs. The maximum number of supported VRFs and Layer 3 VSNs differs depending on the hardware platform. For more information about maximum scaling numbers, see *Release Notes*.

If this solution must support IPv6, then a central router-pair routes all IPv6 traffic. The IPv6 traffic is tunneled from each wiring closet to the IPv6 routers by extending Layer 2 VSNs to the q-tagged router interfaces.

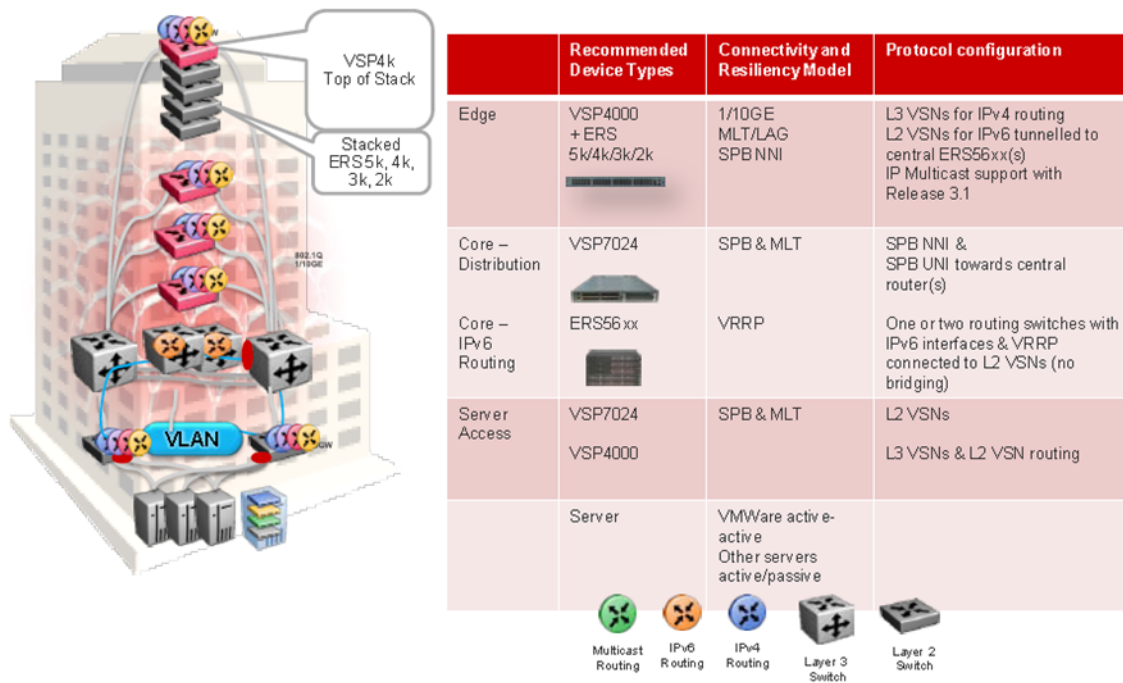

Figure 57: Small core — multi-tenant

The following list outlines the benefits of the fabric connect-based solution:

- Endpoint provisioning
- Fast failover
- Simple to configure
- Layer 2 and Layer 3 virtualized

Hosted data center management solution — E-Tree

In some hosted data center solutions, the hosting center operating company takes responsibility for managing customer servers. For this shared management, shown in the following figure, servers that control the operating system level of the production servers, such as the patch level, are deployed. Because customer production servers do not communicate with each other, a distributed private VLAN solution based on fabric connect is deployed to manage all production servers. This solution builds a distributed set of E-Trees for each management domain.

The VSP switches as access, provide an elegant network-wide E-Tree solution. Spokes, or managed servers, cannot communicate to each other over this network, but the shared management servers on the hub ports can access all spokes. Because of the Layer 2 – E-Tree nature of this setup, the managed servers do not require any route entries, and only require one IP interface in this management private VLAN. This solution supports tagged and untagged physical and virtual (VM) servers.

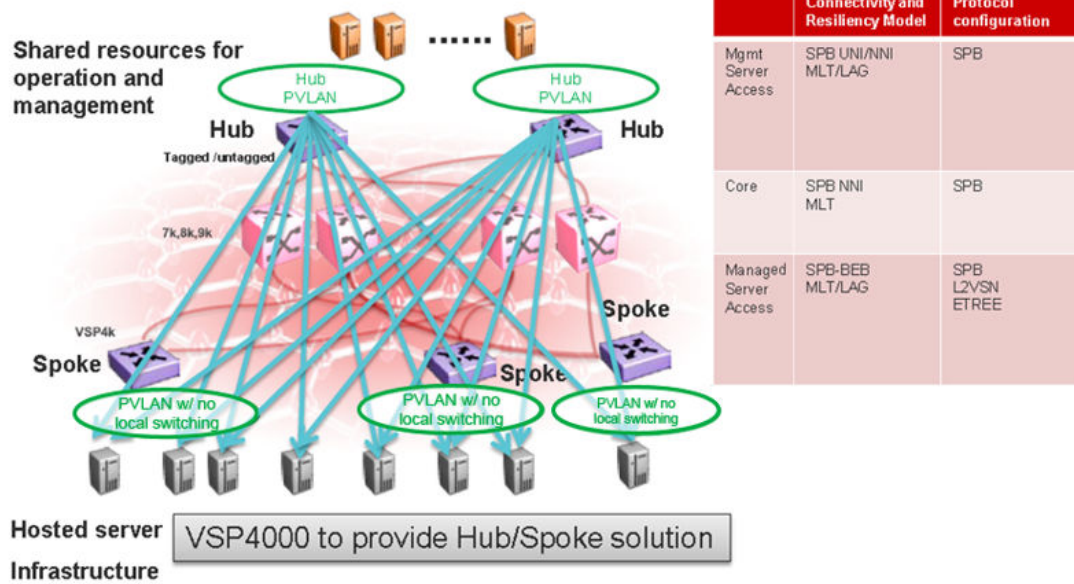

Figure 58: Data center hosting private VLAN

The following list outlines the benefits of the hosted data center management solution:

- Easy endpoint provisioning
- Optimal resiliency
- Secure tenant separation

Video surveillance — bridged

In a video surveillance solution, optimal traffic forwarding is a key requirement to ensure proper operation of the camera and recorder solutions. However, signaling is also important to ensure quick channel switching. This is achieved by deploying a fabric connect based IP multicast infrastructure that is optimized for multicast transport, so that the cameras can be selected quickly, and so that there is no unnecessary traffic sent across the backbone.

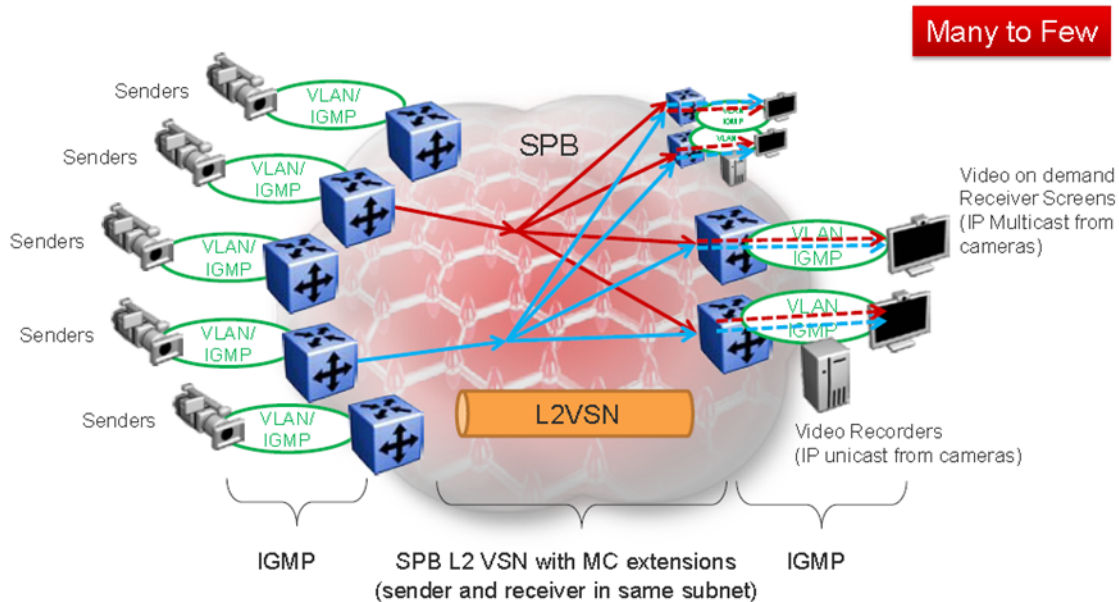

Figure 59: Deployment scenario — bridged video surveillance and IP camera deployment for transportation, airports, and government

The following list outlines the benefits of the bridged video surveillance solution:

- Easy end-point provisioning
- sub second resiliency and mc forwarding
- secure tenant separation
- quick camera switching

Video surveillance — routed

In a video surveillance solution, optimal traffic forwarding is a key requirement to ensure proper operation of the camera and recorder solutions. However, signaling is also important to ensure quick channel switching. This is achieved by deploying an IP multicast infrastructure that is optimized for multicast transport, so that the cameras can be selected quickly, and so that there is no unnecessary traffic sent across the backbone. In the topology shown in the following figure, each camera is attached to its own IP subnet. In a larger topology, this can reduce network overhead. To increase network scalability, you can attach a set of cameras to a Layer 2 switch that has IGMP, and then connect the cameras to the fabric edge (BEB) which has a routing instance.

In many customer scenarios, surveillance must be separated from the rest of the infrastructure. This can be achieved by deploying a Layer 3 VSN for the surveillance traffic to keep the surveillance traffic isolated from any other tenant. For more information, see *Configuring Fabric Layer 3 Services*.

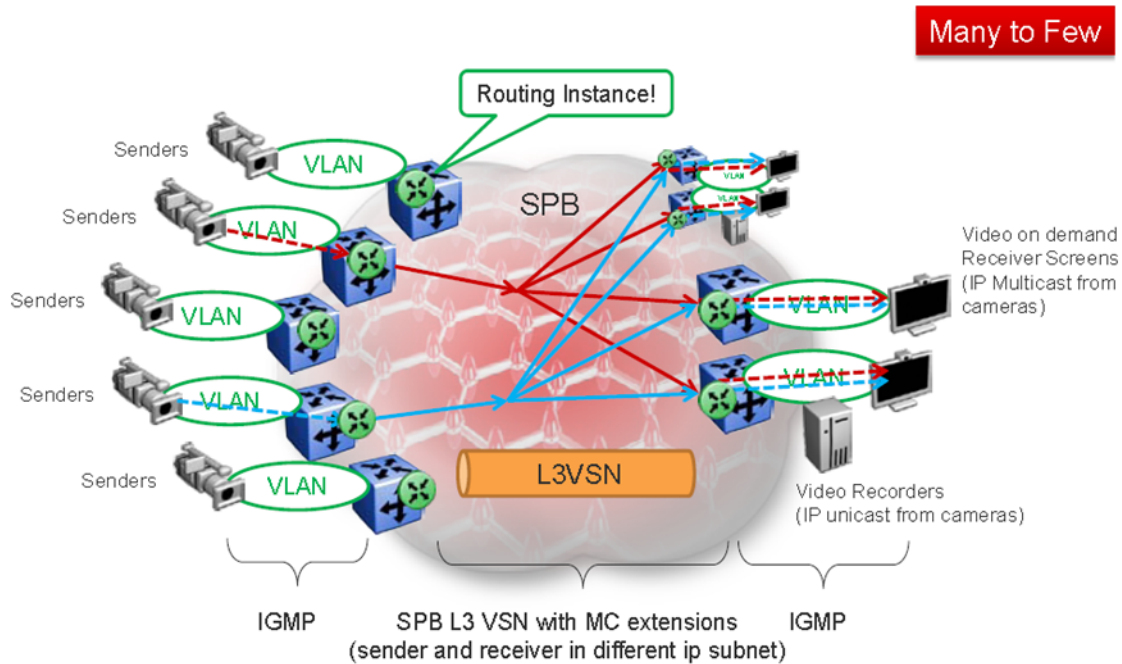

Figure 60: Deployment scenario — Routed video surveillance and IP camera deployment for transportation, airports, and government

The following list outlines the benefits of the routed video surveillance solution:

- Easy endpoint provisioning
- Optimal resiliency and mc forwarding
- Secure tenant separation
- Rapid channel/camera switching

Metro-Ethernet Provider solution

VSP switches provide an end-to-end Metro-Ethernet Provider solution. Leveraging fabric connect throughout the infrastructure enables a scalable and flexible wholesale provider infrastructure.

This use case extends the Transparent Port UNI functionality to transparently forward any customer VLAN across the services.

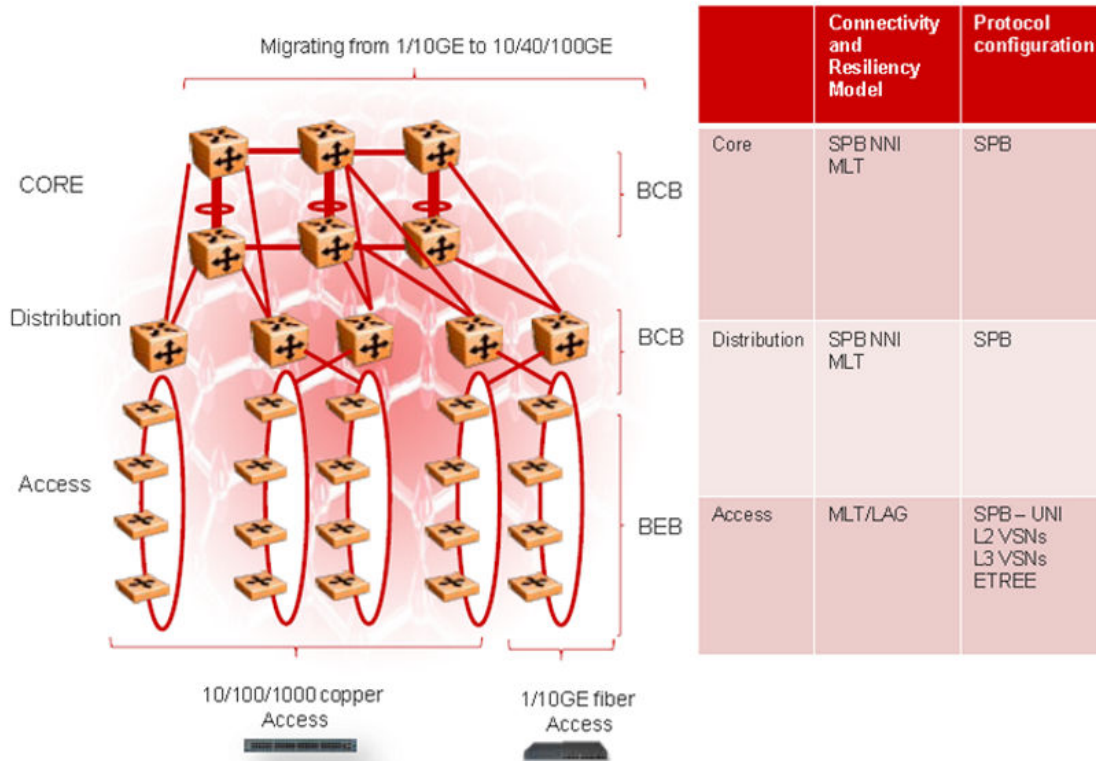

Figure 61: Metro ring access solution

The following list outlines the benefits of the Metro-Ethernet Provider solution:

- Easy endpoint provisioning
- Optimal resiliency
- Secure tenant separation

Glossary

Autonomous System (AS)	A set of routers under a single technical administration, using a single IGP and common metrics to route packets within the Autonomous System, and using an EGP to route packets to other Autonomous Systems.
autonomous system border router (ASBR)	A router attached at the edge of an OSPF network. An ASBR uses one or more interfaces that run an interdomain routing protocol such as BGP. In addition, a router distributing static routes or Routing Information Protocol (RIP) routes into OSPF is considered an ASBR.
Autonomous System Number (ASN)	A two-byte number that is used to identify a specific AS.
Backbone Core Bridge (BCB)	Backbone Core Bridges (BCBs) form the core of the SPBM network. The BCBs are SPBM nodes that do not terminate the VSN services. BCBs forward encapsulated VSN traffic based on the Backbone MAC Destination Address (B-MAC-DA). A BCB can access information to send that traffic to any Backbone Edge Bridges (BEBs) in the SPBM backbone.
Backbone Edge Bridge (BEB)	Backbone Edge Bridges (BEBs) are SPBM nodes where Virtual Services Networks (VSNs) terminate. BEBs handle the boundary between the core MAC-in-MAC Shortest Path Bridging MAC (SPBM) domain and the edge customer 802.1Q domain. A BEB node performs 802.1ah MAC-in-MAC encapsulation and decapsulation for the Virtual Services Network (VSN).
Backbone MAC (B-MAC)	Provider Backbone Bridging (PBB) MAC-in-MAC encapsulation encapsulates customer MAC addresses in Backbone MAC (B-MAC) addresses. MAC-in-MAC encapsulation defines a B-MAC-DA and B-MAC-SA to identify the backbone source and destination addresses. The originating node creates a MAC header that SPBM uses for delivery from end to end. As the MAC header stays the same across the network, no need exists to swap a label or perform a route lookup at each node, allowing the frame to follow the most efficient forwarding path end to end. In Shortest Path Bridging MAC (SPBM), each node has a System ID, which is used in the topology announcement. This same System ID also serves as the switch Backbone MAC address (B-MAC), which is used as the source and destination MAC address in the SPBM network.
Backbone VLAN identifier (B-VID)	The Backbone VLAN identifier (B-VID) indicates the Shortest Path Bridging MAC (SPBM) B-VLAN associated with the SPBM instance.

BGP+	BGP+ is an extension of BGPv4 to support IPv6. BGP+ carries routing information for multiple network layer protocol address families, for example, IPv6 address family and for IP multicast routes.
Circuitless IP (CLIP)	A CLIP is often called a loopback and is a virtual interface that does not map to any physical interface.
Complete Sequence Number Packets (CSNP)	Complete Sequence Number Packets (CSNP) contain the most recent sequence numbers of all Link State Packets (LSPs) in the database. When all routers update their LSP database, synchronization is complete.
Connectivity Fault Management (CFM)	Connectivity Fault Management is a mechanism to debug connectivity issues and to isolate faults within the Shortest Path Bridging MAC (SPBM) network. CFM operates at Layer 2 and provides the equivalent of ping and traceroute. IEEE 802.1ag Connectivity Fault Management (CFM) divides or separates a network into administrative domains called Maintenance Domains (MD).
Customer MAC (C-MAC)	For customer MAC (C-MAC) addresses, which is customer traffic, to forward across the service provider back, SPBM uses IEEE 802.1ah Provider Backbone Bridging MAC-in-MAC encapsulation. The system encapsulates C-MAC addresses within a backbone MAC (B-MAC) address pair made up of a B-MAC destination address (B-MAC-DA) and a B-MAC source address (B-MAC-SA).
Customer VLAN (C-VLAN)	A traditional VLAN with MAC learning and flooding, where user devices connect to the network. In SPBM, C-VLANs are mapped to a Service Instance Identifier (I-SID) at the Backbone Edge Bridges (BEBs).
Data I-SID	In SPBM, the data I-SID is allocated by the Backbone Edge Bridge (BEB) when the multicast stream reaches the BEB. The data I-SID uses Tx/Rx bits to signify whether the BEB uses the I-SID to transmit, receive, or both transmit and receive data on that I-SID. Data is transported from the sender to the receiver across the SPBM cloud using the data I-SID.
Designated Intermediate System (DIS)	A Designated Intermediate System (DIS) is the designated router in Intermediate System to Intermediate System (IS-IS) terminology. You can modify the priority to affect the likelihood of a router being elected the designated router. The higher the priority, the more likely the router is to be elected as the DIS. If two routers have the same priority, the router with the highest MAC address (Sequence Number Packet [SNP] address) is elected as the DIS.
designated router (DR)	A single router elected as the designated router for the network. In a broadcast or nonbroadcast multiple access (NBMA) network running the Open Shortest Path First (OSPF) protocol, a DR ensures all network routers synchronize with each other and advertises the network to the rest of the Autonomous System (AS). In a multicast network running Protocol Independent Multicast (PIM), the DR acts as a representative router for

	directly connected hosts. The DR sends control messages to the rendezvous point (RP) router, sends register messages to the RP on behalf of directly connected sources, and maintains RP router status information for the group.
Enterprise Device Manager (EDM)	A web-based embedded management system to support single-element management. EDM provides complete configuration management functionality for the supported devices and is supplied to the customer as embedded software in the device.
equal cost multipath (ECMP)	Distributes routing traffic among multiple equal-cost routes.
Global routing engine (GRE)	The base router or routing instance 0 in the Virtual Routing and Forwarding (VRF).
Global Routing Table (GRT)	The Global Routing Table (GRT) is a table that maintains the information needed to forward an IP packet along the best route.
graphical user interface (GUI)	A graphical (rather than textual) computer interface.
IEEE 802.1aq	IEEE 802.1aq is the standard for Shortest Path Bridging MAC (SPBM). SPBM makes network virtualization much easier to deploy within, reducing the complexity of the network while at the same time providing greater scalability. SPBM eliminates the need for multiple overlay protocols in the core of the network by reducing the core to a single Ethernet based link state protocol which can provide virtualization services, both layer 2 and layer 3, using a pure Ethernet technology base.
Institute of Electrical and Electronics Engineers (IEEE)	An international professional society that issues standards and is a member of the American National Standards Institute, the International Standards Institute, and the International Standards Organization.
Interior Gateway Protocol (IGP)	Distributes routing information between routers that belong to a single Autonomous System (AS).
Intermediate System to Intermediate System (IS-IS)	<p>Intermediate System to Intermediate System (IS-IS) is a link-state, interior gateway protocol. ISO terminology refers to routers as Intermediate Systems (IS), hence the name Intermediate System to Intermediate System (IS-IS). IS-IS operation is similar to Open Shortest Path First (OSPF).</p> <p>In Shortest Path Bridging MAC (SPBM) networks, IS-IS discovers network topology and builds shortest path trees between network nodes that IS-IS uses for forwarding unicast traffic and determining the forwarding table for multicast traffic. SPBM employs IS-IS as the interior gateway protocol and implements additional Type-Length-Values (TLVs) to support additional functionality.</p>

interswitch trunking (IST)	A feature that uses one or more parallel point-to-point links to connect two aggregation switches. The two aggregation switches use this channel to share information and operate as a single logical switch. Only one interswitch trunk can exist on each Split Multilink Trunking (SMLT) aggregation switch.
IS-IS Hello packets	Intermediate System to Intermediate System (IS-IS) uses Hello packets to initialize and maintain adjacencies between neighboring routers. IS-IS Hello packets contain the IP address of the interface over which the Hello transmits. These packets are broadcast to discover the identities of neighboring IS-IS systems and to determine whether the neighbor is a Level 1 router.
Layer 1	Layer 1 is the Physical Layer of the Open System Interconnection (OSI) model. Layer 1 interacts with the MAC sublayer of Layer 2, and performs character encoding, transmission, reception, and character decoding.
Layer 2	Layer 2 is the Data Link Layer of the OSI model. Examples of Layer 2 protocols are Ethernet and Frame Relay.
Layer 2 Virtual Services Network	The Layer 2 Virtual Services Network (L2 VSN) feature provides IP connectivity over SPBM for VLANs. Backbone Edge Bridges (BEBs) handle Layer 2 virtualization. At the BEBs you map the end-user VLAN to a Service Instance Identifier (I-SID). BEBs that have the same I-SID configured can participate in the same Layer 2 Virtual Services Network (VSN).
Layer 3	Layer 3 is the Network Layer of the OSI model. An example of a Layer 3 protocol is Internet Protocol (IP).
Layer 3 Virtual Services Network	The Layer 3 Virtual Services Network (L3 VSN) feature provides IP connectivity over SPBM for VRFs. Backbone Edge Bridges (BEBs) handle Layer 3 virtualized. At the BEBs through local provisioning, you map the end-user IP enabled VLAN or VLANs to a Virtualized Routing and Forwarding (VRF) instance. Then you map the VRF to a Service Instance Identifier (I-SID). VRFs that have the same I-SID configured can participate in the same Layer 3 Virtual Service Network (VSN).
Layer 4	The Transport Layer of the OSI model. An example of a Layer 4 protocol is Transmission Control Protocol (TCP).
Link Layer Discovery Protocol (LLDP)	Link Layer Discovery Protocol is used by network devices to advertise their identities. Devices send LLDP information at fixed intervals in the form of Ethernet frames, with each frame having one Link Layer Discovery Protocol Data Unit.
Link State Packets (LSP)	Link State Packets (LSP) contain information about the state of adjacencies or defined and distributed static routes. Intermediate System to

Intermediate System (IS-IS) exchanges this information with neighboring IS-IS routers at periodic intervals. Every router in the domain has an identical link state database and each runs shortest path first to calculate routes.

Link State Protocol Data Unit (LSPDUs)

Link State Protocol Data Unit is similar to a Link State Advertisement in Open Shortest Path First (OSPF). Intermediate System to Intermediate System (IS-IS) runs on all nodes of Shortest Path Bridging-MAC (SPBM). Since IS-IS is the basis of SPBM, the device must first form the IS-IS adjacency by first sending out hellos and then Link State Protocol Data Units. After the hellos are confirmed both nodes send Link State Protocol Data Units (LSPDUs) that contain connectivity information for the SPBM node. These nodes also send copies of all other LSPDUs they have in their databases. This establishes a network of connectivity providing the necessary information for each node to find the best and proper path to all destinations in the network.

link trace message

The link trace message (LTM) is often compared to traceroute. A MEP transmits the LTM packet. This packet specifies the target MAC address of an MP, which is the SPBM system id or the virtual SMLT MAC. MPs on the path to the target address respond with an LTR. LTM contains:

- Time to live (TTL)
- Transaction Identifier
- Originator MAC address
- Target MAC address

link-state database (LSDB)

A database built by each OSPF router to store LSA information. The router uses the LSDB to calculate the shortest path to each destination in the autonomous system (AS), with itself at the root of each path.

Local Area Network (LAN)

A data communications system that lies within a limited spatial area, uses a specific user group and topology, and can connect to a public switched telecommunications network (but is not one).

Loopback Messages (LBM)

A Loopback Message (LBM) is a unicast message triggered by the operator issuing an operational command. LBM can be addressed to either a Maintenance End Point (MEP) or Maintenance Intermediate Point (MIP), but only a MEP can initiate an LBM. The destination MP can be addressed by its MAC address. The receiving MP responds with a Loopback Response (LBR). LBM can contain an arbitrary amount of data that can be used to diagnose faults as well as performance measurements. The receiving MP copies the data to the LBR. The system achieves fault verification through the use of Loopback Messages (LBM).

Loopback Response (LBR)

Loopback Response (LBR) is the response from a Maintenance Point (MP).

MAC-in-MAC encapsulation	MAC-in-MAC encapsulation defines a BMAC-DA and BMAC-SA to identify the backbone source and destination addresses. The originating node creates a MAC header that the device uses for delivery from end to end. As the MAC header stays the same across the network, there is no need to swap a label or do a route lookup at each node, allowing the frame to follow the most efficient forwarding path end to end.
Maintenance Associations (MA)	Maintenance Associations (MA) are administrative associations in a network that is divided by the 802.1ag Connectivity Fault Management (CFM) feature. CFM groups MAs within Maintenance Domains. Each MA is defined by a set of Maintenance Points (MP). An MP is a demarcation point on an interface that participates in CFM within an MD. Connectivity Fault Management is a mechanism to debug connectivity issues and to isolate faults within the Shortest Path Bridging MAC (SPBM) Network.
Maintenance Domains (MD)	Maintenance Domains (MD) are administrative domains that divides a network by the 802.1ag Connectivity Fault Management (CFM) feature. Each MD is further subdivided into logical groupings called Maintenance Associations (MA). Connectivity Fault Management is a mechanism to debug connectivity issues and to isolate faults within the Shortest Path Bridging MAC (SPBM) Network.
Maintenance Points (MP)	Maintenance Points (MP) are a demarcation point on an interface that participates in Connectivity Fault Management (CFM) within a Maintenance Domain (MD). There are two types of MP: Maintenance End Point (MEP) and Maintenance Intermediate Point (MIP). Connectivity Fault Management is a mechanism to debug connectivity issues and to isolate faults within the Shortest Path Bridging MAC (SPBM) Network.
MD5 Authentication	MD5 authentication creates an encoded checksum in the transmitted packet. The receiving router uses an authentication key (password) to verify the packet's MD5 checksum. There is an optional key ID.
Media Access Control (MAC)	Arbitrates access to and from a shared medium.
MultiLink Trunking (MLT)	A method of link aggregation that uses multiple Ethernet trunks aggregated to provide a single logical trunk. A multilink trunk provides the combined bandwidth of multiple links and the physical layer protection against the failure of a single link.
Network Entity Title (NET)	<p>The Network Entity Title (NET) is the combination of all three global parameters: Manual area, System ID and NSEL.</p> <ul style="list-style-type: none"> • Manual area — The manual area or area ID is up to 13 bytes long. The first byte of the area number (for example, 49) is the Authority and Format Indicator (AFI). The next bytes are the assigned domain (area) identifier, which is up to 12 bytes (for example, 49.0102.0304.0506.0708.0910.1112).

- System ID — The system ID is any 6 bytes that are unique in a given area or level. The system ID defaults to the node BMAC.
- NSEL — The last byte (00) is the n-selector.

In the Ethernet Routing Switch 8800/8600 implementation, this part is automatically attached. There is no user input accepted.

Open Shortest Path First (OSPF)

A link-state routing protocol used as an Interior Gateway Protocol (IGP).

Partial Sequence Number Packets (PSNP)

Partial Sequence Number Packets (PSNP) are requests for missing Link State Packets (LSPs). When a receiving router detects a missing LSP, it sends a PSNP to the router that sent the Complete Sequence Number Packets (CSNP).

port

A physical interface that transmits and receives data.

Protocol Data Units (PDUs)

A unit of data that is specified in a protocol of a specific layer and that consists of protocol-control information of the specific layer and possibly user data of that layer.

Provider Backbone Bridge (PBB)

To forward customer traffic across the service-provider backbone, SPBM uses IEEE 802.1ah Provider Backbone Bridging (PBB) MAC-in-MAC encapsulation, which hides the customer MAC (C-MAC) addresses in a backbone MAC (B-MAC) address pair. MAC-in-MAC encapsulation defines a BMAC-DA and BMAC-SA to identify the backbone source and destination addresses.

rendezvous point (RP)

The root of the shared tree. One RP exists for each multicast group. The RP gathers information about available multicast services through the reception of control messages and the distribution of multicast group information. Protocol Independent Multicast (PIM) uses RPs.

reverse path checking (RPC)

Prevents packet forwarding for incoming IP packets with incorrect or forged (spoofed) IP addresses.

reverse path forwarding (RPF)

Prevents a packet from forging its source IP address. Typically, the system examines and validates the source address of each packet.

Routing Information Protocol (RIP)

A distance vector protocol in the IP suite, used by IP network-layer protocol, that enables routers in the same AS to exchange routing information by means of periodic updates. You often use RIP as a very simple interior gateway protocol (IGP) within small networks.

scope level

In IP Multicast over Fabric Connect, the scope level is the level in which the multicast stream is constrained. For instance, if a sender sends a multicast stream to a BEB on a Layer 2 Virtual Services Network (VSN) only receivers that are part of a Layer 2 VSN can receive that stream. Similarly,

if a sender sends a multicast stream to a BEB on a Layer 3 VSN only receivers that are part of a Layer 3 VSN can receive that stream.

Service Instance Identifier (I-SID)

The SPBM B-MAC header includes a Service Instance Identifier (I-SID) with a length of 24 bits. SPBM uses this I-SID to identify and transmit any virtualized traffic in an encapsulated SPBM frame. SPBM uses I-SIDs to virtualize VLANs (Layer 2 Virtual Services Network [VSN]) or VRFs (Layer 3 Virtual Services Network [VSN]) across the MAC-in-MAC backbone. With Layer 2 VSNs, you associate the I-SID with a customer VLAN, which is then virtualized across the backbone. With Layer 3 VSNs, you associate the I-SID with a customer VRF, which is also virtualized across the backbone.

Shortest Path Bridging (SPB)

Shortest Path Bridging is a control Link State Protocol that provides a loop-free Ethernet topology. There are two versions of Shortest Path Bridge: Shortest Path Bridging VLAN and Shortest Path Bridging MAC. Shortest Path Bridging VLAN uses the Q-in-Q frame format and encapsulates the source bridge ID into the VLAN header. Shortest Path Bridging MAC uses the 802.1 ah MAC-in-MAC frame format and encapsulates the source bridge identifier into the B-MAC header.

Shortest Path Bridging MAC (SPBM)

Shortest Path Bridging MAC (SPBM) uses the Intermediate-System-to-Intermediate-System (IS-IS) link-state routing protocol to provide a loop-free Ethernet topology that creates a shortest-path topology from every node to every other node in the network based on node MAC addresses. SPBM uses the 802.1ah MAC-in-MAC frame format and encapsulates the source bridge identifier into the B-MAC header. SPBM eliminates the need for multiple overlay protocols in the core of the network by reducing the core to a single Ethernet-based link-state protocol, which can provide virtualization services, both layer 2 and layer 3, using a pure Ethernet technology base.

shortest path first (SPF)

A class of routing protocols that use Dijkstra's algorithm to compute the shortest path through a network, according to specified metrics, for efficient transmission of packet data.

shortest path tree (SPT)

Creates a direct route between the receiver and the source for group members in a Protocol Independent Multicast-Sparse Mode (PIM-SM) domain.

Split MultiLink Trunking (SMLT)

An extension to IEEE 802.1AX (link aggregation), provides nodal and link failure protection and flexible bandwidth scaling to improve on the level of Layer 2 resiliency.

time-to-live (TTL)

The field in a packet used to determine the valid duration for the packet. The TTL determines the packet lifetime. The system discards a packet with a TTL of zero.

Top of Rack (TOR)	A Top of Rack (TOR) switch refers to a switch that sits at the top or near the top of a rack often found in data centers.
Virtual Link Aggregation Control Protocol (VLACP)	Virtual Link Aggregation Control Protocol (VLACP) is a Layer 2 handshaking protocol that can detect end-to-end failure between two physical Ethernet interfaces.
Virtual Local Area Network (VLAN)	A Virtual Local Area Network is a group of hosts that communicate as if they are attached to the same broadcast domain regardless of their physical location. VLANs are layer 2 constructs.
Virtual Private Network (VPN)	A Virtual Private Network (VPN) requires remote users to be authenticated and ensures private information is not accessible to unauthorized parties. A VPN can allow users to access network resources or to share data.
VLAN Identifier (VID)	VLAN Identifier (VID) is a data field in IEEE 802.1Q VLAN tagging.