

# Extreme Networks<sup>®</sup>

## *ExtremeControl User Guide*

## Legal Notices

Extreme Networks, Inc., on behalf of or through its wholly-owned subsidiary, Enterasys Networks, Inc., reserves the right to make changes in specifications and other information contained in this document and its website without prior notice. The reader should in all cases consult representatives of Extreme Networks to determine whether any such changes have been made.

The hardware, firmware, software or any specifications described or referred to in this document are subject to change without notice.

## Trademarks

Extreme Networks and the Extreme Networks logo are trademarks or registered trademarks of Extreme Networks, Inc. in the United States and/or other countries.

All other names (including any product names) mentioned in this document are the property of their respective owners and may be trademarks or registered trademarks of their respective companies/owners.

For additional information on Extreme Networks trademarks, please see: [www.extremenetworks.com/company/legal/trademarks/](http://www.extremenetworks.com/company/legal/trademarks/)

## Contact

If you require assistance, contact Extreme Networks using one of the following methods.

- [Global Technical Assistance Center \(GTAC\) for Immediate Support](#)
  - **Phone:** 1-800-998-2408 (toll-free in U.S. and Canada) or 1-603-952-5000. For the Extreme Networks support phone number in your country, visit: [www.extremenetworks.com/support/contact](http://www.extremenetworks.com/support/contact)
  - **Email:** [support@extremenetworks.com](mailto:support@extremenetworks.com). To expedite your message, enter the product name or model number in the subject line.

- 
- [GTAC Knowledge](#) — Get on-demand and tested resolutions from the GTAC Knowledgebase, or create a help case if you need more guidance.
  - [The Hub](#) — A forum for Extreme customers to connect with one another, get questions answered, share ideas and feedback, and get problems solved. This community is monitored by Extreme Networks employees, but is not intended to replace specific guidance from GTAC.
  - [Support Portal](#) — Manage cases, downloads, service contracts, product licensing, and training and certifications.



## Extreme Networks® Software License Agreement

---

This Extreme Networks Software License Agreement is an agreement ("Agreement") between You, the end user, and Extreme Networks, Inc. ("Extreme"), on behalf of itself and its Affiliates (as hereinafter defined and including its wholly owned subsidiary, Enterasys Networks, Inc. as well as its other subsidiaries). This Agreement sets forth Your rights and obligations with respect to the Licensed Software and Licensed Materials. BY INSTALLING THE LICENSE KEY FOR THE SOFTWARE ("License Key"), COPYING, OR OTHERWISE USING THE LICENSED SOFTWARE, YOU ARE AGREEING TO BE BOUND BY THE TERMS OF THIS AGREEMENT, WHICH INCLUDES THE LICENSE AND THE LIMITATION OF WARRANTY AND DISCLAIMER OF LIABILITY. IF YOU DO NOT AGREE TO THE TERMS OF THIS AGREEMENT, RETURN THE LICENSE KEY TO EXTREME OR YOUR DEALER, IF ANY, OR DO NOT USE THE LICENSED SOFTWARE AND CONTACT EXTREME OR YOUR DEALER WITHIN TEN (10) DAYS FOLLOWING THE DATE OF RECEIPT FOR A REFUND. IF YOU HAVE ANY QUESTIONS ABOUT THIS AGREEMENT, CONTACT EXTREME, Attn: LegalTeam@extremenetworks.com.

1. DEFINITIONS. "Affiliates" means any person, partnership, corporation, limited liability company, or other form of enterprise that directly or indirectly through one or more intermediaries, controls, or is controlled by, or is under common control with the party specified. "Server Application" shall refer to the License Key for software installed on one or more of Your servers. "Client Application" shall refer to the application to access the Server Application. "Licensed Materials" shall collectively refer to the licensed software (including the Server Application and Client Application), Firmware, media embodying the software, and the documentation. "Concurrent User" shall refer to any of Your individual employees who You provide access to the Server Application at any one time. "Firmware" refers to any software program or code imbedded in chips or other media. "Licensed Software" refers to the Software and Firmware collectively.
2. TERM. This Agreement is effective from the date on which You install the License Key, use the Licensed Software, or a Concurrent User accesses the Server Application.

---

You may terminate the Agreement at any time by destroying the Licensed Materials, together with all copies, modifications and merged portions in any form. The Agreement and Your license to use the Licensed Materials will also terminate if You fail to comply with any term of condition herein.

3. GRANT OF SOFTWARE LICENSE. Extreme will grant You a non-transferable, non-exclusive license to use the machine-readable form of the Licensed Software and the accompanying documentation if You agree to the terms and conditions of this Agreement. You may install and use the Licensed Software as permitted by the license type purchased as described below in License Types. The license type purchased is specified on the invoice issued to You by Extreme or Your dealer, if any. YOU MAY NOT USE, COPY, OR MODIFY THE LICENSED MATERIALS, IN WHOLE OR IN PART, EXCEPT AS EXPRESSLY PROVIDED IN THIS AGREEMENT.
4. LICENSE TYPES.
  - *Single User, Single Computer.* Under the terms of the Single User, Single Computer license, the license granted to You by Extreme when You install the License Key authorizes You to use the Licensed Software on any one, single computer only, or any replacement for that computer, for internal use only. A separate license, under a separate Software License Agreement, is required for any other computer on which You or another individual or employee intend to use the Licensed Software. A separate license under a separate Software License Agreement is also required if You wish to use a Client license (as described below).
  - *Client.* Under the terms of the Client license, the license granted to You by Extreme will authorize You to install the License Key for the Licensed Software on your server and allow the specific number of Concurrent Users shown on the relevant invoice issued to You for each Concurrent User that You order from Extreme or Your dealer, if any, to access the Server Application. A separate license is required for each additional Concurrent User.
5. AUDIT RIGHTS. You agree that Extreme may audit Your use of the Licensed Materials for compliance with these terms and Your License Type at any time, upon reasonable notice. In the event that such audit reveals any use of the Licensed Materials by You other than in full compliance with the license granted and the terms of this Agreement, You shall reimburse Extreme for all reasonable expenses related to such audit in addition to any other liabilities You may incur as a result of such non-compliance, including but not limited to additional fees for Concurrent Users over and above those specifically granted to You. From time to time, the Licensed Software will upload information about the Licensed Software and the associated devices to

---

Extreme. This is to verify the Licensed Software is being used with a valid license. By using the Licensed Software, you consent to the transmission of this information. Under no circumstances, however, would Extreme employ any such measure to interfere with your normal and permitted operation of the Products, even in the event of a contractual dispute.

6. RESTRICTION AGAINST COPYING OR MODIFYING LICENSED MATERIALS. Except as expressly permitted in this Agreement, You may not copy or otherwise reproduce the Licensed Materials. In no event does the limited copying or reproduction permitted under this Agreement include the right to decompile, disassemble, electronically transfer, or reverse engineer the Licensed Software, or to translate the Licensed Software into another computer language.

The media embodying the Licensed Software may be copied by You, in whole or in part, into printed or machine readable form, in sufficient numbers only for backup or archival purposes, or to replace a worn or defective copy. However, You agree not to have more than two (2) copies of the Licensed Software in whole or in part, including the original media, in your possession for said purposes without Extreme's prior written consent, and in no event shall You operate more copies of the Licensed Software than the specific licenses granted to You. You may not copy or reproduce the documentation. You agree to maintain appropriate records of the location of the original media and all copies of the Licensed Software, in whole or in part, made by You. You may modify the machine-readable form of the Licensed Software for (1) your own internal use or (2) to merge the Licensed Software into other program material to form a modular work for your own use, provided that such work remains modular, but on termination of this Agreement, You are required to completely remove the Licensed Software from any such modular work. Any portion of the Licensed Software included in any such modular work shall be used only on a single computer for internal purposes and shall remain subject to all the terms and conditions of this Agreement. You agree to include any copyright or other proprietary notice set forth on the label of the media embodying the Licensed Software on any copy of the Licensed Software in any form, in whole or in part, or on any modification of the Licensed Software or any such modular work containing the Licensed Software or any part thereof.

7. TITLE AND PROPRIETARY RIGHTS
- a. The Licensed Materials are copyrighted works and are the sole and exclusive property of Extreme, any company or a division thereof which Extreme controls or is controlled by, or which may result from the merger or consolidation with Extreme (its "Affiliates"), and/or their suppliers. This Agreement conveys a limited right to operate the Licensed Materials and shall not be construed to

---

convey title to the Licensed Materials to You. There are no implied rights. You shall not sell, lease, transfer, sublicense, dispose of, or otherwise make available the Licensed Materials or any portion thereof, to any other party.

- b. You further acknowledge that in the event of a breach of this Agreement, Extreme shall suffer severe and irreparable damages for which monetary compensation alone will be inadequate. You therefore agree that in the event of a breach of this Agreement, Extreme shall be entitled to monetary damages and its reasonable attorney's fees and costs in enforcing this Agreement, as well as injunctive relief to restrain such breach, in addition to any other remedies available to Extreme.
8. PROTECTION AND SECURITY. In the performance of this Agreement or in contemplation thereof, You and your employees and agents may have access to private or confidential information owned or controlled by Extreme relating to the Licensed Materials supplied hereunder including, but not limited to, product specifications and schematics, and such information may contain proprietary details and disclosures. All information and data so acquired by You or your employees or agents under this Agreement or in contemplation hereof shall be and shall remain Extreme's exclusive property, and You shall use your best efforts (which in any event shall not be less than the efforts You take to ensure the confidentiality of your own proprietary and other confidential information) to keep, and have your employees and agents keep, any and all such information and data confidential, and shall not copy, publish, or disclose it to others, without Extreme's prior written approval, and shall return such information and data to Extreme at its request. Nothing herein shall limit your use or dissemination of information not actually derived from Extreme or of information which has been or subsequently is made public by Extreme, or a third party having authority to do so.

You agree not to deliver or otherwise make available the Licensed Materials or any part thereof, including without limitation the object or source code (if provided) of the Licensed Software, to any party other than Extreme or its employees, except for purposes specifically related to your use of the Licensed Software on a single computer as expressly provided in this Agreement, without the prior written consent of Extreme. You agree to use your best efforts and take all reasonable steps to safeguard the Licensed Materials to ensure that no unauthorized personnel shall have access thereto and that no unauthorized copy, publication, disclosure, or distribution, in whole or in part, in any form shall be made, and You agree to notify Extreme of any unauthorized use thereof. You acknowledge that the Licensed Materials contain valuable confidential information and trade secrets, and that unauthorized use,

---

copying and/or disclosure thereof are harmful to Extreme or its Affiliates and/or its/their software suppliers.

9. MAINTENANCE AND UPDATES. Updates and certain maintenance and support services, if any, shall be provided to You pursuant to the terms of an Extreme Service and Maintenance Agreement, if Extreme and You enter into such an agreement. Except as specifically set forth in such agreement, Extreme shall not be under any obligation to provide Software Updates, modifications, or enhancements, or Software maintenance and support services to You.
10. DEFAULT AND TERMINATION. In the event that You shall fail to keep, observe, or perform any obligation under this Agreement, including a failure to pay any sums due to Extreme, or in the event that you become insolvent or seek protection, voluntarily or involuntarily, under any bankruptcy law, Extreme may, in addition to any other remedies it may have under law, terminate the License and any other agreements between Extreme and You.
  - a. Immediately after any termination of the Agreement or if You have for any reason discontinued use of Software, You shall return to Extreme the original and any copies of the Licensed Materials and remove the Licensed Software from any modular works made pursuant to Section 3, and certify in writing that through your best efforts and to the best of your knowledge the original and all copies of the terminated or discontinued Licensed Materials have been returned to Extreme.
  - b. Sections 1, 7, 8, 10, 11, 12, 13, 14 and 15 shall survive termination of this Agreement for any reason.
11. EXPORT REQUIREMENTS. You are advised that the Software is of United States origin and subject to United States Export Administration Regulations; diversion contrary to United States law and regulation is prohibited. You agree not to directly or indirectly export, import or transmit the Software to any country, end user or for any Use that is prohibited by applicable United States regulation or statute (including but not limited to those countries embargoed from time to time by the United States government); or contrary to the laws or regulations of any other governmental entity that has jurisdiction over such export, import, transmission or Use.
12. UNITED STATES GOVERNMENT RESTRICTED RIGHTS. The Licensed Materials (i) were developed solely at private expense; (ii) contain "restricted computer software" submitted with restricted rights in accordance with section 52.227-19 (a) through (d) of the Commercial Computer Software-Restricted Rights Clause and its successors, and (iii) in all respects is proprietary data belonging to Extreme and/or its suppliers. For Department of Defense units, the Licensed Materials are considered commercial



---

computer software in accordance with DFARS section 227.7202-3 and its successors, and use, duplication, or disclosure by the U.S. Government is subject to restrictions set forth herein.

13. LIMITED WARRANTY AND LIMITATION OF LIABILITY. The only warranty that Extreme makes to You in connection with this license of the Licensed Materials is that if the media on which the Licensed Software is recorded is defective, it will be replaced without charge, if Extreme in good faith determines that the media and proof of payment of the license fee are returned to Extreme or the dealer from whom it was obtained within ninety (90) days of the date of payment of the license fee. NEITHER EXTREME NOR ITS AFFILIATES MAKE ANY OTHER WARRANTY OR REPRESENTATION, EXPRESS OR IMPLIED, WITH RESPECT TO THE LICENSED MATERIALS, WHICH ARE LICENSED "AS IS". THE LIMITED WARRANTY AND REMEDY PROVIDED ABOVE ARE EXCLUSIVE AND IN LIEU OF ALL OTHER WARRANTIES, INCLUDING IMPLIED WARRANTIES OF MERCHANTABILITY OR FITNESS FOR A PARTICULAR PURPOSE, WHICH ARE EXPRESSLY DISCLAIMED, AND STATEMENTS OR REPRESENTATIONS MADE BY ANY OTHER PERSON OR FIRM ARE VOID. ONLY TO THE EXTENT SUCH EXCLUSION OF ANY IMPLIED WARRANTY IS NOT PERMITTED BY LAW, THE DURATION OF SUCH IMPLIED WARRANTY IS LIMITED TO THE DURATION OF THE LIMITED WARRANTY SET FORTH ABOVE. YOU ASSUME ALL RISK AS TO THE QUALITY, FUNCTION AND PERFORMANCE OF THE LICENSED MATERIALS. IN NO EVENT WILL EXTREME OR ANY OTHER PARTY WHO HAS BEEN INVOLVED IN THE CREATION, PRODUCTION OR DELIVERY OF THE LICENSED MATERIALS BE LIABLE FOR SPECIAL, DIRECT, INDIRECT, RELIANCE, INCIDENTAL OR CONSEQUENTIAL DAMAGES, INCLUDING LOSS OF DATA OR PROFITS OR FOR INABILITY TO USE THE LICENSED MATERIALS, TO ANY PARTY EVEN IF EXTREME OR SUCH OTHER PARTY HAS BEEN ADVISED OF THE POSSIBILITY OF SUCH DAMAGES. IN NO EVENT SHALL EXTREME OR SUCH OTHER PARTY'S LIABILITY FOR ANY DAMAGES OR LOSS TO YOU OR ANY OTHER PARTY EXCEED THE LICENSE FEE YOU PAID FOR THE LICENSED MATERIALS.

Some states do not allow limitations on how long an implied warranty lasts and some states do not allow the exclusion or limitation of incidental or consequential damages, so the above limitation and exclusion may not apply to You. This limited warranty gives You specific legal rights, and You may also have other rights which vary from state to state.

14. JURISDICTION. The rights and obligations of the parties to this Agreement shall be governed and construed in accordance with the laws and in the State and Federal courts of the State of California, without regard to its rules with respect to choice of law. You waive any objections to the personal jurisdiction and venue of such courts.

---

None of the 1980 United Nations Convention on the Limitation Period in the International Sale of Goods, and the Uniform Computer Information Transactions Act shall apply to this Agreement.

15. GENERAL.

- a. This Agreement is the entire agreement between Extreme and You regarding the Licensed Materials, and all prior agreements, representations, statements, and undertakings, oral or written, are hereby expressly superseded and canceled.
- b. This Agreement may not be changed or amended except in writing signed by both parties hereto.
- c. You represent that You have full right and/or authorization to enter into this Agreement.
- d. This Agreement shall not be assignable by You without the express written consent of Extreme. The rights of Extreme and Your obligations under this Agreement shall inure to the benefit of Extreme's assignees, licensors, and licensees.
- e. Section headings are for convenience only and shall not be considered in the interpretation of this Agreement.
- f. The provisions of the Agreement are severable and if any one or more of the provisions hereof are judicially determined to be illegal or otherwise unenforceable, in whole or in part, the remaining provisions of this Agreement shall nevertheless be binding on and enforceable by and between the parties hereto.
- g. Extreme's waiver of any right shall not constitute waiver of that right in future. This Agreement constitutes the entire understanding between the parties with respect to the subject matter hereof, and all prior agreements, representations, statements and undertakings, oral or written, are hereby expressly superseded and canceled. No purchase order shall supersede this Agreement.
- h. Should You have any questions regarding this Agreement, You may contact Extreme at the address set forth below. Any notice or other communication to be sent to Extreme must be mailed by certified mail to the following address:

Extreme Networks, Inc.  
145 Rio Robles  
San Jose, CA 95134 United States  
ATTN: General Counsel

---

# Table of Contents

---

Legal Notices .....	2
Trademarks .....	2
Contact .....	2
Extreme Networks® Software License Agreement .....	4
Table of Contents .....	11
ExtremeControl Help .....	38
Document Version .....	38
<b>Control .....</b>	<b>39</b>
Access Requirements .....	39
Navigating the Control Tab .....	39
Dashboard .....	40
Policy .....	40
Access Control .....	40
End-Systems .....	41
Reports .....	41
Policy .....	42
Understanding Policy Domains .....	44
Understanding Roles .....	46
Role Summary Column .....	47
Understanding Services .....	47
Working with Service Groups .....	49
Understanding Traffic Classification Rules .....	50
Adding Devices .....	51

---

---

Viewing Port Configuration Information .....	51
Working with Port Groups .....	52
Working with VLANS .....	52
Viewing Classes of Service .....	53
Saving the Domain .....	54
Enforcing .....	54
Enforce Preview .....	55
Rule Counts Reported by Devices .....	55
Verifying .....	56
AP Aware .....	56
Policy Configuration Considerations .....	57
General Considerations .....	58
Authenticating without Policy .....	58
Terminating Role Override Sessions .....	59
Port-Level MAC to Role Mappings .....	59
Import From Device .....	59
Flood Control .....	59
C1 Considerations .....	60
Policy Support .....	60
Rule Limits .....	61
N-Series Considerations .....	61
Role Precedence for the N-Series Platinum .....	61
C2 and B2 Considerations .....	62
C3 and B3 Considerations .....	62
Mixed-Stack C2/C3 and B2/B3 Considerations .....	63

---

---

7100 Considerations .....	64
Extreme Access Control Controller Configuration .....	64
Extreme Access Control Controllers Require Separate Domains .....	65
Modifying Extreme Access Control Controllers Preconfigured Policy	65
Modifying the Downstream Default Policy .....	65
Configuring LAG on Extreme Access Control Controllers .....	65
Configuring LAG on Layer 3 Extreme Access Control Controllers - Upstream Ports .....	66
Configuring LAG on Layer 3 Extreme Access Control Controllers - Downstream Ports .....	66
Configuring LAG on Layer 2 Extreme Access Control Controllers - Upstream Ports .....	66
Configuring LAG on Layer 2 Extreme Access Control Controllers - Downstream Ports .....	66
ExtremeWireless Controller Configuration .....	67
Version Supported .....	67
Policy Rules .....	67
Supported Rule Types .....	67
"No Change" Filter Sets .....	68
Rule Actions .....	68
Rule Directions .....	68
Rule Limits .....	69
Role Default Actions .....	69
Class of Service .....	69
Rate Limits .....	70
Internal VLAN .....	70
Policy Inheritance .....	71

---

Configuring RADIUS Servers .....	71
Other Considerations .....	72
<b>Extreme Management Center™ Policy Help .....</b>	<b>73</b>
Policy Tab Overview .....	73
Extreme Management Center Details View .....	74
Extreme Management Center General .....	74
Policy Menus .....	74
Open/Manage Domains Menu .....	75
Global Domain Settings Menu .....	76
Tools Menu .....	77
<b>Extreme Management Center Enforce Preview Window .....</b>	<b>78</b>
Left Panel .....	79
Right Panel .....	79
Import from Domain .....	84
Data Elements to Import .....	85
Application of Imported Data Elements .....	87
Import from File .....	89
Data Elements to Import .....	89
Global Domain Data .....	92
Application of Imported Data Elements .....	92
Assign Devices to Domain .....	94
<b>Extreme Management Center Authentication Configuration .....</b>	<b>97</b>
Device Selection .....	97
Port Selection .....	98
Device Configuration .....	98

---

---

Authentication Status .....	98
Global Authentication Settings .....	100
MAC Authentication Settings .....	100
Web Authentication Settings .....	101
General .....	101
Guest Networking .....	103
Web Page Banner .....	104
Convergence End-Point Settings .....	105
CEP Role Mappings .....	106
CEP Detection Tab .....	106
Port Configuration .....	108
Authentication Mode .....	109
Port Mode .....	109
RFC3580 VLAN Authorization Tab .....	111
Login Settings .....	112
Automatic Re-Authentication .....	114
Authenticated User Counts .....	115
Convergence End-Point Access .....	116
Policy Main Window .....	117
Dialog Boxes (Messages) .....	118
Icons .....	118
Open/Manage Domain Menu Icons .....	119
Policy Windows .....	120
Policy Concepts .....	120
Policy .....	121

---

---

Role .....	121
What is a Role .....	121
Default Role .....	121
Policy Domains .....	121
Service .....	123
Rule .....	123
What is a Rule .....	123
Disabling Rules .....	124
Conflict Checking .....	124
Packet Tagging .....	125
VLAN to Role Mapping .....	126
Dynamic Egress .....	127
Setting Domain GVRP Status .....	130
Policy VLAN Islands .....	131
Traffic Mirroring .....	131
Port Groups .....	132
User-Defined Port Groups .....	133
Network Resource Groups .....	133
Network Resource Topologies .....	133
Verifying .....	134
Enforcing .....	134
Controlling Client Interactions with Locks .....	135
Extreme Management Center Policy Tab Right-Panel .....	137
Policy Left Panel .....	137
Roles/Services Tab .....	138



---

Roles Tree .....	138
Service Repository Tree .....	139
Class of Service Tab .....	140
VLAN Tab .....	142
Network Resources Configuration .....	143
Devices/Port Groups Tab .....	145
Devices Tree .....	145
Extreme Management Center Summary (Roles) .....	146
Extreme Management Center General (Role) .....	147
Default Actions .....	148
Services .....	150
Extreme Management Center VLAN Egress (Role) .....	151
Add Egress VLAN Window .....	152
Extreme Management Center Mappings (Role) .....	153
MAC to Role Mapping .....	154
IP to Role Mapping .....	154
Tagged Packet VLAN to Role Mapping .....	155
Authentication-Based VLAN to Role Mapping .....	155
Add/Remove Services (Roles) .....	155
Extreme Management Center Details View (Service) .....	157
<b>Extreme Management Center Service Repository .....</b>	<b>162</b>
<b>Extreme Management Center Local/Global Services .....</b>	<b>163</b>
Extreme Management Center Details View (Services) .....	164
Extreme Management Center Details View (Service Group) .....	165
Add/Remove Services (Service Groups) .....	166

---

---

Extreme Management Center Rule .....	167
General Area .....	168
Traffic Description Area .....	169
Actions Area .....	170
Create Rule .....	173
Edit Rule .....	174
Layer Area .....	175
Value Area .....	175
Class of Service Overview .....	176
Getting Started with Class of Service .....	177
Class of Service Overview .....	178
Implementing CoS .....	179
Configuring CoS .....	179
Rate Limits .....	180
Transmit Queues .....	181
Flood Control .....	183
Extreme Management Center Class of Service .....	183
General .....	184
Rate Limiting/Rate Shaping .....	185
Index Numbers .....	186
Extreme Management Center General (CoS Components Folder) .....	188
General (Rate Limits) .....	189
Extreme Management Center Details View (Rate Limits Folder) .....	191
<b>Extreme Management Center Priority-Based Rate Limits .....</b>	<b>192</b>
Add/Edit CoS to Rate Limit Mapping .....	193

---

Advanced Rate Limiting by Port Type .....	195
Configuring Rate Limit Mappings .....	196
Associating Rate Limits with a Class of Service .....	196
Extreme Management Center Summary (Rate Limit Port Groups Folder) .	197
Extreme Management Center CoS - Rate Limit Mappings (Rate Limit Port Group) .....	198
Extreme Management Center Ports (Rate Limit Port Group) .....	201
Extreme Management Center Automated Service .....	203
Traffic Description Area .....	205
Actions Area .....	205
Traffic Classification Rules .....	208
Traffic Descriptions .....	209
Actions .....	210
VLAN Membership (Access Control) .....	210
Priority (Class of Service) .....	210
Classification Types and their Parameters .....	211
Layer 2 -- Data Link Classification Types .....	211
Layer 3 -- Network Classification Types .....	213
Layer 4 -- Application Transport Classification Types .....	221
Layer 7 -- Application Classification Types .....	224
Examples of How Rules are Used .....	225
Traffic Containment .....	225
Traffic Filtering .....	226
Traffic Security .....	227
Traffic Prioritization .....	227
Extreme Management Center Ports (Transmit Queue Port Group) .....	229

---

Extreme Management Center Summary (Transmit Queue Port Groups) ...	231
Extreme Management Center CoS - Transmit Queue Mappings (Transmit Queue Port Group) .....	232
Extreme Management Center Ports (Flood Control Port Groups) .....	234
<b>Extreme Management Center Flood Control Port Groups .....</b>	<b>237</b>
Extreme Management Center Flood Control Rate Limits (Flood Control Port Groups) .....	238
Class of Service Example .....	239
Configure the Classes of Service .....	242
Create the VoIP Core Role .....	242
Create a VoIP Core Service .....	242
Create a Rule .....	242
Creating the VoIP Edge Role .....	243
Create a VoIP Edge Service .....	243
Create a Rule .....	243
Creating the H.323 Call Setup Role .....	243
Create a H.323 Call Setup Service .....	243
Create a Rule .....	243
Apply the Roles to Network Devices .....	244
ToS/DSCP Value Definition Chart .....	244
Policy VLAN Tab Overview .....	245
General .....	246
Authentication-Based VLAN to Role Mapping .....	247
Tagged Packet VLAN to Role Mapping .....	247
Global VLANs .....	249
Create VLAN .....	250

---

Editing an existing VLAN/Class of Service .....	251
Selection View (Roles) .....	251
Policy VLAN Islands .....	252
(VLANs) - VIDs Tab .....	253
(VLANs) - Role Mappings Tab .....	254
General .....	254
Authentication-Based VLAN to Role Mapping .....	255
Tagged Packet VLAN to Role Mapping .....	255
Add Devices (VLAN Islands) .....	257
Extreme Management Center Island Topology (Policy VLAN Islands) .....	258
(Island) - VIDs Tab .....	258
(Island) - Devices Tab .....	260
Extreme Management Center Packet Flow Diagram .....	261
Extreme Management Center Network Resources Tab Overview .....	262
Extreme Management Center Network Resource Group General Tab .....	263
Extreme Management Center Network Resource Topology Tab .....	264
Extreme Management Center Network Resource Topology Island Domain Wide .....	265
<b>Extreme Management Center Details View (Network Resource Topologies Folder) .....</b>	<b>267</b>
Extreme Management Center Devices (Devices) .....	268
Extreme Management Center User Sessions (Devices) .....	269
User Sessions Tab .....	269
<b>Extreme Management Center Authentication (Device) .....</b>	<b>274</b>
Authentication Status .....	274
Current User Counts .....	276

---



---

Global Authentication Settings .....	277
MAC Authentication Settings .....	277
Web Authentication Settings .....	278
General .....	278
Guest Networking .....	280
Web Page Banner .....	282
Convergence End-Point Settings .....	282
CEP Role Mappings .....	283
CEP Detection Tab .....	283
<b>Extreme Management Center Add/Edit CEP Detection Rule .....</b>	<b>286</b>
CEP Detection Settings .....	287
<b>Extreme Management Center Ports (Authentication) .....</b>	<b>288</b>
Authentication Mode .....	289
RFC3580 VLAN Authorization .....	290
Login Settings .....	291
MAC .....	292
802.1X .....	292
Web Auth .....	293
Quarantine .....	293
Auto Tracking .....	294
Automatic Re-Authentication .....	294
Authenticated User Counts .....	295
Convergence End-Point Access .....	296
<b>Extreme Management Center RADIUS (Device) .....</b>	<b>298</b>
Authentication Tab .....	299

---

RADIUS Authentication Client Settings .....	299
Authentication RADIUS Server(s) Table .....	301
Accounting Tab .....	303
RADIUS Accounting Client Settings .....	304
Accounting RADIUS Servers Table .....	305
<b>RADIUS Authentication (Device) .....</b>	<b>308</b>
RADIUS Authentication Client Settings .....	308
Authentication RADIUS Server(s) Table .....	310
<b>Extreme Management Center RADIUS Authentication (Devices) .....</b>	<b>314</b>
<b>Extreme Management Center RADIUS Accounting (Device) .....</b>	<b>316</b>
RADIUS Accounting Client Settings .....	317
Accounting RADIUS Servers Table .....	318
<b>Extreme Management Center RADIUS Accounting (Devices) .....</b>	<b>321</b>
<b>Extreme Management Center Add/Edit RADIUS Server .....</b>	<b>323</b>
<b>Extreme Management Center Add RADIUS Accounting Server .....</b>	<b>326</b>
Extreme Management Center Ports (Device) .....	328
<b>Extreme Management Center Ports (Port Group) .....</b>	<b>331</b>
Extreme Management Center Details View (Port Groups) .....	332
Extreme Management Center Add/Remove Ports (User-Defined Port Groups) .....	333
Add/Remove Ports .....	334
<b>Extreme Management Center Port Authentication Configuration .....</b>	<b>337</b>
Authentication Mode .....	337
Port Mode .....	337
RFC3580 VLAN Authorization Tab .....	339
Login Settings .....	340

---

---

Automatic Re-Authentication .....	342
Authenticated User Counts .....	343
Convergence End-Point Access .....	344
How To Use Extreme Management Center Policy .....	346
How to Select on Add/Remove Windows .....	346
Selecting single items .....	346
Selecting multiple sequential items .....	346
Selecting multiple non-sequential items .....	347
How to Create and Use Domains .....	347
Creating a New Domain .....	348
Opening a Domain .....	348
Assigning Devices to a Domain .....	349
Removing Devices From a Domain .....	349
Importing a File into a Domain .....	350
Exporting a Domain to a File .....	351
Importing Data from a Domain .....	351
Saving a Domain .....	351
Renaming a Domain .....	352
Deleting a Domain .....	352
How to Create a Role .....	352
Using the Role Tabs .....	353
Modifying a Role .....	354
Adding Services to Roles .....	354
Removing Services from a Role .....	355
Modifying a Role's Default Class of Service .....	355



---



---

Modifying a Role's Default Access Control .....	355
Modifying a Role's Description .....	355
Modifying a Role's Ports .....	356
Mapping a Role to an HTTP Redirect Group .....	356
Deleting a Role .....	356
How to Assign a Default Role to a Port .....	357
Assigning and Clearing a Default Role .....	357
Assigning Default Roles to Ports .....	357
Clearing Default Roles from Ports .....	357
How to Create a Quarantine Role .....	358
Modifying the Quarantine Role .....	359
Modifying Default Values .....	359
Adding/Removing Services .....	359
Setting the Quarantine Role as the Default Role on a Port .....	360
How to Create a Service .....	360
Using the Service Tabs .....	361
Creating an Automated Service .....	361
Creating a Manual Service .....	362
Modifying a Service .....	362
Modifying a Service Description .....	363
Modifying a Service Name .....	363
Modifying the Roles for a Service .....	363
Adding a Service to Roles .....	364
Modifying the Rules for a Manual Service .....	364
Modifying an Automated Service .....	364

---

Deleting a Service .....	365
How to Create a Service Group .....	366
Creating a Service Group .....	366
Adding Services to a Service Group .....	366
Removing Services from a Service Group .....	367
How to Create or Modify a Rule .....	367
Creating a Rule .....	368
Disabling/Enabling a Rule .....	368
Deleting a Rule .....	369
How to Define Rate Limits .....	370
Defining Rate Limits .....	370
Removing a Rate Limit .....	371
How to Create a Class of Service .....	372
Creating a Class of Service .....	373
Creating Class of Service Port Groups .....	374
Deleting a Class of Service .....	375
How to Configure Transmit Queues .....	376
Transmit Queue Configuration .....	376
Transmit Queue Rate Shapers .....	377
How to Define Traffic Descriptions .....	377
How to Configure Flood Control .....	378
h gwHow to Create a VLAN .....	380
Creating a VLAN .....	381
Editing an Island VLAN ID .....	381
Deleting a VLAN .....	382

---

---

How to Create a Policy VLAN Island .....	382
Creating a VLAN Island .....	383
Modifying a VLAN Island .....	383
Deleting a VLAN Island .....	383
How to Create a Network Resource .....	384
How to Add and Delete Devices .....	386
Using Console to Discover Devices .....	387
Using Console to Import Devices .....	387
Deleting Devices from the Database .....	388
How to Create a Port Group .....	388
Creating a Port Group .....	389
Adding Ports to a Port Group .....	389
Removing Ports from a Port Group .....	389
Extreme Access Control .....	390
Extreme Access Control Engine Groups .....	390
All Extreme Access Control Engines .....	391
Extreme Access Control Configurations .....	391
Extreme Access Control Configuration Considerations .....	392
Extreme Access Control Configuration Tables .....	392
General Considerations .....	395
Considerations When Implementing Policy Roles .....	400
ExtremeWireless Controller Configuration .....	401
DNS Proxy Functionality for Registration and Remediation .....	402
Basic Operation .....	402
Backup DNS Server .....	403

---

---

Troubleshooting .....	403
How to Update an Extreme Access Control License .....	404
How to Install the Assessment Agent Adapter on a Nessus Server .....	406
How to Deploy Extreme Access Control in an MSP or MSSP Environment .	409
Configuring Extreme Management Center Behind a NAT Router .....	409
Defining Interface Services .....	410
Access Control Concepts .....	411
Overview of the Access Control Tab .....	411
Extreme Access Control Engines .....	412
Use Scenario .....	413
Extreme Access Control VPN Deployment .....	416
Access Control Tab Structure .....	417
Extreme Access Control Configuration .....	417
Rule Components .....	418
Extreme Access Control Profiles .....	418
AAA Configurations .....	419
Portal Configurations .....	419
Access Policies .....	420
Registration .....	422
How Registration Works .....	424
Assessment .....	424
Assessment Remediation .....	427
How Remediation Works .....	428
End-System Zones .....	429
End-System Zone Use Cases .....	430

---

---

Enforcing .....	431
Advanced Enforce Options .....	432
Notifications .....	433
<b>Access Control Configuration .....</b>	<b>434</b>
Access Control Configurations .....	434
<b>Extreme Access Control Configuration Rules .....</b>	<b>435</b>
Accessing Extreme Access Control Configuration Rules .....	435
Viewing Rules in the Table .....	435
Creating and Editing Rules .....	437
<b>Add/Edit Rule .....</b>	<b>439</b>
<b>Add/Edit User to Authentication Mapping .....</b>	<b>443</b>
<b>AAA Configurations .....</b>	<b>446</b>
<b>AAA Configurations .....</b>	<b>448</b>
Accessing the AAA Configuration .....	448
Basic AAA Configuration .....	449
Advanced AAA Configuration .....	450
<b>Manage LDAP Configurations .....</b>	<b>454</b>
Add LDAP Configuration Window .....	456
Edit LDAP Configuration Window .....	461
<b>Manage RADIUS Servers .....</b>	<b>466</b>
Add/Edit RADIUS Server .....	468
<b>Manage RADIUS Attribute Configurations Window .....</b>	<b>471</b>
<b>Advanced RADIUS Server Configuration .....</b>	<b>473</b>
Health Check Section .....	474
<b>Policy Mapping Configuration .....</b>	<b>476</b>

---

Column Definitions .....	477
<b>Add/Edit Policy Mapping .....</b>	<b>480</b>
<b>Access Control Profiles .....</b>	<b>484</b>
<b>New/Edit Extreme Access Control Profile .....</b>	<b>487</b>
Authorization .....	488
Assessment .....	490
<b>Edit Assessment Configuration .....</b>	<b>492</b>
<b>Manage Assessment Settings .....</b>	<b>495</b>
<b>Portal Configuration Overview .....</b>	<b>497</b>
Accessing the Portal Configuration .....	497
Network Settings .....	497
Administration .....	497
Look and Feel .....	497
Guest Access and Registration .....	498
Authenticated Web Access .....	498
Authenticated Registration .....	498
Assessment / Remediation .....	499
Website Configuration .....	499
Portal Configuration Network Settings .....	499
Portal Configuration Administration .....	502
Administration .....	502
Administration Web Page Settings .....	503
Portal Configuration Website Configuration .....	504
Portal Configuration Look and Feel .....	505
<b>Portal Configuration Authenticated Access and Registration .....</b>	<b>511</b>

---

Authenticated Web Access .....	511
Authentication .....	513
Redirection .....	513
Web Access Settings .....	514
Authenticated Registration .....	514
Authentication .....	516
Redirection .....	517
Registration Settings .....	517
<b>Portal Configuration Guest Access .....</b>	<b>520</b>
Registration Settings .....	521
Secure Guest Access .....	523
Secure Access Settings .....	525
Sponsorship .....	527
<b>Portal Configuration Assessment / Remediation .....</b>	<b>528</b>
Web Page Settings .....	530
Remediation Attempt Limits .....	532
Remediation Links .....	532
Custom Remediation Actions .....	533
Portal Web Page URLs .....	534
<b>Portal Configuration Guest Registration .....</b>	<b>535</b>
Registration Settings .....	537
Sponsorship .....	539
Portal Web Page URLs .....	539
Portal Configuration Provider Registration .....	540
Facebook Registration .....	541

---

Google Registration .....	542
Microsoft Registration .....	542
Yahoo Registration .....	543
Salesforce Registration .....	543
Provider Registration (Generic) .....	544
<b>Portal Configurations .....</b>	<b>545</b>
<b>Manage Custom Fields .....</b>	<b>546</b>
Keywords .....	549
Keyword Definitions .....	549
<b>Allowed Web Sites .....</b>	<b>558</b>
Allowed URLs .....	558
Allowed Domains .....	559
Web Proxy Servers .....	561
<b>Message Strings Editor .....</b>	<b>563</b>
Extreme Access Control Engine Groups .....	564
<b>Group Editor .....</b>	<b>566</b>
<b>Add/Edit Device Type Group .....</b>	<b>569</b>
End-Systems .....	571
End-Systems .....	572
Actions .....	576
Menu Buttons .....	577
End-System Events Tab .....	577
<b>Add/Edit End-System Group .....</b>	<b>582</b>
<b>End-System Details .....</b>	<b>585</b>
Access Profile Tab .....	585



---

End-System Tab .....	587
End-System Events Tab .....	588
Health Results Tab .....	590
Health Results .....	590
Health Result Details .....	592
Buttons and Paging Toolbar .....	594
<b>Add/Edit Location Group .....</b>	<b>596</b>
<b>Add/Edit User Group .....</b>	<b>599</b>
<b>Add/Edit User Group Window .....</b>	<b>602</b>
Switches .....	603
Edit Switches in Extreme Access Control Engine Group .....	607
Add Switches to Extreme Access Control Engine Group .....	611
Add Switches to Extreme Access Control Engine Group .....	616
Advanced Switch Settings .....	621
All Access Control Engines .....	623
<b>Engine Settings Window .....</b>	<b>626</b>
Credentials .....	626
Switch Configuration .....	627
Web Service Credentials .....	628
Extreme Access Control Admin Web Page .....	629
EAP-TLS Configuration .....	629
Network Settings .....	630
Manage DNS Configuration .....	630
Manage NTP Configuration .....	630
Manage SSH Configuration .....	631

---

SNMP Configuration .....	633
Auditing .....	634
Details (Extreme Access Control Engine) .....	635
Details (Extreme Access Control Engine Groups) .....	638
<b>Interface Configuration Window .....</b>	<b>641</b>
Interface Modes .....	641
Services .....	643
DHCP/Kerberos Snooping .....	644
Captive Portal HTTP Mirroring .....	644
Tagged VLANs .....	644
<b>Static Route Configuration Window .....</b>	<b>645</b>
<b>How To Use Access Control .....</b>	<b>646</b>
<b>How to Use Device Type Profiling .....</b>	<b>647</b>
Device Profiling Use Case .....	647
<b>How to Configure LDAP for End Users and Hosts via Active Directory in Extreme Management Center .....</b>	<b>656</b>
<b>How to Change the Assessment Agent Adapter Password .....</b>	<b>667</b>
<b>How to Set Extreme Access Control Options .....</b>	<b>669</b>
Advanced Settings .....	669
Assessment Server .....	670
Data Persistence .....	671
End-System Event Cache .....	673
Enforce Warning Settings .....	674
Setting Features Options .....	674
Notification Engine Options .....	674
Policy Defaults .....	675

---

Status Polling and Timeout .....	676
<b>How to Configure Pre-Registration .....</b>	<b>678</b>
Configuring Pre-Registration .....	678
Pre-Registering Guest Users .....	683
Pre-Registering a Single User .....	684
Pre-Registering Multiple Users .....	685
<b>How to Enable RADIUS Accounting .....</b>	<b>689</b>
Considerations for Fixed Switching Devices .....	691
Considerations for ExtremeXOS Devices .....	692
<b>How to Set Up Access Policies and Policy Mappings .....</b>	<b>693</b>
Setting Up Your Access Policies .....	695
<b>How to Configure Credential Delivery for Secure Guest Access .....</b>	<b>700</b>
Configuration Steps .....	700
How Secure Guest Access Works .....	707
<b>How to Configure Verification for Guest Registration .....</b>	<b>711</b>
Configuration Steps .....	711
How User Verification Works .....	715
<b>How to Configure Sponsorship for Guest Registration .....</b>	<b>718</b>
<b>How to Implement Facebook Registration .....</b>	<b>721</b>
Requirements .....	721
Creating a Facebook Application .....	722
Portal Configuration .....	728
How Facebook Registration Works .....	730
Special Deployment Considerations .....	730
Wireless Clients .....	730

---

---

Networks using DNS Proxy .....	731
<b>How to Implement Google Registration .....</b>	<b>732</b>
Requirements .....	732
Creating a Google Application .....	733
Portal Configuration .....	737
How Google Registration Works .....	739
Special Deployment Considerations .....	739
Networks using DNS Proxy .....	739
<b>How to Implement Microsoft Registration .....</b>	<b>741</b>
Requirements .....	741
Creating a Microsoft Application .....	742
Portal Configuration .....	747
How Microsoft Registration Works .....	748
Special Deployment Considerations .....	748
Networks using DNS Proxy .....	749
<b>How to Implement Yahoo Registration .....</b>	<b>750</b>
Requirements .....	750
Creating a Yahoo Application .....	751
Portal Configuration .....	753
How Yahoo Registration Works .....	755
Special Deployment Considerations .....	755
Networks using DNS Proxy .....	755
<b>How to Implement Salesforce Registration .....</b>	<b>757</b>
Requirements .....	757
Creating a Salesforce Application .....	758

---

---

Portal Configuration .....	766
How Salesforce Registration Works .....	767
Special Deployment Considerations .....	767
Networks using DNS Proxy .....	768
End-Systems .....	768
End-Systems .....	769
Actions .....	773
Menu Buttons .....	775
End-System Events Tab .....	775
<b>Add/Edit MAC Lock .....</b>	<b>780</b>

# ExtremeControl Help

---

## Document Version

The following table displays the revision history for the ExtremeControl Help documentation.

Date	Revision Number	Description
6-18	8.1 Revision -01	Extreme Management Center 8.1 release

PN: 9035440

## Control

Extreme Management Center's **Control** tab provides end-system and user identity reports and control capabilities, allowing better visibility and control for IT analysts, troubleshooters, and the helpdesk.

Additionally, the Legacy menu in the **Control** tab menu provides access to the following Java-based legacy applications:

- [NAC Manager](#)
- [Policy Manager](#)

## Access Requirements

To view the reports in the **Control** tab, you must be a member of an authorization group that has been assigned the appropriate capabilities:

- Extreme Management Center (NetSight) OneView > Access OneView
- Extreme Management Center (NetSight) OneView > Extreme Access Control > Access OneView Identity and Access Reports
- Extreme Management Center (NetSight) OneView > Extreme Access Control > OneView End-Systems Read Access or Read/Write Access

## Navigating the Control Tab

Clicking on **Control** in the Menu Bar at the top of Extreme Management Center opens the **Control** tab. The **Control** tab provides access to four sub-tabs:

- [Dashboard](#) — Displays summary Extreme Management Center data including end-system data, system-level information, system events, Access Control engine information, and network health.
- [Policy](#) — Enables you to create policy profiles, called roles, assigned to the ports in your network.
- [Access Control](#) — Allows you to configure how end-users connect to your network.
- [End-Systems](#) — Displays information about end-users connected to your network.
- [Reports](#) — Provides a variety of system reports that give information about your devices, ports, and network traffic.

Additionally, the [Menu icon \(☰\) at the top of the screen](#) provides links to additional information about your version of Extreme Management Center.

## Dashboard

Select the **Dashboard** tab to view information about engines and end-systems.

### Overview

Provides an overview of end-system connection information. For a description of each report, click the **Info** button  in the upper right corner of the view. Enable and disable data display in each chart by clicking on the data set in the chart legend. For example, if one segment represents a disproportionately large percentage of the total, mouse over the segment legend to the right of the chart and click on it to remove it from the pie chart.

### System

Provides system-level information for engines and end-systems. For a description of each report, click the **Info** button  in the upper right corner of the view.

### Health

Provides reports on end-system assessment and state information. For a description of each report, click the **Info** button  in the upper right corner of the view.

### Data Center

The Data Center reports provide an overview of all virtual machines on the network broken down into VM distribution per Extreme Access Control profile, Operating System, Switch, and Hypervisor technology. They also provide table reports with detailed information on all VMs. For each supported Hypervisor technology, sub-reports provide more in-depth data.

## Policy

Clicking the [Policy tab](#) lets you create [policies](#) for your network. It allows you to create policies for users and ports, enabling network engineers, information technology administrators, and business managers to work together to create the appropriate network experience for each user in their organization.

## Access Control

The [Access Control tab](#) lets you manage the end user connection experience and control network access based on a variety of criteria including



authentication, user name, MAC address, time of day, and location. The **Access Control** tab comes with a default Extreme Access Control Configuration which is automatically assigned to your Extreme Access Control engine. You can use this default configuration as is, or make changes to the default configuration, if desired.

## End-Systems

Clicking the [End-Systems tab](#) displays end-system connection information, and lets you monitor end-system events and view the health results from an end-system's assessment. Double-click on any row in the table to open a browser window that displays [End-System Details](#).

## Reports

The **Reports** tab allows you to view information about the end-systems connecting to your network, Extreme Access Control authentication information, and the top services and roles based on policy rules. Available reports are accessible via the **Reports** drop-down menu at the top of the tab and are grouped into the following reporting areas:

- End-Systems
- Access Control
- Access Control – Health
- Policy

---

## Related Information

For information on related topics:

- [Administration](#)
- [Network](#)
- [Alarms and Events](#)
- [Reports](#)
- [Search](#)

## Policy

---

The **Policy** tab, contained in the **Control** tab of Extreme Management Center is a configuration tool that simplifies the creation and enforcement of policies on networks, enabling network engineers, information technology administrators, and business managers to work together to create the appropriate network experience for each user in their organization.

The **Policy** tab enables you to create policy profiles, called roles, which are assigned to the ports in your network. These roles are based on the existing business functions in your company and consist of services that you create, made up of traffic classification rules. Roles provide four key policy features: traffic containment, traffic filtering, traffic security, and traffic prioritization.

Use the following summary to guide you through the basic steps for using the **Policy** tab.

1. Create your Policy Domains (see [How to Create and Use Domains.](#))
2. [Add your devices](#) to the Extreme Management Center Database and assign them to the appropriate domain.
3. If desired, group your ports into port groups (see [How to Create a Port Group](#)).
4. Create services (see [How to Create a Service](#)).
5. If desired, group services into service groups (see [How to Create a Service Group](#)).
6. Create roles (see [How to Create a Role](#)).
7. Write your configuration to your devices (see [Enforcing](#)).

The illustration below shows the **Policy** tab relationship hierarchy, with Rules at the base to define specific packet handling behaviors, Roles at the top to identify specific job functions in the organization, and Services in the middle, providing the interface between the two layers.

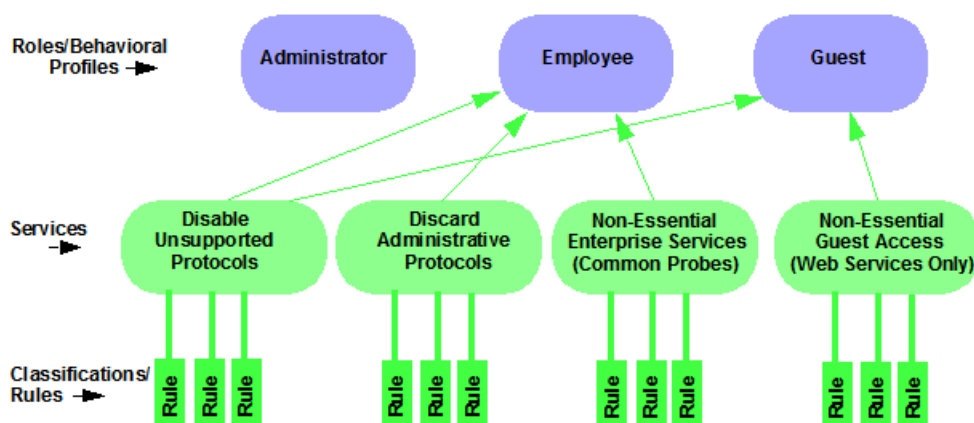

Using policy configuration tools, you can create multiple roles tailored to your specific needs and set a default policy for some or all of your network devices and ports. These policies can be deployed on multiple devices throughout your switch fabric.

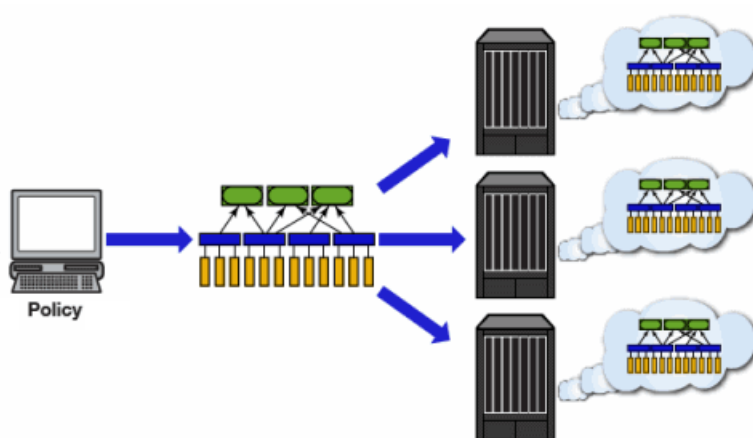

The topic covers the following features:

- [Understanding Policy Domains](#)
- [Understanding Roles](#)
- [Understanding Services](#)
- [Working with Service Groups](#)
- [Understanding Traffic Classification Rules](#)
- [Adding Devices](#)
- [Viewing Port Configuration Information](#)

- [Working with Port Groups](#)
- [Working with VLANs](#)
- [Viewing Classes of Service](#)
- [Saving the Domain](#)
- [Enforcing](#)
- [Verifying](#)
- [AP Aware](#)

## Understanding Policy Domains

The **Policy** tab provides the ability to create multiple policy configurations by allowing you to group your roles and devices into Policy Domains. A Policy Domain contains any number of roles and a set of devices that are uniquely assigned to that particular domain. Policy Domains are centrally managed in the database and shared between **Policy** tab clients.

The first time you launch the **Policy** tab, you are in the Default Policy Domain. You can manage your entire network in the Default Policy Domain, or you can create multiple domains each with a different policy configuration, and assign your network devices to the appropriate domain. The Default Policy Domain is pre-configured with roles and rules. The roles, services, rules, VLAN membership, and class of service in this initial configuration define a suggested implementation of how network traffic can be handled. This is a starting point for a new policy deployment and often needs customization to fully leverage the power of a policy-enabled network.

For more information about domains, see [Policy Domains](#) in the Concepts Help topic.

In the Quick Tour, we'll use the Default Policy Domain as a way to explore the basic features and functionality of the **Policy** tab. Later, you may find the Default Policy Domain useful as you create your own Policy Domains.

If you have just launched the **Policy** tab for the first time, you are in the Default Policy Domain and you can proceed to the next step, [Understanding Roles](#). If someone else has been using the **Policy** tab before you, use the following steps to create a demonstration domain you can use for the Quick Tour.

---

**NOTE:** If someone uses the **Policy** tab before you, you may be prompted to save the previous domain's configuration when you create the new domain. Save the previous domain's configuration if you are going to use that configuration in the future.

---

To create a policy domain:

1. Select **Open/Manage Domains > Create Domain**. Enter the domain name **Demonstration Domain** for the new domain and click **OK**. The new Demonstration Domain opens.
2. Select **Open/Manage Domains > Assign Devices to Domain**. Select the devices to add to the Domain and click **OK**. The device is added to the left-panel **Devices** tab.
3. Click on the left-panel **Roles/Services** tab. Right-click on **Roles**, **Services**, or **Service Groups** and select **Create Role**, **Create Services**, or **Create Service Groups**, respectively to create a role, service, or service group for the domain. For additional information on creating a role, service group, or service, see [How to Create a Role](#), [How to Create a Service](#), or [How to Create a Service Group](#).
4. Click on the left-panel **Class of Service** tab. Right-click on **Class of Service** and select **Create COS** to create a class of service for the domain. For more information on creating a class of service, see [How to Create a Class of Service](#).
5. Click on the left-panel **VLANs** tab. Right-click on **Global VLANs** and select **Create VLAN** for the domain. For more information on creating VLANs, see [How to Create a VLAN](#).
6. Click on the left-panel **Network Resources** tab. Right-click on **Network Resources** or **Global Network Resources (All Domains)** and select **Create Network Resource** to create a network resource for the domain. You can also right-click **Network Resource Topologies** and select **Create Network Resource Topology** to create a network resource topology for the domain. For more information on creating a network resource or network resource topology, see [How to Create a Network Resource](#).
7. Select **Open/Manage Domains > Save Domain**. The data elements are saved to the new Demonstration Domain.

For more information:

- [How to Create and Use Domains](#)

Now that you've created the demonstration domain, we can explore the **Policy** tab in a little more depth.

## Understanding Roles

Roles are usually designed to reflect different users in your organization and to provide customized access capabilities based on the role users have in your organization. For example, accounting and engineering personnel have different network access and priority needs and therefore may have different roles.

To view information about existing roles:

1. Click on the left-panel **Roles/Services** tab in the Policy tab main window.
2. Click on the left-panel **Roles** sub-tab in the Roles/Services tab.
3. Click a role name to see a description of the role.
4. Click on the various roles listed in the left panel, and in the right panel you'll see tabs that display specific information for each role. Click the right-panel tabs to see the information they contain.

A role can be made up of one or more network access services defined in the **Policy** tab. These services determine how network traffic is handled at any network access point configured to use that role. A role may also contain default access control (VLAN) and/or class of service designations applied to traffic not handled specifically by the services contained in the role. A role can contain any number of services or service groups.

To filter through roles easily, select the Show Editable Columns drop down and select if you want to hide or show editable information.

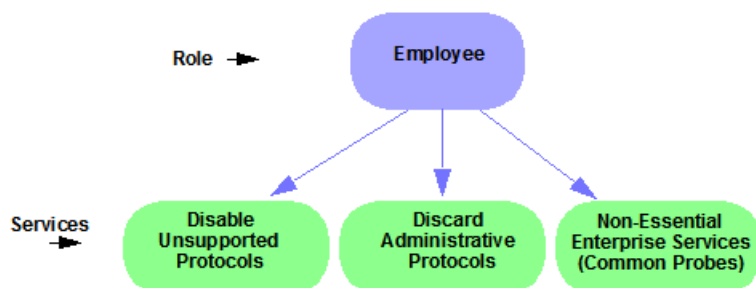

Roles are assigned to users during the authentication process. When a user successfully authenticates, the port is opened, and if a role is assigned to the

user, that role is applied to the port. A role can also be directly assigned to a port as a default role for instances when authenticated users are not assigned a role. If an end user on a port is not assigned a role when logging in (authenticating), or if authentication is inactive on a port, then the port uses its default role. However, if a user is assigned a role upon login, then that role overrides any default role on the port.

To create and define a role, right-click **Roles** and select **Create Role**.

To create a role:

1. In the **Policy** tab left panel, select the **Roles/Services** tab.
2. Select the Roles sub-tab.
3. Right-click the Roles folder, and select **Create Role**.
4. Enter the role name **Office Assistant** in the highlighted box and press **Ok**.

For more information:

- [Role](#)
- [How to Create a Role](#)

## Role Summary Column

The Summary column shows the data for the row in a condensed form. Hovering over the cell displays the summary data in an expanded, easy to read format. This includes the rule and service usage information, traffic description, action details, automated service relevant network resources, and topology information.

## Understanding Services

Roles can be made up of one or more network access services. These services determine how network traffic is handled at any network access point configured to use that role. The **Policy** tab allows you to create Local Services (services unique to the current domain) and Global Services (services common to all domains).

Services can be one of two types:

- Manual Service — Contain customized classification rules you create.
- Automated Service — Associated with a particular set of network resources.

Manual services contain one or more traffic classification rules that define how a network access point handles traffic for a particular network service or application. For example, you might create a Manual service called "Restricted Employee" that contains a classification rule that discards TCP HTTP traffic.

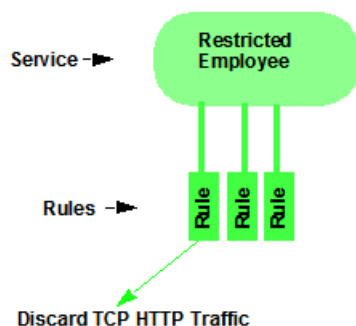

We are creating a Manual service and then adding it to a role. Right now, let's take a look at the services in the domain.

To view information about existing services:

1. Click on the left-panel **Roles/Services** tab in the **Policy** tab main window.
2. Expand the **Service Repository** folder and then the **Local Services** folder.
3. Expand the **Services** folder to view a list of services.
4. Expand a service or two to see the individual classification rules that make up the service.
5. Select a service or two in the left-panel to see the right-panel tabs that display specific information for each service. Click the right-panel tabs to see the information they contain.

For more information:

- [Service](#)
- [How to Create a Service](#)



## Working with Service Groups

Services can be grouped together into Service Groups. This allows you to add a set of services to one or more roles.

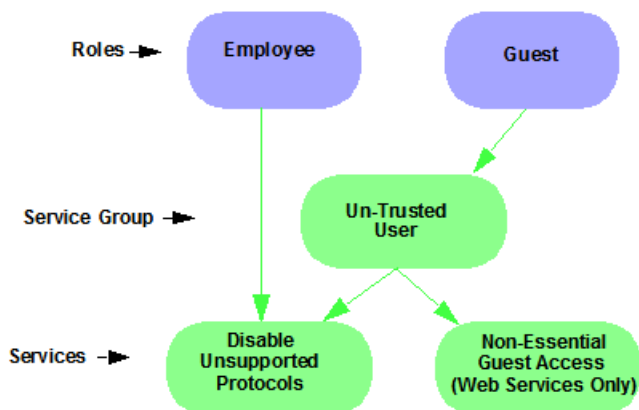

To view information about existing service groups:

1. Click on the left-panel **Service Repository** tab in the **Policy** tab main window.
2. Expand the **Service Repository** folder and then the **Local Services** folder. Expand the **Service Groups** folder.
3. Expand the **Acceptable Use Policy** service group to see its services. These services are also listed under the **Services** folder.

After you have defined and created your services, you can easily create a Service Group and then add your services to the group.

To create a service group:

1. Click on the left-panel **Roles/Services** tab in the **Policy** tab main window.
2. Expand the **Service Repository** folder and then the **Local Services** folder.
3. Right-click the **Service Groups** folder and select **Create Service Group**.
4. Enter the service group name **Trusted User** in the highlighted box and press **Enter**.
5. Right-click Service Group, select **Add/Remove Services** and add one or

---

two of the existing Acceptable Use Policy service groups into the Trusted User service group.

For more information:

[How to Create a Service Group](#)

## Understanding Traffic Classification Rules

Traffic classification rules allow you to assign access control (VLAN membership) and/or class of service to your network traffic based on the traffic's classification type. Classification types are derived from Layers 2, 3, and 4 of the OSI model and all network traffic can be classified according to specific layer 2/3/4 information contained in each frame.

A traffic classification rule has two main parts:

- Traffic Description — Identifies the traffic classification type for the rule.
- Actions — Apply access control, class of service, security, and/or accounting behavior to packets matching the rule.

To view existing rules:

1. In the left-panel, navigate to the **Service Groups** tab (Roles/Services > Service Repository > Local Services > Service Groups) and expand the **Acceptable Use Policy** service group.
2. Expand the **Deny Unsupported Protocol Access** service and click on the **Discard AppleTalk** rule.
3. Use the **Edit** button to add a description to the service, for example: **AppleTalk not supported on this network.**

For more information:

- [Rule](#)
- [Traffic Classification Rules](#)
- [How to Create or Modify a Rule](#)

## Adding Devices

The first step in adding network devices to **Policy** tab, is to add the devices to the Extreme Management Center database. You do this initially, by using the [Discovered tab](#) on the **Network** tab. This section assumes you have already done this. If you need more information, refer to the [Network tab](#) Help page.

Once you add devices to the Extreme Management Center database, you must assign the devices to a [Policy Domain](#) using the **Policy** tab. As soon as the devices are assigned to a domain, they are automatically displayed in the **Policy** tab device tree. Only devices assigned to the domain you are currently viewing are displayed.

To assign devices to a domain:

1. In the **Policy** tab main window, right-click **Devices** and select **Assign Devices to Domain**. The Assign Devices to Domain window opens.

In the left panel, the Unassigned device tree contains all the devices in the database not assigned to a domain. The right panel displays the devices in the current domain.

2. For the Quick Tour, select a couple of devices to add to the domain and click **Add**. Click **OK** to add the devices.

You can also use this window to remove a device from the current domain. This removes the device from the current domain and places it in the Unassigned folder. It does not delete the device from the Extreme Management Center database.

For more information:

- [How to Add and Delete Devices](#)
- [How to Create and Use Domains](#)

## Viewing Port Configuration Information

After importing devices into the **Policy** tab, you can view and configure their ports by selecting a device and displaying its ports in the right-panel **Details View** tab or **Ports** tab.

To view port configuration information:

1. Click on the left-panel **Devices** tab in the **Policy** tab main window.
2. Expand the **Devices** folder and select a device.
3. In the right-panel **Ports** tab, expand a **Ports** or **Slot** folder to display ports on the device.
4. Right-click on a port and select **Current Domain > Show Role Details**.
5. Set Default Role, if necessary.

## Working with Port Groups

The **Policy** tab allows you to group ports into User-Defined Port Groups, similar to the way you can group services into service groups. Port groups enable you to configure multiple ports on the same device or on different devices, at the same time. The **Policy** tab also provides you with Pre-Defined Port Groups. Every time one of the Pre-Defined Port Groups is accessed, the **Policy** tab goes to the devices in the current domain and retrieves the ports which fit the pre-defined characteristics of the port group.

To view pre-defined port groups:

1. Click on the left-panel **Port Groups** tab in the **Policy** tab main window.
2. Highlight a port group to display information for that port group.

For more information:

- [Pre-Defined Port Groups](#)

## Working with VLANs

All traffic in a **Policy** tab network is assigned membership in a VLAN. Roles are used to assign VLAN membership to traffic either through the role's default access control or through the role's services which may include traffic classification rules that assign VLAN membership (access control).

When you open a new domain, the Global VLANs folder is prepopulated with the Default VLAN (not to be confused with a default VLAN assigned to a role, although the Default VLAN *could* be a default VLAN for a role). You can then create additional VLANs and assign them as default access control for a role and/or use them to define traffic classification rules. You can view the roles and

services associated with a VLAN by selecting the VLAN in the left-panel. You can also make role and service changes from this window.

Island VLANs are used in Policy VLAN Islands, which enable you to deploy a policy across your network, while restricting user access to only selected local devices. The **Policy** tab allows you to view currently configured Island VLAN information.

To view VLANs:

1. From the **VLANs** tab, expand the **Global VLANs** folder to see individual VLANs.
2. Click on the Default VLAN listed and view the VLAN information in the right panel.

For more information:

- [How to Create a VLAN](#)
- [General Tab \(VLAN\)](#)
- [Policy VLAN Islands](#)

## Viewing Classes of Service

The **Policy** tab lets you create a class of service (CoS) that includes one or more of the following components: an 802.1p priority, an IP type of service (ToS) value, rate limits, and transmit queue configuration. You can then assign the class of service as a classification rule action, as part of the definition of an automated service, or as a role default.

To view Classes of Service:

1. From the **Policy** tab, select the **Class of Service** tab from the left-hand panel. The Class of Service section expands.

Notice that the window is pre-populated with eight static classes of service, each associated with one of the 802.1p priorities (0-7). You can use these classes of service as is, or configure them to include ToS/DSCP, drop precedence, rate limit, and/or transmit queue values. You can also rename them, if desired. In addition, you can also create your own classes of service (user-defined CoS).

2. Select the **Class of Service** and all information related to the Class of Service selected is displayed in the right-panel.

For more information:

- [Getting Started with Class of Service](#)
- [How to Define Rate Limits](#)
- [How to Configure Transmit Queues](#)
- [How to Create a Class of Service](#)

## Saving the Domain

After changing a policy domain, save the domain. This notifies all clients viewing the domain there is a change, which prevents them from saving a domain with an incorrect configuration. The system automatically updates their view with the new configuration.

To save a domain, select **Open/Manage Domains > Save Domain**.

The domain is saved and automatically updates for all clients viewing the domain. To discard unsaved changes you made to a domain, open the **Open/Manage Domains > Open Domain** menu and select the domain in which you are currently working.

For more information:

[How to Create and Use Domains](#)

## Enforcing

Any time you add, make a change to, or delete a role or any part of it (any of its services and/or rules), the devices in your current domain need to be informed of the change so that your revised policy configuration can take effect. This is accomplished by enforcing — writing your policy configuration to a device or devices. Enforce operations are performed only on the current domain.

To enforce to all devices in the current domain, select **Open/Manage Domains > Enforce Domain**. To enforce to a single device, right-click the device and select **Enforce**.

## Enforce Preview

The Enforce preview tool has a very similar setup to the Enforcing Domain tool. To view the enforce preview, select **Open/Manage Domains > Enforce Preview** and select the device to preview from the left dropdown.

**Note:** If the device has a red exclamation type next to it in the left panel, then it is incompatible with the domain configuration and should be corrected.

Enforcing preview shows you a summary of the stats and info, roles, rules, and services on device. The three preview tabs include:

**Device Stats & Info:** Shows information on supported role/rule counts, etc.

**Roles & Rules:** Shows a grid panel with roles and rules that will enforce the device. If supported, it will show a green circle. A yellow circle indicates a rule not being supported, and a red circle denotes a role not being supported. **Right-click** and select **View/Edit** which will close enforce preview and bring you to the item you wish to make changes to.

**Classes of Service:** Shows details of the Class of Service and the related rate limit configuration.

## Rule Counts Reported by Devices

Every device has a maximum number of rules that it can follow. Going over the max number of rules on a device will create enforce failures. The max supported rules by rule type are mainly a concern for EXOS device, which now report the max a type supports via the value returned for `etsysPolicyRuleAttributeMaxCreatable` for any rule type in that group. For example, reading either instance 1 (`macSource(1)`) or 2 (`macDestination(2)`) will return the supported number of layer 2 (MAC) rules. The 4 rule “types” and the rule types () that these include are:

- MAC
  - `macSource(1)`
  - `macDestination(2)`
- IPv4
  - `ip4Source(12)`
  - `ip4Destination(13)`

- ipFragment(14)
- udpSourcePort(15)
- udpDestinationPort(16)
- tcpSourcePort(17)
- tcpDestinationPort(18)
- ipTtl(20)
- ipTos(21)
- ipType(22),
- IPv6
  - ip6Destination(10)
- L2
  - etherType(25)

The total max supported number of rules for EXOS devices is the sum of these 4 types, NOT the value returned by `etsysPolicyRulesMaxEntries` (due to that including other things by the FW).

The devices supported number of rules is only read when the device is added to the domain, the firmware is upgraded, or the device is manually refreshed.

For more information:

[Enforcing](#)

## Verifying

To determine if the roles currently in effect on your domain devices match the set of roles defined in your current Policy Domain configuration, use the [Verify](#) feature.

## AP Aware

An AP is assigned "AP Aware," all traffic through this port will not need authentication. This new Role default action is configurable via a new AP Aware setting in the role configurations view. To enable AP Aware:



1. Click on the left-panel **Roles/Services** tab in the Policy tab main window.
2. Click on the left-panel **Roles** sub-tab in the Roles/Services tab.
3. Click a role name to see a description of the role.
4. Using the scroll bar, scroll to find the **AP Aware** column.
5. Double-click **Disabled**, and in the drop-down, select **Enabled**.

When enforce or verify occurs, the secondary logic runs which inspects all AP Aware enabled roles, and for each role finds all in-use VLANs (rule actions, role default action) and automatically adds them to that role's tagged VLAN egress list if they are not already present. This is then used for the enforce/verify logic, and returned to the client so the domain is updated accordingly.

The domain data may change from doing an enforce/verify, and needs to be saved.

For more information:

[Verifying](#)

---

## Related Information

For information on related concepts:

- [Policy Tab Concepts](#)
- [Traffic Classification Rules](#)

For information on related windows:

- [Main Window](#)

## Policy Configuration Considerations

---

Review the following configuration considerations when installing and configuring Extreme Management Center's **Policy** tab.

- [General Considerations](#)
  - [Authenticating without Policy](#)
  - [Terminating Role Override Sessions](#)
  - [Port-Level MAC to Role Mappings](#)

- [Import From Device](#)
- [Flood Control](#)
- [C1 Considerations](#)
  - [Policy Support](#)
  - [Rule Limits](#)
- [N-Series Considerations](#)
  - [Role Precedence for the N-Series Platinum](#)
- [C2 and B2 Considerations](#)
- [C3 and B3 Considerations](#)
- [Mixed-Stack C2/C3 and B2/B3 Considerations](#)
- [7100 Considerations](#)
- [Extreme Access Control Controller Configuration](#)
- [Wireless Controller Configuration](#)

## General Considerations

### Authenticating without Policy

This section discusses how authentication works in a network where end users must authenticate, but there are no roles (policy) for authenticated users defined on the network devices.

The following table shows Authentication Behavior for each device type when the authenticated role is not defined on the device:

Authentication Type	K-Series, S-Series, N-Series				
	Gold and Platinum	E6/E7	E1	RoamAbout R2 RoamAbout AP3000	C2/B2
<i>802.1X</i>	Successful	Successful	Successful	Successful	Successful
<i>MAC</i>	Successful	Successful	Successful	Successful	Successful
<i>Web-Based</i>	Successful	Successful on firmware version 5.06.x. Failed on older firmware versions.	Successful	Web-Based Auth Not Supported	Successful

The following table shows Authenticated Traffic Behavior for each device type when the authenticated role is not defined on the device:

Authentication Type	N-Series Gold and Platinum 4.11 and earlier	K-Series, S-Series, N-Series 5.01 and later Gold and Platinum	E6/E7	E1	RoamAbout R2 RoamAbout AP3000	C2/B2
<i>802.1X</i>	1	3	2	2	3	2
<i>MAC</i>	1	3	2	2	3	2
<i>Web-Based</i>	1	3	2	2	Web-Based Auth Not Supported	2

**1** - Traffic is forwarded based on the 802.1Q PVID and 802.1p priority for the port, regardless of whether the port has been assigned a default role. Authenticated users display a current role of "None" in the Port Usage tab.

**2** - Traffic is forwarded based on the port's default role and authenticated users will display the default role as their current role in the **Port Usage** tab. If no default role has been assigned to the port, the port's 802.1Q PVID and 802.1p priority are used, and the current role will be "None."

**3** - Traffic is forwarded based on the Invalid Role Action configuration at the device level in the **Policy** tab.

### Terminating Role Override Sessions

On Port Usage tabs, you cannot terminate Role Override (IP) or Role Override (MAC) sessions created through the CLI (command line interface).

### Port-Level MAC to Role Mappings

Enforcing port-level MAC to Role mappings could potentially remove rules as an intrusion detection response.

### Import From Device

If you perform a Verify operation following an Import Policy Configuration from Device, the Verify may fail. This is because the import operation imports only roles and rules from the device, not the complete policy configuration.

Also, if you import from more than one device and the configuration is not the same on each device, Verify fails. This is because the imported configuration will not match the configuration on any one device.

### Flood Control

Individual Class of Service granularity is unsupported on fixed switches, so if any CoS is assigned a Flood Control rate, all Class of Service on these devices use

that rate.

## C1 Considerations

Review the following considerations prior to configuring policy on C1 devices:

### Policy Support

Policy support on C1 devices utilizes both a port-level role and a device-level role. In the **Policy** tab, a role is a set of network access services made up of traffic classification rules. It may also contain default Access Control (VLAN) and/or Class of Service settings applied to traffic not handled specifically by the rules contained in the role. Although both the device-level and port-level roles may contain all of these components, only certain portions of each role are used when applied to a port on a C1 device.

On the C1, classification rules are implemented at the device level through a device-level role. The **Policy** tab allows you to set a unique device-level role for each C1 device. The device-level role is a regular role that defines how inbound traffic is handled in terms of classification rules and default Class of Service assignment. In other words, all classification rules are taken from the device-level role, and any rules defined in the port-level role are ignored when applied to a port. The Class of Service setting is also implemented through the device-level role and ignored in the port-level role. However, the default Access Control setting of the device-level role is ignored, and is defined through the port-level role.

Classification rules from the device-level role are only applied to ports which also have a port-level role applied (either statically or dynamically). This allows you to exclude the device-level role from uplink ports and hosts ports, by not applying a port-level role to these ports and not enabling authentication on them.

When a port-level role is applied to a port, it overrides any PVID and Class of Service settings defined on the port through Console or local management. When a device-level role is applied to a port, it also overrides these PVID and Class of Service settings, and overrides any Class of Service setting defined in the port-level role. It does **not** override any default Access Control setting defined in the port-level role.

In addition, if the port-level role's default Access Control is configured to deny traffic, then **all** inbound traffic will be discarded even if it matches a (forward) classification rule.

## Rule Limits

C1 devices limit the number of rules you can create for some classification types. Refer to the C1 information in the Extreme Management Center Release Notes to see which classification types limit the number of rules.

## N-Series Considerations

Review the following considerations prior to configuring policy on N-Series devices:

### Role Precedence for the N-Series Platinum

The following precedence determines the role (policy) that is being applied on a user/port on a N-Series Platinum device. The precedence used depends on whether the device is configured for multi-user authentication or single user authentication.

#### Multi-User Authentication:

Devices configured with multi-user authentication use the following precedence when applying a role on a user/port (starting with the highest precedence):

- MAC override policy
- Authenticated role
- MAC-to-Role mapping
- IP override policy
- IP-to-Role mapping
- VLAN-to-Role mapping
- Default port role

#### Single User Authentication:

Devices configured with single user authentication use the following precedence when applying a role on a user/port (starting with the highest precedence):

- MAC override policy
- MAC-to-Role mapping
- IP override policy
- IP-to-Role mapping
- Authenticated role

VLAN-to-Role mapping  
Default port role

## C2 and B2 Considerations

Review the following considerations prior to configuring policy on C2 and B2 devices.

- When TCI Overwrite is enabled on a role, C2 and B2 devices support rewriting the 802.1p bit (CoS values) but not the 802.1Q bit (VLAN ID).
- On C2 and B2 gigabit and 10/100 ports, the number of rules per port is restricted. Refer to your C2 and B2 firmware release notes for the maximum number of rules that can be utilized on a port.
- C2 and B2 10/100 ports support two priority-based rate limits (inbound only). When creating a rate limit to be used on C2 and B2 10/100 ports, create the limit with either Low priority to associate the rate limit with priorities 0-3 or High priority to associate the rate limit with priorities 4-7. You can specify both Low and High priorities if you want to associate the rate limit with priorities 0-7.
- C2 and B2 devices do not support setting a default role on a logical port.
- On C2 and B2 devices, it is strongly recommended that you do not enforce rules that assign a Class of Service (CoS) that includes Priority 7. Doing so will interfere with stack communication.
- C2 and B2 devices do not allow a mask for an IP type of service (ToS) rewrite value associated with a class of service (CoS); they will always use ff.
- C2 and B2 devices do not support VLAN ID traffic classification rules. C2 devices (firmware 3.02.xx and newer) and B2 devices (firmware 2.xx.xx) support device-level VLAN to Role mapping. However, VLAN ID traffic classification rules can be configured on C2 devices with firmware versions 3.01.xx or older, using CLI.
- B2 only. Each port on a policy-enabled B2 switch can support up to 100 rules and up to 10 masks. The maximum number of unique rules in a single switch or B2 stack is 100, while the maximum number of unique masks is 18. These unique rules and masks may be shared across any and all ports in a stack or switch.

## C3 and B3 Considerations

Review the following considerations prior to configuring policy on C3 and B3 devices.

- 
- B3/C3 devices do not support TCI Overwrite. The B3/C3 does not overwrite 802.1Q VLAN bits, but overwrites the 802.1p Priority bits.
  - B3/C3 devices do not support Layer 3 ICMP rules.
  - B3/C3 devices support role-based rate limiting. However, on the B3/C3, class of service inbound rate limiting works only on policy roles, not on policy rules.
  - C3G and B3 devices have the following additional limitations:
    - Maximum 100 rules per policy role.
    - A system limitation of 768 unique rules.
    - Maximum of 15 roles.
  - C3 and B3 devices do not support setting a default role on a logical port.

### Mixed-Stack C2/C3 and B2/B3 Considerations

Review the following considerations prior to configuring policy on mixed stacks of C2/C3 and B2/B3 devices.

---

**NOTE:** While you can create mixed stacks of C2/C3 devices and mixed stacks of B2/B3 devices, you should not create mixed stacks of C and B devices (e.g. mixed stacks of C2/B2 or C3/B3 devices).

---

- It is strongly recommended that a C3 device be configured as the master in a mixed C2/C3 stack.
- It is strongly recommended that a B3 device be configured as the master in a mixed B2/B3 stack.
- When you have a mixed stack, all devices in the stack have the rule type and Class of Service limitations of a C3 or B3 device, despite the fact that the stack may report itself as a C2 or a B2. The device type that the stack reports is based on what switch is set as the master.
- Mixed stacks with a B3/C3 master support role-based rate limiting, however, class of service inbound rate limiting works only on policy roles, not on policy rules.
- A mixed stack containing a C2H or a B2 has the following limitations:
  - A single role limitation of 100 rules and 10 masks.
  - A system limitation of 100 unique rules and 18 unique masks.
  - No support for Layer 2 rules or Layer 3 ICMP type rules.

- Maximum of 15 roles.
- No support for rate limiting.
- A mixed stack containing a C2G has the following limitations:
  - A single role limitation of 100 rules and 10 masks.
  - A system limitation of 768 unique rules.
  - No support for Layer 2 rules.
  - Maximum of 15 roles.
  - No support for rate limiting.
- When adding a new device to a mixed stack, the ports should not go active unless the stack supports the policy configuration. Once a device has joined the stack, no roles should be enforced that are not supported on all devices. For example:  
A C2K is added to an existing C3 stack.
  - If the number of masks in the C3 stack's current configuration exceed those allowed by the C2K, its ports cannot go active.
  - Once the C2K joins the stack, no roles can be enforced that exceed the limitations of any device.

## 7100 Considerations

- 7100 devices only support fixed IRL index reference mappings for the static CoS. The IRL Index for the CoS needs to match the priority. This is the default configuration for domains, but if it is changed for a static CoS, enforce will fail.
- 7100 devices only support fixed TXQ index reference mappings for the static CoS. The TXQ Index for the CoS needs to match the priority. This is the default configuration for domains, but if it is changed for a static CoS, enforce will fail.
- 7100 devices only support fixed COS - transmit queue mappings. The transmit queue specified for a Class of Service must match the 802.1p priority, or enforce will fail.
- TCI Overwrite configuration is not supported on the 7100. It is always enabled, and cannot be turned on or off using the Policy tab.

## Extreme Access Control Controller Configuration

Review the following considerations prior to configuring policy on Extreme Access Control Controller devices.



## Extreme Access Control Controllers Require Separate Domains

Extreme Access Control Controllers must be assigned to their own unique policy domain and cannot be combined with other switch types in a domain.

## Modifying Extreme Access Control Controllers Preconfigured Policy

Extreme Access Control Controllers are shipped with a default policy configuration already configured on the device. To modify this default policy configuration, you must create a domain for the Extreme Access Control Controller, assign the Extreme Access Control Controller to the domain, then import the policy configuration from the device into the Policy tab (File > Import > Policy Configuration from Device). You can then alter the policy configuration to define the authorization levels for the Extreme Access Control process, as appropriate for your environment. If assessment will be enabled in the Extreme Networks Extreme Access Control solution, you must add classification rules to the Quarantine and Assessing policies to allow traffic to be forwarded to the assessment servers deployed on the network. When you have finished modifying the policy configuration, you must enforce it back to the Extreme Access Control Controller.

---

**NOTE:** If you are using assisted remediation and quarantined end-users will be required to download remediation files via FTP, you will also need to add a rule to the Quarantine policy configuration that opens up ports 49152-65535. If you are concerned with security, you can configure your FTP server to use a smaller range of ports.

---

## Modifying the Downstream Default Policy

Depending on the network configuration or circumstances, it's possible that traffic from the upstream side could be rerouted to the Extreme Access Control Controller where it would be authenticated using the upstream source IP address. To avoid this problem, add a Layer 3 IP Address Source rule to the downstream default policy configured on the Extreme Access Control Controller, using the upstream IP subnets (or critical servers located in the upstream) and containing the traffic to a VLAN.

## Configuring LAG on Extreme Access Control Controllers

This section provides instructions for configuring LAG (link aggregation) on your Extreme Access Control Controller appliance. The instructions vary

---

depending on whether you are configuring LAG on a Layer 2 or Layer 3 Extreme Access Control Controller.

### Configuring LAG on Layer 3 Extreme Access Control Controllers - Upstream Ports

1. Configure LAG on the Extreme Access Control Controller PEP (Policy Enforcement Point) using the CLI (Command Line Interface).
2. Use the **Policy** tab to assign the appropriate upstream role as the default role on the port. For instructions, see [Assigning Default Roles to Ports](#).

### Configuring LAG on Layer 3 Extreme Access Control Controllers - Downstream Ports

1. Configure LAG on the Extreme Access Control Controller PEP (Policy Enforcement Point) using the CLI (Command Line Interface).
2. In the **Policy** tab options (Tools > Options), display the Ports panel and uncheck the Hide Logical Ports option.
3. Use the **Policy** tab to assign the appropriate downstream role as the default role on the port. For instructions, see [Assigning Default Roles to Ports](#).

### Configuring LAG on Layer 2 Extreme Access Control Controllers - Upstream Ports

1. Configure LAG on the Extreme Access Control Controller PEP (Policy Enforcement Point) using the CLI (Command Line Interface).
2. In the **Policy** tab options (Tools > Options), display the Ports panel and uncheck the Hide Logical Ports option.
3. Use the **Policy** tab to assign the appropriate upstream role as the default role on the port. For instructions, see [Assigning Default Roles to Ports](#).

### Configuring LAG on Layer 2 Extreme Access Control Controllers - Downstream Ports

1. Configure LAG on the Extreme Access Control Controller PEP (Policy Enforcement Point) using the CLI (Command Line Interface).
2. In the **Policy** tab options (Tools > Options), display the Ports panel and uncheck the Hide Logical Ports option.

3. Use the **Policy** tab to assign the appropriate downstream role as the default role on the port. For instructions, see [Assigning Default Roles to Ports](#).
4. Use the CLI to set the following command: `nodealias maxentries 4096 <lag port>`.

## ExtremeWireless Controller Configuration

The following sections present information regarding support for the ExtremeWireless Controller in the **Policy** tab. Review the following considerations prior to configuring policy on wireless controller devices.

### Version Supported

The Policy tab only supports Wireless Controller version 8.01.03 and higher.

### Policy Rules

This section describes wireless controller support for policy rules.

### Supported Rule Types

The Wireless Controller supports the following traffic classification rule types:

- Ethertype
- MAC Address Source/Destination/Bilateral
- Priority
- IP Type of Service
- IP Protocol Type<sup>1</sup>
- ICMP
- IP Address Source/Destination/Bilateral
- IP Socket Source/Destination/Bilateral
- IP UDP Port Source/Destination/Bilateral
- IP UDP Port Source/Destination/Bilateral Range
- IP TCP Port Source/Destination/Bilateral
- IP TCP Port Source/Destination/Bilateral Range

<sup>1</sup>Not all IP Protocols are supported for the wireless controller. Supported IP Protocols for this rule type are: ICMP, TCP, UDP, GRE, ESP, AH.

## "No Change" Filter Sets

The wireless controller allows administrators to define policies that do not have any filters of their own, but which instead use the set of filters already assigned to a station by a previously applied policy. This type of policy is said to have a "No Change" set of policy rules. The **Policy** tab does not support policies that have "No change" policy rule sets. Using the ExtremeWireless Assistant, you need to remove any policies containing "No Change" rule sets before the wireless controller can be managed by the **Policy** tab.

## Rule Actions

The following list defines the wireless controller support for rule actions:

- Access Control: Permit, Deny, and Contain to VLAN actions are supported.
- Class of Service is supported.
- TCI Overwrite is not supported.
- System Log, Audit Trap, Disable Port, and Traffic Mirror actions are not supported.

## Rule Directions

The **Policy** tab rules are applied to incoming data packets based on the source or destination address, whereas the wireless controller applies rules to packets based on In/Out direction. On the wireless controller, "In" means coming from the station into the network and "Out" means going from the network out to the station. The wireless controller applies rules to the destination address of inbound packets and to the source address of outbound packets, as shown in the illustration below.

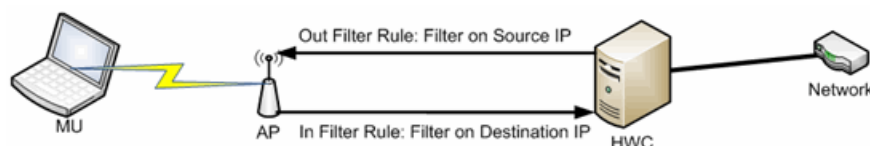

When you create a rule in the Policy tab that allows traffic to a specific destination, that same rule permits data flow from the destination back to the traffic source. This means that Destination rules in the **Policy** tab map to In/Out rules on the wireless controller. Certain **Policy** tab rule types do not have a Source or Destination designation (such as ICMP); however, these rules still map to In/Out rules on the wireless controller to indicate the filters are applied to traffic in both directions. Unchecking the In or Out flag for non-directional rules

via the ExtremeWireless Assistant does not affect the way it is reported to the **Policy** tab. As long as the rule still exists, verify succeeds.

All rules enforced from the **Policy** tab are created as "In" rules, and "Out" rules created on the controller are not reported to the **Policy** tab.

When the egress policy feature is enabled for a VNS, egressing traffic is applied to the defined "In" filters as a "reflected" Out rule (with the source and destination fields reversed) and any explicitly defined "Out" filters created on the controller are ignored. Egress policy may be enabled per VNS by selecting Port Properties for that VNS.

The wireless controller reports to the **Policy** tab any rules created directly on the controller that contain an "In" component. "Out" rules are not reported to the Policy tab. This allows administrators to define and use "Out" rules on the wireless controller in special cases where additional restrictions need to be imposed.

## Rule Limits

The wireless controller has a limit of 64 rules per policy role if the policy is enforced at the controller (bridged @ wireless controller or routed topology), and 32 rules per policy role if the policy is enforced at the AP (bridged @ AP).

## Role Default Actions

The following list defines the wireless controller support for role default actions:

- Access Control: Permit, Deny, and Contain to VLAN are supported.
- Class of Service: Inbound and outbound rate limits are supported. 802.1p Priority, and ToS/DSCP Marking are supported.
- TCI Overwrite is not supported.
- System Log, Audit Trap, Disable Port, and Traffic Mirror actions are not supported.
- The wireless controller will reject policy configurations that specify a VLAN that does not have an egress port already specified.

## Class of Service

The following list defines the wireless controller support for Class of Service (CoS) configuration via the **Policy** tab:

- Inbound and outbound rate limits are supported at the role-level as Class of Service default actions.
- User-based inbound/outbound rate limits are supported for the Default port group for wireless controllers only.
- 802.1p Priority configuration is supported.
- ToS/DSCP Marking is supported.
- TCI Overwrite is not supported.
- Transmit Queue Rate Shaping is not supported.

### Rate Limits

The wireless controller supports inbound and outbound rate limits at the role-level as Class of Service (CoS) default actions. There are three states supported for a rate limit:

- Rate limit traffic at the specified rate.
- No Change (the CoS does not specify a rate, and the rate limit is "inherited" from the port's default role or from the global default policy, if one is defined.)

To explicitly prevent traffic from being rate limited for a role, you can map a rate limit with a value of 0 to a CoS, and set that as the default CoS for the role.

### Internal VLAN

The wireless controller uses an *internal VLAN* for processing traffic. For controllers with firmware version 8.01.xx, the internal VLAN is set by default to use VID 1 and the static name of "DEFAULT VLAN." For controllers with firmware version 8.11.xx and later, the internal VLAN uses the VID 4094 and the static name of "INTERNAL VLAN."

This internal VLAN cannot be used in your **Policy** tab domain configuration to tag traffic. If the VID for the internal VLAN is used in your domain configuration, the **Policy** tab enforce fails with an error message in the Event Log indicating the internal VID cannot be used.

You can use the Web UI (<https://<controller IP>:5825> > VNS Config > Topologies > Internal VLAN) to change the internal VLAN to a different value, but your policy domain must not use that new value or the **Policy** tab enforce fails.

---

**NOTE:** For controllers with firmware version 8.01.xx. Since using a Default VLAN with a VID of 1 is valid on wired devices, the controller's internal VLAN must be changed to another value to prevent issues with the Policy tab enforcing a configuration that uses this VLAN.

---

## Policy Inheritance

The wireless controller uses the concept of policy inheritance, which specifies that if the authenticated policy's access control (VLAN) or class of service (CoS) is set to "No Change," then the policy inheritance hierarchy is used to determine the VLAN and/or CoS. The policy inheritance hierarchy is as follows:

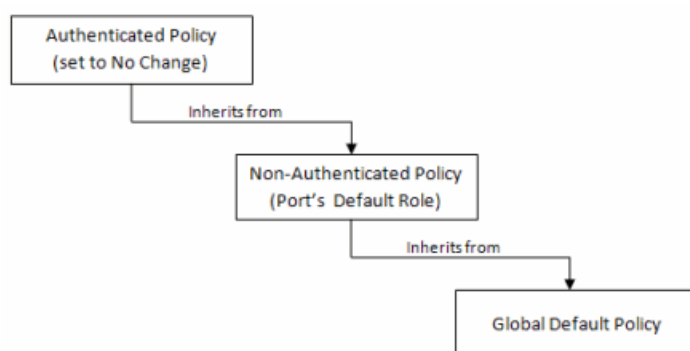

If the authenticated policy's VLAN and CoS are set to "No Change," then the VLAN and CoS settings for the port's default role is used. If the port's default role does not specify the VLAN and CoS, then the global default policy (specified via the ExtremeWireless Assistant) is used. (In wireless controller terminology, a VNS port's default role is the VNS's default policy.)

It is important to note that the **Policy** tab does not support "No Change" rules (filter set). If any policy's rules (filter set) are set to "No Change," then the **Policy** tab is not able to manage the device until the policy containing the "No Change" configuration is removed.

## Configuring RADIUS Servers

When configuring RADIUS authentication and accounting servers, keep in mind the following differences:

- The "Number of Retries" and "Timeout Duration" settings for RADIUS authentication servers are configured on a per-server basis for wireless controller devices. For all other devices, these settings are global to all RADIUS servers, and are specified per device as client defaults.

- The "Update Interval" setting for RADIUS accounting servers is configured on a per-server basis for wireless controller devices. For all other devices, this setting is global to all RADIUS servers, and is specified per device as client defaults.
- For wireless controller devices, the Client Status (Enabled or Disabled) is automatically set to Enabled when a RADIUS server exists and Disabled when it does not. For all other devices, Client Status is configured for each device, allowing you to enable and disable communication between the device and the RADIUS servers.
- If Strict Mode is enabled, up to three RADIUS servers are automatically associated to each WLAN service. If Strict Mode is disabled, RADIUS servers must be manually added to a WLAN service via the ExtremeWireless Assistant.

### Other Considerations

- The wireless controller does not support authentication configuration.
- The wireless controller does not support viewing user sessions in the Port Usage tabs.
- The wireless controller must have any VLANs used in a Role's default action already defined on the device and configured with an egress port. If the **Policy** tab enforces a domain configuration to the wireless controller using a VLAN that does not have an egress port specified, enforce fails.



# Extreme Management Center™ Policy Help

---

Extreme Management Center **Policy** enables the creation and deployment of role-based policies that dynamically control user access, network security, application prioritization and other parameters. Policy management and role-based administration are keys to effectively enforcing business and IT rules in the network infrastructure.

Contact your sales representative for information on obtaining an Extreme Management Center software license.

## Policy Tab Overview

The **Policy** tab simplifies the configuration of policies on networks, and deploys the policies on multiple devices throughout the switch fabric.

With the **Policy** tab, you can create policy profiles, called roles, assigned to the ports in your network. These roles provide four key policy features: traffic containment, traffic filtering, traffic security, and traffic prioritization. When authentication is enabled, users identify themselves to the network and are given customized access capabilities based on the role they serve in the organization.

Using the **Policy** tab configuration tools, you can create multiple roles tailored to your specific needs, and set a default role for all or some of your network devices and ports. Basic **Policy** tab operations include creating, editing, and deleting roles. You can also view role configuration on a per device and per port basis. In addition, the **Policy** tab allows you to verify the roles enforced on your network device match the roles currently configured in the application. The **Policy** tab supports a maximum of 1,000 devices (25,000 ports) and 50 roles per policy domain, and can process a maximum of 250 classification rules with a maximum of 50 classification rules per role.

## Extreme Management Center Details View

---

Some Details View tabs display a simple list of items for the current selection in the left panel. However, other Details View tabs present more complex tables of information. To access Help topics on those tabs, expand the Details View Tabs folder in the Policy tab Help Table of Contents. The Help topics are named to reflect the item selected in the left-panel tree. For example, the Help topic for the Details View tab with a device selected in the left panel is named Details View Tab (Device).

Most Details View tabs provide the following features:

- *Right-click menus*: Right-click an item for a menu of options.
  - *Sorting, filtering and finding*: Clicking on column headings sorts the column. Click the magnifying glass icon to open a **Search** field.
- 

## Extreme Management Center General

---

A **General** tab is available in the right panel of the **Policy** tab main window for many items selected in the left-panel tab. It provides general properties information about the selected item.

Help topics for the right-panel **General** tabs are named to reflect the item selected in the left-panel tree. For example, the Help topic for the **General** tab with a device selected in the left panel is named General Tab (Device). For more complete information on the different **General** tabs, expand the General Tabs section and select the desired tab.

### Policy Menus

---

The two drop-down menus on the **Policy** tab provide access to Policy tab functions. The **Open/Manage Domains** menu provides options for the domain currently accessed. The **Global Domain Settings** drop-down menu allows you to configure global **Policy** tab settings.

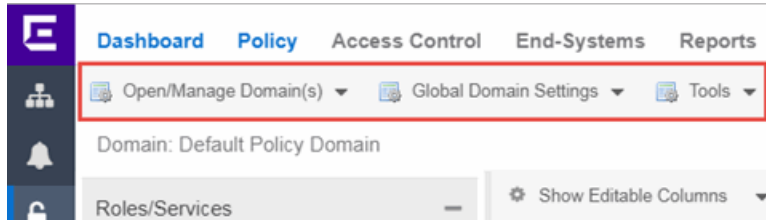

## Open/Manage Domains Menu

The Open/Manage Domains provides the following options for the **Policy** tab:

### Open Domain

Provides a list of the available Policy Domains. Selecting a domain opens that domain, allowing you to make changes.

### Lock Domain

Lets you lock the current Policy Domain for editing purposes. The **Policy** tab automatically locks the domain when you begin to edit the domain configuration. Other **Policy** tab users are notified that the domain is locked and they are not able to save their own domain changes until the lock is released. For more information, see [Controlling Client Interactions with Locks](#).

### Save Domain

Lets you save any changes you made to the current Policy Domain. Only users with the capability to [Enforce](#) are able to save the domain.

### Enforce Domain

Writes the role and/or any changes you have made to it (rules, services) to all the devices in your current domain. See [Enforcing](#) for more information.

### Verify Domain

Compares the roles in your current domain to the roles currently enforced on all the devices in the current domain. This is useful for ensuring the roles in your domain are [enforced](#), or, if you use more than one domain, ensuring that the roles in the domain you are currently using matches what is on the devices. See [Verifying](#) for more information.

### Assign Devices to Domain

Opens the [Assign Devices to Domain window](#) where you can assign devices that are in the Extreme Management Center database to the current Policy Domain.

### Create Domain

Lets you create and name a new (blank) Policy Domain.

**Delete Domain(s)**

Opens a window where you can select one or more Policy Domains to delete.

**Rename Domain**

Lets you rename the current Policy Domain.

**Import/Export > Import From Domain**

Opens the [Import from Domain window](#) where you can import policy configuration data from one Policy Domain into another domain. (This menu option is not available if only one domain exists, as there are no other domains from which to import data.)

**Import/Export > Import From File**

Opens the [Import from File](#) window, which enables you to import policy data from a .pmd file into the current Policy Domain. Be aware that the import overwrites any existing data in the Policy Domain. Any devices in the .pmd file must already exist in the Console database or they won't be imported.

**Import/Export > Export to File**

Lets you save policy data from the current Policy Domain to a .pmd file or .xml file with the file name and location of your choosing. This file stores all information about roles, services, and rules configured in the current Policy Domain. This allows you to save a Domain configuration prior to making changes so that you can restore the original Domain configuration if required (via Import/Export > Import From File).

## Global Domain Settings Menu

The Global Domain Settings Menu provides the following options:

**GVRP > Ignore GVRP**

To ignore GVRP status on the devices in the current domain, select this menu option and [enforce](#). This means that the **Policy** tab ignores the GVRP configuration on a device during an Enforce operation, allowing you to configure some network devices with GVRP enabled and others with GVRP disabled (using MIB Tools or local management), according to their configuration requirements. Be aware that for devices with GVRP set to disabled, ignoring GVRP configuration during an Enforce may affect connectivity on ports with VLANs that rely on Dynamic Egress.

**GVRP > Enable GVRP**

To enable GVRP on the devices in the current domain, select this menu option and [enforce](#). If the current domain configuration contains rules that use VLAN

containment, Dynamic Egress and GVRP must be enabled on the devices in the domain, or the VLANs must be properly pre-configured on the devices outside of the **Policy** tab.

### **GVRP > Disable GVRP**

If you do not want GVRP enabled on the devices in the current domain, select this menu option and [enforce](#). Be aware that disabling GVRP may affect connectivity through ports with VLANs that rely on Dynamic Egress.

### **Port Level Role Mappings Enabled**

Check this box to enable any port-level Tagged Packet VLAN to role mappings or port-level MAC to role mappings that have been configured and enforced for the current domain. If the box is not checked, all port-level mappings are ignored.

**NOTE:** This functionality is not yet available.

### **Do Not Use Global Services**

Check this box to hide the display of Global Services in the left-panel **Services** tab for this domain. If you use Global Services in some domains but not in others, this option allows you to hide global services in the domains where they are not used so that they won't be inadvertently used or modified.

## Tools Menu

### **Authentication Configuration**

Opens the [Authentication Configuration wizard](#), where you can configure authentication settings on a device.

### **RADIUS Configuration**

Opens the RADIUS Configuration wizard, where you can configure RADIUS authentication and accounting settings on a device.

### **Policy Event Log**

Opens the [Events tab](#) filtered to display only Policy events.

---

## **Related Information**

For information on related windows:

- [Main Window](#)

## Extreme Management Center Enforce Preview Window

---

Use the **Enforce Preview** window in the **Policy** tab to view the information you are writing to your devices, before you actually [enforce](#). Use this window when enforcing to devices that only support certain aspects of policy management. For example, some devices support only the policy features of policy management; some devices support the policy features and classification rules, but do not support VLAN forwarding for certain classification rules; and some devices fully support all policy management features, including policy, classification rules, and VLAN forwarding for all classification rules.

The **Enforce Preview** window appears in the **Policy** tab by selecting **Open/Manage Domain(s) > Enforce Preview**, or clicking the enforce icon in the left panel and selecting **Enforce Preview**. You can control whether this view automatically appears when you click **Enforce** with the **Show on Enforce** checkbox.

What you see in the window depends on whether you are enforcing to all devices or to a subset of devices. The title bar indicates the devices to which the enforce applies. After viewing the information in this window, you can either click **Close** to back out and make changes, or **Enforce** to go ahead with the enforce.

You can view device support for specific roles, services, and rules on the **Roles & Rules** tab. Refer to the Extreme Management Center Firmware Support tables for complete information on device support for Policy features, and VLAN and Priority classification rules.

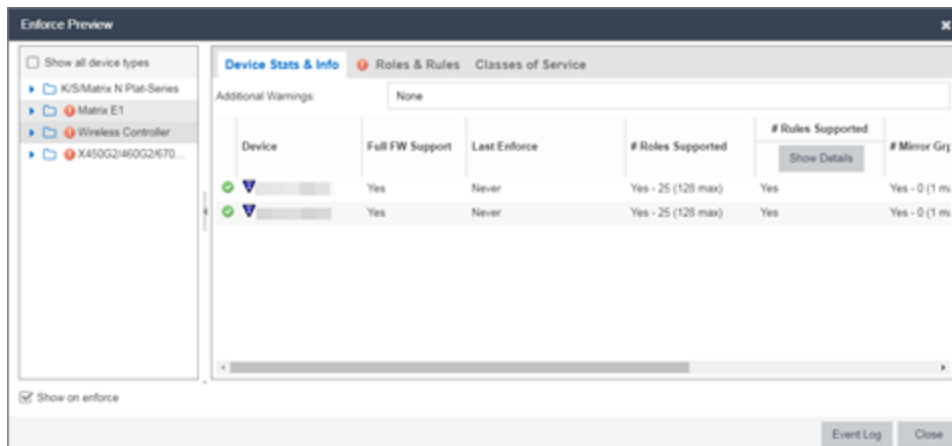

### Show on Enforce

When this checkbox is checked, the **Enforce Preview** window appears any time you [enforce](#), before the actual enforcement takes place.

## Left Panel

The left panel of the **Enforce Preview** window displays folders for different device types. Expand the folders to see your network devices and device groups organized according to device type. The warning icon (⚠️) alerts you that Extreme Management Center is not writing a staged change to this device type (e.g. rules not supported on a device).

### Show all device types

Select the checkbox in the left panel to display all device types in the left panel. When the checkbox is not selected, only the devices you are changing by enforcing are displayed.

Select a specific device type to display the information Extreme Management Center is writing to those devices when you enforce in the right panel.

## Right Panel

The right panel provides information about whether certain policy management features are supported and/or enabled for the device type selected in the left panel.

- Additional Warnings - If there are additional problems detected with the enforce, you will be directed to see the Event Log for details.
- GVRP - Shows whether GVRP is Enabled, Disabled, or Ignored. You can change GVRP status for the domain via the Edit menu.
- Dynamic Egress - Shows whether [Dynamic Egress](#) is Supported or Not Supported.

### Device Stats & Info Tab

Displays the devices for the device type selected in the left panel and provides information about each device. If the number of roles in the domain exceeds the supported number of roles on a device, the enforce fails.

- # of Roles Supported - The maximum number of roles supported by the device.
- Domain Role Count Supported - This column says "No" if the number of roles in the domain exceeds the supported number of roles on the device. A "Yes" in this column indicates that the number of roles on the device is equal to or less than the maximum number of supported roles.

**Role Statistics** - Lists information about each role:

- Number of Rules - The number of traffic classification rules the role includes.
- Number of Unique Masks - The number of masks defined for the rules included in the role.

There are six tabs that provide specific information about the Roles, Classification Rules, VLANs, Classes of Service, and Mappings that will be enforced. The information displayed depends on the device type you've selected in the left panel, and whether you have the Show All or the Show Errors and Warnings Only radio button selected. In addition, select a role in the Roles tab to filter the information for just that role.

### Roles Tab

**Incomplete** - Lists any roles with unsupported classification rules. These roles will be written to the devices, but without the unsupported rules.

**Complete** - Lists any roles which do *not* include unsupported classification rules. These roles will be written to the devices as defined.

---

**NOTE:** Select a Role to display only those classification rules and VLANs associated with the selected role.

---



---

**Classification Rules Tab**

**Excluded** - Lists any unsupported classification rules that have been applied to a role. These rules will not be included when the associated roles are written to the devices.

**Included** - Lists any supported classification rules that have been applied to a role. These rules will be included when the associated roles are written to the devices.

---

**NOTE:** On N-Series Platinum devices, range classification rules are achieved through applying subnet masks to values. As such, in order to achieve a user-specified range, the device may need multiple rules with subnets applied to encompass that range. So, although the user created only one rule with a range, this list may show multiple instances of that rule with the name of the rule followed by the portion of the over-all range it applies to.

---

**VLAN Tab**

**Excluded** - Lists any VLANs associated with unsupported classification rules, or VLANs that are not supported by the device. These VLANs will not be written to the devices.

**Included** - Lists any VLANs associated with supported classification rules and VLANs associated with roles. These will be written to the devices.

**Classes of Service Tab**

**Class of Service Mode** - Lists the Class of Service mode that will be written to the devices.

**Classes of Service Subtab** - Lists the classes of service that will be written to the devices:

- Class of Service - the name of the class of service.
- 802.1p Priority - the priority associated with the class of service.
- ToS Value - the IP type of service value associated with this class of service, if any. See [IP Type of Service](#) for more information.
- Drop Prec - The drop precedence associated with this class of service, if any. See [Drop Precedence](#) for more information.
- TxQueue Index - the transmit queue index associated with the class of service.
- IRL Index - the role-based inbound rate limit index associated with the class of service.
- ORL Index - the role-based outbound rate limit index associated with the class of service.

---

For more information, see [Getting Started with Class of Service](#) and [How to Create a Class of Service](#).

**Inbound/Outbound Role-Based Rate Limit Mappings Subtabs** - Lists the rate limit mappings that will be written to the devices:

- Device - The device where the rate limit mapping will be in effect.
- IRL/ORL Port Grp - The name of the port group that contains the rate limit mapping.
- IRL/ORL Index - The logical inbound rate limit (IRL) or outbound rate limit (ORL) index number. This index number is specified in a class of service and dictates the rate limiting behavior for incoming packets.
- Rate Limit - The actual rate limit that the IRL/ORL index is mapped to.
- IRL/ORL Port Type - The type of ports included in the port group. Port type is based on the number of rate limits the ports support (for example, 8-rate limit ports and 32-rate limit ports).
- Information - Information about mapping support.

**Transmit Queue/Rate Shaper Mappings Subtab** - Lists the transmit queue rate shaper mappings that will be written to the devices:

- Device - The device where the transmit queue rate shaper mapping will be in effect.
- TxQ Port Grp - The name of the port group that contains the transmit queue rate shaper mapping.
- TxQ Index - The logical transmit queue rate shaper index number. This index number is specified in a class of service and dictates the transmit queue and rate shaper behavior for incoming packets.
- Physical Transmit Queue / Rate Shaper - The actual transmit queue rate shaper that the index is mapped to.
- TxQ Port Type - The type of ports included in the port group. Port type is based on the number of transmit queues the ports support (for example, 4-transmit queue ports and 16-transmit queue ports).
- Information - Information about mapping support.

---

## Mappings Tab

---

**WARNING:** Enforcing port-level MAC to Role mappings could potentially remove rules created as an intrusion detection response.

---

**MAC to Role Mapping** - Lists the device-level and port-level mappings that will be written to the devices:

- Device/Port Level - indicates whether the mapping is a device-level mapping (all devices) or a port-level mapping (IP address and port description). Port-level mappings on frozen ports will be enforced.
- MAC Address - the MAC address mapped to the role. Masking a MAC address is only supported on N-Series Platinum devices.
- Mask - the mask associated with the MAC address.
- Role - the role mapped to the MAC address.

**IP to Role Mapping** - Lists the device-level mappings that will be written to the devices:

- IP Address - the IP address mapped to the role.
- Mask - the mask associated with each IP address. Masking an IP address is only supported on N-Series Gold and Platinum devices.
- Role - the role mapped to the IP address.

**Tagged Packet VLAN to Role Mapping** - Lists the device-level and port-level mappings that will be written to the devices:

- Device/Port Level - indicates whether the mapping is a device-level mapping (all devices) or a port-level mapping (IP address and port description). Port-level mappings on frozen ports will be enforced.
- VLAN - the VLAN mapped to the role.
- Role - the role mapped to the VLAN.

**Authentication Based VLAN (RFC 3580) to Role Mapping** - Lists the mappings that will be written to the devices:

- VLAN - the VLAN mapped to the role.
- Role - the role mapped to the VLAN.

## Event Log Button

Opens the [Events tab](#) filtered to display events with an **Event Type** of **Policy**.

## Enforce Button

[Enforces](#) the roles, classification rules and VLANs in the current data file to the devices, based on the level of support available on the devices as indicated in the **Enforce Preview** window.

## Related Information

For information on related concepts:

- [Enforcing](#)

## Import from Domain

This window lets you import policy configuration data from one [Policy Domain](#) into another domain. To access the Import from Domain window, select **Open/Manage Domain > Import/Export > Import From Domain**. (This menu option is not available if only one domain exists, as there are no other domains from which to import data.)

Import From Domain

Domain: Embedded NAC Domain

**Data Elements to Import**

<input checked="" type="checkbox"/> Roles	<input checked="" type="checkbox"/> Class of Service	<input checked="" type="checkbox"/> Port Level Role Mapping Status
<input checked="" type="checkbox"/> Services & Rules (Local)	<input checked="" type="checkbox"/> Adv CoS Config	<input checked="" type="checkbox"/> GVRP Status
<input checked="" type="checkbox"/> Service Groups	<input checked="" type="checkbox"/> Rate Limits	<input checked="" type="checkbox"/> Do Not Use Global Rules Status
<input checked="" type="checkbox"/> Devices	<input checked="" type="checkbox"/> VLANs	<input checked="" type="checkbox"/> Domain Mode (Active/Passive)
<input checked="" type="checkbox"/> Port Groups (User-Defined)	<input checked="" type="checkbox"/> Network Resources	

Select All Deselect All

WARNING: Importing Class of Service can affect the rate limits associated to existing CoS even if only appending the imported data. Before enforcing, inspect the Classes of Service for accurate/expected Rate Limits to confirm QoS that will be enforced to your network devices.

**Application of Imported Data Elements**

Append domain data to existing elements  
 Update existing data with elements from the domain  
 Overwrite existing elements

Import Cancel

## Domain

Use the drop-down menu to select the domain whose data you want to import.

## Data Elements to Import

In this section, you can choose the specific data elements you want to import. Click **Select All** to select all the data import options at once.

### Roles

Select this option to import roles, including the role's name, description, default VLAN (access control), and default class of service. If a role's services already exist in the current domain, or if you are importing them at the same time as the role, the services are associated with the role. Otherwise, the services are not imported.

### Services & Rules (Local)

Select this option to import Local services (services that are unique to a specific domain) and their associated classification rules. When you import rules from another domain, the Policy tab checks for rule conflicts (see [Conflict Checking](#) for more information).

### Service Groups

Select this option to import service group names. If a service group's services already exist in the current domain, or if you are importing them at the same time as the service group, the services will be associated with the group. Otherwise, the services will not be imported.

### Devices

Select this option to import devices. Any devices in the .pmd file must already exist in the Extreme Management Center database or they won't be imported. (See [How to Add and Delete Devices](#) for more information on using Console to add devices to the Extreme Management Center database.) Devices that are imported are automatically assigned to the current domain and are displayed in the Policy tab Network Elements tree. If the devices being imported were already assigned to another domain, then those devices are reassigned to the current domain. Any devices that are not imported are listed in an Event Log message along with their device type and firmware version.

### Port Groups (User-Defined)

Select this option to import user-defined port groups. If you are importing a port group's ports at the same time as the port group, the ports will be associated with the port group. Otherwise, the ports are not imported.

### Class of Service

Select this option to import classes of service, role-based rate limit port groups, and transmit queue port groups. For the purposes of importing, a class of service is

defined as the class of service name, i.e., priority is not a factor in determining uniqueness. After a class of service is imported, its associated roles, services, and rules are updated. When you import class of service data, the relationship between a class of service and its priority is retained; however, rate limiting characteristics of the priorities are not imported. If you also elect to [import rate limits](#), the rate limits are imported first, then the classes of service are imported. You can then redefine the class of service priorities with some or all of the imported rate limits, if desired. Although ToS characteristics are not used to determine the uniqueness of a class of service for importing, if ToS is a part of a class of service, it is imported as an attribute of the class of service. See [append](#), [update](#) and [overwrite](#) for information on how those specific actions affect the import of classes of service.

### **Adv CoS Config**

Select this option to import the class of service configuration (basic or advanced) for the domain (whether the Advanced Class of Service Configuration option is selected).

### **Rate Limits**

Select this option to import rate limits. For the purposes of importing, a rate limit is defined as [rate + direction] when determining uniqueness. When you [append](#) or [update](#) rate limits and a duplicate rate limit exists in the current domain, any unique priority and exclusion properties of the imported rate limit replace (if appending) or are added to (if updating) those of the first duplicate rate limit in the existing [precedence](#) list. Any other duplicates on the list are not changed. Because rate limits cannot include conflicting priority values, if a priority is already being utilized by an existing rate limit, it will not be imported. If you also elect to [import classes of service](#), the rate limits are imported first, then the classes of service are imported. See [append](#) and [update](#) for information on how those specific actions affect the import of rate limits.

---

**NOTE:** ZTP+ functionality requires an ExtremeXOS device on which version 21.1 is installed.

---

**NOTE:** Only those network elements that are recognized by the existing domain can be imported as exclusions. Others are ignored.

### **VLANs**

Select this option to import VLANs.

#### **Policy VLAN Islands**

If applicable, Policy VLAN Islands and Island VLANs are imported via the Devices and VLANs options.

- If the Devices option is selected and the Policy VLAN Islands feature is enabled in the current domain as well as the imported domain, the Policy VLAN Islands will be imported. The Policy VLAN Island Base ID and Offset settings from the imported data will be used and those in the current domain will be lost.
- If the VLANs option is selected and the Policy VLAN Islands feature is enabled in the current domain as well as the imported domain, the Island VLANs are imported and are added to any existing Policy VLAN Islands.

Whenever Policy VLAN Islands are imported, all the island VLANs are recalculated and the island ranges may change. It is possible to import more islands and VLANs than can be configured. If this is the case, an error appears in the Event Log, asking that the Base ID and Offset settings be changed.

### **Network Resources**

Select this option to import network resource groups. After a Network Resource is imported, the associated services are updated. If a network resource group no longer exists after an import, the service with which it was associated is changed to a manual service on the [Automated Service tab](#) for the service.

### **Port-Level Role Mapping Status**

Select this option to import the [Port-Level Role Mappings Enabled](#) status for the domain, as specified in the Edit menu.

### **GVRP Status**

Select this option to import the GVRP status for the domain (as specified in the Edit menu).

### **Do Not Use Global Services Status**

Select this option to import the Do Not Use Global Services status for the domain, as specified in the Edit menu.

### **Domain Mode**

Select this option to import the domain mode (active or passive) as specified in the Edit menu.

## **Application of Imported Data Elements**

In this section, you can choose how you want the data elements selected above to update your current domain.

### **Append domain data to existing elements**

Select this option to import only new data elements into your current domain. If any of the selected data elements already exist in your current domain, they will not be

changed.

**Rate Limits:** A rate limit will not be appended if: 1) The Rate, Direction, and 802.1P Priority are already defined. 2) The Priority list is empty.

**CoS:** A class of service will not be appended if: 1) The name is the same as an existing class of service. 2) The class of service names are different but the rate limits for the imported class of service do not match the existing rate limit settings.

### **Update existing data with elements from domain**

Select this option to 1) replace the selected data elements that exist in your current domain with the imported data elements, and 2) import the selected data elements that don't exist in your current domain.

**Rate Limits:** A rate limit will not be updated if the rate limit and direction do not match.

**CoS:** A class of service will not be updated if: 1) The name does not match an existing class of service. 2) The class of service name matches but the rate limits for the imported class of service do not match the existing rate limit settings.

### **Overwrite existing elements**

Select this option to replace the selected data elements that exist in your current domain with the imported data elements.

**CoS:** A class of service will not be overwritten if the rate limits for the imported class of service do not match the existing rate limit settings.

---

**NOTE:** If you decide that you want to return to the previous configuration (that the import updated), you can perform a File > Read Policy Domain operation to restore the configuration, as long as you have not saved the data you imported.

---

### **Select All Button**

Selects all of the data elements.

### **Import Button**

Imports the selected data and closes the window.

---

## **Related Information**

For information on related tasks:



- [How to Create and Use Domains](#)

For information on related windows:

- [Import From File Window](#)

## Import from File

This window lets you import policy data from a .pmd file into a Policy Domain. To access the window, select **Open/Manage Domains > Import/Export > Import From File**.

### Policy Manager Data (PMD) File

Enter the name and path for the data file (.pmd) you want to import, or navigate to the file by selecting the **Select File** button.

### Data Elements to Import

In this section, you can choose the specific data elements you want to import. Click **Select All** to select all the data import options at once.

### Roles

Select this option to import roles, including the role's name, description, default VLAN (access control), and default class of service. If a role's services already exist

in the current domain, or if you are importing them at the same time as the role, the services will be associated with the role. Otherwise, the services are not imported.

### **Services & Rules (Local)**

Select this option to import Local services (services that are unique to a specific domain) and their associated classification rules. When you import rules from another domain, the **Policy** tab checks for rule conflicts (see [Conflict Checking](#) for more information).

### **Service Groups**

Select this option to import service group names. If a service group's services already exist in the current domain, or if you are importing them at the same time as the service group, the services are associated with the group. Otherwise, the services are not imported.

### **Devices**

Select this option to import devices. Any devices in the .pmd file must already exist in the Extreme Management Center database or they won't be imported. (See [How to Add and Delete Devices](#) for more information on using Console to add devices to the Extreme Management Center database.) Devices that are imported are automatically assigned to the current domain and are displayed in the Policy tab Network Elements tree. If the devices being imported were already assigned to another domain, then those devices are reassigned to the current domain. Any devices that are not imported are listed in an Event Log message along with their device type and firmware version.

### **Port Groups (User-Defined )**

Select this option to import user-defined port groups. If you are importing a port group's ports at the same time as the port group, the ports are associated with the port group. Otherwise, the ports are not imported.

### **Class of Service**

Select this option to import classes of service, role-based rate limit port groups, and transmit queue port groups. For the purposes of importing, a class of service is defined as the class of service name, i.e., priority is not a factor in determining uniqueness. After a class of service is imported, its associated roles, services, and rules are updated. When you import class of service data, the relationship between a class of service and its priority is retained; however, rate limiting characteristics of the priorities are not imported. If you also elect to [import rate limits](#), the rate limits are imported first, then the classes of service are imported. You can then redefine the class of service priorities with some or all of the imported rate limits, if desired.

Although ToS characteristics are not used to determine the uniqueness of a class of service for importing, if ToS is a part of a class of service, it is imported as an attribute of the class of service. See [append](#), [update](#) and [overwrite](#) for information on how those specific actions affect the import of classes of service.

### **Adv CoS Config**

Select this option to import the class of service configuration (basic or advanced) for the domain (whether the Advanced Class of Service Configuration option is selected).

### **Rate Limits**

Select this option to import rate limits. For the purposes of importing, a rate limit is defined as [rate + direction] when determining uniqueness. When you [append](#) or [update](#) rate limits and a duplicate rate limit exists in the current domain, any unique priority and exclusion properties of the imported rate limit replace (if appending) or are added to (if updating) those of the first duplicate rate limit in the existing [precedence](#) list. Any other duplicates on the list are not changed. Because rate limits cannot include conflicting priority values, if a priority is already being utilized by an existing rate limit, it will not be imported. If you also elect to [import classes of service](#), the rate limits are imported first, then the classes of service are imported. See [append](#) and [update](#) for information on how those specific actions affect the import of rate limits.

**Note:** Only those network elements that are recognized by the existing domain can be imported as exclusions. Others will be ignored.

### **VLANs**

Select this option to import VLANs.

#### **Policy VLAN Islands**

If applicable, Policy VLAN Islands and Island VLANs are imported via the Devices and VLANs options.

- If the Devices option is selected and the Policy VLAN Islands feature is enabled in the current domain as well as the imported domain, the Policy VLAN Islands will be imported. The Policy VLAN Island Base ID and Offset settings from the imported data will be used and those in the current domain will be lost.
- If the VLANs option is selected and the Policy VLAN Islands feature is enabled in the current domain as well as the imported domain, the Island VLANs are imported and are added to any existing Policy VLAN Islands.

Whenever Policy VLAN Islands are imported, all the island VLANs are recalculated

and the island ranges may change. It is possible to import more islands and VLANs than can be configured. If this is the case, an error appears in the Event Log, asking that the Base ID and Offset settings be changed.

### **Network Resources**

Select this option to import network resource groups. After a Network Resource is imported, the associated services are updated. If a network resource group no longer exists after an import, the service with which it was associated is changed to a manual service on the [Automated Service tab](#) for the service.

### **Port-Level Role Mapping Status**

Select this option to import the [Port-Level Role Mappings Enabled](#) status for the domain.

### **GVRP Status**

Select this option to import the GVRP status for the domain.

### **Do Not Use Global Services Status**

Select this option to import the Do Not Use Global Services status for the domain.

### **Domain Mode**

Select this option to import the domain mode (active or passive) as specified in the Edit menu.

### **Global Domain Data**

Use this option only if you want to append, update, or overwrite the globally defined services and rules in your current domain with the global domain data stored in the .pmd file you are importing. This option will modify or remove any existing global data and will affect all domains. If overwrite is selected, all current global data will be removed and replaced with the global configuration in the file, or nothing if there is no configuration defined.

### **Global Services & Rules**

Select this option to import Global services (services that are common to all domains) and their associated classification rules. When you import rules from another domain, the Policy tab checks for rule conflicts (see [Conflict Checking](#) for more information).

### **Application of Imported Data Elements**

In this section, you can choose how you want the data elements selected above to update your current domain.

---

**Append domain data to existing elements**

Select this option to import only new data elements into your current domain. If any of the selected data elements already exist in your current domain, they will not be changed.

**Rate Limits:** A rate limit will not be appended if: 1) The Rate, Direction, and 802.1P Priority are already defined. 2) The Priority list is empty.

**CoS:** A class of service will not be appended if: 1) The name is the same as an existing class of service. 2) The class of service names are different but the rate limits for the imported class of service do not match the existing rate limit settings.

**Update existing data with elements from domain**

Select this option to 1) replace the selected data elements that exist in your current domain with the imported data elements, and 2) import the selected data elements that don't exist in your current domain.

**Rate Limits:** A rate limit will not be updated if the rate limit and direction do not match.

**CoS:** A class of service will not be updated if: 1) The name does not match an existing class of service. 2) The class of service name matches but the rate limits for the imported class of service do not match the existing rate limit settings.

**Overwrite existing elements**

Select this option to replace the selected data elements that exist in your current domain with the imported data elements.

**CoS:** A class of service will not be overwritten if the rate limits for the imported class of service do not match the existing rate limit settings.

---

**NOTE:** If you decide that you want to return to the previous configuration (that the import updated), you can perform a File > Read Policy Domain operation to restore the configuration, as long as you have not saved the data you imported.

---

**Select All Button**

Selects all of the data elements.

**Import Button**

Imports the selected data and closes the window.

## Related Information

For information on related tasks:

- [How to Create and Use Domains](#)

For information on related windows:

- [Import From Domain Window](#)

## Assign Devices to Domain

---

This window lets you assign devices in the Extreme Management Center database to a Policy Domain or move devices from one domain to another. A Policy Domain contains any number of roles and a set of devices uniquely assigned to that particular domain. A device can exist in only one Policy Domain. For more information on domains, see [How to Create and Use Domains](#).

Initially, you must [add your devices](#) to the Extreme Management Center database. Once your devices are in the database, use this window to assign the devices to a Policy Domain. As soon as the devices are assigned to a domain, they display automatically in the **Policy** tab **Devices** tab. Only devices that support policy are displayed in the **Devices** tab.

To access this window, [open the domain](#) to which you want to assign devices, and select **Open/Manage Domains > Assign Devices to Domain**.

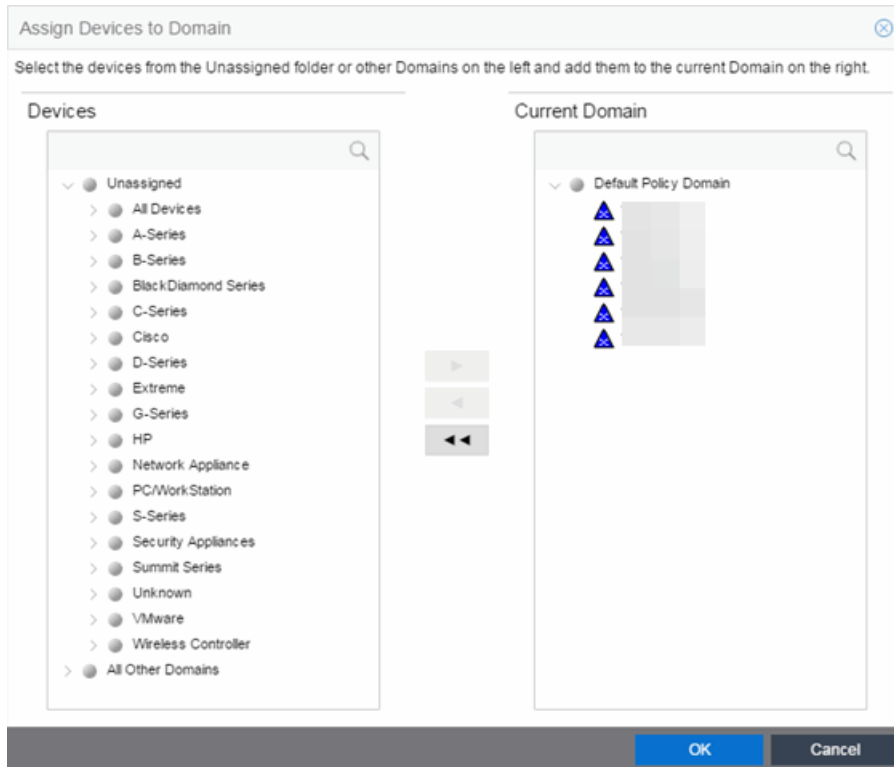

## Devices

The Devices list displays all the unassigned devices in the database (including devices that do not support policy) but are not assigned to a domain. The panel also displays any other domains and the devices assigned to that domain. Use the navigation trees to select a single domain or All Other Domains.

## Current Domain

The Current Domain list displays the current domain and the devices assigned to that domain. To add a device to the current domain, select the device in the left panel and click the right arrow. You can also select and add multiple devices. To remove a device from the current domain, select the device and click the left arrow. This removes the device from the current domain and places it back in the device tree as either unassigned or as a member of the domain it came from. To remove all devices, click the double left arrow.

## Device Domain Membership

This section is only displayed when more than one domain exists. It lists the domain assignment for whatever device or device group you have selected in the Devices panel. This is particularly useful when you have selected All Other Domains from the drop-down menu in the Devices panel, as it allows you to quickly see the domain assignment for each device.

**Right Arrow Button**

Adds the devices selected in the Devices list to the Current Domain list.

**Remove Button**

Removes the devices selected in the Current Domain list from the current domain and places it back in the Devices list as either unassigned or as a member of the domain from which it came.

---

**NOTE:** Removing a device from a domain does not delete the device from the Extreme Management Center database. To [delete a device from the database](#), right-click on the device in the **Network** tab, and select **Device > Delete Device** from the menu. When a device is deleted from the database, it is automatically removed from the **Network** and **Policy** tabs.

---

**Double Left Arrow Button**

Removes all the devices from the current domain.

**OK Button**

Assigns the selected devices to the current domain and displays the devices in the **Policy** tab's **Devices** tab. Only devices that support policy are assigned to the domain and displayed in the **Devices** tab.

---

**Related Information**

For information on related tasks:

- [How to Add and Delete Devices](#)
- [How to Create and Use Domains](#)



# Extreme Management Center Authentication Configuration

The **Authentication Configuration** wizard enables you to configure and change the [authentication](#) settings on your devices. Authentication must be configured and enabled on a device in order for individual port authentication settings to take effect (see [How to Configure Ports](#)).

To access this tab, select **Authentication Configuration** from the **Tools** drop-down menu.

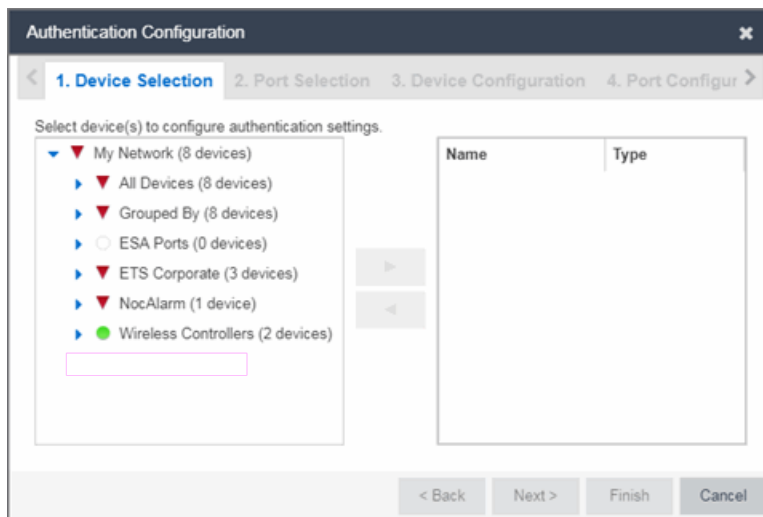

## Device Selection

Use the **Device Selection** tab to select the devices on which you are configuring authentication settings.

Select a device from the available devices list in the left of the tab and click the right arrow icon to move the device to the selected devices list. Click **Next>** to proceed to the next tab.

## Port Selection

Use the **Port Selection** tab to select the ports on which you are configuring authentication settings.

Select a port from the Available Ports list at the top of the tab and click **Add Ports** to move the port to the Selected Devices list. Click **Next>** to proceed to the next tab.

## Device Configuration

The **Device Configuration** tab allows you to configure authentication for a device. Use the **Port Configuration** tab to configure authentication settings for individual ports on the device.

### Save Device & Port Config Settings To Template

Click to save the settings you define on the **Device Configuration** and **Port Configuration** tabs to a template you can load for other devices.

### Load Device & Port Config Settings From Template

Click to load a previously saved template of settings you previously defined on the **Device Configuration** and **Port Configuration** tabs.

## Authentication Status

Use this section to select the authentication mode and types used on the device.

Authentication Status <span style="float: right;">⊖</span>			
Multi-Auth Mode:	Multi-Auth	Auth Type Precedence (High->Low):	AT/Q/WB/MAC/CEP
MAC:	Enabled	Re-Auth Timeout Action:	Terminate
802.1X:	Disabled	RFC3580 VLAN Authorization:	Enabled
Web-Based:	Disabled		
CEP:	Disabled		
Quarantine:	Disabled		
Auto Tracking:	Disabled		

Use the fields on the left side of this section to select the appropriate single- or multi-user authentication types. Only options supported by the selected device are available for selection. Some devices support multiple authentication types and multiple users (Multi-User Authentication) per port, while others are restricted to only one or two authentication types and single users per port. Refer to the

Firmware Support tables for information on the authentication types supported by each device type.

---

**WARNING:** Switching Authentication Types, or changing the Authentication Status from Enabled to Disabled, logs off any currently authenticated users.

---

### **Auth Type Precedence (High->Low)**

This displays the order in which the authentication types are attempted on the device, with the authentication type on the left having the highest precedence (attempted first). You can edit the precedence order by clicking the field. In the Edit Precedence window, select the authentication type you want to position, and use the **Up** and **Down** buttons to arrange the types in the desired order of precedence.

---

**WARNING:** Leave the default precedence, if possible. Changing the Quarantine precedence to be lower than any other type or changing the Auto Track precedence to be higher than any other type may cause problems.

---

### **Re-Auth Timeout Action**

This setting defines the action for sessions that need to be re-authenticated if the RADIUS server re-authentication request times out. Select the **Terminate** option to terminate the session or the **None** option to allow the current session to continue without disruption.

### **Maximum Number of Users**

This setting applies to devices with Multi-User as their configured authentication type. The maximum number of users that can be actively authenticated or have authentications in progress at one time on this device. You can specify the maximum number of users per port on the port's [Port Properties Authentication Configuration tab](#).

### **RFC3580 VLAN Authorization**

This allows you to enable and disable RFC 3580 VLAN Authorization for the selected device. RFC 3580 VLAN Authorization must be enabled on devices in networks where the RADIUS server is configured to return a VLAN ID when a user authenticates.

When RFC 3580 VLAN Authorization is enabled:

- devices that do **not** support policy tag packets with the VLAN ID.
- devices that support both policy and [Authentication-Based VLAN to Role Mapping](#) classify packets according to the role to which the VLAN ID maps.

## Global Authentication Settings

This section lets you set session timeout and session idle timeout values for each authentication type.

Global Authentication Settings		Session Idle Timeout	
Session Timeout:		MAC:	300
MAC:	0	802.1X:	300
802.1X:	0	Web Based:	300
Web-Based:	0	CEP:	300
CEP:	0	Quarantine:	0
Quarantine:	0	Auto Tracking:	300
Auto Tracking:	0		

### Session Timeout

This setting represents the maximum number of seconds an authenticated session may last before automatic termination of the session. A value of zero indicates that no session timeout applies. This value may be superseded by a session timeout value provided by the authenticating server. For example, if a session is authenticated by a RADIUS server, that server may send a session timeout value in its authentication response.

---

**NOTE:** Non-zero values are rounded to the nearest non-zero multiple of 10 by the device.

---

### Session Idle Timeout

This displays the maximum number of consecutive seconds an authenticated session may be idle before Extreme Management Center automatically terminates the session. A value of zero indicates that no idle timeout applies. This value may be superseded by an idle timeout value provided by the authenticating server. For example, if a session is authenticated by a RADIUS server, that server may send an idle timeout value in its authentication response.

## MAC Authentication Settings

This section enables you to set up the MAC password for [MAC authentication](#). In order for MAC authentication to work, you must also configure the RADIUS server with the MAC password as well as the MAC addresses which are allowed to authenticate.

MAC Authentication Settings	
<input checked="" type="checkbox"/> Set Password/Mask:	
MAC User Password:	<input type="password"/>
MAC Mask:	FF:FF:FF:FF:FF:FF
MAC Address Delimiter:	N/A

**Set Password/Mask**

Select this checkbox to set a password and mask for MAC authentication.

**MAC User Password**

The password passed to the RADIUS server for MAC authentication.

**MAC Mask**

You can select a mask to provide a way to authenticate end-systems based on a portion of their MAC address. For example, you could specify a mask that would base authentication on the manufacturers ID portion of the MAC address. The MAC Mask is passed to the RADIUS server for authentication after the primary attempt to authenticate using the full MAC address fails.

**MAC Address Delimiter**

The character used between octets in a MAC address:

- **None** — No delimiter is used in the MAC address (e.g. xxxxxxxxxxxx).
- **Hyphen** — A hyphen is used as a delimiter in the MAC address (e.g. xx-xx-xx-xx-xx-xx).

## Web Authentication Settings

For users of web-based authentication, this tab lets you specify web authentication parameters using three sections:

- [General](#)
- [Guest Networking](#)
- [Web Login](#)

### General

The General section lets you specify the URL of the authentication web page and the IP address of the system where it resides. It also lets you enable certain web authentication features, such as Enhanced Login Mode, on devices that support those features.

Web Authentication Settings	
General	
Enhanced Login Mode:	Disabled
Enhanced Mode Redirect Time(s):	5
WINS/DNS Spoofing:	N/A
Logo Display Status:	Show
Authentication Protocol:	PAP
Web Authentication URL: http://	
Web Authentication IP Address:	0.0.0.0
Guest Networking	
Web Page Banner	

### Enhanced Login Mode

Enabling the Enhanced Login Mode causes the authentication web page to be displayed regardless of whether the URL or IP address entered into the browser by the end user is the designated Web Authentication URL or IP address. This option is grayed out if the device does not support the mode.

### Enhanced Mode Redirect Time(s)

This setting applies for devices with [Enhanced Login Mode](#) enabled. It specifies the amount of time (in seconds) before the end-user is redirected from the authentication web page to their requested URL.

An end-system using DHCP requires time to transition from the temporary IP address issued by the authentication process to the official IP address issued by the network. **Enhanced Mode Redirect Time** specifies the amount of time allowed for the end-system to complete this process and begin using its official IP address.

For example, if an end-user (in **Enhanced Login Mode** and a **Redirect Time of 30 seconds**) enters the URL of "http://ExtremeNetworks.com", the user is presented the authentication web page. When the user successfully authenticates into the network, the user sees a login success page that displays "Welcome to the Network. Completing network connections. You will be redirected to http://ExtremeNetworks.com in approximately 30 seconds."

### WINS/DNS Spoofing

This setting allows you to enable and disable WINS/DNS spoofing for the selected device. Spoofing allows the end-user to resolve the Web Authentication URL name

to the IP address using WINS/DNS. The default is Disabled. This option is grayed out if not supported by the device.

### **Logo Display Status**

Specifies whether the Extreme Networks logo is displayed or hidden on the authentication web page window. This option is grayed out if not supported by the device.

### **Authentication Protocol**

This setting is the authentication protocol being used (PAP or CHAP). PAP (Password Authentication Protocol) provides an automated way for a PPP (Point-to-Point Protocol) server to request the identity of user, and confirm it via a password. CHAP (Challenge Handshake Authentication Protocol), the more secure of the two protocols, provides a similar function, except that the confirmation is accomplished using a challenge and response authentication dialog.

### **Web Authentication URL**

This is the URL for your authentication web page. Users wishing to receive network services access the web page from a browser using this URL. The **http://** is supplied. Alphabetical characters, numerical characters and dashes are allowed as part of the URL, but dots are not. The URL needs to be mapped to the Web Authentication IP address in DNS or in the hosts file of each client. It must be resolvable via DNS/WINS, either on the device or at corporate, assuming the Web Authentication mapping has been set up on the corporate DNS/WINS service. This option is grayed out if not supported by the device.

### **Web Authentication IP Address**

This is the IP address of your authentication web page server. If you have specified a Web Authentication URL, the IP address needs to be mapped to the URL in DNS or in the host file of each client.

## Guest Networking

The **Guest Networking** section lets you configure guest networking, a feature that allows any user to access the network and obtain a guest policy without having to know a username or password. The user accesses the authentication web page, where the username and password fields are automatically filled in, allowing them to log access as a guest. If the user does not want to log in as a guest, they can type in their valid username and password to log in.

---

**NOTE:** Guest networking is designed for networks using web-based authentication, with [port mode](#) set to Active/Discard.

---

Web Authentication Settings

General

Guest Networking

Guest Networking Status:

Guest Name:

Guest Password:

Web Page Banner

## Guest Networking Status

Use the drop-down list to specify guest networking status:

- **Disable** — Guest networking is unavailable.
- **Local Auth** — Guest Networking is enabled. The user accesses the authentication web page where the username field is automatically filled in with the specified [Guest Name](#). Once the user submits the web page using this guest name, the default policy of that port becomes the active policy. The port mode must be set to Active/Discard mode.
- **RADIUS Auth** — Guest Networking is enabled. The user accesses the authentication web page, where the username field is automatically filled in with the specified [Guest Name](#), and the password field is masked out with asterisks. Once the user submits the web page using these credentials, the value of the [Guest Password](#) is used for authentication. Following successful authentication from the RADIUS server, the port applies the policy (role) returned from the RADIUS server. The port mode must be set to Active/Discard mode.

## Guest Name

The username that Guest Networking uses to authenticate users. The guest name is displayed automatically on the authentication web page. If the user does not want to log in as a guest, they can type in their valid username to override the guest username.

## Guest Password

The password that Guest Networking uses to authenticate users when [RADIUS Auth](#) is selected.

## Web Page Banner

The Web Page Banner section allows you to customize the banner end users see at the top of the authentication web page and set a Redirect Time, if applicable.



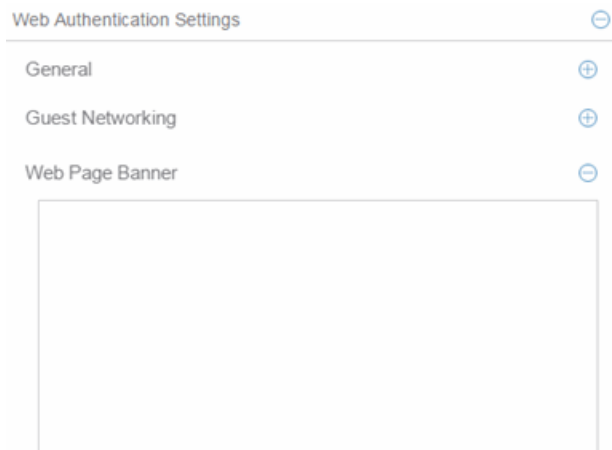

### Web Page Banner

Use this area to create a banner end users see at the top of the authentication web page. For example, you might include your company name and information on what to do if the user has questions or problems. Because this banner also appears in messages that occur during successful login and failed authentication, as well as on the "Radius Busy" screen, it is not appropriate to include "Welcome to [Your Company]" in the banner.

The **Default** button allows you to reset the banner to default text provided in a text file (pwa\_banner.txt). Initially, the default banner text is the Extreme Networks contact information. However, you can customize the text for your network by editing the pwa\_banner.txt file, located in the top level of the Policy Manager install directory. Then, when you click the Default button, the new text will be displayed in the Web Page Banner area.

## Convergence End-Point Settings

This section provides a way to identify Convergence End-Points (IP phones) connecting to the device, and apply a role to the end-point based on the type of end-point detected. The CEP Detection section lets you create detection rules for identifying the end-points, and the CEP Role Mappings section lets you map a role to each CEP product type.

In addition to configuring CEP on the device, you must also enable CEP protocols on each port using the CEP Access section in the [Port Authentication Tab](#). Once you have configured CEP on the device and each port, you can monitor CEP usage on the Port Usage Tab (Port) or Port Usage Tab (Device).

## CEP Role Mappings

This section lets you select the CEP product types supported on the device, and map a role for each type. Then, when a convergence end-point (such as an IP phone) connects to the network, the device identifies the type of end-point (using CEP detection rules) and applies the assigned role.

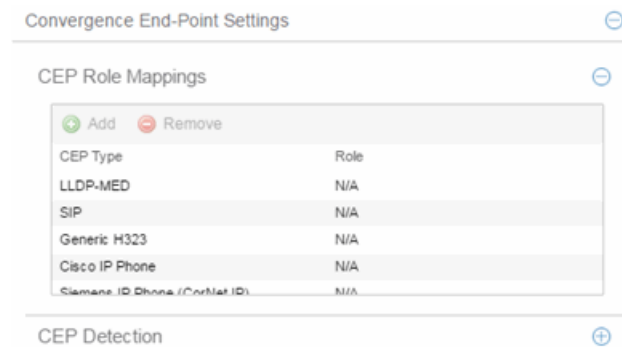

### CEP Type

Lists the CEP types supported by the device.

### Role

Lists the role mapped to each **CEP Type**.

### Add

Select a CEP Type and click the **Add** button to open the Add Role Mapping window, where you can select a role for the selected **CEP Type**. Your selections are added to the CEP Role Mappings list.

### Remove

Select the **CEP Type** and click **Remove** to remove the **CEP Type** in the CEP Role Mappings list.

## CEP Detection Tab

Use this section to create CEP detection rules used to determine if a connecting end-system is a CEP device and the type of CEP device. This allows Extreme Management Center to assign the appropriate role to the port based on the type of CEP device detected.

---

**NOTE:** CEP detection rules apply only to Siemens, H.323, and SIP (Session Initiation Protocol) phone detection. Cisco detection uses CiscoDP as its detection method.

---

CEP detection rules are based on two detection methods:

- TCP/UDP Port Number detection — Many CEP vendors use specific TCP/UDP port numbers for call setup on their IP phones. You can create detection rules that identify CEP devices based on specific TCP/UDP port numbers. By default, Siemens Hi-Path phones are detected on TCP/UDP port 4060.
- IP Address detection — H.323 phones use a reserved IP multicast address and UDP port number for call setup. You can create detection rules to detect an IP phone based on its IP address in combination with an IP address mask. By default, H.323 phones are detected using the multicast address 224.0.1.41 and the TCP/UDP ports 1718, 1719, and 1720. SIP phones are detected using the multicast address 224.0.1.75 and the TCP/UDP port 5060. H.323 and SIP phones are also detected using only their respective multicast addresses without the TCP/UDP ports.

Convergence End-Point Settings

CEP Role Mappings

CEP Detection

Priority	Address	Address Mask	End Point Type	Protocol	Port Low	Port High
1	1.2.3.4	255.255.255.255	h323	UDP + TCP	1718	1720

### Priority

The rule priority with one (1) being the highest priority. The rule with the highest priority is used first, so it is recommended the highest priority be given to the predominate protocol in the network to provide for greater efficiency.

### Address

If the rule is based on IP address detection, this field displays the IP address that incoming packets matched against. By default, H.323 uses 224.0.1.41 as its IP address, SIP uses 224.0.1.75 as its IP address, and Siemens has no IP address configured.

### Address Mask

If the rule is based on IP address detection, this field displays the IP address mask against which incoming packets are matched.

### End Point Type

Specifies the end-point type assigned (H.323, Siemens, or SIP) if incoming packets match this rule.

### Protocol

If the rule is based on TCP/UDP port detection, this field displays the protocol type used for matching, using a port range defined with the Port Low and Port High

values:

- UDP + TCP — Match the port number for both UDP and TCP frames.
- TCP — Match the port number only for TCP frames.
- UDP — Match the port number only for UDP frames.

**Port Low**

The low end of the port range defined for detection on UDP and/or TCP ports.

**Port High**

The high end of the port range defined for detection on UDP and/or TCP ports.

**Add**

Opens the [Add/Edit CEP Detection Rule window](#) where you can create CEP detection rules.

**Remove**

To remove a CEP detection rule, select the entry and click **Remove**.

**Edit**

To edit a CEP detection rule, select the rule and click **Edit**. The [Add/Edit CEP Detection Rule window](#) opens where you edit the rule's parameters. You can also double-click an entry in the table to open the edit window.

## Port Configuration

The **Port Configuration** tab allows you to configure authentication for the ports of a device.

The **Authentication Configuration** tab has six sections:

- [Authentication Mode](#)
- [RFC3580 VLAN Authorization](#)
- [Login Settings](#)
- [Automatic Re-Authentication](#)
- [Authenticated User Counts](#)
- [CEP Access](#)

## Authentication Mode

This section displays general authentication and port mode information about the port.

Authentication Mode	
Port Mode (Auth / Unauth Behavior):	Authentication Optional (Active / Default Role) ▼
MAC Auth Status:	Disabled ▼
802.1X Auth Status:	Enabled ▼
Web-Based Auth Status:	Enabled ▼
Quarantine Auth Status:	Disabled ▼
Auto Tracking Auth Status:	Disabled ▼

## Port Mode

This area displays the current port mode for the port, and allows you to change the settings if desired. Port mode defines whether or not a user is required to authenticate on a port, and how unauthenticated traffic will be handled. It is a combination of Authentication Behavior (whether or not authentication is enabled on the port), and Unauthenticated Behavior (whether unauthenticated traffic will be assigned to the port's default role or discarded). See [Port Mode](#) for a complete description of each port mode.

In addition, this section provides checkboxes that allow you to disable a specific authentication type at the port level.

### Auth/Unauth Behavior

Select an option to specify how authenticated and unauthenticated traffic is handled on the port. (See [Port Mode](#) for more information.) If you set the port's Authentication Behavior to Active (i.e., you enable authentication for the port), it is recommended that you enable the Drop VLAN Tagged Frames feature.

---

**NOTE:** Authentication Behavior must be set to **Active** for authentication to be allowed using CEP Protocols.

---

Additionally, specify whether unauthenticated traffic is assigned to the port's [default role](#) or discarded. The current default role for the port is shown. For additional information, see [Port Mode](#).

**NOTE:** For Single User 802.1X and 802.1X+MAC authentication types:

- Active/Default Role mode requires that a default role be set on the port
- Active/Discard mode requires that any default role set on the port is cleared

For Multi-User Web-based authentication Active/Discard mode is not supported.

---

### **MAC Auth Status**

Select whether to enable or disable MAC authentication at the port level. If the device is only configured with MAC authentication, selecting this checkbox will result in the port Authentication Behavior being set to Inactive.

### **802.1X Auth Status**

Select whether to enable or disable 802.1X authentication at the port level. If the device is only configured with 802.1X authentication, selecting this checkbox will result in the port Authentication Behavior being set to Inactive.

---

**NOTE:** For Single User 802.1X+MAC authentication with Active/Default Role as the selected port mode: Disabling 802.1X authentication also disables MAC authentication on the port. An end user connecting to the port will not be able to authenticate via 802.1X or MAC. The port will behave as if Inactive/Default Role is the selected port mode.

---

### **Web-Based Auth Status**

Select whether to enable or disable web-based authentication at the port level. If the device is only configured with web-based authentication, selecting this checkbox will result in the port Authentication Behavior being set to Inactive.

---

**NOTE:** For Multi-User Web-Based authentication with Active/Discard as the selected port mode: This checkbox is automatically selected because multi-user web-based authentication does not support the Active/Discard port mode.

---

### **Quarantine Auth Status**

Select whether to enable or disable Quarantine authentication at the port level. If the device is only configured with Quarantine authentication, selecting this checkbox will result in the port Authentication Behavior being set to Inactive.

### **Auto Tracking Auth Status**

Select whether to enable or disable MAC authentication at the port level. If the device is only configured with Auto Tracking authentication, selecting this checkbox will result in the port Authentication Behavior being set to Inactive.

### Apply Button

Applies any Port Mode changes to the port.

### CEP protocols in the CEP Access tab

Use the [CEP Access tab](#) to disable CEP protocols at the port level.

## RFC3580 VLAN Authorization Tab

This tab lets you enable or disable RFC 3580 VLAN Authorization on the port and specify an egress state. RFC 3580 VLAN Authorization must be enabled in networks where the RADIUS server has been configured to return a VLAN ID when a user authenticates.

When RFC 3580 VLAN Authorization is enabled:

- ports on devices that do **not** support policy tag packets with the VLAN ID.
- ports on devices that do support policy and also support [Authentication-Based VLAN to Role Mapping](#) classify packets according to the role to which the VLAN ID maps.

You can also enable and disable VLAN Authorization at the device level using the device [Authentication tab](#). If the device does not support RFC 3580, this tab is grayed out.

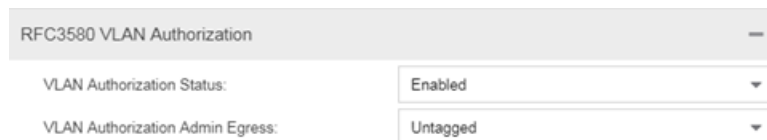

RFC3580 VLAN Authorization	
VLAN Authorization Status:	Enabled
VLAN Authorization Admin Egress:	Untagged

### VLAN Authorization Status

Allows you to enable and disable RFC 3580 VLAN Authorization for the selected port. This option is grayed out if not supported by the device.

### VLAN Authorization Admin Egress

Allows you to modify the VLAN egress list for the VLAN ID returned by the RADIUS server when a user authenticates on the port:

- None - No modification to the VLAN egress list will be made.
- Tagged - The port will be added to the list with the egress state set to Tagged (frames will be forwarded as tagged).
- Untagged - The port will be added to the list with the egress state set to Untagged (frames will be forwarded as untagged).

- Dynamic - The port will use information returned in the RADIUS response to modify the VLAN egress list. This value is supported only if the device supports a mechanism through which the egress state may be returned in the RADIUS response.

The current egress settings for the port are displayed in the [VLAN Oper Egress column](#) in the **User Sessions** tab. These options are grayed out if not supported by the device.

### Apply Button

Saves any change you made to the VLAN Authorization settings.

## Login Settings

This tab displays the current login settings for the port and allows you to change the settings if desired. The options available depend on what type(s) of authentication are enabled on the device.

Login Settings	
<b>MAC</b>	
Hold time (sec):	0
<b>802.1X</b>	
Hold time (sec):	60
Auth request period (sec):	30
User timeout (sec):	30
Auth server timeout (sec):	30
Handshake requests before failure:	2
<b>Web Auth</b>	
Max requests:	16
Hold time (sec):	60
<b>Quarantine</b>	
Session Timeout (sec):	0
Session Idle Timeout (sec):	0

### Number of Attempts Before Timeout

Number of times a user can attempt to log in before authentication fails and login attempts are not allowed. For web-based authentication, valid values are 1-2147483647, zero is not allowed, and the default is 2. For 802.1X and MAC authentication, this value is permanently set to 1.



**Hold Time (seconds)**

Amount of time (in seconds) authentication will remain timed out after the specified Number of Attempts Before Timeout has been reached. Valid values are 0-65535. The default is 60. (Hold Time is also known as Quiet Period in web-based and MAC authentication.)

**Authentication Request Period**

For 802.1X authentication, how often (in seconds) the device queries the port to see if there is a new user on it. If a user is found, the device then attempts to authenticate the user. Valid values are 1-65535. The default is 30.

**User Timeout**

For 802.1X authentication, the amount of time (in seconds) the device waits for an answer when querying the port for the existence of a user. Valid values are 1-300. The default is 30.

**Authentication Server Timeout**

For 802.1X authentication, if a user is found on the port, the amount of time (in seconds) the device waits for a response from the authentication server before timing out. Valid values are 1-300. The default is 30.

**Port Handshake Requests Before Failure**

For 802.1X authentication, the number of times the device tries to finalize the authentication process with the user before the authentication request is considered invalid and authentication fails. Valid values are 1-10. The default is 2.

**Quarantine Session Timeout (sec)**

For Quarantine authentication, the maximum number of seconds an authenticated session may last before automatic termination of the session. A value of zero indicates that no session timeout will be applied.

**Quarantine Session Idle Timeout (sec)**

For Quarantine authentication, the maximum number of consecutive seconds an authenticated session may be idle before automatic termination of the session. A value of zero indicates that the device level setting is used.

**Auto Tracking Session Timeout (sec)**

For Auto Tracking sessions, the maximum number of seconds a session may last before automatic termination of the session. A value of zero indicates that the device level setting is used.

### Auto Tracking Session Idle Timeout (sec)

For Auto Tracking sessions, the maximum number of consecutive seconds a session may be idle before automatic termination of the session. A value of zero indicates that the device level setting is used.

### Apply Button

Applies the Login Settings changes to the port.

## Automatic Re-Authentication

This tab is grayed out if only web-based authentication is enabled on the device. For 802.1X and MAC authentication, the Automatic Re-Authentication tab lets you set up the periodic automatic re-authentication of logged-in users on this port. Without disrupting the user's session, the device repeats the authentication process using the most recently obtained user login information to see if the same user is still logged in. Authenticated logged-in users are not required to log in again for re-authentication, as this occurs "behind the scenes."

Automatic Re-Authentication	
802.1X Re-auth Status:	Disabled
802.1X Re-auth Frequency (sec):	3600
MAC Re-auth Status:	Disabled
MAC Re-auth Frequency (sec):	3600

### 802.1X Re-auth Status

If **Active** is selected, the re-authentication feature is enabled for 802.1X authentication. If **Inactive** is selected, the re-authentication feature is disabled.

### 802.1X Re-auth Frequency (sec)

How often (in seconds) the device checks the port to re-authenticate the logged-in user via 802.1X authentication. Valid values are 1-2147483647. The default is 3600.

### MAC Re-auth Status

If **Active** is selected, the re-authentication feature is enabled for MAC authentication. If **Inactive** is selected, the re-authentication feature is disabled.

### MAC Re-auth Frequency (sec)

How often (in seconds) the device checks the port to re-authenticate the logged in user via MAC authentication. Valid values are 1-2147483647. The default is 3600.

## Authenticated User Counts

This tab provides authenticated user-count information for devices with Multi-User as their configured authentication type. See the [device Authentication tab](#) for information on setting the device authentication type.

Authenticated User Counts	
Current Number of Users:	0
Number of Users Allowed (up to 8):	8
Number of MAC Users Allowed (up to 8):	256
Number of Quarantine Users Allowed:	256
Number of Auto Tracking Users Allowed:	256

### Current Number of Users

The current number of users actively authenticated or have authentications in progress on this interface. If **Multi-User** authentication is disabled, this number is 0. Any unauthenticated traffic on the port is not included in this count.

### Number of Users Allowed (up to 2048)

The number of users that can be actively authenticated or have authentications in progress at one time on this interface. If you set this value below the current number of users, end-user sessions exceeding that number are terminated.

**NOTE: B2/C2 Devices.** If you are configuring a single user and an IP phone per port, set this value to 2.

### Number of MAC Users Allowed (up to 2048)

The number of users that can be actively authenticated via MAC authentication, or have MAC authentications in progress at one time on this interface. The number of MAC users allowed cannot exceed the number of users allowed. If you set this value below the current number of users, end user sessions exceeding that number are terminated. If MAC is not selected as a **Multi-User** authentication type on the [device Authentication tab](#), this field will be grayed out.

### Number of Quarantine Users Allowed (up to 2048)

The number of users that can be actively authenticated via Quarantine authentication, or have Quarantine authentications in progress at one time on this interface. The number of Quarantine users allowed cannot exceed the number of users allowed. If you set this value below the current number of users, end user sessions exceeding that number are terminated. If Quarantine

Auth is not enabled on the [device Authentication tab](#), this field will be grayed out.

### Number of Auto Tracking Users Allowed (up to 2048)

The number of Auto Tracking users that can be actively authenticated or have authentications in progress at one time on this interface. The number of Auto Tracking users allowed cannot exceed the number of users allowed. If you set this value below the current number of users, end user sessions exceeding that number will be terminated. If Auto Tracking is not enabled on the [device Authentication tab](#), this field is grayed out.

## Convergence End-Point Access

This tab lists all the CEP (Convergence End-Point) protocols supported by the device on which the port resides, and lets you enable or disable them for that port. For devices that do not support CEP, the tab is blank.

**NOTE:** Port Mode Authentication Behavior must be set to **Active** (on the [General sub-tab](#)) for authentication to be allowed using these CEP Protocols.

Enable CEP protocols for multiple ports using the [Port Configuration Wizard](#). In addition to enabling protocols on the port, you must also configure CEP for the device on which the port resides. Configure CEP for a single device using the [device Authentication tab \(CEP sub-tab\)](#) or for multiple devices using the [Device Configuration Wizard](#).

Convergence End-Point Access	
Port Mode Authentication behavior should be set to Active for auth to be allowed using the enabled CEP Protocols below.	
Enable	Disable
Status	Name
Disabled	LLDP-MED
Disabled	SIP
Disabled	Generic H323
Disabled	Siemens IP Phone (CorNet IP)
Disabled	Cisco IP Phone

### CEP Access

Lists all the CEP protocols supported by the device on which the port resides. Use the checkboxes to enable or disable CEP protocols on this port. If the device does not support the CEP feature, this area is blank.

**Enable All Button**

Selects all the checkboxes and enables all the CEP protocols for this port.

**Disable All Button**

Deselects all the checkboxes and disables all the CEP protocols for this port.

**Apply Button**

Applies CEP access changes to the port.

---

**Related Information**

For information on related windows:

- [Add/Edit CEP Detection Rule Window](#)

## Policy Main Window

---

The **Control > Policy** tab main window is the central point for all **Policy** tab tasks. It is divided into a left panel and a right panel. The tabs in the left panel display hierarchical trees that represent the roles, services, network elements, devices and port groups involved in managing policies for your network. There are five left-panel tabs: Roles/Services, Class of Service, VLANs, Network Resources, and Devices. The tabbed pages in the right panel display detailed information about the item selected in the left panel.

Information on Policy tab features:

- [Dialog Boxes \(Messages\)](#)
- [Icons](#)
- [Left Panel](#)

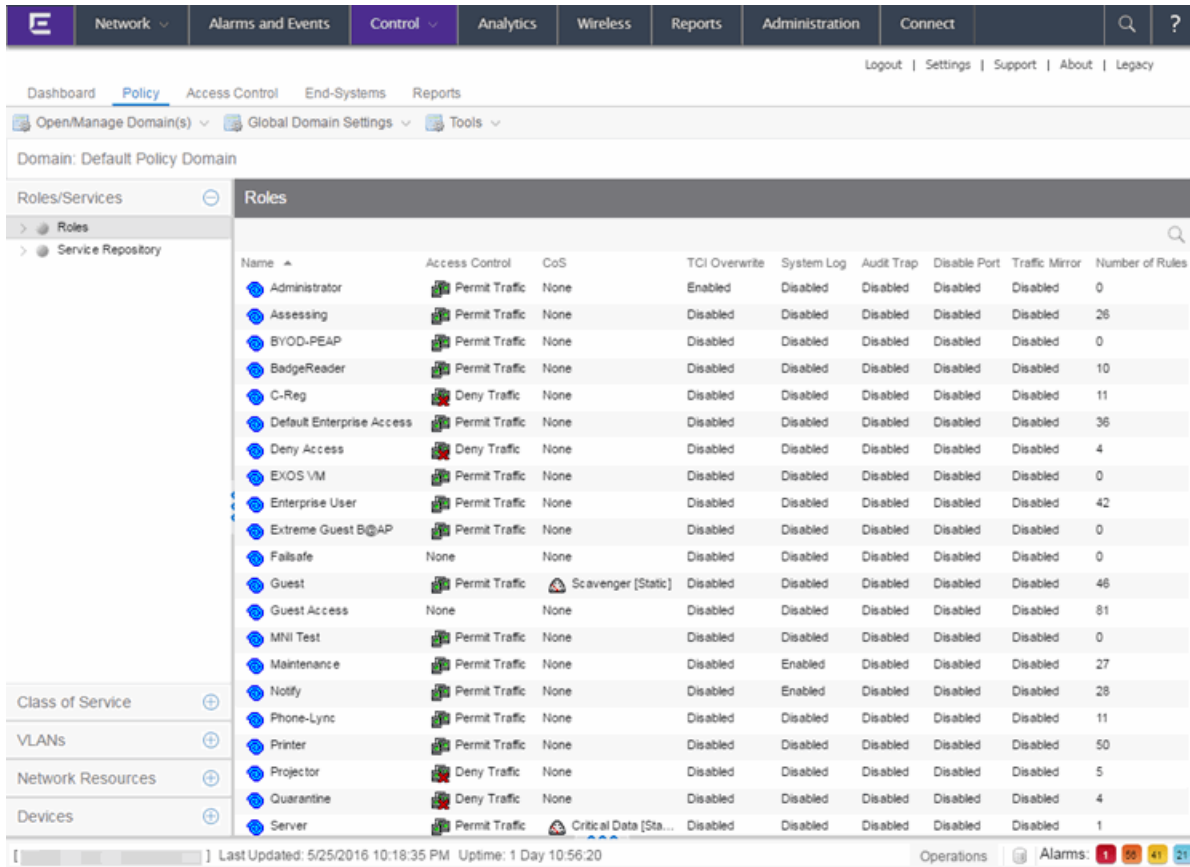

















## Dialog Boxes (Messages)

In the course of using the **Policy** tab, message dialog boxes appear confirming certain tasks are complete, or warning of the consequences of performing a certain action.

## Icons

The icons used in the **Policy** tab and their meanings are as follows:

Icon	Definition	Icon	Definition
	Pre-Defined Groups		User-Defined Groups
	Device/Wireless Device		Port Group
	Port		Frozen Port
	Role		Quarantine Role
	Rule		Disabled Rule
	Device-specific Rule		Service Group

Icon	Definition	Icon	Definition
	Automated Service		Manual Service
	Network Resource Group		Slot/Logical Ports/Ports
	Contain VLAN		Deny VLAN
	VLAN or Network Resource Island		Island VLAN
	Warning		CoS (Class of Service)
	802.1p Priority		IP Type of Service Value
	CoS Port Group		Rate Limit
	Transmit Queue		Network Resource Topology

## Open/Manage Domain Menu Icons

The following icons appear in the **Open/Manage Domains** drop-down menu:



### Lock

Reminds you the current Policy Domain is locked for editing purposes. You can lock and unlock the domain from the Lock tool bar button.



### Save

Reminds you that you've made changes, and you need to save the data to the Policy Domain. Clicking this icon initiates the save operation. Only users with the capability to Enforce are able to save the domain.



### Enforce

Reminds you that you've made changes to roles that you need to enforce. Clicking this icon initiates the enforce operation.

---

## Related Information

For information on related windows:

- [Details View Tabs](#)
- [Left Panel](#)

## Policy Windows

---

The **Windows** Help section contains Help topics describing **Policy** tab windows and their field definitions.

## Policy Concepts

---

This topic explains concepts used in the **Policy** tab.

Information on:

- [Policy](#)
- [Role](#)
  - [What is a Role](#)
  - [Default Role](#)
- [Policy Domains](#)
- [Service](#)
- [Rule](#)
  - [What is a Rule](#)
  - [Disabling Rules](#)
  - [Conflict Checking](#)
- [Packet Tagging](#)
- [VLAN to Role Mapping](#)
- [Dynamic Egress](#)
  - [Setting Domain GVRP Status](#)
- [Policy VLAN Islands](#)
- [Traffic Mirroring](#)
- [Port Groups](#)
- [Network Resource Groups](#)
  - [Network Resource Topologies](#)
- [Verifying](#)



- [Enforcing](#)
- [Controlling Client Interactions with Locks](#)

## Policy

In the **Policy** tab, network access policies are called Roles. See [Role](#), below, for a description.

## Role

### What is a Role

A role is a set of network access services that can be applied at various access points in a policy-enabled network. A port takes on a user's role when the user authenticates. Roles are usually named for a type of user such as Student or Engineering. Often, role names match the naming conventions that already exist in the organization. A role can contain any number of [services](#) in the **Policy** tab.

A role may also contain default access control (VLAN) and/or class of service (priority) characteristics that will be applied to traffic not identified specifically by the set of access services contained in the role. The set of services included in a role, along with any access control or class of service defaults, determine how all network traffic will be handled at any network access point configured to use that role.

### Default Role

Once you have created a role, assign it as the default role for a port (see [Assigning Default Roles to Ports](#)).

## Policy Domains

The **Policy** tab provides the ability to create multiple policy configurations by allowing you to group your roles and devices into Policy Domains. A Policy Domain contains any number of roles and a set of devices that are uniquely assigned to that particular domain. Policy Domains are centrally managed in the database and shared between the **Policy** tab clients.

In the **Policy** tab, you work in one current domain at a time. Each domain is identified by a unique name. The Domain menu lets you easily switch from one domain to another. There is no limit to the number of domains you can create, however, a device can exist in only one Policy Domain.

The first time you launch the **Policy** tab, you are in the Default Policy Domain. You can manage your entire network in the Default Policy Domain, or you can create multiple domains each with a different policy configuration, and assign your network devices to the appropriate domain. The roles, services, rules, VLAN membership, and class of service in this initial configuration define a suggested implementation of how network traffic can be handled. This is a starting point for a new policy deployment and often needs customization to fully leverage the power of a policy-enabled network.

The **Policy** tab ships with a set of domain configurations that provide ready-made workflows for common policy scenarios. Each domain configuration contains all the elements (roles, services, rules, VLAN membership, class of service) that define how network traffic is handled for each scenario. These domains are listed in the Open/Manage Domain menu.

You can import the data elements from one domain into another domain. You can also import a domain saved as a policy Database file (.pmd file) or data from a Database file into a domain, and you can export a domain or data from a domain to a .pmd file, (one file per domain) for backup and troubleshooting purposes. Verify and Enforce operations are performed only on the current domain.

In order for your network devices to be displayed on the left-panel **Devices** tab, they must be assigned to a Policy Domain. Initially, you must add your devices to the Extreme Management Center database. Once devices have been added to the Extreme Management Center database, you can assign the devices to a Policy Domain using the **Policy** tab. As soon as a device is assigned to a domain, it is automatically displayed on the left-panel **Devices** tab. Only devices that support policy are displayed in the **Policy** tab.



The **Policy** tab automatically locks the current Policy Domain when you begin to edit the domain configuration. Other users are notified that the domain is locked and they are not be able to save their own domain changes until the lock is released. For more information, see [Controlling Client Interactions with Locks](#). After a Policy Domain has been changed, you must save the domain to notify all clients viewing that domain of the change and automatically update their view with the new configuration.

## Service

Services are sets of [rules](#) that define how network traffic for a particular network service or application should be handled by a network access device. A service might consist of only one rule governing, for example, email priority, or it might consist of a complex set of rules combining class of service, filtering, rate limiting, and access control (VLAN) assignment. The **Policy** tab allows you to create Local Services (services that are unique to the current domain) and Global Services (services that are common to all domains). Global Services let you easily create and manage services shared between all your domains. A service can be included in any number of [roles](#).

As an example, you might create a service called `High Priority Internet Web Access` that contains priority classification rules for traffic directed toward each of your organization's Internet proxy servers. This service would likely contain one traffic classification rule for each of your Internet proxy servers.

Services can be one of two types: Manual Service or Automated Service.

- **Manual Service**  - This service consists of one or more [traffic classification rules](#) you create based on your requirements. Manual services are good for applying customized sets of rules to roles.
- **Automated Service**  - This service automatically creates a rule with a specified action (class of service and/or access control), for each device in a particular network resource group. You create a network resource group using a list of IP addresses or an IP subnet, and then associate the group with the Automated service (see [How to Create a Network Resource Group](#) for more information). Automated rule types include Layer 3 IP Address and IP Socket rules, and Layer 4 IP UDP Port and IP TCP Port rules.

Services provide a common language that network engineers, information technology administrators, and business managers understand. See [How to Create a Service](#) for more information.

## Rule

### What is a Rule

Policy rules define one element of how traffic for a particular network service or application is handled by a network access device. For example, you might create a rule that assigns a certain priority to all email traffic, by adding an

802.1p, ToS, or DiffServ value to all SMTP traffic. A policy rule can be included in any number of [services](#) and you can select the types of devices to which the rule applies. You create rules by right-clicking a Service in the **Service Repository** tab and selecting **Create Rule**.

See [Traffic Classification Rules](#) for a detailed explanation of rules.

## Disabling Rules

You can elect to disable a rule during or after its creation. If you disable a rule, it is temporarily unavailable for use by the current service, but it can still be copied to other services and enabled, or re-enabled at another time for the current service. Disabling a rule is a way to temporarily remove a rule from your service without having to delete and recreate it. You disable rules by right-clicking a Service in the **Service Repository** tab and selecting **Disable Rule**.

## Conflict Checking

As you create your Policy view services and rules, you may define conflicting rules. A conflict exists when two rules in the same service or role define different actions for the same traffic description. For example, two rules might have the same traffic description, but forward traffic to different VLANs, or have different priorities. Extreme Management Center ensures that conflicting rules do not coexist in the same role or service by checking rule traffic descriptions and action values, providing a message if conflicts are found, and writing the conflict information to the Event Log. If a rule is [disabled](#), conflicts between that rule and others are ignored.

The one exception to this conflict checking behavior, is when the conflicting rules coexist in the same role, but one rule exists in a Local service and the other exists in a Global service. In this case, the rule defined in the Local service takes precedence over the rule defined in the Global service because the Local service is specific to the current domain. Consider the following example:

In the North Campus domain you have a Local service "A" that assigns an Ethertype IP rule to the Red VLAN. The "A" service is assigned to the Student Role. In addition, a Global service "B" exists that assigns Ethertype IP rules to the Blue VLAN. The "B" service is also assigned to the Student Role. In this case, the Local service takes precedence over the Global service in the North Campus domain. Note that the precedence pertains to the rule's actions: class of service (priority) and access control (VLAN). For example, if a rule in a Local service and a rule in a Global service both have the same traffic description, and the Local

rule's actions apply CoS Priority 1 and no access control (no VLAN), while the Global rule's actions apply CoS Priority 2 and VLAN Blue(2), then the rule will be enforced using CoS Priority 1 and VLAN Blue(2). In addition, if *either* the Local or Global service has the Accounting or Security actions enabled, then they will be enforced to the devices.

## Packet Tagging

Packet tagging in a Policy view environment occurs as follows:

Tagged packets and ingress filtering are processed first. Then, VLAN ID and priority are determined.

- *VLAN ID*: If the packet matches an active VLAN classification rule on the ingress port, the VID (VLAN ID) specified in the matching VLAN classification rule is assigned. Otherwise, if there is an active role on the ingress port and it specifies a default VLAN, the default VID from the active role on the ingress port is assigned. If there is no active role and no classification rule matches, the 802.1Q PVID for the ingress port is assigned.
- *Priority*: If the packet matches an active priority classification rule on the ingress port, the priority specified in the matching priority classification rule is assigned. Otherwise, if there is an active role on the ingress port and it specifies a default priority, the default priority from the active role on the ingress port is assigned. If there is no active role and no classification rule matches, the 802.1Q\_PPRI for the ingress port is assigned.

The set of classification rules active on a port includes statically created rules that specify the ingress port on their port list, as well as any rules established as a result of a role being applied on that port. If the port has no active role and thus no default access control (VLAN) or class of service (priority), untagged packets that do not match any classification rules are assigned a VLAN and priority from the 802.1Q and 802.1p defaults for the ingress port.

For a graphical illustration of the packet tagging process in a Policy view scenario, see the [Packet Flow Diagram](#). The packet passes through the decision-making process illustrated in the graphic twice – once for VLAN tagging and once for priority tagging.

## VLAN to Role Mapping

VLAN to Role mapping lets you assign a role to an end user based on a VLAN ID. There are two kinds of VLAN to Role Mapping: Authentication-Based and Tagged Packet.

- **Authentication-Based VLAN to Role Mapping** (RFC 3580) — Provides a way to assign a role to a user during the authentication process, based on a VLAN Attribute. An end user connects to a policy-enabled device that supports 802.1X authentication using a RADIUS Server. During the authentication process, the RADIUS server returns a VLAN ID in its RADIUS VLAN Tunnel Attribute. The device uses the Authentication-Based VLAN to Role mapping list to determine what role to assign to the end user, based on the VLAN Tunnel Attribute. Authentication-Based VLAN to Role mappings are only configured at the device level (for all devices).

---

**NOTE:** When configuring Authentication-Based VLAN to role mapping, you must enable RFC3580 VLAN Authorization on the device via the device Authentication tab. In addition, VLAN IDs must be configured on the RADIUS server for each user authorized to access the network. If a user does not have a configured VLAN ID, the default role (if there is one) or the 802.1Q PVID for the ingress port is assigned. For more information on configuring VLAN ID attributes on the RADIUS server, refer to your device firmware documentation, RFC 3580, and your RADIUS server documentation.

---

- **Tagged Packet VLAN to Role Mapping** - Provides a way to let policy-enabled devices assign a role to network traffic, based on a VLAN ID. When a device receives network traffic that has been tagged with a VLAN ID (tagged packet) it uses the Tagged Packet VLAN to Role mapping list to determine what role to assign the traffic based on the VLAN ID. Tagged Packet VLAN to Role mapping can be configured at the device level (all devices) and at the port level (for an individual port on a device). A VLAN can only be mapped to one role at the device level, but the same VLAN can be mapped to a different role at the port level. A mapping does not have to exist at the device level to be created at the port level, and port-level mappings will override any device-level mappings.

---

**NOTE: TCI Overwrite Requirement**

- Tagged Packet VLAN to Role Mapping will apply the Role definition to incoming packets using a mapped VLAN. This definition will apply a COS and determine if the packet is discarded or permitted, and if TCI Overwrite is enabled will re-specify the VLAN ID defined by the Rule / Role Default. If TCI Overwrite is disabled, the packet will egress (if permitted by the Rule Hit) with the original VLAN ID it ingress with.
  - If supported by the device, you can enable TCI Overwrite for an individual role in the role's [General tab](#). The stackable devices support rewriting the CoS values but not the VLAN ID.
- 

To configure VLAN to Role Mapping in the Policy view, use the role's [Mappings tab](#) and/or the VLAN's [General tab](#).

## Dynamic Egress

In the **VLANs** tab, you can enable Dynamic Egress for a VLAN by selecting the **Dynamic Egress** checkbox when you select a VLAN.

When Dynamic Egress is enabled for a VLAN, any time a device tags a packet with that VLAN ID, the ingress port is automatically added to the VLAN's egress list, enabling the reply packet to be forwarded back to the source. This means you do not need to add the ingress port to the VLAN's egress list manually. (See [Example 1](#), below.)

Dynamic Egress affects only the egress lists for the source and destination ingress ports. However, GVRP (GARP VLAN Registration Protocol) automatically adds the interswitch ingress ports to the egress lists of VLANs. (See [Example 2](#), below.) You can enable GVRP for the domain by selecting the **Global Domain Settings > GVRP > Enable** menu option.

---

**NOTE:** If you do not want GVRP enabled on your network, you can disable it by selecting the **Global Domain Settings > GVRP > Disable** menu option. If necessary, you can then manually configure the interswitch ports to do what GVRP does automatically, using local management to set up your interswitch links as Q trunks. The trunk ports will be automatically added to the egress lists of all the VLANs at the time of trunk configuration. For more information on using GVRP in the Policy view, see the section on [Setting Domain GVRP Status](#) below.

---

When you disable Dynamic Egress for a VLAN, the VLAN effectively becomes a discard VLAN. Since the destination port is not added to the egress list of the VLAN, the device discards the traffic. If you want a VLAN to act as a discard VLAN, disable Dynamic Egress for that VLAN. (See [Example 3](#), below.)

If an endstation is talking to a "silent" endstation which does not send responses, like a printer, you need to add the silent endstation's ingress port to the VLAN's egress list manually using local management. Dynamic Egress and GVRP take care of adding the other ingress ports to the VLAN's egress list. (See [Example 4](#), below.)

**CAUTION:** If no packets are tagged with the applicable VLAN on a port within five minutes, Dynamic Egress list entries time out. The result is that an endstation appears "silent" if the VLAN has not been used within that time period. For example, if there is a "telnet" rule and two users (A and B) are on ports whose role includes a service containing the "telnet" rule, if User B has not utilized the "telnet" rule within the five minute time frame, User A is not able to telnet to User B. For this reason, the best application of Dynamic Egress is for containing undirected traffic on "chatty" clients which utilize, for example, IPX, NetBIOS, AppleTalk, and/or broadcast/multicast protocols such as routing protocols.

#### Example 1: Dynamic Egress Enabled

In this example, Dynamic Egress is enabled for VLAN 5. When source endstation A is tagged with VLAN 5, Dynamic Egress places A's ingress port (1) on VLAN 5's egress list. When destination endstation B's traffic is tagged with VLAN 5, Dynamic Egress places B's ingress port (2) on VLAN 5's egress list. The device can then forward traffic to both endstations.

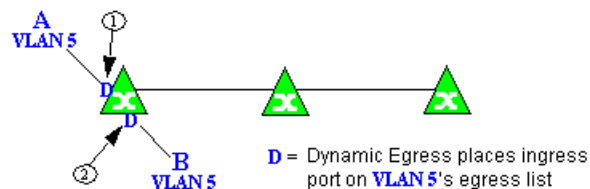

#### Example 2: Dynamic Egress + GVRP

In this example, Dynamic Egress is enabled for VLAN 5, and the destination endstation, B, is on a different device from the source endstation, A. When A is tagged with VLAN 5, Dynamic Egress places A's ingress port (1) on VLAN 5's egress list. GVRP then places interswitch ingress ports (2) and (3) on VLAN 5's egress list. When B's traffic is tagged with VLAN 5, Dynamic Egress places B's ingress port (4) on VLAN 5's egress list. GVRP then places interswitch ingress ports (5) and (6) on VLAN 5's egress list. The devices can then forward traffic to both endstations.



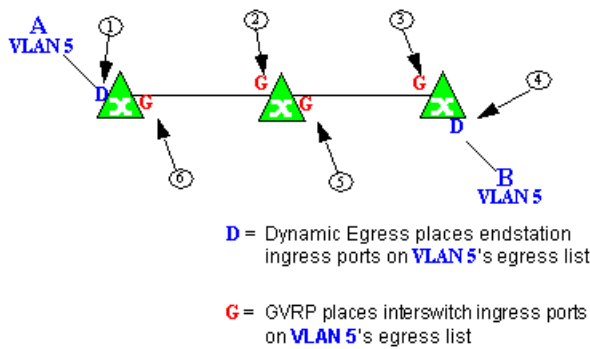

**Example 3: Dynamic Egress Disabled**

In this example, Dynamic Egress is disabled. When source endstation A is tagged with VLAN 5, A's ingress port is not placed on VLAN 5's egress list. GVRP places interswitch ingress ports (1) and (2) on VLAN 5's egress list. When B's traffic is tagged with VLAN 5, B's ingress port is not placed on VLAN 5's egress list. GVRP places interswitch ingress ports (3) and (4) on VLAN 5's egress list. But VLAN 5 traffic for both A and B is discarded, because VLAN 5 is not aware of the ingress ports for A and B.

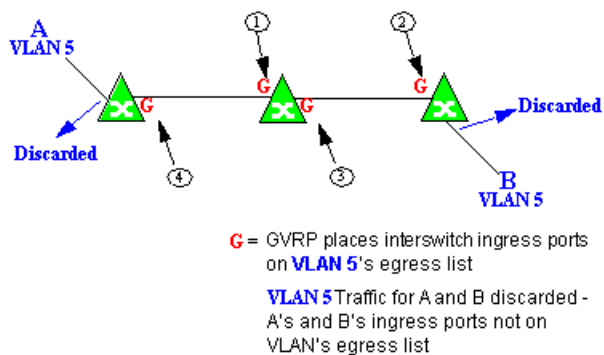

**Example 4: Silent Endstation**

In this example, Dynamic Egress is enabled for VLAN 5, but the destination endstation, B, is a "silent" endpoint, like a printer. Endstation B does not send responses, so the Administrator must place B's ingress port on VLAN 5's egress list manually (1). When A is tagged with VLAN 5, Dynamic Egress places A's ingress port (2) on VLAN 5's egress list. GVRP then places interswitch ingress ports (3) and (4), then (5) and (6) on VLAN 5's egress list. Endstation A is then able to communicate with the printer.

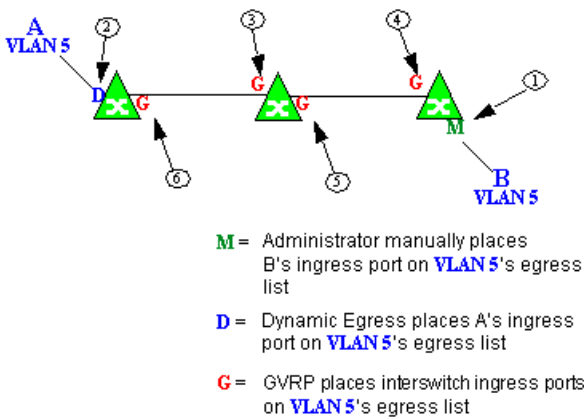

## Setting Domain GVRP Status

The Policy view allows you to set the domain GVRP (GARP VLAN Registration Protocol) status via the Edit menu. There are three GVRP status options. To set the GVRP status for all the devices in the current domain, select a status and then enforce.

- **Ignore** — When this option is selected, Extreme Management Center ignores the GVRP configuration on a device during an Enforce operation. This allows you to configure some network switches with GVRP enabled and others with GVRP disabled, according to their configuration requirements.
- **Enable** — When this option is selected, GVRP is enabled for the devices in the current domain.
- **Disable** — Select this option if you do not want GVRP enabled on the devices in the current domain. Disabling GVRP may affect connectivity through ports with VLANs that rely on Dynamic Egress. If GVRP is disabled, rules using VLAN containment may not work properly unless the VLANs have been pre-configured on the devices outside of Extreme Management Center.

The following table shows how domain GVRP status affects device-level and port-level GVRP status when an Enforce operation is performed.

Domain GVRP Status	Device Set on Enforce
Domain GVRP status is set to <b>Ignore</b> .	No GVRP status is written to devices on Enforce.

Domain GVRP Status	Device Set on Enforce
Domain GVRP status is set to <b>Enable</b> and the device-level GVRP is enabled.	No GVRP status is written to the device on Enforce.
Domain GVRP status is set to <b>Enable</b> and the device-level GVRP is disabled.	Device-level GVRP status and port-level GVRP status is set to enabled on Enforce.
Domain GVRP status is set to <b>Disable</b> and the device-level GVRP is disabled.	No GVRP status is written to the device on Enforce.
Domain GVRP status is set to <b>Disable</b> and the device-level GVRP is enabled.	Device level GVRP status is set to disabled and no change is made to the port-level GVRP status on Enforce.

## Policy VLAN Islands

The Policy view offers you the ability to set up Policy VLAN Islands which enable you to deploy a policy across your network, while restricting user access to only selected local devices. For example, if you want to have a guest VLAN but you do not want the guests in one facility to be able to communicate with guests in another facility, you can set up a VLAN island containing only selected devices in each facility, with access controlled by island VLANs.

- **Global VLAN** — Global VLANs are written to all selected devices with the same VID. They are referenced in the format <VID[name]>.
- **Island VLAN** — An Island VLAN is a conceptual VLAN and does not have an actual VID. The VID is assigned automatically based on the island it belongs to.

---

**NOTE:** The Policy view provides management of Global VLAN settings, but does not provide management of Island VLANs beyond setting the appropriate VIDs in the Role defaults and Rule access control actions. Also, you must manage separately other related settings in the qBridgeMib such as name, and dynamic egress values.

---

See [How to Create a Policy VLAN Island](#) for more information.

## Traffic Mirroring

The Policy view provides policy-based traffic mirroring functionality that allows network administrators to monitor traffic received at a particular port on the

network, by defining a class of traffic that will be duplicated (mirrored) to another port on that same device where the traffic can then be analyzed. Traffic mirroring can be configured for a rule (based on a traffic classification) or as a role default action. Only incoming traffic can be mirrored using policy-based traffic mirroring, and the traffic mirroring configuration takes precedence over regular port-based mirroring.

Traffic mirroring uses existing the Policy view port groups (created using the Port Groups tab) to specify the ports where the mirrored traffic will be sent for monitoring and analysis. When an end user connects to the device where the specified ports exist, and is assigned the role that has traffic mirroring configured, then there is a traffic mirror set up for the port the end user connected to. However, if the end user is assigned a role that does not have traffic mirroring configured, or if the end user connects to a device that doesn't have any ports in the specified port groups, then no traffic mirror will exist.

Examples of how traffic mirroring might be used include:

- Mirroring the traffic from suspicious users based on their MAC or IP address.
- Monitoring VoIP calls by IP address or port range.
- Mirroring traffic to optimized IDS systems, for example one system for all HTTP traffic (to look for suspicious websites) or one system for all emails (to look for spam).
- Mirroring traffic to Application Analytics appliances for use in Extreme Management Center application identification reports and analysis.

For information on configuring traffic mirroring, see the [Role tab](#) and the [Rule General tab](#).

## Port Groups

Extreme Management Center allows ports to be combined into groups, similar to the way services can be combined into service groups. Port groups enable you to configure multiple ports on the same device or on different devices simultaneously, or to retrieve port information from them. You can view port groups on the left-panel **Port Groups** tab.

The Policy view provides you with several commonly used port groups for your convenience, called Pre-Defined Port Groups. You can also create your own port groups, called [User-Defined Port Groups](#).

## User-Defined Port Groups

The Policy view also enables you to create your own port groups and select individual ports to add to the group.

## Network Resource Groups

Network Resource Groups provide a quick and easy way to define traffic classification rules for groups of network resources such as routers, VoIP (Voice over IP) gateways, and servers. The default Policy domain configuration contains examples of network resource groups that you might want to create, such as Internet Proxy Servers and SAP Servers. Use the Network Resource Configuration window to view and define your network resource groups. See [How to Create a Network Resource](#) for more information.

Once a network resource group has been defined, you can associate it with an [Automated service](#) (see [How to Create a Service](#) for more information). The Automated service automatically creates a rule with a specified action (class of service and/or access control), for each resource in the network resource group. Automated rule types include Layer 2 MAC Address rules, Layer 3 IP Address and IP Socket rules, and Layer 4 IP UDP Port and IP TCP Port rules.

## Network Resource Topologies

Network Resource Topologies are used to divide the devices in a domain into groups called islands. Each network resource group specifies a topology and can then define a unique resource list for each island within that topology, allowing user access to resources on the network based on the physical location at which they authenticate.

For example, you could create a topology called "Campus Printers" that could be used to restrict printer access to only the printers in the building where the end user is physically located. This topology might define islands such as "Library," "Admissions Office," or "Science Building." Each island would include the network devices for that location. Then, in the Network Resource Group that specifies this topology, there would be resource lists that define the printers for each of those islands.

In addition to defining topologies based on physical location (such as geographic region, corporate offices, or campus buildings) a topology could also be used to define resources based on the departments within a company (such as Sales, IT, or Human Resources).

When you create a topology, it contains a Default Island that includes all the devices in your domain. You can then create additional islands and distribute your devices between the different islands according to your needs. Each device in a domain must belong to one island in each topology. You can set any island as the Default island for new devices that are added to the domain.

## Verifying

The Verify feature lets you verify that the roles in your current domain have been enforced. Verify operations are performed only on the current domain. The Verify operation compares the roles currently in effect ([enforced](#)) on your domain devices with the roles defined in the current Policy Domain.

---

**NOTE:** If you perform a Verify operation following an Import Policy Configuration from Device, the Verify may fail. This is because the import operation imports only roles and rules from the device, not the complete policy configuration. Also, when you import device-specific rules, these rules are converted to a Rule Type of "All Devices," and this will cause Verify to fail. If you want the rules to be device-specific, you will have to change their Rule Type via the Rule General tab after the import and prior to Enforce.

---

You can verify using the [Open/Manage Domain > Verify Domain](#) menu option, both of which verify the information on all the devices in the current domain. You can also selectively verify on individual devices or device groups in the domain by right-clicking the device or group in the left panel or in the right-panel Details View tab for the Devices folder or Device Group folder, and choosing **Verify** from the menu.

After verifying, you see a window that reports any discrepancies. The title bar of the window lets you know if the verify was done on all devices in the domain, or a subset of devices. From this window, you can select **Enforce Domain** to open the Enforce Preview window, where you can view the effects [enforcing](#) the current role set would have, prior to actually enforcing. You can also view the full results of the Verify operation in the event log, which displays any discrepancies and statistics of the operation itself.

## Enforcing

In the **Policy** tab, enforcing means writing role information to a device or devices. Enforce operations are performed only on the current domain. Any time you add, make a change to, or delete a role or any part of it (any of its services and/or rules), the devices in your current domain need to be informed of the

---

change, otherwise the role will not take effect. To determine if the roles currently in effect on your domain devices match the set of roles you have defined in your current Policy Domain configuration, use the [Verify](#) feature.

---

**NOTE: Setting up Profiles and Credentials for Enforce.** All SNMP operations that are performed from the Policy view client use the SNMP credentials of the logged-in user. For example, when devices are identified, the credentials associated with the user's group are used to communicate with the devices. However, the Enforce operation occurs on the server and uses the Extreme Management Center Administrator profile to communicate with devices. Because of this, the Extreme Management Center Administrator profile must have write privileges on the devices that users can enforce.

---

When an Enforce is initiated, the Policy Domain is locked to prevent other clients from enforcing at the same time. Different Policy Domains can be enforced at the same time, but if another user attempts to enforce the same domain at the same time, that user will be notified that the domain is already locked.

To enforce, select the [Open/Manage Domains > Enforce Domain](#) menu option. You can also selectively enforce on individual devices by right-clicking the device in the **Devices** tab left panel or in the right-panel **Devices** tab and choosing **Enforce** from the menu. Only users that have been assigned the Enforce capability are allowed to perform an Enforce.

## Controlling Client Interactions with Locks

Because the Policy view uses a Client/Server architecture, it is important to maintain a proper sequence of client interactions to ensure a consistent view of Policy Domains among all clients. To do this, the Policy view uses Server Locks to manage user interactions. When a user begins editing a Policy Domain (for example by assigning devices or adding a role), a lock is acquired for that domain at the server. That lock is not released until the same user saves the domain data. This guarantees a consistent view of that domain for all clients. Users are given the option of revoking locks held by other users. This protects against the possibility that users may forget they have locked a domain and keep that lock for an extended period of time.

A domain is locked automatically when a user begins to edit the domain data or a user can lock/unlock a domain by clicking the Lock toolbar button. When a domain is locked, the title bar states that the policy data is being edited and specifies the user who has locked the domain. Other Policy view clients are

notified that the domain is locked and they will not be able to save their own domain changes until the lock is released.

Here are some important things to remember about locks:

- Locks operate on individual Policy Domains. When a user edits a domain, a lock is acquired for that domain and it remains locked until the same user saves the domain data or the lock is revoked by another user. You cannot save a domain that is locked by another user.
- During Enforce, a lock is acquired on the domain which is being enforced. This ensures a consistent view of the domain while it is being used by the server.
- When devices are being assigned to a Policy Domain, multiple domains may be locked concurrently. This will happen if devices from one domain are being reassigned to another domain. In this case, locks for both domains are acquired.
- When a lock is revoked, the last domain save "wins." While consistency is always maintained by the server, the order of domain saves cannot be guaranteed when locks are revoked, and consequently work done by one user may be lost.

You can view server locks for all clients via the Options > [Server Information tab](#).

---

## Related Information

For information on related concepts:

- [Traffic Classification Rules](#)

For information on related tasks:

- [Creating a Role](#)
- [How to Create a VLAN](#)

For information on related windows:

- [Create VLAN Window](#)



## Extreme Management Center Policy Tab Right-Panel

---

The **Policy** tab main window is divided into two panels: a left panel and a right panel. The Right-Panel Tabs Help section contains Help topics describing the tabs and their field definitions.

The right panel displays different tabs and information depending on the item selected in the left-panel tree. Help topics for right-panel tabs are named in a manner to reflect this. For example, the help topic named Details View Tab (Device Group), provides information on the right-panel **Details View** tab when a device group is selected in the left-panel tree.

## Policy Left Panel

---

The left panel of the **Policy** tab contains tabs that display hierarchical trees representing the roles, services, classes of service, VLANs, network resources, devices, and port groups involved in managing policies for your network. What you select in the left panel determines what is displayed in the right panel. When you first open the Policy tab, the Roles tab is displayed in the left panel, by default.

Features of the left panel include:

- *Expanding and collapsing items in the hierarchy:* Double-click the item or its icon, or single-click the turner to the left of the icon.
- *Right-click menus:* Right-click a folder or other item in the left panel, and a menu of the options you can perform on your selection appears.

Information on the left-panel tabs:

- [Roles/Services Tab](#)
- [Network Elements/Port Groups Tab](#)
- [Access Control Configuration](#)
- [Class of Service Configuration](#)

- [Network Resources Configuration](#)
- [Devices/Port Groups](#)

## Roles/Services Tab

This tab displays the Roles and Service Repository trees.

### Roles Tree

The Roles tree lists the roles defined for the current domain. A [role](#) is a set of network access services that can be applied at various access points in a policy-enabled network.

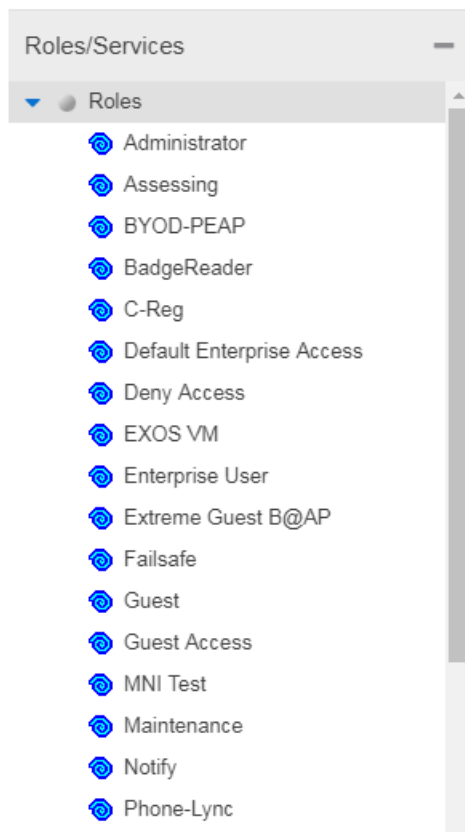

### Roles Folder

This folder contains the roles defined for the current domain. See [How to Create a Role](#) for more information.

### Role

Individual roles are listed by name. Select a role in the left panel, and view information about that role in the right-panel tabs. Only [Quarantine roles](#) are

displayed with a red icon .

## Service Repository Tree

The Service Repository tree displays your Local and Global services and service groups. [Services](#) are sets of rules that define how network traffic for a particular network service or application is handled by a network access device. Local Services are services unique to the current domain. Global Services are services common to all domains. The tab also displays your [network resource groups](#).

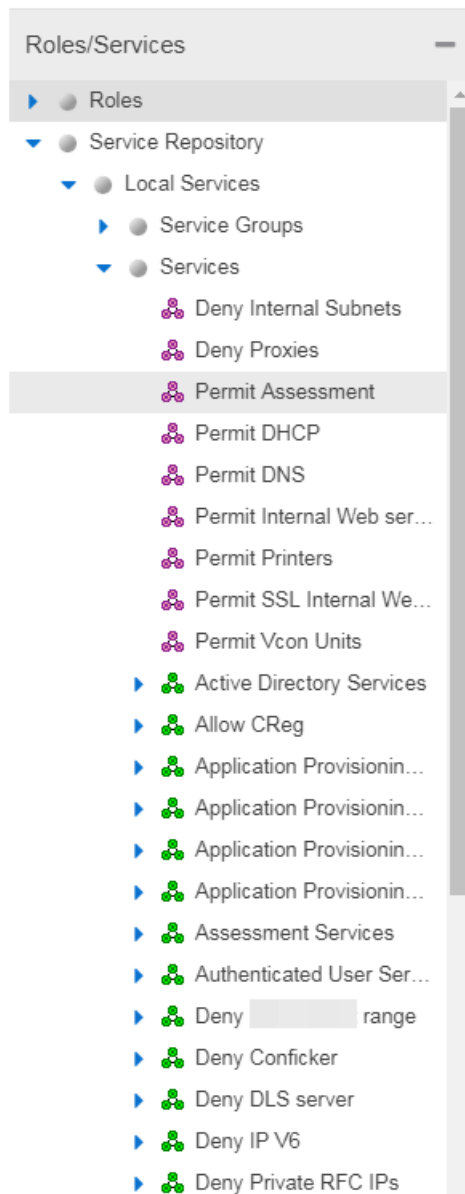

### Local Services Folder

Local Services are services unique to the current domain. This folder contains the local service groups and services defined for the current domain. For more information, see [How to Create a Service Group](#).

### Global Services Folder

Global Services are services that are common across all domains. This folder contains the global service groups and services shared by all domains. For more information, see [How to Create a Service Group](#).

### Service Groups Folder

The **Policy** tab lets you create categories (service groups) into which you can group services. This folder contains the defined service groups. For more information, see [How to Create a Service Group](#).

### Service Group

Individual service groups are listed by name. Expand the service group to see the services and service groups included in that group.

### Services Folder

This folder contains the automated and manual services that have been defined. For more information, see [How to Create a Service](#).



### Automated Service

Individual [Automated services](#) are listed under the Services Folder or within a service group in the Service Groups folder.

### Manual Service

Individual [Manual services](#) are listed under the Services Folder. Expand the service to see the rules associated with it.

### Rule

Individual rules are listed by name. If the rule is disabled, the rule icon displays a red X . If the rule is device-specific, the rule icon displays a small switch .

## Class of Service Tab

The left panel Class of Service tab displays your Classes of Service defined for the current domain.

Classes of Service prioritize traffic with an 802.1p priority, and optionally an IP type of service (ToS/DSCP) value, rate limits, and transmit queue configuration.

You can then assign the class of service as a classification rule action, as part of the definition of an Automated service, or as a role default. For more information, see [Getting Started with Class of Service](#).

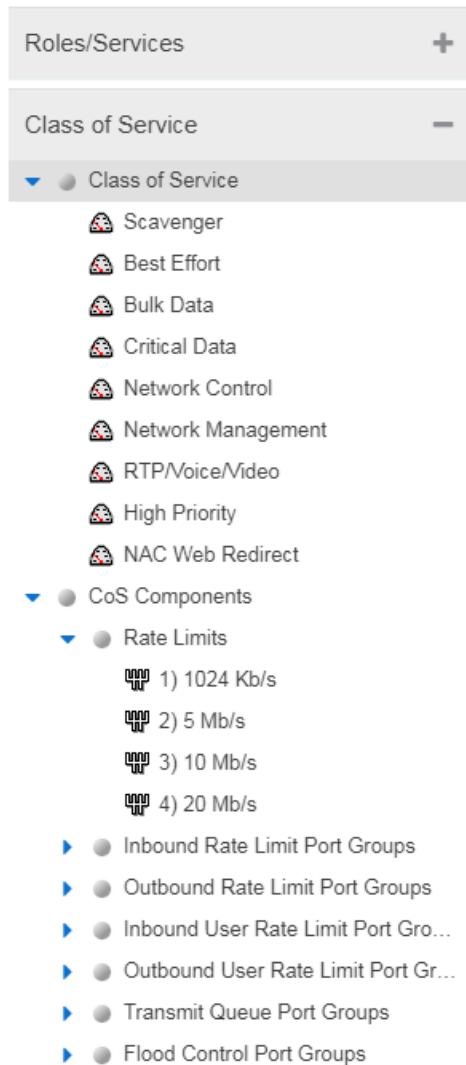

### Classes of Service Folder

When you first access the **Policy** tab, the left-panel Classes of Service tab is pre-populated with eight classes of service, each associated with one of the 802.1p priorities (0-7). These are static classes of service and cannot be deleted. You can use these classes of service as is, or configure them to include ToS/DSCP, rate limit, and/or transmit queue values. You can also rename them, if desired. In addition, you can also create your own classes of service. After you have created and defined your classes of service, they are then available when you make a class of service

selection for a rule action ([Rule tab](#)), a role default ([General tab](#)), or an automated service ([General tab](#)).

### **Class of Service**

Select a Class of Service in the left panel, and view information about that service in the right-panel tabs. For more information, see [How to Create a Class of Service](#).

### **CoS Components Folder**

This folder contains subfolders of the possible components of a class of service (Rate Limits, Inbound Rate Limit Port Groups, Outbound Rate Limit Port Groups, and Transmit Queue Port Groups).

### **Rate Limits Folder**

This folder contains the currently defined rate limits, listed in the order of precedence. For more information, see [How to Define Rate Limits](#).

### **Inbound Rate Limit Port Groups**

This folders contains the currently defined inbound rate limit port groups. Select a port group in the left panel and view information about that group in the right-panel tabs. For more information, see [Creating Class of Service Port Groups](#).

### **Outbound Rate Limit Port Groups**

These folders contain the currently defined outbound rate limit port groups. Select a port group in the left panel and view information about that group in the right-panel tabs. For more information, see [Creating Class of Service Port Groups](#).

### **Transmit Queue Port Groups Folder**

This folder contains the currently defined transmit queue port groups and the transmit queues defined for each group. For more information, see [How to Configure Transmit Queues](#).

## **VLAN Tab**

The left panel VLAN tab displays the Global VLANs for the current domain. If you have enabled Policy VLAN Islands, it also displays your Island VLANs and [Policy VLAN Islands](#).



### Global VLANs Folder

This folder contains your currently defined [global VLANs](#) for this domain.

### VLAN

The VLAN icon indicates the access control for the VLAN-- if it is a Discard VLAN, the icon displays a red X . Otherwise, it is a Contain VLAN.

### Island VLANs Folder

This folder appears only when the [Policy VLAN Islands](#) feature is enabled, and contains your currently defined [Island VLANs](#) for this domain.

### Policy VLAN Islands Folder

This folder appears only when the [Policy VLAN Islands](#) feature is enabled, and contains your currently defined VLAN islands and the devices that belong to them. When you enable Policy VLAN Islands, this folder is pre-populated with a Default Island containing all the devices in the domain.

### VLAN Island

Click on a [VLAN island](#) to see the devices associated with it listed in the right-panel Details View tab. The Default Island is created by the Policy tab when you enable Policy VLAN Islands, and it cannot be deleted.

## Network Resources Configuration

The **Network Resources** left-panel tab displays the network resources and network resource topologies for the current domain.

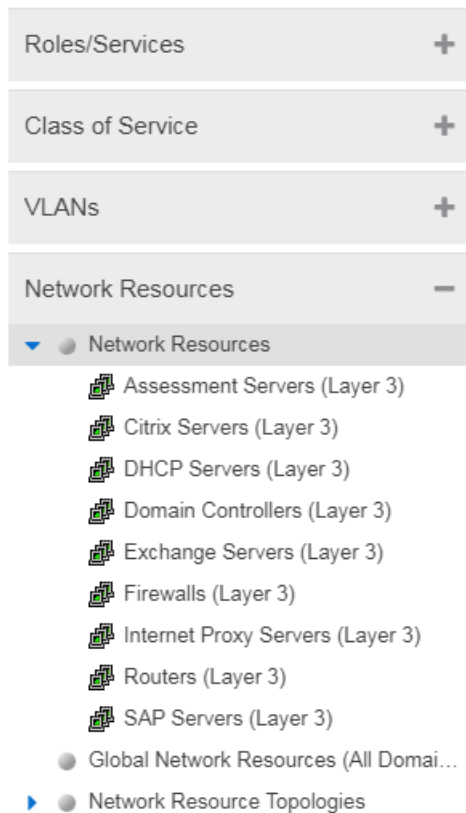

### Network Resources Folder

This folder contains any [network resource groups](#) you have created. For more information, see [How to Create a Network Resource](#).

### Network Resource

Individual network resource groups are listed by name. Select a resource in the left panel, and view information about that resource in the right-panel tabs.

### Global Network Resources Folder

Global Network Resources are network resources that are common across all domains. For more information, see [How to Create a Network Resource](#).

### Network Resource Topologies Folder

This folder contains the [network resource topologies](#) currently defined for this domain.

### Network Resource Topology

A network resource topology can be used to divide the devices in a domain into groups called islands. You can then define a unique network resource list for each island within that topology, allowing user access to resources on the network based



on the physical location at which they authenticate. If you are not using custom topologies to group your devices, you will use the Domain Wide topology, which contains just one island for all your domain devices.

### Topology Island 🌴

A topology island is a group of devices that have a unique network resource list, allowing you to set up network resource access based on the location where end users authenticate.

## Devices/Port Groups Tab

This tab displays the Devices and Port Groups trees.

### Devices Tree

The Devices tree displays the devices assigned to the current domain, organized into groups.

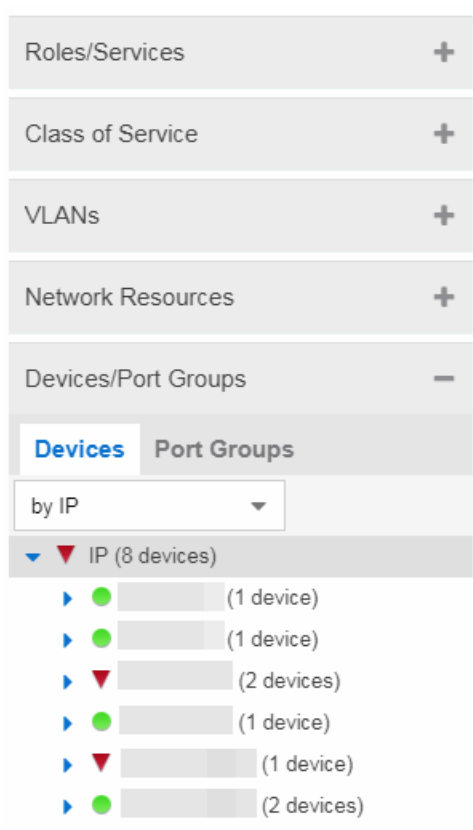

## Devices

This tab contains all the devices assigned to the current domain. For information on adding devices to the domain, see [How to Add and Delete Devices](#).

## Port Groups

This tab contains the Pre-Defined and User-Defined Port Groups for the current domain. The **Policy** tab allows ports to be combined into groups, similar to the way devices are combined into device groups. Port groups enable you to configure multiple ports on the same device or on different devices simultaneously, or to retrieve port information from them. For more information, see [How to Create a Port Group](#).

## Related Information

For information on related windows:

- [Main Window](#)
- [Right Panel](#)

## Extreme Management Center Summary (Roles)

This tab provides a summary view of the domain's roles. To access this tab, select the **Roles** left-panel tab in the Roles/Services tab. Right-click a role to add/remove services, rename the role, or delete the role.

Name	Access Control	CoS	TCI Overwrite	System Log	Audit Trap	Disable Port	Traffic Mirror	Number of Rules
Administrator	Permit Traffic	None	Disabled	Disabled	Disabled	Disabled	Disabled	0
Assessing	Deny Traffic	None	Disabled	Disabled	Disabled	Disabled	Disabled	7
Deny Access	Deny Traffic	None	Disabled	Disabled	Disabled	Disabled	Disabled	7
Enterprise User	Permit Traffic	Network Contr...	Disabled	Disabled	Disabled	Disabled	Disabled	2
Failsafe	Permit Traffic	None	Disabled	Disabled	Disabled	Disabled	Disabled	0
Guest Access	Permit Traffic	Best Effort [St...	Disabled	Disabled	Disabled	Disabled	Disabled	64
Notification	Permit Traffic	Network Contr...	Disabled	Disabled	Disabled	Disabled	Disabled	7
Quarantine	Deny Traffic	None	Disabled	Disabled	Disabled	Disabled	Disabled	7
Unregistered	Deny Traffic	None	Disabled	Disabled	Disabled	Disabled	Disabled	7

## Related Information

For information on related windows:

- [General Tab \(Roles\)](#)
- [VLAN Egress Tab \(Roles\)](#)
- [Mappings Tab \(Roles\)](#)

## Extreme Management Center General (Role)

---

The [role](#) **General** tab lets you assign default actions for a role applied to traffic not identified specifically by the set of access services contained in the role. You can also use this tab to enable TCI Overwrite functionality for the role, and enter or edit the description of the role.

The Services section displays a list of the services and service groups associated with the selected role, and provides buttons for adding and removing services, creating a new service, viewing and editing a service or service group, and showing conflicting rules.

To access this tab, select a role in the left panel's **Roles** tab, then select the **General** tab in the right panel. Any additions or changes you make to this tab must be [enforced](#) in order to take effect.

Role: Guest Access

**General** | VLAN Egress | Mappings | Port Default Usage

Name:

Description:  Edit...

TCI Overwrite:

Default Actions Show All Hide All

Services

Name ↑	Also Used By Roles
<input type="checkbox"/> Acceptable Use Policy	Enterprise User
<input type="checkbox"/> Secure Guest Access	

**Name**

Name of the selected role.

**Description**

Use the **Edit** button to open a window where you can enter or modify a description of the role.

**TCI Overwrite**

Enable or disable TCI Overwrite functionality for the role. Enabling TCI Overwrite allows the VLAN (access control) and class of service characteristics defined in this role or any of its rules to overwrite the VLAN or class of service (CoS) tag in a received packet if that packet has already been tagged with VLAN or CoS information. If TCI Overwrite is not enabled, tagged packets will egress using the TCI data they already contain. You can also enable TCI Overwrite on a per-rule basis in the [Rule Tab](#).

**Default Actions**

Default actions for a role are applied to traffic not identified specifically by the set of access services contained in the role.

### Access Control

Use the drop-down menu to choose a default access control (VLAN) for the role. You can select:

- None - No default access control specified.
- Permit Traffic - Allows traffic to be forwarded with the port's assigned VID.
- Deny Traffic - Traffic will be automatically discarded.
- Contain To VLAN - This option contains traffic to the VLAN specified. Use the drop-down list to the right to select the desired VLAN. You can also select the NSI (Network Service Identifier) to extend the VLAN address space. The NSI is Extreme Management Center's implementation of a VXLAN, which increases the number of available VLANs.

### Class of Service

Use the drop-down list to choose a default class of service (priority) for the role, create a new class of service, or select None if no class of service is desired. The drop-down list displays all of the classes of service for the current domain and also allows you to edit a class of service using the Edit button .

### System Log

When this option is enabled, a syslog message is generated as long as no matching rules specify that sending a syslog message is prohibited (that is, the rule's system log action is set to "Prohibited" on the [Rule tab](#)). When the option is disabled, the system log setting is ignored.

### Audit Trap

When this option is enabled, an audit trap is generated as long no matching rules specify that sending an audit trap is prohibited (that is, the rule's audit trap action is set to "Prohibited" on the [Rule tab](#)). When the option is disabled, the audit trap setting is ignored.

### Disable Port

When this option is enabled, the port is disabled as long no matching rules specify that disabling the port is prohibited (that is, the rule's disable port action is set to "Prohibited" on the [Rule tab](#)). Ports that have been disabled due to this option are displayed in the device Role/Rule tab. When the option is disabled, the disable port setting is ignored.

### Traffic Mirror

Use the drop-down list to specify port groups where [mirrored traffic](#) is sent for monitoring and analysis. Select View/Modify Port Groups to open the Port Groups

tab where you can define user-defined port groups for selection.

To the right of the drop-down list is an option to mirror only the first (N) packets of a flow. This option is intended for use when mirroring traffic to an Application Analytics engine. The Application Analytics engine only needs the initial packets of a flow to properly identify the traffic, and setting this option will reduce network traffic overhead for the switch and engine. By default this number is set to 10, but can be changed by clicking on the Edit button . Note that the value you set is used by all mirror actions in use in the current domain.

## Services

### Name

Lists the names of the services and service groups (local and global) associated with the selected role.

### Also Used By Roles

List the other roles using this service. If the service is a global service, the domain name is also displayed if the role is in a different domain.

### Add/Remove Services Button

Opens the role [Add/Remove Services window](#), where you can add and remove services and service groups to and from any of the existing roles.

### Show Details Button

Select a service or service group in the table and click this button to open the left-panel Services tab. The appropriate service or service group will be selected and you can access its right-panel tabs.

### Show Conflicting Rules Button

If the rules in a Global service conflict with the rules in a Local service, the Name column will display a message indicating that the global rules will be overridden by the local rules. Click on the **Show Conflicting Rules** button to open a window that displays the rule conflicts and shows specifically which rules will be used and which will be overridden. For more information, see [Conflict Checking](#).

---

## Related Information

For information on related tasks:

- [How to Create a Role](#)
- [How to Create a Class of Service](#)

## Extreme Management Center VLAN Egress (Role)

The role VLAN Egress tab displays the list of VLANs on the selected role's egress list, and allows you to add and remove VLANs and set their Egress Forwarding State. Ports that the selected role is active on forwards traffic belonging to the listed VLANs according to the specified forwarding state. Both the role's egress list and the VLAN egress list are checked for egress information. If the lists have duplications, the Forbid Forwarding state takes precedence.

To access this tab, select a role in the left panel's **Roles/Services** tab and click the **VLAN Egress** tab in the right panel. Any changes made on this tab need to be [enforced](#).

Role: Administrator		
General <b>VLAN Egress</b> Mappings		
+ Add - Remove		
VID ▲	Name	Egress Forwarding State
1	DEFAULT VLAN	Forwarding Tagged
2	VOIP	Forwarding Tagged

### VID

The VLAN ID.

### Name

The VLAN Name.

### Egress Forwarding State

Ports on which the selected role is active forward traffic belonging to this VLAN according to the egress forwarding state: Tagged (frames are forwarded as tagged), Untagged (frames are forwarded as untagged), or Forbid Forwarding (frames are not forwarded; they are discarded).

### Add

Opens the [Add Egress VLAN Window](#), where you can choose a VLAN for the role's egress list and specify the egress forwarding state.

**Remove**

Select a VLAN and click **Remove** to remove the VLAN from the list.

---

**Related Information**

For information on related windows:

- [Add Egress VLAN Window](#)

### Add Egress VLAN Window

---

The Add Egress VLAN window appears when you click the **Add** button in the role's [VLAN Egress tab](#). It allows you to add a VLAN to the Role's Egress list and specify the egress forwarding state.

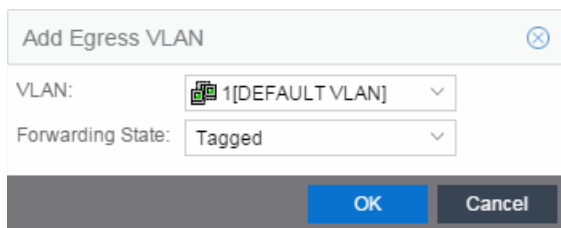

The screenshot shows a dialog box titled "Add Egress VLAN". It features two dropdown menus. The first is labeled "VLAN:" and has "1[DEFAULT VLAN]" selected. The second is labeled "Forwarding State:" and has "Tagged" selected. At the bottom of the dialog are two buttons: "OK" and "Cancel".

**VLAN**

This is a drop-down menu of the available VLANs.

**Forwarding State**

Select the desired forwarding state: Tagged (frames are forwarded as tagged), Untagged (frames are forwarded as untagged), or Forbidden (frames are not forwarded; they are discarded).

---

**Related Information**

For information on related tasks:

- [How to Create a VLAN](#)

For information on related windows:

- [Create VLAN Window](#)
- [VLAN Egress Tab \(Role\)](#)



## Extreme Management Center Mappings (Role)

This tab lets you view and configure four different mapping lists for the selected role:

- **MAC to Role Mapping** — Lets you assign the role to an end user based on the user's MAC address.
- **IP to Role Mapping** — Lets you assign the role to an end user based on the user's IP address.
- **Tagged Packet VLAN to Role Mapping** — Lets you assign the role to network traffic based on the traffic's VLAN ID.
- **Authentication-Based VLAN to Role Mapping** — Lets you assign the role to an end user during the authentication process, based on a VLAN Attribute.

To access this tab, select a role in the left-panel **Roles** tab and click the **Mappings** tab in the right panel. Any additions or changes you make to this tab must be [enforced](#) in order to take effect.

### NOTE: TCI Overwrite Requirement

-- Tagged Packet VLAN to Role Mapping applies the Role definition to incoming packets using a mapped VLAN. This definition applies a CoS and determine if the packet is discarded or permitted, and if TCI Overwrite is enabled re-specifies the VLAN ID defined by the Rule / Role Default. If TCI Overwrite is disabled, the packet egresses (if permitted by the Rule Hit) with the original VLAN ID with which it ingressed.

-- If supported by the device, you can enable TCI Overwrite for an individual role in the role's [General tab](#). The stackable devices support rewriting the CoS values but not the VLAN ID.

Role: Administrator

General
VLAN Egress
Mappings

Primary Stackable Tagged VLAN Mapping:  Edit

+ Add - Remove 🔍

Type ▲	Value	Src/Dst	Device/Port
MAC	00:11:88:fe:65:a4/48	Source	Device Level
VLAN (RFC3580)	VID: 1	N/A	N/A

**Primary Stackable Tagged VLAN Mapping**

Use this column to select the device-level VLAN to role mapping used for C2/C3/C5 and B2/B3/B5 devices (C2 firmware version 03.02.xx and higher/B2 firmware version 02.00.16 and higher), and D2, A4, and G3 devices (G3 firmware version 6.03.xx and higher). These devices only support one device-level VLAN to role mapping. If you do not make a selection, there will be no device-level mapping for these devices. Use the Mappings tab in the [Enforce Preview window](#) to quickly see which VLAN to role mapping is selected for these devices.

**Type**

This column indicates the type of mapping: [MAC to Role](#), [IP to Role](#), [Tagged Packet VLAN to Role](#), and [Authentication based VLAN to Role](#).

**Value**

The MAC addresses, IP addresses, or VLAN mapped to this role.

**Src/Dst**

Specifies whether the MAC address is a source or destination address.

**Device/Port Level**

This column indicates whether the mapping is a device-level mapping (all devices) or a port-level mapping (IP address and port description).

**Add Button**

Opens the Add Role Mapping window, where you can add a new Role mapping by entering the Mapping Type, Value, and Direction.

**Remove Button**

Remove the selected mapping from the list by clicking **Remove**.

## MAC to Role Mapping

MAC to Role mapping provides a way to assign a role to an end station based on its MAC address. This allows you to create a specific role for a group of end stations (such as IP phones), and assign it to them based on their MAC address. When the end stations connect to the network, the policy-enabled device identifies the source MAC address and applies the mapped role.

## IP to Role Mapping

IP to Role mapping provides a way to assign a role to an end station based on its IP address. For example, in networks that haven't deployed authentication, this

would allow you to map an individual IP address such as an administrator's laptop, to a specific role. When the end station connects to the network, the policy-enabled device identifies the IP address and applies the mapped role.

## Tagged Packet VLAN to Role Mapping

Tagged Packet VLAN to Role mapping provides a way to let policy-enabled devices assign a role to network traffic, based on a VLAN ID. When a device receives network traffic that has been tagged with a VLAN ID (tagged packet) it uses the Tagged Packet VLAN to Role mapping list to determine what role to assign the traffic based on the VLAN ID. For more information, see [VLAN to Role Mapping](#) in the Concepts Help topic.

## Authentication-Based VLAN to Role Mapping

Authentication-Based VLAN to Role mapping provides a way to assign a role to a user during the authentication process, based on a VLAN Attribute. An end user connects to a policy-enabled device that supports 802.1X authentication using a RADIUS Server. During the authentication process, the RADIUS server returns a VLAN ID in its RADIUS VLAN Tunnel Attribute. The device uses the Authentication-Based VLAN to Role mapping list to determine what role to assign to the end user, based on the VLAN Tunnel Attribute. Use this table to view and configure the VLANs that will map to the selected role. For more information, see [VLAN to Role Mapping](#) in the Concepts Help topic.

---

### Related Information

For information on related concepts:

- [VLAN to Role Mapping](#)

### Add/Remove Services (Roles)

---

Add and remove services and service groups from roles using the Add/Remove Services window.

To access the Add/Remove Services window, you must have a role selected in the left-panel **Roles** tab. Click the **Add/Remove** button in the Services section of the Role window.

If you add a service to a role and any or all of the following conditions exist, you are in effect adding an "empty" service, and a warning message displays when you click **OK**:

- No traffic description exists for one or more of the classification rules.
- No access control or class of service has been defined for one or more of the classification rules.
- All of the classification rules are disabled.

When you add a service to a role which already has services associated with it, the **Policy** tab checks for rule conflicts. See [Conflict Checking](#) for more information.

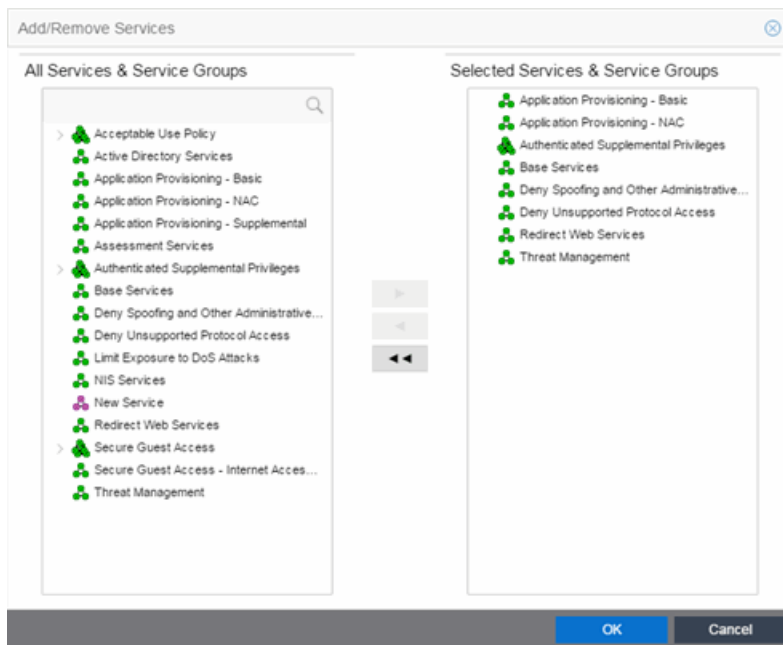

### All Services & Service Groups

This field displays all the services (local and global) and service groups in the current domain. [Select](#) the service groups or services you want to add to the role.

### Selected Services & Service Groups

This field displays all the services currently defined for the selected role. [Select](#) the services you want to remove from the role.

### Right Arrow

Click the **Right Arrow** to add the services or service groups selected in the All Services & Service Groups column to the Selected Services & Service Groups field.

### **Left Arrow**

Click the **Left Arrow** to remove the services selected in the Selected Services & Service Groups field.

### **Double Left Arrow**

Click the **Double Left Arrow** to remove all the services in the Selected Services & Service Groups field.

---

### **Related Information**

For information on related tasks:

- [Adding Services to a Role](#)
- [Removing Services from a Role](#)

## **Extreme Management Center Details View (Service)**

---

This tab displays information about the rules contained in a [Manual service](#) or an [Automated service](#). To display this tab:

1. Select a service in the left-panel's **Roles/Services > Service Repository** tab.
2. Open either the **Local Services** tab or **Global Services** tab, depending on the type of service.
3. Select a service from within the **Services** left-panel tab.

The **Details View** tab opens in the right panel. Right-click a rule in the table to see a menu of available options.

For Manual services, you can double-click on any of the table columns opens the rule's [General tab](#).

Active Directory Services													
Name	Rule Status	Rule Type	Traf Desc Type	Traf Desc Value	Access Control	CoS	System Log	Audit Trap	Disable Port	Traffic Mirror	TCI Overwrite	Quarantine Role	
Allow Global LDAP	Disabled	All Devices	IP TCP Port Destination	3268	Permit Traffic	None	Disabled	Disabled	Disabled	Disabled	Disabled	Disabled	
Allow Global Secure LDAP	Disabled	All Devices	IP TCP Port Destination	3269	Permit Traffic	None	Disabled	Disabled	Disabled	Disabled	Disabled	Disabled	
Allow LDAP - TCP	Disabled	All Devices	IP TCP Port Destination	LDAP	Permit Traffic	None	Disabled	Disabled	Disabled	Disabled	Disabled	Disabled	
Allow LDAP - UDP	Disabled	All Devices	IP UDP Port Destination	LDAP	Permit Traffic	None	Disabled	Disabled	Disabled	Disabled	Disabled	Disabled	
Allow NetBIOS - TCP	Disabled	All Devices	IP TCP Port Destination	NetBIOS Name Se...	Permit Traffic	None	Disabled	Disabled	Disabled	Disabled	Disabled	Disabled	
Allow NetBIOS - UDP	Disabled	All Devices	IP UDP Port Destination	NetBIOS Name Se...	Permit Traffic	None	Disabled	Disabled	Disabled	Disabled	Disabled	Disabled	
Allow NetBIOS - datagram	Disabled	All Devices	IP UDP Port Destination	NetBIOS Datagra...	Permit Traffic	None	Disabled	Disabled	Disabled	Disabled	Disabled	Disabled	
Allow NetBIOS session	Disabled	All Devices	IP TCP Port Destination	NetBIOS Session ...	Permit Traffic	None	Disabled	Disabled	Disabled	Disabled	Disabled	Disabled	
Allow SMB over IP - TCP	Disabled	All Devices	IP TCP Port Destination	445	Permit Traffic	None	Disabled	Disabled	Disabled	Disabled	Disabled	Disabled	
Allow SMB over IP - UDP	Disabled	All Devices	IP UDP Port Destination	445	Permit Traffic	None	Disabled	Disabled	Disabled	Disabled	Disabled	Disabled	
Allow Secure LDAP	Disabled	All Devices	IP TCP Port Destination	636	Permit Traffic	None	Disabled	Disabled	Disabled	Disabled	Disabled	Disabled	
Permit Kerberos - TCP	Disabled	All Devices	IP TCP Port Destination	88	Permit Traffic	None	Disabled	Disabled	Disabled	Disabled	Disabled	Disabled	
Permit Kerberos - UDP	Disabled	All Devices	IP UDP Port Destination	88	Permit Traffic	None	Disabled	Disabled	Disabled	Disabled	Disabled	Disabled	

### Name

Name of the rule. For rules contained in an Automated service, this column gives detailed information about the rule including the associated Network Resource (NR), if multiple resource groups are specified. You can rename a rule by right-clicking the rule and selecting **Rename**.

### Rule Status

Indicates whether the rule is currently available for use by this service (Enabled), or not (Disabled), as set in the [General tab](#) for the rule. If the rule is disabled, the rule icon displays a red X . You can enable or disable a rule by right-clicking and selecting **Enable Rule** or **Disable Rule**, respectively.

### Rule Type

Indicates the device types to which the rule applies. (See [Create Classification Rule Window](#) for more information.)

### Traf Desc Type

Traffic classification type for the rule. (See [Classification Types and their Parameters](#) for more information.)

### Traf Desc Value

Values associated with the traffic classification type for the rule. (See [Classification Types and their Parameters](#) for more information.) Double-clicking on this column opens the [Edit Rule window](#), where you can edit the parameters or values for the rule's classification type.

### Access Control

VLAN action associated with the rule. Double-clicking on this column allows you change the setting. You can permit traffic to be forwarded, deny traffic altogether, or

select a VLAN to contain traffic. Select **None** to disable access control for this rule.

### **CoS**

Class of service action associated with the rule. Double-clicking on this column allows you change the setting.

### **System Log**

Displays whether the syslog functionality (a syslog message is generated when the rule is used) is enabled, disabled, or prohibited for the rule. Double-clicking on this column allows you change the setting.

- **Enabled** - If this option is enabled, a syslog message is generated when the rule is used. This option must be enabled if you are configuring Policy Rule Hit Reporting on your devices.
- **Disabled** - If this option is disabled and this rule is hit, it does not generate a Syslog message, but lower-precedence rules and the role default actions may still specify a syslog message be sent for this data packet if there is a match.
- **Prohibited** - If this rule is hit, no syslog message is generated for this data packet, even when a lower-precedence rule or the role default actions has the System Log action set to enabled.

### **Audit Trap**

Displays whether the audit trap functionality (an audit trap is generated when the rule is used) is enabled, disabled, or prohibited for the rule. Double-clicking on this column allows you change the setting.

- **Enabled** - If this option is enabled, an audit trap is generated when the rule is used.
- **Disabled** - If this option is disabled and this rule is hit, it does not generate an audit trap, but lower-precedence rules and the role default actions may still specify generating an audit trap for this data packet if there is a match.
- **Prohibited** - If this rule is hit, no audit trap is generated for this data packet, even when a lower-precedence rule or the role default actions has the Audit Trap action set to enabled.

### **Disable Port**

Displays whether the disable port functionality (ports reported as using this rule will be disabled) is enabled, disabled, or prohibited for the rule. Double-clicking on this column allows you change the setting.

- **Enabled** - If this option is enabled, any port reported as using this rule are

disabled.

- **Disabled** - If this option is disabled and this rule is hit, it does not disable the port, but lower-precedence rules and the role default actions may still specify disabling the port for this data packet if there is a match.
- **Prohibited** - If this rule is hit, the port is not disabled, even when a lower-precedence rule or the role default actions has the Disable Port action set to enabled.

### Traffic Mirror

Displays whether the [traffic mirror](#) functionality is enabled, disabled, or prohibited for the rule. Double-clicking on this column allows you change the setting.

- **Select port group(s)** - Use the drop-down list to specify the port groups where mirrored traffic will be sent for monitoring and analysis.
- **Disabled** - If this option is disabled and this rule is hit, traffic mirroring will not take place, but lower-precedence rules and the role default actions may still specify traffic mirroring for this data packet if there is a match.
- **Prohibited** - If this rule is hit, traffic mirroring is disabled, even when a lower-precedence rule or the role default actions has the Traffic Mirror action specified.

### TCI Overwrite

Displays whether TCI Overwrite is enabled, disabled, or prohibited for the rule. Double-clicking on this column allows you change the setting.

- **Enabled** - Enabling TCI Overwrite allows the VLAN (access control) and class of service characteristics defined in this rule to overwrite the VLAN or class of service (CoS) tag in a received packet, if that packet has already been tagged with VLAN or CoS information.
- **Disabled** - If this option is disabled the TCI Overwrite option is ignored, but lower-precedence rules and the role default actions may still specify TCI Overwrite for the data packet if there is a match.
- **Prohibited** - Do not set TCI Overwrite for this data packet, even when a lower-precedence rule or the role default actions has the TCI Overwrite option set to enabled.

### Quarantine Role

Displays whether a [Quarantine role](#) is enabled, disabled, or prohibited for the rule. Double-clicking on this column allows you change the setting.

- **Select Role** - Use the drop-down list to select the role that you want to assign



as a Quarantine role.

- **Disabled** - If this option is disabled and this rule is hit, a Quarantine role will not be assigned, but lower-precedence rules may still specify a Quarantine role for this data packet if there is a match.
  - **Prohibited** - If this rule is hit, a Quarantine role will not be assigned, even when a lower-precedence rule has a Quarantine role action specified.
- 

### Related Information

For information on related concepts:

- [Traffic Classification Rules](#)

For information on related windows:

- [Rule Tab](#)

# Extreme Management Center Service Repository

---

Selecting Service Repository in the Roles/Services navigation panel in the left panel opens the Service Repository panel.

Double-click Local Services to display the service groups and services associated with the current domain or Global Services (All Domains) to display the service groups and services available to all domains.

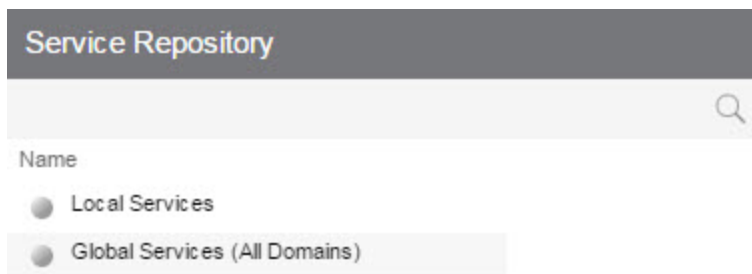

## Name

Displays the Local or Global service groups and services.

---

## Related Information

For information on related tasks:

- [How to Create a Service](#)
- [How to Create a Service Group](#)

# Extreme Management Center Local/Global Services

---

Selecting Local Services or Global Services (All Domains) in the Roles/Services > Service Repository navigation panel in the left panel opens the Local Services or Global Services (All Domains) panel, respectively.

Double-click Service Groups to display the services that are part of a service group or Services to view services not contained within a service group.



## Name

Double-click one of the options to display the Service Groups or Services.

---

## Related Information

For information on related tasks:

- [How to Create a Service](#)
- [How to Create a Service Group](#)

## Extreme Management Center Details View (Services)

This tab lists the Automated and Manual services you create in the **Policy** tab. To display the tab, expand the **Local Services** or **Global Services** left-panel tab in the **Roles/Services > Service Repository** tab, and select the **Services** tab. To see a menu of options available for a service, right-click the service.

For information on the differences between automated or manual services, and local or global services, see the Policy tab Concepts Help topic's section on [Services](#).

Services			
Name ▲	Number of Rules	Included in Roles Directly (Indirectly)	Parent Service Group(s)
 Active Directory Services	13	5	
 Application Provisioning - NAC	2	7	
 Assessment Services	1	1	
 Base Services	7	6	
 NIS Services	4	3	
 Redirect Web Services	2	5	
 Secure Guest Access - Internet Access ...	71	1	

### Name

Name of the service.

### Number of Rules

Number of rules associated with the service.

### Included in Roles Directly (Indirectly)

Number of roles in which the service is included.

### Parent Service Group

The service group in which the service is included.

## Related Information

For information on related tasks:

- [How to Create a Service](#)

## Extreme Management Center Details View (Service Group)

This tab lists information about the services or service groups contained in a **Local** or **Global** service group. To display this tab, select a service group in the left-panel **Roles/Services > Service Repository** tab.

Service Groups			
Name	Number of Rules	Included in Roles Directly (Indirectly)	Parent Service Group(s)
 Secure Guest Access	76	1	
 Acceptable Use Policy	47	2	
 Authenticated Supplemental Privileges	1	2	

### Name

The name of the service or service group.

### Number of Rules

The number of rules included in the service or service group.

### Included in Roles Directly (Indirectly)

The number of roles where the service or service group exists directly in the role's Services list (as viewed on the role's [General tab](#)). If a service group also exists indirectly in other roles as part of another service group, that number of roles is displayed in parenthesis. In the example above, the service group called "Authenticated Supplemental Privileges" displays "1 (1)" in this column, showing that it is associated directly with one role (exists in that role's services list) and is also part of a service group associated with one other role.

### Parent Service Group(s)

Displays all the "parent" service groups to which the service or service group belongs. This gives you an idea of the service group hierarchy without having to expand the left-panel tree.

## Related Information

For information on related tasks:

- [How to Create a Service](#)

## Add/Remove Services (Service Groups)

You can add and remove services from service groups using the Add/Remove Services window.

To access the Add/Remove Services window, either select the **Service Groups** tab in the **Local Services** or **Global Services** left-panel tab, right-click on a service group in the right panel and select **Add/Remove Services**. You can also right-click on a service group in the **Service Groups** left-panel tab and select **Add/Remove Services** from the menu.

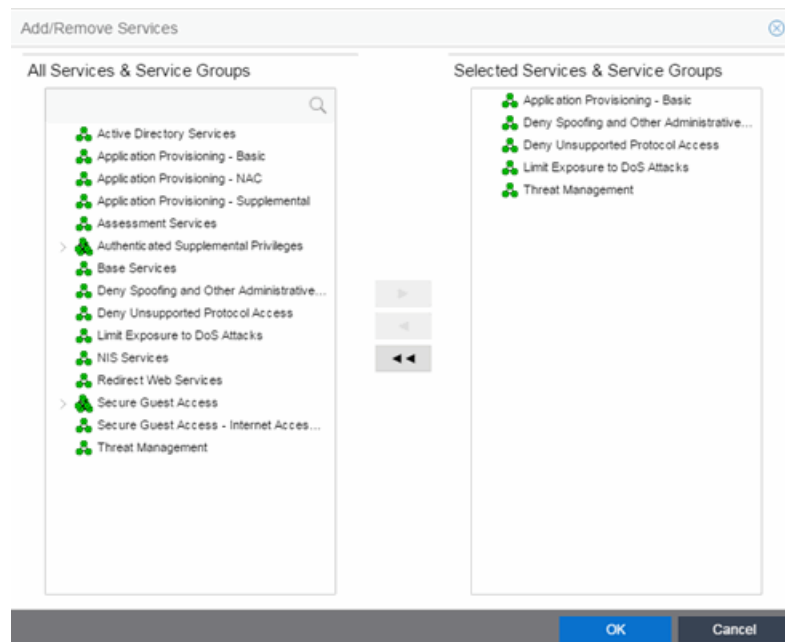

### All Services & Service Groups

This list displays all the local or global services and service groups in the current domain, depending whether you launched the window with a local or global service group selected. [Select](#) the services you want to add to the service group.

### Selected Services & Service Groups

This list displays all the services currently defined for the selected service group. [Select](#) the services you want to remove from the service group.

### Right Arrow Button

Click the **Right Arrow** button to add the services selected in the All Services & Service Groups list to the Selected Services & Service Groups list.

### **Left Arrow Button**

Click the **Left Arrow** button to remove the services selected in the Selected Services & Service Groups list.

### **Double Left Arrow Button**

Click the **Double Left Arrow** button to remove all the services from the Selected Services & Service Groups list.

---

### **Related Information**

For information on related tasks:

- [Adding Services to a Service Group](#)
- [Removing Services from a Service Group](#)

## **Extreme Management Center Rule**

---

The rule **General** tab displays general information about the rule selected for a Service in the left-panel **Roles/Services > Service Repository > Local or Global Services** tab and enables you to change it. In addition, you can view and change the Traffic Description and Actions associated with the rule. Traffic Description identifies the type of traffic to which the rule pertains. Actions apply class of service, access control, and/or accounting and security behavior to packets matching the rule.

Any additions or changes you make to this tab must be [enforced](#) in order to take effect. If you modify an enabled rule's actions, the Policy tab checks for conflicts with other rules in the services and roles with which the newly modified rule is associated. See [Conflict Checking](#) for more information.

**Rule: Discard TCP Bil 1434 - MS-SQL-M (Sapphire Worm)**

Service Name:

Description:  [Edit...](#)

Rule Status:

Rule Type:

TCI Overwrite:

---

**Traffic Description**

Type:

Value:  [Remove](#) [Edit...](#)

---

**Actions**

Access Control:  Contain to VLAN:

Class of Service:

System Log:

Audit Trap:

Disable Port:

Traffic Mirror:   Mirror First 15 packets

Quarantine Role:

## General Area

### Service Name

Displays the name of the rule.

### Description

Use the **Edit** button to open a window where you can enter or modify a description of the rule.

### Rule Status

Lets you disable the rule, or enable it if it's already disabled. If the rule is disabled, it is unavailable for use by the current service, but can still be copied to other services and enabled, or re-enabled at another time for the current service. Disabling a rule is an alternative to deleting and recreating it. The rule icon in the left panel displays a red X if the rule is disabled.

### Rule Type

Use the drop-down list to select the types of devices to which you wish this rule to apply when enforced. The recommended selection is All Devices, unless there is a specific need for a device-specific rule. If this need arises, the Rule Type feature allows services to be customized to contain rules specific to a device's type when support for a traffic description and/or action may not be available on all managed



devices.

For device-specific rules, only those traffic descriptions supported on the device are available when you define the rule's traffic description on this tab. For All Devices rules, all traffic descriptions are available; however, you must be aware that you cannot enforce the rule to a device on which it is not supported.

### TCI Overwrite

Specify the TCI Overwrite functionality for the rule:

- **Enabled** — Enabling TCI Overwrite allows the VLAN (access control) and class of service characteristics defined in this rule to overwrite the VLAN or class of service (CoS) tag in a received packet, if that packet has already been tagged with VLAN or CoS information.
- **Disabled** — If this option is disabled the TCI Overwrite option is ignored, but lower-precedence rules and the role default actions may still specify TCI Overwrite for the data packet if there is a match.
- **Prohibited** — Do not set TCI Overwrite for this data packet, even when a lower-precedence rule or the role default actions has the TCI Overwrite option set to enabled.

## Traffic Description Area

The Traffic Description area allows you to view and change the traffic description associated with a rule. The Traffic Description identifies the traffic classification type for the rule. Rules allow you to assign access control (VLAN membership) and/or class of service to network traffic depending on the traffic's classification type.

### Type

Displays the Classification Type selected for the rule.

### Value

Displays the values/parameters selected for the rule's Classification Type. See [Classification Types and their Parameters](#) for parameter information.

### Remove Button

Removes the traffic description from the rule.

## Edit Button

If a Traffic Description Type has been defined for the rule, clicking Edit opens the [Edit Rule window](#), where you can edit the parameters or values for the rule's classification type.

## Actions Area

The Actions area allows you to view and change the actions associated with a rule. Actions apply access control, class of service, security, and/or accounting behavior to packets matching the rule.

### Access Control

Use this drop-down list to select the appropriate access control for the rule. You can permit traffic to be forwarded, deny traffic altogether, or contain traffic to a VLAN. Select **None** to disable access control for this rule.

- **Permit Traffic** — allows traffic to be forwarded with the port's assigned VID.
- **Deny Traffic** — traffic will be automatically discarded.
- **Contain to VLAN** — contains traffic to a specific VLAN. Use the drop-down list to select the desired VLAN.

### Class of Service

Use the drop-down list to select a class of service to associate with the rule. The Policy tab lets you define classes of service that each include an 802.1p priority, and optionally an IP type of service (ToS/DSCP) value, rate limits, and transmit queue configuration. You can then assign a class of service as a classification rule action. See [Getting Started with Class of Service](#) and [How to Create a Class of Service](#) for more information. Select **None** to disable class of service for this rule.

When rule accounting is enabled on a device, each rule keeps a list of the ports on which it has been used. Use the following three options to specify certain rule usage actions to take place when a "rule hit" is reported.

### System Log

Specify System Log functionality for the rule. Syslog receivers are configured in the legacy Console java application. Refer to the Help topic in the Console User Guide for more information.

- **Enabled** — If this option is enabled, a syslog message is generated when the rule is used. This option must be enabled if you are configuring Policy Rule Hit Reporting on your devices.

- **Disabled** — If this option is disabled and this rule is hit, it does not generate a Syslog message, but lower-precedence rules and the role default actions may still specify a syslog message be sent for this data packet if there is a match.
- **Prohibited** — If this rule is hit, no syslog message is generated for this data packet, even when a lower-precedence rule or the role default actions has the System Log action set to enabled.

### Audit Trap

Specify Audit Trap functionality for the rule:

- **Enabled** — If this option is enabled, an audit trap is generated when the rule is used.
- **Disabled** — If this option is disabled and this rule is hit, it does not generate an audit trap, but lower-precedence rules and the role default actions may still specify generating an audit trap for this data packet if there is a match.
- **Prohibited** — If this rule is hit, no audit trap is generated for this data packet, even when a lower-precedence rule or the role default actions has the Audit Trap action set to enabled.

### Disable Port

Specify Disable Port functionality for the rule:

- **Enabled** — If this option is enabled, any port reported as using this rule will be disabled. Ports that have been disabled due to this option are displayed in the device Role/Rule tab.
- **Disabled** — If this option is disabled and this rule is hit, it does not disable the port, but lower-precedence rules and the role default actions may still specify disabling the port for this data packet if there is a match.
- **Prohibited** — If this rule is hit, the port is not disabled, even when a lower-precedence rule or the role default actions has the Disable Port action set to enabled.

### Traffic Mirror

Specify [traffic mirroring](#) functionality for the rule:

- **Select port group(s)** — Use the drop-down list to specify the port groups where mirrored traffic will be sent for monitoring and analysis. Select View/Modify Port Groups to open the Port Groups tab where you can define user-defined port groups for selection. To the right of the drop-down list is an option to mirror only the first (N)

packets of a flow. This option is intended for use when mirroring traffic to an Application Analytics engine. The Application Analytics engine only needs the initial packets of a flow to properly identify the traffic, and setting this option will reduce network traffic overhead for the switch and engine. By default this number is set to 10, but can be changed by clicking on the Edit button . Note that the value you set is used by all mirror actions in use in the current domain.

- **Disabled** — If this option is disabled and this rule is hit, traffic mirroring will not take place, but lower-precedence rules and the role default actions may still specify traffic mirroring for this data packet if there is a match.
- **Prohibited** — If this rule is hit, traffic mirroring is disabled, even when a lower-precedence rule or the role default actions has the Traffic Mirror action specified.

### Quarantine Role

Specify the [Quarantine Role](#) functionality for the rule:

- **Select Role** — Use the drop-down list to select the role that you want to assign as a Quarantine role. Specifying a role as a Quarantine role turns the role's icon red, denoting its restrictive nature.
- **Disabled** — If this option is disabled and this rule is hit, a Quarantine role will not be assigned, but lower-precedence rules may still specify a Quarantine role for this data packet if there is a match.
- **Prohibited** — If this rule is hit, a Quarantine role will not be assigned, even when a lower-precedence rule has a Quarantine role action specified.

---

### Related Information

For information on related concepts:

- [Traffic Classification Rules](#)

For information on related tasks:

- [Using the Rule Tabs](#)

## Create Rule

This window appears when you right-click a service group or the **Services** tab in the left-panel and select **Create Rule**. If you use this window, traffic descriptions and actions can be added to the rule afterwards (see [Using the Rule Tabs](#)). In order for a rule to be applied to devices, you must [enforce](#).

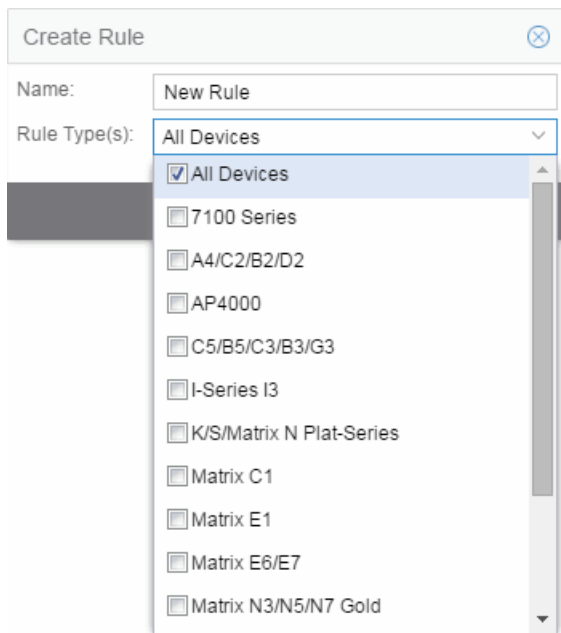

### Name

Enter a name for the rule.

### Type

Select the types of devices to which you wish this rule to apply when enforced. See [Rule Type](#) for more information on the consequences of your choice.

### OK

Click **OK** to create the rule and close the **Create Rule** window.

### Apply

Click **Apply** to create the rule and remain in the **Create Rule** window.

### Cancel

Click **Cancel** to close the **Create Rule** window without saving your changes.

## Related Information

For information on related concepts:

- [Traffic Classification Rules](#)

For information on related tasks:

- [Using the Rule Tabs](#)

For information on related windows:

- [General Tab \(Rule\)](#)

## Edit Rule

---

The Edit Rule window allows you to change the traffic description associated with a rule. The Traffic Description, which includes the traffic classification layer, traffic classification type, and traffic value, was entered when the rule was created (see [How to Create or Modify a Rule](#)).

To display the Edit Rule window, select the rule in the left panel's **Services** tab. In the Traffic Description section, click **Edit** to bring up the Edit Rule window.

If you modify an enabled rule's traffic descriptions, the **Policy** tab checks for conflicts with other rules in the services and roles with which the newly modified rule is associated. See [Conflict Checking](#) for more information.

The contents of the Edit Rule window varies according to the selected rule and traffic description.

The screenshot shows the 'Edit Rule' dialog box. At the top, there is a title bar with 'Edit Rule' and a close button. Below the title bar, there are two dropdown menus: 'Traffic Classification Layer' set to 'All Layers' and 'Traffic Classification Type' set to 'IP TCP Port Bilateral'. The main section is titled 'Traffic Classification Value' and contains three radio buttons: 'Well-Known Value' (selected with a dropdown menu showing 'FTP Data (20)'), 'Single Value' (selected with a text input field containing '1434'), and 'Range' (with 'Start Value' and 'End Value' text input fields). Below this is a section titled 'Traffic Classification Optional Value' with a 'Value:' label and an empty text input field. At the bottom, there are 'OK' and 'Cancel' buttons.

## Layer Area

### Traffic Classification Layer

The OSI model classification layer (or All Layers) currently associated with the rule. Each layer has multiple classification types from which you can select. If you change the layer, the Type and Value sections in the window change, and you must make new selections in those sections. See [Classification Types and their Parameters](#) for information.

### Traffic Classification Type

The traffic classification type currently associated with the rule. Each classification type consists of certain parameters and/or values. If you change the type, the Value section of the window changes, and you must make new selections in that section. See [Classification Types and their Parameters](#) for information.

## Value Area

This area displays the values currently selected for the traffic classification type, and allows you to change those values. Each traffic classification type requires certain parameters and/or values. See [Classification Types and their Parameters](#) for parameter information.

---

## Related Information

For information on related concepts:

- [Traffic Classification Rules](#)

For information on related tasks:

- [How to Create or Modify a Rule](#)

For information on related windows:











- [General Tab \(Rule\)](#)

## Class of Service Overview

Use this tab to view the Class of Service (CoS) configuration for the current domain. To access this window, select the **Class of Service** left-panel tab from the **Policy** tab.

This window displays the eight pre-populated static classes of service, each associated with one of the 802.1p priorities (0-7). Use these predefined classes of service or create your own classes of service.

Expanding this tab in the left panel allows you to select individual classes of service in the right panel, which opens them in the [Class of Service tab](#), where you can edit the configuration for the selected CoS.

Class of Service				
Name	Index	Priority	ToS	Drop Precedence
 Scavenger	0	0		None
 Best Effort	1	1		None
 Bulk Data	2	2		None
 Critical Data	3	3		None
 Network Control	4	4		None
 Network Management	5	5		None
 RTP/Voice/Video	6	6		None
 High Priority	7	7		None
 NAC Web Redirect	8	3	0x40:ff	None
 New COS	9	7		None

### Name

The name of the class of service.

### Index

The index number automatically assigned to the class of service.



### Priority

The 802.1p priority associated with the class of service. The priority for the eight static classes of service provided by the Policy tab (Priority 0-7), cannot be disabled or changed.

### ToS

The IP type of service value associated with this class of service, if any. See [IP Type of Service](#) for more information.

### Drop Precedence

The [drop precedence](#) associated with this class of service. Double-click in the column to select a Drop Precedence value: Low, Medium, or High.

---

## Related Information

For information on related concepts:

- [Getting Started with Class of Service](#)

For information on related tasks:

- [How to Create a Class of Service](#)
- [How to Define Rate Limits](#)

For information on related windows:

- [General Tab \(Class of Service\)](#)

## Getting Started with Class of Service

---

This Help topic provides an overview of **Policy** tab's class of service (CoS) functionality, including information about defining rate limits and configuring transmit queues.

After you have read this topic, look at an example of how a network administrator might use CoS to configure VoIP traffic with appropriate priority, ToS, queue treatment, and flood control by clicking on the link: [Class of Service Example](#).

This guide includes the following information:

- [Class of Service Overview](#)
- [Rate Limits](#)
- [Transmit Queues](#)
- [Flood Control](#)

## Class of Service Overview

Class of Service (CoS) provides the ability to give certain network traffic preferential treatment over other traffic. It classifies traffic into categories such as high, medium, and low, where high-priority traffic gets the best service while low-priority traffic is "drop eligible."

Class of Service helps you manage the bandwidth requirements of a given network flow with the available port resources on your network devices. (In a CoS context, a flow is a stream of packets classified with the same class of service as the packets transit the interface). Using CoS, you can:

- Assign different priority levels to different packet flows.
- Mark or re-mark the packet priority at port ingress with a Type of Service (ToS).
- Sort flows by transit queue. Higher priority queues get preferential access to bandwidth during packet forwarding.
- Limit the amount of bandwidth available to a given flow by either dropping (rate limiting) or buffering (rate shaping) packets in excess of configured limits.

The following figure shows how you can manage network bandwidth requirements by assigning different classes of service to different types of network traffic.

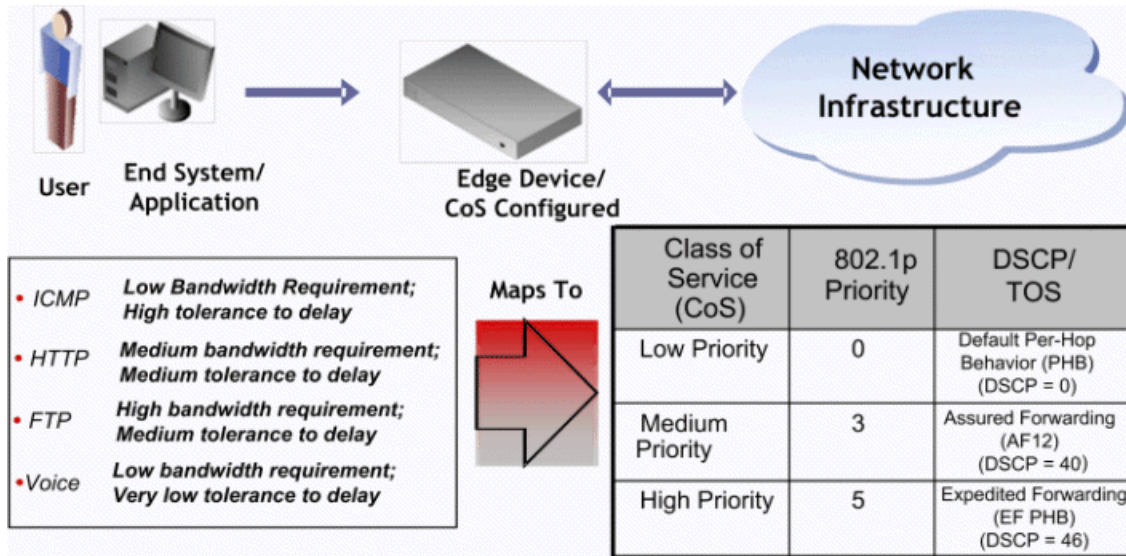

The ICMP protocol, used for error messaging, has a low bandwidth requirement, with a high tolerance for delay and jitter, and is appropriate for a low priority setting. HTTP and FTP protocols, used respectively for browser generated and file transfer traffic, have a medium to high bandwidth requirement, with a medium to high tolerance for delay and jitter, and are appropriate for a medium priority level. Voice (VoIP), used for voice calls, has a low bandwidth requirement, but is very sensitive to delay and jitter and is appropriate for a high priority level.

### Implementing CoS

CoS determines how a given network flow is assigned bandwidth as it transits your network devices. As a preliminary step to using CoS, it is important that you understand the characteristics of the flows on your network and associate these flows with your policy roles. In this sense, CoS is the third step in a three step process:

1. Understand your network flows using NetFlow.
2. Associate your network flows with a **Policy** tab role.
3. Configure your classes of service and associate them with the rules contained in your roles.

### Configuring CoS

The **Policy** tab lets you configure multiple classes of service that include one or more of the following components:

- 802.1p priority
- IP type of service (ToS) value
- drop precedence
- inbound and outbound rate limits
- outbound rate shaper per transmit queue.
- flood control rate limits

After you have created and defined your classes of service, they are then available when you make a class of service selection for a rule action ([Rule tab](#)), a role default ([General tab](#)), or an automated service ([Automated Service tab](#)).

To view and configure CoS, open the [Class of Service Overview tab](#) from the **Policy** tab. It is pre-populated with eight static classes of service, each associated with one of the 802.1p priorities (0-7). You can use these classes of service as is, or configure them to include ToS, drop precedence, rate limit, and/or transmit queue values. In addition, you can also create your own classes of service (user-defined CoS).

## Rate Limits

Rate limits are one component of a **Policy** tab class of service. They control the transmit rate at which traffic enters and exits ports in your network. All traffic mapped to a Class of Service on a given port share the bandwidth specified by the rate limit.

For instructions on how to configure rate limits, see [How to Define Rate Limits](#).

Rate limits are tied directly to roles and rules, and are written to a device when the role/rule is enforced. When rate limits are implemented, all traffic on the port that matches the rule with the associated rate limit cannot exceed the configured limit. If the rate exceeds the configured limit, frames are dropped until the rate falls below the limit.

The rate limit remains on the port only as long as the role using the rate limit is active on the port either as the authenticated role or as the port's default role.

The following figure shows how bursty traffic is clipped above the assigned threshold when rate limiting is applied.

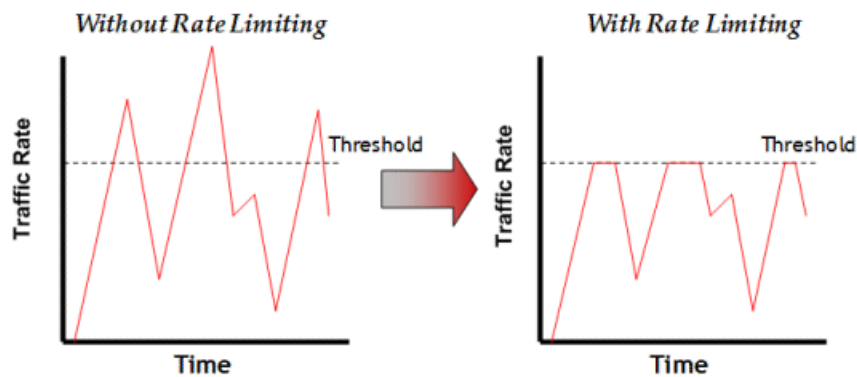

The CoS can be configured to perform one or all of the following actions when a rate limit is exceeded:

- Generate System Log on Rate Violation - a syslog message is generated when the rate limit is first exceeded.
- Generate Audit Trap on Rate Violation - an audit trap is generated when the rate limit is first exceeded.
- Disable Port on Rate Violation - the port is disabled when the rate limit is first exceeded.

The **Policy** tab class of service also provides the ability to create rate limit port groups. Port groups let you specify different rate limits within the same class of service. For example, you might create a port group for edge ports and a port group for core ports, and assign two different rate limits. For more information on rate limit port groups, see [Creating Class of Service Port Groups](#).

## Transmit Queues

Transmit queue configuration is defined within a class of service and associated with a specific role via a rule action or as a role default. It is implemented based on the role assigned to a port. All traffic received on a port and matching a rule with the associated class of service is forwarded using the defined transmit queue configuration.

For instructions on how to configure transmit queues, see [How to Configure Transmit Queues](#).

There are three components to transmit queue configuration:

- Transmit Queue Configuration allows you to set the transmit queue associated with the class of service.

- Transmit Queue Rate Shapers let you pace the rate at which traffic is transmitted out of that transmit queue.
- Bandwidth Configuration allows you to specify how the traffic in each transmit queue is serviced as it egresses the port.

The transmit queue configuration remains on the port only as long as the role using the configuration is active on the port either as the authenticated role or as the port's default role.

The following figure shows how bursty traffic is smoothed out when it goes above the assigned threshold when rate shaping is applied.

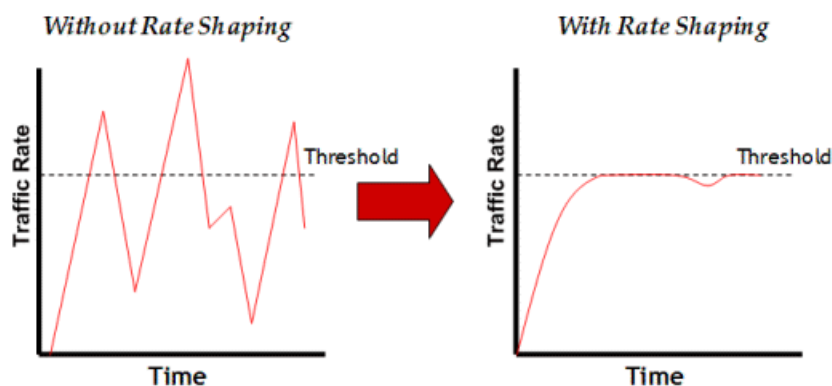

Rate shaping retains excess packets in a queue and then schedules these packets for later transmission over time. Therefore, the packet output rate is smoothed and bursts in transmission are not propagated as seen with rate limiting.

Rate shaping can be used for the following reasons:

- to control bandwidth
- to offer differing levels of service
- to avoid traffic congestion on other network links by removing the bursty property of traffic that can lead to discarded packets

The **Policy** tab class of service also provides the ability to create transmit queue shaper port groups that allow you to isolate certain kinds of sensitive network traffic so that you can vary the bandwidth of the shape for that single queue. For more information on transmit queue port groups, see [Creating Class of Service Port Groups](#).

## Flood Control

Flood control provides rate limiting capabilities to individual Class of Service to allow certain types of flooded traffic to be dropped. When enabled, incoming traffic is monitored over one second intervals. Traffic is identified using the following configuration types:

- unknown - unicast
- broadcast
- multicast

A traffic control rate sets the acceptable flow for each type, specified in packets per second. If, during a one second interval, the incoming traffic of a configured type reaches the traffic control rate on the port, the traffic is dropped until the interval ends. Packets are then allowed to flow again until the limit is reached.

By default, Flood Control is disabled for each CoS. Similar to CoS Port Groups, a different configuration can be assigned for each group. Since Flood Control is shared across all CoS, once Flood Control is enabled on at least one CoS, those rates apply to all ports that have Flood Control enabled.

For instructions on how to configure flood controls, see [How to Configure Flood Control](#).

---

### Related Information

For information on related tasks:

- [How to Create a Class of Service](#)
- [How to Define Rate Limits](#)
- [How to Configure Transmit Queues](#)

## Extreme Management Center Class of Service

---

This tab lets you view and configure the components of a class of service (CoS). See below for a description of each section. For more information, see [How to Create a Class of Service](#).

Once you have created and defined a class of service, you can then apply it as a classification rule action, as part of the definition of an automated service, or as a role default. For more information, see [Getting Started with Class of Service](#).

To access this tab, select the **Class of Service** left-panel tab on the **Policy** tab. Select a class of service in the tree, and the information for the selected class of service displays in the right panel.

**Class of Service**

Name:	<input type="text" value="Scavenger"/>	
Description:	<input type="text"/>	<input type="button" value="Edit..."/>
Transmit Queue:	<input type="text" value="Q0-LLQ (15Q) / Q0-LLQ (11Q) / Q0 (4Q)"/>	<input type="button" value="Edit..."/>
802.1p Priority:	<input type="text" value="Priority 0"/>	
ToS:	<input type="text" value="None"/>	<input type="button" value="Edit..."/>
Drop Precedence:	<input type="text" value="None"/>	

---

**Rate Limiting / Rate Shaping**

To Rate Limit using this CoS: Specify a logical Rate Limit Index (IRL/ORL), then for each Rate Limit Port Group, map the IRL/ORL index to an actual Rate Limit. The IRL/ORL index may map to a different rate for different port types or port groups. The former allows ports which support a fewer number of rates, to define the desired behavior if more mappings than they support are used. The latter allows different ports to use different rates, for instance edge ports versus interswitch links.

NOTE: Advanced is shown when a COS port group defines a different rate/shaper for different port types for the same IRL/ORL Index.

IRL Port Group Mappings:	<input type="text" value="None"/>	<input type="button" value="View/Edit..."/>
ORL Port Group Mappings:	<input type="text" value="None"/>	<input type="button" value="View/Edit..."/>
TXQ Port Group Shapers:	<input type="text" value="None"/>	<input type="button" value="View/Edit..."/>

IRL Index:	<input type="text" value="0"/>	<input type="button" value="Edit..."/>	
ORL Index:	<input type="text" value="-1"/>	<input type="button" value="Edit..."/>	
TXQ Index:	<input type="text" value="0"/>	<input type="button" value="Edit..."/>	

## General

### Name

Name of the selected class of service.

### Description

Use the **Edit** button to open a window where you can add or modify a description for the class of service.

### Transmit Queue

This field displays the transmit queue associated with the class of service for each port type. Use the **Edit** button to display a menu where you can select a new transmit queue, if desired.



### **802.1p Priority**

This drop-down menu lets you select the 802.1p priority associated with the class of service, if desired. This field is grayed out for the eight static classes of service provided by the Policy tab (Priority 0-7), because the 802.1p priority cannot be disabled or changed.

### **ToS**

Some IP rules allow a ToS value to be written to the ToS field in the IP header of incoming packets. Click the **Edit** button to open the Edit ToS window, where you can enter a ToS value. The value must be an 8-bit hexadecimal number between 0 and FF (see [IP Type of Service](#) for more information).

### **Drop Precedence**

The Drop Precedence option is used in conjunction with the Flex-Edge feature available on K-Series and S-Series (Release 7.11 or higher) devices. Flex-Edge provides the unique capability to prioritize traffic in the MAC chip as it enters the switch. When the Class of Service is assigned to a policy role, and that role is applied to a port via a MAC source address mapping or the port default role, the drop precedence dictates the internal priority (within the MAC chip) used for packets received on the port. If congestion occurs, packets with a high drop precedence are discarded first. Therefore, if a packet is important, it should have a low drop precedence. Refer to the K-Series or S-Series Configuration Guide for more information on the Flex-Edge feature and drop precedence.

## **Rate Limiting/Rate Shaping**

This section displays the inbound/outbound rate limits (IRL/ORL) and the outbound transmit queue (TxQ) rate shapers that are configured for the Default port groups associated with the class of service. If you have created additional port groups, the information displays for those groups as well.

With port rate limits, all traffic assigned to this class of service on a given port shares bandwidth specified by the rate limit. Rate shaping paces the rate at which traffic is transmitted out of the transmit queue. You can add or change a rate limit or a rate shaper by double-clicking on the area below a port group name.

If you have ExtremeWireless Controllers (Release 8.01.xx or higher) on your network, you also see the IRL and ORL user rate limits associated with the class of service. User rate limits specify the bandwidth given to each individual user on a port. Currently, user rate limits are only available on wireless controllers.

For more information, see [Advanced Rate Limiting by Port Type](#) and [How to Configure Transmit Queues](#).

## Index Numbers

At the bottom of the tab there is a section for configuring the rate limit and transmit queue index numbers associated with this class of service. These index numbers are used to map the class of service to the actual rate limits and transmit queue configuration on the device.

Typically, each class of service uses a different index number. The Policy tab automatically assigns these index numbers when you configure a class of services' rate limits and transmit queue shapers. An index number of "-1" indicates that no mappings are associated with the class of service.

All CoS using the same index will use the same rate limit and rate shaping assignments, and thus all traffic using those CoS will share the bandwidth.

### **IRL/ORL Index (Inbound/Outbound Rate Limits Index)**

The inbound/outbound port rate limit index associated with the class of service. Index numbers map logical rate limit indexes to the actual physical rate limits you have created in the Policy tab. Click the button to open the Rate Limits selection view window, and select an index for the CoS. For convenience, existing index to rate limit mappings are displayed; if one of the existing indexes is selected, the displayed mappings will apply for this CoS. (Selecting an index highlights all the mappings configured for that index number within the selection view.)

### **TxQ Index (Transmit Queue Index)**

The transmit queue index associated with the class of service. Index numbers map logical transmit queue indexes on the ports to the actual physical transmit queues you have configured in the **Policy** tab. If you have selected an 802.1p priority for this class of service, a default transmit queue index is automatically specified based on the selected priority. You can use the default index or change it according to your own transmit queue configuration. Click the button to open the Transmit Queues selection view window, which lists all the possible transmit queues, organized by index number for each existing port type and group. Selecting an index automatically includes all the transmit queues configured for that index number.

### **IUB/OUB Index (Inbound/Outbound User-Based Rates Index)**

If you have ExtremeWireless Controllers (Release 8.01.xx or higher) on your network, you also see the inbound/outbound user rate limits associated with the class of service. User rate limits specify the bandwidth given to each individual user

on a port. Currently, user rate limits are only available for these wireless controllers. Click the button to open the Rate Limits selection view window, and select an index for the CoS. For convenience, existing index to rate limit mappings are displayed; if one of the existing indexes is selected, the displayed mappings apply for this CoS. (Selecting an index highlights all the mappings configured for that index number within the selection view.)

### **Flood Ctrl Port Groups**

CoS-based flood control is a form of rate limiting that prevents configured ports from being disrupted by a traffic storm, by rate limiting specific types of packets through those ports. When flood control is enabled on a port, incoming traffic is monitored over one second intervals. During an interval, the incoming traffic rate for each configured traffic type (unknown-unicast, broadcast, or multicast) is compared with the configured traffic flood control rate, specified in packets per second. If, during a one second interval, the incoming traffic of a configured type reaches the traffic flood control rate configured on the port, CoS-based flood control drops the traffic until the interval ends. Packets are then allowed to flow again until the limit is again reached.

---

**NOTE:** By default, Flood Control is not managed by the **Policy** tab. To manage flood control configuration on devices in a domain, it can be enabled via the Domain Managed CoS Components drop-down menu by selecting All CoS Components or by selecting Flood Control.

---

### **Related Information**

For information on related concepts:

- [Getting Started with Class of Service](#)

For information on related tasks:

- [How to Create a Class of Service](#)
- [How to Define Rate Limits](#)
- [How to Configure Transmit Queues](#)

For information on related windows:

- [General Tab \(Rate Limit\)](#)

## Extreme Management Center General (CoS Components Folder)

---

This tab lists the elements that comprise a class of service. It appears when you select the **CoS Components** tab in the **Class of Service** left-panel tab of the **Policy** tab.

See [Getting Started with Class of Service](#) for more information about these components.

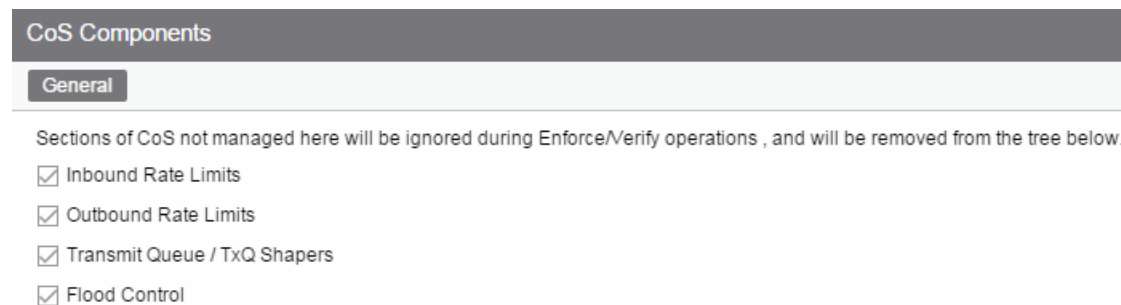

The screenshot shows the 'CoS Components' tab with the 'General' sub-tab selected. Below the sub-tab, there is a warning message: 'Sections of CoS not managed here will be ignored during Enforce/Verify operations , and will be removed from the tree below.' Below this message are four checked checkboxes: 'Inbound Rate Limits', 'Outbound Rate Limits', 'Transmit Queue / TxQ Shapers', and 'Flood Control'.

### **Inbound Rate Limits**

Select this checkbox to enable the [Inbound Rate Limit Port Groups tab](#) in the CoS Components left-panel tab.

### **Inbound Rate Limits**

Select this checkbox to enable the [Outbound Rate Limit Port Groups tab](#) in the CoS Components left-panel tab.

### **Transmit Queue/TxQ Shapers**

Select this checkbox to enable the [Transmit Queue Port Groups tab](#) in the CoS Components left-panel tab.

### **Flood Control Port Groups**

Select this checkbox to enable the [Flood Control Port Groups tab](#) in the CoS Components left-panel tab.

## Related Information

For information on related concepts:

- [Getting Started with Class of Service](#)

For information on related tasks:

- [How to Create a Class of Service](#)
- [How to Define Rate Limits](#)
- [How to Configure Transmit Queues](#)
- [How to Configure Flood Control](#)

## General (Rate Limits)

---

This tab allows you to create and define a [rate limit](#). Rate limits are components of a class of service and are used to control the transmit rate at which traffic enters and exits ports in your network.

To access this window, open the **Control** tab, select the **Policy** tab > **Class of Service** left-panel tab > **CoS Components** left-panel tab > **Rate Limits** tab. Select an existing rate limit to view or modify a rate limit or right-click the **Rate Limits** left-panel tab and select the **Create Rate Limit** option to create a new rate limit.

To create the rate limit, fill out the window and click **OK** (to create a single rate limit) or **Apply** (to create more rate limits). After you create the rate limit, the General tab for the new rate limit appears, where you can configure additional rate limit parameters.

The screenshot shows a configuration window titled "Rate Limit: 1) 1024 Kb/s". The "General" tab is selected. The "Name" field contains "1) 1024 Kb/s". The "Rate" field is set to "1024" with a unit dropdown menu set to "Kb/s". There is an "Edit..." button next to the rate field. Under the "Actions" section, there are three dropdown menus: "System Log" (Disabled), "Audit Trap" (Disabled), and "Disable Port" (Disabled).

**Name**

Specify the name of the rate limit.

**Rate Limit**

Click the **Edit** button to specify the highest transmission rate at which traffic can enter or exit a port before packets are rate limited:

- % - A percentage of the total bandwidth available (not available for priority-based rate limits)
- PPS - Packets per second (not available for priority-based rate limits)
- Kb/s - Kilobits per second
- Mb/s - Megabits per second
- Gb/s - Gigabits per second

**Actions**

Select the action(s) you would like this rate limit to use:

- System Log - a syslog message is generated when the rate limit is first exceeded.
- Audit Trap - an audit trap is generated when the rate limit is first exceeded.
- Disable Port - the port is disabled when the rate limit is first exceeded.

---

**NOTE:** N-Series Gold devices do not support rate limit notification.

---

**Related Information**

For information on related concepts:

- [Rate Limits](#)





For information on related tasks:

- [How to Define Rate Limits](#)

## Extreme Management Center Details View (Rate Limits Folder)

This tab lists information on any rate limits that have been defined in the **Policy** tab.

To access this tab, select the **Class of Service > CoS Components > Rate Limits** left-panel tab. See [How to Define Rate Limits](#) for more information.

Rate Limits			
Name	Syslog	Audit Trap	Disable Port
 1) 1024 Kb/s	Disabled	Disabled	Disabled
 2) 5 Mb/s	Disabled	Disabled	Disabled
 3) 10 Mb/s	Disabled	Disabled	Disabled
 4) 20 Mb/s	Disabled	Disabled	Disabled

### Name

Name of the rate limit.

### Syslog

Specifies whether a syslog message will be generated when the rate limit is first exceeded.

### Audit Trap

Specifies whether an audit trap will be generated when the rate limit is first exceeded.

### Disable Port

Specifies whether the port will be disabled when the rate limit is first exceeded.

## Related Information

For information on related windows:

- [General Tab \(Rate Limits\)](#)

## Extreme Management Center Priority-Based Rate Limits

---

Priority-based rate limits are used primarily by legacy devices. They are rate limits that are associated with one or more of the eight 802.1p priorities (0-7). When the associated priority is selected for a class of service, the rate limit becomes part of that class of service.

These rate limits are written directly to each port (unless the port is specified in the rate limit's exclusion list), and are implemented based on the 802.1p priority assigned to a data packet appearing on that port. While priority-based rate limits are not tied directly to roles or rules, they are displayed with the associated priority when you select a class of service while creating a rule, automated service, or role.

When priority-based rate limiting is implemented, the combined rate of all traffic on the port that matches the priorities associated with the rate limit cannot exceed the configured limit. If the rate exceeds the configured limit, frames are dropped until the rate falls below the limit.

Once a rate limit is associated with a priority, that priority includes rate limiting wherever and however it is used, until the rate limit is deleted from Extreme Management Center. Also, once a priority-based rate limit is applied to a port, it remains on the port even if the role that originally used the rate limit is no longer associated with the port. For example, if an untagged packet arrives on a port where there is no role or default priority, but the port's 802.1p priority includes a rate limit, that traffic is rate limited. As another example, if the priority of a tagged packet matches a priority-based rate limit on a port, the traffic is rate limited.

To configure a priority-based rate limit, you need to specify the following components:

- *Rate Limit* - The highest transmission rate at which traffic can enter or exit a port.
- *Direction* - The direction to which the limit applies (inbound or outbound traffic). In order to control traffic inbound and outbound on the same port, two rate limits must be configured (one inbound and one outbound). Inbound rate limiting takes place after a frame is classified into one of the eight priorities. Outbound rate limiting



takes place just before a frame is queued for transmission. A single frame may pass through inbound and outbound rate limits depending on the path it takes through the device and the rate limiting configuration on the device.

- *Priority* - The 802.1p priority or priorities with which the rate limit is associated.
- *Precedence* - The order in which the rate limit is written to supported devices. Extreme Management Center allows you to define as many rate limits as you wish; however, the number written to a device is restricted by the number of rate limits supported by the device. Each port on the device may utilize any or all of the defined rate limits up to the number of rate limits it supports.
- *Exclusion* - The devices/ports you wish to be excluded from the rate limit. For example, rate limiting is most often used for edge devices; therefore, you might want to exclude a device group or port group containing non-edge devices or ports.

### Add/Edit CoS to Rate Limit Mapping

---

This window lets you configure the rate limit mappings for a rate limit port group. Rate limit mappings map a logical rate limit index to an actual physical rate limit you have created in Extreme Management Center.

For reference, the CoS IRL/ORL Index table (at the bottom of the window) displays classes of service that already have an IRL/ORL index specified, so that you can see which classes of service are affected by mapping an index to a rate limit.

To access this window, open the click on the **Add/Edit** button on the [CoS - Rate Limit Mappings tab](#) (Control tab > Policy tab > Class of Service left-panel tab > CoS Components left-panel tab and select a port group in either the **Inbound Rate Limit Port Groups** or **Outbound Rate Limit Port Groups** left-panel tab, depending on the type of rate limit.

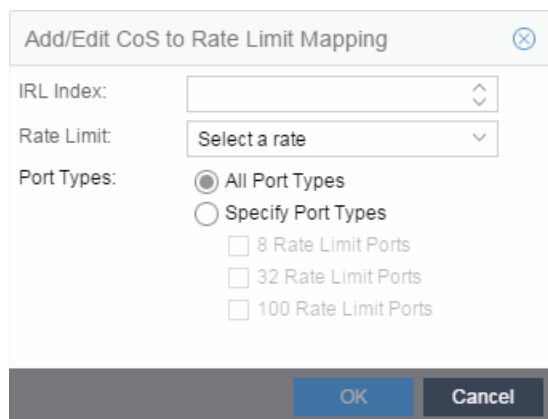

The dialog box is titled "Add/Edit CoS to Rate Limit Mapping" and has a close button (X) in the top right corner. It contains three main sections: "IRL Index:" with a dropdown menu; "Rate Limit:" with a dropdown menu showing "Select a rate"; and "Port Types:" with two radio buttons. The first radio button is "All Port Types" and is selected. The second radio button is "Specify Port Types", which is unselected and has three sub-options: "8 Rate Limit Ports", "32 Rate Limit Ports", and "100 Rate Limit Ports", each with an unchecked checkbox. At the bottom of the dialog are "OK" and "Cancel" buttons.

### IRL/ORL Index

Specify the IRL (Inbound Rate Limit) or ORL (Outbound Rate Limit) Index you are mapping.

### Rate Limit

Use the drop-down menu to select a rate limit to map to the index. Rate limits are listed by the rate limit name followed by the precedence. For information on how to create a rate limit, see [How to Define Rate Limits](#). Select **None** to remove an existing mapping for the specified port types.

### Port Types

These options allow you to create a mapping for all port types at once, or create a mapping just for specific port types.

---

## Related Information

For information on related concepts:

- [Getting Started with Class of Service](#)

For information on related tasks:

- [Defining Rate Limits](#)
- [Advanced Rate Limiting by Port Type](#)

For information on related windows:

- [Ports Tab \(Rate Limit Port Group\)](#)

## Advanced Rate Limiting by Port Type

---

The **Policy** tab class of service feature provides the ability to create rate limit port groups that let you group together ports with similar rate limiting requirements. For instructions on creating a port group, see [Creating Class of Service Port Groups](#).

This Help topic provides information about an advanced port group feature that lets you specify different rate limits for the different port types contained in a port group: 8-rate limit, 32-rate limit, 64-rate limit, and 100-rate limit port types.

After you have created your port groups, you can use the [CoS to rate limit mappings tab](#) to configure rate limit index mappings for each group. These mappings map a logical rate limit index to an actual physical rate limit created in the Policy tab. For each class of service, you can select one mapping index that gives you the desired physical rate limit for each port group (see the [Index Numbers](#) section of the CoS General tab for more information on CoS Index Numbers).

The **Policy** tab supports a maximum of 100 logical rate limit indexes and each rate limit port group lets you map all 100 indexes. For 8-rate limit, 32-rate limit, and 64-rate limit ports, this means that the number of logical indexes might be greater than the actual number of rate limits the port supports. The port group can map 100 logical rate limit indexes, but they can only be mapped to a maximum of 8, 32, or 64 different physical rate limits on those ports.

For example, you want to have 25 rate limits for 25 different CoS. You need to define the behavior for the 8-rate port type, since once you get to the 9th rate, you would have no more resources available for the remaining rates (9-25). You would either need to share some of the same resources, or not rate limit with the remaining rates.

The maximum supported indexes for a device is based on the largest number of rates supported for that device. On devices supporting a maximum of 8 rate limits, indexes 0-7 are supported. On devices supporting a maximum of 32 rate limits, indexes 0-31 are supported. On devices supporting 64 rate limits, IRL indexes 0-63 are supported. If a rate limit port group maps indexes greater than the supported value, they are ignored during Enforce (indicated in the Class of Service > Rate Limit Mappings tables of Enforce Preview)

**Instructions on:**

- [Configuring Rate Limit Mappings](#)
- [Associating Rate Limits with a Class of Service](#)

## Configuring Rate Limit Mappings

Use the following instructions configure rate limit mappings for a port group.

1. Open the **Class of Service > CoS Components** left-panel tab.
2. Select either the **Inbound Rate Limit Port Groups** or **Outbound Rate Limit Port Groups** left-panel tab.
3. Select the right-panel [CoS - Rate Limit Mappings tab](#).
4. Click **Add/Edit** to open the [Add/Edit CoS to Rate Limit Mappings window](#).
5. In the window, specify the IRL (Inbound Rate Limit) or ORL (Outbound Rate Limit) Index you are mapping.
6. Use the drop-down list to select a rate limit to map to the index.
7. The port type options allow you to create a mapping for all port types at once, or create a mapping just for specific port types.
8. Click the **OK** button to map all your indexes and close the window. The Mappings tab displays your index to rate limit mapping configuration.

## Associating Rate Limits with a Class of Service

After you have configured the rate limit mappings for a port group, you can associate a rate limit mapping index with a class of service.

1. Open the **Class of Service** left-panel tab.
2. Select the CoS in the left-panel tree. (If you have not created the class of service, see [How to Create a Class of Service](#).)
3. At the bottom of the **Class of Service** tab in the right panel, click the **Edit** button next to the IRL or ORL index that you want to configure. The Edit Index window opens.
4. This window lists all the currently mapped rate limits, organized by index number for each existing port type and group. Selecting one index number automatically includes all the rate limits configured for that index number. To configure new mappings for the CoS, you can first select an index that is not currently mapped, then create the mappings as described in [Configuring Rate Limit Mappings](#) above. Click **OK**.

5. Once you have selected the mapping index, the table below displays the actual rate limits used by each rate limit port group for that class of service.
  6. Click **Open/Manage Domains > Save Domain**.
- 

### Related Information

For information on related concepts:

- [Getting Started with Class of Service](#)

For information on related tasks:

- [How to Create a Class of Service](#)
- [How to Define Rate Limits](#)

For information on related windows:

- [Create Rate Limit Window](#)
- [General \(Rate Limit\)](#)

## Extreme Management Center Summary (Rate Limit Port Groups Folder)

---

This tab lists the name of all the inbound or outbound rate limit port groups (depending on the left-panel tab you select). Rate limit mappings map a logical rate limit index (IRL/ORL Index) to an actual physical rate limit. You can configure a port group's mappings on the port group [Mappings tab](#).

To access this tab, open the **Class of Service > CoS Components** left-panel tab, then, select either the **Inbound Rate Limit Port Groups** left-panel tab or the **Outbound Rate Limit Port Groups** tab. The Summary tab displays in the right panel.

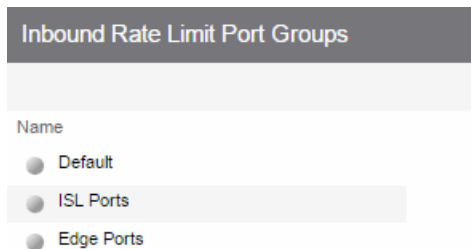

### Name

The name of the port group

---

### Related Information

For information on related concepts:

- [Getting Started with Class of Service](#)

For information on related tasks:

- [Creating Class of Service Port Groups](#)

## Extreme Management Center CoS - Rate Limit Mappings (Rate Limit Port Group)

---

This tab lets you view and configure the rate limit mappings for a rate limit port group. Rate limit mappings map a logical rate limit index used by classes of service to an actual physical rate limit you create in Extreme Management Center.

Each port group has its own set of index mappings. Extreme Management Center automatically assigns these index numbers when you configure a class of services' rate limits and transmit queue shapers.

The rate limit mappings tab allows you to do two things:

- Map the index to a different rate for different port groups (edge ports versus inter-switch links). See [Creating Class of Service Port Groups](#).

- Map the index to a different rate limit for each port type (8-rate limit, 32-rate limit, 64-rate limit, and 100-rate limit) in a port group. See [Advanced Rate Limiting by Port Type](#).

To access this tab:

1. Open the **Control** tab.
2. Open the **Policy** tab.
3. Open the **Class of Service > CoS Components** left-panel tab.
4. Select either the **Inbound Rate Limit Port Groups** or **Outbound Rate Limit Port Groups** left-panel tab, depending on whether the rate limit is inbound or outbound.
5. Select a existing port group in the left panel to open it in the **Rate Limit Port Group** tab.

---

**NOTE:** Create a new port group by right-clicking the **Inbound Rate Limit Port Groups** or **Outbound Rate Limit Port Groups** left-panel tab, selecting **Create Port Group**, entering a **Name** for the port group, and clicking **OK**.

---

6. Select the **CoS - Rate Limit Mappings** tab in the right panel.

Rate Limit Port Group: Default

CoS - Rate Limit Mappings Ports

To Rate Limit using a Class of Service: Specify a logical Rate Limit Index (IRL/URL) for that CoS, then for each Role-Based Rate Limit Port Group such as this one, Add/Edit an IRL/URL index and map it to an actual Rate Limit below. The index in a CoS may map to a different rate for different port types or port groups. The former allows ports which support a fewer number of rates to define the desired behavior if more mappings than they support are used. The latter allows different ports to use different rates, for instance edge ports versus interswitch links.

+ Add/Edit - Remove 🔍

IRL Index	Rate Limit	IRL Port Type(s)	IRL Index Used By CoS
0	None	8 Rate Ports	Scavenger
0	None	32 Rate Ports	Scavenger
0	None	100 Rate Ports	Scavenger
1	None	8 Rate Ports	Best Effort
1	None	32 Rate Ports	Best Effort
1	None	100 Rate Ports	Best Effort
2	None	8 Rate Ports	Bulk Data
2	None	32 Rate Ports	Bulk Data
2	None	100 Rate Ports	Bulk Data
3	None	8 Rate Ports	Critical Data
3	None	32 Rate Ports	Critical Data
3	None	100 Rate Ports	Critical Data
4	None	8 Rate Ports	Network Control
4	None	32 Rate Ports	Network Control
4	None	100 Rate Ports	Network Control
5	None	8 Rate Ports	Network Management
5	None	32 Rate Ports	Network Management
5	None	100 Rate Ports	Network Management
6	None	8 Rate Ports	RTP/Voice/Video
6	None	32 Rate Ports	RTP/Voice/Video
6	None	100 Rate Ports	RTP/Voice/Video
7	None	8 Rate Ports	High Priority
7	None	32 Rate Ports	High Priority
7	None	100 Rate Ports	High Priority

**IRL/ORL Index**

The logical inbound rate limit (IRL) or outbound rate limit (ORL) index number. This index number is specified in a class of service and dictates the rate limiting behavior for incoming or outgoing packets. For each rate limit port group, use this tab to map the index number to an actual rate limit.

**Rate Limit**

The actual rate limit to which the IRL/ORL index is mapped.

**IRL/ORL Port Type(s)**

The type of ports included in the port group. Port type is based on the number of rate limits the ports support (for example, 8-rate limit ports and 32-rate limit ports).

**IRL/ORL Index Used By CoS**

The classes of service using this IRL/ORL index.

**Add/Edit Button**

Opens the [Add/Edit CoS to Rate Limit Mappings window](#) where you can add or edit rate limit mappings for the rate limit port group

**Remove Button**

Removes the mapping(s) selected in the table.

---

**Related Information**

For information on related concepts:

- [Getting Started with Class of Service](#)

For information on related tasks:

- [How to Define Rate Limits](#)
- [Advanced Rate Limiting by Port Type](#)

For information on related windows:

- [Ports Tab \(Rate Limit Port Group\)](#)



## Extreme Management Center Ports (Rate Limit Port Group)

---

The rate limit port group **Ports** tab lets you view all the ports in the selected port group, as well as add and remove ports to and from the group. It provides information about each port, and lets you view and edit port information (via the port's **General** tab).

To access this tab:

1. Open the **Control** tab.
2. Open the **Policy** tab.
3. Open the **Class of Service > CoS Components** left-panel tab.
4. Select either the **Inbound Rate Limit Port Groups** or **Outbound Rate Limit Port Groups** left-panel tab, depending on whether the rate limit is inbound or outbound.
5. Select a existing port group in the left panel to open it in the **Rate Limit Port Group** tab.

---

**NOTE:** Create a new port group by right-clicking the **Inbound Rate Limit Port Groups** or **Outbound Rate Limit Port Groups** left-panel tab, selecting **Create Port Group**, entering a **Name** for the port group, and clicking **OK**.

---

6. Select the **Ports** tab in the right panel.

Create a new port group by right-clicking the **Inbound Rate Limit Port Groups** or **Outbound Rate Limit Port Groups** left-panel tab, selecting **Create Port Group**, entering a **Name** for the port group, and clicking **OK**.

Rate Limit Port Group: Default								
CoS - Rate Limit Mappings <span style="float: right;">Ports</span>								
Add/Remove								
Name	Rate/Queue Port Type	Default Role	Alias	Stats	Port Type	Neighbor	Port Speed	Description
ge.1.1	32 Rate Limits				Interswitch	Port ge.1.47	Gigabit	100BASE-T RJ45 Gigabit Ethernet Frontpanel Port
ge.1.2	32 Rate Limits				Access		10/100	100BASE-T RJ45 Gigabit Ethernet Frontpanel Port
ge.1.3	32 Rate Limits				Access		10/100	100BASE-T RJ45 Gigabit Ethernet Frontpanel Port
ge.1.4	32 Rate Limits				Access		10/100	100BASE-T RJ45 Gigabit Ethernet Frontpanel Port
ge.1.5	32 Rate Limits				Access		10/100	100BASE-T RJ45 Gigabit Ethernet Frontpanel Port
ge.1.6	32 Rate Limits				Access		10/100	100BASE-T RJ45 Gigabit Ethernet Frontpanel Port
ge.1.7	32 Rate Limits				Access		10/100	100BASE-T RJ45 Gigabit Ethernet Frontpanel Port
ge.1.8	32 Rate Limits				Access		10/100	100BASE-T RJ45 Gigabit Ethernet Frontpanel Port
ge.1.9	32 Rate Limits				Access		10/100	100BASE-T RJ45 Gigabit Ethernet Frontpanel Port
ge.1.10	32 Rate Limits				Access		10/100	100BASE-T RJ45 Gigabit Ethernet Frontpanel Port
ge.1.11	32 Rate Limits				Access		10/100	100BASE-T RJ45 Gigabit Ethernet Frontpanel Port
ge.1.12	32 Rate Limits				Access		10/100	100BASE-T RJ45 Gigabit Ethernet Frontpanel Port
ge.1.13	32 Rate Limits				Access		10/100	100BASE-T RJ45 Gigabit Ethernet Frontpanel Port
ge.1.14	32 Rate Limits				Access		10/100	100BASE-T RJ45 Gigabit Ethernet Frontpanel Port
ge.1.15	32 Rate Limits				Access		10/100	100BASE-T RJ45 Gigabit Ethernet Frontpanel Port
ge.1.16	32 Rate Limits				Access		10/100	100BASE-T RJ45 Gigabit Ethernet Frontpanel Port
ge.1.17	32 Rate Limits				Access		10/100	100BASE-T RJ45 Gigabit Ethernet Frontpanel Port
ge.1.18	32 Rate Limits	Mirror	MPLSTEST		Access		10/100	100BASE-T RJ45 Gigabit Ethernet Frontpanel Port
ge.1.19	32 Rate Limits				Access		10/100	100BASE-T RJ45 Gigabit Ethernet Frontpanel Port
ge.1.20	32 Rate Limits	Mirror	MPLSTEST		Access		10/100	100BASE-T RJ45 Gigabit Ethernet Frontpanel Port
ge.1.21	32 Rate Limits				Access		10/100	100BASE-T RJ45 Gigabit Ethernet Frontpanel Port
ge.1.22	32 Rate Limits				Access		10/100	100BASE-T RJ45 Gigabit Ethernet Frontpanel Port
ge.1.23	32 Rate Limits				Access		10/100	100BASE-T RJ45 Gigabit Ethernet Frontpanel Port

## Name

Name of the port, constructed of the name or IP address of the device and either the port index number or the port interface name.

## Rate/Queue Port Type

The number of rate limits the port supports.

## Default Role

The default role assigned to the port. See [Default Role](#) in the Concepts topic for information on default roles. For additional information, see [Port Mode](#).

## Alias

Shows the alias (ifAlias) for the interface, if one is assigned.

## Stats

Shows statistics collected for a port, enabled via the Flow Collection & Interface setting in the [PortView](#).

## Port Type

Type of port. Possible values include: Access, Interswitch Backplane, Backplane, Interswitch, and Logical.

## Neighbor

The port's neighbor port.

## Port Speed

Speed of the port. Possible values include: 10/100, speed in megabits per second (for example, 800.0 Mbps), Unknown (displayed for logical ports).

### **Description**

A description of the port.

### **Add/Remove Ports Button**

Opens the [Add/Remove Ports window](#), where you can add and remove ports to and from the port group. When you create new port groups, you add ports from the Default group into your newly defined port groups.

---

### **Related Information**

For information on related concepts:

- [Getting Started with Class of Service](#)

For information on related tasks:

- [How to Define Rate Limits](#)
- [Creating Class of Service Port Groups](#)

For information on related windows:

- [CoS - Rate Limits Mappings Tab \(Rate Limit Port Group\)](#)

## **Extreme Management Center Automated Service**

---

Selecting an Automated Service opens the **Automated Service** tab which allows you to define settings for the service. For more information on services, see [How to Create a Service](#).

**Rule: New Service**

---

Service Name:

Description:  Edit...

TCI Overwrite:

---

**Traffic Description**

Type:  Remove Edit...

Network Resource Type:

Network Resources:

---

**Actions**

Access Control:  Contain to VLAN:

Class of Service:

System Log:

Audit Trap:

Disable Port:

Traffic Mirror:   Mirror First 15 packets

Quarantine Role:

### Service Name

Name of the selected service.

### Description

Use the **Edit** button to open a window where you can enter or modify a description of the service.

### TCI Overwrite

Specify the TCI Overwrite functionality for the service:

- **Enabled** - Enabling TCI Overwrite allows the VLAN (access control) and class of service characteristics defined in this service to overwrite the VLAN or class of service (CoS) tag in a received packet, if that packet has already been tagged with VLAN or CoS information.
- **Disabled** - If this option is disabled the TCI Overwrite option is ignored, but lower-precedence rules and the role default actions may still specify TCI Overwrite for the data packet if there is a match.
- **Prohibited** - Do not set TCI Overwrite for this data packet, even when a lower-precedence rule or the role default actions has the TCI Overwrite option set to enabled.

## Traffic Description Area

Use this area to provide the specifications for an automated service. Specify the network resource type, the network resources for the service, and the rule type. Some rule types require that you enter certain parameters and/or values. This section is not displayed for a Manual service.

### Type

Click the **Edit** button to select the type of rule you want to create for the network resources. Some rule types require you enter certain parameters and/or values. See [Classification Types and their Parameters](#) for parameter information. Select and/or enter the required parameters.

### Network Resource Type

Select the network resource type (Layer 2 MAC or Layer 3 IP). This will determine the list of network resources available for selection for this service.

### Network Resources

Use the drop-down list to select the network resources to associate with the automated service. Use the configuration menu button to the right of the list to add a network resource or view and edit your network resources. For more information, see [How to Create a Network Resource](#).

## Actions Area

Use this area to define the access control and/or a class of service for the Automated service rule. This section is not displayed for a Manual service.

### Access Control

Use this drop-down list to select the appropriate access control for the rule. You can permit traffic to be forwarded, deny traffic altogether, or contain traffic to a VLAN. Select **None** to disable access control for this rule.

- **Permit Traffic** - allows traffic to be forwarded with the port's assigned VID.
- **Deny Traffic** - traffic will be automatically discarded.
- **Contain to VLAN** - contains traffic to a specific VLAN. Use the drop-down menu to select the desired VLAN. Use the **Contain to VLAN** drop-down menu to select a VLAN.

### **Class of Service**

Use the drop-down menu to select a class of service to associate with the service. The Policy tab lets you define classes of service that each include an 802.1p priority, and optionally an IP type of service (ToS/DSCP) value, rate limits, and transmit queue configuration. You can then assign a class of service as a classification rule action. See [Getting Started with Class of Service](#) and [How to Create a Class of Service](#) for more information. Select **None** to disable class of service for this rule. Use the configuration menu button to the right of the drop-down list to add or edit a Class of Service.

When rule accounting is enabled on a device, each rule keeps a list of the ports on which it has been used. The next three options allow you to specify certain rule usage actions to take place when a "rule hit" is reported.

### **System Log**

Specify System Log functionality for the rule:

- **Enabled** - If this option is enabled, a syslog message is generated when the rule is used. This option must be enabled if you are configuring Policy Rule Hit Reporting on your devices.
- **Disabled** - If this option is disabled and this rule is hit, it does not generate a Syslog message, but lower-precedence rules and the role default actions may still specify a syslog message be sent for this data packet if there is a match.
- **Prohibited** - If this rule is hit, no syslog message is generated for this data packet, even when a lower-precedence rule or the role default actions has the System Log action set to enabled.

### **Audit Trap**

Specify Audit Trap functionality for the rule:

- **Enabled** - If this option is enabled, an audit trap is generated when the rule is used.
- **Disabled** - If this option is disabled and this rule is hit, it does not generate an audit trap, but lower-precedence rules and the role default actions may still specify generating an audit trap for this data packet if there is a match.
- **Prohibited** - If this rule is hit, no audit trap is generated for this data packet, even when a lower-precedence rule or the role default actions has the Audit Trap action set to enabled.

## Disable Port

Specify Disable Port functionality for the rule:

- **Enabled** - If this option is enabled, any port reported as using this rule is disabled. Ports that have been disabled due to this option are displayed in the device Role/Rule tab.
- **Disabled** - If this option is disabled and this rule is hit, it does not disable the port, but lower-precedence rules and the role default actions may still specify disabling the port for this data packet if there is a match.
- **Prohibited** - If this rule is hit, the port is not disabled, even when a lower-precedence rule or the role default actions has the Disable Port action set to enabled.

## Traffic Mirror

Specify [traffic mirroring](#) functionality for the rule:

- **Select port group(s)** - Use the drop-down list to select the port groups where mirrored traffic will be sent for monitoring and analysis. Use the configuration menu button to the right of the drop-down list and select View/Modify Port Groups to open the Port Groups tab where you can define user-defined port groups for selection.
- **Disabled** - If this option is disabled and this rule is hit, traffic mirroring will not take place, but lower-precedence rules and the role default actions may still specify traffic mirroring for this data packet if there is a match.
- **Prohibited** - If this rule is hit, traffic mirroring is disabled, even when a lower-precedence rule or the role default actions has the Traffic Mirror action specified.

## Quarantine Role

Specify Quarantine role functionality for the rule:

- **Enabled** - If this option is enabled, any role reported as using this rule is quarantined.
- **Disabled** - If this option is disabled and this rule is hit, it does not quarantine the role, but lower-precedence rules and the role default actions may still specify quarantining the role for this data packet if there is a match.
- **Prohibited** - If this rule is hit, the role is not quarantined, even when a lower-precedence rule or the role default actions has the Quarantine Role action set to enabled.

## Related Information

For information on related tasks:

- [How to Create a Service](#)
- [How to Create a Network Resource](#)

## Traffic Classification Rules

---

Traffic Classification rules allow you to assign VLAN membership and/or class of service to your network traffic based on the traffic's classification type. Classification types are derived from Layers 2, 3, 4, and 7 of the OSI model, and all network traffic can be classified according to specific layer 2/3/4/7 information contained in each frame. In the **Policy** tab, rules are used to provide four key policy features: traffic containment, traffic filtering, traffic security, and traffic prioritization. Examples of how to design rules for each of these features are given below.

A Traffic Classification rule has two main parts: Traffic Description and Actions. The Traffic Description identifies the traffic classification type for the rule. The Actions specify whether traffic matching that classification type will be assigned VLAN membership, class of service, or both. When a frame arrives on a port, the switch checks to see if the frame's classification type matches the type specified in a rule. If it does, then the actions defined in that rule will apply to the frame.

In the **Policy** tab, rules are created and then grouped together into Services, which are then used to define roles. A role is assigned to each port either through end user authentication or as the port's default role. This means that there can be multiple rules active on a port. When a frame is received on a port, if the frame's classification type matches more than one rule, classification precedence rules are used to determine which rule to use.

The following information is discussed in this file:

- [Traffic Descriptions](#)
- [Actions](#)
  - [VLAN Membership](#)
  - [Priority \(Class of Service\)](#)



- [Classification Types and their Parameters](#)
  - [Layer 2 Data Link Classification Types](#)
  - [Layer 3 Network Classification Types](#)
  - [Layer 4 Application Transport Classification Types](#)
  - [Layer 7 Application Classification Type](#)
- [Examples of How Rules are Used](#)
  - [Traffic Containment](#)
  - [Traffic Filtering](#)
  - [Traffic Security](#)
  - [Traffic Prioritization](#)

## Traffic Descriptions

When you create a Traffic Classification rule in the **Policy** tab, you must define the rule's traffic description. The traffic description identifies the traffic classification type for that rule. You must select a classification type, and then select or enter certain parameters or values for each type.

Classification types are grouped according to Layers 2, 3, 4, and 7 of the OSI model and there are multiple classification types for each layer.

OSI Model
<b>Layer 7 - Application</b>
Layer 6 - Presentation
Layer 5 - Session
<b>Layer 4 - Transport</b>
<b>Layer 3 - Network</b>
<b>Layer 2 - Data Link</b>
Layer 1 - Physical

Specific Layer 2/3/4/7 information contained in each frame is used to identify the frame's classification type. Each layer uses different information to classify frames.

- **Layer 2 Data Link** -- classifies frames based on an exact match of the MAC address or specific protocol type of each frame.

- **Layer 3 Network** -- classifies IP or IPX frames based on specific information contained within the Layer 3 header.
- **Layer 4 Transport** -- classifies IP frames based on specific Layer 4 TCP or UDP port numbers contained in the header.
- **Layer 7 Application** -- classifies frames based on specific Layer 7 application types.

For a complete description of Layer 2, 3, 4, and 7 classifications, refer to [Classification Types and Their Parameters](#).

## Actions

When you create a Traffic Classification rule in the **Policy** tab, you must define the actions the rule performs. When a frame arrives on a port, the switch checks to see if the frame's classification type matches the type specified in a rule. If it does, then the actions defined in that rule will apply to the frame. Actions specify whether the frame will be assigned VLAN membership (access control) and/or priority (class of service).

### VLAN Membership (Access Control)

In your network domains, you can create VLANs (Virtual Local Area Networks) that allow end-systems connected to separate ports to send and receive traffic as though they were all connected to the same network segment. Using traffic classification rules, you can classify a frame based on the frame's classification type to have membership in a specific VLAN, providing important traffic containment, filtering, and security for your network.

For example, a network administrator could use rules to separate end user traffic into VLANs according to protocol, subnet, or application. Rules could also be used to group geographically separate end-systems into job-specific workgroups.

### Priority (Class of Service)

Traffic Classification rules allow you to assign a transmission priority to frames received on a port based on the frame's classification type. For example, a network administrator could use rules to assign priority to one network application over another.

Priority is a value between 0 and 7 assigned to each frame as it is received on a port, with 7 being the highest priority. Frames assigned a higher priority will be

transmitted before frames with a lower priority. Each of the priorities is mapped into a specific transmit queue by the switch or router. The insertion of the priority value (0-7) allows all 802.1Q devices in the network to make intelligent forwarding decisions based on its own level of support for prioritization.

The **Policy** tab enables you to utilize priority by creating classes of service that each include an 802.1p priority, and optionally an IP type of service (ToS/DSCP) value, rate limits, and transmit queue configuration. You can then assign the class of service as a classification rule action, as part of the definition of an automated service, or as a role default. See [Getting Started with Class of Service](#) for more information.

## Classification Types and their Parameters

When you define a rule's traffic description, you select a classification type, and then select or enter certain parameters or values for each type. Classification types are grouped according to Layers 2, 3, 4, or 7 of the OSI model.

### Layer 2 -- Data Link Classification Types

Layer 2 classification types allow you to define classification rules based on an exact match of the MAC address or specific protocol type of each frame.

#### **MAC Address Source, MAC Address Destination, MAC Address Bilateral**

These classification types are based on an exact match of the source, destination, or bilateral (either source or destination) MAC address contained in an Ethernet frame. Enter a valid MAC address or click **Select** to open a window where you can select a MAC address read from your network devices. You can specify a mask, however masking a MAC address is not supported on legacy devices.

#### **Ethertype**

This classification type is based on the specific protocol type of each frame defined in the two-byte Ether type field. Select an Ether type from the list of well-known values, or select **Other** and manually enter a single value in hexadecimal form. You can enter a range of values, however range rules are not supported on legacy devices or N-Series Gold.

Well-known Ethertypes	Values
IP	0x0800

Well-known Ethertypes	Values
ARP	0x0806
Reverse ARP	0x8035
Novell IPX 1	0x8137
Novell IPX 2	0x8138
Banyan	0x0bad
AppleTalk	0x809b
AppleTalk ARP	0x80f3
IPv6	0x86dd
Decnet Phase 4	0x6003

### DSAP/SSAP

This classification type is based on the specific protocol type of each frame defined in the DSAP and SSAP fields. Select a protocol from the list of well-known values, or select **Other** and manually enter a custom two-byte value in hexadecimal format (0xFFFF). The LSB of the DSAP address specifies Individual(0) or Group(1), while the LSB of the SSAP address specifies Command(0) or Response(1). For the SNAP frame type, you may enter Advanced DSAP/SSAP configurations. The advanced fields are not supported on legacy devices and are ignored.

Well-known DSAP/SSAP Types	Values
IP	0x0606
IPX	0xe0e0
NetBIOS	0xf0f0
Banyan Vines	0xbcbc
SNA	0x0404
SNAP	0xAAAA
Other	a two-byte value

### VLAN ID

This classification type is based on an exact match of the VLAN tag contained within a frame. Select a VLAN ID (VID) from the list of VLANs defined in the Policy tab. If you select **Other**, you must enter a single VID or specify a range of VIDs in decimal form. Range rules are not supported on legacy devices.

**Priority**

This classification type is based on an exact match of the Priority tag contained within a frame. Select a Priority value 0 - 7 from the list of well-known values, or select **Other** and enter a value in decimal form.

**Layer 3 -- Network Classification Types**

Layer 3 Network classification types allow you to define classification rules based on specific information contained within the Layer 3 header of an IP or IPX frame.

**IP Time to Live (TTL)**

This classification type is based on an exact match of the TTL field contained in the IP header of a frame. The TTL field indicates the maximum number of router hops the packet can make before being discarded. The TTL field is set by the packet sender and reduced by every router on the route to its destination. If the TTL field reaches zero before the packet arrives at its destination, then the packet is discarded. IP Time to Live rules are only supported on K-Series and S-Series devices.

**IPX Network Source, IPX Network Destination, IPX Network Bilateral**

These classification types are based on specific information contained within the Layer 3 header of an IPX frame. It is a four-byte user-defined value that represents the IPX source, destination, or bilateral (either source or destination) network number. This value must be a valid IPX network address in hexadecimal form. You can enter a range of values, however range rules are not supported on legacy devices or N-Series Gold.

**IPX Socket Source, IPX Socket Destination, IPX Socket Bilateral**

These classification types are based on specific information contained within the Layer 3 header of an IPX frame. It is a two-byte, user-defined value that represents the IPX source, destination, or bilateral (either source or destination) socket numbers. This value is used by higher layer protocols to target specific applications running among hosts. Select an IPX Socket type from the list of well-known values, or select **Other** and manually enter the value in decimal form. You can enter a range of values, however range rules are not supported on legacy devices or N-Series Gold.

Well-known IPX Socket Types	Values
NCP	1105

Well-known IPX Socket Types	Values
SAP	1106
RIP	1107
NetBIOS	1109
Diagnostics	1110
NSLP	36865
IPX Wan	56868
Other	0-65535

### IPX Class of Service

This classification type is based on specific information contained within the Layer 3 header of an IPX frame. This is a one-byte field used for transmission control (hop count) by IPX routers. Enter a valid IPX Class of Service in decimal form, 0-255. You can enter a range of values, however range rules are not supported on legacy devices or N-Series Gold.

### IPX Packet Type

This classification type is based on specific information contained within the Layer 3 header of an IPX frame. Select an IPX Packet type from the list of well-known values or select **Other** and manually enter the value in decimal form. You can enter a range of values, however range rules are not supported on legacy devices or N-Series Gold.

Well-known IPX Packet Types	Values
Hello/SAP	0
RIP	1
Echo Packet	2
Error Packet	3
NetWare 386	4
SeqPackProt	5
NetWare 286	17
Other	0-31

### IPv6 Address Source, IPv6 Address Destination, IPv6 Address Bilateral

These classification types are based on an exact match of the source, destination, or bilateral (either source or destination) IPv6 address information contained within

the IPv6 header of each frame. Enter a valid IPv6 address and optional mask ("/n") in the Value field.

**IPv6 Socket Source, IPv6 Socket Destination, IPv6 Socket Bilateral**

These classification types are based on an exact match of a specific source, destination, or bilateral (either source or destination) IPv6 address and a UDP/TCP port number (type) contained within the IPv6 header of each frame. Enter an IPv6 address in the Value field. Then, select a UDP/TCP type from the list of well-known values, or select **Other** and manually enter the value in form. (UDP/TCP port numbers are defined in RFC 1700.) If you select **Other**, you can enter a range of values.

Well-known UDP/TCP Types	Values
FTP Data	20
FTP	21
SSH	22
Telnet	23
SMTP	25
TACACS	49
DNS	53
BootP Server	67
BootP Client	68
TFTP	69
Finger	79
HTTP	80
POP3	110
Portmapper	111
NNTP	119
NTP	123
NetBIOS Name Service	137
NetBIOS Datagram Service	138
NetBIOS Session Service	139

Well-known UDP/TCP Types	Values
IMAP2/IMAP4	143
SNMP	161
IMAP3	220
LDAP	389
HTTPS	443
R-Exec	512
R-Login	513
R-Shell	514
LPR	515
RIP	520
SOCKS	1080
Citrix ICA	1494
RADIUS	1812
RADIUS Accounting	1813
NFS	2049
X11 (Range Start)	6000
X11 (Range End)	6063
Other	0-65535

**IPv6 Flow Label**

These classification types are based on the exact match of the value in the 20-bit Flow Label field in the IPv6 header. This field is used to identify packets belonging to particular traffic flow that needs special traffic handling. Enter a flow label value and sigbits mask.

**IP Address Source, IP Address Destination, IP Address Bilateral**

These classification types are based on an exact match of the source, destination, or bilateral (either source or destination) IP address information contained within the IP header of each frame. Enter a valid IP address and optional mask ("/n") in the Value field.

**IP Socket Source, IP Socket Destination, IP Socket Bilateral**

These classification types are based on an exact match of a specific source, destination, or bilateral (either source or destination) IP address and a UDP/TCP



port number (type) contained within the IP header of each frame. Enter an IP address in the Value field. Then, select a UDP/TCP type from the list of well-known values, or select **Other** and manually enter the value in decimal form. (UDP/TCP port numbers are defined in RFC 1700.) If you select **Other**, you can enter a range of values, however range rules are not supported on legacy devices or N-Series Gold.

Well-known UDP/TCP Types	Values
FTP Data	20
FTP	21
SSH	22
Telnet	23
SMTP	25
TACACS	49
DNS	53
BootP Server	67
BootP Client	68
TFTP	69
Finger	79
HTTP	80
POP3	110
Portmapper	111
NNTP	119
NTP	123
NetBIOS Name Service	137
NetBIOS Datagram Service	138
NetBIOS Session Service	139
IMAP2/IMAP4	143
SNMP	161
IMAP3	220
LDAP	389

Well-known UDP/TCP Types	Values
HTTPS	443
R-Exec	512
R-Login	513
R-Shell	514
LPR	515
RIP	520
SOCKS	1080
Citrix ICA	1494
RADIUS	1812
RADIUS Accounting	1813
NFS	2049
X11 (Range Start)	6000
X11 (Range End)	6063
Other	0-65535

### IP Fragment

This classification type is based on Layer 4 information in fragmented frames. IP supports frame fragmentation, where large frames are divided into smaller fragments and sent wrapped in the original Layer 3 (IP) header. When a frame is fragmented, information that is Layer 4 and above is only present in the first fragment. For example, the first fragment may be classified to Layer 4, while subsequent fragments will be classified only to Layer 3. The product line does not support Layer 4 classification for IP frames that have been fragmented, as the Layer 4 information is not present in these frames. Using the IP Fragment classification rule, any frame which is a fragment of a larger frame, is classified according to the information in the original frame. If the first fragment is classified to Layer 4, subsequent fragments will also be classified to Layer 4.

### ICMP and ICMPv6

These classification types are based on an exact match of the ICMP (Internet Control Message Protocol) message contained in the ICMP tag within a frame. Select an ICMP well-known value type from the list of well-known values (some well-known value types also let you select a code), or select **Other** and manually enter the value in hexadecimal form. The format of the value is 0xXXYY, where "XX" is the ICMP

type, and "YY" is the associated code, if applicable. You can enter a range of values, however range rules are not supported on legacy devices or N-Series Gold.

### **IP Type of Service**

This classification type is based on an exact match of the one-byte ToS/DSCP field contained in the IP header of a frame. The ToS (Type of Service) or DSCP (Diffserve Codepoint) value is defined by an 8-bit hexadecimal number between 0 and FF. Enter a value or click Select to open a window where you can generate a hex value.

Type of Service can be used by applications to indicate priority and Quality of Service for each frame. The level of service is determined by a set of service parameters which provide a three way trade-off between low-delay, high-reliability, and high-throughput. The use of service parameters may increase the cost of service. In many networks, better performance for one of these parameters is coupled with worse performance on another. Except for very unusual cases, at most, two of the parameters should be set.

**For a ToS value**, the 8-bit hexadecimal number breaks down as follows:

Bits 0-2: Precedence

Bit 3: 0=Normal Delay, 1=Low Delay

Bit 4: 0=Normal Throughput, 1=High Throughput

Bit 5: 0=Normal Reliability, 1=High Reliability

Bits 6-7: Explicit Congestion Notification

The precedence bits (bits 0-2) break down as follows:

111 - Network Control

110 - Internetwork Control

101 - CRITIC/ECP

100 - Flash Override

011 - Flash

010 - Immediate

001 - Priority

000 - Routine

The Network Control precedence designation is intended to be used within a network only. The actual use and control of that designation is up to each network. The Internetwork Control designation is intended for use by gateway originators only.

For a **DSCP value**, the value represents codepoints for two Differentiated Services (DS) Per-Hop-Behavior (PHB) groups called Expedited Forwarding (EF) and Assured Forwarding (AF). For more information on these PHB groups, refer to RFC 2597 and RFC 2598.

### IP Protocol Type

This classification type is based on the specific protocol type defined in a field contained in the IP header of each frame. Select a protocol from the list of well-known values, or select **Other** and manually enter the value in decimal form. You can enter a range of values, however range rules are not supported on legacy devices or N-Series Gold.

Well-known IP Protocol Types	Values
ICMP	1
IGMP	2
TCP	6
EGP	8
UDP	17
IPv6 (encapsulated in IPv4 packets)	41
RSVP	46
GRE	47
ESP	50
AH	51
ICMPv6	58
EIGRP	88
OSPF	89
PIM	103
VRRP	112
L2TP	115
Other	0-255

## Layer 4 -- Application Transport Classification Types

Layer 4 IP classification types allow you to define classification rules based on specific Layer 4 TCP or UDP port numbers contained in the header of an IP frame. You can specify a specific port number or a range of port numbers.

**Note:** Certain devices do not support Layer 4 classification for IP frames that have been fragmented, as the Layer 4 information is not present in these frames. If a device has an FDDI HSIM installed, Layer 4 classification will not be supported for any frames larger than 1500 bytes. Frames larger than 1500 bytes are fragmented internally in the switch. When creating classification rules based on specific Layer 4 information, using the [IP Fragment](#) classification rule will allow fragmented frames to be classified according to the Layer 4 information contained in the original frame.

### IP UDP Port Source, IP UDP Port Destination, IP UDP Port Bilateral

These classification types are based on specific Layer 4 UDP port numbers contained within the header of an IP frame. Select a UDP type from the list of well-known values, or select **Other** and manually enter the value in decimal form. (UDP port numbers are defined in RFC 1700.) You can enter a range of values, however range rules are not supported on legacy devices or N-Series Gold. Enter a valid IPv4 or IPv6 address and optional mask ("/n"), if desired. The IP address is an optional field and does not have to be specified. It is only valid for non-range port values.

Well-known UDP Types	Values
FTP Data	20
FTP	21
SSH	22
Telnet	23
SMTP	25
TACACS	49
DNS	53
BootP Server	67
BootP Client	68
TFTP	69

Well-known UDP Types	Values
Finger	79
HTTP	80
POP3	110
Portmapper	111
NNTP	119
NTP	123
NetBIOS Name Service	137
NetBIOS Datagram Service	138
NetBIOS Session Service	139
IMAP2/IMAP4	143
SNMP	161
IMAP3	220
LDAP	389
HTTPS	443
R-Exec	512
R-Login	513
R-Shell	514
LPR	515
RIP	520
SOCKS	1080
Citrix ICA	1494
RADIUS	1812
RADIUS Accounting	1813
NFS	2049
X11 (Range Start)	6000
X11 (Range End)	6063
Other	0-65535

**IP TCP Port Source, IP TCP Port Destination, IP TCP Port Bilateral**

These classification types are based on specific Layer 4 TCP port numbers contained within the header of an IP frame. Select a TCP type from the list of well-known values, or select **Other** and manually enter the value in decimal form. (TCP port numbers are defined in RFC 1700.) You can enter a range of values, however range rules are not supported on legacy devices or N-Series Gold. Enter a valid IPv4 or IPv6 address and optional mask ("/n"), if desired. The IP address is an optional field and does not have to be specified. It is only valid for non-range port values.

Well-known TCP Types	Values
FTP Data	20
FTP	21
SSH	22
Telnet	23
SMTP	25
TACACS	49
DNS	53
BootP Server	67
BootP Client	68
TFTP	69
Finger	79
HTTP	80
POP3	110
Portmapper	111
NNTP	119
NTP	123
NetBIOS Name Service	137
NetBIOS Datagram Service	138
NetBIOS Session Service	139
IMAP2/IMAP4	143
SNMP	161

Well-known TCP Types	Values
IMAP3	220
LDAP	389
HTTPS	443
R-Exec	512
R-Login	513
R-Shell	514
LPR	515
RIP	520
SOCKS	1080
Citrix ICA	1494
RADIUS	1812
RADIUS Accounting	1813
NFS	2049
X11 (Range Start)	6000
X11 (Range End)	6063
Other	0-65535

**IP UDP Port Source Range, IP UDP Port Destination Range, IP UDP Port Bilateral Range**

These classification types are based on Layer 4 UDP port numbers contained within the header of an IP frame. When you select this type, you enter a range of UDP port numbers that the port number in the header will be matched against. Enter the start and end range values in decimal form. UDP port numbers are defined in RFC 1700.

**IP TCP Port Source Range, IP TCP Port Destination Range, IP TCP Port Bilateral Range**

These classification types are based on Layer 4 TCP port numbers contained within the header of an IP frame. When you select this type, you enter a range of TCP port numbers that the port number in the header will be matched against. Enter the start and end range values in decimal form. TCP port numbers are defined in RFC 1700.

**Layer 7 -- Application Classification Types**

Layer 7 IP classification types allow you to define classification rules based on specific Layer 7 application types.



## Application

This rule type allows management of traffic for a specific application type, for example Apple traffic (Bonjour) using mDNS-SD. The following application types are supported:

- LLMNR - (Link Local Multicast Name Resolution) Query/Response  
This protocol is based on the Domain Name System (DNS) packet format. It allows hosts to perform name resolution for hosts on the same local link.
- SSDP - (Simple Service Discovery Protocol) Query/Response  
SSDP is a Universal Plug-and-Play (UPnP) based protocol. SSDP uses the NOTIFY and MSEARCH HTTP methods to discover and advertise services on the network.
- mDNS-SD - (Multicast Domain Name System – Service Discovery) Query/Response  
DNS-SD is a service discovery protocol that utilizes the Domain Name System. Multicast DNS is a protocol that is mostly compatible with normal DNS but uses link local multicast addressing, allowing for zero configuration networking (zeroconf) functionality.

## Examples of How Rules are Used

Traffic Classification rules are used to provide four key policy features: Traffic Containment, Traffic Filtering, Traffic Security, and Traffic Priority.

### Traffic Containment

Using classification rules, network administrators can group together users of a given protocol, subnet, or application, and control where their traffic can logically go on the network.

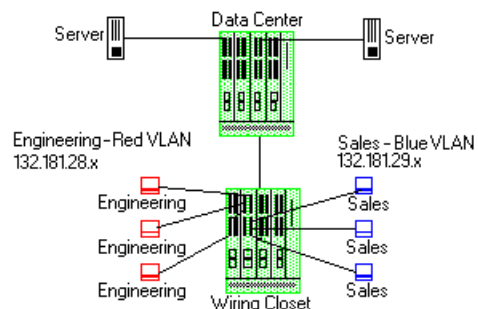

The figure above shows a configuration where the network administrator wants to separate end-user traffic into VLANs based on the assigned IP subnet of each

department. This can easily be accomplished by creating two Layer 3 classification rules based on the IP subnet range of the respective departments.

Rule 1 - Engineering, which uses the 132.181.28.x subnet, will be assigned to the Red VLAN.

Rule 2 - Sales, which uses the 132.181.29.x subnet, will be assigned to the Blue VLAN.

Based on these two Layer 3 classification rules, the traffic from the Engineering VLAN will be isolated from the Sales VLAN. Since these rules are based on Layer 3 information, an Engineering user could enter the network from a connection in the Sales department, and that user would still be contained in the Engineering VLAN.

## Traffic Filtering

Classification rules can also be used to filter out (discard) specific unwanted traffic. Filter criteria can include things such as broadcast routing protocols, specific IP addresses, or even applications such as HTTP or SMTP.

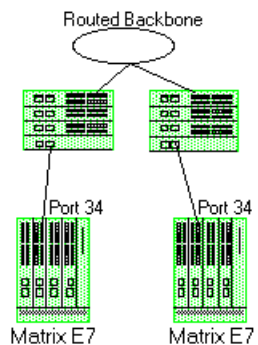

The figure above shows a common configuration in which a routed backbone is using both RIP and OSPF for its routing protocols. The network administrator does not want the multicast OSPF and broadcast RIP frames propagated to the end stations. The network is designed so that only end users are attached to the E7 devices.

To implement filtering in this scenario, a Layer 3 rule and a Layer 4 rule will be created.

Rule 1 (Layer 3) - Any frame received with an IP Protocol Type of 89 (OSPF) will be discarded.

Rule 2 (Layer 4) - Any frame received with a Bilateral UDP port number of 520 (RIP) will be discarded.

Based on this configuration, all RIP and OSPF frames will be filtered from the end users.

## Traffic Security

Traffic Security uses the same concepts as [Traffic Filtering](#). Imagine a scenario where network access is provided to a group of unknown users. There have been problems with these unknown users "hacking" into the router and altering the configuration. A simple classification rule can be put in place that will prevent these types of occurrences.

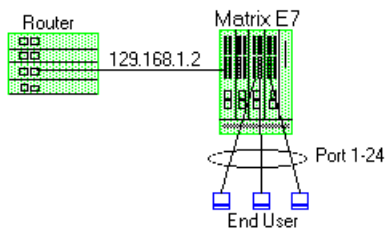

In the figure above, the network components include a router and an E7 device. In this configuration end-users connect to the ports of the E7 device.

Since the end-users would never need to communicate directly to the router using the router's IP address, a Layer 3 IP classification rule will be used.

Rule - Any frames received by the switch with a destination IP address of the router (129.168.1.2) will be discarded.

The end result is that any frames from a user trying to "hack" into the router will be discarded before ever reaching the router.

## Traffic Prioritization

Classification rules can be used to specify that certain network applications receive the highest transmission priority. For example, a network administrator wants to assign priority to three network applications, SAP R/3, web traffic, and email, in that order.

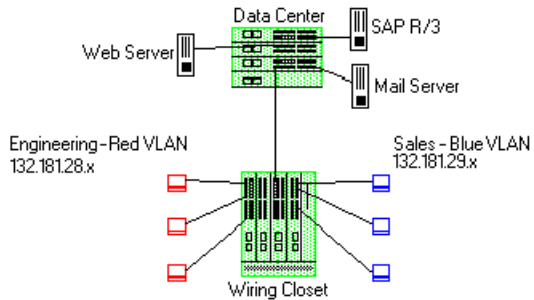

To accomplish the prioritization goals in this example, there are two main steps required: creating the classification rules, and then configuring the priority-to-transmit queue mapping for the switch, if needed.

First, create one Layer 3 and two Layer 4 classification rules.

Rule 1, Layer 3 (SAP R/3) - All frames to or from the IP address of the SAP R/3 server will be tagged with a priority indicator of 7 (highest).

Rule 2, Layer 4 (Web) - All frames with a TCP port number of 80 (HTTP) will be tagged with a priority indicator of 5.

Rule 3, Layer 4 (email) - All frames with a TCP port number of 25 (SMTP) will be tagged with a priority indicator of 3.

**Note:** An IP address classification was selected for Rule 1 because it has been observed that SAP R/3 dynamically negotiates the TCP/UDP port used, so the port number selections vary from session to session. If this was not the case, a Layer 4 UDP classification could be used.

Then, configure the priority-to-transmit queue mappings. Each switch has default priority-to-transmit queue mappings. You can use these defaults or change the mappings using local management or the legacy Console java application. In addition, the **Policy** tab provides the ability to configure transmit queues as part of the Role-Based Rate Limits and Transmit Queue Configuration class of service mode. This functionality is available only on certain devices such as the S-Series and N-Series Gold and Platinum devices (refer to the Extreme Management Center Firmware Support tables for specific device/firmware rate limit support).

Based on the default priority-to-traffic queue mapping for an E7 device, the priorities assigned above will work out so that each frame classification type will be mapped to the desired traffic queue. This means that no user configuration of the priority-to-transmit queue mapping would be required.

With the classification rules described above, the network traffic would be prioritized as shown in the table below:

Application	Classification Type	Desired Priority	Priority Value	E7 Traffic Queue
SAP R/3	Bilateral IP	High	7	3
Web	TCP Port Number	Medium	5	2
Email	TCP Port Number	Low	3	1

---

### Related Information

For information on related tasks:

- [How to Create or Modify a Rule](#)
- [How to Define Traffic Descriptions](#)

## Extreme Management Center Ports (Transmit Queue Port Group)

---

The **Ports** tab lets you view all the ports in the selected transmit queue port group, as well as add and remove ports to and from the group. It provides information about each port, and lets you view and edit port information.

To access this tab:

1. Open the **Control** tab.
2. Open the **Policy** tab.
3. Open the **Class of Service > CoS Components** left-panel tab.
4. Select either the **Transmit Queue Port Groups** left-panel tab.
5. Select a existing port group in the left panel to open it in the **Transmit Queue Port Group** tab.

---

**NOTE:** Create a new port group by right-clicking the **Transmit Queue Port Groups** left-panel tab, selecting **Create Port Group**, entering a **Name** for the port group, and clicking **OK**.

---

6. Select the **Ports** tab in the right panel.

## Extreme Management Center Ports (Transmit Queue Port Group)

Transmit Queue Port Group: Default									
CoS - Transmit Queue Mappings <b>Ports</b>									
Add/Remove									
Name	Rate/Queue Port Type	Default Role	Alias	Stats	Port Type	Neighbor	Port Speed	Description	
fe.1.1	4 Transmit Queues	Administrator			Interswitch	[ ] Port ge.1.11	10/100	Extreme Networks, Inc. 100BASE-TX RJ45 F	
fe.1.2	4 Transmit Queues				Access	Last Known: [ ] Port ge.1.2	10/100	Extreme Networks, Inc. 100BASE-TX RJ45 F	
fe.1.3	4 Transmit Queues				Access		10/100	Extreme Networks, Inc. 100BASE-TX RJ45 F	
fe.1.4	4 Transmit Queues				Interswitch	[ ] Port 1:1	10/100	Extreme Networks, Inc. 100BASE-TX RJ45 F	
fe.1.5	4 Transmit Queues				Interswitch	[ ] Port 1:1	10/100	Extreme Networks, Inc. 100BASE-TX RJ45 F	
fe.1.6	4 Transmit Queues				Access		10/100	Extreme Networks, Inc. 100BASE-TX RJ45 F	
fe.1.7	4 Transmit Queues				Access		10/100	Extreme Networks, Inc. 100BASE-TX RJ45 F	
fe.1.8	4 Transmit Queues				Access		10/100	Extreme Networks, Inc. 100BASE-TX RJ45 F	
fe.1.9	4 Transmit Queues				Access		10/100	Extreme Networks, Inc. 100BASE-TX RJ45 F	
fe.1.10	4 Transmit Queues				Access		10/100	Extreme Networks, Inc. 100BASE-TX RJ45 F	
fe.1.11	4 Transmit Queues				Access		10/100	Extreme Networks, Inc. 100BASE-TX RJ45 F	
fe.1.12	4 Transmit Queues				Interswitch	[ ] Port 1:1	10/100	Extreme Networks, Inc. 100BASE-TX RJ45 F	
fe.1.13	4 Transmit Queues				Access		10/100	Extreme Networks, Inc. 100BASE-TX RJ45 F	
fe.1.14	4 Transmit Queues				Access		10/100	Extreme Networks, Inc. 100BASE-TX RJ45 F	
fe.1.15	4 Transmit Queues				Access		10/100	Extreme Networks, Inc. 100BASE-TX RJ45 F	
fe.1.16	4 Transmit Queues				Access		10/100	Extreme Networks, Inc. 100BASE-TX RJ45 F	
fe.1.17	4 Transmit Queues				Access		10/100	Extreme Networks, Inc. 100BASE-TX RJ45 F	
fe.1.18	4 Transmit Queues				Access		10/100	Extreme Networks, Inc. 100BASE-TX RJ45 F	
fe.1.19	4 Transmit Queues				Access		10/100	Extreme Networks, Inc. 100BASE-TX RJ45 F	
fe.1.20	4 Transmit Queues				Access		10/100	Extreme Networks, Inc. 100BASE-TX RJ45 F	
fe.1.21	4 Transmit Queues				Access		10/100	Extreme Networks, Inc. 100BASE-TX RJ45 F	

### Name

Name of the port, constructed of the name or IP address of the device and either the port index number or the port interface name.

### Rate/Queue Port Type

The number of rate limits the port supports.

### Default Role

The default role assigned to the port. See [Default Role](#) in the Concepts topic for information on default roles. For additional information, see [Port Mode](#).

### Alias

Shows the alias (ifAlias) for the interface, if one is assigned.

### Stats

Shows statistics collected for a port, enabled via the Flow Collection & Interface setting in the [PortView](#).

### Port Type

Type of port. Possible values include: Access, Interswitch Backplane, Backplane, Interswitch, and Logical.

### Neighbor

The port's neighbor port.

### **Port Speed**

Speed of the port. Possible values include: 10/100, speed in megabits per second (for example, 800.0 Mbps), Unknown (displayed for logical ports).

### **Description**

A description of the port.

### **Add/Remove Ports Button**

Opens the [Add/Remove Ports window](#), where you can add and remove ports to and from the port group. When you create new port groups, you add ports from the Default group into your newly defined port groups.

---

### **Related Information**

For information on related concepts:

- [Getting Started with Class of Service](#)

For information on related tasks:

- [How to Configure Transmit Queues](#)

For information on related windows:

- [CoS - Transmit Queue Mappings Tab \(Transmit Queue Port Group\)](#)

## **Extreme Management Center Summary (Transmit Queue Port Groups)**

---

This tab displays the transmit queue port groups. Transmit queue mapping maps a logical transmit queue index (used by a class of service) to an actual physical transmit queue you have configured in the **Policy** tab. You can configure transmit queue mappings for a port group using the [CoS - Transmit Queue Mappings tab](#).

To access this tab, open the **Class of Service > CoS Components** tab. Then, select the **Transmit Queue Port Groups** tab in the left panel. The Summary tab displays in the right panel.

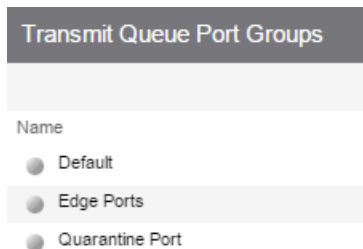

### Name

The name of the transmit queue port group.

---

### Related Information

For information on related concepts:

- [Getting Started with Class of Service](#)

For information on related tasks:

- [How to Configure Transmit Queues](#)

For information on related windows:

- [CoS - Transmit Queue Mappings Tab \(Transmit Queue Port Group\)](#)
- [Ports Tab \(Transmit Queue Port Group\)](#)

## Extreme Management Center CoS - Transmit Queue Mappings (Transmit Queue Port Group)

---

This tab lets you view and configure the transmit queue mappings for a port group. Transmit queue mappings map a logical rate limit index used by classes of service to an actual physical rate limit you have created in Extreme Management Center.

Each port group has its own set of index mappings. Extreme Management Center automatically assigns these index numbers when you configure a class of services' rate limits and transmit queue shapers.

The **Transmit Queue Mappings** tab allows you to do two things:



## Extreme Management Center CoS - Transmit Queue Mappings (Transmit Queue

- Map the index to a different rate for different port groups (edge ports versus inter-switch links). See [Creating Class of Service Port Groups](#)
- Map the index to a different rate limit for each port type (8-rate limit, 32-rate limit, 64-rate limit, and 100-rate limit) in a port group. See [Advanced Rate Limiting by Port Type](#).

To access this tab:

1. Open the **Control** tab.
2. Open the **Policy** tab.
3. Open the **Class of Service > CoS Components** left-panel tab.
4. Select either the **Transmit Queue Port Groups** left-panel tab.
5. Select a existing port group in the left panel to open it in the **Transmit Queue Port Group** tab.

---

**NOTE:** Create a new port group by right-clicking the **Transmit Queue Port Groups** left-panel tab, selecting **Create Port Group**, entering a **Name** for the port group, and clicking **OK**.

---

6. Select the **CoS - Transmit Queue Mappings** tab in the right panel.

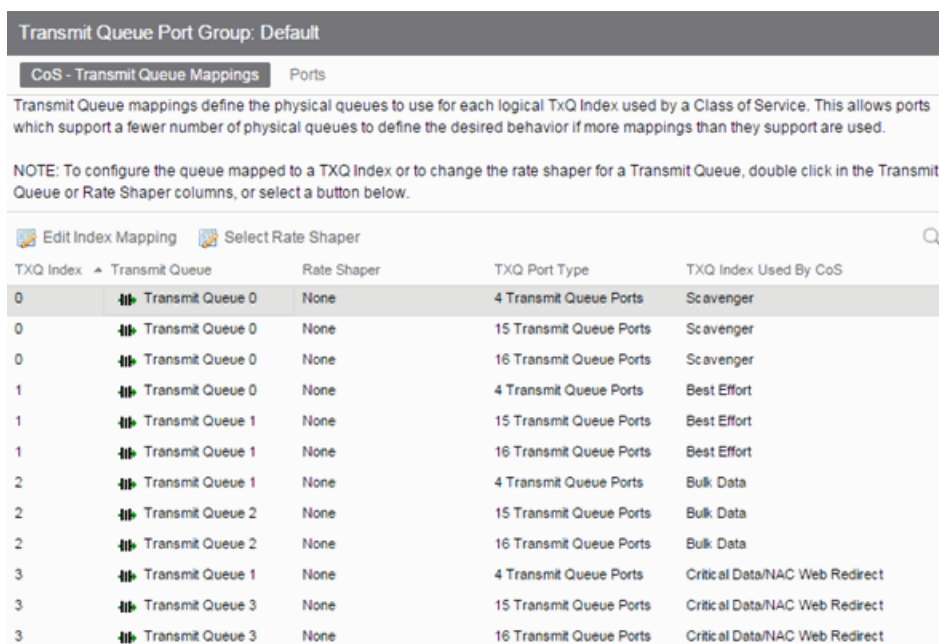

Transmit Queue Port Group: Default

CoS - Transmit Queue Mappings Ports

Transmit Queue mappings define the physical queues to use for each logical TxQ Index used by a Class of Service. This allows ports which support a fewer number of physical queues to define the desired behavior if more mappings than they support are used.

NOTE: To configure the queue mapped to a TXQ Index or to change the rate shaper for a Transmit Queue, double click in the Transmit Queue or Rate Shaper columns, or select a button below.

Edit Index Mapping Select Rate Shaper

TXQ Index	Transmit Queue	Rate Shaper	TXQ Port Type	TXQ Index Used By CoS
0	Transmit Queue 0	None	4 Transmit Queue Ports	Scavenger
0	Transmit Queue 0	None	15 Transmit Queue Ports	Scavenger
0	Transmit Queue 0	None	16 Transmit Queue Ports	Scavenger
1	Transmit Queue 0	None	4 Transmit Queue Ports	Best Effort
1	Transmit Queue 1	None	15 Transmit Queue Ports	Best Effort
1	Transmit Queue 1	None	16 Transmit Queue Ports	Best Effort
2	Transmit Queue 1	None	4 Transmit Queue Ports	Bulk Data
2	Transmit Queue 2	None	15 Transmit Queue Ports	Bulk Data
2	Transmit Queue 2	None	16 Transmit Queue Ports	Bulk Data
3	Transmit Queue 1	None	4 Transmit Queue Ports	Critical Data/NAC Web Redirect
3	Transmit Queue 3	None	15 Transmit Queue Ports	Critical Data/NAC Web Redirect
3	Transmit Queue 3	None	16 Transmit Queue Ports	Critical Data/NAC Web Redirect

### TXQ Index

The logical transmit queue index. This index number is specified in a class of service and dictates the queue and shaping behavior for incoming packets.

### **Transmit Queue**

Displays the physical transmit queue used to map to each transmit queue index. To change this value, click the **Edit Index Mapping** button to open the Edit Transmit Queue Mapping window and select a value in the **Transmit Queue** drop-down menu.

### **Rate Shaper**

The transmit queue's associated rate shaper. To change this value, click the **Select Rate Shaper** button to open the Select Transmit Queue Rate Shaper window and select a value in the **Rate Limit** field.

### **TXQ Port Type**

The Port Type is based on the number of transmit queues the port supports: 4 transmit queues or 16 transmit queues.

### **TXQ Index Used By CoS**

The Class of Service using this TXQ index.

---

## **Related Information**

For information on related concepts:

- [Getting Started with Class of Service](#)

For information on related tasks:

- [How to Configure Transmit Queues](#)

For information on related windows:

- [Ports Tab \(Transmit Queue Port Group\)](#)

## **Extreme Management Center Ports (Flood Control Port Groups)**

---

The **Flood Control Port Group Ports** tab provides a table of information about the ports in the selected port group. It also includes buttons that enable you to retrieve the latest information about the ports and to add and remove ports. To access this tab, select a port group in the left-panel **Flood Control Port Groups** tab, then select the **Ports** tab in the right panel.

**NOTE:** The **Ports** tab is only available when a Flood Control port group is selected, and when advanced mode is enabled on the [CoS Components tab](#).

Flood Control Port Group: Default

Flood Control Rate Limits **Ports**

+ Add/Remove 🔍

Name	Rate/Queue Port Type	Default Role	Alias	Stats	Port Type	Neighbor	Port Speed	Description
fe.1.1	3 Rate Limits				Interswitch	[ ] Port ge.1.10	10/100	100BASE-TX RJ45 Fast Ethernet Frc
fe.1.2	3 Rate Limits				Access			100BASE-TX RJ45 Fast Ethernet Frc
fe.1.3	3 Rate Limits				Interswitch	[ ] Port ge.1.1	10/100	100BASE-TX RJ45 Fast Ethernet Frc
fe.1.4	3 Rate Limits				Interswitch	[ ] Port 1:1	10/100	100BASE-TX RJ45 Fast Ethernet Frc
fe.1.5	3 Rate Limits		AP		Access	Last Known: [ ] ..		100BASE-TX RJ45 Fast Ethernet Frc
fe.1.6	3 Rate Limits				Access	Last Known: [ ] ..		100BASE-TX RJ45 Fast Ethernet Frc
fe.1.7	3 Rate Limits				Access			100BASE-TX RJ45 Fast Ethernet Frc
fe.1.8	3 Rate Limits				Access			100BASE-TX RJ45 Fast Ethernet Frc
fe.1.9	3 Rate Limits				Access			100BASE-TX RJ45 Fast Ethernet Frc
fe.1.10	3 Rate Limits				Access			100BASE-TX RJ45 Fast Ethernet Frc
fe.1.11	3 Rate Limits				Access			100BASE-TX RJ45 Fast Ethernet Frc
fe.1.12	3 Rate Limits				Access			100BASE-TX RJ45 Fast Ethernet Frc
fe.1.13	3 Rate Limits				Access			100BASE-TX RJ45 Fast Ethernet Frc
fe.1.14	3 Rate Limits				Access			100BASE-TX RJ45 Fast Ethernet Frc
fe.1.15	3 Rate Limits				Access			100BASE-TX RJ45 Fast Ethernet Frc
fe.1.16	3 Rate Limits				Access			100BASE-TX RJ45 Fast Ethernet Frc

**Name**

Name of the port, constructed of the name or IP address of the device and either the port index number or the port interface name.

**Rate/Queue Port Type**

Shows the selected port type rate/queue.

**Default Role**

Shows the default role for the port. See [Default Role](#) in the Concepts topic for information on default roles. For additional information, see [Port Mode](#).

**Alias**

Shows the alias (ifAlias) for the interface, if one is assigned.

**Stats**

Shows that statistics are being collected for a port, enabled via the [PortView](#).

**Port Type**

Type of port. Possible values include: Access, Interswitch Backplane, Backplane, Interswitch, and Logical.

**Neighbor**

Port to which the port is connected.

**Port Speed**

Speed of the port. Possible values include: 10/100, speed in megabits per second (for example, 800.0 Mbps), Unknown (displayed for logical ports).

**Description**

A description of the port.

**Add/Remove Button**

Selecting a port in the table and clicking this button opens the [Add/Remove Ports window](#), which enables you to add and remove ports to and from the port group. This option is available for user-defined port groups only.

---

**Related Information**

For information on related concepts:

- [Getting Started with Class of Service](#)

For information on related tasks:

- [How to Create a Class of Service](#)
- [How to Configure Flood Control](#)

For information on related windows:

- [General Tab \(Rate Limit\)](#)

## Extreme Management Center Flood Control Port Groups

---

This panel lists port groups on which you can configure flood control. Each port group supports rate limits for three separate configured traffic types (Unicast, Multicast, and Broadcast).

To access this tab, open Class of Service > CoS Components left panel of the Policy tab and select Flood Control Port Groups.



### Name

The name of the port group.

---

### Related Information

For information on related concepts:

- [Getting Started with Class of Service](#)

For information on related tasks:

- [How to Create a Class of Service](#)
- [How to Configure Flood Control](#)

## Extreme Management Center Flood Control Rate Limits (Flood Control Port Groups)

This tab allows you to set individual flood control rates for each traffic type (Unicast, Multicast, and Broadcast).

Choices include:

- None
- Rate limits created in the **Rate Limit** tab. For additional information, see [Create Rate Limit/Shaper](#).

As flood control is enabled/disabled for a Class of Service, when enabled, each column displays a rate limit, or **None**, if no rate has been defined for that portion of flood control.

To access this tab, open the **Class of Service > CoS Components** left-panel tab. Then, select the **Flood Control** checkbox from the **General** tab in the left-panel to display the **Flood Control Port Groups** tab in the left panel. Expand the **Flood Control Port Groups** tab, and select a flood control port group in the tree. The **Flood Control Port Groups** tab is displayed in the right panel.

The screenshot shows a configuration window titled "Flood Control Port Group: Default". It has two tabs: "Flood Control Rate Limits" (selected) and "Ports". Below the tabs are three dropdown menus for setting rate limits:

Unicast Unknown:	None
Multicast:	None
Broadcast:	None

### Unicast Unknown

Select a rate, create a new rate, or edit an existing flood control rate limit for Unicast traffic.

### Multicast

Select a rate, create a new rate, or edit an existing flood control rate limit for Multicast traffic.

### Broadcast

Select a rate, create a new rate, or edit an existing flood control rate limit for Broadcast traffic.

---

### Related Information

For information on related concepts:

- [Getting Started with Class of Service](#)

For information on related tasks:

- [How to Create a Class of Service](#)
- [How to Configure Flood Control](#)
- [How to Create a Rate Limit](#)

For information on related windows:

- [General Tab \(Rate Limit\)](#)

### Class of Service Example

This Help topic provides an example of how class of service (CoS) can be configured on a network to manage bandwidth requirements of network traffic. Before you look at this example, read [Getting Started with Class of Service](#).

In this example, an organization's network administrator needs to assure that VoIP traffic, both originating in and transiting a network of edge switches and a core router, is configured with appropriate priority, ToS, and queue treatment. We also rate limit the VoIP traffic at the edge to 1 Mb/s to guard against DOS attacks, VoIP traffic into the core at 25 Mb/s, and H.323 call setup at 5 PPS. Data traffic retains the default configuration.

This example assumes CEP authentication using H.323 for VoIP. For networks that do not authenticate VoIP end point with CEP H.323 authentication, the VoIP policy needs to be adjusted accordingly. For instance, SIP uses UDP port 5060, not the TCP port 1720.

To simplify the discussion of the configuration process, this example is limited to the VoIP configuration context. The following table provides a set of sample values for priority, inbound rate limit (IRL), and transmit queue across a number

of real world traffic types. This table can be used as an aid in thinking about how you might want to apply CoS across your network. Note that Scavenger class is traffic that should be treated as less than best effort: external web traffic, for instance.

CoS Name	CoS Index	Priority	IRL		Transmit Queue					
					Queue#		Shaping		Bandwidth	
			Edge	Core	Edge	Core	Edge	Core	Edge	Core
Scavenger (Static)	0	0	15 Mb/s		0	0	10%		5%	5%
Best Effort (Static)	1	1								
Bulk Data (Static)	2	2			1	1	80%		45%	45%
Critical Data (Static)	3	3								
Network Control (Static)	4	4	40 PPS	1 Mb/s						
Network Mgmt (Static)	5	5	2 Mb/s		2	2	1 Mb/s		25%	25%
RTP/Voice/Video (Static)	6	6								
High Priority (Static)	7	7	1 Mb/s	25 Mb/s	3	3			25%	25%
VoIP Call Setup	8	7		5 PPS	3	3			25%	25%

The following figure displays the network setup for this example configuration, with the desired Profile/CoS summary for each network device. Each device is configured with VoIP and Data VLANs. Each VoIP VLAN contains four 1 gigabit interfaces for each device.



CoS VoIP Configuration Example

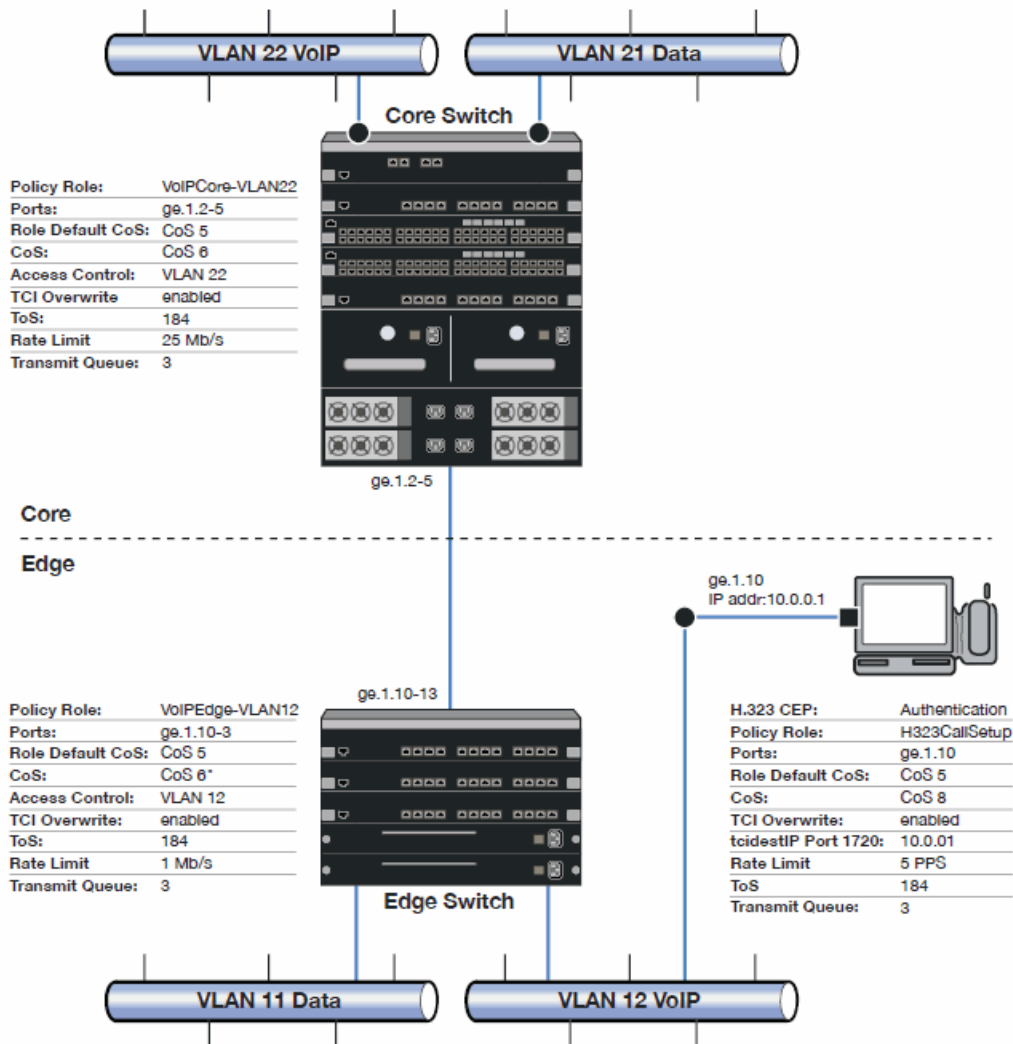

Edge and Core port groups in the RTP/Voice/Video (Static) CoS provide for the difference in rate limiting needs between the end user and aggregation devices. A VoIP Call Setup CoS provides rate limiting for the setup aspect of the VoIP call.

The Edge, Core, and H.323 Call Setup roles are configured with TCI Overwrite, default CoS 5 (best default priority for voice and video), and default access control that contains traffic to the appropriate VLAN.

Use the Policy tab to configure the policy roles and related services using the following instructions. For more information, see [How to Create a Class of Service](#) and [How to Define Rate Limits](#).

## Configure the Classes of Service

Use the Class of Service tab to configure the static RTP/Voice/Video CoS with the appropriate edge and core rate limits, and create a new CoS for the call setup rate limits.

1. For the static RTP/Voice/Video CoS (CoS Index 6):
  - a. Set the ToS to B8.
  - b. Create two new Inbound RL port groups called Edge and Core.
  - c. Set the Edge port group rate limit to 1 Mb/s and the Core port group rate limit to 25 Mb/s. (You may need to first create these rate limits.)
  - d. Add the appropriate ports to each port group.
2. Create a new class of service and name it VoIP Call Setup (CoS Index 8).
  - a. Set the rate limit to 5 PPS for all port groups. (You may need to first create this rate limit.)
  - b. Set the ToS to B8.

## Create the VoIP Core Role

For the core router, create a policy role for VoIP Core. VoIP Core policy deals with packets transiting the core network using VoIP VLAN 22.

1. Name the role VoIPCore VLAN22.
2. Enable TCI overwrite so that ToS is rewritten for this role.
3. Set the default access control action to Contain to VLAN 22.
4. Set default Class of Service to CoS Index 5.

## Create a VoIP Core Service

1. Name the service VoIPCore.
2. Add the service to the VoIPCore VLAN22 role.

## Create a Rule

1. Create a Layer 2 traffic classification rule for VLAN ID 22 within the VoIPCore service.
2. Assign the static RTP/Voice/Video CoS (CoS Index 6) as the Class of Service action for the rule.

## Creating the VoIP Edge Role

For the edge switches, create a policy role for VoIP Edge. VoIP Edge policy deals with packets transiting the edge network using VoIP VLAN 12.

1. Name the role VoIPEdge VLAN12.
2. Enable TCI overwrite so that ToS is rewritten for this role.
3. Set the default access control action to Contain to VLAN 12.
4. Set default Class of Service to CoS Index 5.

### Create a VoIP Edge Service

1. Name the service VoIPEdge.
2. Add the service to the VoIPEdge VLAN12 role.

### Create a Rule

1. Create a Layer 2 traffic classification rule for VLAN ID 12 within the VoIPEdge service.
2. Assign the static RTP/Voice/Video CoS (CoS Index 6) as the Class of Service action for the rule.

## Creating the H.323 Call Setup Role

The H.323 Call Setup role deals with the call setup traffic for VoIP H.323 authenticated users directly attached to the switch using link ge.1.10.

1. Name the role H323CallSetup.
2. Enable TCI overwrite so that ToS is rewritten for this policy.
3. Set default Class of Service to CoS Index 5.

### Create a H.323 Call Setup Service

1. Name the service H323CallSetup.
2. Add the service to the H323CallSetup role.

### Create a Rule

Create a Layer 4 traffic classification rule as follows:

1. Traffic Classification Type: IP TCP Port Destination
2. Enter in Single Value field: 1720 (TCP Port ID).
3. For IP TCP Port Destination value: 10.0.0.1 with a mask of 255.255.255.255.
4. Assign the new VoIP Call Setup CoS (CoS Index 8) as the Class of Service action for the rule.

## Apply the Roles to Network Devices

Once you have created your roles, you must apply them to the network devices as follows:

### Core Router

Apply the VoIPCore VLAN22 role to ports ge.1.2 5.

### Edge Switch

Apply the VoIPEdge VLAN12 role to ports ge.1.10 13.

Apply the H323CallSetup role to port ge.1.10

## ToS/DSCP Value Definition Chart

Use this chart to compare ToS and DSCP values.

ToS (Dec)	ToS (Hex)	ToS (Binary)	ToS Precedence (Binary)	ToS Precedence (Decimal)	ToS Precedence Name	ToS Delay Flag	ToS Throughput Flag	ToS Reliability Flag	DSCP (Binary)	DSCP (Hex)	DSCP (Decimal)	DSCP Class
0	0x00	00000000	000	0	Routine	0	0	0	000000	0x00	0	none
32	0x20	00100000	001	1	Priority	0	0	0	001000	0x08	8	cs1
40	0x28	00101000	001	1	Priority	0	1	0	001010	0x0A	10	af11
48	0x30	00110000	001	1	Priority	1	0	0	001100	0x0C	12	af12
56	0x38	00111000	001	1	Priority	1	1	0	001110	0x0E	14	af13
64	0x40	01000000	010	2	Immediate	0	0	0	010000	0x10	16	cs2
72	0x48	01001000	010	2	Immediate	0	1	0	010010	0x12	18	af21
80	0x50	01010000	010	2	Immediate	1	0	0	010100	0x14	20	af22
88	0x58	01011000	010	2	Immediate	1	1	0	010110	0x16	22	af23
96	0x60	01100000	011	3	Flash	0	0	0	011000	0x18	24	cs3
104	0x68	01101000	011	3	Flash	0	1	0	011010	0x1A	26	af31
112	0x70	01110000	011	3	Flash	1	0	0	011100	0x1C	28	af32

ToS (Dec)	ToS (Hex)	ToS (Binary)	ToS Precedence (Binary)	ToS Precedence (Decimal)	ToS Precedence Name	ToS Delay Flag	ToS Throughput Flag	ToS Reliability Flag	DSCP (Binary)	DSCP (Hex)	DSCP (Decimal)	DSCP Class
120	0x78	01111000	011	3	Flash	1	1	0	011110	0x1E	30	af33
128	0x80	10000000	100	4	FlashOverride	0	0	0	100000	0x20	32	cs4
136	0x88	10001000	100	4	FlashOverride	0	1	0	100010	0x22	34	af41
144	0x90	10010000	100	4	FlashOverride	1	0	0	100100	0x24	36	af42
152	0x98	10011000	100	4	FlashOverride	1	1	0	100110	0x26	38	af43
160	0xA0	10100000	101	5	Critical	0	0	0	101000	0x28	40	cs5
184	0xB8	10111000	101	5	Critical	1	1	0	101110	0x2E	46	ef
192	0xC0	11000000	110	6	InterNetwork Control	0	0	0	110000	0x30	48	cs6
224	0xE0	11100000	111	7	Network Control	0	0	0	111000	0x38	56	cs7

## Policy VLAN Tab Overview

The **VLAN** tab displays information about the VLAN selected in the left panel and lets you configure certain VLAN parameters. If you are using [VLAN to Role mapping](#) in your network, you can also use this tab to map the VLAN to a specific role. If you make a change on this tab, you need to [enforce](#) it.

To view this tab, select **Control > Policy > VLANs** and select a VLAN from the drop down.

Global VLAN: 1[DEFAULT VLAN]

Name:

VID:

Dynamic Egress

Always write VLAN to device(s)

---

Authentication Based VLAN (RFC3580) to Role Mapping

Mapped to Role: None Select...

---

Tagged Packet VLAN to Role Mapping

NOTE: To forward traffic with the VLAN ID & CoS specified by the mapped Role, TCI Overwrite must be enabled.

Device Level Mapping: None Select...

Primary C5/B5/A4/C3/B3/G3/C2/B2/D2 mapping

Port Level Mappings:

Port	Role

## General

This area provides general information about the VLAN and allows you to configure the VLAN.

### Name

Name of the VLAN selected in the left panel.

### VID

Unique number assigned to the VLAN, also called VID (for VLAN ID). This ID was either assigned by an administrator or assigned automatically by the system when the VLAN was created. The value can be anywhere between 1 and 4094, with VID 1 being reserved for the DEFAULT VLAN (a name for a particular VLAN, not to be confused with a role's assigned default VLAN).

### Dynamic Egress

Dynamically add all ports which use this VLAN to this VLAN's egress list. Dynamic Egress is enabled by default in Policy Manager. Leave disabled for discard VLANs. See [Dynamic Egress](#) for more information.

**Always write VLAN to device(s)**

If the box is checked, the VLAN is written to the device whether the VLAN is being used in a rule or role, or not. If it is not checked, the VLAN is not written to the device unless it is being used in a rule or role. Enabling this option is a way of ensuring that the device is aware of a VLAN that is being used for something other than policy configuration, and it allows you to configure that VLAN for Dynamic Egress. If the Default VLAN (VID=1) is selected in the left panel, this option is checked and cannot be edited, as the default VLAN is always on the device.

## Authentication-Based VLAN to Role Mapping

Authentication-Based VLAN to Role Mapping provides a way to assign a role to a user during the authentication process, based on a VLAN Attribute. (For more information, see [VLAN to Role Mapping](#) in the Concepts help topic.) This area displays what role (if any) the VLAN is mapped to (at the device-level) and lets you configure a mapping, if desired.

**Mapped to Role**

The role to which the VLAN is mapped. To select a role, click **Select**, click the **Assign RFC3580 VLAN -> Role Mapping** radio button, choose a role in the drop-down menu, and click **OK**.

**Select**

Opens the role [Selection View](#), where you can choose a role to associate with the VLAN.

## Tagged Packet VLAN to Role Mapping

Tagged Packet VLAN to Role Mapping provides a way to let policy-enabled devices assign a role to network traffic, based on a VLAN ID. (For more information, see [VLAN to Role Mapping](#) in the Concepts help topic.) This area displays what role (if any) the VLAN is mapped to at both the device-level and port-level, and lets you configure mappings, if desired.

**NOTE: TCI Overwrite Requirement**

Tagged Packet VLAN to Role Mapping will apply the Role definition to incoming packets using a mapped VLAN. This definition will apply a CoS and determine if the packet is discarded or permitted, and if TCI Overwrite is enabled will re-specify the VLAN ID defined by the Rule / Role Default. If TCI Overwrite is disabled, the packet will egress (if permitted by the Rule Hit) with the original VLAN ID it ingress with.

If supported by the device, you can enable TCI Overwrite for an individual role in the role's [General tab](#). The stackable devices support rewriting the CoS values but not the VLAN ID.

---

**Device Level Mapping**

The role the VLAN is mapped to at the device level (all devices). To select a role, click **Select**, choose a role, and click **OK**.

**Select**

Opens the role [Selection View](#), where you can choose a role to associate with the VLAN at the device level.

**Primary C2/B2/D2/C3/B3/G3/C5/B5/A4 mapping**

Use this checkbox to specify that this VLAN to role mapping will be the primary mapping for C2/C3/C5 and B2/B3/B5 devices (C2 firmware version 03.02.xx and higher/B2 firmware version 02.00.16 and higher), and D2, A4, and G3 devices (G3 firmware version 6.03.xx and higher). These devices only support one device-level VLAN to role mapping. If you do not make this selection, there will be no device-level mapping for these devices.

**Port Level Mappings**

This table lists any port-level Tagged Packet VLAN to Role Mappings configured for this VLAN. Port-level mappings override any device-level mapping.

---

**NOTE:** This functionality is not yet enabled.

---

**Related Information**

For information on related concepts:

- [Dynamic Egress](#)
- [Policy VLAN Islands](#)

For information on related tasks:













- [How to Create a VLAN](#)
- [How to Create a Policy VLAN Island](#)

## Global VLANs

This tab appears when you select the **Global VLANs** tab in the **VLANs** left-panel tab. It displays a table of information about the existing VLANs.

Right-clicking the **Global VLANs** tab allows you to create a new VLAN by selecting the **Create VLAN** option, while selecting **Reload VLANs** updates the list of VLANs with the latest information.

If you right-click a VLAN in the left-panel tab or in the right-panel table, you have the option to rename and delete the selected VLAN.

Global VLANs			
Name	VID	Dynamic Egress	Always Write to Device(s)
 DEFAULT VLAN	1	Enabled	Enabled
 VOIP	2		Disabled
 Edge	3		Disabled
 STCOP	4		Disabled
 IMPDEV VLAN- 5	5		Disabled
 IT Staff Vlan	6		Disabled
 7	7		Disabled
 abc	8		Disabled
 Management Vlan	9		Disabled
 10.20.89.0/32 - 10.20.89.2	10		Disabled

### Name

Name of the VLAN.

### VID

Unique number assigned to the VLAN, also called VID (for VLAN ID). For [Global VLANs](#), this ID was either assigned by an administrator or assigned automatically by the system when the VLAN is created. The value can be anywhere between 1 and 4094, with VID 1 being reserved for the DEFAULT VLAN (a name for a particular VLAN, not to be confused with a role's assigned default VLAN).

### Dynamic Egress

Indicates whether the Dynamic Egress feature is on (**Enabled**) or off (**Disabled**) for the VLAN. The default is **Enabled**; therefore, this column displays **Enabled** unless a user has turned it off for a particular VLAN.

### Always Write to Device(s)

If enabled, the VLAN is written to the device whether or not it is being used in a rule or role.

---

## Related Information

For information on related tasks:

- [How to Create a VLAN](#)

For information on related windows:

- [VLAN Tab](#)
- [VLAN Egress Tab \(Role\)](#)

## Create VLAN

This window appears when you right-click the **Global VLANs** left-panel tab and select **Create VLAN**. See [How to Create a VLAN](#), [How to Create a Policy VLAN Island](#), and [Roles](#) for additional information.

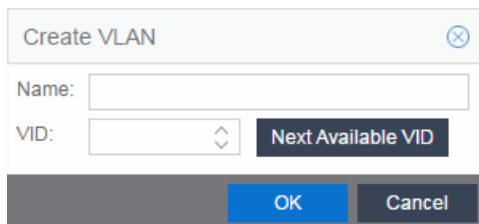

The screenshot shows a dialog box titled "Create VLAN". It has a close button in the top right corner. Below the title bar, there is a "Name:" label followed by a text input field. Below that is a "VID:" label followed by a dropdown menu and a "Next Available VID" button. At the bottom of the dialog, there are two buttons: "OK" and "Cancel".

### Name

The name for the VLAN you want to create. VLAN names can be up to 32 characters in length, including spaces. Do not create a VLAN name that uses any letters with diacritical marks. Diacritical marked letters are not supported by SNMP. VLAN names are case sensitive. For example, "Sales" and "sales" would be considered two different VLAN names. You can have multiple VLANs with the same name but with different VLAN IDs in the Policy tab.

**VID**

Unique numerical identifier for the VLAN, also known as VLAN ID. Can be a value between 1 and 4094, with VID1 being reserved for the DEFAULT VLAN (a name for a particular VLAN, not to be confused with a default VLAN you assign to a role). To select the next VID in sequence, click **Next Available VID**.

**Next Available VID Button**

Enters the next unassigned VID in the **VLAN ID** field.

## Editing an existing VLAN/Class of Service

**OK Button**

Creates the VLAN.

---

**Related Information**

For information on related concepts:

- [Dynamic Egress](#)
- [Policy VLAN Islands](#)

For information on related tasks:

- [How to Create a VLAN](#)
- [How to Create a Policy VLAN Island](#)

For information on related windows:

- [General Tab \(Role\)](#)

## Selection View (Roles)

---

The Roles Selection View appears when you are selecting a role for VLAN to role mapping. It also lets you clear the current VLAN to role mapping. To access this view, click the desired VLAN in the VLANs > Global VLANs left-panel tab, then click the **Select** button in the VLAN to Role Mapping section on the [VLAN tab](#).

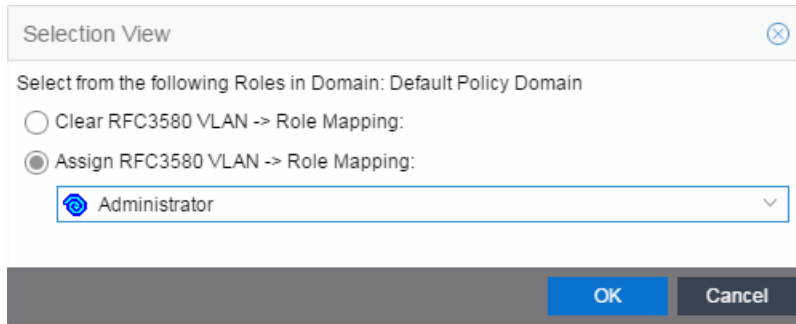

Selection View

Select from the following Roles in Domain: Default Policy Domain

Clear RFC3580 VLAN -> Role Mapping:

Assign RFC3580 VLAN -> Role Mapping:

Administrator

OK Cancel

### Clear RFC3580 VLAN -> Role Mapping

Select this option to clear the current role selection.

### Assign RFC3580 -> Role Mapping

Select this option to assign a new role and make a selection from the list of available roles.

---

## Related Information

For information on related tasks:

- [Creating a Role](#)

For information on related windows:

- [General Tab \(VLAN\)](#)

## Policy VLAN Islands

---

This tab displays a table of the Island VLANs being used in the [Policy VLAN Island](#), and the names created on the devices in the island. To display this tab, select **Control > Policy > VLANs > Policy VLANs Islands**.

The **VLANs Tab** provides two sub-tabs:

- [\(VLAN\) - VIDs Tab](#)
- [\(VLAN\) - Role Mappings Tab](#)

## (VLANs) - VIDs Tab

This tab provides information on VIDs assigned to specific islands. When an island is selected, the VIDs tab shows all VIDs for the defined PVI VLANs used for that island.

The screenshot shows the 'Policy VLAN Islands' interface. At the top, there are two tabs: 'VLANs' (selected) and 'Island Topology'. Below the tabs is a descriptive paragraph: 'Policy VLAN Islands (PVI) allow Roles and Rules using VLAN containment Access Control to vary the VID across the network based on the Island where a user connects to the network. This can allow the network to isolate resources, for instance putting traffic from visitors in a "Guest" PVI VLAN that uses a different VID for each campus of a company. Below, select a PVI VLAN to see the specific VIDs used for that VLAN in each island as well as the Role mappings assigned to that VLAN.'

The interface is divided into two main sections:

- VLANs:** A list of defined VLANs. It includes a '+ Create' button and two entries: 'North Campus' and 'South Campus', each with a small icon.
- VLAN Settings:** A section for configuring a selected VLAN. It has two sub-tabs: 'North Campus - VIDs' (selected) and 'North Campus - Role Mappings'. Below these is an 'Edit Island VID' button and a table with two columns: 'Island Name' and 'Island VLAN ID'. The table contains one row: 'Default Island' with the value 'None'.

### VLANS

Name of all defined VLANs. Select a VLAN to see the policy VLAN islands in the VLAN Settings section of the window and the VIDs with which that island is associated.

### Create

Opens the Create VLAN window from which you can create a PVI VLAN. Unlike global VLANs, PVI VLANs are not created by the Policy tab during enforce. It is left to the user to configure these on the device(s) externally. The Policy tab only associates the appropriate VIDs to the rules during enforce.

### Island Name

Shows the names of all VLAN Islands for the PVI VLAN selected in the VLANs section of the window.

### Island VLAN ID

Shows the VID used for this PVI VLAN in this Island.

## Edit Island VLAN ID

Selecting an island in the table and clicking this button opens the Edit Island VLAN ID window, where you can change the VID for the Island VLAN.

## (VLANs) - Role Mappings Tab

This tab displays the role mappings for the [Policy VLAN Island](#).

The screenshot shows the 'Policy VLAN Islands' configuration page. The 'VLANs' tab is selected, and the 'North Campus' island is chosen. The 'VLAN Settings' section is active, showing the 'North Campus - Role Mappings' configuration for the 'PVI VLAN: [North Campus]'. The 'Name' field is set to 'North Campus' and the 'VID' field is set to 'N/A'. There are two checkboxes: 'Dynamic Egress' and 'Always write VLAN to device(s)', both of which are unchecked. Below this, there are sections for 'Authentication Based VLAN (RFC3580) to Role Mapping' and 'Tagged Packet VLAN to Role Mapping'. The 'Mapped to Role' is set to 'None' with a 'Select...' button. The 'Device Level Mapping' is also set to 'None' with a 'Select...' button. A checkbox for 'Primary C5/B5/A4/C3/B3/G3/C2/B2/D2 mapping' is unchecked. At the bottom, there is a 'Port Level Mappings' table with columns for 'Port' and 'Role'.

## General

This area provides general information about the VLAN and allows you to configure the VLAN.

### Name

Name of the VLAN selected in the left panel.

### VID

Unique number assigned to the VLAN, also called VID (for VLAN ID). This ID was either assigned by an administrator or assigned automatically by the system when

the VLAN was created. The value can be anywhere between 1 and 4094, with VID 1 being reserved for the DEFAULT VLAN (a name for a particular VLAN, not to be confused with a role's assigned default VLAN).

### **Dynamic Egress**

Dynamically add all ports which use this VLAN to this VLAN's egress list. Dynamic Egress is enabled by default in Policy Manager. Leave disabled for discard VLANs. See [Dynamic Egress](#) for more information.

### **Always write VLAN to device(s)**

If the box is checked, the VLAN is written to the device whether the VLAN is being used in a rule or role, or not. If it is not checked, the VLAN is not written to the device unless it is being used in a rule or role. Enabling this option is a way of ensuring that the device is aware of a VLAN that is being used for something other than policy configuration, and it allows you to configure that VLAN for Dynamic Egress. If the Default VLAN (VID=1) is selected in the left panel, this option is checked and cannot be edited, as the default VLAN is always on the device.

## [Authentication-Based VLAN to Role Mapping](#)

Authentication-Based VLAN to Role Mapping provides a way to assign a role to a user during the authentication process, based on a VLAN Attribute. (For more information, see [VLAN to Role Mapping](#) in the Concepts help topic.) This area displays what role (if any) the VLAN is mapped to (at the device-level) and lets you configure a mapping, if desired.

### **Mapped to Role**

The role to which the VLAN is mapped. To select a role, click **Select**, click the **Assign RFC3580 VLAN -> Role Mapping** radio button, choose a role in the drop-down menu, and click **OK**.

### **Select**

Opens the role [Selection View](#), where you can choose a role to associate with the VLAN.

## [Tagged Packet VLAN to Role Mapping](#)

Tagged Packet VLAN to Role Mapping provides a way to let policy-enabled devices assign a role to network traffic, based on a VLAN ID. (For more information, see [VLAN to Role Mapping](#) in the Concepts help topic.) This area displays what role (if any) the VLAN is mapped to at both the device-level and port-level, and lets you configure mappings, if desired.

**NOTE: TCI Overwrite Requirement**

Tagged Packet VLAN to Role Mapping will apply the Role definition to incoming packets using a mapped VLAN. This definition will apply a CoS and determine if the packet is discarded or permitted, and if TCI Overwrite is enabled will re-specify the VLAN ID defined by the Rule / Role Default. If TCI Overwrite is disabled, the packet will egress (if permitted by the Rule Hit) with the original VLAN ID it ingress with.

If supported by the device, you can enable TCI Overwrite for an individual role in the role's [General tab](#). The stackable devices support rewriting the CoS values but not the VLAN ID.

---

**Device Level Mapping**

The role the VLAN is mapped to at the device level (all devices). To select a role, click **Select**, choose a role, and click **OK**.

**Select**

Opens the role [Selection View](#), where you can choose a role to associate with the VLAN at the device level.

**Primary C2/B2/D2/C3/B3/G3/C5/B5/A4 mapping**

Use this checkbox to specify that this VLAN to role mapping will be the primary mapping for C2/C3/C5 and B2/B3/B5 devices (C2 firmware version 03.02.xx and higher/B2 firmware version 02.00.16 and higher), and D2, A4, and G3 devices (G3 firmware version 6.03.xx and higher). These devices only support one device-level VLAN to role mapping. If you do not make this selection, there will be no device-level mapping for these devices.

**Port Level Mappings**

This table lists any port-level Tagged Packet VLAN to Role Mappings configured for this VLAN. Port-level mappings override any device-level mapping.

**NOTE:** This functionality is not yet enabled.

---

**Related Information**

For information on related concepts:

- [Policy VLAN Islands](#)
- [VLAN to Role mapping](#)

For information on related tasks:

- [How to Create a Policy VLAN Island](#)



## Add Devices (VLAN Islands)

This window enables you to add devices to VLAN islands.

To access the window:

1. Click the **VLANs > Policy VLAN Islands** tab in the left panel.
2. Select the **Island Topology** tab in the Policy VLAN Islands right panel.
3. Select the Default Island - Devices tab in the Island Settings section of the window.
4. Click the **Add Devices** button.

Devices contained in an island are assigned a VID for each Island VLAN unique to the island, allowing roles and rules which use the Island VLANs to isolate users to that island. A device must always belong to an island, and shares a common VID assignment for the Island VLANs with all other devices contained in that island.

To add a device to an island, select the Island to which the device is to be added in the **Destination** drop-down menu, select the device in the Devices section, and click **Add**. You can also select and add multiple devices.

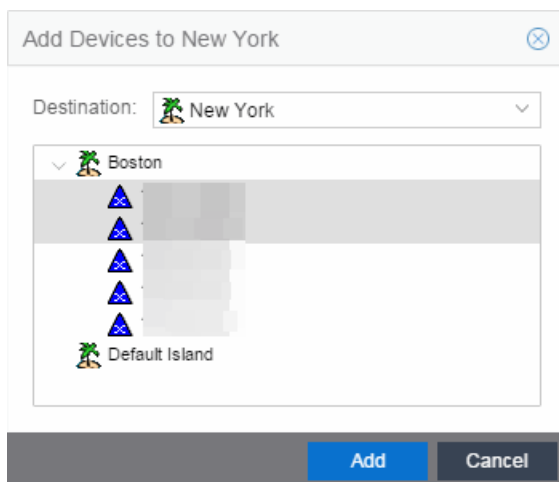

### Destination

Select the VLAN Island to which the device is to be added.

### Devices Section

Expand the Island folder from which the VLAN Island is being selected to add the device or devices.

### **Add Button**

Adds the device(s) selected in the Devices panel to the island selected in the Islands panel.

---

### **Related Information**

For information on related concepts:

- [Policy VLAN Islands](#)

For information on related tasks:

- [How to Create a Policy VLAN Island](#)

## **Extreme Management Center Island Topology (Policy VLAN Islands)**

---

This tab displays a table of information about the [Policy VLAN Islands](#), which shows the VIDs used in the selected island for all defined PVI VLANs. To access this tab, select the Policy VLAN Islands node in the tree of the Access Control Configuration view, and select the Island Topology tab on the right panel.

The **Island Topology** tab provides two sub-tabs:

- [\(Island\) - VIDs Tab](#)
- [\(Island\) - Devices Tab](#)

### **(Island) - VIDs Tab**

This tab provides information on VIDs assigned to specific islands. When an island is selected, the VIDs tab shows all VIDs for the defined PVI VLANs that will be used for that island.

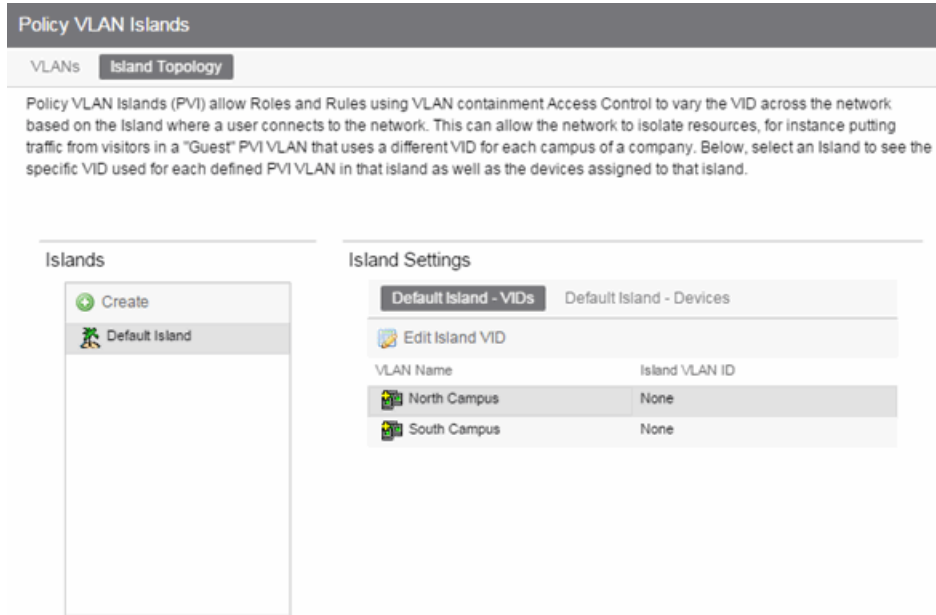

## Islands

Name of all defined PVI islands. Select an island to see the VLANs and devices associated with that Island. The Island VLAN ID is the VLAN ID in which the Island VLAN is being used.

## VLAN Name

Shows the defined PVI VLANs in the Domain. Unlike global VLANs, PVI VLANs are not created by the Policy tab during enforce. It is left to the user to configure these on the device(s) externally. The Policy tab only associates the appropriate VLANs to the rules during enforce.

## Island VLAN ID

Shows the VLAN ID used for this PVI VLAN in this Island.

## Edit Island VLAN ID

Selecting an island in the table and clicking this button opens the Edit Island VLAN ID window, where you can change the VLAN ID for the Island VLAN.

## Create

Opens the Create VLAN Island dialog. For more information, see [Creating a VLAN Island](#).

## (Island) - Devices Tab

This tab displays the devices that are part of a [Policy VLAN Island](#). To see a menu of options for a device in the table, right-click the device.

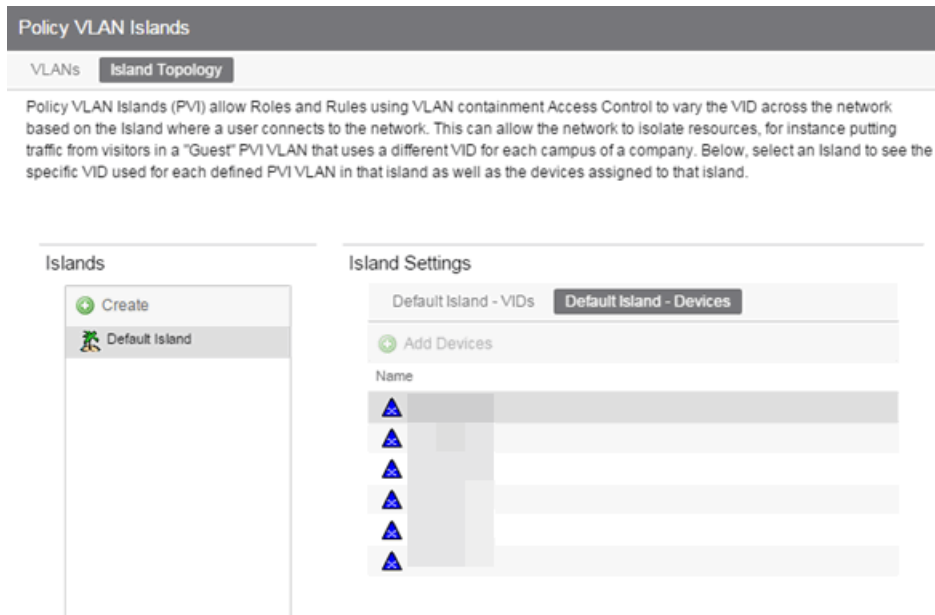

### Create

Opens the Create VLAN Island dialog. For more information, see [Creating a VLAN Island](#).

### Name

The device's IP address.

### Add Devices

Opens a separate dialog to add devices to specific Islands. For more information, see [Add/Remove Devices window](#).

## Related Information

For information on related concepts:

- [Policy VLAN Islands](#)
- [Network Resource Groups](#)

For information on related tasks:

- [How to Create a Policy VLAN Island](#)
- [How to Create a Network Resource Group](#)

## Extreme Management Center Packet Flow Diagram

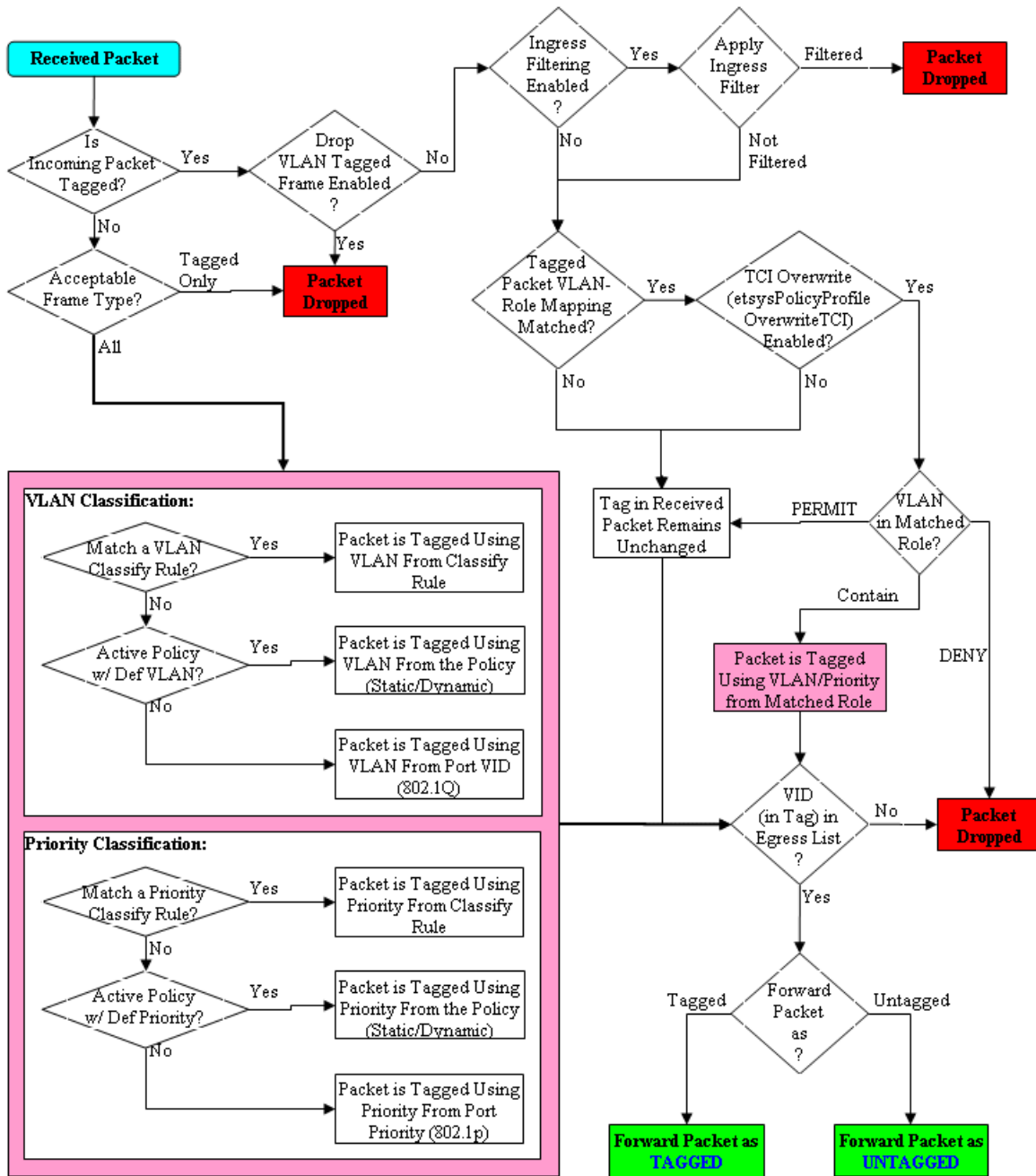

## Extreme Management Center Network Resources Tab Overview

The **Network Resources** tab displays a table of information about all the network resources in the current domain. To access this tab, select the **Network Resources > Network Resources** left-panel tab on the **Policy** tab. The Details View is displayed in the right panel. Right-click a network resource to rename or delete it. See [How to Create a Network Resource](#) for more information on topologies and islands.

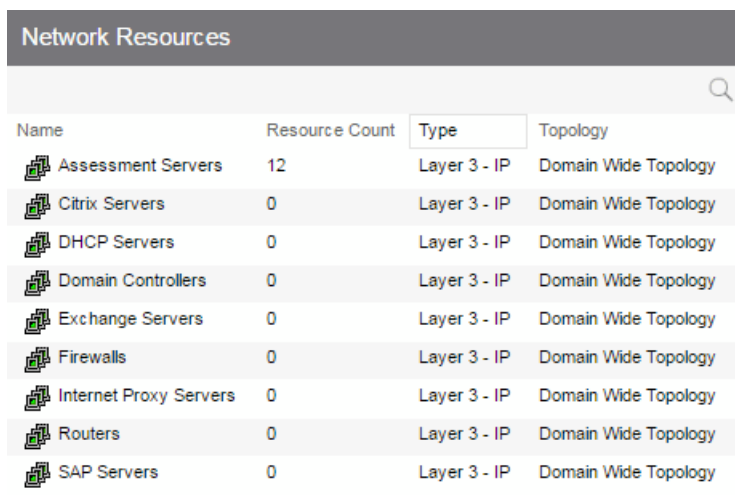

Name	Resource Count	Type	Topology
Assessment Servers	12	Layer 3 - IP	Domain Wide Topology
Citrix Servers	0	Layer 3 - IP	Domain Wide Topology
DHCP Servers	0	Layer 3 - IP	Domain Wide Topology
Domain Controllers	0	Layer 3 - IP	Domain Wide Topology
Exchange Servers	0	Layer 3 - IP	Domain Wide Topology
Firewalls	0	Layer 3 - IP	Domain Wide Topology
Internet Proxy Servers	0	Layer 3 - IP	Domain Wide Topology
Routers	0	Layer 3 - IP	Domain Wide Topology
SAP Servers	0	Layer 3 - IP	Domain Wide Topology

### Name

Name of the network resource group.

### Resource Count

The number of addresses added to the network resource.

### Type

The network resource type:

- Layer 2 MAC - Define a group of network resource MAC addresses.
- Layer 3 IP - Define a group of network resource IP addresses.

### Topology

The [network resource topology](#) for this group.

## Related Information

For information on related windows:

- [General Tab \(Network Resources\)](#)
- [How to Create a Network Resource](#)

# Extreme Management Center Network Resource Group General Tab

---

This tab lets you configure a network resource group, which is a group of network resource devices associated with an [Automated service](#). You configure the group by selecting a network resource type (MAC or IP) and [typology](#), and then creating a list of MAC or IP addresses for the resources that are part of the group. Once a network resource group is defined, you can associate it with the desired Automated service (see [How to Create a Service](#) for more information).

To access this tab, select a network resource group in the **Network Resources** left-panel tab of the **Policy** tab.

**Network Resource: SAP Servers (Layer 3)**

**General**

Name:

Description:  **Edit...**

Type:  ▾

Topology:  ▾

---

**Network Resource Address List**

**Administration Office** Default Island Library **Remove**

---

IPv4/IPv6 Address (Mask Optional "n"):  **Add**

**Name**

Name of the network resource group selected in the left panel.

**Description**

Use the **Edit** button to open a window where you can add or modify a description for the network resource group.

**Type**

Select the network resource type:

- Layer 2 MAC - Define a group of network resource MAC addresses.
- Layer 3 IP - Define a group of network resource IP addresses.

**Topology**

Use this drop-down menu to select a [network resource topology](#) for this group. Use the configuration menu button on the right to add a new topology or edit an existing topology.

**Network Resource Address List**

Lists the addresses included in the selected network resource. Use the address field (IPv4 or IPv6, depending on the selected type) and click the **Add** button to add a new resource to the list.

---

**Related Information**

For information on related tasks:



- [How to Create a Network Resource Group](#)
- [How to Create a Service](#)

## Extreme Management Center Network Resource Topology Tab

---

This tab appears when you select a [Network Resource Topology](#) in the left panel of the **Network Resources** tab. It displays a list of the islands defined for the topology and the number of devices assigned to each island. See [How to Create a Network Resource](#) for more information on topologies and islands.



New Network Resource Topology	
Name	Device Count
 Administration Office	0
 Default Island (Default)	0
 Library	0

### Name

Name of the topology island.

### Device Count

The number of devices included in that island.

---

### Related Information

For information on related windows:

- [General Tab \(Network Resource Group\)](#)
- [How to Create a Network Resource](#)

## Extreme Management Center Network Resource Topology Island Domain Wide

---

The **Domain Wide** tab displays a table of information about all the devices in an island within the network resource topology selected in the left panel. To access this tab, select a network resource island in a network resource topology on the **Network Resources > Network Resource Topologies** left-panel tab on the **Policy** tab. The Domain Wide view is displayed in the right panel. To see a menu of options available for a device, right-click the device.

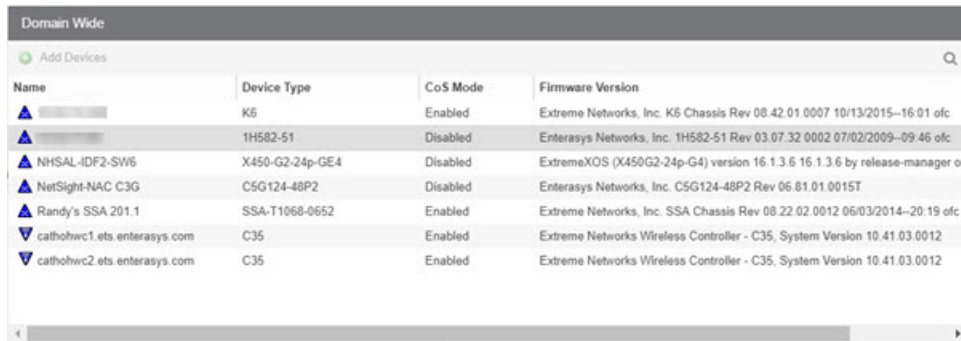

Name	Device Type	CoS Mode	Firmware Version
▲ [Redacted]	K6	Enabled	Extreme Networks, Inc. K6 Chassis Rev 08.42.01.0007 10/13/2015--16.01 ofc
▲ [Redacted]	1H582-51	Disabled	Enterasys Networks, Inc. 1H582-51 Rev 03.07.32.0002 07/02/2009--09.46 ofc
▲ NHSAL-IDF2-SW6	X450-G2-24p-GE4	Disabled	ExtremeXOS (X450G2-24p-G4) version 16.1.3.6 16.1.3.6 by release-manager on
▲ NetSight-NAC C3G	C5G124-48P2	Disabled	Enterasys Networks, Inc. C5G124-48P2 Rev 06.81.01.0015T
▲ Randy's SSA 201.1	SSA-T1068-0652	Enabled	Extreme Networks, Inc. SSA Chassis Rev 08.22.02.0012 06/03/2014--20.19 ofc
▼ cathohwc1.ets.enterasys.com	C35	Enabled	Extreme Networks Wireless Controller - C35, System Version 10.41.03.0012
▼ cathohwc2.ets.enterasys.com	C35	Enabled	Extreme Networks Wireless Controller - C35, System Version 10.41.03.0012

## Name

Name of the device, or its IP address if it does not have a display name.

## Device Type

Indicates the type of device. Certain devices may be listed as "Authentication Only" (supports 802.1X and RFC 3580 only; does not support Policy).

## CoS Mode

Shows whether the Class of Service mode has been enabled or disabled on the device.

## Firmware Version

Shows the current firmware revision for this device.

## Add Devices Button

Click the **Add Devices** button to add devices to the network resource topology.

## Extreme Management Center Details View (Network Resource Topologies Folder)

---

This tab appears when you select Network Resources > Network Resource Topologies in the left panel of the **Policy** tab. It displays a table of information about the [network resource topologies](#) configured in the current domain. See [How to Create a Network Resource](#) for more information on topologies.

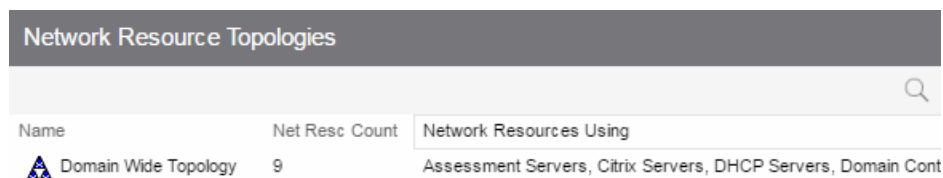

The screenshot shows a table titled "Network Resource Topologies" with a search icon in the top right corner. The table has three columns: "Name", "Net Resc Count", and "Network Resources Using". There is one row of data with a small triangle icon next to the name "Domain Wide Topology".

Name	Net Resc Count	Network Resources Using
 Domain Wide Topology	9	Assessment Servers, Citrix Servers, DHCP Servers, Domain Cont

### Name

Name of the network resource topology.

### Net Resc Count

The number of network resource groups using this topology.

### Network Resources Using

The names of the network resource groups using this topology.

---

### Related Information

For information on related windows:

- [General Tab \(Network Resource Group\)](#)
- [How to Create a Network Resource](#)

## Extreme Management Center Devices (Devices)

The **Devices** tab displays a table of information about all the devices in the current domain. To access this tab, select the **Devices/Port Groups > Devices** left-panel tab on the **Policy** tab. The Details View is displayed in the right panel. To see a menu of options available for a device, right-click the device.

The screenshot shows the 'Devices' tab selected in a navigation bar. Below the navigation bar is a search icon and a table with the following columns: Name, Device Type, CoS Mode, and Firmware Version. The table contains seven rows of device information.

Name	Device Type	CoS Mode	Firmware Version
▲ [Redacted]	K6	Enabled	Extreme Networks, Inc. K6 Chassis Rev 08.42.01
▲ NHSAL-IDF2-SW6	X450-G2	Enabled	ExtremeXOS (X450G2-24p-G4) version 16.1.3.6
▲ NetSight-NAC C3G	C5	Enabled	Enterasys Networks, Inc. C5G124-48P2 Rev 06.8
▲ NetSight-NAC Extr X460-24t	Summit Stack	Disabled	ExtremeXOS (Stack) version 15.3.5.2 v1535b2 by
▲ Randy's SSA 201.1	SSA	Enabled	Extreme Networks, Inc. SSA Chassis Rev 08.22.1
▼ cathohwc1.ets.enterasys.com	Wireless Co...	Enabled	Extreme Networks Wireless Controller - C35, Sys
▼ cathohwc2.ets.enterasys.com	Wireless Co...	Enabled	Extreme Networks Wireless Controller - C35, Sys

### Name

Name of the device, or its IP address if it does not have a display name.

### Device Type

Indicates the type of device. Certain devices may be listed as "Authentication Only" (supports 802.1X and RFC 3580 only; does not support Policy).

### CoS Mode

Indicates whether Class of Service is enabled or disabled on the device.

### Firmware Version

Shows the current firmware revision for this device.

## Related Information

For information on related windows:

- [Details View Tabs](#)

## Extreme Management Center User Sessions (Devices)

The device **User Sessions** panel displays information related to end user login sessions for a device.

This tab can be accessed in a variety of ways:

1. Select a device in the left-panel **Devices** tab, then click the **User Sessions** tab in the right panel.
2. Select the My Network navigation tree in the left panel, select a device in the Devices list, and right-click the device or open the tools menu and select **View > User Sessions**.
3. Open the **Control > Policy** tab, select **Devices** in the left panel, and select the **User Sessions** tab in the right panel.

### User Sessions Tab

This tab displays information about each login session for the ports on the device, including the current values being collected for a session still in progress, or the final values for the last valid session when there is no session currently active.

Checking the **Show Only Active Sessions** checkbox displays only your active sessions. Deselect the checkbox to display all entries. Active sessions applied to traffic are listed in blue text. Active sessions not being applied are listed in green text.

Some devices support multiple authentication sessions simultaneously per interface. This allows a single user to authenticate via 802.1X, Web-Based, MAC, and CEP all at the same time. However, only one authentication type per interface can be *applied* at a single time. The multi-user authentication type precedence (configured on the device Authentication tab) determines which type is applied. The applied session is the one that provides the role and traffic classification information. The remaining non-applied sessions will only be used if the currently applied session is terminated. For example, if a user authenticates on a port that has multi-user authentication enabled (802.1X, Web-Based, and MAC) the active/applied session will be displayed in blue text and the other two

sessions will be in green text. Another example would be if the user authenticates using the MAC authentication type but MAC authentication is disabled on the port, the session would be listed in green text. For devices that do not support multi-authentication, by definition the active session is also applied.

---

**NOTE:** Devices configured for multi-user authentication always list *only* active sessions even if the **Show Only Active Session** checkbox is deselected.

---

Session entries are collected up to the maximum allowed. When the maximum is reached, the oldest session entries are replaced with newer ones. The exception to this is the RoamAbout R2, where older session data is not kept.

For devices that support one authenticated user per port, only one user/current role per port appears in the table. For devices that support multiple authenticated users per port, all users authenticated on its ports are listed in the table, along with the roles under which they are authenticated.

### **Session Status**

The status of the device.

### **Switch IP**

The IP address or name of the device.

### **Switch Port**

A description of the port.

### **Switch Alias**

The alias (ifAlias) for the interface, if one is assigned.

### **Type**

The authentication type of this login session: Web-Based, 802.1X, MAC, CEP, Quarantine, Auto Tracking, or Role Override. If Role Override is displayed, it signifies that a rule has been applied to the port, overriding the user's current role with a different role.

- **Role Override (MAC)** signifies that a MAC address rule has been applied to the port, overriding the Default role or any authenticated role assigned to the end user.
- **Role Override (IP)** signifies that an IP address rule has been applied to the port, overriding the Default role or any authenticated role assigned to an end user

authenticated with Single User 802.1X. An IP Address rule will **not** override the authenticated role for any authentication type other than Single User 802.1X.

**MAC Address**

The MAC address of the remote user of this login session.

**IP Address**

For web-based authentication sessions, this column displays the IP address of the remote user of this login session.

**Hostname**

The hostname of the remote user of this login session. To determine the hostname, the **Policy** tab takes the IP address (when available) and uses the hostname cache on the Extreme Management Center server. The hostname cache must be explicitly enabled by selecting the **Enable Name Resolution** checkbox in the Administration > Options > tab (by default, this option is disabled).

**Role**

The role under which the user authenticated on the port. If the user authenticated via RFC 3580 VLAN Authorization, this column displays the role the VLAN is mapped to (configured through Authentication-based VLAN to Role Mapping). If VLAN to Role mapping has not been configured, the port's Default role is displayed (if there is one); otherwise, the column displays "N/A."

**Default VID Source**

When traffic received on a port doesn't match any rules, it is assigned the default VLAN ID. This column indicates the source for the default VLAN ID:

- Policy Default Access Control - The role assigned to the session defines the default VLAN ID via its Default Access Control.
- PVID - If the role assigned to the session has no Default Access Control specified, then the 802.1Q PVID for the port is assigned to the traffic.

**Default VID**

Displays the VLAN ID that comes from the source listed in the Default VLAN ID Source column: Permit (4095), Deny (VLAN ID #), or Contain (VLAN ID #).

**RFC3580 VID**

If the user authenticated via RFC 3580 VLAN Authorization, this is the VLAN ID that was returned from the RADIUS server. A VLAN ID value of 0 indicates that no VLAN was assigned. If VLAN authentication is not supported on the device, this column will display "N/A."

### **VLAN Oper Egress**

The modification that will be made to the VLAN egress list for the VLAN ID returned by the RADIUS server, if the user authenticated via RFC 3580 VLAN Authorization.

- None - No modification to the VLAN egress list will be made.
- Tagged - The port will be added to the list with the egress state set to Tagged (frames will be forwarded as tagged).
- Untagged - The port will be added to the list with the egress state set to Untagged (frames will be forwarded as untagged).
- Dynamic - The port will use information returned in the RADIUS response to modify the VLAN egress list.

If VLAN authentication is not supported on the device, this column will display "N/A."

### **Start Time**

The time and date when the login session started.

### **Duration**

The duration of the user's login session, in the format D + HH:MM:SS.

### **Auth Status**

The authentication status of the login session. Possible values are:

- Authentication Successful
- Authentication Failed
- Authentication in Progress
- Authentication Server Timeout
- Authentication Terminated

### **Terminate Cause**

The reason the login session terminated. For web-based authentication, the possible values are:

- Administratively Terminated
- Authorization Revoked
- Link Down
- Not Applicable
- Port Disabled



- Unknown Termination Cause
- User Logged Out

For 802.1X authentication, the possible values are:

- Authorization Revoked
- Client Restarted
- Link Down (or Lost Carrier)
- Not Applicable
- Port Disabled
- Port Reinitialized
- Reauthentication Failed
- Unknown Termination Cause
- User Logged Out

### **Authentication Server**

The RADIUS server that authenticated the session.

---

### **Related Information**

For information on related concepts:

- [MAC Locking](#)
- [Getting Started with Class of Service](#)

For information on related tasks:

- [Defining Rate Limits](#)

For information on related windows:

- [General Tab \(Rate Limit\)](#)

# Extreme Management Center Authentication (Device)

The device **Authentication** tab enables you to configure and change the [authentication](#) settings on the selected device. Authentication must be configured and enabled on the device in order for individual port authentication settings to take effect (see [How to Configure Ports](#)).

To access this tab, select a device in the left panel under Devices > Devices, then click the **Authentication** tab in the right panel.

The screenshot shows the 'Authentication' tab in the Extreme Management Center interface. At the top, there are tabs for 'Ports', 'User Sessions', 'Authentication', and 'RADIUS'. Below these, there are sub-tabs for 'Device' and 'Ports'. The 'Authentication' sub-tab is active, showing a configuration form. The form includes an 'Apply' button and a 'Refresh' button. The main configuration area is titled 'Authentication Status' and contains several settings: 'Multi-Auth Mode' (Multi-Auth), 'MAC' (Enabled), '802.1X' (Disabled), 'Web-Based' (Disabled), 'CEP' (Disabled), 'Quarantine' (Disabled), and 'Auto Tracking' (Disabled). To the right, there are settings for 'Auth Type Precedence (High→Low)' (AT/QX/WB/MAC/CEP), 'Re-Auth Timeout Action' (Terminate), and 'RFC3580 VLAN Authorization' (Enabled). Below the main configuration area, there are expandable sections for 'Current User Counts', 'Global Authentication Settings', 'MAC Authentication Settings', 'Web Authentication Settings', and 'Convergence End-Point Settings'.

## Apply

Click this button to save any changes you made to the **Authentication** tab.

## Refresh

Click this button to update the tab with your changes.

## Authentication Status

Use this section to select the authentication mode and types used on the device.

**Authentication Status** ⊖

Multi-Auth Mode:	<input type="text" value="Multi-Auth"/>	Auth Type Precedence (High->Low):	<input type="text" value="AT/Q/WB/MAC/CEP"/>
MAC:	<input type="text" value="Enabled"/>	Re-Auth Timeout Action:	<input type="text" value="Terminate"/>
802.1X:	<input type="text" value="Disabled"/>	RFC3580 VLAN Authorization:	<input type="text" value="Enabled"/>
Web-Based:	<input type="text" value="Disabled"/>		
CEP:	<input type="text" value="Disabled"/>		
Quarantine:	<input type="text" value="Disabled"/>		
Auto Tracking:	<input type="text" value="Disabled"/>		

Use the fields on the left side of this section to select the appropriate single- or multi-user authentication types. Only options supported by the selected device are available for selection. Some devices support multiple authentication types and multiple users (Multi-User Authentication) per port, while others are restricted to only one or two authentication types and single users per port. Refer to the Firmware Support tables for information on the authentication types supported by each device type.

---

**WARNING:** Switching Authentication Types, or changing the Authentication Status from Enabled to Disabled, logs off any currently authenticated users.

---

### Auth Type Precedence (High->Low)

This displays the order in which the authentication types are attempted on the device, with the authentication type on the left having the highest precedence (attempted first). You can edit the precedence order by clicking the field. In the Edit Precedence window, select the authentication type you want to position, and use the **Up** and **Down** buttons to arrange the types in the desired order of precedence.

---

**WARNING:** Leave the default precedence, if possible. Changing the Quarantine precedence to be lower than any other type or changing the Auto Track precedence to be higher than any other type may cause problems.

---

### Re-Auth Timeout Action

This setting defines the action for sessions that need to be re-authenticated if the RADIUS server re-authentication request times out. Select the **Terminate** option to terminate the session or the **None** option to allow the current session to continue without disruption.

### Maximum Number of Users

This setting applies to devices with Multi-User as their configured authentication type. The maximum number of users that can be actively authenticated or have authentications in progress at one time on this device. You can specify the

maximum number of users per port on the port's [Port Properties Authentication Configuration tab](#).

### RFC3580 VLAN Authorization

This allows you to enable and disable RFC 3580 VLAN Authorization for the selected device. RFC 3580 VLAN Authorization must be enabled on devices in networks where the RADIUS server is configured to return a VLAN ID when a user authenticates.

When RFC 3580 VLAN Authorization is enabled:

- devices that do **not** support policy tag packets with the VLAN ID.
- devices that support both policy and [Authentication-Based VLAN to Role Mapping](#) classify packets according to the role to which the VLAN ID maps.

## Current User Counts

This section allows you to specify the maximum number of users on the device and per authentication type.

Current User Counts	
Maximum User Count:	<input type="text" value="1152"/>
Current Users: Total:	<input type="text" value="4"/>
MAC:	<input type="text" value="4"/>
802.1x:	<input type="text" value="0"/>
Web-Based:	<input type="text" value="0"/>
CEP:	<input type="text" value="0"/>
Quarantine:	<input type="text" value="0"/>
Auto Tracking:	<input type="text" value="0"/>

### Current Number of Users

For devices with Multi-User as their configured authentication type. The current number of users that are actively authenticated or have authentications in progress, or that the device is keeping authentication termination information for. Any unauthenticated traffic on the port is not included in this count.

**NOTE:** On E1 and E6/E7 devices, if both 802.1X and MAC authentication are enabled, it is possible for the device to receive a start or response 802.1X packet while a MAC authentication is in progress. If this happens, the device immediately terminates the MAC authentication, and the 802.1X authentication proceeds to completion. Regardless of the success of the 802.1X login attempt, no new MAC authentication logins may occur on the port until 1) the link is toggled; 2) the user executes an 802.1X logout; or 3) the 802.1X session is terminated administratively.

## Global Authentication Settings

This section lets you set session timeout and session idle timeout values for each authentication type.

Global Authentication Settings			
Session Timeout:		Session Idle Timeout:	
MAC:	0	MAC:	300
802.1X:	0	802.1X:	300
Web-Based:	0	Web Based:	300
CEP:	0	CEP:	300
Quarantine:	0	Quarantine:	0
Auto Tracking:	0	Auto Tracking:	300

### Session Timeout

This setting represents the maximum number of seconds an authenticated session may last before automatic termination of the session. A value of zero indicates that no session timeout applies. This value may be superseded by a session timeout value provided by the authenticating server. For example, if a session is authenticated by a RADIUS server, that server may send a session timeout value in its authentication response.

**NOTE:** Non-zero values are rounded to the nearest non-zero multiple of 10 by the device.

### Session Idle Timeout

This displays the maximum number of consecutive seconds an authenticated session may be idle before Extreme Management Center automatically terminates the session. A value of zero indicates that no idle timeout applies. This value may be superseded by an idle timeout value provided by the authenticating server. For example, if a session is authenticated by a RADIUS server, that server may send an idle timeout value in its authentication response.

## MAC Authentication Settings

This section enables you to set up the MAC password for [MAC authentication](#). In order for MAC authentication to work, you must also configure the RADIUS

server with the MAC password as well as the MAC addresses which are allowed to authenticate.

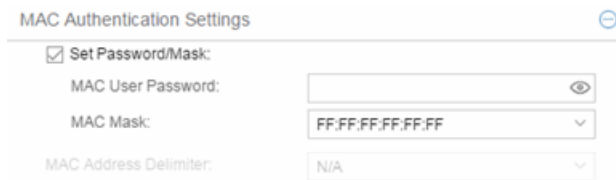

The screenshot shows the 'MAC Authentication Settings' configuration panel. It includes a checked checkbox for 'Set Password/Mask'. Below this, there are three fields: 'MAC User Password' (a text input field with a toggle icon), 'MAC Mask' (a dropdown menu showing 'FF:FF:FF:FF:FF:FF'), and 'MAC Address Delimiter' (a dropdown menu showing 'N/A').

### Set Password/Mask

Select this checkbox to set a password and mask for MAC authentication.

### MAC User Password

The password passed to the RADIUS server for MAC authentication.

### MAC Mask

You can select a mask to provide a way to authenticate end-systems based on a portion of their MAC address. For example, you could specify a mask that would base authentication on the manufacturers ID portion of the MAC address. The MAC Mask is passed to the RADIUS server for authentication after the primary attempt to authenticate using the full MAC address fails.

### MAC Address Delimiter

The character used between octets in a MAC address:

- **None** — No delimiter is used in the MAC address (e.g. xxxxxxxxxxxx).
- **Hyphen** — A hyphen is used as a delimiter in the MAC address (e.g. xx-xx-xx-xx-xx-xx).

## Web Authentication Settings

For users of web-based authentication, this tab lets you specify web authentication parameters using three sections:

- [General](#)
- [Guest Networking](#)
- [Web Login](#)

### General

The General section lets you specify the URL of the authentication web page and the IP address of the system where it resides. It also lets you enable certain

web authentication features, such as Enhanced Login Mode, on devices that support those features.

Web Authentication Settings	
General	
Enhanced Login Mode:	Disabled
Enhanced Mode Redirect Time(s):	5
WINS/DNS Spoofing:	N/A
Logo Display Status:	Show
Authentication Protocol:	PAP
Web Authentication URL: http://	
Web Authentication IP Address:	0.0.0.0
Guest Networking	
Web Page Banner	

### Enhanced Login Mode

Enabling the Enhanced Login Mode causes the authentication web page to be displayed regardless of whether the URL or IP address entered into the browser by the end user is the designated Web Authentication URL or IP address. This option is grayed out if the device does not support the mode.

### Enhanced Mode Redirect Time(s)

This setting applies for devices with [Enhanced Login Mode](#) enabled. It specifies the amount of time (in seconds) before the end-user is redirected from the authentication web page to their requested URL.

An end-system using DHCP requires time to transition from the temporary IP address issued by the authentication process to the official IP address issued by the network. **Enhanced Mode Redirect Time** specifies the amount of time allowed for the end-system to complete this process and begin using its official IP address.

For example, if an end-user (in **Enhanced Login Mode** and a **Redirect Time of 30 seconds**) enters the URL of "http://ExtremeNetworks.com", the user is presented the authentication web page. When the user successfully authenticates into the network, the user sees a login success page that displays "Welcome to the Network. Completing network connections. You will be redirected to http://ExtremeNetworks.com in approximately 30 seconds."

**WINS/DNS Spoofing**

This setting allows you to enable and disable WINS/DNS spoofing for the selected device. Spoofing allows the end-user to resolve the Web Authentication URL name to the IP address using WINS/DNS. The default is Disabled. This option is grayed out if not supported by the device.

**Logo Display Status**

Specifies whether the Extreme Networks logo is displayed or hidden on the authentication web page window. This option is grayed out if not supported by the device.

**Authentication Protocol**

This setting is the authentication protocol being used (PAP or CHAP). PAP (Password Authentication Protocol) provides an automated way for a PPP (Point-to-Point Protocol) server to request the identity of user, and confirm it via a password. CHAP (Challenge Handshake Authentication Protocol), the more secure of the two protocols, provides a similar function, except that the confirmation is accomplished using a challenge and response authentication dialog.

**Web Authentication URL**

This is the URL for your authentication web page. Users wishing to receive network services access the web page from a browser using this URL. The **http://** is supplied. Alphabetical characters, numerical characters and dashes are allowed as part of the URL, but dots are not. The URL needs to be mapped to the Web Authentication IP address in DNS or in the hosts file of each client. It must be resolvable via DNS/WINS, either on the device or at corporate, assuming the Web Authentication mapping has been set up on the corporate DNS/WINS service. This option is grayed out if not supported by the device.

**Web Authentication IP Address**

This is the IP address of your authentication web page server. If you have specified a Web Authentication URL, the IP address needs to be mapped to the URL in DNS or in the host file of each client.

## Guest Networking

The **Guest Networking** section lets you configure guest networking, a feature that allows any user to access the network and obtain a guest policy without having to know a username or password. The user accesses the authentication web page, where the username and password fields are automatically filled in, allowing them to log access as a guest. If the user does not want to log in as a guest, they can type in their valid username and password to log in.



---

**NOTE:** Guest networking is designed for networks using web-based authentication, with [port mode](#) set to Active/Discard.

---

Web Authentication Settings

General

Guest Networking

Guest Networking Status:

Guest Name:

Guest Password:

Web Page Banner

### Guest Networking Status

Use the drop-down list to specify guest networking status:

- **Disable** — Guest networking is unavailable.
- **Local Auth** — Guest Networking is enabled. The user accesses the authentication web page where the username field is automatically filled in with the specified [Guest Name](#). Once the user submits the web page using this guest name, the default policy of that port becomes the active policy. The port mode must be set to Active/Discard mode.
- **RADIUS Auth** — Guest Networking is enabled. The user accesses the authentication web page, where the username field is automatically filled in with the specified [Guest Name](#), and the password field is masked out with asterisks. Once the user submits the web page using these credentials, the value of the [Guest Password](#) is used for authentication. Following successful authentication from the RADIUS server, the port applies the policy (role) returned from the RADIUS server. The port mode must be set to Active/Discard mode.

### Guest Name

The username that Guest Networking uses to authenticate users. The guest name is displayed automatically on the authentication web page. If the user does not want to log in as a guest, they can type in their valid username to override the guest username.

### Guest Password

The password that Guest Networking uses to authenticate users when [RADIUS Auth](#) is selected.

## Web Page Banner

The Web Page Banner section allows you to customize the banner end users see at the top of the authentication web page and set a Redirect Time, if applicable.

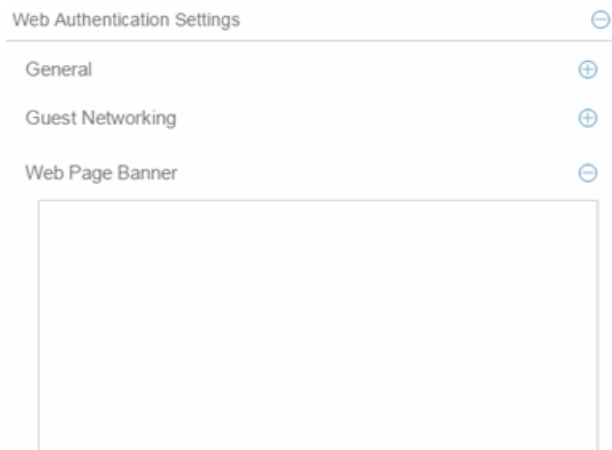

### Web Page Banner

Use this area to create a banner end users see at the top of the authentication web page. For example, you might include your company name and information on what to do if the user has questions or problems. Because this banner also appears in messages that occur during successful login and failed authentication, as well as on the "Radius Busy" screen, it is not appropriate to include "Welcome to [Your Company]" in the banner.

The **Default** button allows you to reset the banner to default text provided in a text file (pwa\_banner.txt). Initially, the default banner text is the Extreme Networks contact information. However, you can customize the text for your network by editing the pwa\_banner.txt file, located in the top level of the Policy Manager install directory. Then, when you click the Default button, the new text will be displayed in the Web Page Banner area.

## Convergence End-Point Settings

This section provides a way to identify Convergence End-Points (IP phones) connecting to the device, and apply a role to the end-point based on the type of end-point detected. The CEP Detection section lets you create detection rules for identifying the end-points, and the CEP Role Mappings section lets you map a role to each CEP product type.

In addition to configuring CEP on the device, you must also enable CEP protocols on each port using the CEP Access section in the [Port Authentication Tab](#). Once you have configured CEP on the device and each port, you can monitor CEP usage on the Port Usage Tab (Port) or Port Usage Tab (Device).

## CEP Role Mappings

This section lets you select the CEP product types supported on the device, and map a role for each type. Then, when a convergence end-point (such as an IP phone) connects to the network, the device identifies the type of end-point (using CEP detection rules) and applies the assigned role.

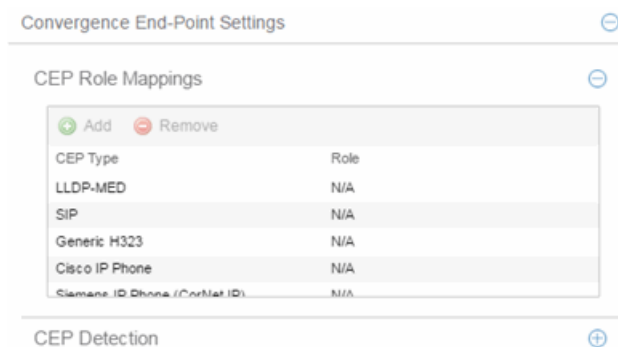

### CEP Type

Lists the CEP types supported by the device.

### Role

Lists the role mapped to each **CEP Type**.

### Add

Select a CEP Type and click the **Add** button to open the Add Role Mapping window, where you can select a role for the selected **CEP Type**. Your selections are added to the CEP Role Mappings list.

### Remove

Select the **CEP Type** and click **Remove** to remove the **CEP Type** in the CEP Role Mappings list.

## CEP Detection Tab

Use this section to create CEP detection rules used to determine if a connecting end-system is a CEP device and the type of CEP device. This allows Extreme Management Center to assign the appropriate role to the port based on the type of CEP device detected.

**NOTE:** CEP detection rules apply only to Siemens, H.323, and SIP (Session Initiation Protocol) phone detection. Cisco detection uses CiscoDP as its detection method.

CEP detection rules are based on two detection methods:

- TCP/UDP Port Number detection — Many CEP vendors use specific TCP/UDP port numbers for call setup on their IP phones. You can create detection rules that identify CEP devices based on specific TCP/UDP port numbers. By default, Siemens Hi-Path phones are detected on TCP/UDP port 4060.
- IP Address detection — H.323 phones use a reserved IP multicast address and UDP port number for call setup. You can create detection rules to detect an IP phone based on its IP address in combination with an IP address mask. By default, H.323 phones are detected using the multicast address 224.0.1.41 and the TCP/UDP ports 1718, 1719, and 1720. SIP phones are detected using the multicast address 224.0.1.75 and the TCP/UDP port 5060. H.323 and SIP phones are also detected using only their respective multicast addresses without the TCP/UDP ports.

Convergence End-Point Settings ⊖

CEP Role Mappings ⊕

CEP Detection ⊖

Priority	Address	Address Mask	End Point Type	Protocol	Port Low	Port High
1	1.2.3.4	255.255.255.255	h323	UDP + TCP	1718	1720

### Priority

The rule priority with one (1) being the highest priority. The rule with the highest priority is used first, so it is recommended the highest priority be given to the predominate protocol in the network to provide for greater efficiency.

### Address

If the rule is based on IP address detection, this field displays the IP address that incoming packets matched against. By default, H.323 uses 224.0.1.41 as its IP address, SIP uses 224.0.1.75 as its IP address, and Siemens has no IP address configured.

### Address Mask

If the rule is based on IP address detection, this field displays the IP address mask against which incoming packets are matched.

**End Point Type**

Specifies the end-point type assigned (H.323, Siemens, or SIP) if incoming packets match this rule.

**Protocol**

If the rule is based on TCP/UDP port detection, this field displays the protocol type used for matching, using a port range defined with the Port Low and Port High values:

- UDP + TCP — Match the port number for both UDP and TCP frames.
- TCP — Match the port number only for TCP frames.
- UDP — Match the port number only for UDP frames.

**Port Low**

The low end of the port range defined for detection on UDP and/or TCP ports.

**Port High**

The high end of the port range defined for detection on UDP and/or TCP ports.

**Add**

Opens the [Add/Edit CEP Detection Rule window](#) where you can create CEP detection rules.

**Remove**

To remove a CEP detection rule, select the entry and click **Remove**.

**Edit**

To edit a CEP detection rule, select the rule and click **Edit**. The [Add/Edit CEP Detection Rule window](#) opens where you edit the rule's parameters. You can also double-click an entry in the table to open the edit window.

---

**Related Information**

For information on related windows:

- [Add/Edit CEP Detection Rule Window](#)

## Extreme Management Center Add/Edit CEP Detection Rule

Use this window to add or edit CEP detection rules that are used to determine if a connecting end-system is a CEP device, and what type of CEP device it is. This allows Policy Manager to assign the appropriate role to the port based on the type of CEP device detected. Access the window from the CEP Detection sub-tab in the right-panel [Device Authentication tab](#).

**NOTE:** CEP detection rules apply only to Siemens, H.323, and SIP (Session Initiation Protocol) phone detection. Cisco detection uses CiscoDP as its detection method.

CEP detection rules are based on two detection methods:

- TCP/UDP Port Number detection — Many CEP vendors use specific TCP/UDP port numbers for call setup on their IP phones. You can create detection rules that identify CEP devices based on specific TCP/UDP port numbers. By default, Siemens Hi-Path phones are detected on TCP/UDP port 4060.
- IP Address detection — H.323 phones use a reserved IP multicast address and UDP port number for call setup. You can create detection rules detect an IP phone based on its IP address in combination with an IP address mask. By default, H.323 phones are detected using the multicast address 224.0.1.41 and the TCP/UDP ports 1718, 1719, and 1720. SIP phones are detected using the multicast address 224.0.1.75 and the TCP/UDP port 5060. H.323 and SIP phones are also detected using only their respective multicast addresses without the TCP/UDP ports.

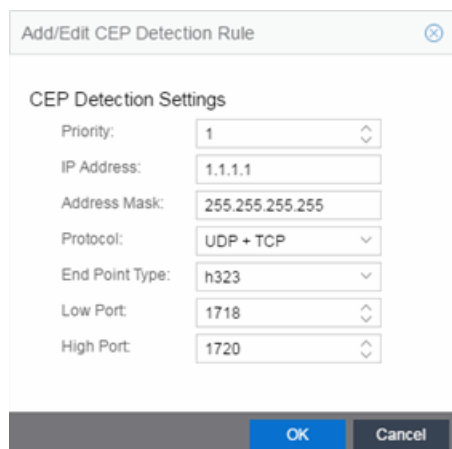

The screenshot shows a dialog box titled "Add/Edit CEP Detection Rule" with a close button in the top right corner. Below the title bar is the "CEP Detection Settings" section, which contains the following fields:

Priority:	1
IP Address:	1.1.1.1
Address Mask:	255.255.255.255
Protocol:	UDP + TCP
End Point Type:	h323
Low Port:	1718
High Port:	1720

At the bottom of the dialog box are two buttons: "OK" and "Cancel".

## CEP Detection Settings

### Priority

Enter the rule priority with one (1) being the highest priority. The rule with the highest priority is used first, so it is recommended the highest priority be given to the predominate protocol in the network to provide for greater efficiency.

### IP Address

If the rule is based on IP address detection, enter the IP address against which incoming packets are matched. By default, H.323 uses 224.0.1.41 as its IP address, SIP uses 224.0.1.75 as its IP address, and Siemens has no IP address configured.

### Address Mask

If the rule is based on IP address detection, enter the IP address mask against which incoming packets are matched.

### End Point Type

Select the endpoint type (H.323, Siemens, or SIP) assigned to incoming packets that match this rule.

### Protocol

If the rule is based on TCP/UDP port detection, select the UDP and/or TCP checkbox and define a port range with Port Low and Port High values:

- UDP and TCP — Match the port number for both UDP and TCP frames.
- TCP — Match the port number only for TCP frames.
- UDP — Match the port number only for UDP frames.

### Port Low

Define the low end of the port range for detection on UDP and/or TCP ports.

### Port High

Define the high end of the port range for detection on UDP and/or TCP ports.

---

## Related Information

For information on related windows:

- [Device Authentication Tab](#)

## Extreme Management Center Ports (Authentication)

The **Ports (Authentication)** tab allows you to configure and change the [authentication](#) settings for a port. Authentication must be configured and enabled on the device in order for individual port authentication settings to take effect. Only those areas of the tab that relate to the authentication type configured on the device are available for editing.

To access the **Ports (Authentication)** tab, select a device in the left-panel **Devices > Devices** tab, then select **Authentication > Ports** in the right panel.

The screenshot displays the configuration interface for port authentication. At the top, there are tabs for 'Ports', 'User Sessions', 'Authentication', and 'RADIUS'. Below these, there are buttons for 'Apply' and 'Refresh', and a status indicator 'Selected port: tg.1.1'. A table lists ports under different slots:

Name	Port Authentication Mode	Default Role
Slot 1 [4 ports]		
tg.1.1	Authentication Optional (Active / Default Role) [Web-Based, Quarantine, Auto Tracking Disabled]	
tg.1.2	Authentication Optional (Active / Default Role) [Web-Based, Quarantine, Auto Tracking Disabled]	
tg.1.3	Authentication Optional (Active / Default Role) [Web-Based, Quarantine, Auto Tracking Disabled]	
tg.1.4	Authentication Optional (Active / Default Role) [Web-Based, Quarantine, Auto Tracking Disabled]	
Slot 5 [24 ports]		
Slot 7 [4 ports]		

Below the table, the 'Authentication Mode' is set to 'Authentication Optional (Active / Default Role)'. There are several checkboxes for disabling various authentication features:

- Port Mode (Auth / Unauth Behavior): Authentication Optional (Active / Default Role)
- Disable 802.1X Auth:
- Disable Web Auth:
- Disable MAC Auth:
- Disable Quarantine Auth:
- Disable Auto Tracking Auth:

At the bottom, there are expandable sections for 'RFC3580 VLAN Authorization', 'Login Settings', 'Automatic Re-Authentication', 'Authenticated User Counts', and 'Convergence End-Point Access'.

Select a port in the top section to display and configure the authentication settings for that port in the bottom of the window.

Click the **Apply** button at the top of the window to save changes to this tab.



The Authentication Configuration tab has six sections:

- [Authentication Mode](#)
- [RFC3580 VLAN Authorization](#)
- [Login Settings](#)
- [Automatic Re-Authentication](#)
- [Authenticated User Counts](#)
- [Convergence End-Point Access](#)

## Authentication Mode

This tab displays general authentication and port mode information about the port.

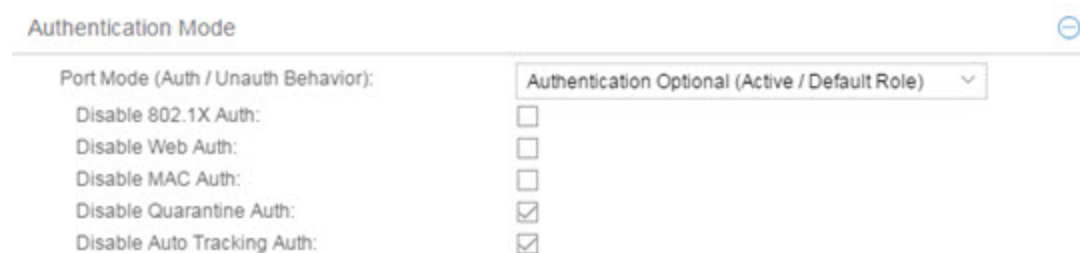

Port Mode (Auth / Unauth Behavior):	Authentication Optional (Active / Default Role) ▾
Disable 802.1X Auth:	<input type="checkbox"/>
Disable Web Auth:	<input type="checkbox"/>
Disable MAC Auth:	<input type="checkbox"/>
Disable Quarantine Auth:	<input checked="" type="checkbox"/>
Disable Auto Tracking Auth:	<input checked="" type="checkbox"/>

This area displays the current port mode for the port, and allows you to change the settings if desired. Port mode defines whether or not a user is required to authenticate on a port, and how unauthenticated traffic is handled. It is a combination of Authentication Behavior (whether or not authentication is enabled on the port), and Unauthenticated Behavior (whether unauthenticated traffic is assigned to the port's default role or discarded). See [Port Mode](#) for a complete description of each port mode.

In addition, this section provides checkboxes that allow you to disable a specific authentication type at the port level.

### Port Mode (Auth/Unauth Behavior)

Select an option to specify whether or not authentication is enabled on the port. (See [Port Mode](#) for more information.)

---

**NOTE:** Authentication Behavior must be set to **Active** for authentication to be allowed using CEP Protocols.

---

**Disable 802.1X Auth**

Select this checkbox to disable 802.1X authentication at the port level. If the device is only configured with 802.1X authentication, selecting this checkbox results in the port Authentication Behavior being set to **Inactive**.

---

**NOTE:** For Single User 802.1X+MAC authentication with Active/Default Role as the selected port mode: Disabling 802.1X authentication also disables MAC authentication on the port. An end user connecting to the port is not able to authenticate via 802.1X or MAC. The port behaves as if Inactive/Default Role is the selected port mode.

---

**Disable Web-Based Auth**

Select this checkbox to disable web-based authentication at the port level. If the device is only configured with web-based authentication, selecting this checkbox results in the port Authentication Behavior being set to **Inactive**.

---

**NOTE:** For Multi-User Web-Based authentication with Active/Discard as the selected port mode: This checkbox is automatically selected because multi-user web-based authentication does not support the Active/Discard port mode.

---

**Disable MAC Auth**

Select this checkbox to disable MAC authentication at the port level. If the device is only configured with MAC authentication, selecting this checkbox results in the port Authentication Behavior being set to **Inactive**.

**Disable Quarantine Auth**

Select this checkbox to disable Quarantine authentication at the port level. If the device is only configured with Quarantine authentication, selecting this checkbox results in the port Authentication Behavior being set to **Inactive**.

**Disable Auto Tracking Auth**

Select this checkbox to disable MAC authentication at the port level. If the device is only configured with Auto Tracking authentication, selecting this checkbox results in the port Authentication Behavior being set to **Inactive**.

## RFC3580 VLAN Authorization



This section lets you enable or disable RFC 3580 VLAN Authorization on the port and specify an egress state. RFC 3580 VLAN Authorization must be enabled in networks where the RADIUS server has been configured to return a VLAN ID when a user authenticates. When RFC 3580 VLAN Authorization is enabled:

- ports on devices that do **not** support policy, will tag packets with the VLAN ID.
- ports on devices that do support policy and also support [Authentication-Based VLAN to Role Mapping](#), will classify packets according to the role that the VLAN ID maps to.

You can also enable and disable VLAN Authorization at the device level using the device [Authentication tab](#). If the device does not support RFC 3580, this tab will be grayed out.

RFC3580 VLAN Authorization 

---

VLAN Authorization Status:	Enabled 
VLAN Authorization Admin Egress:	Untagged 

### VLAN Authorization Status

Allows you to enable and disable RFC 3580 VLAN Authorization for the selected port. This option is grayed out if not supported by the device.

### VLAN Authorization Admin Egress

Allows you to modify the VLAN egress list for the VLAN ID returned by the RADIUS server when a user authenticates on the port:

- None — No modification to the VLAN egress list is made.
- Tagged — The port is added to the list with the egress state set to Tagged (frames are forwarded as tagged).
- Untagged — The port is added to the list with the egress state set to Untagged (frames are forwarded as untagged).
- Dynamic — The port uses information returned in the RADIUS response to modify the VLAN egress list. This value is supported only if the device supports a mechanism through which the egress state may be returned in the RADIUS response.

## Login Settings

This tab displays the current login settings for the port and allows you to change the settings if desired. The options available depend on what type(s) of authentication are enabled on the device.

Login Settings ⊖

**MAC**

Hold time (sec):

**802.1X**

Hold time (sec):

Auth request period (sec):

User timeout (sec):

Auth server timeout (sec):

Handshake requests before failure:

**Web Auth**

Max requests:

Hold time (sec):

**Quarantine**

Session Timeout (sec):

Session Idle Timeout (sec):

**Auto Tracking**

Session Timeout (sec):

Session Idle Timeout (sec):

## MAC

### Hold Time (sec)

Amount of time (in seconds) authentication remains timed out after the user fails to login. Valid values are 0-65535. The default is 60. (Hold Time is also known as Quiet Period in web-based and MAC authentication.)

## 802.1X

### Hold Time (sec)

Amount of time (in seconds) authentication remains timed out after the user fails to login. Valid values are 0-65535. The default is 60.

### Auth request period (sec)

For 802.1X authentication, how often (in seconds) the device queries the port to see if there is a new user on it. If a user is found, the device then attempts to authenticate the user. Valid values are 1-65535. The default is 30.

**User timeout (sec)**

For 802.1X authentication, the amount of time (in seconds) the device waits for an answer when querying the port for the existence of a user. Valid values are 1-300. The default is 30.

**Auth server timeout (sec)**

For 802.1X authentication, if a user is found on the port, the amount of time (in seconds) the device waits for a response from the authentication server before timing out. Valid values are 1-300. The default is 30.

**Handshake requests before failure**

For 802.1X authentication, the number of times the device tries to finalize the authentication process with the user, before the authentication request is considered invalid and authentication fails. Valid values are 1-10. The default is 2.

## Web Auth

**Max Requests**

Number of times a user can attempt to log in before authentication fails and login attempts are not allowed. For web-based authentication, valid values are 1-2147483647, zero is not allowed, and the default is 2.

**Hold Time (sec)**

Amount of time (in seconds) authentication remains timed out after the specified **Max Requests** is reached. Valid values are 0-65535. The default is 60.

## Quarantine

**Session Timeout (sec)**

For Quarantine authentication, the maximum number of seconds an authenticated session may last before automatic termination of the session. A value of zero indicates that no session timeout applies.

**Session Idle Timeout (sec)**

For Quarantine authentication, the maximum number of consecutive seconds an authenticated session may be idle before automatic termination of the session. A value of zero indicates that the device level setting is used.

## Auto Tracking

### Session Timeout (sec)

For Auto Tracking sessions, the maximum number of seconds a session may last before automatic termination of the session. A value of zero indicates that the device level setting is used.

### Session Idle Timeout (sec)

For Auto Tracking sessions, the maximum number of consecutive seconds a session may be idle before automatic termination of the session. A value of zero indicates that the device level setting is used.

## Automatic Re-Authentication

This tab is grayed-out if only web-based authentication is enabled on the device. For 802.1X and MAC authentication, the Automatic Re-Authentication tab lets you set up the periodic automatic re-authentication of logged-in users on this port. Without disrupting the user's session, the device repeats the authentication process using the most recently obtained user login information, to see if the same user is still logged in. Authenticated logged-in users are not required to log in again for re-authentication, as this occurs "behind the scenes."

Automatic Re-Authentication	
802.1X Re-auth Status:	Disabled
802.1X Re-auth Frequency (sec):	3600
MAC Re-auth Status:	Disabled
MAC Re-auth Frequency (sec):	3600

### 802.1X Re-auth Status

If **Enabled** is selected, the re-authentication feature is enabled. If **Disabled** is selected, the re-authentication feature is disabled.

### 802.1X Re-auth Frequency (sec)

The length of time (in seconds) the device checks the port to re-authenticate the logged in user. Valid values are 1-2147483647. The default is 3600.

### MAC Re-auth Status

If **Enabled** is selected, the re-authentication feature is enabled. If **Disabled** is selected, the re-authentication feature is disabled.

**MAC Re-auth Frequency (sec)**

The length of time (in seconds) the device checks the port to re-authenticate the logged in user. Valid values are 1-2147483647. The default is 3600.

**Authenticated User Counts**

This section provides authenticated user count information for devices with Multi-User as their configured authentication type. See the [device Authentication tab](#) for information on setting the device authentication type.

Authenticated User Counts <span style="float: right;">⊖</span>	
Current Number of Users:	0
Number of Users Allowed:	8
Number of MAC Users Allowed:	256
Number of Quarantine Users Allowed:	256
Number of Auto Tracking Users Allowed:	256

**Current Number of Users**

The current number of users actively authenticated or are in the process of authenticating on this interface. If multi-user authentication is disabled, this number is 0 (zero). Any unauthenticated traffic on the port is not included in this count.

**Number of Users Allowed**

The maximum number of users that can actively authenticate or be in the process of authenticating at one time on this interface. If you set this value below the current number of users, end user sessions exceeding that number are terminated.

**NOTE: B2/C2 Devices.** If you are configuring a single user and an IP phone per port, set this value to 2.

**Number of MAC Users Allowed**

The number of users that can actively authenticate via MAC authentication, or be in the process of authenticating via MAC authentication at one time on this interface. The number of MAC users allowed cannot exceed the number of users allowed. If you set this value below the current number of users, end user sessions exceeding that number are terminated. If MAC is not selected as a Multi-User authentication type on the [device Authentication tab](#), this field is grayed out.

### Number of Quarantine Users Allowed

The number of users that can be actively authenticated via Quarantine authentication, or have Quarantine authentications in progress at one time on this interface. The number of Quarantine users allowed cannot exceed the number of users allowed. If you set this value below the current number of users, end user sessions exceeding that number are terminated. If Quarantine Auth is not enabled on the [device Authentication tab](#), this field is grayed out.

### Number of Auto Tracking Users Allowed

The number of Auto Tracking users that can be actively authenticated or have authentications in progress at one time on this interface. The number of Auto Tracking users allowed cannot exceed the number of users allowed. If you set this value below the current number of users, end user sessions exceeding that number are terminated. If Auto Tracking is not enabled on the [device Authentication tab](#), this field is grayed out.

## Convergence End-Point Access

This section lists all the Convergence End-Point (CEP) protocols supported by the device that the port resides on, and lets you enable or disable them for that port. For devices that do not support CEP, the section is blank.

Convergence End-Point Access <span style="float: right;">⊖</span>	
Port Mode Authentication behavior should be set to Active for auth to be allowed using the enabled CEP Protocols below.	
Enable	Disable
Status	Name
Disabled	LLDP-MED
Disabled	SIP
Disabled	Generic H323
Disabled	Siemens IP Phone (CorNet IP)
Disabled	Cisco IP Phone

### Enable Button

Selects all the checkboxes and enables all the CEP protocols for this port.

### Disable All Button

Deselects all the checkboxes and disables all the CEP protocols for this port.

### CEP Protocols List

Lists all the CEP protocols supported by the device on which the port resides.

Highlight a CEP protocol and click the Enable or Disable button to enable or disable



CEP protocols, respectively. If the device does not support the CEP feature, this area is blank.

---

### **Related Information**

For information on related tasks:

- [How to Configure Ports](#)

# Extreme Management Center RADIUS (Device)

The device **RADIUS** tab allows you to configure and enable communication between the selected device (the RADIUS client), a RADIUS server or servers, and Extreme Management Center, for the purposes of authentication and accounting.

RADIUS accounting collects various data and statistics, such as the length of time a user has been logged on, and makes that data available to an administrator. It is used by a device to save accounting data on a RADIUS server. The device sends accounting requests to the server. The server acknowledges these requests, and data is passed to the server via accounting updates. For more information on accounting functionality, refer to your RADIUS server documentation.

To display the device **RADIUS** tab, select a device in the left-panel **Devices** tab, then click the **RADIUS** tab in the right panel.

**Client Settings**

Authentication Status: Enabled

Management Access Auth Status Override: N/A

Network Access Auth Status Override: N/A

Number of Retries: 2

Timeout Duration (seconds): 5

Management Access Timeout Duration Override (sec):

Network Access Timeout Duration Override (sec):

Response Mode: Filter ID (Discard VTA)

Retransmit Algorithm: Standard

**Authentication Servers**

Priority	Address	Client UDP Port	Access Type	Current Sessions	Max Sessions	Number of Retries	Timeout Duration (sec)	Mgmt Interface
1		1812	Network Access	0	12000	N/A	N/A	N/A
2		1812	Network Access	0	12000	N/A	N/A	N/A
3		1812	Management Access	0	12000	N/A	N/A	N/A

## Authentication Tab

Use this tab to view and configure the RADIUS authentication servers with which the device (the RADIUS client) can communicate.

### RADIUS Authentication Client Settings

This section lets you enable or disable communication between the selected device (the RADIUS client) and the RADIUS authentication servers, and specify connection attempt information.

#### **Authentication Status**

Allows you to enable and disable communication between this device and the RADIUS authentication server(s). If enabled, the device becomes a RADIUS client and communicates with a RADIUS authentication server whenever a user logs on to a port on the device, as long as the port itself is enabled for authentication and the device is set up as a client on the RADIUS authentication server. The default is Disabled. For ExtremeWireless devices, the Client Status is automatically set to Enabled when a RADIUS server exists and Disabled when it does not.

#### **Management Access Auth Status Override**

Allows you to override the Authentication Status for users accessing the RADIUS authentication server(s) that have requested management access via the console, Telnet, SSH, or HTTP, etc.

#### **Network Access Auth Status Override**

Allows you to override the Authentication Status for users accessing the network via 802.1X, MAC, or Web-Based authentication.

#### **Number of Retries**

The number of attempts the device will make in contacting each RADIUS authentication server before giving up and trying the next RADIUS authentication server on the list. Valid values are 1-65535. For ExtremeWireless devices, this value is entered when the RADIUS server is added.

#### **Timeout Duration**

The total number of seconds the device will wait for the RADIUS authentication server to respond, before trying again. Valid values are 1-65535. For ExtremeWireless devices, this value is entered when the RADIUS server is added.

**Management Access Timeout Duration Override (sec)**

The total number of seconds the device waits for the RADIUS authentication server to respond before trying again for users accessing the RADIUS authentication server (s) that have requested management access via the console, Telnet, SSH, or HTTP, etc.

**Network Access Timeout Duration Override (sec)**

The total number of seconds the device waits for the RADIUS authentication server to respond before trying again for users accessing the network via 802.1X, MAC, or Web-Based authentication.

**Response Mode**

Select the RADIUS response attribute that the device should use for authentication:

- **Filter ID** — The Filter ID (role) is used. If a VLAN Tunnel Attribute (VTA) is returned, it will be ignored.
- **VLAN Tunnel Attribute** — The VLAN Tunnel Attribute is used and the Authentication-Based VLAN to Role Mappings are applied, if present. If a Filter ID is returned, it will be ignored.
- **Filter ID With VLAN Tunnel Attribute** — Both attributes are applied in the following manner: the role is applied to the user, except that the VLAN Tunnel Attribute replaces the role's Default Access Control VLAN (if present). In this case, the Authentication-Based VLAN to Role mappings are ignored (as the role was explicitly assigned). VLAN classification rules are still applied, as defined by the assigned role.

**Retransmit Algorithm**

Select the authentication retransmission algorithm for this device to use with your RADIUS servers. Devices that do not support this functionality will have the option grayed out.

- **Standard** — Specifies that the primary RADIUS server should always be used for authentication, if it is available. The standard RADIUS authentication algorithm focuses on using RADIUS servers for redundancy rather than for scale provisioning. The only time secondary RADIUS servers are used, is when the primary server is unreachable due to a network outage or because server capacity is exceeded.
- **Round-Robin** — The round-robin RADIUS authentication algorithm spreads RADIUS server usage evenly between available RADIUS servers, allowing the load balancing of a large number of authentications across all RADIUS servers. This allows for a maximum authentication throughput for the number of servers configured.

Additionally, if a single server is down, only a portion of the authenticating sessions will be affected by the outage.

- **Sticky Round-Robin** — This algorithm uses round-robin when assigning a RADIUS server to each unique authentication session, but specifies that the same RADIUS server should be used for any given authentication session once a session is initiated. In large-scale NAC deployments, this algorithm is used for switches that are authenticating more users than a NAC appliance supports. For example, a NAC deployment might have an S-Series device that supports 9000 users deployed at the distribution level and authenticating users to three NAC appliances that support 3000 users each. In this scenario, the sticky round-robin algorithm allows the S-Series device to spread the load across all three NAC appliances while using the same NAC appliance for all RADIUS transactions for a given session (MAC address).

### **Apply Button**

Applies the changes you made in the RADIUS Authentication Client Settings section.

## **Authentication RADIUS Server(s) Table**

This table lists the RADIUS authentication servers with which the device (the RADIUS client) can communicate. Use the buttons to add or remove servers, and edit server parameters. You can also edit a server's parameters by double-clicking the server entry in the list.

### **Priority**

Order in which the RADIUS authentication server is checked, as compared to the other RADIUS authentication servers listed here. The lower the number, the higher the priority.

### **RADIUS Server IP**

IP address of the RADIUS authentication server.

### **Client UDP Port**

UDP port number (1-65535) on the RADIUS authentication server that the device will send authentication requests to; 1812 is the default port number.

### **Access Type**

The type of authentication access allowed for this RADIUS server:

- **Any access** — the server can authenticate users originating from any access type.

- **Management access** — the server can only authenticate users that have requested management access via the console, Telnet, SSH, or HTTP, etc.
- **Network access** — the server can only authenticate users that are accessing the network via 802.1X, MAC, or Web-Based authentication.

Devices that do not support this feature will display N/A in this column.

### **Current Sessions**

The current number of sessions associated with this server when the device is using the [sticky round-robin RADIUS authentication algorithm](#). This value is not used when other algorithms are being used.

### **Max Sessions**

The maximum number of sticky round-robin authentication sessions allowed on the server when the [sticky round-robin RADIUS authentication algorithm](#) is configured for the device. This value is not used when other algorithms are being used. In sticky round-robin, if a MAC address needs to re-authenticate, the request is sent to the same RADIUS server as the initial authentication request, unless the current number of authentication sessions for the server has reached the specified Max Sessions value. When this value is reached, re-authentication requests will instead default to the standard round-robin behavior to determine which RADIUS server to send the request to.

### **Number of Retries**

The number of times the device will resend an authentication request if the RADIUS authentication server does not respond. For ExtremeWireless devices, this value is configured per RADIUS server. For all other devices, this value is global to all RADIUS servers, and is specified per device (Client Default) in the [RADIUS Authentication Client Settings](#) section.

### **Timeout Duration**

The amount of time in seconds the device will wait for the RADIUS authentication server to respond to an authentication request. For ExtremeWireless devices, this value is configured per RADIUS server. For all other devices, this value is global to all RADIUS servers, and is specified per device (Client Default) in the [RADIUS Authentication Client Settings](#) section.

### **Management Interface**

The IP address and VRName used when the switch is communicating with a configured RADIUS server.

### **Apply Button**

Applies any changes you made in the RADIUS Authentication Server(s) tab.

### Add Button

Opens the [Add RADIUS Authentication Server window](#), where you can enter the parameters for a server you want to add to the list. When you click **OK** on this window, the new server is added.

### Remove Button

Select a RADIUS authentication server in the list and use this button to remove the server.

### Edit Button

Select a RADIUS authentication server in the list and use this button to edit the server's parameters. You can also edit the server parameters by double-clicking the server entry in the list.

## Accounting Tab

Use this tab to view and configure the RADIUS accounting servers with which the device (the RADIUS client) can communicate.

Client Settings

Accounting Status: Enabled

Management Access Accounting Status Override: N/A

Network Access Accounting Status Override: N/A

Quarantine Accounting Status: Enabled

802.1X Accounting Status: Enabled

PWA Accounting Status: Enabled

MAC Accounting Status: Enabled

CEP Accounting Status: Enabled

Auto Tracking Accounting Status: Enabled

Update Interval (seconds): 1800

Management Access Timeout Duration (sec):

Network Access Timeout Duration (sec):

Apply

Accounting Servers

Add Edit Remove Apply

Priority	Address	Client UDP Port	Access Type	Number of Retries	Timeout Duration (sec)	Update Interval (sec)	Mgmt Interface
1		1813	N/A	3	10	N/A	N/A

## RADIUS Accounting Client Settings

This section lets you enable or disable communication between the selected device (the RADIUS client) and the RADIUS accounting servers, and specify the update interval.

### Accounting Status

Allows you to enable or disable RADIUS accounting. RADIUS accounting is used by a device to save accounting data on a RADIUS accounting server. If accounting is enabled, an accounting session starts after the user is successfully authenticated by a RADIUS authentication server. The default is Disabled. For ExtremeWireless devices, the status is automatically set to Enabled when a RADIUS server exists and Disabled when it does not. Devices that do not support RADIUS accounting will have this field grayed out.

### Management Access Auth Status Override

Allows you to override the Accounting Status for users accessing the RADIUS accounting server(s) that have requested management access via the console, Telnet, SSH, or HTTP, etc.

### Network Access Auth Status Override

Allows you to override the Accounting Status for users accessing the network via 802.1X, MAC, or Web-Based authentication.

### Per Authentication Type Accounting Status

Allows you to enable/disable RADIUS accounting for individual authentication types. Some authentication types do not have RADIUS accounting enabled by default (when global RADIUS accounting is enabled). Enabling these authentication types will give both NAC and other RADIUS servers more complete information regarding authentication sessions. These options also allow you to disable accounting messages from certain authentication types, for example, Auto-Tracking, which does not actually authenticate end users. Note that the global [Accounting Status](#) option controls accounting on a global basis for all authentication types. Devices that do not support this functionality will have these fields grayed out.

### Update Interval (minutes)

Collected accounting data is sent from the device to the RADIUS accounting server via accounting updates. The Accounting Update Interval is the amount of time in minutes between accounting updates. Valid values are 1-65535. It is recommended that the value be greater than 10 minutes, and careful consideration should be given to its impact on network traffic. Devices that do not support RADIUS accounting



have this field grayed out (with the exception of an SNMPv1 R2 device, which display accounting values but will not allow you to set them.) For ExtremeWireless devices, this value is entered when the RADIUS server is added.

**Management Access Timeout Duration Override (sec)**

The total number of seconds the device waits for the RADIUS accounting server to respond before trying again for users accessing the RADIUS accounting server(s) that have requested management access via the console, Telnet, SSH, or HTTP, etc.

**Network Access Timeout Duration Override (sec)**

The total number of seconds the device waits for the RADIUS accounting server to respond before trying again for users accessing the network via 802.1X, MAC, or Web-Based authentication.

**Apply Button**

Applies the changes you made in the RADIUS Accounting Client Settings section.

## Accounting RADIUS Servers Table

This tab lists the RADIUS accounting servers with which the device (the RADIUS client) can communicate. Use the buttons to add or remove servers, and edit server parameters. You can also edit a server's parameters by double-clicking the server entry in the list.

**Priority**

Order in which the RADIUS accounting server is checked, as compared to the other RADIUS accounting servers listed here. The lower the number, the higher the priority.

**RADIUS Server IP**

IP address of the RADIUS accounting server.

**Client UDP Port**

UDP port number (1-65535) on the RADIUS accounting server that the device will send accounting requests to; 1813 is the default port number. Devices that do not support RADIUS accounting will display N/A in this column (with the exception of an SNMPv1 R2 device, which will display accounting values but will not allow you to set them.)

**Access Type**

The type of authentication access allowed for this RADIUS server:

- **Any access** — the server can authenticate users originating from any access type.
- **Management access** — the server can only authenticate users that have requested management access via the console, Telnet, SSH, or HTTP, etc.
- **Network access** — the server can only authenticate users that are accessing the network via 802.1X, MAC, or Web-Based authentication.

Devices that do not support this feature will display N/A in this column.

**Number of Retries**

The number of times the device will resend an accounting request if the RADIUS accounting server does not respond. Valid values are 0-20. Devices that do not support RADIUS accounting will display N/A in this column (with the exception of an SNMPv1 R2 device, which display accounting values but does not allow you to set them.)

**Timeout Duration**

The amount of time in seconds the device will wait for the RADIUS accounting server to respond to an accounting request. Valid values are 2-10 seconds. Devices that do not support RADIUS accounting will display N/A in this column (with the exception of an SNMPv1 R2 device, which display accounting values but does not allow you to set them.)

**Update Interval**

The amount of time in minutes between accounting updates. For ExtremeWireless devices, this value is configured per RADIUS server. For all other devices, this value is global to all RADIUS servers, and is specified per device (Client Default) in the [RADIUS Accounting Client Settings](#) section.

**Management Interface**

The IP address and VRName used when the switch is communicating with a configured RADIUS server.

**Apply Button**

Applies any changes you made in the RADIUS Accounting Server(s) tab.

**Add Button**

Opens the [Add RADIUS Accounting Server window](#), where you can enter the parameters for a server you want to add to the list. When you click **OK** on this window, the new server is added.

**Remove Button**

Select a RADIUS accounting server in the list and use this button to remove the server.

**Edit Button**

Select a RADIUS accounting server in the list and use this button to edit the server's parameters. You can also edit the server parameters by double-clicking the server entry in the list.

---

**Related Information**

For information on related concepts:

- [Authentication](#)

For information on related windows:

- [Ports Tab \(Device\)](#)
- [Add RADIUS Authentication Server Window](#)
- [Add RADIUS Accounting Server Window](#)

## RADIUS Authentication (Device)

The device RADIUS **Authentication** tab allows you to configure and enable communication between the selected device (the RADIUS client), a RADIUS server or servers, and Extreme Management Center, for the purposes of [authentication](#) and accounting (for your SNMPv3 devices that support it).

Use this tab to view and configure the RADIUS authentication servers with which the device (the RADIUS client) can communicate.

**Client Settings**

Authentication Status:

Management Access Auth Status Override:

Network Access Auth Status Override:

Number of Retries:

Timeout Duration (seconds):

Management Access Timeout Duration Override (sec):

Network Access Timeout Duration Override (sec):

Response Mode:

Retransmit Algorithm:

**Authentication Servers**

Priority	Address	Client UDP Port	Access Type	Current Sessions	Max Sessions	Number of Retries	Timeout Duration (sec)	Mgmt Interface
1		1812	Network Access	0	12000	N/A	N/A	N/A
2		1812	Network Access	0	12000	N/A	N/A	N/A
3		1812	Management Access	0	12000	N/A	N/A	N/A

### RADIUS Authentication Client Settings

This section lets you enable or disable communication between the selected device (the RADIUS client) and the RADIUS authentication servers, and specify connection attempt information.

#### Authentication Status

Allows you to enable and disable communication between this device and the RADIUS authentication server(s). If enabled, the device becomes a RADIUS client and communicates with a RADIUS authentication server whenever a user logs on to a port on the device, as long as the port itself is enabled for authentication and the device is set up as a client on the RADIUS authentication server. For

ExtremeWireless devices, the Client Status is automatically set to **Enabled** when a RADIUS server exists and **Disabled** when it does not.

### **Management Access Auth Status Override**

Allows you to override the Authentication Status for users accessing the RADIUS authentication server(s) that requested management access via the console, Telnet, SSH, or HTTP, etc.

### **Network Access Auth Status Override**

Allows you to override the Authentication Status for users accessing the network via 802.1X, MAC, or Web-Based authentication.

### **Number of Retries**

The number of attempts the device makes in contacting each RADIUS authentication server before giving up and trying the next RADIUS authentication server on the list. For ExtremeWireless devices, this value is entered when the RADIUS server is added.

### **Timeout Duration (seconds)**

The total number of seconds the device waits for the RADIUS authentication server to respond, before trying again. For ExtremeWireless devices, this value is entered when the RADIUS server is added.

### **Management Access Timeout Duration Override (sec)**

The total number of seconds the device waits for the RADIUS authentication server to respond before trying again for users accessing the RADIUS authentication server (s) that requested management access via the console, Telnet, SSH, or HTTP, etc.

### **Network Access Timeout Duration Override (sec)**

The total number of seconds the device waits for the RADIUS authentication server to respond before trying again for users accessing the network via 802.1X, MAC, or Web-Based authentication.

### **Response Mode**

Select the RADIUS response attribute the device uses for authentication:

- **Filter ID (Discard VTA)** — The Filter ID (role) is used. If a VLAN Tunnel Attribute (VTA) is returned, it is ignored.
- **VLAN Tunnel Attribute (Discard Tunnel Attribute)** — The VLAN Tunnel Attribute is used and the [Authentication-Based VLAN to Role Mappings](#) are applied, if present. If a Filter ID is returned, it is ignored.
- **Filter ID With VLAN Tunnel Attribute** — Both attributes are applied in the following manner: the role is applied to the user, except that the VLAN Tunnel Attribute

replaces the role's Default Access Control VLAN (if present). In this case, the Authentication-Based VLAN to Role mappings are ignored (as the role was explicitly assigned). VLAN classification rules are still applied, as defined by the assigned role.

### Retransmit Algorithm

Select the authentication retransmission algorithm for this device to use with your RADIUS servers. Devices that do not support this functionality have the option grayed out.

- **Standard** — Specifies that the primary RADIUS server should always be used for authentication, if it is available. The standard RADIUS authentication algorithm focuses on using RADIUS servers for redundancy rather than for scale provisioning. The only time secondary RADIUS servers are used, is when the primary server is unreachable due to a network outage or because server capacity is exceeded.
- **Round-Robin** — The round-robin RADIUS authentication algorithm spreads RADIUS server usage evenly between available RADIUS servers, allowing the load balancing of a large number of authentications across all RADIUS servers. This allows for a maximum authentication throughput for the number of servers configured. Additionally, if a single server is down, only a portion of the authenticating sessions are affected by the outage.
- **Sticky Round-Robin** — This algorithm uses round-robin when assigning a RADIUS server to each unique authentication session, but specifies that the same RADIUS server is used for any given authentication session once a session is initiated. In large-scale Extreme Access Control deployments, this algorithm is used for switches authenticating more users than an Extreme Access Control appliance supports. For example, an Extreme Access Control deployment might have an S-Series device that supports 9000 users deployed at the distribution level and authenticating users to three Extreme Access Control appliances that support 3000 users each. In this scenario, the sticky round-robin algorithm allows the S-Series device to spread the load across all three Extreme Access Control appliances while using the same Extreme Access Control appliance for all RADIUS transactions for a given session (MAC address).

### Apply Button

Applies the changes you made in the RADIUS Authentication Client Settings section.

## Authentication RADIUS Server(s) Table

This table lists the RADIUS authentication servers with which the device (the RADIUS client) can communicate. Use the buttons to add or remove servers, and

edit server parameters. You can also edit a server's parameters by double-clicking the server entry in the list.

**Priority**

Order in which the RADIUS authentication server is checked, as compared to the other RADIUS authentication servers listed here. The lower the number, the higher the priority with 1 being the highest priority.

**Address**

IP address of the RADIUS authentication server.

**Client UDP Port**

UDP port number (1-65535) on the RADIUS authentication server to which the device sends authentication requests; 1812 is the default port number.

**Access Type**

The type of authentication access allowed for this RADIUS server:

- **Any access** — the server can authenticate users originating from any access type.
- **Management access** — the server can only authenticate users that requested management access via the console, Telnet, SSH, or HTTP, etc.
- **Network access** — the server can only authenticate users accessing the network via 802.1X, MAC, or Web-Based authentication.

Devices that do not support this feature display N/A in this column.

**Current Sessions**

The current number of sessions associated with this server when the device is using the [sticky round-robin RADIUS authentication algorithm](#). This value is not used when other algorithms are being used.

**Max Sessions**

The maximum number of sticky round-robin authentication sessions allowed on the server when the [sticky round-robin RADIUS authentication algorithm](#) is configured for the device. This value is not used when other algorithms are selected. In sticky round-robin, if a MAC address needs to re-authenticate, the request is sent to the same RADIUS server as the initial authentication request, unless the current number of authentication sessions for the server has reached the specified **Max Sessions** value. When this value is reached, re-authentication requests instead default to the standard round-robin behavior to determine the RADIUS server to which to send the request.

**Number of Retries**

The number of times the device resends an authentication request if the RADIUS authentication server does not respond. For ExtremeWireless devices, this value is configured per RADIUS server. For all other devices, this value is global to all RADIUS servers, and is specified per device (Client Default) in the [RADIUS Authentication Client Settings](#) section.

**Timeout Duration (sec)**

The amount of time in seconds the device waits for the RADIUS authentication server to respond to an authentication request. For ExtremeWireless devices, this value is configured per RADIUS server. For all other devices, this value is global to all RADIUS servers, and is specified per device (Client Default) in the [RADIUS Authentication Client Settings](#) section.

**Management Interface**

The IP address and VRName used when the switch is communicating with a configured RADIUS server.

**Add Button**

Opens the [Add/Edit RADIUS Authentication Server window](#), where you can enter the parameters for a server you want to add to the list. When you click **OK** on this window, the new server is added.

**Edit Button**

Select a RADIUS authentication server in the list and use this button to edit the server's parameters. You can also edit the server parameters by double-clicking the server entry in the list.

**Remove Button**

Select a RADIUS authentication server in the list and use this button to remove the server.

**Apply Button**

Applies any changes you made in the RADIUS Authentication Server(s) tab.

---

**Related Information**

For information on related concepts:

- [Authentication](#)

For information on related windows:



- [Port Properties - Authentication Configuration Tab](#)
- [Add RADIUS Authentication Server Window](#)
- [Add RADIUS Accounting Server Window](#)

# Extreme Management Center RADIUS Authentication (Devices)

The **RADIUS Authentication** tab displays authentication RADIUS server information for all the devices in the current domain. You can configure RADIUS server information for an individual device using the device's [RADIUS Tab](#).

To access this tab, select **Devices/Port Groups>Devices** in the left-panel of the **Policy** tab, then click the **RADIUS Authentication** tab in the right panel.

IP Address	Auth Client Status	Auth Retries	Auth Timeout Duration	Auth Server Address	Auth UDP Port	RADIUS Response Conflict
N/A	N/A				1812	Filter ID With VLAN Tunnel Attribute
N/A	N/A				1812	Filter ID With VLAN Tunnel Attribute
N/A	N/A				1812	Filter ID With VLAN Tunnel Attribute
N/A	N/A				1812	Filter ID With VLAN Tunnel Attribute
	Enabled	2	5		1812	Filter ID (Discard VTA)
	Enabled	2	5		1812	Filter ID (Discard VTA)
	Enabled	2	5		1812	Filter ID (Discard VTA)
	Enabled	2	5		1812	Filter ID (Discard VTA)
	Enabled	3	15		1812	Filter ID With VLAN Tunnel Attribute
	Enabled	3	15		1812	Filter ID With VLAN Tunnel Attribute
	N/A					N/A
	Disabled	3	20			Filter ID (Discard VTA)
	Enabled	3	15		1812	Filter ID (Discard VTA)

## IP Address

IP address of the device.

## Auth Client Status

Informs you whether or not the device is enabled as a RADIUS client. If **Enabled**, the device is a RADIUS client and communicates with a RADIUS authentication server whenever a user logs on to a port on the device, as long as the port itself is enabled for authentication. If **Disabled**, the device is currently not enabled as a RADIUS client.

## Auth Retries

Number of attempts the device (RADIUS client) makes to connect to the RADIUS authentication server before giving up and trying the next RADIUS server on the list.

## Auth Timeout Duration

Total number of seconds the device (RADIUS client) waits for the RADIUS authentication server to respond before trying again.

**Auth Server Address**

The IP addresses of the RADIUS servers the client device attempts to contact.

**Auth UDP Port**

The UDP port number used to send authentication requests.

**RADIUS Response Conflict**

Indicates the RADIUS response attribute that the device uses for authentication. You can configure the Response Mode in the [RADIUS tab](#) for the device.

---

**Related Information**

For information on related concepts:

- [Authentication](#)

For information on related windows:

- [Add RADIUS Authentication Server Window](#)
- [Add RADIUS Accounting Server Window](#)

# Extreme Management Center RADIUS Accounting (Device)

The device RADIUS **Accounting** tab allows you to configure and enable communication between the selected device (the RADIUS client), a RADIUS server or servers, and Extreme Management Center, for the purposes of accounting (for your SNMPv3 devices that support it).

RADIUS accounting collects various data and statistics, such as the length of time a user has been logged on, and makes that data available to an administrator. It is used by a device to save accounting data on a RADIUS server. Accounting requests are sent from the device to the server. The server acknowledges these requests, and data is passed to the server via accounting updates. For more information on accounting functionality, refer to your RADIUS server documentation.

To display the device RADIUS **Accounting** tab, select a device in the left panel **Devices > Devices tree**, then click **RADIUS > Accounting** in the right panel.

Ports User Sessions Authentication **RADIUS**

Authentication **Accounting**

Refresh

**Client Settings**

Accounting Status: Enabled

Management Access Accounting Status Override: N/A

Network Access Accounting Status Override: N/A

Quarantine Accounting Status: Enabled

802.1X Accounting Status: Enabled

PWA Accounting Status: Enabled

MAC Accounting Status: Enabled

CEP Accounting Status: Enabled

Auto Tracking Accounting Status: Enabled

Update Interval (seconds): 1800

Management Access Timeout Duration (sec):

Network Access Timeout Duration (sec):

Apply

**Accounting Servers**

Add Edit Remove Apply

Priority	Address	Client UDP Port	Access Type	Number of Retries	Timeout Duration (sec)	Update Interval (sec)	Mgmt Interface
1		1813	N/A	3	10	N/A	N/A

## RADIUS Accounting Client Settings

This section lets you enable or disable communication between the selected device (the RADIUS client) and the RADIUS accounting servers, and specify the update interval.

### Accounting Status

Allows you to enable or disable RADIUS accounting on SNMPv3 devices that support it. RADIUS accounting is used by a device to save accounting data on a RADIUS accounting server. If accounting is enabled, an accounting session starts after the user is successfully authenticated by a RADIUS authentication server. The default is Disabled. For ExtremeWireless devices, the status is automatically set to Enabled when a RADIUS server exists and Disabled when it does not. Devices that do not support RADIUS accounting have this field grayed out.

### Management Access Auth Status Override

Allows you to override the Accounting Status for users accessing the RADIUS accounting server(s) that have requested management access via the console, Telnet, SSH, or HTTP, etc.

### Network Access Auth Status Override

Allows you to override the Accounting Status for users accessing the network via 802.1X, MAC, or Web-Based authentication.

### Per Authentication Type Accounting Status

Allows you to enable/disable RADIUS accounting for individual authentication types (Quarantine, 802.1X, PWA, MAC, CEP, and Auto Tracking). Some authentication types do not have RADIUS accounting enabled by default (when global RADIUS accounting is enabled). Enabling these authentication types gives both Extreme Access Control and other RADIUS servers more complete information regarding authentication sessions. These options also allow you to disable accounting messages from certain authentication types, for example, Auto-Tracking, which does not actually authenticate end users. Note that the global [Accounting Status](#) option controls accounting on a global basis for all authentication types. Devices that do not support this functionality have these fields grayed out.

### Update Interval (seconds)

Collected accounting data is sent from the device to the RADIUS accounting server via accounting updates. The Accounting Update Interval is the amount of time in seconds between accounting updates. This field is greyed out for devices that do not support RADIUS accounting (with the exception of an SNMPv1 R2 device, which

displays accounting values but does not allow you to set them.) For ExtremeWireless devices, this value is entered when the RADIUS server is added.

**Management Access Timeout Duration Override (sec)**

The total number of seconds the device waits for the RADIUS accounting server to respond before trying again for users accessing the RADIUS accounting server(s) that have requested management access via the console, Telnet, SSH, or HTTP, etc.

**Network Access Timeout Duration Override (sec)**

The total number of seconds the device waits for the RADIUS accounting server to respond before trying again for users accessing the network via 802.1X, MAC, or Web-Based authentication.

**Apply Button**

Applies the changes you made in the RADIUS Accounting Client Settings section.

## Accounting RADIUS Servers Table

This table lists the RADIUS accounting servers with which the device (the RADIUS client) can communicate. Use the buttons to add or remove servers, and edit server parameters. You can also edit a server's parameters by double-clicking the server entry in the list.

**Priority**

Order in which the RADIUS accounting server is checked, as compared to the other RADIUS accounting servers listed here. The lower the number, the higher the priority with 1 being the highest priority.

**Address**

IP address of the RADIUS accounting server.

**Client UDP Port**

UDP port number (1-65535) on the RADIUS accounting server to which the device sends accounting requests; 1813 is the default port number. Devices that do not support RADIUS accounting display N/A in this column (with the exception of an SNMPv1 R2 device, which displays accounting values, but does not allow you to set them.)

**Access Type**

The type of authentication access allowed for this RADIUS server:

- **Any access** — the server can authenticate users originating from any access type.

- **Management access** — the server can only authenticate users accessing the network via the console, Telnet, SSH, or HTTP, etc.
- **Network access** — the server can only authenticate users accessing the network via 802.1X, MAC, or Web-Based authentication.

Devices that do not support this feature display N/A in this column.

**Number of Retries**

The number of times the device resends an accounting request if the RADIUS accounting server does not respond. Valid values are 0-20. Devices that do not support RADIUS accounting display N/A in this column (with the exception of an SNMPv1 R2 device, which displays accounting values, but does not allow you to set them.)

**Timeout Duration (sec)**

The amount of time in seconds the device waits for the RADIUS accounting server to respond to an accounting request. Valid values are 2-10 seconds. Devices that do not support RADIUS accounting display N/A in this column (with the exception of an SNMPv1 R2 device, which displays accounting values, but does not allow you to set them.)

**Update Interval (sec)**

The amount of time in seconds between accounting updates. For ExtremeWireless devices, this value is configured per RADIUS server. For all other devices, this value is global to all RADIUS servers, and is specified per device (Client Default) in the [RADIUS Accounting Client Settings](#) section.

**Management Interface**

The IP address and VRName used when the switch is communicating with a configured RADIUS server.

**Apply Button**

Applies any changes you made in the RADIUS Accounting Server(s) tab.

**Add Button**

Opens the [Add RADIUS Accounting Server window](#), where you can enter the parameters for a server you want to add to the list. When you click **OK** on this window, the new server is added.

**Remove Button**

Select a RADIUS accounting server in the list and use this button to remove the server.

**Edit Button**

Select a RADIUS accounting server in the list and use this button to edit the server's parameters. You can also edit the server parameters by double-clicking the server entry in the list.

---

**Related Information**

For information on related concepts:

- [Authentication](#)

For information on related windows:

- [Port Properties - Authentication Configuration Tab](#)
- [Add RADIUS Authentication Server Window](#)
- [Add RADIUS Accounting Server Window](#)



# Extreme Management Center RADIUS Accounting (Devices)

The **RADIUS Accounting** tab displays accounting RADIUS server information for all the devices in the current domain. You can configure RADIUS server information for an individual device using the device's [RADIUS Tab](#).

To access this tab, select **Devices/Port Groups>Devices** in the left-panel of the Policy tab, then click the **RADIUS Accounting** tab in the right panel.

IP Address	Acct Client Status	Acct Update Interval	Acct Server Address	Acct UDP Port
	N/A			1813
	N/A			1813
	N/A			1813
	N/A			1813
	Enabled	0		1813
	Enabled	0		1813
	Enabled	1800		1813
	Enabled	1800		1813
	N/A			
	N/A			
	Enabled	1800		1813

## IP Address

IP address of the device.

## Acct. Client Status

Informs you whether or not RADIUS accounting is enabled on the device (the RADIUS client). RADIUS accounting is supported on certain SNMPv3 devices, and is used by the device to save accounting data on a RADIUS server. If accounting is enabled, an accounting session starts after the user is successfully authenticated by a RADIUS server. Devices that do not support RADIUS accounting display N/A in this column (with the exception of an SNMPv1 R2 device, which displays a status.)

## Acct. Update Interval

Collected accounting data is sent from the device (RADIUS client) to the RADIUS server via accounting updates. The Accounting Update Interval is the amount of time in minutes between accounting updates. Devices that do not support RADIUS accounting display N/A in this column (with the exception of an SNMPv1 R2 device, which displays a value.)

## Acct Server Address

The IP addresses of the RADIUS servers the client device attempts to contact.

### **Auth UDP Port**

The UDP port number used to send accounting requests.

---

### **Related Information**

For information on related concepts:

- [Authentication](#)

For information on related windows:

- [Add RADIUS Authentication Server Window](#)
- [Add RADIUS Accounting Server Window](#)

# Extreme Management Center Add/Edit RADIUS Server

This window lets you add a RADIUS server to Extreme Management Center for the purpose of authentication. Access this window by clicking **Add** in the RADIUS Server(s) Authentication sub-tab in the [RADIUS tab](#) for a device.

The screenshot shows a dialog box titled "Add/Edit RADIUS Server" with a close button in the top right corner. Below the title bar is a section titled "RADIUS Authentication Server Settings". This section contains several configuration fields:

- Authentication Server Type: A dropdown menu currently set to "IPv4".
- Authentication Server IP: An empty text input field.
- Authentication Client UDP Port: A spinner control currently set to "1812".
- Server Shared Secret: An empty text input field.
- Verify Shared Secret: An empty text input field.
- Max Sessions (Sticky Round-Robin): A spinner control currently set to "2048".
- Authentication Access Type: A dropdown menu currently set to "Any Access".
- Server Priority (1-20): A spinner control currently set to "5".

At the bottom of the dialog, there are two buttons: "OK" (highlighted in blue) and "Cancel".

## Authentication Server Type

Select the authentication type used on the RADIUS server.

**NOTE:** DNS servers (on supported devices) may only be added when there is a valid DNS server configured on the Device which allows the DNS name to resolve to an IP address at the time of configuration.

## Authentication Server IP

Enter the IP or IPv6 address, or the hostname of the RADIUS authentication server. Not all devices support IPv6 address types.

## Authentication Client UDP Port

Enter the UDP port number (1-65535) the device (RADIUS client) uses to send authentication requests to the RADIUS authentication server; 1812 is the default port number.

**Server Shared Secret**

A string of characters used to encrypt and decrypt communications between the device (RADIUS client) and the RADIUS authentication server. This string must match the shared secret entered when you added the client device on the RADIUS server. Without the shared secret, the server and client are unable to communicate, and authentication attempts fail. The shared secret must be at least 6 characters long; 16 characters is recommended. Dashes are allowed in the string, but spaces are not.

---

**NOTES:** If you are configuring multiple RADIUS servers, the same server shared secret must be used for each RADIUS server. This is because most devices (RADIUS clients) only support one shared secret. Matrix N-Series devices with firmware version 5.0 or above are an exception to this, as these devices **do** support a unique shared secret for each server.

This Server Shared Secret is not to be confused with the Application Shared Secret that encrypts communication between the RADIUS client and Extreme Management Center, entered in the Application Shared Secret area of the [RADIUS tab](#) for a device.

---

**Verify Shared Secret**

Re-enter the Server Shared Secret you entered above.

**Max Sessions (Sticky Round-Robin)**

Specifies the maximum number of sticky round-robin authentication sessions allowed on the server when the [sticky round-robin RADIUS authentication algorithm](#) is configured for a device. In sticky round-robin, if a MAC address needs to re-authenticate, the request is sent to the same RADIUS server as the initial authentication request, unless the current number of authentication sessions for the server has reached the specified Max Sessions value. When this value is reached, re-authentication requests will instead default to the standard round-robin behavior to determine which RADIUS server to send the request to. Devices that do not support this functionality will have the option grayed out.

**Number of Retries**

The number of times the device will resend an authentication request if the RADIUS authentication server does not respond. For ExtremeWireless devices, this value is configured for each server. For all other devices, this value is global to all RADIUS servers, and is specified per device (Client Default) in the [RADIUS Authentication Client Settings](#) section of the RADIUS tab.

**Timeout Duration**

The amount of time in seconds the device will wait for the RADIUS authentication server to respond to an authentication request. For ExtremeWireless devices, this value is configured for each server. For all other devices, this value is global to all RADIUS servers, and is specified per device (Client Default) in the [RADIUS Authentication Client Settings](#) section of the RADIUS tab.

**Authentication Access Type**

Use the drop-down list to select the type of authentication access allowed for this RADIUS server:

- **Any access** - the server can authenticate users originating from any access type.
- **Management access** - the server can only authenticate users that have requested management access via the console, Telnet, SSH, or HTTP, etc.
- **Network access** - the server can only authenticate users that are accessing the network via 802.1X, MAC, or Web-Based authentication.

This feature allows you to have one set of servers for authenticating management access requests and a different set for authenticating network access requests. Devices that do not support this feature will have this field grayed out.

**Server Priority**

Order in which the RADIUS authentication server will be checked, as compared to the other RADIUS authentication servers on the device. The lower the number, the higher the priority.

**Management Interface**

Select the IP address and VRName to use when the switch is communicating with a configured RADIUS server.

**NOTE:** ExtremeXOS devices must define a Management Interface.

---

**Related Information**

For information on related concepts:

- [Authentication](#)

For information on related windows:

- [RADIUS Tab](#)

# Extreme Management Center Add RADIUS Accounting Server

This window lets you add a RADIUS server to Extreme Management Center for the purpose of RADIUS accounting. Access this window by clicking **Add** in the RADIUS Server(s) Accounting sub-tab in the [RADIUS tab](#) for a device.

The screenshot shows a dialog box titled "Add/Edit RADIUS Server" with a close button in the top right corner. Below the title bar is a section labeled "RADIUS Accounting Server Settings". This section contains several configuration fields:

- Accounting Server Type: A dropdown menu currently showing "IPv4".
- Accounting Server IP: An empty text input field.
- Accounting Client UDP Port: A spinner box currently showing "1813".
- Server Shared Secret: An empty text input field.
- Verify Shared Secret: An empty text input field.
- Number of Retries: A spinner box currently showing "3".
- Timeout Duration (sec): A spinner box currently showing "10".
- Server Priority (1-20): A spinner box currently showing "3".

At the bottom of the dialog, there are two buttons: "OK" (in blue) and "Cancel" (in grey).

## Accounting Server Type

Select the accounting type used on the RADIUS server.

**NOTE:** DNS servers (on supported devices) may only be added when there is a valid DNS server configured on the Device which allows the DNS name to resolve to an IP address at the time of configuration.

## Accounting Server IP

Enter the IP or IPv6 address, or the hostname of the RADIUS accounting server. Not all devices support IPv6 address types.

## Accounting Client UDP Port

Enter the UDP port number (1-65535) the device (RADIUS client) uses to send accounting requests to the RADIUS server; 1813 is the default port number. Devices that do not support RADIUS accounting will have this field grayed out (with the exception of an SNMPv1 R2 device, which will display accounting values but will not allow you to set them.)

**Server Shared Secret**

A string of characters used to encrypt and decrypt communications between the device (RADIUS client) and the RADIUS accounting server. This string must match the shared secret entered when you added the client device on the RADIUS server. Without the shared secret, the server and client will be unable to communicate. The shared secret must be at least 6 characters long; 16 characters is recommended. Dashes are allowed in the string, but spaces are not.

---

**NOTES:** If you are configuring multiple RADIUS servers, the same server shared secret must be used for each RADIUS server. This is because most devices (RADIUS clients) only support one shared secret. Matrix N-Series devices with firmware version 5.0 or above are an exception to this, as these devices **do** support a unique shared secret for each server.

This Server Shared Secret is different than the Application Shared Secret that encrypts communication between the RADIUS client and Extreme Management Center, entered in the Application Shared Secret area of the [RADIUS tab](#) for a device.

---

**Verify Shared Secret**

Re-enter the Server Shared Secret you entered above.

**Number of Retries (0-20)**

The number of times the device will resend an accounting request if the RADIUS server does not respond. Valid values are 0-20. Devices that do not support RADIUS accounting will have this field grayed out (with the exception of an SNMPv1 R2 device, which will display accounting values but will not allow you to set them.)

**Timeout Duration (2 -10 sec)**

The amount of time in seconds the device will wait for the RADIUS server to respond to an accounting request. Valid values are 2-10 seconds. Devices that do not support RADIUS accounting will have this field grayed out (with the exception of an SNMPv1 R2 device, which will display accounting values but will not allow you to set them.)

**Update Interval (minutes)**

The Accounting Update Interval is the amount of time in minutes between accounting updates. For ExtremeWireless Wireless devices, this value is configured per RADIUS server. For all other devices, this value is global to all RADIUS servers, and is specified per device (Client Default) in the [RADIUS Accounting Client Settings](#) section of the RADIUS tab. Devices that do not support RADIUS accounting will have this field grayed out.

### Accounting Access Type

Use the drop-down menu to select the type of accounting access allowed for this RADIUS server:

- **Any access** - the server can send an accounting request for users originating from any access type.
- **Management access** - the server can only send an accounting request for users that have requested management access via the console, Telnet, SSH, or HTTP, etc.
- **Network access** - the server can only send an accounting request users that are accessing the network via 802.1X, MAC, or Web-Based accounting.

This feature allows you to have one set of servers for accounting management access requests and a different set for accounting network access requests. Devices that do not support this feature have this field grayed out.

### Server Priority (1-20)

Order in which the RADIUS accounting server will be checked, as compared to the other RADIUS accounting servers on the device. The lower the number, the higher the priority.

### Management Interface

Select the IP address and VRName to use when the switch is communicating with a configured RADIUS server.

---

**NOTE:** ExtremeXOS devices must define a Management Interface.

---

---

### Related Information

For information on related windows:

- [RADIUS Tab](#)

## Extreme Management Center Ports (Device)

---

The device **Port Groups** tab displays a table of information about the selected device's ports. To access this tab, select a port group from the left panel's **Devices/Port Groups>Port Groups** tab.



Name	Instance	Dot1dIndex	Status	Default Role	Alias	Stats	Port Type	Neighbor	Port Speed	VLANs	Description	Port Type Details	Serial Num
Slot 0 [6 ports]											1G587-09 Enterasys N...		04110811210B
1	1	0	Down (Admi...				Unknown				1		
2	2	0	Down (Admi...				Unknown				2		
3	3	0	Down (Admi...				Unknown				3		
4	4	0	Down (Admi...				Unknown				4		
5	5	0	Down (Admi...				Unknown				5		
6	6	0	Down (Admi...				Unknown				6		
Container 2 [2 ports]											1G-2TX Enterasys Net...		
Container 3 [8 ports]											1H-8FX Enterasys Net...		
Logical Ports [2 ports]													
Other Components											Fans and Power, etc		

### Name

Name of the port, constructed of the name or IP address of the device and either the port index number or the port interface name.

### Instance

Shows the instance for the port.

### Dot1dIndex

The index value assigned to the port interface.

### Status

Shows the status (Up, Down, or Unknown) of the port.

### Default Role

Displays the default role for the port. To set the default role, select a port, right-click and select Set Default Role. The Roles Selection view appears where you can select the desired default role. See [Default Role](#) in the Concepts topic for information on default roles.

---

**NOTE:** Setting a default role on an ExtremeWireless Controller port that is not yet a VNS, creates a new VNS on the HWC.

---

### Alias

Shows the alias (ifAlias) for the interface, if one is assigned.

### Stats

Displays information about the port, if configured in [PortView](#).

### Port Type

Type of port. Possible values include: Access, CDP, CDP FTM 1 Backplane, FTM 1 Backplane, and Logical.

**Neighbor**

The port to which the port is connected.

**Port Speed**

Speed of the port. Possible values include: 10/100, speed in megabits per second (for example, 800.0 Mbps), Unknown (displayed for logical ports).

**VLANs**

The VLANs to which the port is associated.

**Description**

A description of the port and the device.

**Port Type Details**

Additional information about the type of port.

**Serial Number**

The serial number of the device.

**Retrieve Button**

Retrieves the most recent information about the ports on the device.

---

**Related Information**

For information on related tasks:

- [How to Create a Port Group](#)

# Extreme Management Center Ports (Port Group)

The Ports panel in the Port Groups navigation tree lists the ports in the selected port group. You can also add and remove ports (user-defined port groups only) by right-clicking the Port Group in the left-hand navigation tree. To access this panel, select a port group in the left-panel **Devices/Port Groups > Port Groups** navigation tree.

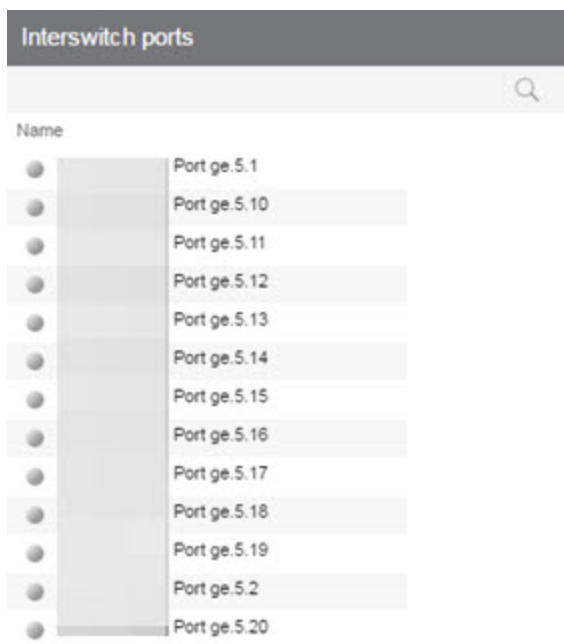

## Name

Name of the port, constructed of the name or IP address of the device and either the port index number or the port interface name.

## Default Role

See [Default Role](#) in the Concepts topic for information on default roles. For additional information, see [Port Mode](#).

## Alias

Shows the alias (ifAlias) for the interface, if one is assigned.

## Port Type

Type of port. Possible values include: Access, Interswitch Backplane, Backplane, Interswitch, and Logical.

### Port Speed

Speed of the port. Possible values include: 10/100, speed in megabits per second (for example, 800.0 Mbps), Unknown (displayed for logical ports).

---

### Related Information

For information on related tasks:

- [How to Configure Ports](#)

For information on related windows:



- [Add/Remove Ports Window](#)
- [Port \(Authentication\) Tab](#)

## Extreme Management Center Details View (Port Groups)

---

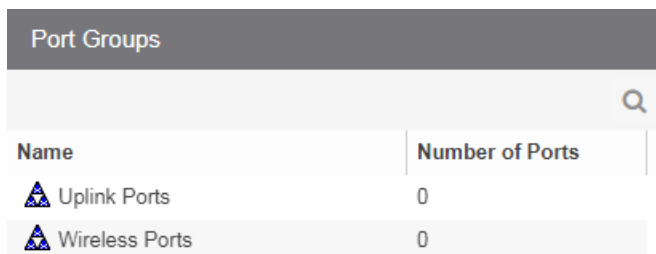
This tab appears when you select the **Devices/Port Groups > Port Groups** left-panel tab. It displays a table of information about the existing port groups.



Name	Number of Ports
 Uplink Ports	0
 Wireless Ports	0

### Name

Name of the port group.

### Number of Ports

Number of ports in the port group.

---

### Related Information

For information on related windows:

- [Details View Tabs](#)

## Extreme Management Center Add/Remove Ports (User-Defined Port Groups)

Use the Add/Remove Ports window to add and remove ports from user-defined port groups.

To access this window, select the left-panel Port Groups tab. Expand the User-Defined Port Groups folder and select a port group. From this window you can:

- Click the **Add/Remove Ports** button in the right-panel **Ports** tab.
- Right-click a Port Group in the left-panel and select **Add/Remove Ports**.

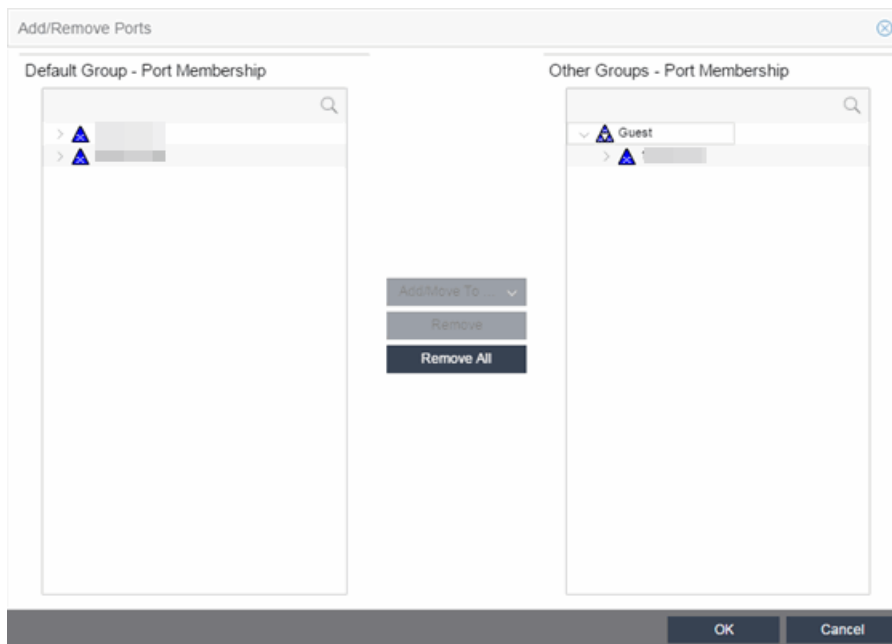

### Default Group — Port Membership

This list displays all the device groups, devices, and port groups in the current domain. [Select](#) the ports you want to add to the port group. You can select individual ports, devices, or groups of ports.

### Other Groups — Port Membership

This field displays all the ports currently defined for the port group. [Select](#) the port you want to remove from the port group.

### **Add/Move To Button**

Click **Add/Move To** and select the port group to add the ports selected in the **Default Group – Port Membership** list to the **Other Groups – Port Membership** list.

### **Remove Button**

Click **Remove** to remove the ports selected in the **Other Groups – Port Membership** list from the port group.

### **Remove All Button**

Click **Remove All** to remove all the ports in the **Other Groups – Port Membership** list.

---

## **Related Information**

For information on related tasks:

- [Adding Ports to a Port Group](#)
- [Removing Ports from a Port Group](#)

## **Add/Remove Ports**

---

In this window, you can add and remove ports to and from port groups. Initially, all ports are grouped into a Default port group. When you create new port groups, you add ports from the Default group into your newly defined port groups using this window.

To access this window, open the **Devices > Port Groups** tab. Then, right-click on the port group to which the ports are being added and select **Add/Remove Ports**. The Add/Remove Ports window opens with the ports in the Default port group displayed in the left panel.

Add ports to the port group by selecting the ports in the left-panel, then selecting the port group in the right panel and clicking **Add To Group**.

---

**NOTE:** User based ports are not listed because user based port groups can only be one default.

---

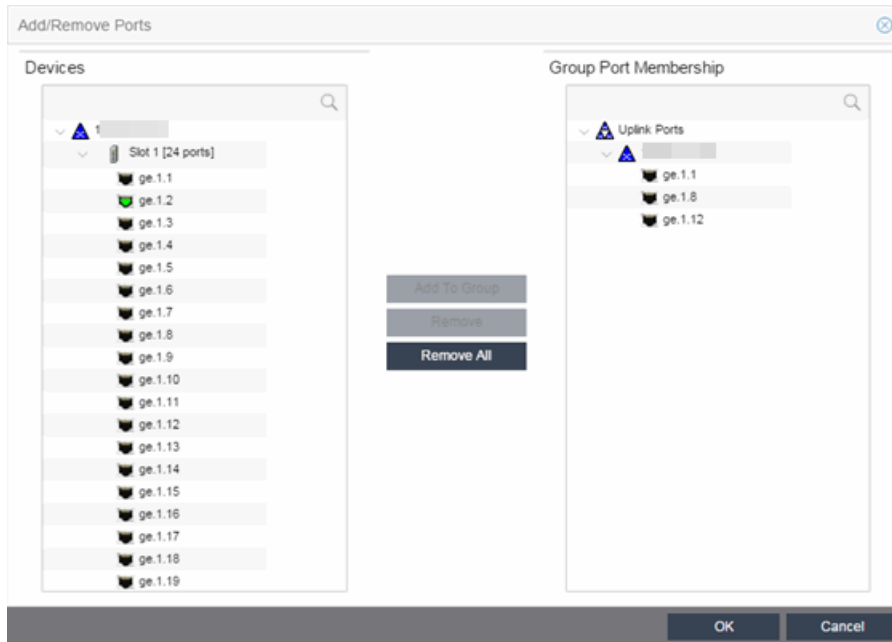

### Devices

This field displays the Devices assigned to the Policy Domain. Ports grouped in the Devices list are not members of the Port Group.

### Group Port Membership

This field displays any port groups you have created and their currently defined ports.

### Add To Group Button

Adds the ports selected under the Devices list to the port group selected on the right.

### Remove Button

Select the ports you want to remove from a port group and click **Remove** to return the ports to the Devices list.

### Remove All Button

Select a port group and click **Remove All** to remove all ports from the port group and return them to the Devices list.

---

## Related Information

For information on related concepts:

- [Getting Started with Class of Service](#)

For information on related tasks:

- [How to Define Rate Limits](#)
- [Creating Class of Service Port Groups](#)
- [How to Configure Transmit Queues](#)



# Extreme Management Center Port Authentication Configuration

The **Port Configuration** tab allows you to configure and change the [authentication](#) settings for a port. Authentication must be configured and enabled on the device in order for individual port authentication settings to take effect. Only those areas of the tab that relate to the authentication type configured on the device are available for editing.

The **Authentication Configuration** tab has six sections:

- [Authentication Mode](#)
- [RFC3580 VLAN Authorization](#)
- [Login Settings](#)
- [Automatic Re-Authentication](#)
- [Authenticated User Counts](#)
- [CEP Access](#)

## Authentication Mode

This section displays general authentication and port mode information about the port.

Authentication Mode	
Port Mode (Auth / Unauth Behavior):	Authentication Optional (Active / Default Role) ▼
MAC Auth Status:	Disabled ▼
802.1X Auth Status:	Enabled ▼
Web-Based Auth Status:	Enabled ▼
Quarantine Auth Status:	Disabled ▼
Auto Tracking Auth Status:	Disabled ▼

## Port Mode

This area displays the current port mode for the port, and allows you to change the settings if desired. Port mode defines whether or not a user is required to authenticate on a port, and how unauthenticated traffic will be handled. It is a

combination of Authentication Behavior (whether or not authentication is enabled on the port), and Unauthenticated Behavior (whether unauthenticated traffic will be assigned to the port's default role or discarded). See [Port Mode](#) for a complete description of each port mode.

In addition, this section provides checkboxes that allow you to disable a specific authentication type at the port level.

### Auth/Unauth Behavior

Select an option to specify how authenticated and unauthenticated traffic is handled on the port. (See [Port Mode](#) for more information.) If you set the port's Authentication Behavior to Active (i.e., you enable authentication for the port), it is recommended that you enable the Drop VLAN Tagged Frames feature.

---

**NOTE:** Authentication Behavior must be set to **Active** for authentication to be allowed using CEP Protocols.

---

Additionally, specify whether unauthenticated traffic is assigned to the port's [default role](#) or discarded. The current default role for the port is shown. For additional information, see [Port Mode](#).

---

**NOTE:** For Single User 802.1X and 802.1X+MAC authentication types:

- Active/Default Role mode requires that a default role be set on the port
- Active/Discard mode requires that any default role set on the port is cleared

For Multi-User Web-based authentication Active/Discard mode is not supported.

---

### MAC Auth Status

Select whether to enable or disable MAC authentication at the port level. If the device is only configured with MAC authentication, selecting this checkbox will result in the port Authentication Behavior being set to Inactive.

### 802.1X Auth Status

Select whether to enable or disable 802.1X authentication at the port level. If the device is only configured with 802.1X authentication, selecting this checkbox will result in the port Authentication Behavior being set to Inactive.

---

**NOTE:** For Single User 802.1X+MAC authentication with Active/Default Role as the selected port mode: Disabling 802.1X authentication also disables MAC authentication on the port. An end user connecting to the port will not be able to authenticate via 802.1X or MAC. The port will behave as if Inactive/Default Role is the selected port mode.

---

### Web-Based Auth Status

Select whether to enable or disable web-based authentication at the port level. If the device is only configured with web-based authentication, selecting this checkbox will result in the port Authentication Behavior being set to Inactive.

---

**NOTE:** For Multi-User Web-Based authentication with Active/Discard as the selected port mode: This checkbox is automatically selected because multi-user web-based authentication does not support the Active/Discard port mode.

---

### Quarantine Auth Status

Select whether to enable or disable Quarantine authentication at the port level. If the device is only configured with Quarantine authentication, selecting this checkbox will result in the port Authentication Behavior being set to Inactive.

### Auto Tracking Auth Status

Select whether to enable or disable MAC authentication at the port level. If the device is only configured with Auto Tracking authentication, selecting this checkbox will result in the port Authentication Behavior being set to Inactive.

### Apply Button

Applies any Port Mode changes to the port.

### CEP protocols in the CEP Access tab

Use the [CEP Access tab](#) to disable CEP protocols at the port level.

## RFC3580 VLAN Authorization Tab

This tab lets you enable or disable RFC 3580 VLAN Authorization on the port and specify an egress state. RFC 3580 VLAN Authorization must be enabled in networks where the RADIUS server has been configured to return a VLAN ID when a user authenticates.

When RFC 3580 VLAN Authorization is enabled:

- ports on devices that do **not** support policy tag packets with the VLAN ID.
- ports on devices that do support policy and also support [Authentication-Based VLAN to Role Mapping](#) classify packets according to the role to which the VLAN ID maps.

You can also enable and disable VLAN Authorization at the device level using the device [Authentication tab](#). If the device does not support RFC 3580, this tab is grayed out.

RFC3580 VLAN Authorization	
VLAN Authorization Status:	Enabled
VLAN Authorization Admin Egress:	Untagged

### VLAN Authorization Status

Allows you to enable and disable RFC 3580 VLAN Authorization for the selected port. This option is grayed out if not supported by the device.

### VLAN Authorization Admin Egress

Allows you to modify the VLAN egress list for the VLAN ID returned by the RADIUS server when a user authenticates on the port:

- None - No modification to the VLAN egress list will be made.
- Tagged - The port will be added to the list with the egress state set to Tagged (frames will be forwarded as tagged).
- Untagged - The port will be added to the list with the egress state set to Untagged (frames will be forwarded as untagged).
- Dynamic - The port will use information returned in the RADIUS response to modify the VLAN egress list. This value is supported only if the device supports a mechanism through which the egress state may be returned in the RADIUS response.

The current egress settings for the port are displayed in the [VLAN Oper Egress column](#) in the **User Sessions** tab. These options are grayed out if not supported by the device.

### Apply Button

Saves any change you made to the VLAN Authorization settings.

## Login Settings

This tab displays the current login settings for the port and allows you to change the settings if desired. The options available depend on what type(s) of authentication are enabled on the device.

Login Settings	
MAC	
Hold time (sec):	0
802.1X	
Hold time (sec):	60
Auth request period (sec):	30
User timeout (sec):	30
Auth server timeout (sec):	30
Handshake requests before failure:	2
Web Auth	
Max requests:	16
Hold time (sec):	60
Quarantine	
Session Timeout (sec):	0
Session Idle Timeout (sec):	0

### Number of Attempts Before Timeout

Number of times a user can attempt to log in before authentication fails and login attempts are not allowed. For web-based authentication, valid values are 1-2147483647, zero is not allowed, and the default is 2. For 802.1X and MAC authentication, this value is permanently set to 1.

### Hold Time (seconds)

Amount of time (in seconds) authentication will remain timed out after the specified Number of Attempts Before Timeout has been reached. Valid values are 0-65535. The default is 60. (Hold Time is also known as Quiet Period in web-based and MAC authentication.)

### Authentication Request Period

For 802.1X authentication, how often (in seconds) the device queries the port to see if there is a new user on it. If a user is found, the device then attempts to authenticate the user. Valid values are 1-65535. The default is 30.

### User Timeout

For 802.1X authentication, the amount of time (in seconds) the device waits for an answer when querying the port for the existence of a user. Valid values are 1-300. The default is 30.

### Authentication Server Timeout

For 802.1X authentication, if a user is found on the port, the amount of time (in seconds) the device waits for a response from the authentication server before timing out. Valid values are 1-300. The default is 30.

### **Port Handshake Requests Before Failure**

For 802.1X authentication, the number of times the device tries to finalize the authentication process with the user before the authentication request is considered invalid and authentication fails. Valid values are 1-10. The default is 2.

### **Quarantine Session Timeout (sec)**

For Quarantine authentication, the maximum number of seconds an authenticated session may last before automatic termination of the session. A value of zero indicates that no session timeout will be applied.

### **Quarantine Session Idle Timeout (sec)**

For Quarantine authentication, the maximum number of consecutive seconds an authenticated session may be idle before automatic termination of the session. A value of zero indicates that the device level setting is used.

### **Auto Tracking Session Timeout (sec)**

For Auto Tracking sessions, the maximum number of seconds a session may last before automatic termination of the session. A value of zero indicates that the device level setting is used.

### **Auto Tracking Session Idle Timeout (sec)**

For Auto Tracking sessions, the maximum number of consecutive seconds a session may be idle before automatic termination of the session. A value of zero indicates that the device level setting is used.

### **Apply Button**

Applies the Login Settings changes to the port.

## **Automatic Re-Authentication**

This tab is grayed out if only web-based authentication is enabled on the device. For 802.1X and MAC authentication, the Automatic Re-Authentication tab lets you set up the periodic automatic re-authentication of logged-in users on this port. Without disrupting the user's session, the device repeats the authentication process using the most recently obtained user login information to see if the same user is still logged in. Authenticated logged-in users are not required to log in again for re-authentication, as this occurs "behind the scenes."

Automatic Re-Authentication	
802.1X Re-auth Status:	Disabled
802.1X Re-auth Frequency (sec):	3600
MAC Re-auth Status:	Disabled
MAC Re-auth Frequency (sec):	3600

### 802.1X Re-auth Status

If **Active** is selected, the re-authentication feature is enabled for 802.1X authentication. If **Inactive** is selected, the re-authentication feature is disabled.

### 802.1X Re-auth Frequency (sec)

How often (in seconds) the device checks the port to re-authenticate the logged-in user via 802.1X authentication. Valid values are 1-2147483647. The default is 3600.

### MAC Re-auth Status

If **Active** is selected, the re-authentication feature is enabled for MAC authentication. If **Inactive** is selected, the re-authentication feature is disabled.

### MAC Re-auth Frequency (sec)

How often (in seconds) the device checks the port to re-authenticate the logged in user via MAC authentication. Valid values are 1-2147483647. The default is 3600.

## Authenticated User Counts

This tab provides authenticated user-count information for devices with Multi-User as their configured authentication type. See the [device Authentication tab](#) for information on setting the device authentication type.

Authenticated User Counts	
Current Number of Users:	0
Number of Users Allowed (up to 8):	8
Number of MAC Users Allowed (up to 8):	256
Number of Quarantine Users Allowed:	256
Number of Auto Tracking Users Allowed:	256

### Current Number of Users

The current number of users actively authenticated or have authentications in progress on this interface. If **Multi-User** authentication is disabled, this number is **0**. Any unauthenticated traffic on the port is not included in this count.

### Number of Users Allowed (up to 2048)

The number of users that can be actively authenticated or have authentications in progress at one time on this interface. If you set this value below the current number of users, end-user sessions exceeding that number are terminated.

---

**NOTE: B2/C2 Devices.** If you are configuring a single user and an IP phone per port, set this value to 2.

---

### Number of MAC Users Allowed (up to 2048)

The number of users that can be actively authenticated via MAC authentication, or have MAC authentications in progress at one time on this interface. The number of MAC users allowed cannot exceed the number of users allowed. If you set this value below the current number of users, end user sessions exceeding that number are terminated. If MAC is not selected as a **Multi-User** authentication type on the [device Authentication tab](#), this field will be grayed out.

### Number of Quarantine Users Allowed (up to 2048)

The number of users that can be actively authenticated via Quarantine authentication, or have Quarantine authentications in progress at one time on this interface. The number of Quarantine users allowed cannot exceed the number of users allowed. If you set this value below the current number of users, end user sessions exceeding that number are terminated. If Quarantine Auth is not enabled on the [device Authentication tab](#), this field will be grayed out.

### Number of Auto Tracking Users Allowed (up to 2048)

The number of Auto Tracking users that can be actively authenticated or have authentications in progress at one time on this interface. The number of Auto Tracking users allowed cannot exceed the number of users allowed. If you set this value below the current number of users, end user sessions exceeding that number will be terminated. If Auto Tracking is not enabled on the [device Authentication tab](#), this field is grayed out.

## Convergence End-Point Access

This tab lists all the CEP (Convergence End-Point) protocols supported by the device on which the port resides, and lets you enable or disable them for that port. For devices that do not support CEP, the tab is blank.

---

**NOTE:** Port Mode Authentication Behavior must be set to **Active** (on the [General sub-tab](#)) for authentication to be allowed using these CEP Protocols.

---



Enable CEP protocols for multiple ports using the [Port Configuration Wizard](#). In addition to enabling protocols on the port, you must also configure CEP for the device on which the port resides. Configure CEP for a single device using the [device Authentication tab \(CEP sub-tab\)](#) or for multiple devices using the [Device Configuration Wizard](#).

Enable	Disable
<input type="checkbox"/>	<input type="checkbox"/>
<b>Status</b>	<b>Name</b>
Disabled	LLDP-MED
Disabled	SIP
Disabled	Generic H323
Disabled	Siemens IP Phone (CorNet IP)
Disabled	Cisco IP Phone

### CEP Access

Lists all the CEP protocols supported by the device on which the port resides. Use the checkboxes to enable or disable CEP protocols on this port. If the device does not support the CEP feature, this area is blank.

### Enable All Button

Selects all the checkboxes and enables all the CEP protocols for this port.

### Disable All Button

Deselects all the checkboxes and disables all the CEP protocols for this port.

### Apply Button

Applies CEP access changes to the port.

---

## Related Information

For information on related tasks:

- [How to Configure Ports](#)
- [Authentication Configuration Guide](#)

For information on related tabs:

- [Port Properties - Port Usage Tab](#)
- [Port Properties - General Tab](#)

## How To Use Extreme Management Center Policy

---

The **How To** section contains Help topics that give you instructions for performing tasks in the **Policy** tab.

### How to Select on Add/Remove Windows

---

The **Policy** tab includes several Add/Remove windows in which you can add items from a left panel to a right panel, and remove items from the right panel. The following procedures explain how to make single and multiple selections in the panels and move the selections to the opposite panel.

Instructions on:

- [Selecting single items](#)
- [Selecting multiple sequential items](#)
- [Selecting multiple non-sequential items](#)

#### Selecting single items

To select one item from the left panel and add it to the right panel, click the item, then click the **Right Arrow** button.

To remove one item from the right panel, click the item, then click the **Left Arrow** button.

#### Selecting multiple sequential items

To select a sequence of items in the left panel and add them to the right panel:

1. Hold down the **Shift** key and click the first and last (or last and first) items in the sequence.
2. Click the **Right Arrow** button.

To remove a sequence of items from the right panel:

1. Hold down the **Shift** key and click the first and last (or last and first) items in the sequence.
2. Click the **Left Arrow** button.

### Selecting multiple non-sequential items

To select multiple non-sequential items in the left panel and add them to the right panel:

1. Hold down the **Ctrl** key and click each item you want to add.
2. Click the **Right Arrow** button.

To remove multiple non-sequential items from the right panel:

1. Hold down the **Ctrl** key and click each item you want to remove.
2. Click the **Left Arrow** button.

### How to Create and Use Domains

---

Extreme Management Center provides the ability to create multiple policy configurations by allowing you to group your roles and devices into Policy Domains. A Policy Domain contains any number of roles and a set of devices that are uniquely assigned to that particular domain. For example, a university may have a Dormitory domain with a policy configuration created for students, and an Administration domain with a policy configuration for staff members.

You can create multiple domains and easily switch from one domain to another. You can also export policy domain configuration data to a .pmd file, (one file per domain) for backup and troubleshooting purposes, and you can import data from a .pmd file into a policy domain.

In order for your network devices to be displayed in the **Policy** tab's left-panel **Devices** tab, they must be assigned to a Policy Domain. Initially, you must use a [device Discover](#) to add your devices to the Extreme Management Center database. Once your devices are in the database, you can assign the devices to a Policy Domain. As soon as the devices are assigned to a domain, they are automatically displayed in the **Policy** tab's left-panel **Devices** tab. Only devices that support policy are displayed.

Extreme Management Center automatically locks the current Policy Domain when you begin to edit the domain configuration. Other users are notified that the domain is locked and they are not be able to save their own domain changes until the lock is released. For more information, see [Controlling Client Interactions with Locks](#). After a modification is made, you must save the domain

to notify all clients that are viewing that domain of the change, and automatically update their view with the new configuration.

Instructions on:

- [Creating a New Domain](#)
- [Opening a Domain](#)
- [Assigning Devices to a Domain](#)
- [Removing Devices From a Domain](#)
- [Importing a File into a Domain](#)
- [Exporting a Domain to a File](#)
- [Importing Data from a Domain](#)
- [Saving a Domain](#)
- [Reading a Domain](#)
- [Renaming a Domain](#)
- [Deleting a Domain](#)

### Creating a New Domain

Use these steps to create a new Policy Domain.

1. Select **Open/Manage Domain > Create Domain**.
2. Enter the name for the new domain. Click **OK**.
3. A new (blank) Domain opens.
4. Select the **Global Domain Settings > Do Not Use Global Services** checkbox if you don't want the domain to include and display services common to all domains.
5. Proceed with [assigning devices](#) to the domain and then configuring the desired policies.

### Opening a Domain

In Extreme Management Center, you work in one current domain at a time. To change to a different domain, use the **Open/Manage Domain > Open Domain** menu to select the desired domain. If you have made changes to the current domain, you are prompted to update the database with the current domain configuration prior to opening the new domain.

### Assigning Devices to a Domain

Initially, you must perform a [device Discover](#) to add a device to the Extreme Management Center database. Once your devices have been added to the database, you must assign the devices to a Policy Domain. A device can exist in only one Policy Domain. As soon as the devices are assigned to a domain, they are automatically displayed in the **Policy** tab's left-panel **Devices** tab. Only devices assigned to the Policy Domain you are currently viewing are displayed in the tab.

Use these steps to assign devices to a Policy Domain.

1. If necessary, [open the domain](#) to which you want to assign devices.
2. Select **Open/Manage Domain > Assign Devices to Domain**. The [Assign Devices to Domain window](#) opens.
3. Devices in the database but not assigned to a domain are listed in the left-panel Unassigned folder (including devices that do not support policy). The left panel also displays any other domains and the devices assigned to those domains. Use the drop-down list to select a single domain or All Other Domains. If you select All Other Domains, use the bottom panel to view the domain to which each device is assigned.  
**Note:** Select the search icon to search for a device. A search box is available to filter through the visible device tree.
4. The right panel displays the current domain and the devices assigned to that domain. To add a device to the current domain, select the device in the left panel and click **Add**. You can also select and add multiple devices.
5. To remove a device from the current domain, select the device and click **Remove**. This removes the device from the current domain and places it back in the device tree as either unassigned or as a member of the domain from which it came. It does not delete the device from the Extreme Management Center database.
6. Click **OK**.
7. The selected devices are assigned to the current domain and displayed in the **Policy** tab left-panel **Devices** tab. (Only devices that support policy are assigned to the domain and displayed.)

### Removing Devices From a Domain

Removing a device from a domain, removes the device from the **Devices** tab and places it in the Unassigned folder in the Assign Devices to Domain window.

**NOTE:** Removing a device from a domain does not delete the device from the Extreme Management Center database. To [delete a device from the database](#), right-click on the device in the left-panel **Devices** tab, and select **Delete** from the menu. When a device is deleted from the database, it is automatically removed from Extreme Management Center and the **Devices** tab.

---

1. If necessary, [open the domain](#) from which you want to remove devices.
2. Select **Open/Manage Domain > Assign Devices to Domain**. The [Assign Devices to Domain window](#) opens.
3. The right panel displays the current domain and the devices assigned to that domain. To remove a device from the current domain, select the device from the Current Domain right-panel and click the left arrow. This removes the device from the current domain and places it back in the device tree as either unassigned or as a member of the domain from which it came. It does not delete the device from the Extreme Management Center database.
4. Click **OK**.

### Importing a File into a Domain

You can import policy data from a PMD file into a Policy Domain.

1. Make sure that the domain you want to import a file into is your current domain.
2. Select **Open/Manage Domain > Import/Export > Import From File**. The [Import from File window](#) opens.
3. Enter the name and path for the data file (PMD) you want to import, or browse to the file. Clicking **Select File**, opens a dialog box from which you can select a data file by searching your local drive or a network drive.
4. Select the specific data elements you want to import or click **Select All** to select all the data import options at once. See [Data Elements to Import](#) for important information on each element and how they are imported.
5. To append, update, or overwrite the global rules with the PMD file you are importing, select the **Global Services & Rules** checkbox.
6. Select how you want the imported data applied to your current domain. Click on the links below for detailed information on how each specific action affects the import of certain data elements.
  - [Append](#) data to existing elements
  - [Update](#) existing data with elements from domain
  - [Overwrite](#) existing elements

7. Click **OK**. The data elements are imported and see a message regarding import status.

### Exporting a Domain to a File

You can export policy data from a Policy Domain to a PMD file.

1. Select **Open/Manage Domain > Import/Export > Export to File**.
2. Select the **Domain** to save as a PMD file.
3. Click **Export**.
4. The Policy Domain is downloaded to the default file download location.

### Importing Data from a Domain

You can import policy configuration data from one policy domain into another.

1. Ensure your current domain is the domain into which you want to import data.
2. Select **Open/Manage Domain > Import/Export > Import From Domain**. (This menu option is not available if only one domain exists, as there are no other domains from which to import data.) The [Import from Domain window](#) opens.
3. Use the drop-down list to select the domain whose data you want to import.
4. Select the specific data elements you want to import or click **Select All** to select all the data import options at once. See [Data Elements to Import](#) for important information on each element and how they are imported.
5. Select how you want the imported data applied to your current domain. Click on the links below for detailed information on how each specific action affects the import of certain data elements.
  - [Append](#) data to existing elements
  - [Update](#) existing data with elements from domain
  - [Overwrite](#) existing elements
6. Click **Import**. The data elements are imported and you see a message regarding import status.

### Saving a Domain

After a Policy Domain has been changed, you must save the domain to notify all clients using that domain of the change and automatically update their tab with the new configuration. An asterisk (\*) is displayed beside the Policy tab title

when you have made changes to the domain that need to be saved. You can save a Policy Domain by selecting **Open/Manage Domain > Save Domain**. To discard unsaved changes you made to a domain, open the **Open/Manage Domains > Open Domain** menu and select the domain in which you are currently working.

### Renaming a Domain

You can rename the current Policy Domain by selecting **Open/Manage Domain > Rename Domain** and entering a new name.

### Deleting a Domain

You can delete one or more Policy Domains by selecting **Open/Manage Domain > Delete Domain**.

---

## Related Information

For information on related tasks:

- [How to Add and Delete Devices](#)

For information on related windows:

- [Assign Devices to Domain Window](#)
- [Import from Domain Window](#)
- [Import from File Window](#)

## How to Create a Role

---

A [role](#) is a policy profile consisting of a set of network access services that you can apply at various access points in a policy-enabled network. A port takes on a user's role when the user authenticates.

Creating a role using the role tabs consists of creating a name for the role with the **Create Role** menu option, then defining its characteristics (default class of service, default access control, and/or services) using the role's right-panel tabs. You might also use this method if you are creating a role for which there is default class of service and/or access control, but no services.



If you want to change the characteristics of a role, you can select the role in the left panel and use the right panel to modify it.

Instructions on:

- [Using the Role Tabs](#)
- [Modifying a Role](#)
- [Deleting a Role](#)

### Using the Role Tabs

Creating a role using the **Role** tab consists of creating a name for the role, then using the right panel to specify the characteristics of the role (default class of service, default access control, and/or services).

1. In the **Policy** tab left panel, select the **Roles/Services > Roles** tab.
2. Right-click the **Roles** tab, and select **Create Role**.  
The Create window opens.
3. Type the role name in the highlighted box. The name can be up to 64 characters in length, and special characters are allowed, with the exception of colons (:) and semicolons (;). Duplicate names are not allowed, regardless of case. For example, if you already have a role `Faculty` and you attempt to name the new role `Faculty` or `faculty`, the **Policy** tab creates the role, but with the name `New Role`, or `New Rolen` (where *n* is the sequence number, if there is more than one `New Role`). You can then rename the new role. Press **Enter** after you've entered the name. (If you don't press **Enter**, the name remains `New Role`.)
4. Select the role in the left panel, and the [role opens](#) in the right panel. Use the right panel to add a role description, enable TCI Overwrite, and set the role's default actions (including access control and class of service).
5. In the Services section in the [right panel](#), click the **Add/Remove Services** button to add services to the role. This opens the role [Add/Remove Services](#) window.

---

**NOTE:** The **Policy** tab checks for rule conflicts when more than one service is added. See [Conflict Checking](#) for more information.

---

6. To add a VLAN to the Role's Egress list, select the role and use the [VLAN Egress tab](#) in the right panel.

7. To configure MAC, IP, and VLAN to role mapping lists for the role, select the role and use the [Mappings tab](#) in the right panel.
8. Now that you have created the role, you can:
  - [Assign the role as the default role for a port](#)
  - [Modify the role's characteristics](#)
9. [Enforce](#) to write the new information to the devices.

### Modifying a Role

Once you've created a role, you can change its characteristics by selecting the role in the Policy tab's left panel and using the associated tabs in the right panel.

Instructions on:

- [Adding Services to Roles](#)
- [Modifying a Role's Default Class of Service](#)
- [Modifying a Role's Default Access Control](#)
- [Modifying a Role's Description](#)
- [Modifying a Role's Ports](#)
- [Removing Services from Roles](#)

### Adding Services to Roles

To add services to roles:

1. Select the left panel **Roles/Services > Roles** tab and expand the **Roles** tab. Select the role to which you want to add services in the left panel, then select the [General tab](#) in the right panel.
2. Click **Add/Remove Services**. This opens the [Add/Remove Services window](#).
3. Make sure the role to which you wish to add services is displayed in the Role selection box.
4. In the Groups and Services panel, [select](#) the services and/or service groups you wish to add to the role, and click the **Right Arrow** button. To remove services, select them in the Selected Services panel and click the **Left Arrow** button.

---

**NOTE:** The Policy tab checks for rule conflicts when more than one service is added. See [Conflict Checking](#) for more information.

---

5. If you wish, you can select another role, and add or remove services from it.
6. Click **OK**.
7. [Enforce](#) to write the new information to the devices.

### Removing Services from a Role

1. Select the left panel **Roles/Services > Roles** tab and expand the Roles folder.
2. Select the role from which you want to remove services, then select the [General tab](#) in the right panel.
3. Click **Add/Remove Services**. This opens the [Add/Remove Services window](#).
4. Make sure the role from which you wish to remove services is displayed in the Role selection box.
5. In the Selected Services panel, [select](#) the services and/or service groups you wish to remove from the role, and click the **Left Arrow** button. To add services, select them in the Groups and Services panel and click the **Right Arrow** button.
6. If you wish, you can select another role, and remove services from or add services to it.
7. Click **OK**.
8. [Enforce](#) to write the new information to the devices.

### Modifying a Role's Default Class of Service

Use the role's [General tab](#) to change its default class of service settings. Be sure to [enforce](#) to write the new information to the devices.

### Modifying a Role's Default Access Control

Use the role's [General tab](#) to change its default access control. Be sure to [enforce](#) to write the new information to the devices.

### Modifying a Role's Description

You can edit the description for the role on the role's [General tab](#). Click **OK** to save the change to the database.

## Modifying a Role's Ports

You can select a port and choose the default role on the [Ports tab](#). You can also select **PortView** to open the PortView for the port or make changes to the port settings themselves.

1. In the **Policy** tab left panel, select a device in the **Devices** left-panel tab.
2. Select the port on which you want to set a default role.
3. Right-click the port and select **Policy > Set Default Role**.
4. Click the **Assign/Replace Default Role** checkbox. The drop-down menu is available.
5. Select the default role for the port from the drop-down menu.
6. Click **OK**.
7. [Enforce](#) to write the new information to the devices.

## Mapping a Role to an HTTP Redirect Group

The HTTP Redirect action allows the role/rule to be mapped to an HTTP Redirect group index. The action widgets contain a menu to edit the group configuration.

## Deleting a Role

1. In the **Policy** tab left panel, select a device in the **Devices** left-panel tab.
  2. Select the port on which you want to delete the default role.
  3. Right-click the port and select **Policy > Set Default Role**.
  4. Click the **Clear Default Role** checkbox.
  5. Select the default role for the port.
  6. Click **OK**.
  7. [Enforce](#) to write the new information to the devices.
- 

## Related Information

For information on related concepts:

- [Traffic Classification Rules](#)

For information on related tasks:

- [Assigning Default Roles to Ports](#)
- [Clearing Default Roles from Ports](#)
- [How to Make Selections on Add/Remove Windows](#)
- [How to Assign a Default Role to a Port](#)

For information on related windows:

- [Add/Remove Services Window](#)
- [General Tab \(Role\)](#)

### How to Assign a Default Role to a Port

---

In the **Policy** tab, you can specify a default role for the port. To configure ports you use the Set Default Role window.

#### Assigning and Clearing a Default Role

Configuring a port allows you to set the port mode, establish login settings, set the default role, and enables you to view the current configuration on the port.

- [Assigning Default Roles to Ports](#)
- [Clearing Default Roles from Ports](#)

#### Assigning Default Roles to Ports

---

**NOTE:** Setting a default role on an ExtremeWireless Controller port that is not yet a VNS, creates a new VNS on the wireless controller.

---

1. Select a device in the left-panel **Devices** tab and expand a slot or ports grouping in the right-panel Details view.
2. Right-click the desired port and select **Policy > Set Default Role** from the menu. The Set Default Role window opens.
3. Click **Assign/Replace Default Role** and select a role in the drop-down menu.
4. Click **OK**.

#### Clearing Default Roles from Ports

You can clear the default role from a single port, or from multiple ports.

1. Select a device in the left-panel **Devices** tab and expand a slot or ports grouping in the right-panel Details view.
2. Right-click the desired port and select **Policy > Set Default Role** from the menu. The Set Default Role window opens.
3. Click **Clear Default Role**.
4. Click **OK**.

---

**NOTE:** If you are replacing the current default role with another one, you don't need to clear the current default role. Selecting the new default role and clicking **OK** clears the previous default role automatically.

---

### How to Create a Quarantine Role

---

The Quarantine role is a highly restrictive role used to isolate users and restrict network access.

The Quarantine role is used in conjunction with the Extreme Networks Intrusion Prevention System (IPS) to create an automatic response to threats detected on the network. Once the Quarantine role has been enforced to the network and the Extreme Networks IPS is properly configured, this role can be automatically set as the default role on any port where a threat has been detected. Normally, roles are applied to ports via authentication.

You can also set the Quarantine role as a port's default role if, for example, you have modified the role to provide some limited access and you want to use it as a "guest" role.

The **Policy** tab default domain includes the Quarantine role. However, if you add a new domain, you need to create the Quarantine role. For information on how to create a role, see [How to Create a Role](#).

After you have created the role, you can modify the role's default class of service and access control settings, and make changes to the role's services and rules using the right-panel tabs, just like any other role. If you make any changes to the Quarantine role, keep in mind that the role may be used by other applications and should remain highly restrictive in nature.

**Instructions on:**

- [Modifying the Quarantine Role](#): Use the right-panel tabs to modify the Quarantine role's default values and add or remove services.
- [Setting the Quarantine Role as the Default Role on a Port](#): Use the right-panel General tab or the Port Configuration wizard to set the Quarantine role as a default role on a port.

### Modifying the Quarantine Role

Once you've created a Quarantine role, you can change its characteristics by selecting the role in the **Policy** tab's left panel and using the associated tabs in the right panel.

---

**NOTE:** You cannot rename the Quarantine role.

---

### Modifying Default Values

Use the [General tab](#) to change the Quarantine role's default class of service and default access control settings, and to add or edit a description.

1. Select the Quarantine Role in the left-panel **Roles** tab.
2. In the right-panel **General** tab, select the desired default class of service and default access control settings.
3. If desired, add or edit the role's description.
4. Be sure to perform an [Enforce](#) to write the new Quarantine role to the devices.

### Adding/Removing Services

Use the [General tab](#) to add or remove services to the Quarantine role.

1. Select the Quarantine Role in the left-panel Roles tab.
2. In the right-panel General tab, click **Add/Remove Services**. This opens the [Add/Remove Services window](#).
3. Make sure the Quarantine role is displayed in the Role selection box.
4. Select the service or service group in the All Services & Service Groups and click the **Right Arrow** button to add them to the Selected Services & Service Groups list. To remove services, select them in the Selected Services & Service Groups list and click the **Left Arrow** button. To remove all services, click the **Double Left Arrow** button.

**NOTE:** The **Policy** tab checks for rule conflicts when more than one service is added. See [Conflict Checking](#) for more information.

---

5. Click **OK**.
6. Be sure to perform an [Enforce](#) to write the new Quarantine role to the devices.

### Setting the Quarantine Role as the Default Role on a Port

There may be circumstances when you would like to use the **Policy** tab to assign the Quarantine role as the default role on one or more ports. For example, if you have modified the Quarantine role to provide limited access, you may want to use it as the default role for guest users on your network.

The Quarantine role is assigned as a default role just like any other role. Refer to [Assigning Default Roles to Ports](#) for instructions.

---

### Related Information

For information on related tasks:

- [Assigning Default Roles to Ports](#)

For information on related windows:

- [Add/Remove Services Window](#)
- [General Tab \(Role\)](#)



### How to Create a Service

---

Services are sets of [rules](#) that define how network traffic for a particular network service or application should be handled by a network access device. A service might consist of only one rule governing, for example, email priority, or it might consist of a complex set of rules combining class of service, filtering, rate limiting, and access control (VLAN) assignment. Extreme Management Center policy allows you to create Local Services (services unique to the current domain) and Global Services (services common to all domains). Global Services let you easily create and manage services shared between all your domains.

Services can be one of two types: Manual Service or Automated Service.



- **Manual Service**  — This service consists of one or more [traffic classification rules](#) you create based on your requirements. Manual services are good for applying customized sets of rules to roles.
- **Automated Service**  — This service automatically creates a rule with a specified action (class of service and/or access control), for each device in a particular network resource group or groups. You create a network resource group using a list of MAC or IP addresses, and then associate the group with the Automated service (see [How to Create a Network Resource](#) for more information). Automated rule types include Layer 2 MAC Address rules, Layer 3 IP Address and IP Socket rules, and Layer 4 IP UDP Port and IP TCP Port rules.

To create a service using the service tabs, right-click the Services tab and select **Create Service**. If you are creating a Manual service, you can then use the Create Rule menu option and the tabs for the rule to define the rules for the service. You can also use the service tabs and rule tabs to modify an existing service and its rules.

Once you've created a service, you can apply it to any number of [roles](#) in the **Policy** tab. A role may utilize both Manual and Automated services.

Instructions on:

- [Using the Service Tabs](#)
- [Modifying a Service](#)
- [Deleting a Service](#)

### Using the Service Tabs

The following steps depend on whether you are creating a [Manual](#) or an [Automated](#) service. For an Automated service, you create the service, select the newly created service, and define the class of service and/or access control for the service in the right-panel. For a Manual service, you create the service and then use the Create Rule menu option and the tabs for the rule to define the rules for the service.

### Creating an Automated Service

1. In the left panel, select the **Service Repository** tab.

2. Expand either the **Local Services** tab or the **Global Services** tab depending on whether you want the service to be local (unique to the current domain) or global (shared between all your domains).
3. Right-click on the **Services** tab and select **Create Automated Service**. A New Service item is created in the left panel in a highlighted box.
4. Type the service name in the Create window. The service name is case-sensitive; therefore, Extreme Management Center policy sees `Engineer` and `engineer` as two different service names. Click **OK**. If you don't do this, the name remains `New Service`. The right-panel displays the service you created.
5. Define the rule's traffic description and actions, and enter a description of the service, if desired. For information on configuring the fields on this tab, see the [Automated Service window](#) Help topic.
6. [Enforce](#) to write the new information to your devices.

### Creating a Manual Service

1. In the left panel, select the **Service Repository** tab.
2. Expand either the **Local Services** tab or the **Global Services** tab depending on whether you want the service to be local (unique to the current domain) or global (shared between all your domains).
3. Right-click on the **Services** tab and select **Create Service**. A New Service item is created in the left panel in a highlighted box.
4. Type the service name in the Create window. The service name is case-sensitive; therefore, the Policy view sees `Engineer` and `engineer` as two different service names. Click **OK**. If you don't do this, the name remains `New Service`. The service is created.
5. Define rules for the service. For more information, see [Using the Rule General Tab](#).

---

**NOTE:** When you add more than one rule to a service, Extreme Management Center checks for conflicts with other rules in the service. See [Conflict Checking](#) for more information.

---

6. [Enforce](#) to write the new information to your devices.

### Modifying a Service

Once you've created a service, you can change its characteristics by selecting the service or its rules in the left-panel **Services** tab and using the menu options or associated right-panel tabs.

- [Modifying a Service Description](#)
- [Modifying a Service Name](#)
- [Modifying the Roles for a Service](#)
- [Modifying the Rules for a Manual Service](#)
- [Modifying an Automated Service](#)

### Modifying a Service Description

You can edit the description for the service by selecting it and clicking the **Edit** button beside the **Description** field in the right-panel. Enter a description in the Edit Description window and click **Save** to save the change to the database.

### Modifying a Service Name

1. In the left panel, select the **Service Repository** tab.
2. Expand the **Local** or **Global Services** tab and then the **Services** tab, and select the service you want to modify.

---

**NOTE:** If the service is a member of a service group and it's more convenient, you can find the service under the service group in the Service Groups folder. Any change you make to the name there are also reflected in the **Services** tab.

---

3. Right-click the service whose name you want to change, and select **Rename**.
4. Type the new name in the Rename window.
5. Click **OK** to save the change to the database.

### Modifying the Roles for a Service

You can see all the roles associated with a particular service in the Role/Service Usage window.

1. In the left-panel **Roles** tab, select the Role to which you are adding or removing a service.
2. Click the Add/Remove button in the Services section of the window to open the [Add/Remove Services window](#).
  - Add a service by selecting it from the All Services & Service Groups column and moving it to the Selected Services & Service Groups column by clicking the right arrow.

- Remove a service by selecting it from the Selected Services & Service Groups column and moving it to the All Services & Service Groups column by clicking the left arrow.
3. Click **OK** to save the changes.
  4. [Enforce](#) to write the new information to your devices.

### Adding a Service to Roles

A newly created service can be added to multiple roles at once using the Add to Role(s) menu.

1. In the left panel, select the **Roles/Services** drop-down menu.
2. Right-click the service or service group(s) and select **Add to Role(s)**.
3. Select one or more Roles to add to the selected Service/Service Group(s) to.
4. Click **OK** to save the changes.

### Modifying the Rules for a Manual Service

1. Select the left-panel **Services** tab and locate the service you want to modify.

---

**NOTE:** If the service is a member of a service group and it's more convenient, you can find the service under the service group in the **Service Groups** tab. Any change you make to the rule there will also be reflected in the **Services** tab.

---

2. Select the service to display its rules.
3. Select the rule you want to change, then use the right-panel tabs to make your changes.
4. [Enforce](#) to write the new information to your devices.

### Modifying an Automated Service

1. Open the left-panel **Services** tab.

---

**NOTE:** If the service is a member of a service group and it's more convenient, you can find the service under the service group in the **Service Groups** tab. Any change you make to the service there are also reflected in the **Services** tab.

---

2. Select the service you want to modify. The [Automated Service window](#) opens in the right panel.

3. Modify the characteristics of the Automated service as required.
4. [Enforce](#) to write the new information to your devices.

### Deleting a Service

Deleting a service removes the service and its rules. If copies of the rules exist for other services, those copies are not affected by the deletion. However, deleting the service removes it from any service groups and roles with which it was associated, so be sure the service is not needed before you delete it. Deleting a Global service deletes the service from all your domains.

1. Select the left-panel **Roles/Services > Service Repository** tab.
2. Expand the **Services** tab in either the **Local Services** or **Global Services** tab, depending on the type of service you are deleting.

---

**NOTE:** If the service is a member of a service group and it's more convenient, you can find the service under the service group in the **Service Groups** tab. Any change you make to the service there are also reflected in the **Services** tab.

---

3. Right-click the service you want to delete, and select **Delete**.
  4. Click **Yes** to confirm, then **OK** to clear the confirmation message.
  5. [Enforce](#) to write the change to your devices.
- 

### Related Information

For information on related concepts:

- [Traffic Classification Rules](#)

For information on related tasks:

- [Adding Services to Roles](#)
- [Adding Services to Service Groups](#)
- [Creating Service Groups](#)
- [How to Create a Class of Service](#)
- [How to Create a Network Resource Group](#)
- [How to Create or Modify a Rule](#)
- [How to Define a Rate Limit](#)

For information on related windows:

- [Details View Tabs](#)
- [Automated Service Tab](#)

### How to Create a Service Group

---

Extreme Management Center Policy lets you create service groups into which you can group Local and Global [services](#). A service group can contain any number of services, as well as other service groups. A service can be a part of more than one group.

Instructions on:

- [Creating a Service Group](#)
- [Adding Services to a Service Group](#)
- [Removing Services from a Service Group](#)

#### Creating a Service Group

1. In Extreme Management Center, select the **Control** tab.
2. Open the **Policy** tab and select **Roles/Services > Service Repository** left-panel tab. Expand the **Local Services** or **Global Services** tab.
3. Right-click on the Service Groups folder and select **Create Service Group**. This opens the Create window where you can enter a name for the new service group.
4. Type the service group name in the highlighted box and click **OK**. You can now [add services](#) to the service group. Once a service group has been created at the top level under the Service Groups folder, it can be added to another service group.

#### Adding Services to a Service Group

A service group can contain any number of services, as well as other service groups. You can add services to a service group by

1. Right-click the service group from which you wish to remove services, and select **Add/Remove Services**.
2. In the [Add/Remove Services window](#), select the services or service groups you want to add to the service group, and click the **Right Arrow** button.
3. Click **OK**.

### Removing Services from a Service Group

Use the following steps to remove a service or service group from a service group. Removing a service from a service group does not delete the service itself. If you want to delete the service itself, see [Deleting a Service](#). Keep in mind that if you change the contents of a service group, Extreme Management Center automatically updates the services list for any role that the service group is associated with, affecting the rules in the role.

1. Right-click the service group from which you wish to remove services, and select **Add/Remove Services**.
  2. In the [Add/Remove Services window](#), select the services or service groups you want to remove from the service group, and click the **Left Arrow** button.
  3. Click **OK**.
- 

### Related Information

For information on related tasks:

- [How to Create a Service](#)
- [Deleting a Service](#)

For information on related windows:

- [Add/Remove Services \(Roles\) Window](#)

### How to Create or Modify a Rule

---

Traffic Classification rules allow you to assign a class of service and/or access control (VLAN membership) to network traffic, depending on the traffic's classification type. Classification types are based on layers 2, 3, and 4 of the OSI model, and traffic is classified according to specific layer 2/3/4 information contained in each frame. For more information, see [Traffic Classification Rules](#).

A rule has two main parts: Traffic Description and Actions. The Traffic Description identifies the type of traffic to which the rule pertains. Actions specify whether that traffic is assigned class of service, access control, or both.

In order to create a rule, you must first [create a service](#) with which to associate it.

**Instructions on:**

- [Creating a Rule](#)
- [Disabling/Enabling a Rule](#)
- [Deleting a Rule](#)

### Creating a Rule

When you create a rule using the [Rule tab](#), you first create and name the rule using the **Create Rule** menu option, then define its characteristics in the right panel. You can also use the right panel to modify an existing rule's characteristics.

1. In the **Policy** tab left panel, select the **Roles/Services > Service Repository** tab.
2. Expand either the **Local** or **Global Services** folder, depending on whether the rule is going to be used locally or by all users.
3. Expand either the **Service Groups** or **Services** folder and click on the service for which you want to create a rule.
4. Right-click on the service and select **Create Rule**.
5. In the [Create Rule window](#), enter a name for the rule and select the rule type. Click **OK**. The rule is created in the left-panel tree.
6. Select the rule to and use the associated right-panel **Rule** tab to define the rule. Refer to the [Rule tab](#) Help topic for information on configuring the rule.
7. [Enforce](#) to write the new information to the devices.

### Disabling/Enabling a Rule

In the **Policy** tab, you can disable and enable individual or multiple rules. You can also disable and enable all the rules associated with a service, or all the rules for all the services in a service group. The rule icon in the left panel displays a red X if the rule is disabled.

Disabling a rule is an alternative to deleting and recreating it. If you disable a rule, it is temporarily unavailable for use by the service with which it is associated. However, the rule can be copied to another service and enabled for that service.

### Disabling/Enabling an Individual Rule

You can enable or disable a rule on the [Rule tab](#) or by right-clicking on the rule in the **Service Repository** tab and selecting **Disable Rule(s)** or **Enable Rule(s)**.



1. In the **Policy** tab left panel, select the **Roles/Services > Service Repository** tab.
2. Expand either the **Local** or **Global Services** folder, depending on whether the rule is going to be used locally or by all users.
3. Expand either the **Service Groups** or **Services** folder and click on the service for which you want to create a rule.
4. Select the rule you want to disable or enable.  
The [Rule tab](#) opens in the right panel.
5. Select **Enable** or **Disable** in the **Rule Status** field. Disabling the rule turns on the red X on the rule icon in the left panel, and re-enabling it turns it off.
6. [Enforce](#) to write the new information to the devices.

### Disabling/Enabling the Rules for a Service or Service Group

If a service is associated with more than one service group, disabling or enabling the rules for the service in one service group will disable/enable the rules for the service in the other service groups of which the service is a part.

1. In the **Policy** tab left panel, select the **Roles/Services > Service Repository** tab.
2. Expand either the **Local** or **Global Services** folder, depending on whether the rule is used locally or by all users.
3. Right-click the service or service group containing the rules you want to disable or enable and select **Disable Rule(s)** or **Enable Rule(s)**.
4. Click **Yes** to confirm the change.
5. [Enforce](#) to write the new information to the devices.

### Deleting a Rule

Deleting a rule removes the rule from a service. If the service is also part of a service group, the rule is deleted there as well, so be sure the rule is not needed before you delete it.

1. In the **Policy** tab left panel, select the **Roles/Services > Service Repository** tab.
2. Expand either the **Local** or **Global Services** folder, depending on whether you are deleting a rule used locally or by all users.
3. Right-click the rule you want to delete, and select **Delete**.
4. Click **Yes** to confirm, then **OK** to clear the confirmation message. The rule is deleted wherever it exists.
5. [Enforce](#) to write the new information to the devices.

### Related Information

For information on related concepts:

- [Traffic Classification Rules](#)

For information on related windows:

- [Edit Rule Window](#)
- [Rule Tab](#)

### How to Define Rate Limits

---

The **Policy** tab allows you to create and define [rate limits](#) as components of a [class of service](#). Rate limits are used to control the transmit rate at which traffic enters and exits ports in your network.

The **Policy** tab uses role-based rate limits that are tied directly to roles and rules, and are written to a device when the role/rule is enforced.

Instructions on:

- [Defining Rate Limits](#)
- [Removing a Rate Limit](#)

### Defining Rate Limits

Rate limits are defined within a class of service and associated with a specific role via a rule action or as a role default. When role-based rate limits are implemented, all traffic on the port that matches the rule with the associated rate limit cannot exceed the configured limit. If the rate exceeds the configured limit, frames are dropped until the rate falls below the limit.

The rate limit remains on the port only as long as the role using the rate limit is active on the port either as the authenticated role or as the port's default role.

1. Open the **Class of Service > CoS Components** left-panel tab on the **Policy** tab.
2. Right-click the **Rate Limits** left-panel tab and select **Create Rate Limit**.
3. Create a new rate limit using the [Rate Limit tab](#).

4. Select the desired CoS and in the **Class of Service** left-panel tab. Select the **View/Edit** button for the appropriate rate limit to open the Create Rate Limit/Shaper window.
5. Fill out the [Create Rate Limit/Shaper](#) window:
  - a. Specify the desired rate limit.
  - b. Select the action you would like performed if the rate limit is exceeded:
    - Generate System Log on Rate Violation — a syslog message is generated when the rate limit is first exceeded.
    - Generate Audit Trap on Rate Violation — an audit trap is generated when the rate limit is first exceeded.
    - Disable Port on Rate Violation — the port is disabled when the rate limit is first exceeded.

---

**NOTE:** N-Series Gold devices do not support rate limit notification.

---

- 
- 
- c. Click **OK**.

The rate limit appears in the CoS Configuration table mapped to the CoS.

Role-based rate limits are written to your devices when you enforce the role that includes them.

## Removing a Rate Limit

Rate limits remain on a port only as long as the role using the rate limit is active on the port either as the authenticated role or as the port's default role. To remove a rate limit, you must delete it from the **Policy** tab and then enforce. This removes the rate limit from any roles with it is associated.

1. Select the **Class of Service > CoS Components > Rate Limits** left-panel tab on the **Policy** tab.
2. In the right-panel table, right-click on the rate you want to remove.
3. Select **Delete**.
4. [Enforce](#).

---

**NOTE:** If you simply select **None** from the drop-down menu, it un-maps the rate from the class of service but it does not remove the rate limit.

---

### Related Information

For information on related concepts:

- [Rate Limits](#)

For information on related tasks:

- [How to Create a Class of Service](#)

For information on related windows:

- [Create Rate Limit Window](#)
- [General Tab \(Rate Limit\)](#)

### How to Create a Class of Service

---

The **Policy** tab lets you define classes of service (CoS) that can include one or more of the following components: an 802.1p priority, an IP type of service (ToS) value, drop precedence, rate limits, and transmit queue configuration.

Initially, the Class of Service Configuration window (available from the **Policy** tab **Class of Service** left-menu tab) is pre-populated with eight static classes of service, each associated with one of the 802.1p priorities (0-7). You can use these classes of service as is, or configure them to include ToS, rate limit, and/or transmit queue values. In addition, you can also create your own classes of service.

After you have created and defined your classes of service, they are then available when you make a class of service selection for a rule action ([Rule tab](#)), a role default ([General tab](#)), or an automated service ([Automated Service window](#)).

It is recommended that you read [Getting Started with Class of Service](#) before creating your classes of service.

Instructions on:

- [Creating a Class of Service](#)
- [Creating Class of Service Port Groups](#)
- [Deleting a Class of Service](#)

## Creating a Class of Service

The basic components for a class of service include an 802.1p priority, an IP type of service (ToS) value, drop precedence, rate limits, and transmit queue configuration.

Use the following instructions to create a new class of service using the [Class of Service Configuration window](#).

1. Open Extreme Management Center and select **Control** tab > **Policy** tab > **Class of Service** left-menu tab.
2. Right-click the **Class of Service** tab tree and select **Create COS** from the menu. The Create window opens.
3. Enter the name for the CoS in the **Name** field and click **OK**. The new class of service opens in the right panel.
4. Click the **Edit** button to enter a description for the CoS.
5. Click the **Edit** button next to the **Transmit Queue** field to open the Edit Transmit Queue window, from which you can select a transmit queue for the class of service. If you would like to select a different transmit queue for each port type, select the **Select Q/Port Type** option. Then, when you click **OK**, a window opens where you can specify a different transmit queue for each port type.
6. Select an 802.1p priority from the drop-down menu to choose the priority (0-7 with 7 being the highest priority).
7. Click the **Edit** button to select the ToS option to associate an IP ToS (Type of Service) value with the class of service, if desired (see [IP Type of Service](#) for more information). Enter a value in the **Type of Service (ToS)** field.
8. Specify a Drop Precedence, if necessary. The Drop Precedence is used in conjunction with the Flex-Edge feature available on K-Series and S-Series (Release 7.11 or higher) devices. Flex-Edge provides the unique capability to prioritize traffic in the MAC chip as it enters the switch. When the Class of Service is assigned to a policy role, and that role is applied to a port via a MAC source address mapping or the port default role, the drop precedence dictates the internal priority (within the MAC chip) that will be used for packets received on the port. If congestion occurs, packets with a high drop precedence are discarded first. Therefore, if a packet is important, it should have a low drop precedence. Refer to the K-Series or S-Series Configuration Guide for more information on the Flex-Edge feature and drop precedence.

9. If desired, use the Rate Limiting/Rate Shaping section to select a port inbound, outbound, and transmit queue rate limit to associate with the class of service. Click **View/Edit** next to the **IRL Port Group Mappings** or **ORL Port Group Mappings** to open the [CoS - Rate Limit Mappings tab](#) of the Rate Limit Port Groups window where you can add, edit, or delete a rate limit. The rate limit you select here applies to all IRL/ORL [port groups](#). Click the **View/Edit** button next to **TXQ Port Group Shapers** field to open the [CoS - Transmit Queue Mappings tab](#) to configure transmit queue mappings.
10. If you have ExtremeWireless Controllers on your network, you see an option to select inbound and outbound user rate limits to associate with the class of service. User rate limits specify the bandwidth given to each individual user on a port. Currently, user rate limits are only available for wireless controllers.
11. Click **Open/Manage Domain > Save Domain**. The class of service is created and is listed in the **Class of Service** tab.

After a class of service has been created, you can double-click in the Class of Service Configuration table to modify its characteristics, if necessary.

### Creating Class of Service Port Groups

The **Policy** tab provides the ability to create rate limit port groups that let you group together ports with similar rate limiting requirements. For example, you might want to create a class of service where your edge ports would receive one rate limit while your core ports would receive a different rate limit. With port groups, you can create a single class of service that assigns a different rate limit to each group.

It also provides the ability to create transmit queue shaper port groups that allow you to isolate certain kinds of sensitive network traffic so that you can give it a high transmit queue priority. For example, ports on a router might be grouped together and configured with a specific rate shaping parameter. A transmit queue port group may contain multiple port queue types (for example, 4-queue ports and 16-queue ports) depending on the type of devices on your network.

Initially, all ports are grouped into a Default port group. When you create new port groups, you add ports from the Default group into your newly defined port groups.

The following instructions are for creating new port groups for an existing class of service.

1. Open the **Class of Service** left-panel tab and select the **Inbound Rate Limit Port Groups**, **Outbound Limit Port Groups**, or **Transmit Queue Port Groups** tab, depending on the type of port group you want to create.
2. Right-click the tab and select **Create Port Group** to create the desired group type: rate limit (RL) port group or transmit queue (TxQ) shaper port group. The Create window opens.
3. Enter a name for the port group and click **OK**.
4. The new port group appears in the **Class of Service** left-panel tab under the appropriate port group type.
5. Right-click on the new port group in the left-panel tab and select **Add/Remove Ports**.
6. The [Add/Remove Ports window](#) opens with the ports in the Default port group displayed in the left panel. Add ports to the new port group by selecting the ports in the left-panel, then selecting the port group in the right panel, and clicking **Add/Move To**. Click **OK** to save the changes and close the window.
7. Click **Save Domain** in the **Open/Manage Domain** drop-down menu.

### Deleting a Class of Service

1. Open the [Class of Service tab](#).
2. Right-click the class of service you want to remove, and select **Delete**.
3. Click **OK** to confirm that you want the class of service removed.
4. Click **Save Domain** in the **Open/Manage Domain** drop-down menu.

---

### Related Information

For information on related tasks:

- [Getting Started with Class of Service](#)
- [How to Define Rate Limits](#)
- [How to Configure Transmit Queues](#)

For information on related windows:

- [Class of Service Tab](#)

## How to Configure Transmit Queues

---

The **Policy** tab allows you to configure transmit queues as a component of a [class of service](#) (CoS).

There are two transmit queue configuration capabilities:

- Transmit Queue Configuration — Allows you to set the transmit queue associated with the class of service.
- TxQ Shaper — Transmit Queue Rate Shapers let you pace the rate at which traffic is transmitted out of a transmit queue.

These two capabilities are configured in the [Class of Service tab](#) available from the **Policy** tab.

For more information, see the section on transmit queues in [Getting Started with Class of Service](#).

Instructions on:

- [Transmit Queue Configuration](#)
- [Transmit Queue Rate Shapers](#)

### Transmit Queue Configuration

Transmit queues represent the hardware resources for each port used in scheduling packets for egressing the device. By default, the static classes of service 0-7 map to transmit queues 0-7. The actual transmit queue number may vary depending on the number of queues supported by the port.

The Priority column in the Class of Service Configuration window displays the actual transmit queues associated with the class of service for each port type. Double-click in the column to see a drop-down menu where you can select a new transmit queue for all port types, or select a different transmit queue for each individual port type.

---

**TIP:** For more detailed information, refer to the tooltip that appears when you hover the cursor over the Queue column.

---



## Transmit Queue Rate Shapers

Rate shapers let you pace the rate at which traffic is transmitted out of a transmit queue. Packets received above the configured rate are buffered rather than dropped. Only when the buffer fills are packets dropped.

The following steps describe how to configure rate shapers in the **Policy** tab:

1. In the **Class of Service** left-panel tab, select the class of service where you want to configure the transmit queue.
2. Click the **Edit** button beside the **Transmit Queue** field and select the desired Transmit Queue from the drop-down menu.
3. Click **Open/Manage Domain > Save Domain** to save the configuration change to the database.

For more information, see the section on transmit queues in [Getting Started with Class of Service](#).

---

**NOTE:** A rate shaper is associated to a specific transmit queue, not a CoS. This means that the 1) you should select the queue you want to use for a CoS first, then set the shaper and 2) all CoS using that queue uses the same rate shaper. Associating a rate shaper to a transmit queue is accomplished via the **CoS - Transmit Queue Mappings** tab. For additional information, see the [CoS - Transmit Queue Mappings Tab \(Transmit Queue Port Group\)](#) Help topic.

---

## Related Information

For information on related concepts:

- [Getting Started with Class of Service](#)

For information on related tasks:

- [How to Create a Class of Service](#)

## How to Define Traffic Descriptions

---

Traffic Classification rules allow you to assign VLAN membership and/or class of service to network traffic based on the traffic's classification type. Traffic descriptions are the part of a rule that defines this classification type. For more information, see [Traffic Classification Rules](#).

The Edit Rule window accessed via the Traffic Description section of the Rule window is used to define traffic descriptions for new rules.

Use the following steps to create a new rule:

1. Open the **Control** tab.
2. Select the **Policy** tab.
3. In the Policy tab left panel, select the **Roles/Services** tab.
4. Open the Service Repository tab and open either the **Local** or **Global Services** tab, depending on the location of the rule being edited.
5. Open either the **Service Groups** or **Services** tab and click on the service for which you want to create a rule.
6. From the menu bar, select **Tools > Create Classification Rule**. You can also right-click on the service and select the option from the menu.  
The Rule opens in the right panel.
7. Click the **Edit** button in the Traffic Description area.  
The Edit Rule window opens.
8. Enter the information for the Traffic Description rule. For additional information, see [Edit Rule window](#).
9. [Enforce](#) to write the new information to the devices.

---

### Related Information

For information on related concepts:

- [Traffic Classification Rules](#)

For information on related tasks:

- [How to Create or Modify a Rule](#)

For information on related windows:

- [General Tab \(Rule\)](#)

### How to Configure Flood Control

---

Flood Control provides rate limiting capabilities to CoS to allow certain types of flooded traffic to be dropped. The flood control traffic types are:

- unknown - unicast
- multicast
- broadcast

When Flood Control is enabled, incoming traffic is monitored over one second intervals. A traffic control rate sets the acceptable flow for each type, specified in packets per second. If, during a one second interval, the incoming traffic of a configured type reaches the traffic control rate on the port, the traffic is dropped until the interval ends. Packets are then allowed to flow again until the limit is reached.

By default, Flood Control is disabled for each CoS. Similarly to CoS Port Groups, a different configuration can be assigned for each group. Since Flood Control is shared across all CoS, once Flood Control is enabled on at least one CoS, those rates apply to all ports that have Flood Control enabled.

### How to Display Flood Control Port Groups on the CoS Components Tab

1. Select the **CoS Components** left-panel tab on the **Class of Service** left-panel tab. The [CoS Configuration tab](#) opens.
2. Verify that the **Flood Control** checkbox is selected.

### How to Create a Flood Control Port Group

1. From the left-panel menu, open the **CoS Components** tab and select the **Flood Control Port Groups** tab.
2. Right-click the **Flood Control Port Groups** tab and select **Create Port Groups**.
3. In the Create window, enter a name for the Flood Control Port Group and click **OK**. A New Flood Control item is added to the CoS Configuration Window.

### How to Enable/Disable Flood Control for a CoS

Flood Control Rate Limits are shared across all CoS. Once a Flood Control rate has been enabled on at least one CoS, that is the rate specified for all Flood Control enabled CoS.

1. Open the **Flood Control Port Groups** tab (**Class of Service > CoS Components** tab) and select a Port Group.
2. Select a rate from the drop-down menu for the desired Flood Control broadcast traffic type Unicast, Multicast, or Broadcast.
3. Select an existing rate or create a new one.

4. Open a CoS in the **Class of Service** left-panel tab, and enable Flood Control for the CoS by selecting the **Enable** in the **Flood Ctrl Status** drop-down menu.

### How to Add/Remove Ports to Flood Control Port Groups

1. From the **Class of Service** left-panel tab, select the **CoS Components > Flood Control Port Groups** tab.
  2. Right-click a Flood Control Port Group, and select **Add/Remove Ports**.
  3. Add or remove the ports in the [Add/Remove Ports window](#).
- 

### Related Information

For information on related concepts:

- [Getting Started with Class of Service](#)
- [Class of Service Configuration Tab](#)

For information on related tasks:

- [How to Create a Class of Service](#)
- [How to Define Rate Limits](#)
- [How to Configure Transmit Queues](#)

For information on related windows:

- [General Tab \(Rate Limit\)](#)
- [General Tab \(Class of Service\)](#)

### How to Create a VLAN

---

The **Policy** tab **VLANs** left-panel tab used for access control are displayed in the Access Control Configuration window. If you have enabled the [Policy VLAN Islands](#) feature, there are two tabs in the VLANs tab: [Global VLANs](#) and [Policy VLAN Islands](#). Otherwise, only the Global VLANs folder is displayed. For more information on Policy VLAN Islands, see [How to Create a Policy VLAN Island](#).

The **Policy** tab provides you with one Global Default VLAN, available when you first access the **Policy** tab. You can create additional VLANs by selecting the **Create VLAN** option available when you right-click on the **Global VLANs** tab.

Once a VLAN is created, you can use it as follows:

- as the default access control for a role, using the role [General tab](#).
- as an access control action for a rule using the [Rule tab](#).
- as an access control action for an automated service, using the [Automated Service tab](#).
- in a Policy VLAN Island, if that feature is enabled.

See [Create VLAN Window](#) and [Roles](#) for additional information.

Instructions on:

- [Creating a VLAN](#)
- [Editing an Island VLAN ID](#)
- [Deleting a VLAN](#)

### Creating a VLAN

1. Open the **Policy** tab.
2. Select the left-panel **VLANs > Global VLANs** tab.
3. Right click the **Global VLANs** tab and select **Create VLAN** from the menu.
4. Fill out the [Create VLAN Window](#) to your specifications.
5. Click **OK** to create the VLAN and close the Create VLAN window.
6. [Enforce](#) to write the new information to the devices.

### Editing an Island VLAN ID

1. Open the **Policy** tab.
2. Expand the **VLANs > Policy VLAN Islands** left-panel tab.
3. Select the **VLANs** tab in the right panel.
4. Select the VLAN with which the policy VLAN island is associated in the VLANs section of the window.
5. Select the Island VLAN in the VLAN Settings section of the window and click **Edit Island VID**.
6. Enter the new VLAN ID and click **OK**.
7. [Enforce](#) to write the new information to the devices.

## Deleting a VLAN

Deleting a VLAN removes it and its associations with any roles and services from the NetSight database and from the devices.

---

**WARNING:** The delete operation immediately removes the VLAN(s) from the devices in the **Devices** tab and could result in serious consequences if the VLANs are used outside the scope of the **Policy** tab.

---

1. Open the **Policy** tab and select the **VLANs** left-panel tab.
  2. Expand the **Global VLANs** left-panel tab.
  3. Right-click on the VLAN you wish to delete and select **Delete** from the menu. A confirmation window opens.
  4. Click **Yes** to delete the VLAN.
  5. [Enforce](#) to write the new information to the devices.
- 

## Related Information

For information on related concepts:

- [Dynamic Egress](#)
- [Policy VLAN Islands](#)

For information on related windows:

- [Create VLAN Window](#)
- [General Tab \(Role\)](#)

## How to Create a Policy VLAN Island

---

VLAN islands enable you to set up, for example, a guest VLAN that restricts the guests in one facility from communicating with guests in another facility. See [Policy VLAN Islands](#) for more information.

Instructions on:

- [Creating a VLAN Island](#)
- [Modifying a VLAN Island](#)

- [Deleting a VLAN Island](#)

### Creating a VLAN Island

You can create a Policy VLAN Island as follows:

**Note:** VLANs used in VLAN islands must be Island VLANs.

1. Open the **Policy** tab and select the **VLANs** left-panel tab.
2. In the left-panel **VLANs** tab, click the **Policy VLAN Islands** tab.
3. In the right-panel, click the [VLANs Tab](#) and click **Create** in the VLANs section.
4. In the **Create VLAN** window, enter a name for the VLAN. Click **OK**.
5. Click **Open/Manage Domains > Save Domain**.

### Modifying a VLAN Island

Once you've created a VLAN island, you can change its characteristics using the right-panel tabs as follows:

- *To change a VLAN island name:* Right-click the island in the VLANs section of the **VLANs > Policy VLAN Islands** and select **Rename**.
- *To change a VLAN island description:* Use the island's [Island Topology tab](#).
- *To edit an Island VLAN ID:* Use the **Edit Island VLAN ID** button on the island's [VLANs tab](#).
- *To change a VLAN Island Configuration (Base ID, Offset, Naming Convention):* Use the **Policy VLAN Islands** tab [Island Topology tab](#) .
- *To add or remove devices from a VLAN island:* Use the VLAN Islands [Add/Remove Devices window](#).

### Deleting a VLAN Island

You cannot delete the Default Island.

1. Open the **Policy** tab and select the **VLANs > Policy VLAN Islands** left-panel tab.
2. Select the VLAN island you want to delete in the VLANs section of the right panel.
3. Right-click the island you want to delete and select **Delete**.
4. Click **Yes** to confirm the deletion.

### Related Information

For information on related concepts:

- [Policy VLAN Islands](#)

For information on related windows:

- [Add/Remove Devices window](#)
- [VLANs Tab \(Policy VLAN Islands\)](#)
- [Island Topology Tab \(Policy VLAN Islands\)](#)

### How to Create a Network Resource

---

Network Resource groups provide a quick and easy way to define traffic classification rules for groups of network resources such as routers, VoIP (Voice over IP) gateways, and servers. You create a network resource group by defining a list of MAC or IP addresses for the resources you want included in the group.

In addition, you can use [Network Resource Topologies](#) to define a different resource list for different groups of devices in your domain. This enables you to set up network resource access based on the location where end users authenticate.

Once a network resource group has been defined, you can associate it with an [Automated service](#) (see [How to Create a Service](#) for more information). The Automated service automatically creates a rule with a specified action (class of service and/or access control), for each resource address in the network resource group. Automated rule types include Layer 2 MAC Address rules, Layer 3 IP Address and IP Socket rules, and Layer 4 IP UDP Port and IP TCP Port rules.

You can also create Global Network Resources shared between all your domains and can be used by global automated services. Network Resource Topologies are not available for Global Network Resources.

---

**TIP:** The Policy tab [Demo.pmd file](#) contains examples of network resource groups that you might want to create, such as Internet Proxy Servers and SAP Servers.

---

### How to Create a Network Resource



1. From the **Policy** tab, select the **Network Resources** left-panel tab.
2. Right-click the Network Resources folder and select **Create Network Resource**. A New Network Resource item is created in the left panel in a highlighted box. (If you want to create a Global Network Resource, click on the Global Network Resources folder.)
3. Type the resource name in the Create window and click **OK**.
4. In the right-panel [General tab](#), use the **Edit** button to add a description of the network resource, if desired.
5. Select the network resource Type:
  - Layer 2 MAC - Define a group of network resources using MAC addresses.
  - Layer 3 IP - Define a group of network resources using IP addresses.
6. Select the appropriate network resource topology. [Network Resource Topologies](#) are used to divide the devices in a domain into groups called islands. You can then define a unique resource list for each island within that topology, allowing user access to resources on the network based on the physical location at which they authenticate. If you are not using topologies to group your devices, select the Domain Wide topology, which contains just one island for all your domain devices.
7. For each topology island included in the selected topology, a tab is available where you can list the resources for that specific island. Use the address field (MAC or IP, depending on the selected type) and click the **Add** button to add a new resource to the list.

Once a network resources group has been created and defined, it can be associated with an Automated service (see [How to Create a Service](#) for more information).

### How to Create a Network Resource Topology

1. From the **Policy** tab, select the **Network Resources** left-panel tab.
2. Right-click the **Network Resource Topologies** left-panel tab and select **Create Network Resource Topology**. A New Network Resource Topology item is created in the left panel in a highlighted box.
3. Type the topology name in the highlighted box.
4. Expand the topology to see the Default Island, which contains all the devices in the domain.

5. Right-click on the topology and select **Create Network Resource Island**. Type in the island name in the highlighted box and click **OK**. Use this step to create all the islands for this topology.
6. Select an island and click the **Add Devices** button to open the Add Devices to Resource Island window, where you can move devices from the Default Island to the islands you just created. Click **Add**.
7. Set any island as the [Default] island for new devices that are added to the domain by right-clicking the island and selecting **Set Default**.

The Network Resource Topology is available for selection when you create your network resources.

---

### Related Information

For information on related tasks:

- [How to Create a Service](#)

For information on related windows:

- [General Tab \(Network Resource Group\)](#)

### How to Add and Delete Devices

---

The Extreme Management Center database contains all the devices in your network and displays them in the left-panel device tree. The **Network** tab and the **Policy** tab share a common view of the device tree, except that only devices that support policy are displayed in the **Policy** tab tree. Any changes you make to the devices are reflected in both trees.

Initially, perform a [device Discover](#) to populate the database. Once devices have been added to the Extreme Management Center database, you must assign the devices to a [Policy Domain](#) using the **Policy** tab. As soon as the devices are assigned to a domain, they are automatically displayed in the **Policy** tab device tree. Only devices assigned to the domain you are currently viewing are displayed. For more information, see [How to Create and Use Domains](#).

After you have initially added your devices, you can use the **Policy** tab's Add Device window to add a single device to the database and the current domain.

Instructions on:

- [Using Console to Discover Devices](#)
- [Using Console to Import Devices](#)
- [Adding a Single Device](#)
- [Deleting Devices from the Database](#)

### Using Console to Discover Devices

Console Discover lets you to discover your network devices and add them to the Extreme Management Center database. You can perform a discover on a specified range of IP addresses, or perform a CDP (Cabletron Discovery Protocol) discover for CDP-compliant devices. Discover automatically explores a specific network segment and creates a list of discovered devices. You can then save all or a subset of the discovered devices to the Extreme Management Center database.

For step-by-step instructions, see the **How to Discover Devices** help topic in your Console online help system.

After devices are added to the database via Console Discover, they must be assigned to a Policy Domain (using the **Policy** tab) before they display in the **Policy** tab tree. Once they have been [assigned to a domain](#), the devices are automatically displayed in the appropriate groups in the **Policy** tab Network Elements device tree.

### Using Console to Import Devices

The Console Import Devices feature imports device information and profiles for unique devices (ones that do not exist locally) from a .ngf file, and adds them to the Extreme Management Center database. For step-by-step instructions, see the **Importing a Device List from a File** section of the **How to Export and Import a Device List** help topic in your Console online help system.

After the devices are imported to the database, they must be assigned to a Policy Domain (using the **Policy** tab) before they display in the Policy tab tree. Once they have been [assigned to a domain](#), the devices are automatically displayed in the appropriate groups in the Policy tab Network Elements device tree.

### Deleting Devices from the Database

When a device is deleted from the Extreme Management Center database, it is removed from all groups where it is a member in both the **Policy** tab and Console device tree (and any other Extreme Management Center plugin applications).

---

**NOTE:** If you want to remove a device from a domain without deleting it from the database, you must use the [Assign Devices to Domain window](#). For more information, see [Removing Devices from a Domain](#).

---

To delete devices from the Extreme Management Center database:

1. Open the **Network** tab, select the device being deleted from the Devices table.
  2. Right-click the device and select **Device > Delete Device** from the menu. A confirmation message advises that you are deleting the device from the Extreme Management Center database.
  3. Click **Yes** to delete the device.
- 

### Related Information

For information on related tasks:

- [How to Create and Use Domains](#)

### How to Create a Port Group

---

The **Policy** tab allows you to group ports into user-defined port groups, similar to the way you can group services into service groups. Port groups enable you to configure multiple ports on the same device or on different devices, simultaneously. A port can be a member of more than one group.

When you create a user-defined port group, you select individual ports to add to the group.

The **Policy** tab also provides you with Pre-Defined Port Groups which are automatically populated according to port characteristics. See [Pre-Defined Port Groups](#) for more information.

Instructions on:

- [Creating a Port Group](#)
- [Adding Ports to a Port Group](#)
- [Removing Ports from a Port Group](#)

### Creating a Port Group

1. In the left panel, click the **Devices > Port Groups** tab.
2. Right-click on the Port Groups folder and select **Create Port Group**. This opens the Create window.
3. Enter a **Name** and click **OK**.

### Adding Ports to a Port Group

You can add ports directly from the port group:

1. Select the left-panel **Devices > Port Groups** tab. Expand the User-Defined Port Groups folder and select a port group.
2. Right-click the port group and select **Add/Remove Ports** from the menu.
3. In the Add/Remove Ports window, select the ports you want to add to the port group in the Devices list and click **Add to Group** to move the port to the Group Port Membership list.
4. Click **OK**.

### Removing Ports from a Port Group

This procedure applies to user-defined port groups.

1. In the left-panel **Devices > Port Groups** tab, right-click the port group from which you wish to remove a port, and select **Add/Remove Ports**.
2. In the Add/Remove Ports window, select the ports you want to remove from the port group, and click **Remove**.
3. Click **OK**.

Alternatively, you can right-click a single port under the port group in the left panel or multiple ports in the right-panel Ports tab, and select **Remove Port(s) from Group**.

---

### Related Information

For information on related windows:

- [Add/Remove Ports Window](#)

## Extreme Access Control

---

The **Access Control** tab provides secure, policy-based management for the Extreme Access Control solution. It configures and manages Extreme Access Control gateways, provides user to device location mapping services, generates network endpoint audit reports and interfaces with other security management applications.

Contact your sales representative for information on obtaining an Extreme Management Center software license.

The **Access Control** tab contains three main navigation trees in the left-panel:

- [Extreme Access Control Engine Groups](#)
- [All Extreme Access Control Engines](#)
- [Extreme Access Control Configurations](#)

### Extreme Access Control Engine Groups

The [Extreme Access Control Engine Groups](#) tree presents groups of Extreme Access Control engines you configure into engine groups. Information for engine groups is organized into four tabs in the right-panel, each showing different information relating to the engine group selected:

- [Details](#) — Displays basic information about the engine group as well as information about how the engines in the group are configured.
- [Switches](#) — Shows the switches monitored by the gateway engines in the group and allows you to add, delete, and edit the switch configuration.
- [End-Systems](#) — Displays end-systems monitored by the Extreme Access Control engines in the selected engine group.
- [Extreme Access Control Engines](#) — Displays the Extreme Access Control engines added to the engine group. Right-clicking an engine in the table displays a menu from which you can configure the engine.

## All Extreme Access Control Engines

The [All Extreme Access Control Engines](#) tree displays all of your Extreme Access Control engines. Selecting an engine displays information in three tabs:

- [Details](#) — Displays basic information about the engine, provides a summary of the interface, and allows you to disable Extreme Access Control authentication and assessment.
- [End-Systems](#) — Displays end-systems monitored by the Extreme Access Control engine.
- [Switches](#) — Shows the switches monitored by the gateway engine and allows you to add, delete, and edit the switch configuration.

## Extreme Access Control Configurations

The Extreme Access Control Configurations tree lets you manage the end-user connection experience and control network access based on a variety of criteria including authentication, user name, MAC address, time of day, and location. Extreme Management Center comes with a default Extreme Access Control Configuration which is automatically assigned to your Extreme Access Control engines. You can use this default configuration as is, or make changes to the default configuration, if desired.

Configure a registration that forces any new end-system connected on the network to provide the user's identity in a web page form before being allowed access to the network. End users are automatically provisioned network access on demand without time-consuming and costly network infrastructure reconfigurations. In addition, IT operations gains visibility into the end-systems and their associated users (e.g. guests, students, contractors, and employees) on the network.

Via the Extreme Access Control Configurations tree, you can also configure agent-less or agent-based security posture assessment of endpoints. The **Access Control** tab uses assessment servers to assess and audit connecting end-systems and provide details about an end-system's patch levels, running processes, anti-virus definitions, device type, operating system, and other information critical in determining an end-system's security compliance. End-systems that fail assessment can be dynamically quarantined with restrictive

network access to prevent security threats from entering the network.

Assisted remediation is a process that informs end users when their end-systems have been quarantined due to network security policy non-compliance, and allows end users to safely remediate their non-compliant end-systems without assistance from IT operations. Once the remediation steps have been successfully performed and the end-system is compliant with network security policy, the appropriate network resources are allocated to the end-system, again without the intervention of IT operations.

## Extreme Access Control Configuration Considerations

---

Review the following configuration considerations when installing and configuring Extreme Management Center Extreme Access Control.

- [Extreme Access Control Configuration Tables](#)
- [General Considerations](#)
- [Considerations When Implementing Policy Roles](#)
- [ExtremeWireless Controller Configuration](#)
- [DNS Proxy Functionality for Registration and Remediation](#)

### Extreme Access Control Configuration Tables

The following tables provide valuable information to help guide you through the deployment of Extreme Networks Extreme Access Control for your network. The first table displays suggested Extreme Access Control configurations to use for different network deployment circumstances (e.g. type of end-systems on the network, network topology, authentication method deployed, etc.). The second table displays details and information for each of the different suggested Extreme Access Control configurations. The information in the tables assumes that DHCP is deployed on the network.



*Suggested Extreme Access Control Configuration for Different Deployments*

Policy/VLAN Switch Configuration	Number of Devices Allowed to Connect to Authentication-enabled Edge Port	Type of End-Systems	Authentication Method Deployed	Switch Support IEEE 802.1X MIB	Switch Support, Session Timeout and Termination Action RADIUS Attributes	Suggested Configuration
- Policy Only (without changing of VLANs)	*	*	*	*	*	A
- VLAN only - Policy and VLAN - Policy Only (with changing of VLANs)	Multiple	Microsoft XP SP1 with KB822596 installed <sup>1</sup>	802.1X <sup>2</sup>	Yes	*	A
- VLAN only - Policy and VLAN - Policy Only (with changing of VLANs)	Multiple	*	802.1X <sup>2</sup>	Yes	*	B
- VLAN only - Policy and VLAN - Policy Only (with changing of VLANs)	Multiple	*	802.1X <sup>2</sup>	No	Yes	C
- VLAN only - Policy and VLAN - Policy Only (with changing of VLANs)	Multiple	*	802.1X <sup>2</sup>	No	No	D
- VLAN only - Policy and VLAN - Policy Only (with changing of VLANs) [for Enterasys switch]	Multiple	*	MAC Authentication	*	*	B
- VLAN only - Policy and VLAN - Policy Only (with changing of VLANs) [for non-Enterasys switch]	Multiple	*	MAC Authentication	*	Yes	C
- VLAN only - Policy and VLAN - Policy Only (with changing of VLANs) [for non-Enterasys switch]	Multiple	*	MAC Authentication	*	No	D
- VLAN only - Policy and VLAN - Policy Only (with changing of VLANs)	Single	Microsoft or MAC OS	*	*	*	E
- VLAN only - Policy and VLAN - Policy Only (with changing of VLANs)	Single	Linux	*	*	*	F
Wireless Device	Multiple	*	*	*	*	G

\* = Any value.

N/A = Not applicable.

<sup>1</sup>For more information on this patch, see the following link: <http://support.microsoft.com/default.aspx?scid=kb;en->

us;KB822596

<sup>2</sup>When 802.1X is implemented to authenticate multiple users on a single switch port, the downstream device providing connectivity to the users must support the forwarding of EAP frames. Unintelligent devices such as repeaters and switches with newer firmware releases should forward EAP frames. However, some switches do not forward EAP frames therefore preventing the 802.1X authentication of multiple users on a single port.

**Extreme Access Control Configuration Details**

Configuration	Port Link Control	Assessing Session Timeout	Assessing Policy Configuration	DHCP Server Configuration Considerations	Other Considerations
A	Disabled	Disabled	*	No	N/A
NOTE: This is the simplest of configurations.					
B	Disabled	Disabled	Initial Scan Only	- Set short lease times (e.g. 1 min) for the unauthenticated, Assessing, and Quarantine VLANs - Normal lease times can be configured for the Accept (Production) VLANs	N/A
NOTES: When an end-system transitions from the unauthenticated, Assessing, or Quarantine VLAN to another VLAN, the end-system will soon renew its IP address via DHCP to automatically re-establish connectivity to the network. When a compliant end-system on the Production VLAN is subsequently quarantined after failing a re-assessment, the end-system's connectivity to the network will be lost until expiration of the DHCP lease for the Accept (Production) VLANs.					
C	Disabled	Enabled	Initial Scan Only	- Set short lease times (e.g. 1 min) for the unauthenticated, Assessing, and Quarantine VLANs - Normal lease times can be configured for the Accept (Production) VLANs	N/A
NOTES: When an end-system transitions from the unauthenticated, Assessing, or Quarantine VLAN to another VLAN, the end-system will soon renew its IP address via DHCP to automatically re-establish connectivity to the network. Furthermore, the end-system will continually reauthenticate to the network while it is being scanned. When a compliant end-system on the Production VLAN is subsequently quarantined after failing a re-assessment, the end-system's connectivity to the network will be lost until expiration of the DHCP lease for the Accept (Production) VLANs.					

Configuration	Port Link Control	Assessing Session Timeout	Assessing Policy Configuration	DHCP Server Configuration Considerations	Other Considerations
D	Disabled	Disabled	Initial Scan Only	- Set short lease times (e.g. 1 min) for the unauthenticated, Assessing, and Quarantine VLANs - Normal lease times can be configured for the Accept (Production) VLANs	Set short reauthentication interval manually on edge switches (e.g. 2 min)
	NOTE: This is not a very scalable configuration model, and therefore should not be implemented for a network with a large number of end-systems.				
E	Enabled	Disabled	*	No	N/A
	NOTE: End-system will be reauthenticated and will renew its IP address via DHCP with link down/up execution.				
F	Enabled	Disabled	Initial Scan Only	- Set short lease times (e.g. 1 min) for the unauthenticated, Assessing, and Quarantine VLANs - Normal lease times can be configured for the Accept (Production) VLANs	N/A
	NOTES: End-system will be reauthenticated with link down/up execution and will automatically re-establish network connectivity via DHCP upon lease expiration of the IP address in the unauthenticated, Assessing, and Quarantine VLANs. When a compliant end-system on the Production VLAN is subsequently quarantined after failing a re-assessment, the end-system will be reauthenticated and will renew its IP address via DHCP with link down/up execution.				
G	Disabled	*	*	*	RFC 3576 Reauthentication Enabled
	NOTES: Extreme Management Center supports RFC 3576 which provides for forced reauthentication (Force Reauth) of end-systems connected to an RFC 3576-capable switch. RFC 3576 defines new RADIUS messaging that allows the Extreme Access Control Gateway to send Disconnect or Change of Authorization (CoA) RADIUS messages to the authenticating switch or AP to force reauthentication on a currently authenticated end-system.				

\* = Any value.  
N/A = Not applicable.

## General Considerations

- Gateway RADIUS Attributes to Send - Send RFC 3580 Only Feature.** This feature (configured in the Add/Edit Switches to Identity and Access Appliance Group panel) lets you specify that an Extreme Access Control Gateway sends a VLAN (instead of a policy) via RFC 3580-defined RADIUS Tunnel attributes to the RFC 3580-enabled switches in your network. Keep in mind the following considerations when configuring this feature:

- **Send RFC 3580 Only is not supported on Matrix E7 Devices.** Matrix E7 devices should not be configured with the "Gateway RADIUS Attributes to Send" parameter set to RFC 3580 Only.
- **Send RFC 3580 Only does not support end-systems with static IP addresses.** The Send RFC 3580 Only feature is not-supported for end-systems with static IP addresses. This is because end-systems transitioned between VLANs must be assigned an IP address on the appropriate subnet to maintain IP connectivity to the network, which is facilitated dynamically through DHCP.
- **Send RFC 3580 Only requires a particular DHCP configuration for Active/Default Role port mode.** When the Send RFC 3580 Only feature is configured, the Active/ Default Role port mode on network devices requires a particular DHCP configuration. The DHCP lease time for the pool of IP addresses that corresponds to the default role's VLAN must be short (e.g. less than 1 minute) because the Active/Default Role port mode allows end-systems to obtain IP addresses via the DHCP protocol before they are authenticated to a VLAN.
- **Switch management fails with Send RFC 3580 Only and certain Auth Access Types.** Switch management via TELNET/WebView fails with the following configuration in the Add/Edit Switches to Identity and Access Appliance Group window:
  - Auth Access Type = "Management Access" or "Any Access"
  - Gateway RADIUS Attributes to Send = "RFC 3580 Only"This is because switches check the "mgmt" attribute in the Filter-ID for Telnet management. To avoid this problem, set the Auth Access Type to "Network Access."
- **Enable Port Link Control Option.** Port link control is required if you are using VLAN only (RFC 3580) switches or if you are using policy with VLANs on policy-enabled switches. When an end-system is transitioned between VLANs with a new VLAN being assigned to a switch port, the end-system is required to obtain a new IP address for the assigned VLAN. To do this, the Extreme Access Control Gateway links down the port (using the ifAdmin MIB), waits the configured amount of time, and then links up the port, causing the end-system to make a new DHCP request and get a new IP address.
  - **Port Link Control is not supported on authentication-enabled switch ports providing connectivity to multiple end-systems.** Do not enable port link control for switches authenticating multiple users per port. When an Extreme

Access Control Gateway is configured to return only the VLAN RADIUS attribute, the gateway links down the authenticated port to force the end-system to release and then renew the DHCP IP address when port link control is enabled. This action interrupts IP connectivity of other authenticated end-systems on the port. If the switch is an Enterasys switch, protection is automatically provided by reading the number of users currently on the port prior to linking down an port.

- **Port Link Control is only supported on Windows XP or later.** Port link control is only supported for end-users that are authenticating from end-systems running Windows XP or later. When an Extreme Access Control Gateway is configured to return only the VLAN RADIUS attribute, the gateway links down the authenticated port to force the end-system to release and then renew the DHCP IP address when port link control is enabled. However, other systems such as NT workstations, do not release their DHCP IP address when the port is linked down. To account for this scenario, disable port link control, set the Extreme Access Control Profile to "Use Assessment Policy During Initial Assessment Only," and set the DHCP lease time for the IP address pools that correspond to the VLAN(s) associated to the Quarantine and Assessing access policies, as well as the default VLAN associated to the unauthenticated state of the port, to a low value (e.g. 1 minute). This forces an end-system to send DHCP Request messages every 30 seconds while it is unauthenticated, being assessed, and quarantined. Upon passing assessment, the end-system is dynamically assigned an IP address on the production VLAN shortly after assessment is complete, establishing connectivity to the network on the production VLAN.
- **Extreme Access Control Gateway DHCP Snooping:**
  - **Option 1: Locate the Extreme Access Control Gateway on the same subnet as the DHCP server.** If the Extreme Access Control engine is in the same subnet (relay router interface) as the end-system, it is able to hear ACK responses from the DHCP server, allowing it to have more accurate DHCP entries unless the relay router (or DHCP server) sends unicast ACK responses directly to the end-system.  
Note: Whether the ACK response is sent using unicast or broadcast is normally determined by how the end-system requests the packet. If the end-system sends out a DHCP discover/request with a unicast bootp flag, then the DHCP server (or relay router) sends the ACK response using unicast. This is typically what happens. Sometimes, the end-system can request the DHCP

discover/request with a broadcast bootp flag set. In this case, the end-system gets the ACK response with broadcast, and the Extreme Access Control engine hears the ACK response if it is in the same broadcast domain.

The benefit of using option 1 over the helper-address implementation described in option 2, is that the helper-address implementation only gets the requests from the end-systems which may or may not have the correct IP address. When an Extreme Access Control Gateway learns a MAC/IP address pair, it sends a message to all other Extreme Access Control Gateways, so only one Extreme Access Control Gateway needs to live on each subnet with a DHCP server on it, to leverage this technique.

- **Option 2: Add the Extreme Access Control Gateway IP address as a helper address on default gateway routers.** To increase the accuracy of the MAP-to-IP resolution, the Extreme Access Control Gateway listens for DHCP traffic on port 67 and saves the MAC/IP address pairs it learns. In order to receive DHCP traffic, the IP address of any Extreme Access Control Gateway must be added as a helper address on default gateway routers on the network. Routers allow multiple IP helper address entries, so the Extreme Access Control Gateway's IP address can be added along with the actual DHCP server IP addresses. When an Extreme Access Control Gateway learns a MAC/IP address pair, it sends a message to all other Extreme Access Control Gateways, so only one Extreme Access Control Gateway IP address needs to be added.
- **Configure RADIUS settings on 3rd-party switches.** You must manually configure the RADIUS settings on your third-party switches communicating to the Extreme Access Control Gateway. In addition, make sure that the shared secret on the switches matches the shared secret you entered in the [Advanced Switch Settings window](#). This is the shared secret the switches uses to communicate with Extreme Access Control Gateways.
- **Configuring Agent-based Assessment Test Sets with Hotfix Checks.** When configuring an Agent-based test set to perform multiple hotfix checks, make sure that the Monitoring Interval is set to at least 5 minutes, so that the assessment agent does not take a lot of CPU cycles trying to monitor these settings.
- **Supported desktop browsers for end-systems connecting through Extreme Access Control.** The following browsers are supported for desktop end-systems connecting to the network through Extreme Networks Extreme Access Control:

- Microsoft Edge and Internet Explorer version 11
- Mozilla Firefox 34 and later
- Google Chrome 33.0 and later
- **Supported mobile browsers for end-systems connecting through Extreme Access Control.** The following browsers are supported for mobile end-systems connecting to the network through the Mobile Captive Portal of Extreme Networks Extreme Access Control:
  - IE11+ (Windows Phone)
  - Microsoft Edge
  - Microsoft Windows 10 Touch Screen Native (Surface Tablet)
  - iOS 9+ Native
  - Android 4.0+ Chrome
  - Android 4.4+ Native
  - Dolphin
  - Opera

---

**NOTES:** A native browser indicates the default, system-installed browser. Although this may be Chrome (Android), this also includes the default, system-controlled browser used for a device's Captive Network Detection. Typically, this is a non-configurable option for Wi-Fi Captive Network Detection, but default Android, Microsoft or iOS devices are tested for compatibility with the Mobile Captive Portal.

A mobile device can access the standard (non-mobile) version of the Captive Portal using any desktop-supported browsers available on a mobile device.

---

- For other browsers, the Mobile Captive Portal requires the browser on the mobile device be compatible with Webkit or Sencha Touch. To confirm compatibility with Webkit or Sencha Touch, open `http://<ip_of_engine>/mobile_screen_preview` using your mobile web browser. If the browser is compatible, the page displays properly.
- **RADIUS Configuration on E1 Devices.** The Extreme Access Control engine opens an SSH/Telnet session on the E1 device and enable RADIUS by running a script of CLI commands. CLI credentials for the device are obtained from the device profile and must be configured in the Authorization/Device Access tool.

- **RADIUS Authentication and Accounting Configuration on ExtremeXOS Devices.** Extreme Management Center uses CLI access to perform RADIUS configuration operations on ExtremeXOS devices. CLI credentials for the device are obtained from the device profile and must be configured in the Authorization/Device Access tool.
- **RADIUS Accounting Configuration on Fixed Switching Devices.** Extreme Access Control uses CLI to configure RADIUS accounting on Enterasys fixed switching devices (A-Series, B-Series, C-Series, D-Series, G-Series, and I-Series). CLI credentials for the device are obtained from the device profile and must be configured in the Authorization/Device Access tool. This does not apply to A4, B5, and C5 devices running firmware version 6.81 and higher. Those devices support RADIUS accounting configuration using SNMP. For more information, see [How to Enable RADIUS Accounting](#).

## Considerations When Implementing Policy Roles

This section describes the communication that takes place between Extreme Access Control engines and end-systems connecting to the network. This communication should be taken into account when defining and deploying policy roles and rules on your network. It is particularly critical because certain policy roles and rules may discard traffic that is necessary for communication between the end-system and the engine. For example, in a Guest policy role, NetBIOS traffic is probably discarded, but doing so could impact the MAC to IP resolution process.

Review the following information and verify that the policy roles and rules deployed on your network will allow the required communication between end-systems and your Extreme Access Control engines.

IP resolution via NetBIOS

MAC Resolution via NetBIOS

Extreme Access Control engine UDP Port 137 <==> End-System Port 137

Remediation and Registration

Extreme Access Control engine (TCP or UDP) Port 80 <==> End-System Port (determined on the client) - HTTP

Extreme Access Control engine (TCP or UDP) Port 443 <==> End-System Port (determined on the client) - HTTPS

Extreme Access Control Agent Discovery via HTTP

Extreme Access Control engine Port TCP 8080 <==> End-System Port (determined on the client)

Extreme Access Control Agent Heartbeat via HTTPS



Extreme Access Control engine Port TCP 8443 <==> End-System Port  
(determined on the client)

Extreme Access Control Agent-less Assessment  
All ports determined by the selected test set.

The following software is optional and may be installed with agent-less  
Assessment:

SAMBA add-on enabled

TCP Ports 149 and 195, and UDP Ports 137 and 138.

End-System Reachability Test (Assessment Configurations - does not apply to  
agent-based assessment)

ICMP Ping Test => ICMP Protocol (1), ICMP Type (8)

TCP Ping Test => Default TCP Ports: 21, 22, 23, 25, 79, 80, 111, 135, 139, 445, 497,  
515, 548, 1025, 1028, 1029, 1917, 5000, 6000, 9100

## ExtremeWireless Controller Configuration

- The NAS IP address used for the wireless controller should be either the management IP address or an IP address of one of its physical data ports, or all zeros to force Extreme Access Control (Extreme Access Control) to use the source IP. If a logical IP address is used, then Extreme Access Control is unable to reauthenticate end-systems.
- If you have configured Assisted Remediation, you must perform the following steps if your network includes wireless controllers:
  - Enable the "ToS override for Extreme Access Control" option configured through Wireless Manager in the Edit WLAN Service > Authentication Mode Configuration > Settings window.
  - If Policy Manager is **not** being used to configure policy on the wireless controller, use Wireless Manager to manually add the following rule to the VNS Quarantine, Assessing, and Unregistered filters to allow HTTP traffic to pass through (IN/OUT) the controller when end-systems are proxied to the Internet during remediation.  
`0.0.0.0/0 tcp port 80 (Allow traffic In/Out)`
  - If Policy Manager **is** being used to configure policy for the wireless controller, use the Classification Rule Wizard to add an "Allow HTTP" rule to a service currently included in your Quarantine, Assessing, and Unregistered policy roles. The rule would be a traffic classification type "IP TCP Port Destination"

with the TCP type set to HTTP (80) and the Access Control set to "Permit Traffic."

## DNS Proxy Functionality for Registration and Remediation

Extreme Access Control (Extreme Access Control) Gateway engines provide DNS proxy functionality for use in networks that are deploying registration and/or remediation, but cannot configure the policy-based routing that is required to redirect network traffic to the web portal. Using DNS proxy, any end-system that needs to be redirected to the remediation and registration web portal has its DNS packets spoofed to direct all web page requests to the Extreme Access Control Gateway engine. This allows networks that do not have a router to deploy registration and remediation.

### Basic Operation

To set up DNS proxy, the Extreme Access Control engine is configured as a secondary DNS server in the DHCP scope, in addition to the primary DNS server on the network. When an end-system is required to register or undergo remediation, access to the primary DNS server is blocked and the end-system sends its DNS requests to the DNS proxy on the Extreme Access Control Gateway engine.

The DNS proxy must determine whether to spoof the packet or forward the request to the primary DNS server. If the end-system is unregistered or quarantined, the DNS proxy spoofs the DNS packet and send back a DNS response to the end-system with the Extreme Access Control engine IP address. This redirects the end-system traffic to the web portal where the end user can register or remediate. Once the end user has registered or remediated their end-system, their DNS requests are forwarded to the primary DNS server.

For third-party devices, a dynamic ACL is configured to block access to the primary DNS server for end-systems undergoing registration or remediation. This causes the DNS requests to be sent to the DNS proxy. The DNS proxy determines whether spoofing is necessary or not by checking the state of the end-system in the database. If the end-system is unregistered or quarantined, the DNS proxy spoofs the DNS packet.

To allow access to hosts or domains for any protocol other than http, you must add the host or domain to the list of [allowed web sites](#) configured in the Network Settings view of the Extreme Access Control Edit Portal Configuration window. The DNS proxy uses this list of allowed domains to determine if the

end-system is allowed access to the requested domain. This can be useful if you want to allow end-systems to perform specific functions such as anti-virus updates or software updates that run over TCP/UDP ports.

You can also define post authorization assessment behavior using DNS proxy. End-systems in the scan state are granted access according to the [assessment settings](#) in your Extreme Access Control profile.

- If an assessment policy is **not** defined, the user is allowed access while being scanned.
- If an assessment policy is defined for initial assessment only, the user is allowed access if they passed the last scan. If the first or last scan resulted in quarantine, the user is redirected to the Extreme Access Control Gateway.
- If an assessment policy is defined for all assessments, the user is redirected to the Extreme Access Control Gateway.

## Backup DNS Server

Because the DNS proxy forwards DNS requests to the primary DNS server, it is important to configure a backup DNS server on your network, in case the primary server is down. The DNS proxy polls the primary DNS server every minute. If the primary server is down, a backup DNS server is used. If both servers are down, all DNS requests forwarded by the DNS proxy are dropped.

## Troubleshooting

DNS proxy error messages are logged in the `/var/log/dnsProxy.log` file on the Extreme Access Control engine. You can enable diagnostics for DNS proxy by going to the Extreme Access Control engine administration web page and enabling the DNS Proxy diagnostic group to provide troubleshooting information. Launch the Extreme Access Control engine administration web page by using the following URL: `https://<Extreme Access ControlengineIP>:8443/Admin`. The default user name and password for access to this web page is "admin/Extreme@pp." Click on the Diagnostics page and then the Server Diagnostics page. View the output in the `/var/log/dnsProxy.log` file or on the Log Files > Server Log web page.

---

## How to Update an Extreme Access Control License

---

This Help topic provides instructions for saving an Extreme Access Control license and applying the license after upgrading to a new Extreme Access Control engine.

the password on the assessment agent adapter on your network assessment servers, including agent-less, Nessus, or a third-party assessment agent (an assessment agent not supplied or supported by Extreme Management Center). The assessment agent adapter enables communication between the Extreme Access Control engine and the assessment servers, and the password is used by the assessment agent adapter to authenticate Extreme Access Control engine assessment requests.

This password must match the password specified in the Extreme Access Control Options as the [Assessment Agent Adapter Credentials](#) (Administration > Options > Identity and Access > Assessment Server). If you change the password on the assessment agent adapter, change assessment agent adapter credentials in the Extreme Access Control options as well, or connection between the engine and assessment servers is lost and assessments is not performed.

To change the assessment agent adapter password:

1. Go to the install directory for the assessment agent adapter on the assessment server. This can be a Nessus server or the Extreme Access Control engine if you are using on-board agent-less assessment. On an Extreme Access Control engine, the install directory is `/opt/nac/saint`.
2. Run the `sha1.sh` script (on an Extreme Access Control engine, the script is located in `/opt/nac/saint/util`) using the new password as the argument. The script produces a hash string that looks something like:  
`9ba2db465ff11b0bdfd188f7ee87b10fc3a145dc`
3. Open the `users.properties` file (on an Extreme Access Control engine, the file is located in `/opt/nac/saint/users.properties`) and replace the existing hash string with the new one:  
`admin=<new string>`

4. Restart the assessment agent adapter. On an Extreme Access Control engine, the command is `ag1sctl restart`.
- 

### **Related Information**

For information on related tasks:

- [How to Install the Assessment Agent Adapter on a Nessus Server](#)
- [How to Set Extreme Access Control Options - Assessment Server](#)

For information on related windows:

- [Manage Assessment Settings Window](#)
- [Extreme Access Control Options - Assessment Server](#)

---

# How to Install the Assessment Agent Adapter on a Nessus Server

---

This document provides instructions to install the Extreme Networks Assessment Agent Adapter software on a Nessus Server. The Assessment Agent Adapter is required for communication between the Extreme Access Control engine and the Nessus server.

---

**NOTE:** As of Extreme Management Center version 8.1, only Nessus Version 6 is officially supported.

---

1. Go to the Network Management Suite (NMS) Download web page to download the Assessment Agent Adapter:  
<https://extranet.extremenetworks.com/downloads/Pages/NMS.aspx>. Select the version of Extreme Management Center you are using.
2. Scroll down to find the Identity and Access Tools section of the web page. The install file is named "Assessment Adapter (for 3rd party assessment integration)". Download the file and copy it to the Nessus server.
3. Open a shell and "cd" to the directory where you downloaded the install file.
4. Change the permissions on the install file by entering the following command at the shell prompt:  

```
chmod 755 EXTRAassessmentServerAgentAdapter_
x.x.x.x.bin
```
5. Run the install program by entering the following command at the shell prompt:  

```
./EXTRAassessmentServerAgentAdapter_x.x.x.x.bin
```
6. The Introduction screen appears. Press **Enter**.
7. Enter Nessus as the agent type to install. Press **Enter**.
8. The Choose Install Folder screen appears where you can choose the installation folder or directory. Enter an absolute path or press **Enter** to accept the default installation folder /root/AssessmentAgent. The installer requires 100 MB of memory. If the installation folder does not have enough memory, an error displays.
9. The Pre-Installation Summary screen appears. This screen shows you the locations you have chosen for the installation process and disk space requirements. Review this information to ensure its accuracy. Press **Enter**.

10. The Nessus Server Information screen appears. You must enter information in several fields in this screen.
11. Enter the port on which the Nessus daemon is running. The default value is 1241. Press **Enter**.
12. Enter the username you created when you installed the Nessus server. Press **Enter**. If you did not create a user when you installed the Nessus server, from a shell prompt, type:

```
cd /nessus_installation_directory/sbin
```

followed by

```
nessuscli adduser username
```

and follow the prompts to add a user to the application. Press **Enter**.
13. Enter the password for the Nessus user. Press **Enter**.
14. The SSL Server Information screen appears. Enter the port on which the HTTPS daemon is running. The default port number is 8445. Press **Enter**. The Assessment Agent Adapter begins installing.
15. If you are upgrading to a newer version of the Assessment Agent Adapter, you are asked if you want to overwrite several files: launchAS.sh, bin/nessus\_cmd, and version.txt. Enter the letter "y" to answer yes and press **Enter**.
16. The Installation Complete screen appears. The installation is complete and the Assessment Agent Adapter has been installed on the server.
17. Start the Assessment Agent Adapter as a background process by entering the following command at the shell prompt:

```
/assessment_agent_adapter_installation_directory/launchAS.sh &
```
18. Make sure that the Nessus daemon and the Assessment Agent Adapter are started each time the system is started, by adding this command into your rc.local script:

```
/assessment_agent_adapter_installation_directory/launchAS.sh &
```
19. To verify the Assessment Agent Adapter is running on the system, from the shell prompt enter:

```
netstat -an | grep port number
```

where port number is the port you entered that has the HTTPS daemon running on it. The default value for this is 8445. Returned entries containing ESTABLISHED or LISTEN is displayed.
20. To verify the Nessus application is running on the system, from the shell prompt enter:

```
ps -eaf | grep nessusd
```

A return entry similar to: "nessusd: waiting for incoming connections" is displayed. This is an indication that the Nessus process is running correctly on the system.

---

### **Related Information**

For information on related tasks:

- [How to Change the Assessment Agent Adapter Password](#)
- [How to Set Extreme Access Control Options - Assessment Server](#)

For information on related windows:

- [Manage Assessment Settings Window](#)
- [Edit Assessment Configuration Window](#)



## How to Deploy Extreme Access Control in an MSP or MSSP Environment

---

This Help topic presents instructions for deploying Extreme Access Control within an MSP (Managed Service Provider) or MSSP (Managed Security Service Provider) environment. It includes the following information:

- [Configuring Extreme Management Center Behind a NAT Router](#)
- [Defining Interface Services](#)

### Configuring Extreme Management Center Behind a NAT Router

If the Extreme Management Center server is located behind a NAT (Network Address Translation) router, use the following steps to add an entry to the nat\_config.text file that defines the real IP address for the Extreme Management Center server. This allows the Extreme Management Center server to convert the NAT IP address received in the Extreme Access Control engine response to the real IP address used by the Extreme Management Center server.

---

**NOTE:** The text in the nat\_config.text file refers to a remote IP address and a local IP address. For this configuration, the NAT IP address is the remote IP address and the real IP address is the local IP address.

---

1. On the Extreme Management Center server, add the following entry to the <install directory>/appdata/nat\_config.text file.  
<NAT IP address>=<real IP address>
2. Save the file.
3. Configure your Extreme Access Control engines to use the NAT IP address for the IP address of the Extreme Management Center server. For information on how to configure or change your engine settings, refer to your Extreme Access Control engine Installation Guide.

If you have remote Extreme Management Center clients connecting to the NAT IP address, perform the following additional steps.

1. On the Extreme Management Center server, add the following text to the <install directory>/appdata/NSJBoss.properties file. In the second to last line, specify the hostname of the Extreme Management Center server.  

```
# In order to connect to a NetSight server behind a NAT firewall or a
# NetSight server with multiple interfaces you must define
  these two
# variables on the NetSight server. The java.rmi.server.hostname
# should be the hostname
(not the IP) if multiple IPs are being used
# so that each client can resolve the hostname to the correct IP that
# they want to use as the IP to connect to.
java.rmi.server.hostname=<hostname of Extreme Management
Center server>
java.rmi.server.useLocalHostname=true
```
2. Save the file.
3. Add the Extreme Management Center server hostname to your DNS server.

## Defining Interface Services

The advanced interface configuration mode available in Extreme Management Center allows you to define which services are provided by each of the Extreme Access Control engine's interfaces. This provides the very granular out-of-band management that is often required in MSP or MSSP environments.

For instructions, see the [Interface Configuration Window](#) Help topic.

---

### Related Information

For information on related windows:

- [Interface Configuration Window](#)

## Access Control Concepts

---

This Help topic explains some of the concepts you'll need to understand in order to make the most effective use of **Access Control** tab.

Information on:

- [Overview of the Access Control Tab](#)
- [Extreme Access Control Engines](#)
  - [Use Scenario](#)
  - [Extreme Access Control VPN Deployment](#)
- [Access Control Tab Structure](#)
  - [Extreme Access Control Configuration](#)
    - [Rule Components](#)
    - [Extreme Access Control Profiles](#)
    - [AAA Configurations](#)
    - [Portal Configurations](#)
- [Access Policies](#)
- [Registration](#)
- [Assessment](#)
  - [Assessment Remediation](#)
- [End-System Zones](#)
- [Enforcing](#)
- [MAC Locking](#)
- [Notifications](#)

## Overview of the Access Control Tab

Extreme Networks Extreme Access Control is a centralized network access control solution located in the **Access Control** tab that combines authentication, vulnerability assessment, and location services to authorize network access and determine the appropriate level of service for an end-system. The Extreme Access Control solution ensures that only valid users and devices with

appropriate security postures at the proper location are granted access to your network. For end-systems which are not compliant with defined security guidelines, the Extreme Access Control solution provides assisted remediation, allowing end users to perform self-service repair steps specific to the detected compliance violation.

The **Access Control** tab is the management component in the Extreme Networks Extreme Access Control solution. The **Access Control** tab and Extreme Access Control engines work in conjunction to implement network access control. The **Access Control** tab provides one centralized interface for configuring the authentication, authorization, assessment, and remediation parameters for your Extreme Access Control engines. After these configurations are enforced, the Extreme Access Control engines can detect, authenticate, assess, authorize, and remediate end-systems connecting to the network according to those configuration specifications.

## Extreme Access Control Engines

The Extreme Access Control engine is required for all Extreme Networks Extreme Access Control deployments. It provides the ability to detect, authenticate, and effect the authorization of end devices attempting to connect to the network. It also integrates with, or connects to, vulnerability assessment services to determine the security posture of end-systems connecting to the network. Once authentication and assessment are complete, the Extreme Access Control engine effects the authorization of devices on the network by allocating the appropriate network resources to the end-system based on authentication and/or assessment results.

If authentication fails and/or the assessment results indicate a non-compliant end-system, the Extreme Access Control engine can either totally deny the end-system access to the network or quarantine the end-system with a highly restrictive set of network resources, depending on its configuration. The Extreme Access Control engine also provides the remediation functionality of the Extreme Access Control solution by means of the remediation web server that runs on the engine. Remediation informs end users when their end-systems have been quarantined due to network security policy non-compliance, and allows end users to safely remediate their non-compliant end-systems without assistance from IT operations.

## Use Scenario

The Extreme Access Control Gateway engine provides out-of-band network access control for networks where intelligent wired or wireless edge infrastructure devices are deployed as the authorization point for connecting end-systems. End-systems are detected on the network through their RADIUS authentication interchange. Based on the assessment and authentication results for a connecting device, RADIUS attributes are added/modified during the authentication process to authorize the end-system on the authenticating edge switch. Therefore, the Extreme Access Control Gateway may be positioned anywhere in the network topology with the only requirement being that IP connectivity between the authenticating edge switches and the Extreme Access Control Gateways is operational.

It is important to note that if the wired edge of the network is non-intelligent (unmanaged switches and hubs) and is not capable of authenticating and authorizing locally connected end-systems, it is possible to augment the network topology to allow implementation of inline Extreme Access Control with the Extreme Access Control Gateway. This can be accomplished by adding an intelligent edge switch that possesses specialized authentication and authorization features. The Extreme Networks K-, S-, or N-Series switch is capable of authenticating and authorizing numerous end-systems connected on a single port through its Multi-User Authentication (MUA) functionality, and may be positioned upstream from non-intelligent edge devices to act as the intelligent edge on the network. In this configuration, the K-, S-, or N-Series switch acts as the intelligent edge switch on the network, although not physically located at the access edge.

For end-systems connected to EOS policy-enabled switches, a *policy role* is specified in the **Access Control** tab (policy roles are defined and distributed to those switches by the **Policy** tab) to authorize connecting end-systems with a particular level of network access. For end-systems connected to RFC 3580-compliant switches (Enterasys and third-party), a VLAN is specified in the **Access Control** tab to authorize connecting end-systems with a particular level of network access, facilitated using dynamic VLAN assignment via Tunnel RADIUS attributes.

When a user or device attempts to connect to the network, the end-system is authenticated and assessed according to configurations defined in the **Access Control** tab. The **Access Control** tab uses the results of the authentication and

assessment to determine if that device meets the requirements for a compliant end-system. If the results of the authentication and security assessment are positive, Extreme Management Center authorizes the end-system with network access by assigning a designated policy role or VLAN on the switch port to which the end-system is connected. If the result of the security assessment is negative, Extreme Management Center restricts network access by assigning the user or device to a Quarantine policy role or VLAN on the switch port until the end-system is remediated and brought into a compliant state. If the result of the authentication is negative, Extreme Management Center can deny all network access for the endpoint as an invalid device or user on the network, setting the switch port to the unauthenticated state.

Depending on the engine model, the Extreme Access Control Gateway provides either on-board (integrated) vulnerability assessment server functionality and/or the ability to connect to external assessment services, to determine the security posture of end-systems connecting to the network. (On-board assessment requires a separate license.)

The number of Extreme Access Control Gateways you deploy on the network depends on the number of end-systems on the network. The following table displays the number of end-systems supported per Extreme Access Control Gateway model. Use this table to help determine the number of gateways to deploy.

Model	Number of End-Systems Supported	Notes
IA-A-20	6000	Configured Extreme Access Control Features: Authentication and OS/Device Fingerprinting, but no Registration or Assessment.
	4500	Configured Extreme Access Control Features: All features excluding Assessment.
	3000	Configured Extreme Access Control Features: All features including Assessment.

Model	Number of End-Systems Supported	Notes
IA-A-300	12000	Configured Extreme Access Control Features: Authentication and OS/Device Fingerprinting, but no Registration or Assessment.
	9000	Configured Extreme Access Control Features: All features excluding Assessment.
	6000	Configured Extreme Access Control Features: All features including Assessment.
IA-V	See Notes	The IA-V is included with the Extreme Management Center Advanced (NMS-ADV) license and is Extreme Access Control used in conjunction with an Extreme Access Control Enterprise license (IA-ES-12K).
NAC-V-20	3000	The NAC-V-20 is a virtual engine and requires an Extreme Access Control VM license in the Extreme Management Center Server.
NAC-A-20	3000	
SNS-TAG-ITA	3000	
SNS-TAG-HPA	3000	
SNS-TAG-LPA	2000	

It is important to configure Extreme Access Control Gateway redundancy for each switch. This is achieved by configuring two different Extreme Access Control Gateway engines as a primary and secondary gateway for each switch. When connection to the primary gateway engine is lost, the secondary gateway is used. Note that this configuration supports redundancy but not load-sharing, as the secondary gateway engine is only used in the event that the primary gateway becomes unreachable. To achieve redundancy with load-sharing for two Extreme Access Control Gateways, it is suggested that one half of the switches connecting to the gateways are configured with "Extreme Access Control Gateway A" as the primary and "Extreme Access Control Gateway B" as the secondary, and the second half are configured with "Extreme Access Control Gateway B" as the primary and "Extreme Access Control Gateway A" as the secondary. In this way, Extreme Access Control Gateways are configured in redundant active-active operation on the network.

## Extreme Access Control VPN Deployment

Extreme Networks Extreme Access Control provides out-of-band support for VPN remote access with specific VPN concentrators (see the Release Notes for a list of supported VPN concentrators). Out-of-band VPN support provides visibility into who and what is accessing the network over VPN. If RADIUS accounting is used, you also have the ability to determine who was on the network at any given time. In the VPN remote access use scenario, the VPN concentrator acts as a termination point for remote access VPN tunnels into the enterprise network. In addition, the Extreme Networks Extreme Access Control Gateway engine is deployed to authenticate and authorize connecting end-systems on the network and implement network access control.

The process begins when the user's end-system successfully establishes a VPN tunnel with the VPN concentrator, and the VPN concentrator sends a RADIUS authentication request with the associated credentials to the Extreme Access Control Gateway. The Extreme Access Control Gateway proxies the authentication request to a backend authentication server (RADIUS or LDAP) to validate the identity of the end user/device or can authenticate with a local password repository within Extreme Management Center. If authentication fails, the Extreme Access Control Gateway can deny the end-system access to the network by sending a RADIUS access reject message to the VPN concentrator.

After the end-system is authenticated, the Extreme Access Control Gateway requests an assessment of the end-system, if assessment is configured. Once authentication and assessment are complete, the Extreme Access Control Gateway allocates the appropriate access control to the end-system based on authentication and/or assessment results. Access control can be implemented using one of two methods. With the first method, access control is applied directly at the VPN concentrator via RADIUS response attributes, if the VPN concentrator supports this. For example, with a Cisco ASA security engine, this can be accomplished by using the filter-ID response attribute to specify the name of a valid ACL.

With the second method, an Extreme Networks K-Series, S-Series, or N-Series device is added between the VPN's internal port and the internal network as a Policy Enforcement Point (PEP). This allows the Extreme Access Control Gateway to provide a more granular access control mechanism using IP to Policy Mappings. This method must be used if you are implementing remediation on your network. If the end-system fails assessment, the Extreme Access Control



Gateway can apply a Quarantine policy on the PEP to quarantine the end-system. When the quarantined end user opens a web browser to any web site, its traffic is dynamically redirected to a Remediation web page that provides steps for the user to execute in order to achieve compliance. After executing the steps, the end user can reattempt network access and start the process again.

## Access Control Tab Structure

The **Access Control** tab components are contained in three major navigation trees.

At the top are the following navigation trees:

- Engine Groups — Lists the Extreme Access Control engines added to the selected engine group, the end-systems connected to those engines, the switches added to the Gateway engines in the engine group, and general information about the engine group.
- All Extreme Access Control Engines — Lists all Extreme Access Control engines added to Extreme Management Center, the end-systems connected to those engines, the switches added to the Gateway engines, and general information about the engine.
- Extreme Access Control Configurations — Provides options to configure the end-user connection experience and control network access based on a variety of criteria including authentication.

## Extreme Access Control Configuration

The Extreme Access Control Configuration lets you manage the end user connection experience and control network access based on a variety of criteria. The **Access Control** tab comes with a default Extreme Access Control Configuration which is automatically assigned to your Extreme Access Control engines. You can use this default configuration as is, or make changes to the default configuration, if desired.

The Extreme Access Control Configuration determines what Extreme Access Control Profile will be assigned to an end-system connecting to the network. It contains an ordered list of rules that are used by the configuration to assign an Extreme Access Control Profile to a connecting end-system based on rule criteria. It also specifies the Default Profile which serves as a "catch-all" profile

for any end-system that doesn't match one of the rules. By default, all end-systems match the Default Profile.

When an end-system connects to the network, the rules are evaluated in a top-down fashion, similar to the way an ACL would be evaluated. End-systems that do not match any of the rules are assigned the Default Profile.

## Rule Components

The rules defined in an Extreme Access Control Configuration provide very granular control over how end-systems are treated as they come onto the network. The following criteria can be used to define the rules used in your Extreme Access Control Configuration:

- Authentication Type - for example, 802.1X or MAC authentication.
- End-System Groups - allow you to group together devices that have similar network access requirements or restrictions. For example, a list of MAC addresses, IP addresses, or hostnames.
- Device Type - allow you to group together end-systems based on their device type. The device type can be an operating system family, an operating system, or a hardware type, such as Windows, Windows 7, Debian 3.0, and HP Printers.
- Locations - allow you to specify network access requirements or restrictions based on the network location where the end user is connecting. For example, a list of switches, wireless devices, switch ports, or SSIDs.
- Time of Day - allow you to specify network access requirements or restrictions based on the day and time when the end user is accessing the network. For example, traditional work hours or weekend work hours.
- User Groups - allow you to group together end users having similar network access requirements or restrictions. For example, a list of usernames, an LDAP users group, or a RADIUS user group.

For more information, see the [Manage Rule Groups window](#).

## Extreme Access Control Profiles

Extreme Access Control Profiles specify the authorization and assessment requirements for the end-systems connecting to the network. Profiles also specify the security policies applied to end-systems for network authorization, depending on authentication and assessment results.

The **Access Control** tab comes with ten system-defined Extreme Access Control Profiles:

- Administrator
- Allow
- Default
- Guest Access
- Notification
- Pass Through
- Quarantine
- Registration Denied Access
- Secure Guest Access
- Unregistered

If desired, you can edit these profiles or you can define your own profiles to use for your Extreme Access Control Configurations. For more information, see the [Manage Extreme Access Control Profiles window](#).

## AAA Configurations

The AAA Configuration defines the RADIUS servers, LDAP configurations, and Local Password Repository that provide the authentication and authorization services for all end-systems connecting to your Extreme Access Control engines. The **Access Control** tab comes with a default Basic AAA Configuration that ships with each Extreme Access Control engine. You can use this default configuration as is, or make changes to the default configuration, if desired. For more information, see the [Edit Basic AAA Configurations window](#).

## Portal Configurations

If your network is implementing [Registration](#) or [Assisted Remediation](#), the Portal Configuration defines the branding and behavior of the website used by the end user during the registration or remediation process. Extreme Access Control engines are shipped with a default Portal Configuration. You can use this default configuration as is, or make changes to the default configuration, if desired. For more information, see the [Portal Configuration](#) Help topic.

## Access Policies

Access policies define the authorization level that the Extreme Access Control assigns to a connecting end-system based on the end-system's authentication and/or assessment results. There are four access policies used in the **Access Control** tab: Accept policy, Quarantine policy, Failsafe policy, and Assessment policy. In your Extreme Access Control Profiles, these access policies define a set of network access services that determine exactly how an end-system's traffic is authorized on the network. How access policies are implemented depends on whether your network utilizes Extreme Access Control Controller engines and/or Extreme Access Control Gateway engines.

For end-systems connected to EOS policy-enabled switches, Extreme Access Control Gateway engines inform the switch to assign a policy role to a connecting end-system, as specified by the access policy. These policy roles must be defined in **Policy** tab and enforced to the EOS policy-enabled switches in your network.

For end-systems connected to RFC 3580-enabled switches, policy roles are associated to a VLAN ID. This allows your Extreme Access Control Gateways to send a VLAN ID instead of a policy role to those switches using Tunnel RADIUS attributes.

For Extreme Access Control Controller engines, authorization of the end-system is implemented locally on the Extreme Access Control Controller engine by assigning a policy role to the end-system, as specified by the access policy. In this scenario, all policy roles must be defined in the Extreme Access Control Controller policy configuration.

Here is a description of each the **Access Control** tab access policy, and some guidelines for creating corresponding policy roles in the **Policy** tab.

**Accept Policy:** The Accept access policy is applied to an end-system when it has been authorized locally by the Extreme Access Control Gateway and when an end-system has passed an assessment (if an assessment was required), or if the Accept policy has been configured to replace the Filter-ID information returned in the RADIUS authentication messages. For EOS policy-enabled switches, a corresponding policy role (created in the **Policy** tab) would allocate the appropriate set of network resources for the end-system depending on their role in the enterprise. For example, you might associate the Accept policy in the

**Access Control** tab to the "Enterprise User" role that is defined in the **Policy** tab demo.pmd file. For RFC 3580-compliant switches, the Accept access policy may be mapped to the Production VLAN. Extreme Access Control Controllers are shipped with a default policy configuration that includes an Enterprise User policy role.

**Quarantine Policy:** The Quarantine access policy is used to restrict network access to end-systems that have failed assessment. For EOS policy-enabled switches, a corresponding Quarantine policy role (created in the **Policy** tab) should deny all traffic by default while permitting access to only required network resources such as basic network services (e.g. ARP, DHCP, and DNS) and HTTP to redirect web traffic for Assisted Remediation. For RFC 3580-compliant switches, the Quarantine access policy may be mapped to the Quarantine VLAN. Extreme Access Control Controllers are shipped with a default policy configuration that includes a Quarantine policy role.

**Failsafe Policy:** The Failsafe access policy is applied to an end-system when it is in an Error connection state. An Error state results if the end-system's IP address could not be determined from its MAC address, or if there was an assessment error and an assessment of the end-system could not take place. For EOS policy-enabled switches, a corresponding policy role (created in the **Policy** tab) allocates a nonrestrictive set of network resources to the connecting end-system so it can continue its connectivity on the network, even though an error occurred in the Extreme Access Control Solution operation. For RFC 3580-compliant switches, the Failsafe access policy may be mapped to the Production VLAN. Extreme Access Control Controllers are shipped with a default policy configuration that includes a Failsafe policy role.

**Assessment Policy:** The Assessment access policy may be used to temporarily allocate a set of network resources to end-systems while they are being assessed. For EOS policy-enabled switches, a corresponding policy role (created in the **Policy** tab) should allocate the appropriate set of network resources needed by the Assessment server to successfully complete its end-system assessment, while restricting the end-system's access to the network.

Typically, the Assessment access policy allows access to basic network services (e.g. ARP, DHCP, and DNS), permits all IP communication to the Assessment servers so the assessment can be successfully completed (using destination IP address "Permit" classification rule), and HTTP to redirect web traffic for Assisted Remediation. For RFC 3580-compliant switches, the Assessment access policy may be mapped to the Quarantine VLAN. Extreme Access Control

Controllers are shipped with a default policy configuration that includes an Assessing policy role.

It is not mandatory to assign the Assessment policy to a connecting end-system while it is being assessed. The policy role received from the RADIUS server or the Accept policy can be applied to the end-system, allowing the end-system immediate network access while the end-system assessment is occurring in the background. In this case, the policy role or Accept policy (or the associated VLAN for RFC 3580-compliant switches) must be configured to allow access to the appropriate network resources for communication with the Assessment servers.

---

**NOTE:** The Assessment server sends an ICMP Echo Request (a "ping") to the end-system before the server begins to test IP connectivity to the end-system. Therefore, the Assessment policy role, the router ACLs, and the end-system's personal firewall must allow this type of communication between end-systems and Assessment servers in order for the assessment to take place. If the Assessment server cannot verify IP connectivity, the Failsafe policy is assigned to the end-system.

---

For more information, refer to the [How to Set Up Access Policies](#) Help topic.

## Registration

The Extreme Networks Extreme Access Control Solution provides support for Registration, a solution that forces any new end-system connected on the network to provide the user's identity in a web page form before being allowed access to the network, without requiring the intervention of network operations. This means that end users are automatically provisioned network access on demand without time-consuming and costly network infrastructure reconfigurations. In addition, IT operations has visibility into the end-systems and their associated users (e.g. guests, students, contractors, and employees) on the network without requiring the deployment of backend authentication and directory services to manage these users. This binding between user identity and machine is useful for auditing, compliance, accounting, and forensics purposes on the network.

End-system or user groups may be configured to exempt certain devices and users from having to register to the network, based on authentication type, MAC address, or user name. For example, a end-system group for the MAC OUI of the

printer vendor for the network can be configured to exempt printers from having to register for network access.

The Registration solution has minimal impact on the end user's experience by initially redirecting guests, contractors, partners, students, or other pre-defined end users to a web page for registering their end-system when it is first connected to the network. After successful registration, the end-system is permitted access, and possibly assessed for security posture compliance checking, until the registration is administratively revoked.

Registration is supported on Extreme Access Control Gateway engines and/or Layer 2 Extreme Access Control Controller engines. (Registration is not supported on the Layer 3 Identity and Access Controller engines.) Registration provides flexibility in implementation by offering the following capabilities:

- Determine "valid" end users by prompting each end user for a username with additional information such as full name and e-mail address, or a username and password (e.g. e-mail address and student ID number) which can be validated against an existing database on the network.
- Allow end users to register to the network when approved by a "sponsor" who is an internal trusted user to the organization. This is referred to as "Sponsored Registration." With sponsored registration, end users are only allowed to register to the network when approved by a sponsor. Sponsorship can provide the end user with a higher level of access than just guest or web access and allows the sponsor to fine-tune the level of access for individual end users.
- Configure the introductory message for the Registration web page (displayed to end-systems before registering to the network) to state that the end user is agreeing to the Acceptable Use Policy for the network upon registering their device.
- Specify the maximum number of registered MAC addresses per user.
- Control areas on the network where Registration is enabled.
- Provide a web-based administrative interface served over HTTPS where registrations may be viewed, manually added, deleted, and modified by administrators and sponsors without requiring access to the **Access Control** tab.

The Extreme Networks Extreme Access Control Solution utilizes a Registration Web Server installed on the Extreme Access Control engine to provide this registration functionality to end-systems. Note that an Extreme Access Control engine may implement both assisted remediation and registration concurrently.

There are specific network configuration steps that must be performed when using Registration in your Extreme Access Control Solution. In addition, you must configure Registration in the **Access Control** tab.

## How Registration Works

Here is a description of how Registration works in the Extreme Networks Extreme Access Control (Extreme Access Control) Solution:

- An unregistered end-system attempts to connect to the network and is assigned the unregistered access profile without being assessed by the Extreme Access Control engine. For example, if connected to a Layer 2 Extreme Access Control Controller, the end-system may be assigned to the "Unregistered" policy as defined in the Extreme Access Control Controller's default policy configuration. If connected to an EOS policy-enabled switch, the end-system may be assigned to the "Unregistered" policy as defined in the Extreme Management Center **Policy** tab and enforced to the policy-enabled switches. Or, if connected to an RFC 3580-compliant switch, the end-system may be assigned to the "Unregistered" VLAN.
- The user on the unregistered end-system opens up a web browser to any URL and is redirected to the Registration Web Page served by the Extreme Access Control engine.
- The end user registers its end-system on the network by entering information such as username, full name, e-mail, and possibly a password or sponsor's email address into the Registration Web Page, and clicking the "Complete Registration" button.
- The Registration Web Server assigns the end user to an end-system group based on the Registration Behavior configured in the Extreme Access Control Configuration.
- The end-system is then automatically re-authenticated to the network by the Extreme Access Control engine. Upon re-authentication, the end-system is authenticated, assessed, and authorized as defined by the profile specified in the Extreme Access Control Configuration for the newly registered system. If the profile specifies to assess the end-system, an assessment of the end-system takes place at this time.

## Assessment

The Extreme Networks Extreme Access Control Solution integrates with assessment services to determine the security posture of end-systems connecting to the network. It uses assessment servers to assess and audit



connecting end-systems and provide details about an end-system's patch levels, running processes, anti-virus definitions, device type, operating system, and other information critical in determining an end-system's security compliance. End-systems that fail assessment can be dynamically quarantined with restrictive network access to prevent security threats from entering the network.

When an assessment is performed on an end-system, a *Health Result* is generated. For each health result, there may be several *Health Result Details*. A health result detail is a result for an individual test performed during the assessment. Each health result detail is given a score ranging from 1 to 10, and based on this score, the health result is assigned a risk level. The **Access Control** tab uses this risk level to determine whether or not the end-system will be quarantined.

In addition, assessment tests are assigned a *scoring mode* which determines whether the resulting health result detail is applied towards the quarantine decision, or is used only for informational or warning purposes. Informational health result details can be used to gather information about the security risks on your network, while warning health result details allow you to notify end users when they have security risks that should be remediated. Informational or warning health result details have scores, however these health result details do not impact the end-system's overall risk level.

The **Access Control** tab lets you create multiple *assessment configurations* that can define different assessment requirements for end-systems. Assessment configurations define the following information:

- What assessment tests to run (determined by the selected test sets).
- What resources to use to run the tests (determined by the selected Assessment Resources).
- How to score assessment results (determined by the selected Risk Level and Scoring Override configurations).

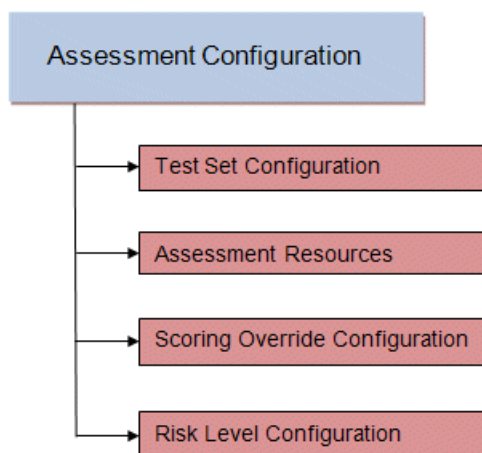

Test sets let you define what type of assessment to execute, what parameters to pass to the assessment server, and which assessment server resources to use. The **Access Control** tab provides three default test sets; one for each type of assessment agent that is either supplied or supported by the **Access Control** tab. You can use these default test sets "as is" or edit them, if desired.

When you define your assessment server resources for a test set, you can specify to balance the assessment load between your all your assessment servers, or, you can specify an assessment server pool. For example, if you have four Nessus assessment servers, you can put server A and server B in server pool 1, and server C and server D in server pool 2. Then, in your test set configuration you can specify which server pool that test set should use.

You can use risk level and scoring override configurations to define how each assessment configuration will interpret an end-system's health results. The risk level configuration determines what risk level is assigned to an end-system (high, medium, or low) based on the end-system's health result details score. The scoring override configuration lets you override the default score and scoring mode assigned to a particular assessment test ID.

Once you have defined your assessment configurations, they are available for selection when creating your Extreme Access Control Profiles. In addition, the **Access Control** tab provides a default assessment configuration that is already set up with default assessment parameters and is ready to use in your Extreme Access Control Profiles.

Before beginning to configure assessment on your network, you should read through the following information presented in the **Access Control** tab online Help.

- [How to Set up Assessment](#) - Provides information on the steps that must be performed in the **Access Control** tab prior to deploying assessment on your network, including managing your assessment servers and adding external assessment servers. It also includes basic information on how to use the default assessment configurations provided by the **Access Control** tab, and enable assessment for your Extreme Access Control Configuration.
- [Extreme Access Control Assessment Phased Deployment Guide](#) - This guide describes the phased approach to introducing assessment into your Extreme Access Control deployment using Informational, Warning, and Quarantine assessment. The guide also provides information on the **Access Control** tab tools that can be used to monitor and evaluate assessment results, and diagnose and troubleshoot problems.
- [How to Configure Assessment](#) - Provides step-by-step instructions for configuring assessment using the phased approach described in the Extreme Access Control Assessment Phased Deployment Guide. Instructions are provided for configuring phased assessment using agent-less or agent-based assessment, or a combination of both.
- [How to Deploy Agent-Based Assessment](#) - If you are deploying agent-based assessment, this Help topic provides the configuration steps specific to deploying agent-based assessment in a Windows and Mac network environment. It includes instructions for configuring agent deployment and provides information about the agent icon and notification messages that appear on the end-user's system. It also includes instructions on performing a managed deployment or installation of the agent.
- [How to Set Up Assessment Remediation](#) - Because Warning and Quarantine assessment provides end-system remediation, you must enable remediation for your Extreme Access Control Configuration. This Help topic provides the specific steps that must be performed when setting up assisted remediation in your network.

## Assessment Remediation

Remediation is a process that informs end users when their end-systems have been quarantined due to network security policy non-compliance, and allows end users to safely remediate their non-compliant end-systems without assistance from IT operations. The process takes place when an end-system

connects to the network and assessment is performed. End users whose systems fail assessment are notified that their systems have been quarantined, and are instructed in how to perform self-service remediation specific to the detected compliance violation. Once the remediation steps have been successfully performed and the end-system is compliant with network security policy, the appropriate network resources are allocated to the end-system, again without the intervention of IT operations.

The Extreme Networks Extreme Access Control Solution implements local Remediation Web Server functionality to provide web notification to end users indicating when their end-systems are quarantined and what remediation steps the end user must take. The Remediation Web Server is installed on the Extreme Access Control engine.

There are specific network configuration steps that must be performed when using assisted remediation in your Extreme Access Control Solution. In addition, you must configure assisted remediation in the **Access Control** tab. For more information, see [How to Set up Assessment Remediation](#) and [Portal Configuration](#) Help topics.

## How Remediation Works

Here is a description of how assisted remediation works in the Extreme Networks Extreme Access Control Solution:

- An end-system connects to the network (where assessment has been configured) and is authorized with the level of network access defined by the Assessment access policy configuration.
- The end-system is assessed by the assessment server for security threats and vulnerabilities.
- When the end-system opens a web browser to any web site, the HTTP traffic is redirected to the Extreme Access Control engine and a web page indicating that the end-system is currently being assessed is displayed.
- When the assessment is complete, the assessment server sends the results to the Extreme Access Control engine. If the end-system failed assessment, the end-system is authorized with the level of network access defined by the Quarantine access policy configuration.
- When the quarantined end user opens a web browser to any web site, its traffic is dynamically redirected to the Extreme Access Control engine.

- The Extreme Access Control engine returns a web page formatted with self-service remediation information for the quarantined end-system. This web page indicates the reasons the end-system was quarantined and the remediation steps the end user must take.
- After taking the appropriate remediation steps, the end-user clicks a button on the web page and attempts to reconnect to the network. A re-assessment of the end-system is initiated. If the end-system is now compliant with network security policy, the Extreme Access Control engine authorizes the end-system with the appropriate access policy. If the end-system is not compliant, the Quarantine access policy is again utilized to restrict the authorization level of the end-system and the process starts again.
- After a specified number of attempts and/or maximum time to remediate have expired, the end user may be redirected to a web page requiring them to contact the helpdesk for further assistance, and a notification is sent to the helpdesk system with information regarding the non-compliant end-system.

## End-System Zones

The **Access Control** tab end-system zones allow you to group end-systems into zones, and then limit an Extreme Management Center user's access to Extreme Management Center end-system information and configuration based on those zones.

End-system zones are configured and managed in the **Access Control** tab, and are enforced for Extreme Management Center end-system information and configuration.

When an end-system authenticates to the network, Extreme Access Control rules are used to assign an Extreme Access Control profile and an end-system zone to the end-system. This allows you to use a variety of rule components (such as End-System Groups, Location Groups, and User Groups) to determine which zone an end-system should be assigned to.

You can create any number of end-system zones in your network. An end-system can only be assigned to one zone (but does not have to be assigned to a zone). You can view which zone an end-system is currently assigned to in the end-systems table in the **Access Control** tab in Extreme Management Center.

A user's authorized zones are determined by their Extreme Management Center user group membership. User groups are created and configured in the Extreme

Management Center Authorization/Device Access Tool (accessed from the Tool menu), and authorized zones are assigned to each user group in the **Access Control** tab. For instructions, see [How to Configure End-System Zones](#).

In addition to using end-system zones, you can also limit a user's access to Extreme Management Center operations by assigning authorized rule groups. Whenever a user initiates a change to a rule group, such as adding or removing an end-system to or from a group, a check is performed to verify that the user is authorized to change that rule group. Similar to end-system zones, a user's authorized rule groups are determined by their Extreme Management Center user group membership.

A third component that should be taken into consideration is the ability to limit user access to Extreme Management Center using authorization group capabilities. For example, you can assign a user group the Extreme Management Center End-Systems Read Access capability to allow read-only access to Extreme Management Center end-system information, and use end-system zones to limit which end-systems can be viewed. You can assign a user group the Extreme Management Center End-Systems Read/Write Access capability to allow the ability to modify rule groups, and use rule group authorization to limit which rule groups the user can perform these operations on.

Capabilities are assigned to user groups using the Authorization/Device Access Tool. The Extreme Management Center Administrator group is always assigned all capabilities.

For more information, see [How to Configure User Access to Extreme Management Center Applications and Authorization Group Capabilities in the Suite-Wide Tools Help](#).

## End-System Zone Use Cases

Here are several network scenarios where using end-system zones could be beneficial.

- **A Service Provider with multiple tenants.** If a service provider serves multiple tenants and each tenant has a clearly delineated set of switches, user access can be configured to allow each tenant's IT staff to only view the end-systems connecting to their own switches.
- **A large enterprise with network administrator groups.** In a large enterprise where specific groups of network administrators are responsible for specific groups of

switches on shared engines, user access can be configured so that each administrator can view reports and other information only for their switches and end-systems.

- **A large business segmented by business function.** In a large enterprise where division of control is not closely tied to switches or engines, user access can be configured so that administrators only have the ability to view and manage the appropriate end user groups.

In each of these scenarios, a restricted set of authorization group capabilities must be used to prevent users from viewing and accessing information that may not pertain to their area.

## Enforcing

In the **Access Control** tab, enforcing means writing Extreme Access Control configuration information to one or more Extreme Access Control engines. Any time you add or make a change to the Extreme Access Control Configuration, the engines need to be informed of the change through an enforce, otherwise the changes do not take effect. When an engine needs to be enforced, the Enforce icon  appears on that engine in the left-panel tree.

To enforce, use the **Enforce All** button in the **Enforce** menu  at the bottom of the left-hand panel which writes the information to all the Extreme Access Control engines. You can enforce to an individual engine or engine group by clicking the **Enforce** menu and selecting **Selection**.

---

**TIP:** For a preview of what will be enforced/updated on an individual engine, right-click the engine and choose **Enforce Preview** from the menu.

---

The enforce operation is performed in two stages: first an engine configuration audit is performed and then the actual enforce to engines is performed.

The configuration audit takes place automatically after you start the enforce operation. It looks for a wide-range of engine configuration problems including a review of the Extreme Access Control Configuration, Extreme Access Control Profile, rule configuration, AAA configuration, and portal configuration. The audit results are displayed in the Enforce window, allowing you to view any warning and error information. To see warning or error details, use the + icon in the left column to expand the Details information (as shown below) or click **Show Details** to open the information in a new window.

If you choose to correct any problems at this point, you must close the Audit Results window. When you have made your changes, click the Enforce All button to start the enforce operation and perform a new audit.

From the Enforce window, you can click the **Enforce All** button to enforce all engines, or use the checkboxes in the Select column to select some of the engines to enforce and click the **Enforce** button. In order for the enforce operation to be carried out, none of the selected engines can have an error associated with it. Even if one of the selected engine has passed the audit, it will not be enforced if other selected engines have errors.

If none of the selected engines have errors, but a selected engine has a warning associated with it, you are given the option to acknowledge the warning and proceed with the enforce anyway. Once you acknowledge the warning and click OK, the enforce is performed.

---

**TIP:** If there are warning messages that are regularly displayed during Enforce engine audits, you can use the [Enforce Warning Settings](#) to specify that these messages should be ignored and not be displayed.

---

The Enforce window displays the enforce operation status, as shown below.

## Advanced Enforce Options

In the Enforce window, there are two Advanced enforce options available. The two options can be used for the following situations:

- **Force Reconfiguration for All Switches** - This option can be used if the switch RADIUS settings were manually changed via CLI or the **Policy** tab. Since Identity and Access does not reconfigure the switches every time there is an enforce, selecting this option forces reconfiguration of RADIUS settings on all switches to ensure they are configured correctly.
- **Force Reconfiguration for Captive Portal** - During an enforce, captive portal settings are not enforced unless they have changed. You can use this option to force reconfiguration of the portal to ensure the state of the captive portal processes.

---

**NOTE:** MAC Locking to a specific port on a switch is based on the port interface name (e.g. fe.5.1). If a switch board is moved to a different slot in a chassis, or if a stack reorders itself, this name will change and break the MAC Locking settings.

---



**NOTE: For Extreme Access Control Controller Engines.**

-- On Layer 3 Extreme Access Control Controllers, do not use MAC Locking to lock a MAC address to the Controller PEP IP address **and** a port on the PEP. You can however, lock a MAC address to the PEP IP and **not** the port, which would restrict movement of the MAC address away from the Layer 3 Controller.

-- On Layer 2 Extreme Access Control Controllers, a MAC address can be locked to the Controller PEP IP address and port, or just the PEP IP address, but this only controls the movement of the end-system between the downstream ports on the PEP (IP address and port) and not the actual edge of the network.

-- On Layer 3 Extreme Access Control Controllers, there may be cases where the **Access Control** tab cannot determine the MAC address of the connecting end-system (for example, DHCP is disabled and a firewall is enabled on the end-system, or the end-system is connecting through a VPN), and the MAC address for the end-system is displayed as "Unknown." In these cases, the MAC Locking feature is not supported.

---

## Notifications

Notifications provide the ability for the **Identity and Access** tab to notify administrators or helpdesk personnel of important information through email, Trap, or Syslog messages. These notifications help administrators understand what is going on in their system on a real-time basis. For example, the **Access Control** tab could be configured to send a notification when a new end-system is learned on the network, when a MAC lock is violated, or when a new MAC address is registered on the network.

## Access Control Configuration

The Access Control Configuration panel provides a central location to view the configuration parameters for all aspects of your Extreme Access Control system. Access this window by selecting Access Control Configurations from the **Control > Access Control** tab.

Access Control Configurations		
Name ↑	Portal	AAA
Default	Default	Default

Expand the Access Control Configurations left-panel tree to access to the following Access Control system components.

### Access Control Configurations

Each engine group uses one Access Control configuration that contains an ordered list of rules used to determine which Access Control profile is assigned to the end-systems connecting to the engines in that group. Access Control configurations include the following components:

#### **Name**

The **Name** by which the Access Control Configuration is known.

#### **Portal Configurations**

If your network is implementing [Registration](#) or [Assisted Remediation](#), use the Portal Configuration to define the branding and behavior of the website used by the end user during the registration or remediation process.

#### **AAA Configurations**

AAA configurations define the RADIUS and LDAP configurations, and Local Password Repository that provide the authentication and authorization services to your Extreme Access Control engines.

# Extreme Access Control Configuration Rules

---

The Rules panel in the **Access Control** tab displays a list of rules used by the Extreme Access Control Configuration to assign an Extreme Access Control Profile to a connecting end-system based on rule criteria.

This Help topic provides information for accessing and configuring Extreme Access Control Configuration Rules:

- [Accessing Extreme Access Control Configuration Rules](#)
- [Viewing Rules in the Table](#)
- [Creating and Editing Rules](#)

## Accessing Extreme Access Control Configuration Rules

Use the following steps to view and edit your Extreme Access Control Configuration rules.

1. Open the **Control** tab in Extreme Management Center.
2. Click the **Access Control** tab.
3. In the left-panel tree, expand the Access Control Configurations tree.
4. Expand an Extreme Access Control Configuration and select Rules. The table of your Extreme Access Control rules is displayed in the right panel. See below for an explanation of the table columns.
5. Use the toolbar buttons at the top of the right-panel to create a new rule or edit existing rules. See below for a description of each button.

## Viewing Rules in the Table

The Rules table displays the rule name, whether the rule is enabled, and summary information about the rule. It also shows the Extreme Access Control Profile assigned to any end-system that matches the rule and the portal

redirection action, if applicable. Rules are listed in order of precedence. End-systems that do not match any of the listed rules are assigned the Default Catchall rule.

---

**TIP:** Right click on a rule in the table to access a menu of options including the ability to edit the Extreme Access Control profile and any user groups included in the rule.

---

### Enabled

This column displays whether the rule is enabled by displaying a checkmark icon ✓ or disabled, with no checkmark. Click the **Edit** button to enable or disable the rule. You cannot disable any of the system rules provided by Extreme Management Center.

### Rule Name

This column displays the rule name. Double-click on the rule to open the Edit Rule window where you can edit the rule name, if desired. You cannot change the name of the system rules provided by Extreme Management Center.

### Conditions

This column displays the criteria an end-system must meet in order to be assigned the rule, including the authentication method and rule groups that the end-system or user must match. Double-click on the rule to open the Edit Rule window where you can edit the rule criteria, if desired. You cannot change the criteria for the system rules provided by Extreme Management Center. Click on a rule group name to open a window where you can edit the group's parameters.

### User Group

This column, hidden by default, displays the user group you configured. User groups limit an Extreme Management Center user's access based on the LDAP, RADIUS, or Username group to which they are assigned. To edit the **User Group**, click the user group in the **Conditions** column, which opens the [Add/Edit User Group window](#).

### Zone

This column displays the end-system zone you configured. End-system zones allow you to group end-systems into zones, and then limit an Extreme Management Center user's access to end-system information and configuration based on those zones.

## Actions

This column displays the actions the rule takes when an end-system matches the rule's criteria. This includes the profile assigned to the end-system and the portal configuration the end user sees. Click on the profile or portal name to open a window where you can make changes, if desired.

Add or remove a column by clicking the down arrow at the right of a column header and selecting a checkbox associated with a column from the Columns menu.

## Creating and Editing Rules

Use the Rules toolbar buttons to create, edit, and modify the rules in the table. Any changes made in this table are written immediately to the Extreme Management Center database.

### Add... **Add New Rule**

Opens the [Create Rule window](#) where you can define a new rule to use in the Extreme Access Control configuration.

---

**TIP:** To add a new rule at a specific location in the table, select the rule that you want the new rule to follow, right-click and select **Add Rule** after Selection. When you create the new rule and click **OK**, it is added after the selected rule. The selected rule must be a custom (user-defined) rule, or it can be the Blacklist or Assessment Warning rule.

---

### Copy... **Copy Rule**

Opens the Copy Rule window where you can copy the rule criteria of an existing rule for a new rule.

### Edit... **Edit Rule**

Opens the [Edit Rule window](#) where you can edit the rule criteria for a selected rule.

### Delete **Delete Selected Rules**

Deletes any rules selected in the table.

### Up Down **Move Rule Up/Down**

Move rules up and down in the list to determine rule precedence.

### Apply Group Label... **Apply Group Label**

Opens the Apply Group Label window where you can add a group label to selected rules to create a new group. Once the group label is applied, the new group appears in the Rules window and is collapsible.

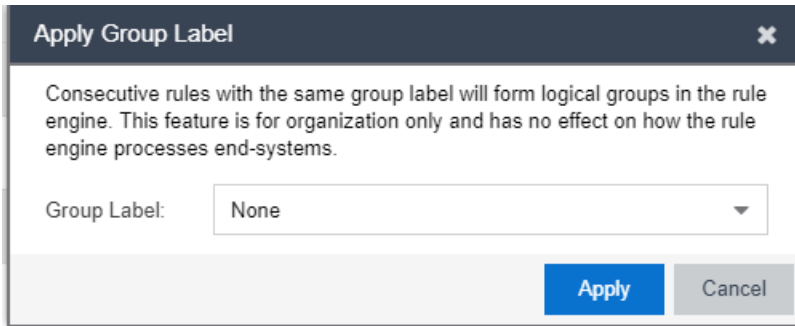

**Apply Group Label** ✕

Consecutive rules with the same group label will form logical groups in the rule engine. This feature is for organization only and has no effect on how the rule engine processes end-systems.

Group Label:

**Apply** Cancel

---

## Related Information

For information on related windows:

- [AAA Configuration](#)
- [Portal Configuration](#)

## Add/Edit Rule

---

Use this window to add a new rule or edit an existing rule in an Extreme Access Control configuration. End-systems that match the criteria selected for the rule are assigned the Extreme Access Control profile that is specified.

To access this window:

1. Open the **Control** tab in Extreme Management Center.
2. Click the **Extreme Access Control** tab.
3. In the left-panel tree, select Extreme Access Control Configurations > Default > Rules. A table of rules for the Extreme Access Control configuration is displayed in the right panel.
4. Click the **Add** button in the table toolbar to open the Create Rule window.  
*or*  
Select a rule in the table and click the **Edit** button in the toolbar to open the Edit Rule window.

The image below shows a rule created to provide a different Extreme Access Control profile for authenticated registered users on mobile devices. Descriptions of the different fields and options in the window are provided below.

**Add Rule** [Close]

Name:   Rule Enabled

Description:

Group Label:

---

**Conditions**

Authentication Method:   Invert

User Group:   Invert

End-System Group:   Invert

Device Type Group:   Invert

Location Group:   Invert

Time Group:   Invert

---

**Actions**

Profile:

Portal:

Zone:

**NOTES:** For the following rule criteria:

- If you select **Any** then the criteria is ignored during the rule match process.
- If you select the Invert checkbox, it is considered a rule match if the end-system does **not** match the selected value.

**Name**

Enter a name for a new rule or change the name of an existing rule, if desired.

**Rule Enabled**

Select this checkbox to enable this rule in the Extreme Access Control configuration.



**Description**

Enter a description of the rule.

**Group Label**

If this rule is part of a group, select the group name from the drop-down menu or enter a new group label here.

**Authentication Method**

Select the authentication method that end-systems must match for this rule.

**User Group**

Select the user group that the end user must be a member of to match this rule.  
Click the Edit button

**End-System Group**

Select the end-system group that the end-system must be a member of to match this rule. Click the **Edit** button to edit the selections available in this drop-down menu.

**Device Type Group**

Select the device type group that the end-system must be a member of to match this rule. Click the **Edit** button to edit the selections available in this drop-down menu.

**Location Group**

Select the network location (switch and interface) that the end-system must originate from to match this rule.

**Time Group**

Select a time frame that the connection request must match for this rule.

**Profile**

Select the Extreme Access Control profile assigned to any end-system matching this rule from the drop-down menu. Select New to add a new profile in the Create New Profile window. Select Manage from the drop-down menu to be redirected to the Engine Group > Switches tab and allows you to make additions or edits to the switches in this engine group.

Click the **More** button to display two additional actions:

**Portal**

Select the portal configuration from the drop-down menu to any end-system matching this rule. Select New to add a new portal configuration in the Add New Portal Configuration window. Select Manage from the drop-down menu to be redirected to the Engine Group > Switches tab and allows you to make additions or edits to the switches in this engine group.

**Zone**

This field only displays if you have displayed the Zone column in the Extreme Access Control Configuration Rules table. Select the end-system zone assigned to any end-system matching this rule. Enter a new zone name if none exists. See [End-System Zones](#) for more information.

## Add/Edit User to Authentication Mapping

This window lets you add or edit the user to authentication mappings that define your Advanced AAA configurations. You can access this window from the **Add** or **Edit** buttons in the [AAA Configuration window](#).

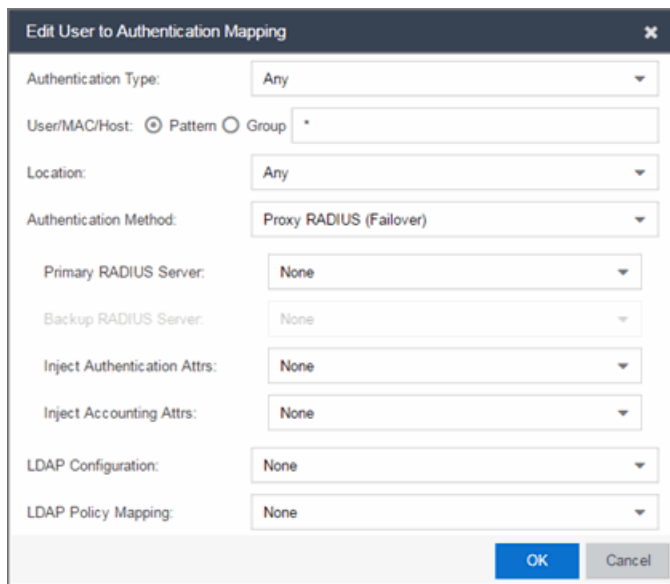

### Authentication Type

Select the authentication type that the end-system must match for this mapping. Note that individual types of 802.1X authentication are not available for selection because at this point in the authentication process, the fully qualified 802.1X authentication type cannot be determined. Select **Any** if you don't want to require an authentication match. Select **802.1X (TTLS-INNER-TUNNEL)** or **802.1X (PEAP-INNER-TUNNEL)** to authenticate via another RADIUS server using an inner tunnel to protect the authentication request.

The Management Login authentication type allows you to set up a mapping specifically for authenticating management login requests, when an administrator logs into a switch's CLI via the console connection, SSH, or Telnet. This allows you to send management requests to a different authentication server than network access requests go to. This authentication type can be used to authenticate users locally, or proxy them to specific RADIUS or LDAP servers. Make sure that the Management Login mapping is

listed above the "Any" mapping in the list of mappings in your Advanced AAA Configuration. In addition, you must set the Auth. Access Type to either "Management Access" or "Any Access" in the Add/Edit Switches window for this authentication type.

### User/MAC/Host

Select the **Pattern** radio button and enter the username, MAC address, or hostname that the end-system must match for this mapping. Or, select the **Group** radio button and select a user group or end-system group from the drop-down list. If you enter a MAC address, you can use a colon (:) or a dash (-) as an address delimiter, but not a period (.).

### Location

Select the [location group](#) that the end-system must match for this mapping, or select "Any" if you don't want to require a location match. You can also add a new location group or edit an existing one.

### Authentication Method

Select the authentication method that the end-system must match for this mapping: Proxy RADIUS, LDAP Authentication, or Local Authentication.

**Primary RADIUS Server** — Use the drop-down menu to select the primary RADIUS server for this mapping to use. You can also add or edit a RADIUS server, or manage your RADIUS servers.

**Backup RADIUS Server** — Use the drop-down menu to select the backup RADIUS server for this mapping to use. You can also add or edit a RADIUS server, or manage your RADIUS servers.

**Inject Authentication Attrs** — Use the drop-down menu to select attributes to inject when proxying authentication requests to the back-end RADIUS servers. You can also add or edit a RADIUS attribute configuration, or manage your RADIUS attribute configurations.

**Inject Accounting Attrs** — Use the drop-down menu to select attributes to inject when proxying accounting requests to the back-end RADIUS servers. You can also add or edit a RADIUS attribute configuration, or manage your RADIUS attribute configurations.

**LDAP Authentication** — If you select LDAP Authentication, specify the LDAP configuration for this mapping to use.

**Local Authentication** — If desired, select the option to configure a password for all authentications that match the mapping. This option could be used with MAC authentication where the password is not the MAC address. For example, you may have MAC (PAP) authentication configured for all your switches, with the exception of MAC (MsCHAP) authentication configured for a wireless controller. For the wireless controller, you would add a new AAA mapping with the authentication type set to MAC (MsCHAP), the location set to the wireless controller location group, and the authentication method set to Local Authentication with the password for all authentications set to the static password configured on the wireless controller.

### **LDAP Configuration**

Use the drop-down menu to select the LDAP configuration for the LDAP servers on your network that you want to use for this mapping. You can also add or edit an LDAP configuration, or manage your LDAP configurations. You must specify an LDAP configuration if you have selected LDAP Authentication as your authentication method. However, you might also specify an LDAP configuration if you use Proxy RADIUS to a Microsoft NPS server that is running on a domain controller. The domain controller is also an LDAP server that can do RADIUS requests and LDAP requests for users on that server.

### **LDAP Policy Mapping**

Use the drop-down menu to select the LDAP Policy Mapping for this mapping. If you have selected an LDAP configuration, this option allows you to use a different LDAP policy mapping. This is useful if the LDAP configuration uses user attribute values that overlap with another LDAP configuration. For example, in the case of multiple companies where company A's Sales department uses one policy, but company B's Sales department uses a different policy.

---

### **Related Information**





For information on related windows:

## AAA Configurations

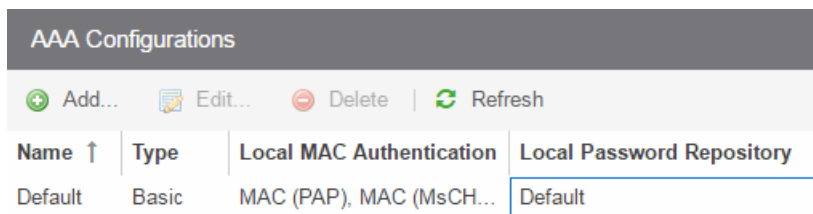
The AAA Configurations panel provides a list of your AAA configurations and buttons to add, edit, or delete configurations. AAA configurations define the RADIUS and LDAP configurations that provide the authentication and authorization services to your Extreme Access Control engines.

Access the Extreme Access Control Configurations panel in the **Control > Extreme Access Control** tab by expanding the **Extreme Access Control Configurations** tree in the left-panel and expanding the AAA Configurations tree. Your configurations are listed within the tree.



AAA Configurations			
 Add...  Edit...  Delete    Refresh			
Name ↑	Type	Local MAC Authentication	Local Password Repository
Default	Basic	MAC (PAP), MAC (MsCH...	Default

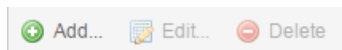

Use these buttons to add, edit, or delete the AAA configurations. Click **Add** to add a new configuration to the table. Then select the configuration in the table and click **Edit** to open the [Edit AAA Configurations](#) panel. Use the **Delete** button to remove any selected configuration(s).

### Name

The name of the AAA Configuration.

### Type

Whether the configuration is a [Basic configuration](#) or an [Advanced configuration](#).

### Local MAC Authentication

Indicates whether MAC authentication requests are handled locally by the Extreme Access Control engine and the type of MAC authentication that will be used.

### **Local Password Repository**

The local password repository specified for this AAA configuration. Extreme Management Center supplies a default repository that can be used to define passwords for administrators and sponsors accessing the Registration administration web page and the sponsor administration web page. The default password is Extreme@pp.

---

### **Related Information**

- [AAA Configurations](#)

## AAA Configurations

---

The AAA Configuration defines the RADIUS and LDAP configurations that provide the authentication and authorization services to your Extreme Access Control engines. A AAA Configuration can be a basic or advanced configuration. Basic AAA Configurations define the authentication and authorization services for all end-systems connecting to your Extreme Access Control engines. Advanced AAA configurations allow you to define different authentication and authorization services for different end users based on end-system to authentication server mappings.

This Help topic provides the following information for accessing and configuring the AAA Configuration:

- [Accessing the AAA Configuration](#)
- [Basic AAA Configuration](#)
- [Advanced AAA Configuration](#)

---

**NOTE:** Users with a AAA configuration using NTLM authentication to a back-end active directory domain whose passwords expire are prompted via windows to change their domain password.

---

## Accessing the AAA Configuration

Use the following steps to edit or change your AAA Configuration.

1. Open the **Control** tab in Extreme Management Center.
2. Select the **Access Control** tab.
3. Select **AAA Configurations** within the left-panel tree. The AAA Configuration is displayed in the right panel.
4. Use the fields in the right panel to edit or modify the configuration. See the sections below for a description of each field and option in the panel.
5. Click **Save** to save your changes.



## Basic AAA Configuration

Basic AAA Configurations define the RADIUS and LDAP configurations for all end-systems connecting to your Extreme Access Control engines.

Basic AAA Configuration - Default

Select AAA Configuration

Authenticate Requests Locally for:
  MAC (All)
  MAC (PAP)
  MAC (CHAP)
  MAC (MsCHAP)
  MAC (EAP-MD5)

Primary RADIUS Server: None

Backup RADIUS Server: None

LDAP Configuration: None

Local Password Repository: Default

Save Cancel

### Authenticate Requests Locally

This option lets you specify that MAC authentication requests are handled locally by the Extreme Access Control engine. Select this option if all MAC authentication requests are to be authorized, regardless of the MAC authentication password (except MAC (EAP-MD5) which requires a password that is the MAC address). The Accept policy is applied to end-systems that are authorized locally.

Select one or more MAC authentication types:

- MAC (All) — includes MAC (PAP), MAC (CHAP), MAC (MsCHAP), and MAC (EAP-MD5) authentication types.
- MAC (PAP) — this is the MAC authentication type used by Extreme Networks wired and wireless devices.
- MAC (CHAP)
- MAC (MsCHAP)
- MAC (EAP-MD5) — this MAC authentication type requires a password, which must be the MAC address.

### Primary/Backup RADIUS Servers

If your Extreme Access Control engines are configured to proxy RADIUS requests to a RADIUS server, use these fields to specify the primary and backup RADIUS servers

to use. Use the drop-down menu to select a RADIUS server, add or edit a RADIUS server, or manage your RADIUS servers.

### **LDAP Configuration**

Use this field to specify the LDAP configuration for the LDAP server on your network that you want to use in this AAA configuration. Use the drop-down menu to select an LDAP configuration, add or edit an LDAP configuration, or manage your LDAP configurations.

### **Local Password Repository**

Use this field to specify the local password repository you want for this AAA configuration. Extreme Management Center supplies a default repository to define passwords for administrators and sponsors accessing the Registration administration web page and the sponsor administration web page. The default password is Extreme@pp. Use the drop-down menu to select a repository.

## **Advanced AAA Configuration**

Advanced AAA configurations allow you to define different authentication and authorization services for different end users based on end-system to authentication server mappings. Mappings can be based on:

- authentication type
- username/user group
- MAC address/end-system group
- hostname/hostname group
- location group
- authentication method
- RADIUS user group
- LDAP user group

---

**NOTE:** LDAP User Group is only available with an Authentication Type of Registration.

---

For example, in a higher education setting, you may want faculty members authenticating to one RADIUS server and students authenticating to another. You can also create mappings specifically for authenticating management login requests, when an administrator logs into a switch's CLI via the console connection, SSH, or Telnet.

Mappings are listed in order of precedence from the top down. If an end-system does not match any of the listed mappings, the RADIUS request is dropped. Because of this, you might want to use the "Any" mapping (created automatically when you add a new advanced AAA configuration) as your last mapping in the list.

Advanced AAA Configuration - Advanced Configuration

Authenticate Requests Locally for:  MAC (All)  MAC (PAP)  MAC (CHAP)  MAC (MsCHAP)  MAC (EAP-MD5)

Local Password Repository:

Authentication Rules

Auth...	User/M...	Location	Auth...	Primary RA...	Backup RA...	Inject A...	Inject Ac...	LDAP Conf
Any	*	Any	Proxy ...	None	None	None	None	None

Save Cancel

### Authenticate Requests Locally for

This option lets you specify that MAC authentication requests are handled locally by the Extreme Access Control engine. Select this option if all MAC authentication requests are to be authorized, regardless of the MAC authentication password (except MAC (EAP-MD5) which requires a password that is the MAC address). The Accept policy is applied to end-systems authorized locally.

Use the drop-down menu to specify a particular type of MAC authentication:

- MAC (All) - includes MAC (PAP), MAC (CHAP), and MAC (EAP-MD5) authentication types.
- MAC (PAP) - this is the MAC authentication type used by Extreme Networks wired and wireless devices.
- MAC (CHAP)
- MAC (MsCHAP)
- MAC (EAP-MD5) - this MAC authentication type requires a password, and the password must be the MAC address.

### Local Password Repository

Use this field to specify the local password repository you want for this AAA configuration. Extreme Management Center supplies a default repository that can be used to define passwords for administrators and sponsors accessing the

Registration administration web page and the sponsor administration web page. The default password is Extreme@pp. Use the drop-down menu to select a repository.

### Join AD Domain

The Join AD Domain selection is only displayed if the AAA configuration has multiple mappings set to LDAP Authentication for an Active Directory domain, with different LDAP configurations specified. Specifying the domain to join is only necessary when multiple Active Directory domains are used but there is not a fully trusted relationship set up between all domains. If there is only a one-way trust set up between some domains you must choose the domain that can authenticate users from all the domains, which is determined by the configuration of a your Active Directory forest. Use the drop-down list to explicitly select which LDAP configuration of the Active Directory domain the Extreme Access Control engine joins in order to authenticate users to all Active Directory domains configured for that engine or select Auto Detect to let the Extreme Access Control engine determine the domain. Auto Detect starts at the first entry set to LDAP Authentication in the table and attempt to join that domain. If it cannot join that domain, it goes to the next entry set to LDAP Authentication and attempt to join that domain, and so on until one succeeds.

### User to Authentication Mapping Table

This table lists mappings between groups of users and authentication configurations. The table displays the username to match along with the defined configuration parameters for that mapping. Mappings are listed in order of precedence from the top down. If an end-system does not match any of the listed mappings, the RADIUS request is dropped. Because of this, you might want to use an "Any" mapping as your last mapping in the list. Use the Mappings toolbar buttons to perform actions on the mappings.

#### Up Down **Move Mappings Up/Down**

Move mappings up and down in the list to determine mapping precedence. Mappings are listed in order of precedence from the top down.

#### Add... **Add New Mapping**

Opens the [Add User to Authentication Mapping window](#) where you can define a new mapping.

#### Edit... **Edit Mapping**

Opens the [Edit User to Authentication Mapping window](#) where you can edit the selected mapping.

 **Delete Selected Mappings**

Deletes any mappings selected in the table.

---

### Related Information

For information on related windows:

- [Add User to Authentication Mapping Window](#)

## Manage LDAP Configurations

This panel lets you view and define the LDAP configurations used in Extreme Management Center. You can access this panel by selecting LDAP Configurations from the left-panel in the Extreme Access Control Configurations > AAA Configurations tree or from AAA Configuration, by clicking the drop-down menu in the LDAP Configuration field. Any changes made are written immediately to the Extreme Management Center database.

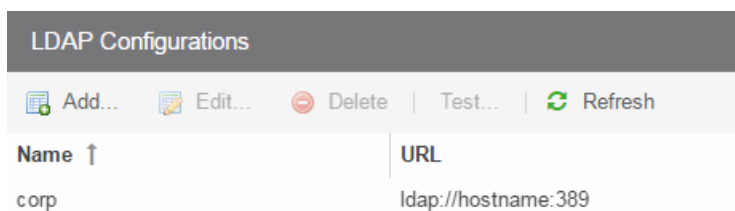

LDAP Configurations	
Name ↑	URL
corp	ldap://hostname:389

### LDAP Configurations Table

The name of the configuration and the LDAP server connection URLs specified for that configuration.

### Test Configuration Button

Use this button to run a connection test for the selected configuration. The connection to the LDAP server is tested and a report on connection test results is provided. There is also a user search that lets you search on a user entry value and display the attributes associated with the user.

### Add Configuration Button

Opens the [Add LDAP Configuration window](#) where you can define a new LDAP configuration.

### Edit Configuration Button

Opens the [Edit LDAP Configuration window](#) where you can edit the selected LDAP configuration.

### Delete Configuration Button

Deletes the selected LDAP configuration(s).

## Related Information

For information on related windows:

- [Add/Edit LDAP Configuration window](#)

## Add LDAP Configuration Window

---

Use the Add LDAP Configuration window to configure the LDAP servers on your network. You can access this window from the [Users/Groups tab](#) in the Authorization/Device Access tool, or in NAC Manager from the AAA Configuration window, by selecting New from the drop-down menu in the LDAP Configuration field. You can also access this window from the [Manage LDAP Configurations window](#). Any changes made in this window are written immediately to the Extreme Management Center database.

---

**NOTE:** If you are using LDAPS, your Extreme Management Center/Extreme Access Control environment must be configured to accept the new LDAPS server certificate. For information, see Server Certificate Trust Mode in the Secure Communications Help topic.

---



### Add LDAP Configuration

Configuration Name:

LDAP Connection URLs

Add... Edit... Delete Up Down

Authentication Settings

Administrator Username:

Administrator Password:

Timeout (seconds):

Search Settings

User Search Root:

Host Search Root:

OU Search Root:

Schema Definition

User Object Class:

User Search Attribute:

Keep Domain Name for User Lookup:

User Authentication Type:

Test... | Populate Default Values

Save Cancel

**Configuration Name**

Enter a name for the LDAP configuration.

## LDAP Connection URLs

Use this table to add, edit, or delete connection URLs for the LDAP server and any backup servers you have configured. (The backup servers are redundant servers containing the same directory information.) Use the Up and Down arrows to arrange the order that the URLs are listed.

The format for the connection URL is `ldap://host:port` where host equals hostname or IP address, and the default port is 389. For example, `ldap://10.20.30.40:389`. If you are using a secure connection, the format is `ldaps://host:port` and the default port is 636. For example, `ldaps://10.20.30.40:636`. If you are using LDAPS, your Extreme Management Center/Extreme Access Control environment must be configured to accept the new LDAPS server certificate. For information, see Server Certificate Trust Mode in the Secure Communications Help topic.

If you are creating an LDAP configuration for Novell eDirectory, be aware that the eDirectory may require that the universal password lookup be done using LDAPS. If you configure the URL for LDAP only, the lookup may fail.

## Authentication Settings

Enter the administrator username and password that will be used to connect to the LDAP server to make queries. The credentials only need to provide read access to the LDAP server. The timeout field lets you specify a timeout value in seconds for the LDAP server connection.

## Search Settings

For the three fields, enter the root node of the LDAP server. To improve search performance, you can specify a sub tree node to confine the search to a specific section of the directory. The search root format should be a DN (Distinguished Name).

## Schema Definition

Provide information that describes how entries are organized in the LDAP server.

Schema Definition fields:

- **User Object Class** - enter the name of the class used for users.
- **User Search Attribute** - enter the name of the attribute in the user object class that contains the user's login ID.
- **Keep Domain Name for User Lookup** - If selected, this option will allow the full username to be used when looking up the user in LDAP. For example, you

should select this option when using the User Search Attribute:  
userPrincipalName.

If the option is not selected, the domain name will be stripped off the username prior to performing the lookup. For example, you should deselect this option when using the User Search Attribute: sAMAccountName. Two examples of the domain name being stripped off would be:

user@domain.com -> user

DOMAIN\user -> user

- **User Authentication Type** - Specify how the user is authenticated. There are 4 options:
  - LDAP Bind - This is the easiest option to configure, but only works with a plain text password. It is useful for authentication from the captive portal but does not work with most 802.1x authentication types.
  - NTLM Auth - This option is only useful when the backend LDAP server is really a Microsoft Active Directory server. This is an extension to LDAP bind that uses ntlm\_auth to verify the NT hash challenge responses from a client in MsCHAP, MsCHAPV2, and PEAP requests.
  - NT Hash Password Lookup - If the LDAP server has the user's password stored as an NT hash that is readable by another system, you can have Extreme Access Control read the hash from the LDAP server to verify the hashes within an MsCHAP, MsCHAPV2, and PEAP request.
  - Plain Text Password Lookup - If the LDAP server has the user's password stored unencrypted and that attribute is accessible to be read via an LDAP request, then this option reads the user's password from the server at the time of authentication. This option can be used with any authentication type that requires a password.
- **User Password Attribute** - This is the name of the password used with the NT Hash Password Lookup and Plain Text Password Lookup listed above.
- **Host Object Class** - enter the name of the class used for hostname.

- **Host Search Attribute** - enter the name of the attribute in the host object class that contains the hostname.
- **Use Fully Qualified Domain Name** checkbox - use this checkbox to specify if you want to use the Fully Qualified Domain Name (FQDN) or just hostname without domain.
- **OU Object Classes** - the names of the classes used for organizational units.

### **Test Button**

The connection to the LDAP server is tested and a report on connection test results is provided. There is also a user/host search that lets you search on a user entry or host entry value and display the attributes associated with those values.

### **Populate Default Values Button**

Select from the defaults available from the menu:

- **Active Directory: User Defaults** - Settings that allow user authentication when Extreme Access Control is set to proxy to LDAP and the server is an Active Directory machine.
- **Active Directory: Machine Defaults** - Settings that allow machine authentication when Extreme Access Control is set to proxy to LDAP and the server is an Active Directory machine.
- **OpenLDAP Defaults** - Settings that allow Extreme Access Control to verify the user's password via an OpenLDAP server. See the NAC Manager How to Configure PEAP Authentication via OpenLDAP Help topic for information.
- **Novell eDirectory Defaults** - Settings that allow Extreme Access Control to read the universal password from Novell eDirectory. You must configure eDirectory to allow that password to be read. See the NAC Manager How to Configure PEAP Authentication via eDirectory Help topic for information.

---

### **Related Information**

For information on related windows:

- [Manage LDAP Configurations Window](#)

## Edit LDAP Configuration Window

---

Use the Edit LDAP Configuration window to configure the LDAP servers on your network. You can access this window from the [Users tab](#) in the Authorization/Device Access tool, or in NAC Manager from the AAA Configuration window, by selecting an LDAP configuration from the drop-down menu in the LDAP Configuration field. You can also access this window from the [Manage LDAP Configurations window](#). Any changes made in this window are written immediately to the Extreme Management Center database.

---





**NOTE:** If you are using LDAPS, your Extreme Management Center/Extreme Access Control environment must be configured to accept the new LDAPS server certificate. For information, see Server Certificate Trust Mode in the Secure Communications Help topic.

---

Configuration Name:

---

LDAP Connection URLs

 Add...  Edit...  Delete  Up  Down

ldap://

---

Authentication Settings

Administrator Username:

Administrator Password:  

Timeout (seconds):

---

Search Settings

User Search Root:

Host Search Root:

OU Search Root:

---

Schema Definition

User Object Class:

User Search Attribute:

Keep Domain Name for User Lookup:

User Authentication Type:

User Password Attribute:

Host Object Class:

Host Search Attribute:

Use Fully Qualified Domain Name:

OU Object Classes:

Test... | Populate Default Values

**Configuration Name**

The name for the LDAP configuration you defined.

**LDAP Connection URLs**

Use this table to add, edit, or delete connection URLs for the LDAP server and any backup servers you have configured. (The backup servers are redundant servers containing the same directory information.) Use the Up and Down arrows to arrange the order that the URLs are listed.

The format for the connection URL is `ldap://host:port` where host equals hostname or IP address, and the default port is 389. For example, `ldap://10.20.30.40:389`. If you are using a secure connection, the format is `ldaps://host:port` and the default port is 636. For example, `ldaps://10.20.30.40:636`. If you are using LDAPS, your Extreme Management Center/Extreme Access Control environment must be configured to accept the new LDAPS server certificate. For information, see Server Certificate Trust Mode in the Secure Communications Help topic.

If you are creating an LDAP configuration for Novell eDirectory, be aware that the eDirectory may require that the universal password lookup be done using LDAPS. If you configure the URL for LDAP only, the lookup may fail.

**Authentication Settings**

Enter the administrator username and password that will be used to connect to the LDAP server to make queries. The credentials only need to provide read access to the LDAP server. The timeout field lets you specify a timeout value in seconds for the LDAP server connection.

**Search Settings**

For the three fields, enter the root node of the LDAP server. To improve search performance, you can specify a sub tree node to confine the search to a specific section of the directory. The search root format should be a DN (Distinguished Name).

**Schema Definition**

Provide information that describes how entries are organized in the LDAP server.

Schema Definition fields:

- **User Object Class** - enter the name of the class used for users.

- **User Search Attribute** - enter the name of the attribute in the user object class that contains the user's login ID.
- **Keep Domain Name for User Lookup** - If selected, this option will allow the full username to be used when looking up the user in LDAP. For example, you should select this option when using the User Search Attribute: userPrincipalName.

If the option is not selected, the domain name will be stripped off the username prior to performing the lookup. For example, you should deselect this option when using the User Search Attribute: sAMAccountName. Two examples of the domain name being stripped off would be:

user@domain.com -> user  
DOMAIN\user -> user

- **User Authentication Type** - Specify how the user is authenticated. There are 4 options:
  - **LDAP Bind** - This is the easiest option to configure, but only works with a plain text password. It is useful for authentication from the captive portal but does not work with most 802.1x authentication types.
  - **NTLM Auth** - This option is only useful when the backend LDAP server is really a Microsoft Active Directory server. This is an extension to LDAP bind that uses ntlm\_auth to verify the NT hash challenge responses from a client in MsCHAP, MsCHAPV2, and PEAP requests.
  - **NT Hash Password Lookup** - If the LDAP server has the user's password stored as an NT hash that is readable by another system, you can have Extreme Access Control read the hash from the LDAP server to verify the hashes within an MsCHAP, MsCHAPV2, and PEAP request.
  - **Plain Text Password Lookup** - If the LDAP server has the user's password stored unencrypted and that attribute is accessible to be read via an LDAP request, then this option reads the user's password from the server at the time of authentication. This option can be used with any authentication type that requires a password.



- **User Password Attribute** - This is the name of the password used with the NT Hash Password Lookup and Plain Text Password Lookup listed above.
- **Host Object Class** - enter the name of the class used for hostname.
- **Host Search Attribute** - enter the name of the attribute in the host object class that contains the hostname.
- **Use Fully Qualified Domain Name** checkbox - use this checkbox to specify if you want to use the Fully Qualified Domain Name (FQDN) or just hostname without domain.
- **OU Object Classes** - the names of the classes used for organizational units.

### **Test Button**

The connection to the LDAP server is tested and a report on connection test results is provided. There is also a user/host search that lets you search on a user entry or host entry value and display the attributes associated with those values.

### **Populate Default Values Button**

Select from the defaults available from the drop-down menu:

- **Active Directory: User Defaults** - Settings that allow user authentication when Extreme Access Control is set to proxy to LDAP and the server is an Active Directory machine.
- **Active Directory: Machine Defaults** - Settings that allow machine authentication when Extreme Access Control is set to proxy to LDAP and the server is an Active Directory machine.
- **OpenLDAP Defaults** - Settings that allow Extreme Access Control to verify the user's password via an OpenLDAP server. See the NAC Manager How to Configure PEAP Authentication via OpenLDAP Help topic for information.
- **Novell eDirectory Defaults** - Settings that allow Extreme Access Control to read the universal password from Novell eDirectory. You must configure eDirectory to allow that password to be read. See the NAC Manager How to Configure PEAP Authentication via eDirectory Help topic for information.

---

### **Related Information**

For information on related windows:

- [Manage LDAP Configurations Window](#)

## Manage RADIUS Servers

This panel lets you view and define the RADIUS servers used in Extreme Management Center. RADIUS servers can be used in Extreme Management Center server authentication configurations and in Extreme Access Control AAA configurations.

You can access this panel by selecting RADIUS Servers from the Extreme Access Control Configurations > AAA Configurations > RADIUS Servers in the left-panel tree, or from the [Configure Device window](#) or AAA Configuration window. Any changes made are written immediately to the Extreme Management Center database.

RADIUS Server IP	Auth Port	Acct Port	Timeout Duration	Number of Retries	Shared Secret
	1812	1813	2	1	*****

### RADIUS Server IP

The IP address of the RADIUS server.

### Auth Port

The UDP port number (1-65535) on the RADIUS server to which the Extreme Management Center server or Extreme Access Control engine sends authentication requests; 1812 is the default port number.

### Acct Port

The UDP port number (1-65535) on the RADIUS server to which the Extreme Access Control engine sends accounting requests; 1813 is the default port number.

### Timeout Duration

The amount of time, in seconds, the Extreme Management Center server or Extreme Access Control engine waits for the RADIUS server to respond to an authentication or accounting request. Valid values are 2-60 seconds.

### Number of Retries

The number of times the Extreme Management Center server or Extreme Access Control engine resends an authentication or accounting request if the RADIUS server does not respond. Valid values are 0-20.

**Shared Secret**

The shared secret used to encrypt and decrypt communication between the Extreme Management Center server or Extreme Access Control engine and the RADIUS server. In Extreme Access Control, this is also the shared secret used between the switch and the RADIUS server if the Extreme Access Control engine is bypassed or if you configured the Management RADIUS Server options when you added the switch.

**Show Shared Secrets**

When checked, the shared secrets are shown in text. When unchecked, the shared secrets are shown as a string of asterisks.

**Used By Button**

This button is only available when the panel is launched from Extreme Access Control. Opens the RADIUS Server(s) Used By window which shows where the selected servers are in use by AAA configurations.

**Add Button**

Opens the [Add RADIUS Server window](#) where you can define a new RADIUS server.

**Edit Button**

Opens the [Edit RADIUS Server window](#) where you can edit the values for the selected RADIUS server.

**Delete Button**

Deletes the selected RADIUS server. You cannot delete servers currently in use.

---

**Related Information**

For information on related windows:

- [Add/Edit RADIUS Server Window](#)

## Add/Edit RADIUS Server

Use the Add/Edit RADIUS Server window to configure the RADIUS servers used in your Extreme Management Center applications. RADIUS servers can be used in Extreme Management Center server authentication configurations and in Extreme Access Control AAA configurations.

You can access this window from the Manage RADIUS Servers window. Any changes made in this window are written immediately to the Extreme Management Center database.

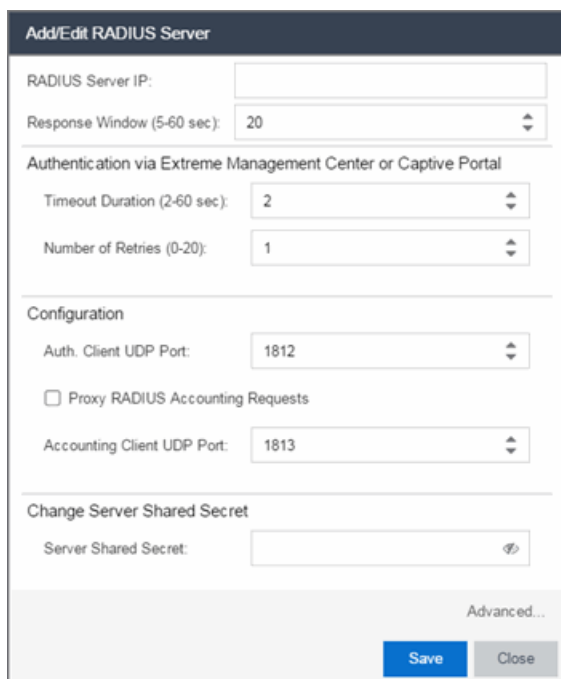

The screenshot shows the 'Add/Edit RADIUS Server' configuration window. It contains the following fields and sections:

- RADIUS Server IP:** A text input field.
- Response Window (5-60 sec):** A spinner control set to 20.
- Authentication via Extreme Management Center or Captive Portal:**
  - Timeout Duration (2-60 sec):** A spinner control set to 2.
  - Number of Retries (0-20):** A spinner control set to 1.
- Configuration:**
  - Auth. Client UDP Port:** A spinner control set to 1812.
  - Proxy RADIUS Accounting Requests
  - Accounting Client UDP Port:** A spinner control set to 1813.
- Change Server Shared Secret:**
  - Server Shared Secret:** A text input field with a toggle icon.

At the bottom right, there is an 'Advanced...' link and two buttons: 'Save' (blue) and 'Close' (grey).

### RADIUS Server IP

The IP address of the RADIUS server.

### Response Window

This setting is used by Extreme Access Control when proxying a RADIUS request to a backend RADIUS server. Extreme Access Control keeps a status on all backend RADIUS servers instead of going to the primary RADIUS server for every request. If a RADIUS server does not respond in the amount of time specified here, that server is marked as down until it can be verified as being up. See the [Health Check](#) section of the Advanced RADIUS Server Configuration window for information on how Extreme Access Control determines the health of a RADIUS server.

**Timeout Duration**

The amount of time in seconds the Extreme Management Center server or Extreme Access Control waits for the RADIUS server to respond to an authentication or accounting request. Valid values are 2-60 seconds. This setting is only used for logging into Extreme Management Center via RADIUS or logging into the Extreme Access Control Captive Portal via RADIUS.

---

**NOTE:** The Extreme Access Control engine times out a RADIUS server if it takes more than "(retries +1) \* timeout" or 20 seconds, whichever is greater, for the server to respond. For example, if the number of retries is set to 1 and the timeout duration is set to 2 (the default values), then the engine times out a RADIUS server if it takes longer than 20 seconds to respond, because that is the greater value (20 to 4). If the RADIUS server times out, then Extreme Access Control fails over to the backup RADIUS server until it determines that the primary server is back up. At that point, Extreme Access Control starts proxying RADIUS requests to the primary server again.

---

**Number of Retries**

The number of times the Extreme Management Center server or Extreme Access Control engine resends an authentication or accounting request if the RADIUS server does not respond. Valid values are 0-20. This setting is only used for logging into Extreme Management Center via RADIUS or logging into the Extreme Access Control Captive Portal via RADIUS.

**Auth. Client UDP Port**

The UDP port number (1-65535) on the RADIUS server that the Extreme Management Center server or Extreme Access Control engine sends authentication requests to; 1812 is the default port number.

**Proxy RADIUS Accounting Requests**

Select this checkbox to enable the Extreme Access Control engine to proxy RADIUS accounting requests to the RADIUS server. This option must be enabled if you are doing RADIUS accounting in an Extreme Access Control environment where the primary RADIUS server is being used for redundancy in a single Extreme Access Control engine configuration (Basic AAA configuration only).

**Accounting Client UDP Port**

The UDP port number (1-65535) on the RADIUS server that the Extreme Access Control engine sends accounting requests to; 1813 is the default port number.

**Server Shared Secret**

The shared secret is a string of characters used to encrypt and decrypt communication between the Extreme Management Center server or Extreme Access

Control and the RADIUS server. In Extreme Management Center, this is also the shared secret used between the switch and the RADIUS server if the Extreme Access Control engine is bypassed or if you configured the Management RADIUS Server options when you added the switch. The shared secret must be at least 6 characters long; 16 characters is recommended. Dashes are allowed in the string, but spaces are not.

**Verify Shared Secret**

Re-enter the Server Shared Secret you entered above.

**Show Shared Secret**

Displays the secret in the **Server Shared Secret** and **Verify Shared Secret** fields.

**Advanced Button**

Use this button to open the [Advanced RADIUS Server Configuration window](#), where you can configure advanced RADIUS settings used by Extreme Access Control when proxying access requests to a backend RADIUS server.

---

**Related Information**

For information on related windows:

- [Manage RADIUS Servers Window](#)
- [Advanced RADIUS Server Configuration Window](#)

## Manage RADIUS Attribute Configurations Window

Use this window to view attributes injected when authentication or accounting requests are proxied to a back-end RADIUS server. Attributes you inject provide additional information about the users on your network. You can access the RADIUS Attribute Configurations window from the [Add/Edit User To Authentication Mapping window](#).

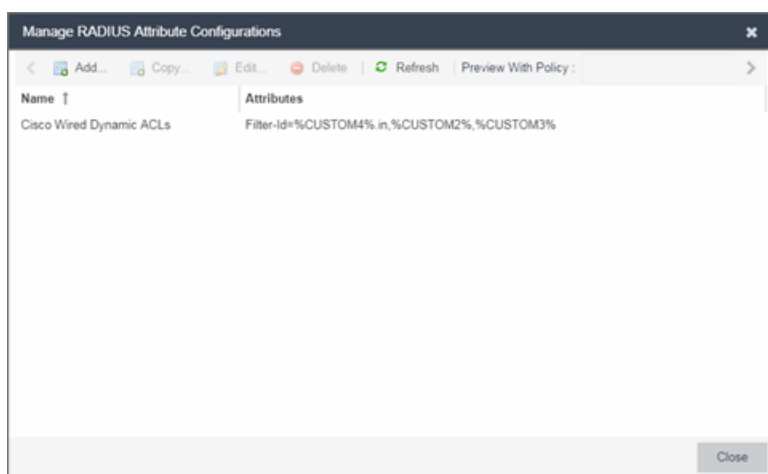

### Preview With Policy

Presents a preview of the attributes defined for selected attribute configuration.

### Name

The names of the available attribute configurations. You cannot edit the name of a configuration.

### Add

Select the **Add** button to open the [Create New RADIUS Attribute Settings window](#), which allows you to create a new attribute configuration.

### Edit

Select the **Edit** button to open the [Edit RADIUS Attribute Settings window](#), which allows you to edit an existing attribute configuration.

### Delete

Select an attribute and click the **Delete** button to remove an existing attribute configuration.

## Related Information

For information on related windows:

- [Add/Edit User To Authentication Mapping Window](#)
- [Create New RADIUS Attribute Settings Window](#)



## Advanced RADIUS Server Configuration

Use this window to configure advanced RADIUS settings used by Extreme Management Center when proxying authentication requests to a backend RADIUS server. You can access this window by clicking the **Advanced** button at the bottom of the [Add/Edit RADIUS Server window](#).

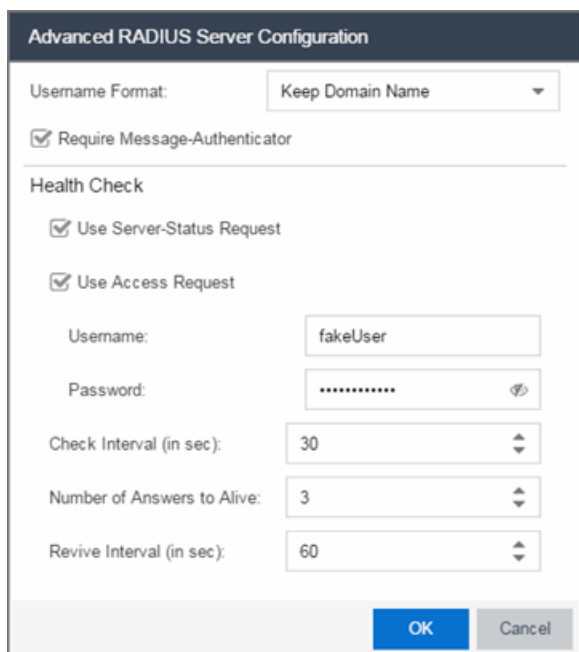

The screenshot shows the 'Advanced RADIUS Server Configuration' dialog box. It has a dark header with the title. Below the header, there is a 'Username Format' dropdown menu set to 'Keep Domain Name'. A checkbox labeled 'Require Message-Authenticator' is checked. A section titled 'Health Check' contains two checked checkboxes: 'Use Server-Status Request' and 'Use Access Request'. Below these are input fields for 'Username' (containing 'fakeUser'), 'Password' (masked with dots and a visibility icon), 'Check Interval (in sec)' (30), 'Number of Answers to Alive' (3), and 'Revive Interval (in sec)' (60). At the bottom right are 'OK' and 'Cancel' buttons.

### Username Format

This field is used by Extreme Management Center to determine what format to use for the username when proxying a request to the backend RADIUS server. There are two options:

- **Strip Domain Name** (*default*) - This option removes a domain name from the username when proxying the request. Select this option unless the backend RADIUS server requires the domain name to be included.
- **Keep Domain Name** - This option keeps any domain names on the username when proxying the request to the backend RADIUS server. If the backend RADIUS server is a Microsoft IAS or NPS server, this option could cause the RADIUS server to time out if a guest comes onto the network with another domain. In that scenario, if the request is proxied to the backend RADIUS

server with the domain name, the server does not respond to the request because it is from an unknown domain. Therefore, if you use this option with a Microsoft IAS or NPS server, use an advanced AAA configuration so that only requests for the desired domain(s) are sent to the backend RADIUS server, and all unknown domains are processed locally so they are rejected.

**Require Message-Authenticator**

Enable this checkbox if the backend RADIUS server requires a message authenticator to be part of the request. If enabled, Extreme Management Center adds the message authenticator when proxying the request.

## Health Check Section

Extreme Management Center uses the options in this section to determine how to check the health of a backend RADIUS server, if that server stops responding to requests.

**Use Server-Status Request**

When selected, Extreme Management Center attempts to use Server-Status RADIUS packets as defined by RFC 5997, to determine if the backend RADIUS server is up.

**Use Access Request**

When selected, Extreme Management Center attempts to use an access request message to determine if the RADIUS server is up. The request is made using the username and password specified below. The username and password do not need to be valid, as Extreme Management Center is looking for a response and a reject also works. The username/password fields are provided in case you want to prevent rejects from being logged in the backend RADIUS server.

**Check Interval**

The interval to wait between checks to see if the RADIUS server is up. This is only applicable if the Server-Status request or Access request methods are used.

**Number of Answers to Alive**

The number of times the RADIUS server must respond before it is marked as alive. This is only applicable if the Server-Status request or Access request methods are used.

**Revive Interval**

If Server-Status requests and Access requests are not allowed or supported by the RADIUS server, then Extreme Management Center waits the amount of time specified here before allowing requests to go to a backend RADIUS server, if it stops

responding. Only use this if there is no other way to detect the health of the backend RADIUS server.

---

### **Related Information**

For information on related windows:

- [Manage RADIUS Servers Window](#)
- [Add/Edit RADIUS Server Window](#)

---

## Policy Mapping Configuration

---

In your Extreme Access Control profiles, each access policy (Accept, Quarantine, Failsafe, and Assessment) is associated to a *policy mapping* that defines exactly how end-system traffic is handled on the network. Each mapping specifies a policy role (created in the **Policy** tab) and/or any additional RADIUS attributes included as part of a RADIUS response to a switch.

The RADIUS attributes required by a switch are specified in the Gateway RADIUS Attributes to Send field configured in the [Edit Switch window](#). The actual switch RADIUS attribute values (Login-LAT-Port, Custom 1, etc.) are defined within each policy mapping configured in this window. Each policy mapping is associated with the access policy selected in your Extreme Access Control profiles.

When an end-system authenticates to the network, the Extreme Access Control profile is applied and the appropriate RADIUS response attributes are extracted from the mapping based on the switch the authentication request originated from. The attributes are returned to the switch in the RADIUS Access-Accept response.

For more information on configuring policy mappings, see [How to Set Up Access Policies and Policy Mappings](#). For a description of each Extreme Access Control access policy, and some guidelines for creating corresponding policy roles in the **Policy** tab, see the section on [Access Policies](#) in the Concepts file.

To access this window, click on the **Policy Mappings** left-panel option in the **Extreme Access Control Configurations > Access Control** left-panel menu.

The columns displayed in this window vary depending on whether you are using a Basic or Advanced policy mapping configuration. For a definition of each column, [see below](#).

### Basic AAA Configuration

Basic AAA Configurations define the RADIUS and LDAP configurations for all end-systems connecting to your Extreme Access Control engines.

Policy Mapping Configuration - Default

➕ Add...
✎ Edit...
🗑 Delete
Switch to Advanced
🔄 Refresh

Name ↑	Policy Role
Administrator	Administrator
Assessing	Assessing
Deny Access	Deny Access
Enterprise Access	Enterprise A...
Enterprise User	Enterprise U...
Enterprise User (Administrator)	Enterprise U...
Enterprise User (Read-Only Manage...	Enterprise U...
Failsafe	Failsafe
Guest Access	Guest Access
MikeN	MikeN
Notification	Notification
Quarantine	Quarantine
Unregistered	Unregistered

Advanced Policy Mapping Configuration

Policy Mapping Configuration - Default

➕ Add...
✎ Edit...
🗑 Delete
Switch to Basic
🔄 Refresh

Name ↑	Policy Role	Location	VLAN Name	VLAN Egress	Login-LAT...	Login-LAT...	Management	Mgmt Service Type	CLI Access	Filter
Administrator	Administrator	Any	None	Untagged						
Assessing	Assessing	Any	None	Untagged	Assessing	0				Ass
Deny Access	Deny Access	Any	None	Untagged	Deny Access	0				Den
Enterprise Access	Enterprise A...	Any	None	Untagged						
Enterprise User	Enterprise U...	Any	None	Untagged	Enterprise U...	1				Enti
Enterprise User (Ad...	Enterprise U...	Any	None	Untagged	Enterprise U...	1	mgmt-rau:	6	1	Enti
Enterprise User (Rea...	Enterprise U...	Any	None	Untagged	Enterprise U...	1	mgmt-ro:	1	1	Enti
Failsafe	Failsafe	Any	None	Untagged	Failsafe	0				Fail
Guest Access	Guest Access	Any	None	Untagged	Guest Access	1				Gue
Notification	Notification	Any	None	Untagged	Notification	0				Noti
Quarantine	Quarantine	Any	None	Untagged	Quarantine	0				Qua
Unregistered	Unregistered	Any	None	Untagged	Unregistered	0				Unr

## Column Definitions

### Name

The policy mapping name.

### Policy Role

The policy role assigned to this mapping. All policy roles used in your mappings must be part of your Extreme Access Control (Extreme Access Control) Controller policy configuration and/or defined in the **Policy** tab and enforced to the policy-enabled switches in your network.

### Location

Policy mapping locations allow authentication requests that match the same Extreme Access Control rule and corresponding Extreme Access Control profile to be authorized to different accept attributes (policy/VLAN/Custom Attribute) based

on the location the request originated from. For example, in the [Policy Mapping Configuration screenshot](#) above, the Administration policy mapping has five entries, with each entry assigning a different VLAN (for RFC 3580-enabled switches) for authentication requests matching the specified location. Requests originating from the 1st floor South location will be authorized to VLAN 100, and requests originating from the 2nd floor North location (matching the same Extreme Access Control rule) is authorized to VLAN 220. Using locations in this manner lets you authorize end-systems to different access criteria using a single Extreme Access Control rule, whereas the alternative would be to create multiple location-based Extreme Access Control rules each with an Extreme Access Control Profile that corresponds with the desired access value.

When policy mapping locations are used in this manner, it is important to include a catch-all policy mapping (the fifth Administration mapping in the example above) that has a location of "any" and sets the access behavior for an authorization originating from any other location. The access behavior could be a policy/VLAN/Custom Attribute that grants some form of restricted access, or denies access altogether. If a catch-all mapping is not included, a warning message may appear on enforce indicating that there is no catch-all mapping configured, and authorizations that match the policy but do not originate from a defined location, may result in errors or unpredictable behavior.

**VLAN Name**

If you have RFC 3580-enabled switches in your network, this column displays the VLAN name assigned to this mapping.

**VLAN Egress**

If you have RFC 3580-enabled switches in your network, this column displays the VLAN ID assigned to this mapping.

**Filter**

This value is only displayed in Basic mode if ExtremeWireless Controllers have been added to Extreme Management Center. The Filter column typically maps to the Filter-Id RADIUS attribute. This value applies to ExtremeWireless Controllers and other switches that support the Filter-Id attribute.

**Login-LAT-Group**

If your network devices require a Login-LAT-Group, it displays here.

**Login-LAT-Port**

If you have ExtremeWireless Controllers on your network, the Login-LAT-Port is an attribute returned in the default RADIUS response. The Login-LAT-Port value is used by the controller to determine whether the authentication is fully authorized. A value of "1" indicates the authentication is authorized, where a value of "0" indicates that authorization is not complete. The value of "0" is used by the controller to determine that additional authentication is required and is a signal for the controller to engage its external captive portal and use HTTP redirection to force HTTP traffic from the end-system to the defined Extreme Access Control engine. This is used in conjunction with the Registration and Assessment features of Extreme Access Control.

**Management**

The authorization attribute returned for successful administrative access authentication requests that originate from network equipment configured to use RADIUS as the authentication mechanism for remote management of switches, routers, VPN concentrators, etc. Examples of management values for EOS devices are: "mgmt=su:", "mgmt=rw:", or "mgmt=ro:". The management attribute determines the level of access the administrator will have when authorized to access the device: superuser, read/write, or read-only.

**Custom**

Some network devices require additional RADIUS response attributes in order to provide authorization or define additional parameters for the authenticated session. These additional attributes can be defined in the five available Custom option fields.

**Attribute List 1-3**

The **Attribute List** fields display additional RADIUS response attributes in a single mapping. For example, you can use each field to provide a complete ACL for a different third-party vendor.

---

**Related Information**

For information on related windows:

- [Add/Edit Policy Mapping Window](#)
- [How to Set Up Access Policies and Policy Mappings](#)

## Add/Edit Policy Mapping

---

Use this window to add a new policy mapping or edit an existing policy mapping. A policy mapping specifies a policy role (created on the **Policy** tab) and/or any additional RADIUS attributes included as part of a RADIUS response to a switch (as defined in the Gateway RADIUS Attributes to Send field configured in the [Edit Switch window](#)). For additional information about configuring policy mappings, see [How to Set Up Access Policies and Policy Mappings](#).

Access this window by clicking the **Add** or **Edit** toolbar buttons in the [Edit Policy Mapping Configuration window](#).

The fields in this window vary depending on whether you are using a basic or advanced policy mapping configuration. For a definition of each field, see below.



**Policy Mapping Configuration - Default**

Add Policy Mapping

Name:

Map to Location:

Policy Role:

VLAN [ID] Name:

VLAN Egress:

Filter:

Port Profile:

Virtual Router:

Login-LAT-Group:

Login-LAT-Port:

Custom 1:

Custom 2:

Custom 3:

Custom 4:

Custom 5:

**RADIUS Attribute Lists**

Organization 1:

Organization 2:

Organization 3:

**Management**

Access:

Management:

Mgmt Service Type:

CLI Access:

**Name**

Enter a name for the policy mapping.

**Map to Location**

Allows you to specify a certain location for the mapping. You should first configure your locations using the Location Group (**Control** tab > **Extreme Access Control** > Extreme Access Control Configurations > Group Editor > Location Groups) or you can click the **Edit** button to the right of the field to add a location group to the list. For more information on using the Location option in Policy Mappings, see the [Edit Policy Mapping Configuration Window](#) Help topic.

**Policy Role**

Use the drop-down menu to select a policy role, or enter a policy role in the field. The drop-down menu displays any policy roles you have created and saved in the **Policy** tab and/or all the policy roles contained in the Extreme Access Control Controller policy configuration. Roles from all your policy domains are listed; if there are duplicate names, only one is listed. The list is not case sensitive, so "Enterprise User" and "enterprise user" are considered duplicate policy names. All policy roles used in your mappings must be part of your Extreme Access Control) Controller policy configuration and/or defined in **Policy** tab and enforced to the EOS policy-enabled switches in your network.

---

**NOTE:** Entering a new policy role does **not** create a new role in the **Policy** tab.

---

**VLAN [ID] Name**

Use the drop-down menu to select the appropriate VLAN associated with the policy. This list displays any VLANs defined in Extreme Management Center. Click the configuration menu button  to the right of the field to add a VLAN to the list. VLANs you add remain in the list only as long as they are used in a mapping and they are **not** added to the Extreme Management Center database.

**VLAN Egress**

Use the drop-down menu to select the appropriate VLAN the egress forwarding state: Tagged (frames are forwarded as tagged), Untagged (frames are forwarded as untagged), Same as Ingress (frames are forwarded as specified by the VLAN Ingress), or User Defined (you define how frames are forwarded).

**Filter**

If your network devices require a custom Filter-Id, enter it here. The Filter column typically maps to the Filter-Id RADIUS attribute. This value applies to ExtremeWireless Controllers and other switches that support the Filter-Id attribute.

**Port Profile**

For ExtremeXOS devices on which legacy firmware is installed, this field indicates the profile used by Extreme Policy.

**Login-LAT-Group**

If your network devices require a Login-LAT-Group, enter it here.

**Login-LAT-Port**

If you have ExtremeWireless Controllers on your network, the Login-LAT-Port is an attribute returned in the default RADIUS response. The Login-LAT-Port value is used by the controller to determine whether the authentication is fully authorized. A value of "1" indicates the authentication is authorized, where a value of "0" indicates that authorization is not complete. The value of "0" is used by the controller to determine that additional authentication is required and is a signal for the controller to engage its external captive portal and use HTTP redirection to force HTTP traffic from the end-system to the defined Extreme Access Control engine. This is used in conjunction with the Registration and Assessment features of Extreme Access Control.

**Custom**

If your network devices require additional RADIUS response attributes in order to provide authorization or define additional parameters for the authenticated session, you can define them in the five available Custom option fields.

**Organization 1-3**

Enter additional RADIUS response attributes in a single mapping in the **Organization** fields. For example, you can use each field to provide a complete ACL for a different third-party vendor.

**Management**

Enter a management attribute used to authenticate requests for administrative access to the selected switches, for example, "mgmt=su:", "mgmt=rw:", or "mgmt=ro:". The management attribute determines the level of access the administrator will have to the switch: superuser, read/write, or read-only. Be sure to include the final colon (":") in the attribute, or the management access will not work.

---

**Related Information**

For information on related windows:

- [Edit Policy Mapping Configuration Window](#)

## Access Control Profiles

Extreme Management Center comes with ten system-defined Extreme Access Control profiles that define the authorization and assessment requirements for the end-systems connecting to the network. The system-defined profiles are: Administrator, Allow, Default, Guest Access, Notification, Pass Through, Quarantine, Registration Denied Access, Secure Guest Access, and Unregistered. You can use this window to view and edit these profiles, and define new profiles if desired. Any changes made in this window are written immediately to the Extreme Management Center database.

To access this window, select the Extreme Access Control Profiles left-panel option in the **Access Control** tab.

Access Control Profiles						
<span>➕ Add...</span> <span>✎ Edit...</span> <span>🗑 Delete</span> <span>🔄 Refresh</span>						
Name ↑	Accept Policy	Reject Policy	Failsafe Pol...	Assessmen...	Assessmen...	Quarar
Administrator NAC Profile	Enterprise U...			----	----	----
Administrator Profile (Auto)	Administrator			----	----	----
Allow NAC Profile	Enterprise U...			----	----	----
Default NAC Profile	Enterprise U...			----	----	----
Enterprise Access Profile ...	Enterprise A...			----	----	----
Guest Access NAC Profile	Guest Access			----	----	----
Notification NAC Profile	Notification			----	----	----
Pass Through NAC Profile				----	----	----
Quarantine NAC Profile	Quarantine			----	----	----
Registration Denied Acces...	Deny Access			----	----	----
Secure Guest Access NA...	Guest Access			----	----	----
Unregistered NAC Profile	Unregistered			----	----	----

### Add Button ➕ Add...

Use this button to open the [New Extreme Access Control Profile window](#), where you can add an Extreme Access Control profile.

### Edit Button ✎ Edit...

Use this button to open the [Edit Extreme Access Control Profile window](#), where you can edit an existing Extreme Access Control profile.

### Delete Button 🗑 Delete

Use this button to add an Extreme Access Control profile.

### Name

The name of the Extreme Access Control profile.

**Accept Policy**

The Accept policy defined for this profile. An Accept policy is applied to an end-system when

- an end-system has been authorized locally by the Extreme Access Control engine and has passed an assessment (if assessment is enabled).
- authentication is configured to replace the attributes returned from the RADIUS server with the Accept policy.

**Reject Policy**

Indicates whether all authentication requests are rejected.

**Failsafe Policy**

The Failsafe policy defined for this profile. A Failsafe policy is applied to an end-system if the end-system's IP address cannot be determined from its MAC address, or if there has been a scanning error and a scan of the end-system could not take place.

**Assessment Configuration**

The assessment configuration defined for this profile. The configuration defines the assessment requirements for end-systems

**Assessment Interval**

If assessment is required, this defines the interval between required assessments for an end-system.

**Quarantine Policy**

The Quarantine policy defined for this profile. A Quarantine policy is applied to an end-system if the end-system fails an assessment.

**Assessment Policy**

The Assessment policy defined for this profile. An Assessment policy is applied to an end-system while it is being assessed.

**Hide Assessment/Remediation Details**

Denotes whether the option to hide assessment or remediation information on the Remediation Web Page has been selected.

---

**Related Information**

For information on related windows:

- [New/Edit Extreme Access Control Profile Window](#)



---

## New/Edit Extreme Access Control Profile

---

Extreme Access Control Profiles specify the authorization and assessment requirements for the end-systems connecting to the network. Profiles also specify the security policies that will be applied to end-systems for network authorization, depending on authentication and assessment results.

Extreme Management Center comes with ten system-defined Extreme Access Control profiles:

- Administrator
- Allow
- Default
- Guest Access
- Notification
- Pass Through
- Quarantine
- Registration Denied Access
- Secure Guest Access
- Unregistered

You can edit these profiles or you can define your own profiles to use for your Extreme Access Control configurations. Use this window to create a new profile, or edit an existing profile. When you create a new profile, it is added to the [Manage Extreme Access Control Profiles window](#). When you edit a profile, it changes the profile wherever it is used, so you don't have to do individual edits for each profile.

To create a new profile, click the **Add** button in the [Manage Extreme Access Control Profiles window](#). To edit an existing profile, select a profile in the Manage Extreme Access Control Profiles window and click the **Edit** button or select it from the left-panel.

## Name

Enter a name for a new profile. If you are editing a profile, the name of the profile is displayed and cannot be edited. To change the name of a profile, right-click on the profile name in the Extreme Access Control Profiles left-hand panel navigation tree and select **Rename** from the menu.

## Reject Authentication Requests

If you select this checkbox, all authentication requests are rejected.

# Authorization

## Accept Policy

Use the drop-down menu to select the Accept policy you want to use in this Extreme Access Control profile. An Accept policy is applied to an end-system when:

- an end-system has been authorized locally (MAC authentication) by the Extreme Access Control engine and has passed an assessment (if assessment is enabled).
- you have selected the **Replace RADIUS Attributes with Accept Policy** option.

If you select "No Policy", then the Extreme Access Control engine does not include a Filter ID or VLAN Tunnel Attribute in the RADIUS attributes returned to the switch,



and the default role configured on the port is assigned to the end-system. This option is necessary when configuring single user plus IP phone authentication supported on C2/C3 and B2/B3 devices.

### **Replace RADIUS Attributes with Accept Policy**

When this option is checked, the attributes returned from the RADIUS server are replaced by the policy designated as the Accept policy. If the RADIUS server does not return a Filter ID or VLAN Tunnel attribute, the Accept policy is inserted. When this option is unchecked, the attributes returned from the RADIUS server are forwarded back "as is" and the Accept Policy would only be used to locally authorize MAC authentication requests. If the RADIUS server does not return a Filter ID or VLAN Tunnel attribute, no attributes are returned to the switch.

### **Use Quarantine Policy**

Select this checkbox if you want to specify a Quarantine policy. The Quarantine policy is used to restrict network access for end-systems that have failed the assessment. You must have the [Enable Assessment checkbox](#) selected to activate this checkbox.

If a Quarantine policy is not specified and you have configured RADIUS in your AAA configuration, then the policy from the RADIUS attributes would be applied (unless **Replace RADIUS Attributes with Accept Policy** has been selected, in which case the Accept policy would be used.) If **Authorize Authentication Requests Locally** has been selected in your AAA configuration, then the Accept policy would be applied to those end-systems that are authorized locally. This allows an end-system onto the network with its usual network access even though the end-system failed the assessment.

### **Use Failsafe Policy on Error**

Select this checkbox if you want to specify a Failsafe policy to be applied to an end-system when it is in an Error connection state. An Error state results if the end-system's IP address could not be determined from its MAC address, or if there was a scanning error and a scan of the end-system could not take place. A Failsafe policy should allocate a nonrestrictive set of network resources to the connecting end-system so it can continue its work, even though an error occurred in Extreme Access Control operation.

If a Failsafe policy is not specified and you have configured RADIUS in your AAA configuration, then the policy from the RADIUS attributes would be applied (unless **Replace RADIUS Attributes with Accept Policy** has been selected, in which case the Accept policy would be used.) If **Authorize Authentication Requests Locally** has

been selected in your AAA configuration, then the Accept policy would be applied to those end-systems that are authorized locally. This allows end-systems onto the network with their usual network access when an error occurs in Extreme Access Control operation.

## Assessment

### Enable Assessment

Select the **Enable Assessment** checkbox if you want to require that end-systems are scanned by an assessment server.

---

**NOTE:** If you require end-systems to be scanned by an assessment server, you need to configure the assessment servers performing the scans. The [Manage Assessment Settings](#) window is the main window used to manage and configure assessment servers. To access this window, select **Assessment** from the Extreme Access Control Configurations > Extreme Access Control Profiles left-hand panel navigation tree.

---

### Assessment Configuration

Use the drop-down list to select the assessment configuration you would like to use in this Extreme Access Control Profile. Use the **Edit** button to add a new assessment configuration or edit a configuration, if needed. Once an assessment configuration has been created, it becomes available for selection in the list.

### Assessment Interval

Enter an assessment interval that defines the interval between required assessments:

- Minutes - 30 to 120
- Hours - 1 to 48
- Days - 1 to 31
- Weeks - 1 to 52
- None

### Hide Assessment Details and Remediation Options from User

If you select this option, the end user does not see assessment or remediation information on the Remediation Web Page. They are informed that they are quarantined, and told to contact the Help Desk for assistance.

**Use Assessment Policy**

Select this checkbox if you want to specify a certain policy to be applied to an end-system while it is being assessed. Use the drop-down menu to select the desired policy.

Select when to apply the policy:

- During Initial Assessment Only - Only initial assessments receive the assessment policy. If the end-system is being re-assessed, it remains in its current policy.
- During All Assessments - All end-systems being assessed receive the specified assessment policy.

If an assessment policy is not specified and you have configured RADIUS in your AAA configuration, then the policy from the RADIUS attributes are applied (unless "Replace RADIUS Attributes with Accept Policy" is selected, in which case the Accept policy is used.) If "Authorize Authentication Requests Locally" is selected in your AAA configuration, then the Accept policy is applied to those end-systems authorized locally. This allows the end-system immediate network access without having to wait for assessment to be complete.

---

**Related Information**

For information on related windows:

- [Manage Identity and Access Profiles Window](#)
- [Manage Assessment Settings Window](#)
- [Edit Assessment Configuration Window](#)

## Edit Assessment Configuration

This window lets you view and configure the assessment configurations that define the assessment requirements for end-systems. Assessment configurations define the following information:

- How to score assessment results (determined by the selected Risk Level and Scoring Override configurations).
- What assessment tests to run (determined by the selected test sets).

Once you have defined your assessment configurations, they are available for selection when creating your Extreme Access Control configurations.

To access this window, select **Extreme Access Control Configurations > Extreme Access Control Profiles > Assessment** in the left-hand menu to open the [Manage Assessment Settings window](#). Select an existing configuration and click **Edit** to open the Edit Assessment Configuration window, or you can click **Add** to add a new assessment configuration, and then open the Edit Assessment Configuration window.

Default

Scoring Override Configuration:

Risk Level Configuration:

Enable Assessment Warning Period:

Test Sets

Used By...

Selected	Name	Type	Assessment Resources
<input checked="" type="checkbox"/>	Default Agent-less	Agent-less	Use Onboard Assessment
<input type="checkbox"/>	Default Nessus	Nessus	Load Balance All
<input type="checkbox"/>	Default Agent-based	Agent-based	Use Onboard Assessment

### Scoring Override Configuration

Use the drop-down menu to select the scoring override configuration for this assessment configuration. Scoring overrides let you override the scoring mode and test result scores for a particular assessment test. The default scoring override configuration provided by Extreme Management Center specifies no overrides, but can be edited to contain overrides, if desired.

### **Risk Level Configuration**

Use the drop-down menu to select the risk level configuration for this assessment configuration. The risk level configuration determines what risk level is assigned to an end-system (high, medium, or low) based on the end-system's health result details score.

### **Advanced**

The Advanced section allows you to enable assessment warning periods. Warning periods let you specify a grace period and probation period used for assessment warnings.

- **Grace Period** — specify the number of days the end user has to resolve the warning issues before the end-system is quarantined.
- **Probation Period** — The number of days after an end user is quarantined that additional warnings results in immediate quarantine. This allows administrators to block repeat offenders by limiting their access to the network. Once the probation period has passed, the end user can again receive assessment warnings. Setting the probation period to 0 is the same as having no probation period.

### **Test Sets**

Select one or more test sets to run for this assessment configuration. Test sets define which type of assessment to launch against the end-system, what parameters to pass to the assessment server, and what assessment server resources to use.

If you select multiple agent-based test sets, the first test set you select is called the Master test set. A Master test set includes the Agent Configuration settings, the Advanced Settings, and all the specified test cases. Each subsequent agent-based test set that you select for the configuration is a "supporting" test set. For supporting test sets, only the "Application" test cases are used; all other configuration values are ignored. In the list of Test Sets, Master test sets have a "(Master)" designation after them.

For example, you might want to use multiple agent-based test sets if you are managing multiple networks, and you have a unique agent-based test set for each network as well as secondary test sets for specific application tests that all the networks would use. In the assessment configuration for each network, select the unique test set as the Master test set and then select any number of secondary test sets to be included in the configuration as well.

If the Master test set is deselected, then a new master is automatically selected. To specify a different test set as Master, deselect all test sets, select the desired Master test set first, and select the additional supporting test sets.

## Manage Assessment Settings

The Manage Assessment Settings panel is the main panel used to manage and configure the assessment servers performing the end-system assessments in your network. To access this window, select **Extreme Access Control Configurations > Extreme Access Control Profiles > Assessment** from the menu bar.

Assessment configurations define the different assessment requirements for end-systems connecting to your network. When you create an Extreme Access Control profile, you select an assessment configuration that defines the assessment requirements for the end-systems using that profile. You can also click the **Used By** button to view a list of all assessment configurations currently being used by Extreme Access Control configurations.

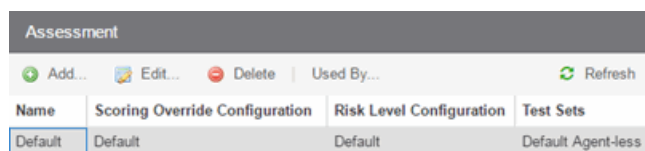

Assessment			
<a href="#">Add...</a> <a href="#">Edit...</a> <a href="#">Delete</a> <a href="#">Used By...</a> <a href="#">Refresh</a>			
Name	Scoring Override Configuration	Risk Level Configuration	Test Sets
Default	Default	Default	Default Agent-less

### Name

The name of the assessment configuration. This is the name that is entered when you add an assessment configuration in the [Edit Assessment Configuration](#) window.

### Scoring Override Config

The scoring override configuration for this assessment configuration. The scoring override configuration lets you override the default scoring assigned by the assessment server to a particular assessment test ID.

### Risk Level Config

The risk level configuration for this assessment configuration. The risk level configuration determines what risk level is assigned to an end-system (high, medium, or low) based on the end-system's health result details score.

### Test Sets

The test sets that runs for this assessment configuration. Test sets define which type of assessment to launch against the end-system, what parameters to pass to the assessment server, and what assessment server resources to use.

## Related Information

For information on related windows:

- [Edit Assessment Configuration](#)



## Portal Configuration Overview

---

If your network is implementing [registration](#) or [assessment / remediation](#), you define the branding and behavior of the portal website used by the end user during the registration or assessment/remediation process using a Portal Configuration. Extreme Access Control engines ship with a default Portal Configuration. You can use this default configuration as is, or make changes to the default configuration using this window, if desired.

### Accessing the Portal Configuration

Use the following steps to access the Portal Configuration:

1. Open the **Control** > Extreme Management Center tab.
2. Expand the Portal tree in the left-panel.
3. Expand a Portal Configuration.

### Network Settings

Use this panel to configure common [network](#) web page settings that are shared by both the [Assessment / Remediation](#) and the Registration portal web pages.

### Administration

Use this panel to configure settings for the [Registration Administration](#) web page and grant access to the page for administrators and sponsors.

The Registration Administration web page allows Helpdesk and IT administrators to track the status of registered end-systems, as well as add, modify, and delete registered end-systems on the network.

### Look and Feel

Use the [Look and Feel](#) panel to configure common web page settings shared by both the [Assessment / Remediation](#) and the Registration portal web pages.

## Guest Access and Registration

[Guest Web Access](#) provides a way for you to inform guests that they are connecting to your network and lets you display an Acceptable Use Policy (AUP).

[Guest Registration](#) forces any new end-system connecting on the network to provide the user's identity in the registration web page before being allowed access to the network.

Secure Guest Access provides secure network access for wireless guests via 802.1x PEAP by sending a unique username, password, and access instructions for the secure SSID to guests via an email address or mobile phone (via SMS text). Secure Guest Access supports both pre-registered guests and guests self-registering through the captive portal. No agent is required.

## Authenticated Web Access

[Authenticated Web Access](#) provides a way to inform end users that they are connecting to your network and lets you display an Acceptable Use Policy. End users are required to authenticate to the network using the Authenticated Web Access login page. However, end users are only granted one-time network access for a single session, and no permanent end user registration records are stored. Authentication is required each time a user logs into the network, which can be particularly useful for shared computers located in labs and libraries.

## Authenticated Registration

[Authenticated Registration](#) provides a way for existing corporate end users to access the network on end-systems that don't run 802.1X (such as Linux systems) by requiring them to authenticate to the network using the registration web page. After successful registration, the end-system is permitted access until the registration expires or is administratively revoked.

## Assessment / Remediation

Use this panel to configure settings for the [Assessment / Remediation](#) portal web page.

## Website Configuration

Use this tab to [configure](#) the common settings used by the different registration web pages, including selecting guest access, authentication settings, and whether assessment and remediation is supported.

---

### Related Information

- [Portal Configuration Network Settings](#)
- [Portal Configuration Administration](#)
- [Portal Configuration Look and Feel](#)
- [Portal Configuration Guest Access](#)
- [Portal Configuration Guest Registration](#)
- [Portal Configuration Authentication](#)
- [Portal Configuration Assessment / Remediation](#)
- [Portal Configuration Website Configuration](#)

## Portal Configuration Network Settings

---

Use this panel to configure common network web page settings that are shared by both the Assessment / Remediation and the Registration portal web pages.

Network Settings

Allowed Web Sites: [Open Editor...](#)

Use Fully Qualified Domain Name:

Use Mobile Captive Portal:

Display Welcome Page:

Portal HTTP Port: 80

Portal HTTPS Port: 443

Force Captive Portal HTTPS:

Redirection

Redirect User Immediately\*:

Test Image URL:

Redirection:

Destination:

\* When used as the portal in an Advanced Location configuration, all fields except Redirect User Immediately are inherited from the Access Control Configuration's base portal.

[Save](#) [Cancel](#)

## Allowed Web Sites

Click on the **Open Editor** button to open the [Allowed Web Sites window](#), where you can configure the web sites to which end users are allowed access during the assessment/remediation and registration process.

## Use Fully Qualified Domain Name

Select this checkbox if you would like the URLs in the portal web pages to display the engine's hostname instead of IP address. When this is enabled, the user's browser does a DNS lookup to find the IP address for the fully qualified hostname of the Extreme Access Controlengine. Enable this option only if all Extreme Access Controlengines have their hostname defined in DNS.

## Use Mobile Captive Portal

Select this checkbox to allow end users using mobile devices to access the network via captive portal registration and remediation. In addition, it allows Helpdesk and IT administrators to track the status of registered end-systems, as well as add, modify, and delete registered end-systems on the network using a mobile device. This feature is supported on the following mobile devices: iPod Touch, iPad, iPhone, Android Phone/Tablet/NetBook, and Windows phones.

## Display Welcome Page

Select this checkbox to display the welcome page. If the checkbox is not selected, users bypass the welcome page and access the portal directly.

### **Portal HTTP Port**

Specify which port the Extreme Management Center server and Extreme Access Controlengine use for HTTP web server traffic. Any change does not take effect on the Extreme Access Controlengine until an Enforce is performed.

### **Portal HTTPS Port**

Specify which port the Extreme Management Center server and Extreme Access Controlengine use for HTTPS web server traffic. Any change does not take effect on the Extreme Access Controlengine until an Enforce is performed.

### **Force Captive Portal HTTPS**

Select this checkbox to force captive portal web pages to be served securely over HTTPS (instead of HTTP) to end users on the network. It is recommended this checkbox is enabled if [Authenticated Registration](#) is configured for the registration process. The default setting is unchecked, specifying to serve the captive portal web pages over HTTP.

### **Redirect User Immediately**

This option redirects end users to the specified test image URL as soon as they have network access. The redirect happens regardless of where the end user is in the connection process. If the end-system's browser can reach the test image URL, then it assumes the end user has network access and redirects the end user out of the captive portal. The test image URL should be an internal image on your own website that end users don't have access to until they're accepted. It is recommended that the test image URL is a link to an SSL site because if the Extreme Access Control captive portal is configured for Force Captive Portal HTTPS, the browser does not allow the attempt to an HTTP test image site. It is also recommended that the captive portal policies, (typically the Unregistered, Assessing, and Quarantine policies), are configured to deny HTTPS traffic. This prevents the test image connection attempt from successfully completing and moving the end-system out of the captive portal prematurely. In the event access to the test image is available, the user may experience the captive portal reverting to the "click here to access the network page", and then upon selecting the link, returning to the previous page based on their state. This behavior continues until the user is finally accepted on the network.

---

**NOTE:** If using the portal for an Extreme Access Control Advanced Location, all portal configurations are inherited from the Extreme Access Control base portal.

---

## Redirection

There are three Redirection options that specify where the end user is redirected following successful registration or remediation, when the end user is allowed on the network:

- **To URL** — This option lets you specify the URL for the web page where the end user is redirected. When selected, the **Destination** field displays, allowing you to indicate the URL of the web page.
  - **Disabled** — This option disables redirection. The end user stays on the same web page where they were accepted onto the network.
  - **To User's Requested URL** — This option redirects the end user to the web page they originally requested when they connected to the network.
- 

## Related Information

- [Portal Configuration Overview](#)

# Portal Configuration Administration

---

The Registration Administration web page allows Helpdesk and IT administrators to track the status of registered end-systems, as well as add, modify, and delete registered end-systems on the network.

## Administration

Use this panel to configure settings for the Registration Administration web page and grant access to the page for administrators and sponsors.

The screenshot shows the 'Administration' configuration page. It includes several settings:

- Welcome Message:** An 'Edit...' button is visible.
- Force Administration HTTPS:** A checked checkbox.
- Session Timeout (Minutes):** A numeric input field set to '10'.
- Login Failure Image:** A dropdown menu currently showing 'Default'.
- Limit Sponsor's View to Own Users:** An unchecked checkbox.
- LDAP Email Address Attribute Name:** A text input field containing 'mail'.
- RADIUS Email Address Attribute Name:** A text input field containing 'mail'.

Below these settings is the 'Administrative Login Configuration' section, which contains a table with the following data:

Authentication	Username, LDAP, or R...	Role Summary
Local Password Repository	Admin	Role Name: Admin Role ...
Local Password Repository	Sponsor	Role Name: Sponsor Rol...

At the bottom of the configuration area are 'Save' and 'Cancel' buttons.

## Administration Web Page Settings

### Welcome Message

Click on the **Edit** button to open a window where you can modify the message displayed to users when they log into the administration or sponsor portal. The default welcome message is *Registration System Administration*.

### Force Administration HTTPS

Select this checkbox to force the administration web page to be served securely over HTTPS (instead of HTTP) to administrators and sponsors on the network. It is recommended this is enabled for additional security.

### Session Timeout (Minutes)

This field specifies the length of time an administrator can be inactive on the administration web page before automatically being logged out. The default value is 10 minutes.

### Login Failure Image

Select an image to display when the end user fails to correctly log in to the web page. The drop-down selection menu displays all the images defined in the [Images](#)

[window](#) for your selection. To add a new image, access the [Look & Feel panel](#).

### Limit Sponsor's View to Own Users

Select this checkbox if you want to limit a sponsor's view to only the users they have sponsored. This option is valid only if you configure LDAP or RADIUS authentication of your sponsors. If you select this checkbox, you must enter the **LDAP Email Address Attribute Name** or **RADIUS Email Address Attribute Name** so a sponsor's login name can be matched to their email address, and only the registered users for that sponsor are displayed.

### Related Information

- [Portal Configuration Overview](#)

## Portal Configuration Website Configuration

Use this tab to configure the common settings used by the different registration web pages, including selecting guest access, authentication settings, and whether assessment and remediation is supported. The options selected in this panel change the panels displayed in the left-panel Website Configuration tree.

The screenshot shows a web interface titled "Website Configuration". It contains several settings sections, each with a checkbox or radio button:

- Guest Settings
  - Guest Web Access:  
Allows presentation of an Acceptable Use Policy to the guest user and allows guest access to the network for the duration of their session. On each subsequent attempt to access the network, the user is presented with the Guest Web Access login page.
  - Guest Registration:  
Allows unauthenticated access to the network for the length of the registration. Registration also has provisions for capturing end-user specific information during the registration process.
  - Secure Guest Access:  
Allows a guest to gain secure wireless access to your network via 802.1x (PEAP) authentication using credentials that are created when the user registers onto an open SSID. The registration can be configured to expire if desired to allow only temporary access to your network.
- Authentication Settings
- Survivable Registration  
This option will allow for a temporary Registration when communication to NAC Manager fails. During this time, any registrations will receive the Failsafe policy of the Unregistered Access Control Profile. When communication is restored, the user will be put through the normal Registration process.
- Assessment/Remediation

At the bottom right of the panel are "Save" and "Cancel" buttons.



### Guest Settings

Select the behavior of the web site for users with guest access and the level of access to your network. For additional information, see the [Guest Web Access](#), [Guest Registration](#), and [Secure Guest Access](#) sections.

### Authentication Settings

Select the behavior of the web site for users with authentication credentials and their level of access to your network. For additional information, see the [Authenticated Web Access](#) and [Authenticated Registration](#) sections.

### Enable Survivable Registration

This feature provides temporary Registration for unregistered end-systems when the Extreme Management Center server is unreachable. If you select this checkbox, unregistered users that try to register while the Extreme Management Center server is unreachable are redirected to the Registration web page. After entering the required information, users are assigned the Failsafe policy and allowed on the network. Once the connection to the Extreme Management Center server is reestablished, the users are reassigned the Unregistered policy and forced to re-register. If you enable Survivable Registration, make sure that the Failsafe policy provides the appropriate network services for unregistered users.

### Assessment/Remediation

Allows you to configure the behavior of the Assessment/Remediation web portal. For additional information, see the [Assessment/Remediation](#) section.

---

### Related Information

- [Portal Configuration Overview](#)

## Portal Configuration Look and Feel

---

Use this panel to configure common web page settings shared by both the Assessment/Remediation and the Registration portal web pages.

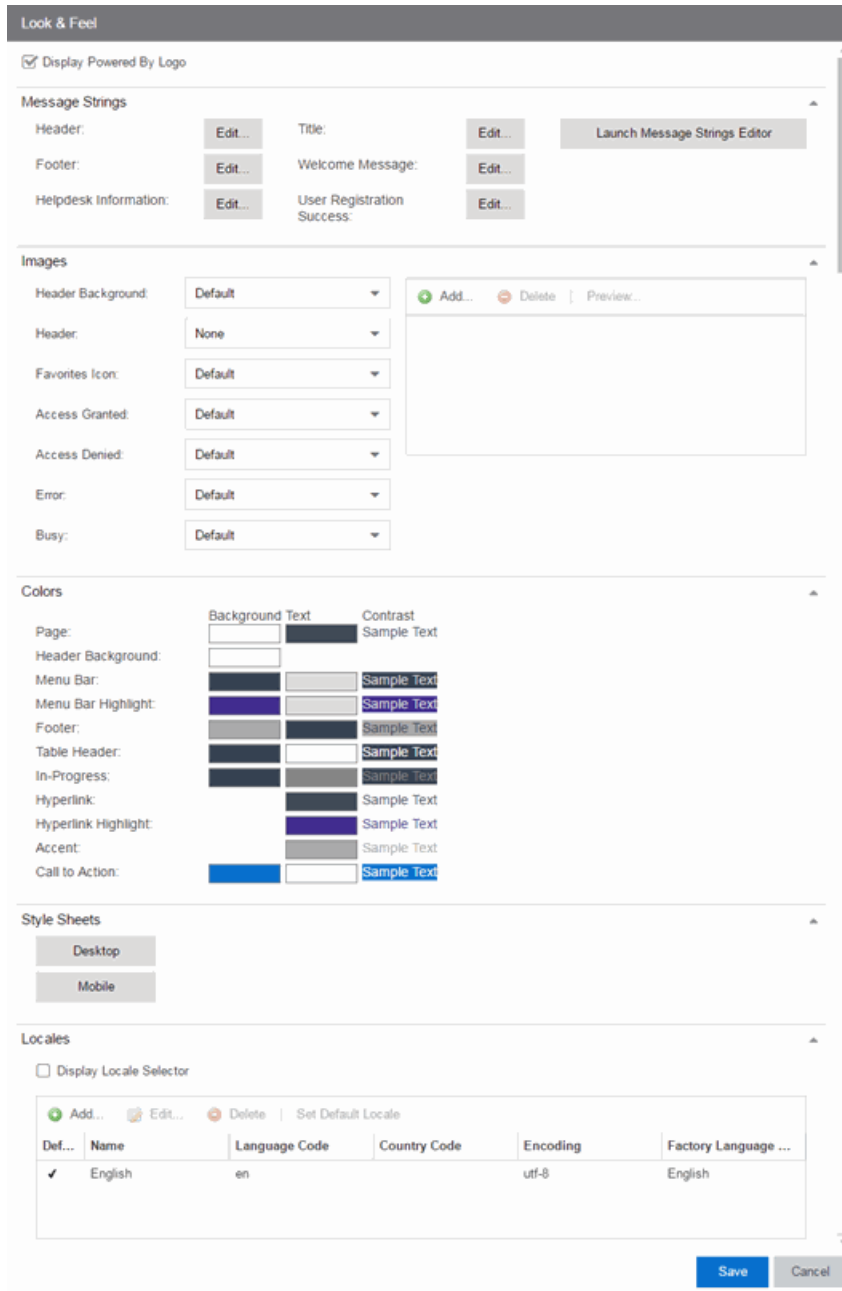

### Display Powered by Logo

Select this checkbox to display the Extreme Networks logo at the bottom of all of your portal web pages.

### Header

Click on the **Edit** button to open a window where you can configure the link for the header image displayed at the top of all portal web pages. By default, the header

image is configured as the Extreme Networks logo acting as a link to the Extreme Networks website. Text entered in this window can be formatted in HTML.

### **Footer**

Click on the **Edit** button to open a window where you can configure the footer displayed at the bottom of all portal web pages. By default, the footer is configured with generalized information concerning an organization. Change the *example* text in this section to customize the footer to your own organization. Text entered in this window can be formatted in HTML.

### **Helpdesk Information**

Click on the **Edit** button to open a window where you can configure the Helpdesk contact information provided to end users in various scenarios during the assessment/remediation and registration process (e.g. an end-system exceeded the maximum number of remediation attempts). By default, this section is configured with generalized Helpdesk information, such as contact URL, email address, and phone number. Change the *example* text to customize the Helpdesk information for your own organization. Text entered in this window can be formatted in HTML. In addition, the entire contents of the Helpdesk Information section are stored in the variable "HELPDESK\_INFO". By entering "HELPDESK\_INFO" (without the quotation marks) in any section that accepts HTML in the Common Page Settings (or any other settings), all information configured in this section will be displayed in place of "HELPDESK\_INFO".

### **Title**

Click on the **Edit** button to open a window where you can modify the text that appears in the title bar of the registration and web access page browser tabs. The default page title is "Enterprise Registration."

### **Welcome Message**

Click on the **Edit** button to open a window where you can modify the message displayed to users on the menu bar of any registration or web access page. The default welcome message is "Welcome to the Enterprise Network's Registration Center."

### **User Registration Success**

Click the **Edit** button to open a window where you can edit the message displayed to the end user after successfully registering their end-system to the network.

### **Images**

Using the dropdown menus, you can specify the image files used in the portal web pages. All image files used for Assessment/Remediation and Registration portal web

pages must be defined in this list. The image files defined here are sent to the Extreme Access Control engine along with the web page configuration. Use the **Add** button to select an image file to add to the list. You can select an image in the list and use the **Preview** button to preview the image.

Once an image file is defined here, it is available for selection from the configuration drop-down lists (for example, when you configure the [Access Granted Image](#)), and may be referenced in the sections supporting HTML. Available drop-down lists include:

- **Header Background Image**

Select the background image displayed behind the header image at the top of all portal web pages. The drop-down menu displays all the images defined in the [Images window](#) for your selection. To add a new image, select **Add** to open the Images window.

- **Header Image**

Select the image displayed at the top of all portal web pages. The drop-down menu displays all the images defined in the [Images window](#) for your selection. To add a new image, select **Add** to open the Images window.

- **Favorites Icon**

Select the image displayed as the Favorites icon in the web browser tabs. The drop-down menu displays all the images defined in the [Images window](#) for your selection. To add a new image, select **Add** to open the Images window.

- **Access Granted Image**

Select the image displayed when the end user is granted access to the network either based on compliance with the network security policy or upon successful registration to the network. The drop-down menu displays all the images defined in the [Images window](#) for your selection. To add a new image, select **Add** to open the Images window.

- **Access Denied Image**

Select the image you would like displayed when the end user has been denied access to the network. The drop-down selection list displays all the images defined in the [Images window](#) for your selection. To add a new image, select Manage Images to open the Images window.

- **Error Image**

Select the image displayed when there is a communication error with the Extreme Management Center Server. The drop-down menu displays all the images defined in the [Images window](#) for your selection. To add a new image, select **Add** to open the Images window.

- **Busy Image**

Select the progress bar image displayed to the end user when the web page is busy processing a request. The drop-down menu displays all the images defined in the [Images window](#) for your selection. To add a new image, select **Add** to open the Images window.

## Colors

Click on the Background or Text color box corresponding to each item to open the Choose Color window, displayed below, where you can define the colors used in the portal web pages:

- Page — Define the background color and the color of all primary text on the web pages.
- Header Background Color — Define the background color displayed behind the header image.
- Menu Bar — Define the background color and text color for the menu bar.
- Menu Bar Highlight — Define the background color and text color used for the menu bar highlights in the Administration pages.
- Footer — Define the background color and text color for the footer.
- Table Header — Define the background color and text color for the table column headers in the Administrative web pages.
- In-Progress — Define the background color and text color for task in-progress images.
- Hyperlink — Define the color used for hyperlinks on the web pages.
- Hyperlink Highlight — Define the color of a hyperlink when it is highlighted.
- Accent — Define the color used for accents on various parts of the web pages.

Click **OK** to save the changes.

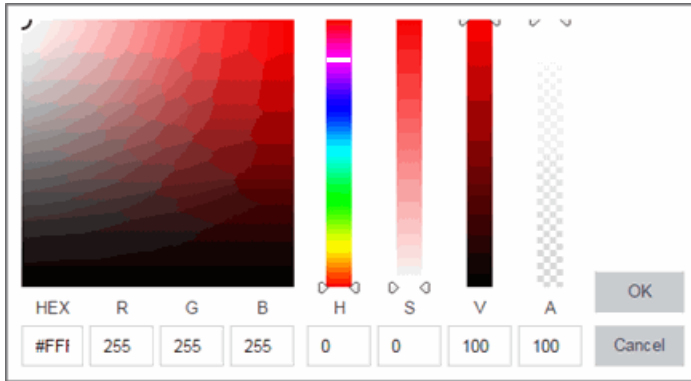

### Style Sheets

Click on the **Desktop** or **Mobile** buttons to open the Edit Style Sheet window where you can create a style sheet that adds to or overwrites the formatting styles for the portal, or mobile version of the portal web pages, respectively.

### Locales

This field lists the locales (languages) presented as options to the user in the captive portal, in addition to the default locale.

You can also define the default locale (language), displayed to any captive portal user unless the client locale detected from their browser matches one of the defined supplemental locales. The list of available locales includes the current default locale and any supplemental defined locales.

### Display Locale Selector

Select this checkbox if you want a locale (language) selector to display as a drop-down menu in the menu bar on the captive portal welcome and login pages. This is useful for a shared machine where the users of the machine may speak different languages. (On the mobile captive portal, the selector is displayed as a list of links at the bottom of the welcome screen.)

---

### Related Information

- [Portal Configuration Overview](#)

## Portal Configuration Authenticated Access and Registration

---

Authenticated web access provides a way to inform end users that they are connecting to your network and lets you display an Acceptable Use Policy. [Authenticated registration](#) provides a way for existing corporate end users to access the network on end-systems that don't run 802.1X (such as Linux systems) by requiring them to authenticate to the network using the registration web page.

---

**NOTE:** The [Authentication](#) and [Redirection](#) settings are shared by the Authenticated Web Access and Authenticated Registration access types. Changing them for one type also changes them for the other.

---

### Authenticated Web Access

End users are required to authenticate to the network using the Authenticated Web Access login page. However, end users are only granted one-time network access for a single session, and no permanent end user registration records are stored. Authentication is required each time a user logs into the network, which can be particularly useful for shared computers located in labs and libraries.

Implementing authenticated web access requires web redirection or DNS proxy.

**Authenticated Web Access**

Login or Register Message:

Introduction Message:

Failed Authentication Message:

Customize Fields:

---

**Authentication**

AAA Configuration:

Authentication to End-System Group: None

Local Password Repository: None

Max Failed Logins:

---

**Redirection**

Redirection:

---

**Web Access Settings**

Enable Agent-Based Login:

### Login or Register Message

Click the **Edit** button to open a window where you can edit the message displayed to the end user when they are registering. By default, the message states that the end user is required to register before being allowed on the network.

### Introduction Message

Click the **Edit** button to open a window where you can edit the introductory message displayed to the end user when they are registering. By default, the message states that the end user is agreeing to the terms and conditions in the Acceptable Use Policy.

### Failed Authentication Message

Click the **Edit** button to open a window where you can edit the message displayed to the end user if the end user fails authentication. By default, this message advises the end user to contact their network administrator for assistance. Note that the default configuration of the message references the "HELPDESK\_INFO" variable which represents the Helpdesk Information that is defined in the [Look and Feel Settings](#).

### Customize Fields (Shared)

Click the **Open Editor** button to open the [Manage Custom Fields window](#) where you can manage the fields displayed in the Registration web page.



## Authentication

### AAA Configuration

This section displays the name of the AAA configuration being used by the Access Control configuration and provides a link to open the AAA Configuration window where you can make changes to the AAA Configuration, if desired. If the portal configuration is shared between multiple Extreme Access Control Configurations using different AAA configurations, the different AAA configurations are listed here (maximum of 3), allowing you to open the appropriate AAA configuration.

The section also displays the method(s) utilized for validating the credentials entered during registration (LDAP, RADIUS, and/or a Local Password Repository) as specified in the AAA configuration(s).

- **Authentication to End-System Group** — Click the **Change** button to open the User Group to End-System Group Map window where you can map the LDAP/RADIUS/Local User Group to the appropriate end-system group to specify end user access levels. Once an end-system group has been mapped to a user group, the icon for the end-system group changes to display a key indicating that it is no longer available for general use. You can use the Move Up/Move Down arrows to set the precedence order for the mappings, allowing you to change the authentication order that takes place during the user authenticated registration.
- **Local Password Repository** — If you are using a local repository, authenticated end users are assigned to the Web Authenticated Users group. Click the **Default** button to open a window where you can edit the Local Password Repository. Multiple links may be listed if there are different repositories associated with different AAA configurations.

### Max Failed Logins

Select this checkbox to specify the maximum consecutive number of times an end user can attempt to authenticate on an end-system and fail. You can specify a lockout period that must elapse before the user can attempt to log in again on that end-system.

## Redirection

### Redirection

There are four Redirection options that specify where the end user is redirected following successful registration, when the end user is allowed on the network. The

option selected here overrides the Redirection option specified on the [Network Settings](#).

- **Use Network Settings Redirection** — Use the Redirection option specified on the [Network Settings panel](#).
- **Disabled** — This option disables redirection. The end user stays on the same web page where they were accepted onto the network.
- **To User's Requested URL** — This option redirects the end user to the web page they originally requested when they connected to the network.
- **To URL** — This option lets you specify the URL of the web page to which the end user is redirected. This is typically the home page for the enterprise website, for example, "http://www.ExtremeNetworks.com."

## Web Access Settings

### Enable Agent-Based Login

If this option is enabled, when the end user connects to the network with an agent installed, the login dialog is displayed in an agent window instead forcing the user to go to the captive portal via a web browser. This allows you to provide authenticated web access without having to set up the captive portal. Agent-based login is useful for shared access end-systems running an agent because it prompts for a login dialog and also provides a logout option. Login credentials are limited to username/password and an Acceptable Use Policy is not displayed.

You can customize the messages in the Agent Login window using the Message Strings Editor available in the [Look and Feel Settings](#). Use the agentLoginMessage string to change the message. Any changes you make in the Message Strings Editor override the internationalized messages used in the Agent Login window.

## Authenticated Registration

Authenticated registration provides a way for existing corporate end users to access the network on end-systems that don't run 802.1X (such as Linux systems) by requiring them to authenticate to the network using the registration web page. After successful registration, the end-system is permitted access until the registration expires or is administratively revoked.

It is recommended that the [Force Captive Portal HTTPS](#) option is enabled if authenticated registration is required for security reasons.

**NOTE:** If you configure both [guest registration](#) and authenticated registration for an area on your network, the end user is presented with a choice on the registration web page whether or not to authenticate.

Authenticated Registration

Login or Register Message:	<a href="#">Edit...</a>
Introduction Message:	<a href="#">Edit...</a>
Failed Authentication Message:	<a href="#">Edit...</a>
Customize Fields:	<a href="#">Open Editor...</a>

---

**Authentication**

AAA Configuration:	<a href="#">Default</a>
Authentication to End-System Group:	Local <a href="#">Change...</a>
Local Password Repository:	<a href="#">Default</a>
Max Failed Logins:	<input type="checkbox"/>

---

**Redirection**

Redirection:	<div style="border: 1px solid #ccc; padding: 2px; display: inline-block;">To User's Requested URL</div>
--------------	---

---

**Registration Settings**

Default Max Registered Devices:	<div style="border: 1px solid #ccc; padding: 2px; display: inline-block;">2</div>
Default Expiration:	<div style="border: 1px solid #ccc; padding: 2px; display: inline-block;">30 <span style="font-size: small;">Days</span> (0 = never)</div>
Delete Expired Users:	<input checked="" type="checkbox"/>
Delete Local Password Repository Users:	<input type="checkbox"/>
Enable Self-Registration Portal:	<input type="checkbox"/>
Enable Pre-Registration Portal:	<input checked="" type="checkbox"/> <div style="border: 1px solid #ccc; padding: 2px; font-size: small;">Multi and Single User</div>
Pre-Registration Expiration at First Login:	<input type="checkbox"/>
Generate Password Characters:	<div style="border: 1px solid #ccc; padding: 2px; display: inline-block;">Alpha-Numeric With No Vowels</div>
Generate Password Length:	<div style="border: 1px solid #ccc; padding: 2px; display: inline-block;">8</div>

### Login or Register Message

Click the **Edit** button to open a window where you can edit the message displayed to the end user when they are registering. By default, the message states that the end user is required to register before being allowed on the network.

### Introduction Message

Click the **Edit** button to open a window where you can edit the introductory message displayed to the end user when they are registering. By default, the message states that the end user is agreeing to the terms and conditions in the Acceptable Use Policy.

### Failed Authentication Message

Click the **Edit** button to open a window where you can edit the message displayed to the end user if the end user fails authentication. By default, this message advises the end user to contact their network administrator for assistance. Note that the default configuration of the message references the "HELPDESK\_INFO" variable which represents the Helpdesk Information that is defined in the [Look and Feel Settings](#).

### Customize Fields (Shared)

Click the **Open Editor** button to open the [Manage Custom Fields window](#) where you can manage the fields displayed in the Registration web page.

## Authentication

These settings are shared by the Authenticated Web Access and Authenticated Registration access types. Changing them for one type also changes them for the other.

### AAA Configuration

This section displays the name of the AAA configuration being used by the Access Control configuration and provides a link to open the AAA Configuration window where you can make changes to the AAA Configuration, if desired. If the portal configuration is shared between multiple Extreme Access Control Configurations using different AAA configurations, the different AAA configurations are listed here (maximum of 3), allowing you to open the appropriate AAA configuration.

The section also displays the method(s) utilized for validating the credentials entered during registration (LDAP, RADIUS, and/or a Local Password Repository) as specified in the AAA configuration(s).

- **Authentication to End-System Group** — Click the **Change** button to open the User Group to End-System Group Map window where you can map the LDAP/RADIUS/Local User Group to the appropriate end-system group to specify end user access levels. Once an end-system group has been mapped to a user group, the icon for the end-system group changes to display a key indicating that it is no longer available for general use. You can use the Move Up/Move Down arrows to set the precedence order for the mappings, allowing you to change the authentication order that takes place during the user authenticated registration.
- **Local Password Repository** — If you are using a local repository, authenticated end users are assigned to the Web Authenticated Users group. Click the **Default** button to open a window where you can edit the Local Password Repository. Multiple links may be listed if there are different repositories associated with different AAA configurations.

### Max Failed Logins

Select this checkbox to specify the maximum consecutive number of times an end user can attempt to authenticate on an end-system and fail. You can specify a

lockout period that must elapse before the user can attempt to log in again on that end-system.

## Redirection

These settings are shared by the Authenticated Web Access and Authenticated Registration access types. Changing them for one type also changes them for the other.

### Redirection

There are four Redirection options that specify where the end user is redirected following successful registration, when the end user is allowed on the network. The option selected here overrides the Redirection option specified on the [Network Settings](#).

- **Use Network Settings Redirection** — Use the Redirection option specified on the [Network Settings](#).
- **Disabled** — This option disables redirection. The end user stays on the same web page where they were accepted onto the network.
- **To User's Requested URL** — This option redirects the end user to the web page they originally requested when they connected to the network.
- **To URL** — This option lets you specify the URL of the web page to which the end user is redirected. This is typically the home page for the enterprise website, for example, "http://www.ExtremeNetworks.com."

## Registration Settings

The Generate Password Character and Generate Password Length settings are shared by Authenticated Registration and Secure Guest Access.

### Default Maximum Registered Devices

Specify the maximum number of MAC addresses each authenticated end user is allowed to register on the network. If a user attempts to register an additional MAC address that exceeds this count, an error message is displayed in the Registration web page stating that the maximum number of MAC addresses is registered to the network and to call the Helpdesk for further assistance. The default value for this field is 2.

**Default Expiration**

Enter a value and select a unit of time to configure the amount of time before an end user's registration automatically expires. When the registration expires, the end user is either suspended (registration must be manually approved by administrator/sponsor) or permanently deleted from the registration list. If a registration is deleted, the end-user must re-enter all their required personal information the next time they attempt to access the network. Individual registration expiration time can also be set by the administrator/sponsor through the Registration Administration web page.

**Delete Expired Users**

Select this checkbox to delete a user from the Registered users list in the Registration Administration web page when their registration expires. If a registration is deleted, the end-user must re-enter all their required personal information the next time they attempt to access the network.

**Delete Local Password Repository Users**

If you select **Delete Expired Users**, then selecting this checkbox also deletes the expired user from the local password repository.

**Enable Self-Registration Portal**

This checkbox allows an authenticated and registered user to be directed to a URL (provided by an administrator) to self-register additional devices that may not support authentication (such as Linux machines) or may not have a web browser (such as game systems). For example, a student may register to the network using their PC. Then, using a self-registration URL provided by the system administrator, they can register their additional devices. Once the additional devices have been registered, the student can access the network using those devices. The URL for the Self Registration web page is `https://<Extreme Access ControlEngineIP>/self_registration`. You can change the instructions displayed on this web page using the Message Strings Editor on the [Look and Feel Settings](#); select the selfRegIntro message string.

**Enable Pre-Registration Portal**

Select this checkbox to enable pre-registration functionality. With pre-registration, guest users can be registered in advance, allowing for a more streamlined and simple registration process when the guest user connects to the network. This is useful in scenarios where guest users are attending a company presentation, sales seminar, or a training session. From the drop-down menu, select whether you want to pre-register a single user (when you want to pre-register one user at time) or

multiple users (when you have a larger group of users to pre-register) or both. For more information, see [How to Configure Pre-Registration](#).

### **Pre-Registration Expiration at First Login**

Select this checkbox to set the **Default Expiration** of a pre-registered user to begin when the user first registers a device, instead of setting it the moment the pre-registered user is created (added via the pre-registration administration process). Select **Enable Pre-Registration Portal** to enable this option. For more information, see [How to Configure Pre-Registration](#).

---

**NOTE:** This option is only valid when importing a CSV file to pre-register multiple users in the Pre-Registration Portal and not when entering information for a single user.

---

### **Generate Password Characters**

This option is available if you select **Enable Pre-Registration Portal**. During the pre-registration process, Extreme Management Center can automatically generate the password that the guest user uses when connecting to the network. The password is generated according to the specification selected here. This setting is shared by Authenticated Registration and Secure Guest Access. Changing it for one access type also changes it for the other.

### **Generate Password Length**

This option is available if you select **Enable Pre-Registration Portal**. During the pre-registration process, Extreme Management Center can automatically generate the password that the guest user uses when connecting to the network. The password length is generated according to the number of characters specified here.

---

## **Related Information**

- [Portal Configuration Overview](#)

## Portal Configuration Guest Access

Guest Web Access provides a way for you to inform guests that they are connecting to your network and lets you display an Acceptable Use Policy (AUP).

End users are initially redirected to the captive portal when they first connect to the network. After the user enters the required information on the Guest Web Access login page (typically, their name and email address), they are allowed access on the network according to the assessment and authorization defined in the Guest Access profile.

Guest web access provides a single session, and no permanent end user records are stored. This provides increased network security, and also allows you to minimize the number of registration records stored in the Extreme Management Center database.

Implementing guest web access requires web redirection or DNS proxy.

The screenshot shows the 'Guest Web Access' configuration page. It includes sections for 'Introduction Message' with an 'Edit...' button, 'Customize Fields' with an 'Open Editor...' button, 'Redirection' with a dropdown menu set to 'To User's Requested URL', and 'Registration Settings'. The 'Registration Settings' section includes a 'Verification Method' dropdown set to 'SMS Text or Email', 'Service Providers' with an 'Edit...' button, 'Message Strings' with an 'Edit...' button, 'Verify PIN Characters' dropdown set to 'Alpha-Numeric With No Vowels', and 'Verify PIN Length' set to '5'. At the bottom right, there are 'Save' and 'Cancel' buttons.

### Introduction Message

Click the **Edit** button to open a window where you can edit the introductory message displayed to end users when gaining web access as guests. It may include an introduction to the network and information stating that the end user is agreeing to the Acceptable Use Policy (AUP) for the network upon registering their device. A



link to the URL that contains the full terms and conditions of the network's AUP can be provided from this introductory message. Note that the URL for this link must be added as an Allowed URL in the [Allowed Web Sites window](#) accessed from the Network Settings. By configuring the introductory message with this information, end users can be held accountable for their actions on the network in accordance with the terms and conditions set forth by the network's AUP. This message is shared by Guest Web Access and Guest Registration. Changing it for one access type also changes it for the other.

### **Customize Fields**

Click the **Open Editor** button to open the [Manage Custom Fields window](#) where you can manage the fields displayed in the Guest Web Access login page. These settings are shared by Guest Web Access, Guest Registration, and Secure Guest Access. Changing them for one access type also changes them for the others.

### **Redirection (Shared)**

There are four Redirection options that specify where the end user is redirected following successful access, when the end user is allowed on the network. The option selected here overrides the Redirection option specified on the Network Settings. This setting is shared by Guest Web Access, Guest Registration, and Secure Guest Access. Changing it for one access type also changes it for the others.

- **Use Network Settings Redirection** — Use the Redirection option specified on the Network Settings.
- **Disabled** — This option disables redirection. The end user stays on the same web page where they were accepted onto the network.
- **To User's Requested URL** — This option redirects the end user to the web page they originally requested when they connected to the network.
- **To URL** — This option lets you specify the URL for the web page where the end user will be redirected. This would most likely be the home page for the enterprise website, for example, "http://www.ExtremeNetworks.com."

## **Registration Settings**

### **Verification Method**

User verification requires that guest end users registering to the network enter a verification code that is sent to their email address or mobile phone (via SMS text) before gaining network access. This ensures that network administrators have at least one way to contact the end user. For more information and complete instructions, see [How to Configure Verification for Guest Registration](#).

Select from the following verification methods:

- **Email** — The end user must enter an email address in the Guest Web Access login page. The Email Address field must be set to **Required** in the [Manage Custom Fields window](#).
- **SMS Gateway** — The end user must enter a mobile phone number in the Guest Web Access login page. The Phone Number field must be set to **Required** in the [Manage Custom Fields window](#).
- **SMS Gateway or Email** — The end user must enter a mobile phone number or email address in the Guest Web Access login page. The Phone Number and Email Address fields must be set to **Visible** in the [Manage Custom Fields window](#).
- **SMS Text Message** — The end user must enter a mobile phone number in the Guest Web Access login page. The Phone Number field must be set to **Required** in the [Manage Custom Fields window](#).
- **SMS Text or Email** — The end user must enter either a mobile phone number or email address in the Guest Web Access login page. The Phone Number and Email Address fields must be set to **Visible** in the [Manage Custom Fields window](#).

If you have selected the "SMS Text Message" or the "SMS Text or Email" Verification method: click the Service Providers **Edit** button (below the verification method) to configure the list of mobile service providers from which end users can select on the Registration web page. This setting allows Extreme Access Control to correctly format the email address to which to send an email. This email is then received by the service provider and converted to an SMS text which is sent the user. The default configuration provides lists of the major US cellular service providers.

---

**NOTE:** Not all cellular service providers provide a way to send SMS text messages via email.

---

If you have selected the "SMS Gateway" or "SMS Gateway or Email" method: enter the SMS Gateway Email address provided by the SMS Gateway provider.

**For all methods:** use the Message Strings **Edit** button (below the verification method) to open the Message Strings Editor and modify the registration verification messages displayed to the user during the verification process. For example, if you have selected **Email**, you need to modify the

"registrationVerificationEmailSentFromAddress" message string to be the appropriate email address for your company.

**For all methods:** set the Verify Pin Characters and Verify Pin Length options to define the characteristics and length of the verification code that is sent to the guest end user. This setting is shared by Guest Registration and Guest Web Access. Changing it for one access type also changes it for the other.

## Secure Guest Access

Secure Guest Access provides secure network access for wireless guests via 802.1x PEAP by sending a unique username, password, and access instructions for the secure SSID to guests via an email address or mobile phone (via SMS text). Secure Guest Access supports both pre-registered guests and guests self-registering through the captive portal. No agent is required.

Here are three scenarios where Secure Guest Access provides increased network security:

- An enterprise provides secure guest access for visitors. Guests self-register through the captive portal and receive connection credentials and instructions for the secure SSID via a text message on their mobile phone.
- A hospitality company provides guests with secure Internet access using pre-registration. A receptionist generates a voucher using the Extreme Access Control pre-registration portal. The voucher is handed to the guest, providing them with instructions and credentials for connecting directly to the secure SSID.
- An enterprise provides secure guest access with the option of elevated access through employee sponsors. Guests self-register through the captive portal and receive connection credentials and instructions via a text message. Sponsors approve guests for secure guest access. Later, sponsors can elevate guest access using the sponsorship portal.

**Secure Guest Access**

Introduction Message: [Edit...](#)

Customize Fields: [Open Editor...](#)

**Secure Access Settings**

Credential Delivery Method: SMS Text Message

Service Providers: [Edit...](#)

Message Strings: [Edit...](#)

Default Expiration: 30 Days (0 = never)

Default Max Registered Devices: 2

Enable Pre-Registration Portal:  Multi and Single Use

Generate Password Characters: Alpha-Numeric With No Vowels

Generate Password Length: 8

**Sponsorship**

End users will be assigned to the Registered Guests group by default. With optional sponsorship, a sponsor can elevate their access. If sponsorship is required, the end user has no access until the sponsor approves.

Sponsorship Mode: Required

Sponsored Registration Introduction: [Edit...](#)

Admin/Sponsor Email (Always Notified):

Sponsor Email Field: User Specifies Any Email

Predefined Sponsors:

[Save](#) [Cancel](#)

## Introduction Message

Click the **Edit** button to open a window where you can edit the introductory message displayed to end users when registering as guests. It may include an introduction to the network and information stating that the end user is agreeing to the Acceptable Use Policy (AUP) for the network upon registering their device. A link to the URL that contains the full terms and conditions of the network's AUP can be provided from this introductory message. Note that the URL for this link must be added as an Allowed URL in the [Allowed Web Sites window](#) accessed from the Network Settings. By configuring the introductory message with this information, end users can be held accountable for their actions on the network in accordance with the terms and conditions set forth by the network's AUP. This message is shared by Guest Web Access and Guest Registration. Changing it for one access type also changes it for the other.

## Customize Fields

Click the **Open Editor** button to open the [Manage Custom Fields window](#) where you can manage the fields displayed in the Registration web page. These settings are shared by Guest Web Access, Guest Registration, and Secure Guest Access.

Changing them for one access type also changes them for the others.

## Secure Access Settings

### Credential Delivery Method

Select the method that will be used to send guests their credentials and access instructions for the secure SSID. For more information and complete instructions, see [How to Configure Credential Delivery for Secure Guest Access](#).

- **Captive Portal** — The credential information displays on the Registration web page.
- **Email** — The end user must enter an email address in the Registration web page. The Email Address field must be set to **Required** in the [Manage Custom Fields window](#).
- **SMS Gateway** — The end user must enter a mobile phone number in the Registration web page. The Phone Number field must be set to **Required** in the [Manage Custom Fields window](#).
- **SMS Gateway or Email** — The end user must enter a mobile phone number or email address in the Registration web page. The Phone Number and Email Address fields must be set to **Visible** in the [Manage Custom Fields window](#).
- **SMS Text Message** — The end user must enter a mobile phone number in the Registration web page. The Phone Number field must be set to **Required** in the [Manage Custom Fields window](#).
- **SMS Text or Email** — The end user must enter either a mobile phone number or email address in the Registration web page. The Phone Number and Email Address fields must be set to **Visible** in the [Manage Custom Fields window](#).

**If you have selected the "SMS Text Message" or the "SMS Text or Email" Verification method:** click the Service Providers **Edit** button (below the verification method) to configure the list of mobile service providers from which end users can select on the Registration web page. This setting allows Extreme Access Control to correctly format the email address to which to send an email. This email is then received by the service provider and converted to an SMS text which is sent the user. The default configuration provides lists of the major US cellular service providers.

---

**NOTE:** Not all cellular service providers provide a way to send SMS text messages via email.

---

If you have selected the "SMS Gateway" or "SMS Gateway or Email" method: enter the SMS Gateway Email address provided by the SMS Gateway provider.

For all methods: use the Message Strings **Edit** button (below the verification method) to open the Message Strings Editor and modify the registration verification messages displayed to the user during the verification process. For example, if you have selected "Email", you need to modify the "secureGuestAccessEmailSentFromAddress" message string to be the appropriate email address for your company.

### **Default Expiration**

Enter a value and select a unit of time to configure the amount of time before an end user's registration automatically expires. When the registration expires, the end user is either suspended (registration must be manually approved by administrator/sponsor) or permanently deleted from the guest registration list. If a registration is deleted, the end-user must re-enter all their personal information the next time they attempt to access the network. Individual expiration time can also be set by the sponsor.

### **Default Max Registered Devices**

Specify the maximum number of MAC addresses each authenticated end user is allowed to register on the network. If a user attempts to register an additional MAC address that exceeds this count, an error message is displayed in the Registration web page stating that the maximum number of MAC addresses has already been registered to the network and to call the Helpdesk for further assistance. The default value for this field is 2.

### **Enable Pre-Registration Portal**

Use this checkbox to enable Pre-Registration functionality. With pre-registration, guest users can be registered in advance, allowing for a more streamlined and simple registration process when the guest user connects to the network. This can be particularly useful in scenarios where guest users will be attending a company presentation, sales seminar, or a training session. From the drop-down menu, select whether you want to pre-register a single user (when you want to pre-register one user at a time) or multiple users (when you have a larger group of users to pre-register) or both. For more information, see [How to Configure Pre-Registration](#).

**Generate Password Characters (Shared)**

Extreme Access Control uses this option when generating passwords for guest users who are either self-registering or are pre-registered, to use when connecting to the network. This setting is shared by Authenticated Registration and Secure Guest Access. Changing it for one access type also changes it for the other.

**Generate Password Length (Shared)**

NAC Manager will use this option when generating passwords for guest users who are either self-registering or are pre-registered, to use when connecting to the network. The password length is generated according to the number of characters specified here. This setting is shared by Authenticated Registration and Secure Guest Access. Changing it for one access type also changes it for the other.

## Sponsorship

Use this section to configure sponsorship for Secure Guest Access registration. Select the Sponsorship Mode required. Additional settings are displayed if you select optional or required sponsorship. For information on each option, see [How to Configure Sponsorship for Guest Registration](#).

With sponsored registration, end users are only allowed to register to the network when approved by a "sponsor," an internal trusted user to the organization. Sponsorship can provide the end user with a higher level of access than just guest access and allows the sponsor to fine-tune the level of access for individual end users. The end user registers and declares a sponsor's email address. The sponsor is notified and approves the registration, and can assign an elevated level of access, if desired.

---

**Related Information**

- [Portal Configuration Overview](#)

## Portal Configuration Assessment / Remediation

---

Use this panel to configure settings for the Assessment/Remediation portal web page. Also, the [Network Settings](#) and [Look and Feel](#) panels provide you access to common settings that are shared by the Assessment/Remediation portal web page.



**Assessment/Remediation**

Title: Edit...

Welcome Message: Edit...

Display Violations:  Description  Solution

Do Not Allow Rescan:

Allow Blacklist Remediation:

Permanently Removed Message: Edit...

Custom Agent Install Message: Edit...

Access Denied Image: Default ▼

Image During Reattempt: Default ▼

Agent Scan in Progress Image: Default ▼

---

**Redirection**

Redirection Type: To User's Requested URL ▼

---

**Remediation Attempt Limits**

Limit Remediation Attempts:

Limit Time for Remediation:

---

**Remediation Links**

+ Add... 
  Edit...
 Delete

Name	Link
MAC OS Update	<a href="http://www.apple.com/support/downloads">http://www.apple.com/support/downloads</a>
Microsoft Update	<a href="http://update.microsoft.com">http://update.microsoft.com</a>

---

**Custom Remediation Actions**

Define Default Custom Action:

+ Add... 
  Edit...
 Delete
| Copy To...

Test Case ID	Remediation Description	Remediation Solution

Save
Cancel

## Web Page Settings

### Title

Click the **Edit** button to open a window where you can modify the message displayed in the title bar of the Assessment/Remediation web pages. The default page title is "Enterprise Remediation."

### Welcome Message

Click the **Edit** button to open a window where you can modify the message displayed in the banner at the top of the Assessment/Remediation web page. The default welcome message is "Welcome to the Enterprise Remediation Center."

### Display Violations

Use the checkboxes to select the assessment violation information that displays to the end user:

- **None** — No violations are displayed to the web page. This option might be used for an Extreme Access Control engine that is serving web pages to guest users, when you do not want the guest users to attempt to remediate their end-system.
- **Description** — Only the description is displayed for violations. This provides the end user with information concerning what violation was found, but no information concerning how it can be fixed. This configuration may be appropriate for scenarios where the user population of the network does not possess technical IT knowledge and is not expected to self-remediate. It provides the Helpdesk personnel with technical information about the violation when the end user places a call to the Helpdesk.
- **Solution** — Only the solution is displayed for violations, allowing the end user to perform self-service remediation without knowing what the violation is. This configuration may be appropriate for scenarios where the user population on the network does not possess technical IT knowledge but is expected to self-remediate.
- **Description and Solution** — Both the description and solution are displayed for violations. This provides the end user with information concerning what violation was found and how to fix it. Providing complete information concerning the violation gives the end user the best chance of self-remediation, however, the technical details of the violation may result in end user confusion. Therefore, this configuration may be appropriate for scenarios

where the user population of the network possesses more technical IT knowledge.

### **Do Not Allow Rescan**

Select this checkbox if you do not want the end-user to have the ability to initiate a rescan of their end-system when quarantined. When selected, the **Reattempt Network Access** button is removed from the Assessment/Remediation web page, and the user is not provided with any way to initiate a rescan on-demand for network access. The end user is forced to contact the Help Desk for assistance. You can edit the "Permanently Removed Message" which, by default, advises the end user to contact the Helpdesk to obtain access to the network. Note that the default configuration of the "Permanently Removed Message" references the "HELPDESK\_INFO" variable which represents the Helpdesk Information that is defined in the [Look and Feel Settings](#).

### **Allow Blacklist Remediation**

Select this checkbox if you want black-listed end users to have the ability to remediate their problem and attempt to reconnect to the network. When selected, a "Reattempt Network Access" button is added to the Blacklist web page, allowing end users to remove themselves from the blacklist and reauthenticate to the network.

### **Permanently Removed Message**

Click the **Edit** button to open a window where you can modify the message displayed when users can no longer self-remediate and must contact the Help Desk for assistance. Note that the default message references the "HELPDESK\_INFO" variable which represents the Helpdesk Information that is defined in the [Look and Feel Settings](#).

### **Custom Agent Install Message**

Click the **Edit** button to open a window where you can create a message containing additional agent install information to add to the default text on the Install Agent portal web page.

### **Access Denied Image**

Select the image you want displayed when the end user is quarantined and denied access to the network. The drop-down menu displays all the images defined in the [Images window](#) for your selection.

### **Image During Reattempt**

Select the image you want displayed when the end-user is reattempting network access after they repair their system. The drop-down menu displays all the images defined in the [Images window](#) for your selection.

### Agent Scan in Progress Image

Select the progress bar image you want displayed while the end-user is being scanned. The drop-down menu displays all the images defined in the [Images window](#) for your selection.

### Redirection

There are four Redirection options that specify where the end-user is redirected following successful remediation, when the end-user is allowed on the network. The option selected here overrides the Redirection option specified in the [Network Settings](#) for Remediation only.

- **Use Network Settings Redirection** — Use the Redirection option specified in the [Network Settings](#).
- **Disabled** — This option disables redirection. The end-user stays on the same web page where they were accepted onto the network.
- **To User's Requested URL** — This option redirects the end user to the web page they originally requested when they connected to the network.
- **To URL** — This option lets you specify the URL of the web page to which the end-user is redirected. This is typically the home page for the enterprise website, for example, "http://www.ExtremeNetworks.com."

## Remediation Attempt Limits

### Limit Remediation Attempts

Select this checkbox to limit the maximum number of times an end-user is allowed to initiate a rescan of their end-system after initially being quarantined, in an attempt to remediate their violations. If selected, enter the number of attempts allowed.

### Limit Time for Remediation

Select this checkbox to limit the total interval of time an end user is allowed to initiate a rescan of their end-system after initially being quarantined, in an attempt to remediate their violations. If selected, enter the amount of time in minutes.

## Remediation Links

This table lists the links displayed on the Assessment/Remediation web page for the end users to use to remediate their end-system violations. There are two default remediation links: Microsoft Support and MAC OS Support. Use this tab to add additional links such as an internal website for patches. Links must contain a valid protocol prefix (http://, https://, ftp://).

Click **Add** to open a window where you can define a new link's name and URL. Select a link and click **Edit** to edit the link's information. Click **Delete** to remove a URL from the table.

## Custom Remediation Actions

Use this table to create your own custom remediation action for a particular violation to use in place of the remediation action provided by the assessment server.

Use the following steps to add a custom remediation action:

1. Click the **Add** button to open the Add Custom Remediation Action window.
2. Enter the Test Case ID for the particular violation being remediated by the custom action. Test Case ID is found in the Health Results Details subtab in the End-Systems tab.
3. Add a custom description of the violation (required) and an optional custom solution.
4. If you have multiple portal configurations and you want to use this custom remediation action in all of your configurations, select the **Add to All Portal Configurations** option. This option overwrites any existing custom actions defined for the test case ID.
5. Click **OK**. Whenever the test case ID is listed as a violation on the web page, the custom violation description and solution you define is displayed instead of the remediation actions provided by the assessment server.

Select the **Define Default Custom Action** checkbox to advise end-users to contact the Helpdesk regarding additional security violations not explicitly listed with custom remediation actions. If this checkbox is selected, only the violations and associated custom remediation actions listed in the table would be presented to the user, along with a message advising them to contact the Helpdesk for any other security violations not explicitly configured with a custom remediation action. Click the **Edit** button to edit this message.

To copy a custom action to another portal configuration, select the action in the table and click the **Copy To** button. A window opens where you can select the portal configurations where you want to copy the action, and whether you want it to overwrite any existing custom remediation actions already defined for that test case ID.

## Portal Web Page URLs

The following table provides a list of URLs for accessing commonly used portal web pages. You can also access these web pages using the **Engine Portal Pages** button at the bottom of the Portal Configuration window.

Web Page	URL
<b>Preview Web Page</b> Allows you to preview the web pages that may be accessed by the end user during the assessment/remediation and registration process.	https://Extreme Access ControlengineIP /screen_ preview
<b>Registration Administration Page</b> Lets administrators view registered devices and users, and manually add, delete, and modify users.	https://Extreme Access ControlengineIP /administration
<b>Registration Sponsor Page</b> Lets sponsors view registered devices and users, and manually add, delete, and modify users.	https://Extreme Access ControlengineIP /sponsor
<b>Pre-Registration Page</b> The pre-registration web page lets selected personnel easily register guest users in advance of an event, and print out a registration voucher that provides the guest user with their appropriate registration credentials.	https://Extreme Access ControlengineIP /pre_ registration
<b>Self-Registration Page</b> Allows an authenticated and registered user to self-register additional devices that may not have a web browser (for example, game systems).	https://Extreme Access ControlengineIP /self_ registration

### Related Information

- [Portal Configuration Overview](#)

## Portal Configuration Guest Registration

---

Guest registration forces any new end-system connecting on the network to provide the user's identity in the registration web page before being allowed access to the network. Guests are initially redirected to a web page for registering their end-system when it is first connected to the network. After successful registration, the end-system is permitted access until the registration expires or is administratively revoked.

The end user's level of network access is determined by the settings specified here, and whether they are required to have a sponsor. With sponsored registration, end users are only allowed to register to the network when approved by a "sponsor," an internal trusted user to the organization. Sponsorship can provide the end user with a higher level of access than just guest registration and allows the sponsor to fine-tune the level of access for individual end users. The end user registers and declares a sponsor's email address. The sponsor is notified and approves the registration, and can assign an elevated level of access, if desired.

---

**NOTES:** If you configure both Guest Registration and [Authenticated Registration](#) for an area on your network, the end user is presented with a choice on the registration web page whether or not to authenticate.

The [Network Settings](#) and [Look and Feel](#) panels provide you access to common settings that are shared by the Registration portal web page.

---

**Guest Registration**

Introduction Message: [Edit...](#)

Customize Fields: [Open Editor...](#)

**Redirection**

Redirection:

**Registration Settings**

Verification Method:

Default Expiration:   (0 = never)

Facebook Registration

Google Registration

Microsoft Registration

Yahoo Registration

Salesforce Registration

Provider 1 Registration

Provider 2 Registration

**Sponsorship**

End users will be assigned to the Registered Guests group by default. With optional sponsorship, a sponsor can elevate their access. If sponsorship is required, the end user has no access until the sponsor approves.

Sponsorship Mode:

## Introduction Message

Click the **Edit** button to open a window where you can edit the introductory message displayed to end users when registering as guests. It may include an introduction to the network and information stating that the end user is agreeing to the Acceptable Use Policy (AUP) for the network upon registering their device. A link to the URL that contains the full terms and conditions of the network's AUP can be provided from this introductory message. Note that the URL for this link must be added as an Allowed URL in the [Allowed Web Sites window](#) accessed from the [Network Settings](#). By configuring the introductory message with this information, end users can be held accountable for their actions on the network in accordance with the terms and conditions set forth by the network's AUP. This message is shared by Guest Web Access and Guest Registration. Changing it for one access type also changes it for the other.

## Customize Fields

Click the **Open Editor** button to open the [Manage Custom Fields window](#) where you can manage the fields displayed in the Registration web page. These settings are shared by Guest Web Access, Guest Registration, and Secure Guest Access. Changing them for one access type also changes them for the others.

## Redirection

There are four Redirection options that specify where the end user is redirected following successful registration, when the end user is allowed on the network. The



option selected here overrides the Redirection option specified on the [Network Settings](#). This setting is shared by Guest Web Access, Guest Registration, and Secure Guest Access. Changing it for one access type also changes it for the others.

- **Use Network Settings Redirection** — Use the Redirection option specified on the [Network Settings](#).
- **Disabled** — This option disables redirection. The end user stays on the same web page where they were accepted onto the network.
- **To User's Requested URL** — This option redirects the end user to the web page they originally requested when they connected to the network.
- **To URL** — This option lets you specify the URL for the web page where the end user is redirected. This would most likely be the home page for the enterprise website, for example, "http://www.ExtremeNetworks.com."

## Registration Settings

### Verification Method

User Verification requires that guest end users registering to the network enter a verification code sent to their email address or mobile phone (via SMS text) before gaining network access. This ensures that network administrators have at least one way to contact the end user.

Select from the following verification methods:

- **Email** — The end user must enter an email address in the Registration web page. The Email Address field must be set to **Required** in the [Manage Custom Fields window](#).
- **SMS Gateway** — The end user must enter a mobile phone number in the Registration web page. The Phone Number field must be set to **Required** in the [Manage Custom Fields window](#).
- **SMS Gateway or Email** — The end user must enter a mobile phone number or email address in the Registration web page. The Phone Number and Email Address fields must be set to **Visible** in the [Manage Custom Fields window](#).
- **SMS Text Message** — The end user must enter a mobile phone number in the Registration web page. The Phone Number field must be set to **Required** in the [Manage Custom Fields window](#).

- **SMS Text or Email** — The end user must enter either a mobile phone number or email address in the Registration web page. The Phone Number and Email Address fields must be set to **Visible** in the [Manage Custom Fields window](#).

**If you have selected the "SMS Text Message" or the "SMS Text or Email" Verification method:** click the Service Providers link (below the verification method) to configure the list of mobile service providers from which end users can select on the Registration web page. This setting allows Extreme Management Center to correctly format the email address to which to send an email. This email is then received by the service provider and converted to an SMS text which is sent the user. The default configuration provides lists of the major US cellular service providers. NOTE: Not all cellular service providers provide a way to send SMS text messages via email.

**If you have selected the "SMS Gateway" or "SMS Gateway or Email" method:** enter the SMS Gateway Email address provided by the SMS Gateway provider.

**For all methods:** use the Message Strings link (below the verification method) to open the Message Strings Editor and modify the registration verification messages displayed to the user during the verification process. For example, if you have selected **Email**, you need to modify the "registrationVerificationEmailSentFromAddress" message string to be the appropriate email address for your company.

**For all methods:** set the Verify Pin Characters and Verify Pin Length options to define the characteristics and length of the verification code sent to the guest end user. This setting is shared by Guest Registration and Guest Web Access. Changing it for one access type also changes it for the other.

### **Default Expiration**

Enter a value and select a unit of time to configure the amount of time before an end user's registration automatically expires. When the registration expires, the end user is either suspended (registration must be manually approved by administrator/sponsor) or permanently deleted from the guest registration list. If a registration is deleted, the end-user must re-enter all their personal information the next time they attempt to access the network. Individual expiration time can also be set by a sponsor.

### **Registration**

The Registration checkboxes indicate the providers from which ExtremeControl can gather registration information: [Facebook](#), [Google](#), [Microsoft](#), [Yahoo](#), and [Salesforce](#).

You can [configure these providers](#) or configure additional OpenID Connect providers using the **Provider Registration** fields.

## Sponsorship

Use this section to [configure sponsorship](#) for Guest Registration. Select the Sponsorship Mode required. Additional settings display if you select optional or required sponsorship.

With sponsored registration, end users are only allowed to register to the network when approved by a "sponsor," an internal trusted user to the organization. Sponsorship can provide the end user with a higher level of access than just guest registration and allows the sponsor to fine-tune the level of access for individual end users. The end user registers and declares a sponsor's email address. The sponsor is notified and approves the registration, and can assign an elevated level of access, if desired.

## Portal Web Page URLs

The following table provides a list of URLs for accessing commonly used portal web pages. You can also access these web pages using the **Engine Portal Pages** button at the bottom of the Portal Configuration window.

Web Page	URL
<b>Preview Web Page</b> Allows you to preview the web pages that may be accessed by the end user during the <a href="#">assessment/remediation</a> and registration process.	https://Extreme Access ControlengineIP /screen_ preview
<b>Registration Administration Page</b> Lets administrators view registered devices and users, and manually add, delete, and modify users.	https://Extreme Access ControlengineIP /administration
<b>Registration Sponsor Page</b> Lets sponsors view registered devices and users, and manually add, delete, and modify users.	https://Extreme Access ControlengineIP /sponsor

Web Page	URL
<p><b>Pre-Registration Page</b>                      The pre-registration web page lets selected personnel easily register guest users in advance of an event, and print out a registration voucher that provides the guest user with their appropriate registration credentials.</p>	<p>https://Extreme                      Access                      ControlengineIP                      /pre_                      registration</p>
<p><b>Self-Registration Page</b>                      Allows an authenticated and registered user to self-register additional devices that may not have a web browser (for example, game systems).</p>	<p>https://Extreme                      Access                      ControlengineIP                      /self_                      registration</p>

**Related Information**

- [Portal Configuration Overview](#)

## Portal Configuration Provider Registration

The Registration Section includes a list of providers from which ExtremeControl can gather registration information. Configure registration using these providers or configure other OpenID Connect providers using the **Provider 1 Registration** and **Provider 2 Registration** options.

**NOTE:** Guest OAuth (e.g. Google, Yahoo) may not support native mobile browsers and display a “user agent” error. To access the network, use a standard browser application (e.g. Google Chrome).

**Guest Registration**

Introduction Message: [Edit...](#)

Customize Fields: [Open Editor...](#)

**Redirection**

Redirection: To User's Requested URL

**Registration Settings**

Verification Method: Disabled

Default Expiration: 30 Days (0 = never)

Facebook Registration

Google Registration

Microsoft Registration

Yahoo Registration

Salesforce Registration

Provider 1 Registration

Provider 2 Registration

**Sponsorship**

[Save](#) [Cancel](#)

## Facebook Registration

1. Select the [Facebook Registration](#) checkbox if you are implementing guest registration using Facebook as a way to obtain end user information. In this scenario, the Guest Registration portal provides the end user with an option to log into Facebook in order to complete the registration process.
2. Enter the Facebook App ID – When you create an application you are given a Facebook App ID to enter here.
3. Enter the Facebook App Secret – When you create an application you are given a Facebook App Secret to enter here.
4. Enter the Facebook Redirect URI – This information allows you to configure the provider as `fb_oauth`.
5. Press OK to save your changes.

## Google Registration

1. Select the [Google Registration](#) checkbox if you are implementing guest registration using Google as a way to obtain end user information. In this scenario, the Guest Registration portal provides the end user with an option to log into Google in order to complete the registration process.
2. Enter the Google Discovery URI – (a benefit of Open ID Connect) - This url gives you access to all the end-points you need to complete authorizations of user data.
3. Enter the Google App ID – When you create an application you are given a Google App ID to enter here.
4. Enter the Google App Secret – When you create an application you are given a Google App Secret to enter here.
5. Enter the Google Redirect URI – This information allows you to configure the provider as `google_oauth`.
6. Press OK to save your changes.

## Microsoft Registration

1. Select the [Microsoft Registration](#) checkbox if you are implementing guest registration using Microsoft as a way to obtain end user information. In this scenario, the Guest Registration portal provides the end user with an option to log into Microsoft in order to complete the registration process.
2. Enter the Microsoft Discovery URI – (a benefit of Open ID Connect) - This url gives you access to all the end-points you need to complete authorizations of user data.
3. Enter the Microsoft App ID – When you create an application you are given a Microsoft App ID to enter here.
4. Enter the Microsoft App Secret – When you create an application you are given a Microsoft App Secret to enter here.
5. Enter the Microsoft Redirect URI – This information allows you to configure the provider as `ms_oauth`.
6. Press OK to save your changes.

## Yahoo Registration

1. Select the [Yahoo Registration](#) checkbox if you are implementing guest registration using Yahoo as a way to obtain end user information. In this scenario, the Guest Registration portal provides the end user with an option to log into Yahoo in order to complete the registration process.
2. Enter the Yahoo Discovery URI – (a benefit of Open ID Connect) - This url gives you access to all the end-points you need to complete authorizations of user data.
3. Enter the Yahoo App ID – When you create an application you are given a Yahoo App ID to enter here.
4. Enter the Yahoo App Secret – When you create an application you are given a Yahoo App Secret to enter here.
5. Enter the Yahoo Redirect URI – This information allows you to configure the provider as `yahoo_oauth`.
6. Press OK to save your changes.

## Salesforce Registration

1. Select the [Salesforce Registration](#) checkbox if you are implementing guest registration using Salesforce as a way to obtain end user information. In this scenario, the Guest Registration portal provides the end user with an option to log into Salesforce in order to complete the registration process.
2. Enter the Salesforce Discovery URI – (a benefit of Open ID Connect) - This url gives you access to all the end-points you need to complete authorizations of user data.
3. Enter the Salesforce App ID – When you create an application you are given a Salesforce App ID to enter here.
4. Enter the Salesforce App Secret – When you create an application you are given a Salesforce App Secret to enter here.
5. Enter the Salesforce Redirect URI – This information allows you to configure the provider as `salesforce_oauth`.
6. Press OK to save your changes.

## Provider Registration (Generic)

1. To add a provider not already considered by Access Control, but uses Open ID Connect, click the box near Provider 1 (generic).
2. Provider 1 Discovery URI – (a benefit of Open ID Connect) – You can use the company’s own discovery URI. This feature gives you access to all the end-points that you need to complete authorizations of user data
3. Provider 1 App ID – This information is given by the provider.
4. Provider 1 App Secret – This information is given by the provider.
5. Provider 1 Image – You can add an image or a logo by selecting New from the drop-down menu. Drag and drop a file or select a file using the browser to add an image for this provider.
6. Provider 1 Text – Press the Text button to open the Localized Message String Editor window. Use the box to add text. Press OK to save your changes.
7. Provider 1 Redirect URI - This information allows you to configure the provider as `genprovider_oauth`.

The Enterprise Registration Center will include logos buttons for providers in Register as Guest panel. Click each logo to be redirected to the provider’s website for user authentication. You will then be redirected back to complete Open ID access authorization.

---

### Related Information

- [Portal Configuration Overview](#)



## Portal Configurations

The Portal Configurations panel in the **Control > Extreme Access Control** tab lets you view and edit all the portal configurations defined in Extreme Management Center.

To access the Portal Configurations panel, select **Extreme Access Control Configurations > Portal** from the left-menu tree. If you expand the Portal tree, the Default portal configuration plus any other configurations you have defined are displayed.

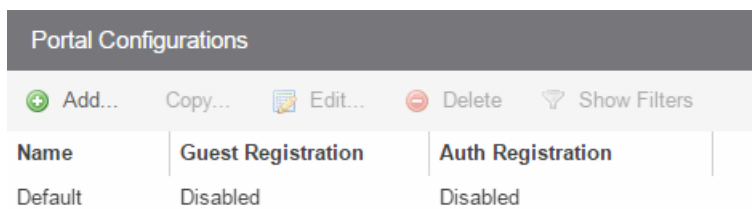

Portal Configurations		
Name	Guest Registration	Auth Registration
Default	Disabled	Disabled

### Related Information

- [Portal Configuration](#)
- [AAA Configuration](#)
- [Extreme Access Control Configuration Rules](#)

## Manage Custom Fields

---

This window lets you manage the fields displayed in the web pages presented to the end user when they access the network. It is configured as part of your portal configuration, and is accessed from the Customize Fields **Open Fields** button in the [Edit Portal Configuration panel](#). You can manage custom fields for both guest and authenticated access types:

- **Guest Access Types** — By default, the guest login/registration web page displays the First Name, Last Name, and Email Address fields. You can use this window to specify other fields you would like to be displayed (visible) and required. These settings are shared by Guest Web Access, Guest Registration, and Secure Guest Access. Modifying settings for one access type also changes them for the others.
- **Authenticated Access Types** — By default, the authenticated login/registration web page displays only the Acceptable Use Policy. You can use this window to specify other fields you would like to be displayed (visible) and required. These settings are shared by the Authenticated Web Access and Authenticated Registration access types. Modifying settings for one access type also changes them for the other.

Sample Manage Custom Fields Window

Field Name	Visibility	Required	Display String
First Name:	Visible	<input checked="" type="checkbox"/>	
Middle Name:	Visible	<input type="checkbox"/>	
Last Name:	Visible	<input checked="" type="checkbox"/>	
Email Address:	Visible	<input checked="" type="checkbox"/>	
Phone Number:	Not Visible	<input type="checkbox"/>	
1st Custom:	Not Visible	<input type="checkbox"/>	Display String
2nd Custom:	Not Visible	<input type="checkbox"/>	Display String
3rd Custom:	Not Visible	<input type="checkbox"/>	Display String
4th Custom:	Not Visible	<input type="checkbox"/>	Display String
5th Custom:	Not Visible	<input type="checkbox"/>	Display String
Device Description:	Not Visible	<input type="checkbox"/>	Display String

**Acceptable Use Policy**

Policy Text:

Display

Note: Custom Display String fields are common between Unauthenticated and Authenticated Registration types. Modifying a Display String for one Registration type will affect the Display String in the other.

Only the Name, Email, and Acceptable Use Policy fields apply to Facebook

For each field, use the drop-down menu to select whether the field is:

- **Visible** - the field is displayed in the login/registration web page for the end user. If you want the field information to be required (the end user must enter the information), select the "Required" checkbox.
- **Not Visible** - the field is not displayed in the login/registration web page for the end user.
- **Admin Only** - the field is visible to network administrators only, in the Add/Edit User web page accessed from the Registration System Administration web page. The end user is not able to see or edit the field.

**NOTES:** For Guest Registration and Guest Web Access: If you are configuring a Verification Method, the Email Address field and/or the Phone Number field are required (depending on the verification method you have selected) and must be set to **Visible/Required**. For more information, see [How to Configure Verification for Guest Access Registration](#).

For Secure Guest Access: The Credential Delivery method requires the Email Address field and/or the Phone Number field (depending on the delivery method you have selected) to be set to **Visible/Required**. For more information, see [Credential Delivery Method](#) in the Edit Portal Configuration panel.

For Facebook Registration: Only the First Name, Last Name, and Email Address fields are filled using Facebook data. These fields and the Acceptable Use Policy (AUP) option are the only fields that apply to Facebook registration. If the display AUP option is selected, the captive portal verifies that the AUP is acknowledged before redirecting the user to Facebook.

---

Use the **Custom fields** to add additional fields to the login/registration web page. Set the field to **Visible**, and then add the text to display by adding a display string. Here are some examples of how to use custom fields:

- In a higher education environment a custom field display string may be set to "Student ID Number" or "Dorm Room Number" to record additional information about students registering to the network.
- In a corporate environment, a custom field display string may be set to "Company Name" to obtain information about organization to which a partner or guest belongs. Or, you might want the end user to enter a device description, such as an asset tag number.
- In a convention deployment, the field may be set to "Booth Number" to record the booth to which a registering end-system is associated.

Select the **Acceptable Use Policy** checkbox if you would like the web page to display your organization's Acceptable Use Policy (AUP) and click the **Edit** button to open a window where you can add the AUP text.

---

**NOTE:** The Pre-Registration web page always displays the First Name and Last Name fields even if they are not selected as visible/required in the Manage Custom Fields window. If they are selected as required, they are displayed as required on the Pre-Registration web page, otherwise they are displayed as optional. This is because it is important to prompt for a first and last name to be included on the pre-registration voucher printed out.

---

## Related Information

- [Edit Portal Configuration Panel](#)

## Keywords

The Custom Arguments field is used to specify the arguments passed to a program. Each argument is delimited by spaces. An argument can be a literal, passed to the program exactly as typed, or a variable, specified as \$keyword. A group of literals and variables can be combined into a single argument by using double quotes. The value "all" is a special value that tells Extreme Management Center to pass all variable values to the program as individual arguments. See below for a list of available keywords, along with their definitions.

### Keyword Definitions

There are certain "keywords" that you can use in your email, syslog, and trap messages to provide specific information. These \$keywords are replaced with information from the notification when the notification action is executed.

Following is a list of available keywords for Extreme Access Control notifications, along with the value the keyword return. The keywords are organized according to the notification type they pertain to (End-System, Registration, Health Result, User Group, or End-System Group), and can only be used when that specific type of notification action is being edited. The Default keywords can be used with any notification type.

Keyword	Returned Value
<b>Default Keywords</b>	
\$type	The notification type.
\$trigger	The notification trigger.
\$conditions	A list of the conditions specified in the notification action.
\$server	The Extreme Management Center server IP address.
<b>End-System Keywords</b>	
\$macAddress	The end-system's current MAC address.

Keyword	Returned Value
\$oldmacAddress	The end-system's previous MAC address.
\$ipAddress	The end-system's current IP address.
\$oldipAddress	The end-system's previous IP address.
\$username	The current username used to authenticate the end-system.
\$oldusername	The previous username used to authenticate the end-system.
\$hostname	The end-system's hostname.
\$oldhostName	The end-system's previous hostname.
\$operatingSystemName	The full operating system running on the end-system.
\$oldoperatingSystemName	The previous full operating system the end-system was running.
\$ESType	The end-system's current operating system family (for example, Windows, Mac, or Linux).
\$oldESType	The end-system's previous operating system family (for example, Windows, Mac, or Linux).
\$state	The end-system's current state: ACCEPT, REJECT, SCAN, QUARANTINE, DISCONNECTED, or ERROR.
\$oldstate	The end-system's previous state: ACCEPT, REJECT, SCAN, QUARANTINE, DISCONNECTED, or ERROR.
\$stateDescr	A description of the end-system's current state.
\$oldstateDescr	A description of the end-system's previous state.
\$extendedState	An extended description of the end-system's current state.
\$oldextendedState	An extended description of the end-system's previous state.
\$switchIP	The IP address of the switch to which the end-system is currently connected.
\$oldswitchIP	The IP address of the switch to which the end-system was previously connected.

Keyword	Returned Value
\$switchLocation	The physical location of the switch the end-system is currently connected to (for example, the building/floor location).
\$oldswitchLocation	The physical location of the switch the end-system was previously connected to (for example, the building/floor location).
\$switchPort	The ifIndex of the switch port the end-system is currently connected to.
\$oldswitchPort	The ifIndex of the switch port the end-system was previously connected to.
\$switchPortId	The name of the switch port the end-system is currently connected to (for example, ge.1.1).
\$oldswitchPortId	The name of the switch port the end-system was previously connected (for example, ge.1.1).
\$authType	The latest authentication method used by the end-system to connect to the network.
\$oldauthType	The previous authentication method used by the end-system to connect to the network.
\$allAuthTypes	A comma-separated list of authentication types currently used for this end-system in its current location. The list is only provided if there is more than one authentication type.
\$oldallauthTypes	A comma-separated list of authentication types previously used for this end-system in its current location. The list is only provided if there is more than one authentication type.
\$nacProfileName	The Extreme Access Control profile currently assigned to the end-system.
\$oldnacProfileName	The Extreme Access Control profile previously assigned to the end-system.
\$reason	The reasons why the end-system is assigned its current Extreme Access Control profile or is in a particular state.

Keyword	Returned Value
\$oldreason	The reasons why the end-system was assigned its previous Extreme Access Control profile or is in a particular state.
\$policy	The access policy currently assigned to the end-system, if on a policy-based switch.
\$oldpolicy	The access policy previously assigned to the end-system, if on a policy-based switch.
\$firstSeentime	The first time the end-system was seen by the Extreme Access Control engine.
\$lastSeenTime	The last time the end-system was seen by the Extreme Access Control engine.
\$oldlastSeenTime	The previous last time the end-system was seen by the Extreme Access Control engine.
\$nacAppliancelp	The IP address of the Extreme Access Control engine on which the end-system authenticated.
\$oldnacAppliancelp	The IP address of the previous Extreme Access Control engine on which the end-system authenticated.
\$nacapplianceGroupName	The engine group for the Extreme Access Control engine where the end-system was last heard.
\$oldnacApplianceGroupName	The previous engine group for the Extreme Access Control engine where the end-system was last heard.
\$lastScanTime	The last time a scan was performed on the end-system.
\$lastScanResultState	The resulting state of the last scan: ACCEPT, QUARANTINE, or empty.
\$ssid	The Service Set Identifier (SSID) of the wireless network to which the end-system is connected.
\$oldssid	The Service Set Identifier (SSID) of the wireless network to which the end-system was previously connected.



Keyword	Returned Value
\$wirelessAp	The name of the Wireless Access Point (AP) to which the end-system is connected. If the AP's name is unavailable, then the AP's MAC address is reported. If the MAC address is unavailable, then the AP's serial number is reported.
\$oldwirelessAp	The name of the Wireless Access Point (AP) to which the end-system was previously connected. If the AP's name is unavailable, then the AP's MAC address is reported. If the MAC address is unavailable, then the AP's serial number is reported.
\$ifAlias	The ifAlias of the switch port to which the end-system is currently connected.
\$oldifAlias	The ifAlias of the switch port to which the end-system was previously connected.
\$ifDescription	The ifDescription of the switch port to which the end-system is currently connected.
\$oldifDescription	The ifDescription of the switch port to which the end-system was previously connected.
\$ifName	The ifName of the switch port to which the end-system is currently connected.
\$oldifName	The ifName of the switch port to which the end-system was previously connected.
\$custom1	The text from the Custom 1 end-system information column.
\$custom2	The text from the Custom 2 end-system information column.
\$custom3	The text from the Custom 3 end-system information column.
\$custom4	The text from the Custom 4 end-system information column.
\$regName	The registered username supplied by the end user during the registration process.

Keyword	Returned Value
\$regEmail	The email address supplied by the end user during the registration process.
\$regPhone	The phone number supplied by the end user during the registration process.
\$regData1	The text from the Custom 1 registration field supplied by the end user during the registration process.
\$regData2	The text from the Custom 2 registration field supplied by the end user during the registration process.
\$regData3	The text from the Custom 3 registration field supplied by the end user during the registration process.
\$regData4	The text from the Custom 4 registration field supplied by the end user during the registration process.
\$regData5	The text from the Custom 5 registration field supplied by the end user during the registration process.
\$regDeviceDescr	The device description supplied by the end user during the registration process.
\$regSponsor	The registered device's sponsor.
\$memberOfGroups	The current list of MAC end-system groups listed in the Groups end-system information column.
\$oldmemberOfGroups	The previous list of MAC end-system groups listed in the Groups end-system information column.
\$groupDescr1	The entry description that was entered when the end-system was added to a MAC-based end-system group.
\$groupDescr2	The entry description that was entered when the end-system was added to a MAC-based end-system group.
\$groupDescr3	The entry description that was entered when the end-system was added to a MAC-based end-system group.
<b>Registration Keywords</b>	

Keyword	Returned Value
\$category	The type of action that was performed, for example: Registered Device Added, Registered Device Updated, Registered User Added; Registered Device Removed, Registered User Removed.
\$time	The time the end-system registered to the network.
\$source	The MAC address of the registered device or the name of the registered user.
\$message	A message describing the action that was performed (for example, Added Registered Device for User: <username> - MacAddress: <MAC address>).
<b>Health Result Keywords</b>	
\$macAddress	The end-system's MAC address.
\$ipAddress	The end-system's IP address.
\$startScanDate	The date and time the scan started.
\$endScanDate	The date and time the scan ended.
\$hostUnreachable	Whether the host was unreachable before or after the scan was run: true or false.
\$testSets	A list of test sets that were run during assessment.
\$totalScore	The total sum of the scores for all the health details for the health result.
\$topScore	The highest score received for a health detail in the health result.
\$riskLevel	The risk level assigned to the end-system based on the health result.
\$riskLevelReason	The reason the health result was placed into the specified risk level.
\$assessmentSummary	A list of all the test cases that were run against the device during assessment.
\$statusDetail	A list of the vulnerabilities that were found during assessment.

Keyword	Returned Value
\$assessmentServerIpAddress	The IP address of the assessment server that performed the scan.
\$assessmentServerName	The name of the assessment server that performed the scan.
<b>User Group Keywords</b>	
\$name	The name of the user group.
\$createdBy	The name of the user that created the user group.
\$creationTime	The time and date the user group was created.
\$description	A description of the user group (if one was defined when the group was created).
\$added	A comma-separated list of user entries that were added to the group during the change.
\$removed	A comma-separated list of user entries that were removed from the group during the change.
\$lastModifiedTime	The last time the user group was modified.
\$oldlastModifiedTime	The previous last time the user group was modified.
\$lastModifiedBy	The name of the user who most recently edited the user group.
\$oldlastModifiedBy	The name of the user who had previously edited the user group.
\$revisionCounter	The current revision count (the number of changes that have been made) for the user group.
\$oldrevisionCounter	The previous revision count (the number of changes that have been made) for the user group.
\$listtype	One of the following types: Username, LDAP User Group, RADIUS User Group.
<b>End-System Group Keywords</b>	
\$name	The name of the end-system group.
\$createdBy	The name of the user that created the end-system group.
\$creationTime	The time and date the end-system group was created.

Keyword	Returned Value
\$description	A description of the end-system group (if one was defined when the group was created).
\$added	A comma-separated list of end-system entries that were added to the group during the change.
\$removed	A comma-separated list of end-system entries that were removed from the group during the change.
\$lastModifiedTime	The last time the end-system group was modified.
\$oldlastModifiedTime	The previous last time the end-system group was modified.
\$lastModifiedBy	The name of the user who most recently edited the end-system group.
\$oldlastModifiedBy	The name of the user who had previously edited the end-system group.
\$revisionCounter	The current revision count (the number of changes that have been made) for the end-system group.
\$oldrevisionCounter	The previous revision count (the number of changes that have been made) for the end-system group.
\$listtype	One of the following types: MAC, IP, Hostname.

### Related Information

For information on related windows:

- [Extreme Access Control Options Panel](#)

## Allowed Web Sites

Use this window to configure the web sites end users are allowed to access during the Extreme Access Control Assisted Remediation and Registration process. This window is configured as part of your portal configuration, and is accessed by clicking the **Open Editor** button in the Network Settings panel of the [Portal Configuration tree](#).

There are three subtabs in the window: [Allowed URLs](#), [Allowed Domains](#), and [Web Proxy Servers](#).

### Allowed URLs

This tab lists the URLs that end-systems can access while the end-system is being assessed, when the end-system is quarantined, or when the end-system is not registered on the network. The Extreme Access Control engine proxies these HTTP connections to the allowed URLs as long as the engine is configured with an appropriate DNS server.

Any URLs that you may have referenced in the captive portal configuration must be entered into this tab so an end-system with restricted access to the network is permitted to communicate to the URL. For example, a URL entered in the [Helpdesk Information](#) section should be entered here so a quarantined end-system may access the Helpdesk web site while quarantined.

Enter the URL you want to add to the list and click **Add**. URLs must be entered without "http://www". For example, if "http://www.apple.com" is an allowed website, then enter "apple.com" as the allowed URL.

You can use the **Import** button to import a file of URLs to the list. Files must be formatted to contain one URL per line. Lines starting with "#" or "/" are ignored.

---

**NOTE:** It is not necessary to enter URLs that are accessed over secure HTTP (HTTPS). To restrict access to these URLs, you must configure network policy to allow or disable HTTPS traffic all together or restrict it to specific IP ranges.

---

When an allowed URL is added, all web pages located within the directory are also allowed. For example, if apple.com is configured as an allowed URL, then HTTP connections for the following URLs are also permitted:

```
www.apple.com/downloads  
www.apple.com/downloads/macosex
```

HTTP connections to URLs located on different hosts than that of the allowed URL entry are not permitted. These HTTP connections are redirected to the Assisted Remediation or MAC Registration web page. Using the same example, if `apple.com` is configured as an allowed URL, HTTP connections for the following URLs are not allowed:

```
store.apple.com
store.apple.com/download
```

Images on the web page may not be displayed properly if the images are served on a separate HTTP connection at a different URL. For example, the web page `http://www.apple.com/support/downloads/` contains images downloaded from `http://images.apple.com`. Therefore, if `apple.com/support/downloads/` is configured as an allowed URL, all of the text on the web page would be displayed properly, but the images would not be displayed on the web page unless `images.apple.com` is also entered as an Allowed URL.

## Allowed Domains

This tab lists the domains to which end users can browse while the end-system is being assessed, the end-system is quarantined, or when the end-system is not registered on the network. The Extreme Access Control engine proxies these HTTP connections to the allowed domains as long as the engine is configured with an appropriate DNS server.

The higher-level domain information not explicitly specified in an allowed domain entry are also permitted for an end-system as well as any web pages served from within the domain. For example, if `apple.com` is configured as an allowed domain, then HTTP connections for the following URLs are also permitted:

```
www.apple.com
www.info.apple.com
store.apple.com
store.apple.com/info
images.apple.com
www.apple.com/software
apple.com/software
```

HTTP connections not matching the specified domain level information in an allowed domain entry are not permitted. These HTTP connections are redirected

to the Assisted Remediation or Registration web page. Using the same example, if `apple.com` is configured as an allowed domain, HTTP connections for the following URLs are not allowed:

```
www.apple2.com
store.apple-chat.com
www.msn.com
```

If multiple allowed domain entries are configured with overlapping first-level and second-level domain information, then the allowed domain entry that is more specific takes precedence. For example, if `apple.com` and `store.apple.com` are configured as allowed domain entries, then the `apple.com` entry is effectively disabled. Therefore, HTTP connections for the following URLs are allowed:

```
store.apple.com
store.apple.com/info
www.store.apple.com/info
```

The following HTTP connections are not allowed:

```
www.apple.com
www.apple.com/support
images.apple.com
```

The following is a list of default allowed domains that are pre-configured for Extreme Access Control remediation. These allowed domains are provided as part of the assisted remediation assessment functionality, which allows end-users limited Internet access to update patches, antivirus definitions, and to upgrade vulnerable software in order to comply with the network security policy. The Extreme Access Control engine proxies traffic to these allowed domains when an end user clicks on a remediation link presented on the violations page.

A default allowed domain should only be deleted if it is determined that a quarantined user should not be able to access it. In some cases, you may need to add additional URLs or domains. If a quarantined user selects a remediation link to resolve an issue and is redirected back to the remediation web page, the domain or URL needs to be added to provide access to that site.

---

<code>adobe.com</code>	<code>akadns.net</code>	<code>akamai.com</code>
<code>akamai.net</code>	<code>altn.com</code>	<code>apache.org</code>
<code>apple.com</code>	<code>archives.neohapsis.com</code>	<code>asp.net</code>

---



---

aws.amazon.com	bitdefender.com	bugzilla.org
ca.com	cdnetworks.com	cert.org
cisco.com	clamav.net	cve.mitre.org
debian.org	drupal.org	eset.com
eu.ntt.com	f-secure.com	gnu.org
godaddy.com	ibm.com	ipswitch.com
isc.org	kaspersky.com	lac.co.jp
level3.com	localmirror.com	kaspersky-labs.com
macromedia.com	mandriva.com	mcafee.com
microsoft.com	mozilla.org	mysql.com
netwinsite.com	norton.com	novell.com
nsatc.net	openssl.org	oracle.com
osvdb.org	pandasecurityusa.com	php.net
phpnuke.org	redhat.com	samba.org
secunia.com	securiteam.com	securityfocus.com
securitytracker.com	sendmail.org	sophos.com
sourceforge.net	squid-cache.org	sun.com
support.citrix.com	suse.com	suse.de
symantec.com	symantecliveupdate.com	techtarget.com
trendmicro.com	ubuntu.com	us-cert.gov
verisign.com	verisigninc.com	vmware.com
vupen.com	web.mit.edu	webroot.com
windows.com	windowsupdate.com	wireshark.org
xforce.iss.net	zerodayinitiative.com	zope.org

---

## Web Proxy Servers

This tab is used to specify the web proxy server(s) deployed on the network. The Extreme Access Control engine proxies end-system Allowed URL and Allowed Domain HTTP traffic to the defined web proxy servers if the network utilizes proxy servers to access the Internet.

If multiple web proxy servers are configured, the Extreme Access Control engine round robins HTTP connections to the configured proxy servers. If the allowed web site is located with the Extreme Access Control engine's configured domain, the Extreme Access Control engine directly contacts the web site and does not go through the configured web proxy servers.

---

### **Related Information**

For information on related help topics:

- [Edit Portal Configuration Panel](#)

## Message Strings Editor

The Message Strings Editor is where you can edit the text and formatting of the various system-defined messages used on the portal web pages, or add a custom message string, if desired. You can also import a file of message strings or export message strings to a file.

To access the Editor, click the Message Strings **Launch Message Strings Editor** button in the Portal Look and Feel view in the **Control > Access Control** tab. Message strings are listed alphabetically according to the Message Key, which is the message identifier. Double-click a message string to open a window where you can edit the message.

Click the down arrow in the right corner of the column header to filter and sort information in the table, and add or remove columns from the table.

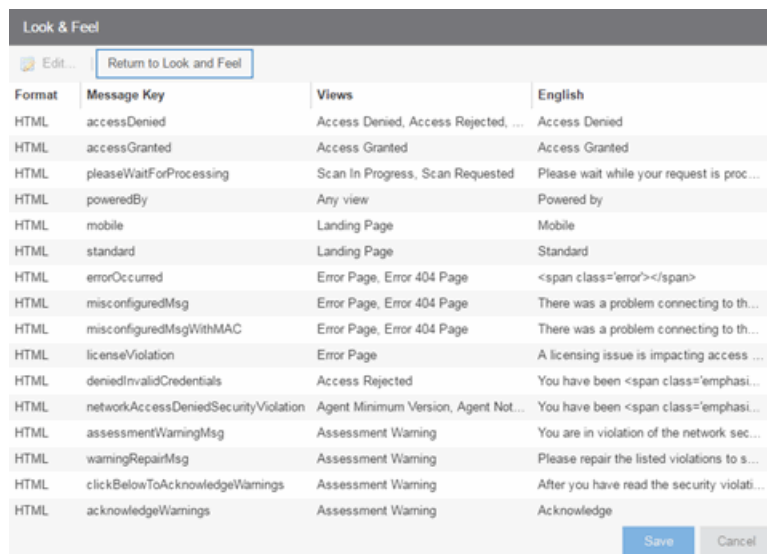

The screenshot shows a window titled "Look & Feel" with a sub-header "Edit...". Below the header is a table with four columns: "Format", "Message Key", "Views", and "English". The table lists various system-defined messages. At the bottom right of the table are "Save" and "Cancel" buttons.

Format	Message Key	Views	English
HTML	accessDenied	Access Denied, Access Rejected, ...	Access Denied
HTML	accessGranted	Access Granted	Access Granted
HTML	pleaseWaitForProcessing	Scan In Progress, Scan Requested	Please wait while your request is proc ...
HTML	poweredBy	Any view	Powered by
HTML	mobile	Landing Page	Mobile
HTML	standard	Landing Page	Standard
HTML	errorOccurred	Error Page, Error 404 Page	<span class="error"></span>
HTML	miscconfiguredMsg	Error Page, Error 404 Page	There was a problem connecting to th...
HTML	miscconfiguredMsgWithMAC	Error Page, Error 404 Page	There was a problem connecting to th...
HTML	licenseViolation	Error Page	A licensing issue is impacting access ...
HTML	deniedInvalidCredentials	Access Rejected	You have been <span class="emphasi...
HTML	networkAccessDeniedSecurityViolation	Agent Minimum Version, Agent Not...	You have been <span class="emphasi...
HTML	assessmentWarningMsg	Assessment Warning	You are in violation of the network sec...
HTML	warningRepairMsg	Assessment Warning	Please repair the listed violations to s...
HTML	clickBelowToAcknowledgeWarnings	Assessment Warning	After you have read the security violati...
HTML	acknowledgeWarnings	Assessment Warning	Acknowledge

### Edit... Edit Message

Select a message in the table and click this button (or double-click the message) to open the Modify Localized Entry window where you can modify the text for the message. Use the Next/Previous buttons in the window to cycle through all the message strings for easy editing.

**NOTE:** To change the Message Key for a user-defined message, you must delete and recreate the message using the new key.

## Message Strings Table

This table displays all the message strings used in the **Access Control** tab. It includes the following columns:

- **Format** — Displays the supported format for the message text: HTML or Text.
- **Message Key** — The message identifier.
- **Views** — The portal views where this message is used.
- **English** — The text of the message.
- **Additional columns** for each supplemental locale (language) you have configured in the portal configuration.

## Related Information

For information on related help topics:

- [Portal Configuration](#)

## Extreme Access Control Engine Groups

The Extreme Access Control Engine Groups panel is displayed in the right panel when you select the Extreme Access Control Engine Groups folder in the left panel. (The Extreme Access Control Engine Groups folder is only displayed if you have created engine groups.) The tab displays a table of information about the engine groups in the folder.

Use the table options and tools to filter, sort, and customize table settings. You can access the options by clicking the down arrow in the right corner of any column header.

Access Control Engine Groups						
Name	Access Control Co	Portal Configuration	AAA Configuration	Policy Mapping	Engine Settings	Policy Domain
Default	Default	Default	Default	Default	Default	Default Policy Do...
Randy's Alpha V...	NetSight-NAC L...	NetSight-NAC L...	NetSight-NAC L...	Default	NetSight-NAC L...	
Randy's Beta V...	NetSight-NAC L...	NetSight-NAC L...	NetSight-NAC L...	Default	NetSight-NAC L...	
Randy's Releas...	NetSight-NAC L...	NetSight-NAC L...	NetSight-NAC L...	Default	NetSight-NAC L...	

### Name

The name of the engine group.

**Extreme Access Control Configuration**

The Extreme Access Control Configuration currently selected for this engine group.

**Portal Configuration**

If your network is implementing Registration or Assisted Remediation, the [Portal Configuration](#) that defines the branding and behavior of the website used by the end user during the registration or remediation process.

**AAA Configuration**

The AAA Configuration used by this engine group.

**Policy Mapping**

The Default policy mapping can be viewed in the Extreme Access Control Configurations tree (under Extreme Access Control Profiles) or accessed from the [Edit Extreme Access Control Profile window](#).

**Engine Settings**

The Engine Settings configured for the group. Use the Edit Engine Settings window to specify and configure engine settings.

---

**Related Information**

For information on related windows:

- [Edit Portal Configuration Window](#)

## Group Editor

This panel lists the various rule groups used to define the criteria for the rules used in your Extreme Access Control configuration. You can use this window to view and edit the defined rule groups and also to add new rule groups for use in your Extreme Access Control configuration. Any changes made in this window are written immediately to the Extreme Management Center database.

Extreme Management Center comes with system-defined rule groups. Extreme Management Center also contains system-defined end-system groups that automatically populate. The Assessment Warning end-system group includes end-systems that have assessment warnings and must acknowledge them before being granted access to the network. The Blacklist end-system group includes end-systems denied access to the network. The other system-defined groups are populated as the end-systems register through the Registration portal.

Select from the following rule group categories when you create a new rule group:

Category	Group Types	Value Types
All Groups	All Types	A list of all group types.
Device Type Groups	Device Type	A list of device types.
End-System Groups	Hostname	A list of hostnames, which can be an exact match or wild card (for example, *.extremenetworks.com).
	IP	A list of IP addresses or subnets.
	LDAP Host Group	A way to group hosts by doing an LDAP lookup on the resolved hostname of the end-system detected on the network, which can be an exact match or wild card.
	MAC	A list of MAC addresses, MAC OUI, or MAC masks.
Location Groups	Location	A list of switches, switches and ports, or switches and SSIDs.

Category	Group Types	Value Types
Time Groups	Time of Week	A list of the times of the week when the end user is accessing the network. You can only <a href="#">add a new Time Group</a> via NAC Manager.
User Groups	LDAP User Group	A list imported from an LDAP Server, organized by Organization Unit (OU), which can be an exact match or wild card.
	RADIUS User Group	A list of attributes returned by the RADIUS server, which can be an exact match or wild card.
	Username	A list of usernames, which can be based on an exact match or a wild card.

To access this window, open the **Access Control** tab and select Extreme Access Control Configurations > Group Editor in the left-panel.

Name ↑	Type	Used By	Description
20X Network	Location		Switches on the VLANs maintained by Randy Houde...
22X Network	Location		Switches on the VLANs maintained by Mike Nikitas, ...
Access Points	MAC	NetSight-NAC Lab N...	Default End-System Group for Access Points.
Administrators	LDAP User ...	NetSight-NAC Lab N...	Default User Group for Administrators.
Android	Device Type		Device Types in Android Family
Apple iOS	Device Type		Device Types in Apple iOS Family
Assessment Warning	MAC	NetSight-NAC Lab N...	End-Systems that have assessment warnings and m...
BlackBerry	Device Type		Device Types in BlackBerry Family
Blacklist	MAC	NetSight-NAC Lab N...	End-Systems denied access to the network
Chrome OS	Device Type		Device Types in Chrome OS Family
Contractor End-Systems	MAC	NetSight-NAC Lab N...	End systems that belong to authorized contractors
DEVLAB Users	Username	NetSight-NAC Lab N...	Users from the DEVLAB Windows domain.
Default All	Time of Week		
DomainPortalCatchAll	MAC		A global CatchAll group used by the domain registrat...
End-System Authentications	Username	NetSight-NAC Lab N...	Automcatic computer sign on requests
Fusion Disconnected Systems	MAC		The default group to move endsystems to on remote...
Fusion Pending Approval	MAC		Endsystem Group to hold endsystems that await ap...

### Add Button Add...

Use this button to add rule groups or to import MAC entries from a file for viewing and assigning to various end-system groups.

### Edit Button Edit...

Use this button to edit existing rule groups.

**Delete Button**  Delete

Use this button to delete existing rule groups.

**Import button**

Use this button to import group entries from files.

**Name**

The name of the rule group.

**Type**

The type selected for the specific rule group; for example, an end-system group could have a type of MAC.

**Used By**

The name of the Identity and Access configuration using this rule group.

**Description**

A description of the rule group.

---

**Related Information**

For information on related windows:

- [Create Rule Window](#)



## Add/Edit Device Type Group

There are nine system-defined operating system family device type groups that are automatically populated by Extreme Management Center: Android, Apple iOS, Blackberry, Chrome OS, Game Console, Linux, Mac, Windows, and Windows Mobile. You can view these system-defined groups and your other device type groups by expanding the Extreme Access Control Configurations > Group Editor > Device Type Groups left-panel tree.

Device type groups are comprised of entries that Extreme Access Control uses to determine if an end-system's device type matches the group. Entries can be a specific device type or a wildcard, such as Windows 7 or win\*. If an entry does not already contain a wildcard, Extreme Management Center creates a wildcard by adding an asterisk (\*) to the beginning and end of the entry. For example, if the entry is **Gentoo**, the match pattern is **\*Gentoo\*** allowing a match for any end-system device type that contains Gentoo. This allows you to restrict the match to a very specific value that might include a version number or model number, or expand the match to include all versions and model numbers of a certain operating system or hardware family.

For additional information about how to use device type groups, see [How to Use Device Type Profiling](#).

**NOTE:** Changes to rule groups do not require an enforce. Changes are automatically synchronized with engines on the next status update. Changes do not affect end-systems until the next authentication and/or assessment occurs.

To access the Add New Group window, click **Add** (  Add... ) in the Device Type Groups right panel.

The Add New Group window opens.

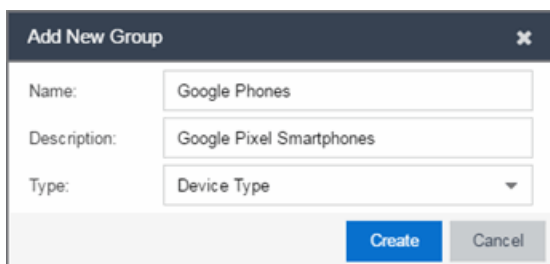

Add New Group	
Name:	Google Phones
Description:	Google Pixel Smartphones
Type:	Device Type
<input type="button" value="Create"/> <input type="button" value="Cancel"/>	

**Name**

Enter a new name for the device type group. Once a group is created, you cannot edit the name of the group.

**Description**

Enter a description of the device type group.

**Type**

To create a new device type group, select **Device Type** from the drop-down menu.

Click the **Create** button to open the Device Type Entry Editor section of the window.

Click the **Select from Existing Types** button (  ) to open the Select Device Types window from which you can choose a list of predefined entries. Click the **Add** button in the Device Type Entry Editor section of the window to open the Add Entry window.

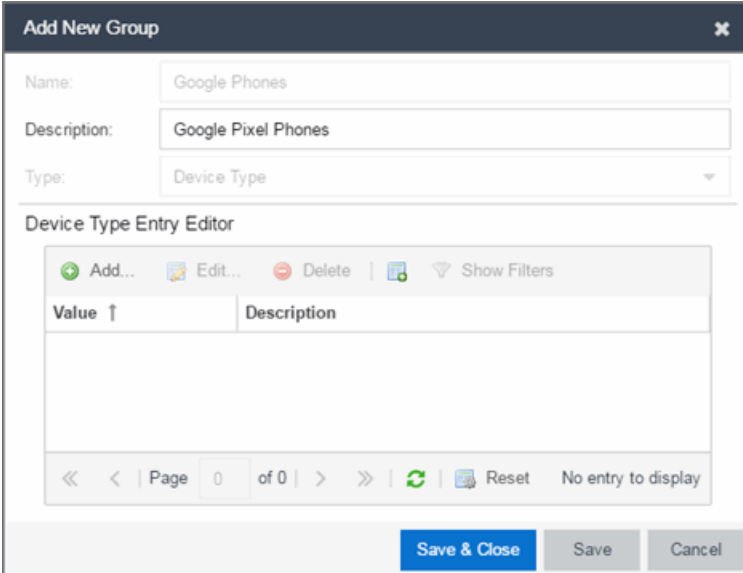

Value ↑	Description
---------	-------------

Use this window to add a new entry by entering a device type or a wildcard, such as Google Pixel or \*pixel. Alternately, you can select a type from a list of entries that already appear in existing device type groups from the Select Device Types window. This window can be accessed by clicking the **Select from Existing Types** button. This list allows you to multi-select entries, and each entry appears as a separate row in the table. The list also allows you to select **Unknown** that matches against any device that does not have an operating system name, either due to failed detection or because detection hasn't happened yet.

All entries selected from the list are assigned the same description. If you would like a separate description for each type, you need to add each entry individually.

## Related Information

For information on related windows:

- [Create Rule Window](#)
- [Manage Rule Groups Window](#)

## End-Systems

The **End-Systems** tab presents end-system connection information for a single Extreme Access Control engine, all Extreme Access Control engines, or all the engines in an engine group, depending on what you select in the left-panel tree. You can also monitor end-system events and view the health results from an end-system's assessment.

The **End-Systems** tab is the first tab displayed when accessing the **Control > Access Control** tab. A high-level overview of the functionality found in the [Extreme Access Control tab](#) is also available.

To access this tab, select a single Extreme Access Control engine, the All Extreme Access Control Engines folder, or an engine group in the left-panel tree, then click the **End-Systems** tab in the right panel.

Use the table options and tools to filter, sort, and customize table settings. Access the options by clicking the down arrow in the right corner of any column header.

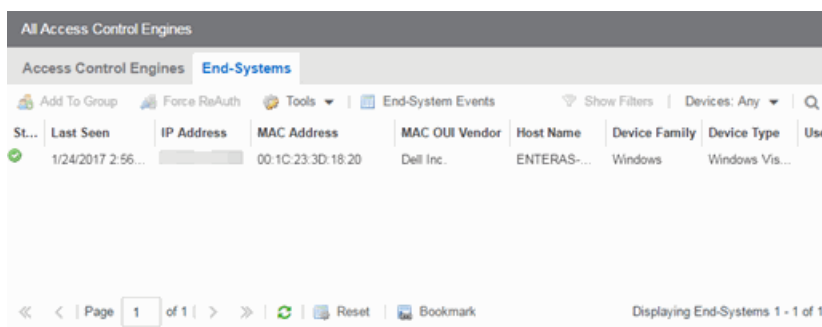

St...	Last Seen	IP Address	MAC Address	MAC OUI Vendor	Host Name	Device Family	Device Type	User
✓	1/24/2017 2:56...		00:1C:23:3D:18:20	Dell Inc.	ENTERAS-...	Windows	Windows Vis...	

## End-Systems

This table displays the last known connection state for each end-system that has attempted connection.

### State

The end-system's connection state:

- Scan — The end-system is currently being scanned.
- Accept — The end-system is granted access with either the Accept policy or the attributes returned from the RADIUS server.
- Quarantine — The end-system is quarantined because the assessment failed.
- Reject — The end-system was rejected because the assigned Extreme Access Control profile was set to Reject, the MAC Locking test failed, or the RADIUS server was reachable but rejected the authentication request.
- Disconnected — All sessions for the end-system are disconnected. This state is only applicable for end-systems connected to switches that have RADIUS accounting enabled.
- Error — Indicates one of nine problems:
  - the MAC to IP resolution failed, if assessment is enabled
  - the MAC to IP resolution timed out, if assessment is enabled
  - all RADIUS servers are unreachable
  - the RADIUS request was non-compliant
  - all assessment servers are unavailable
  - the assessment server can't reach the end-system
  - no assessment servers are configured
  - the assessment server is not compatible with the current version of Extreme Access Control
  - the username and password configured in the [Assessment Server panel](#) of the Extreme Access Control options (Administration > Options > Extreme Access Control > Assessment Server) are incorrect for the assessment server.

### MAC Address

The end-system's MAC address. MAC addresses can be displayed as a full MAC address or with a MAC OUI (Organizational Unique Identifier) prefix.

**MAC OUI Vendor**

The vendor associated with the MAC OUI.

**IP Address**

The end-system's IP address.

**Switch IP**

The IP address of the switch to which the end-system is connected. If the end-system is connected to an Extreme Access Control Controller engine, this is the Extreme Access Control Controller PEP (Policy Enforcement Point) IP address.

**Switch Port**

The port alias (if defined) followed by the switch port number to which the end-system connected. If the end-system is connected to a Layer 2 Extreme Access Control Controller engine, this is the Extreme Access Control Controller PEP (Policy Enforcement Point) port. However, for Layer 3 Extreme Access Control Controller engines this column is blank.

If you add or update the port alias on the switch, you must enforce the Extreme Access Control engine in order for the new information to be displayed in the End-Systems table.

If you don't want the port alias displayed, remove the PORT\_DESCRIPTION\_FORMAT variable from the /opt/nac/server/config/config.properties file. If this variable is removed, only the switch port number is displayed.

**Username**

The username used to connect.

**Hostname**

The end-system's hostname.

**Device Family**

The hardware family or the operating system family for the end-system.

**Device Type**

The hardware type or the operating system type for the end-system.

**Authentication Type**

Identifies the latest [authentication method](#) used by the end-system to connect to the network. (For Layer 3 Extreme Access Control Controller engines, this column displays "IP.")

**Authorization**

The attributes returned by the RADIUS server for this end-system. If the end-system is connected to a switch that supports multi-authentication, then this column may not reflect the actual active policy for the authenticated user. For Layer 3 Extreme Access Control Controller engines, this column displays the policy assigned to the end-system for its authorization.

**Profile**

The name of the Extreme Access Control profile that was assigned to the end-system when it connected to the network.

**Risk**

The overall risk level assigned to the end-system based on the health result of the scan:

- Red — High Risk
- Orange — Medium Risk
- Yellow — Low Risk
- Green — No Risk
- Gray — Unknown

**Reason**

Provides additional information about the reasons why the end-system is in its particular connection state. It gives you an idea as to why a certain policy was applied to the end-system or why the end-system was rejected.

**Extended State**

Provides additional information about the end-system's connection state.

**State Description**

This column provides more details about the end-system state.

**Last Seen**

The last time the end-system was seen by the Extreme Access Control engine.

**First Seen**

The first time the end-system was seen by the Extreme Access Control engine.

**Last Scanned**

The last time an assessment (scan) was performed on the end-system.

**Last Scan Result**

The last scan result assigned to the end-system: Scan, Accept, Quarantine, Reject, Error. This is the state assigned to the end-system as a result of the last completed scan. This typically matches the end-system [State](#) if scanning is currently enabled and has been performed recently.

**Extreme Access Control Engines/Source IP**

The Extreme Access Control engine to which the end-system is connecting.

**Engine Group**

This column is only displayed if you have multiple engine groups. It displays what engine group the Extreme Access Control engine was in when the end-system event was generated. For example, if the engine was in Engine Group A when an end-system connected, but then later the engine was moved to Engine Group B, this column would still list Engine Group A for that end-system's entry.

**Switch Location**

The physical location of the switch to which the end-system connected. If the end-system is connected to an Extreme Access Control Controller engine, this is the Extreme Access Control Controller PEP (Policy Enforcement Point) location.

**All Authentication Types**

This column displays all the authentication methods the end-system has used to authenticate. The authentication types are listed in order of precedence from highest to lowest: Switch Quarantine, 802.1X, CHAP, PAP, Kerberos, MAC, CEP, RADIUS Snooping, Auto Tracking. View details about each authentication session (such as the Extreme Access Control profile that was assigned to the end-system for each authentication type) in the [End-System Events tab](#).

**RFC3580 VLAN**

For end-systems connected to RFC 3580-enabled switches, this is the RFC3580 VLAN ID assigned to the end-system.

**Score**

The total sum of the scores for all the health details that were included as part of the quarantine decision.

**Top Score**

The highest score received for a health detail in the health result.

**Actual Score**

The actual score is what the total score would be if all the health details including those marked Informational and Warning were included in the score.

**Custom 1**

Use this column to add additional information you want to display. To add or edit custom information, right-click on the table and select **Edit Custom Information**. You can add information for up to four Custom columns. The columns for Custom 2, Custom 3, and Custom 4 are hidden by default. To display these columns, click the down arrow to the right of the table header and select Columns > Column 2, Column 3, or Column 4.

**Groups**

Displays any end-system and/or user groups to which the end-system belongs.

**Zone**

Displays the [end-system zone](#) to which the end-system is assigned.

## Actions

---

**TIP:** These actions are also available from the right-click menu off an end-system entry in the table.

---

**Force Reauth**

Forces the selected end-system to re-authenticate. End-systems authenticated to a VPN device are disconnected from the VPN.

**Force Reauth and Scan**

Forces the selected end-system to re-authenticate and undergo an assessment (scan). (End-systems authenticated to a VPN device are disconnected from the VPN.) The assessment only takes place if scanning is enabled in the Extreme Access Control profile assigned to the end-system.

**Add to Group**

Lets you add the selected end-system to a specific end-system or user group. If the end-system is a registered device, it can be added to a registration group. After adding an end-system to a group, any rules created that involved that group apply to the end-system as well. Changes to end-system group membership do not require an enforce and are synchronized with engines immediately. Changes do not affect the end-system until the next authentication or assessment occurs.

**Lock MAC**

Opens the [Add MAC Lock window](#) where you can lock the MAC address of the selected end-system to a switch or switch and port.



**Show Details**

Opens the [End-System Details tab](#) where you can view summary information for the end-system selected in the table.

**Delete**

Deletes the selected end-system entries from the table and also deletes the associated end-system events. You are given the option to delete any custom information, group assignment, MAC locks, and registration and web authentication associated with the end-systems.

The Force Delete of End-System option completely deletes the end-system from Extreme Management Center, regardless of whether the end-system reauthentication is successful when the delete is executed. The option is deselected by default. When deselected, it prevents possible synchronization conditions where the authentication session remains active on the switch even though the end-system has been deleted from Extreme Management Center. These conditions can occur when there are underlying issues that prevent the end-system reauthentication from completing properly.

---

**NOTES:** The Delete operation does not remove an end-system from the Blacklist group. Blacklist is a special group that requires end-systems to be manually removed using the [Edit End-System Group window](#).

Deleting an end-system from the table also deletes the user's current authentication. If the user is connected to the network at the time of the delete, they are forced to re-authenticate.

---

## Menu Buttons

The menu at the top of the window contains most of the options available via a right-click previously mentioned in the [Actions](#) section above, as well as the End-System Events button, described below.

**End-System Events**

Opens the [End-System Events tab](#) where you can view information about events for the end-system selected in the table.

## End-System Events Tab

This tab displays historical connection information for the end-system selected in the table above. End-system events are stored daily in the database. In addition, the end-system event cache stores in memory the most recent end-

system events and displays them here in this tab. This cache allows Extreme Management Center to quickly retrieve and display end-system events without having to search through the database. You can configure parameters for the event cache (such as the number of events to display) using the [End-System Event Cache options](#) in the Extreme Access Control Options view (Administration > Options > Extreme Access Control > End-Systems Event Cache).

**NOTE:** The **End-System Events** tab displays events up to the most recent delete event for the end-system, if one exists. If you want to see events that happened prior to the most recent delete event, use the **Search for Older Events** button.

State	Time Stamp	Access Con...	Profile	IP Address	MAC Address	User Name	Host Name	Device Family	Device Type	State Descr...	Extended S...
✓	1/22/2017 4...		Default NAC...		00:1C:23:3D...		ENTERAS...	Windows	Windows Vis...	Resolving IP...	
✓	1/22/2017 4...		Default NAC...		00:1C:23:3D...		ENTERAS...	Windows	Windows Vis...	No Error	
✓	1/22/2017 4...		Default NAC...		00:1C:23:3D...		ENTERAS...	Windows	Windows Vis...	Resolving IP...	
✓	1/22/2017 4...		Default NAC...		00:1C:23:3D...		ENTERAS...	Windows	Windows Vis...	No Error	
✓	1/22/2017 4...		Default NAC...		00:1C:23:3D...		ENTERAS...	Windows	Windows Vis...	Resolving IP...	
✓	1/22/2017 4...		Default NAC...		00:1C:23:3D...		ENTERAS...	Windows	Windows Vis...	No Error	
✓	1/22/2017 4...		Default NAC...		00:1C:23:3D...		ENTERAS...	Windows	Windows Vis...	Resolving IP...	
✓	1/22/2017 4...		Default NAC...		00:1C:23:3D...		ENTERAS...	Windows	Windows Vis...	No Error	
✓	1/22/2017 4...		Default NAC...		00:1C:23:3D...		ENTERAS...	Windows	Windows Vis...	Resolving IP...	
✓	1/22/2017 4...		Default NAC...		00:1C:23:3D...		ENTERAS...	Windows	Windows Vis...	No Error	
✓	1/22/2017 4...		Default NAC...		00:1C:23:3D...		ENTERAS...	Windows	Windows Vis...	Resolving IP...	
✓	1/22/2017 4...		Default NAC...		00:1C:23:3D...		ENTERAS...	Windows	Windows Vis...	No Error	
✓	1/22/2017 4...		Default NAC...		00:1C:23:3D...		ENTERAS...	Windows	Windows Vis...	Resolving IP...	
✓	1/22/2017 4...		Default NAC...		00:1C:23:3D...		ENTERAS...	Windows	Windows Vis...	No Error	

## State

The end-system's connection state:

- Scan — The end-system was scanned.
- Accept — The end-system was granted access with either the Accept policy or the attributes returned from the RADIUS server.
- Quarantine — The end-system was quarantined because the assessment failed.
- Reject — The end-system was rejected because the assigned Extreme Access Control profile was set to Reject, the MAC Locking test failed, or the RADIUS server was reachable but rejected the authentication request.
- Disconnected — This end-system session was disconnected, however other sessions for the end-system may still be active. For example, the end-system may have a disconnected session with an authentication type of 802.1X, but

still have an active MAC authentication session. This state is only applicable for end-systems connected to switches that have RADIUS accounting enabled.

- Error — Indicates one of nine problems:
  - the MAC to IP resolution failed
  - the MAC to IP resolution timed out
  - all RADIUS servers are unreachable
  - the RADIUS request was non-compliant
  - all assessment servers are unavailable
  - the assessment server can't reach the end-system
  - no assessment servers are configured
  - the assessment server is not compatible with the current version of Extreme Management Center
  - the username and password configured in the [Assessment Server panel](#) of the Extreme Access Control options (Administration > Options > Extreme Access Control > Assessment Server) are incorrect for the assessment server

**Time Stamp**

The date and time the end-system connected.

**IP Address**

The end-system's IP address.

**Switch IP**

The IP address of the switch to which the end-system connected. If the end-system is connected to an Extreme Access Control Controller engine, this is the Extreme Access Control Controller PEP (Policy Enforcement Point) IP address.

**Switch Nickname**

The nickname defined for the switch to which the end-system is connected.

**Switch Port**

The switch port number to which the end-system is connected. If the end-system is connected to a Layer 2 Extreme Access Control Controller engine, this is the Extreme Access Control Controller PEP (Policy Enforcement Point) port. However, for Layer 3 Extreme Access Control Controller engines this column is blank.

**Username**

The username used to connect.

**Hostname**

The end-system's host name.

**Device Family**

The hardware family or the operating system family for the end-system.

**Device Type**

The hardware type or the operating system type for the end-system.

**Authentication Type**

Identifies the authentication method used by the end-system to connect to the network. For Layer 3 Extreme Access Control Controller engines, this column shows IP.

**Authorization**

The attributes returned by the RADIUS server. If the end-system is connected to a switch that supports multi-authentication, then this column may not reflect the actual active policy for the authenticated user. For Layer 3 Extreme Access Control Controller engines, this column displays the policy assigned to the end-system for its authorization.

**Profile**

The name of the Extreme Access Control profile assigned to the end-system when it connected to the network.

**Reason**

Provides additional information about the reasons why the end-system is in its particular connection state. It provides information as to the reason a policy is applied to the end-system or the reason the end-system is rejected.

**Extended State**

Provides additional information about the end-system's connection state.

**State Description**

This column provides more details about the end-system state. For example, if the end-system's connection state is Reject, this column might list the RADIUS server (primary or secondary) that rejected the authentication request.

**Switch Location**

The physical location of the switch to which the end-system is connected. If the end-system is connected to an Extreme Access Control Controller engine, this is the Extreme Access Control Controller PEP (Policy Enforcement Point) location.

**Engine Group**

This column is only displayed if you have multiple engine groups. It displays what engine group the Extreme Access Control engine is in when the end-system event was generated. For example, if the engine began in Engine Group A when an end-system connected, then the engine is moved to Engine Group B, this column still lists Engine Group A for that end-system's entry.

**Zone**

Displays the end-system zone to which the end-system is assigned. For additional information, see [End-System Zones](#).

**Search for Older Events**

This button lets you search for older events stored in the database outside of the end-system events cache. The maximum search parameters for this extended search are configured in the [End-System Event Cache options](#) in the Extreme Access Control Options view (Administration > Options > Extreme Access Control > End-System Event Cache). The search is ended when any one of the parameters is reached.

- Maximum number of results to return from search
- Maximum time to spend searching for events (in seconds)
- Maximum number of days to go back when searching

---

**Related Information**

For information on related topics:

- [Add MAC Lock Window](#)
- [End-System Details Tab](#)

## Add/Edit End-System Group

Use this window to add a new end-system group or edit an existing end-system group. End-system groups are rule components that allow you to group together devices having similar network access requirements or restrictions. You can access the Add/Edit End-System Group window from the [Manage Rule Groups window](#) or from the end-system group field in the [Create Rule window](#).

There are six system-defined end-system groups automatically populated by Extreme Management Center. The first is the Assessment Warning end-system group that includes end-systems that have assessment warnings and must acknowledge them before being granted access to the network. The second is the Blacklist end-system group that includes end-systems denied access to the network. The other four system-defined groups are populated as end-systems register through the Registration portal.

You can access the Add/Edit Location Group window by accessing the **Access Control** tab and selecting Extreme Access Control Configurations > Group Editor > End-System Groups in the left-panel menu and clicking the **Add** button in the right panel.

**NOTE:** Changes to rule components do not require an enforce. Changes are automatically synchronized with engines on the next status update. Changes do not affect end-systems until the next authentication and/or assessment occurs.

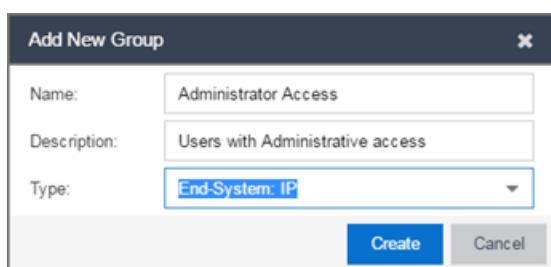

The screenshot shows a dialog box titled "Add New Group" with a close button (X) in the top right corner. It contains three input fields: "Name" with the text "Administrator Access", "Description" with the text "Users with Administrative access", and "Type" with a dropdown menu showing "End-System: IP". At the bottom of the dialog are two buttons: "Create" and "Cancel".

### Name

Enter a new name for the end-system group. You cannot edit the name of a group.

### Description

Enter a description of the end-system group. If you are using Data Center Manager (DCM), the end-system group description contains the DCM specific settings as key/value pairs.

## Type

Specify whether the end-system group be based on:

- MAC - a list of MAC addresses, MAC OUI, or MAC Masks.
- IP - a list of IP addresses or subnets.
- Hostname - a list of hostnames: exact match or wild card (for example, \*.extremenetworks.com).
- LDAP Host Group - a way to group hosts by doing an LDAP lookup on the resolved hostname of the end-system detected on the network. Note for the standard use with Active Directory, the Engine Settings > Hostname Resolution must be configured to use DNS Hostname Resolution so Extreme Management Center can resolve the Fully Qualified Domain Name. In the LDAP configuration, you must also have the "Use Fully Qualified Domain Name" checkbox selected.

Click **Create** to display the End-System Entry Editor section of the window. This section varies depending on the **Type** selected.

The screenshot shows the 'Add New Group' dialog box. The 'Name' field contains 'Administrator Access', the 'Description' field contains 'Users with Administrative access', and the 'Type' dropdown is set to 'End-System: IP'. The 'End-System Entry Editor' section features a table with two columns: 'IP Based Values' and 'Description'. The table has one row with the value '10.20.30.40'. Below the table are navigation controls including 'Page 1 of 1' and a 'Reset' button. At the bottom of the dialog are three buttons: 'Save & Close', 'Save', and 'Cancel'.

## Value

The MAC address, IP address, Hostname, or Attribute value of the end-system.

## Description

The description of the end-system group.

## Mode

For LDAP Host Groups, the mode option lets you specify whether to match any or match all of the LDAP attributes listed below. You can also use "Exists" to just check to see if a host is present in LDAP.

**Add Button**  Add...

Click the **Add** button to open the Add Entry window, from which you can add an entry to the Entry Editor section.

**Edit Button**  Edit..

Select an entry in the Entry Editor section of the window and click the **Edit** button to open the Edit Entry window, from which you can edit an existing entry.

**Delete Button**  Delete

Select an entry in the Entry Editor section of the window and click the **Delete** button to delete an existing entry.

**Save Button**

Click the **Save** button to save the location group.



Use the **Multiple MAC OUI Entries** button to open a window where you can select MAC OUI vendors.

**Filter**

Use the Filter field to filter for a specific entry based on a numeric value or text.

**Custom 1**

This column allows you to add additional information. To add or edit custom information, right-click on the table entry and select Edit Custom Information. You can add information for up to four Custom columns. The columns for Custom 2, Custom 3, and Custom 4 are hidden by default. To display these columns, click the down arrow next to the Custom 1 column header and select **Columns > Custom 2**, **Custom 3**, or **Custom 4**.

---

**Related Information**

For information on related windows:

- [Create Rule Window](#)
- [Manage Rule Groups Window](#)



## End-System Details

---

The End-System Details window provides connection state and assessment information for a single end-system. It is launched from the [End-Systems View](#) in the **Control** tab, by double-clicking any end-system in the table or selecting an end-system and then selecting **Show Details** from the Tools menu.

The End-System Details window has four tabs. The **Access Profile** tab provides end-system summary information. The **End-System** tab provides end-system connection state information. The **End-System Event** tab displays end-system event information. The **Health Results** tab displays end-system assessment result information.

This Help topic provides information on the four tabs:

- [Access Profile Tab](#)
- [End-System Tab](#)
- [End-System Events Tab](#)
- [Health Results Tab](#)

### Access Profile Tab

The **Access Profile** tab presents a graphical view of end-system and health result information, providing an at-a-glance end-system summary. Click on the information in each section to link to more detailed information.

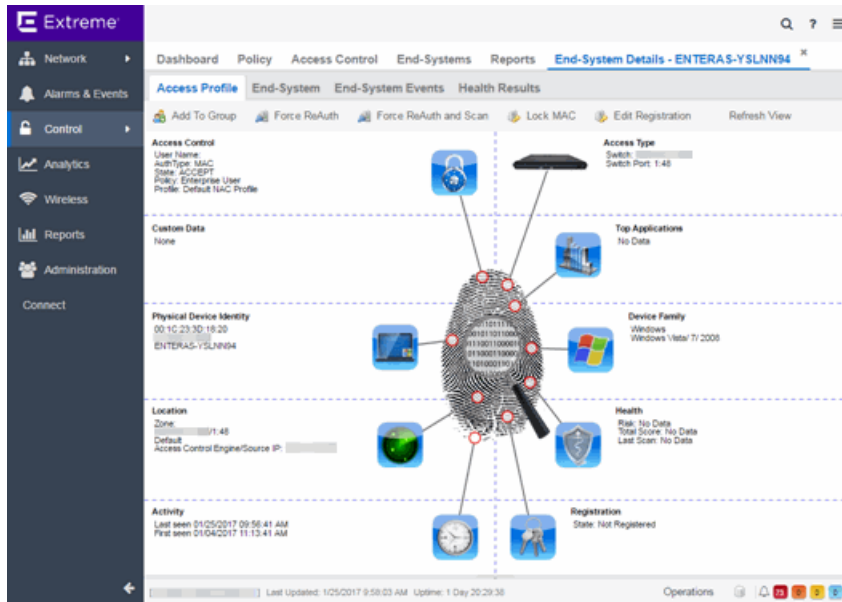

## Access Type

Displays the switch IP address, port index, and port that the end-system is connected to. Click to open a PortView for the switch in a new tab.

## Top Application Flows

Lists the top five applications and flow counts for the end-system, listed in descending order by flow count. Click to open the Applications Dashboard in a new tab.

## Device Family

Displays the end-system's operating system (OS) family (for example: Windows, Linux, Android) and OS name. Use the device family icon to quickly determine the end-system type. Click to open the **End-System** tab where you can view additional end-system details.

## Health

Displays health data from the latest scan, including risk level, total score, and last scan time. Use the health icon to quickly determine [risk level](#) by color. Click to open the **Health Results** tab where you can view additional health result information and details.

## Registration

Displays the end-system's registration state, user name, and sponsor. Click to open the **End-System** tab where you can view additional registration information.

**Activity**

Displays the [last seen](#) and [first seen](#) times for the end-system. Click to open the **End-System** tab where you can view additional end-system details.

**Location**

Displays location summary information, including end-system zone membership, access point information, engine group, and engine IP address. Click to open the **End-System** tab where you can view additional location information.

**Physical Device Identity**

Displays the end-system's MAC address, IP address, and host name. The device icon displays the end-system's physical device type with a small OS-based icon in the corner. Click to open the **End-System** tab where you can view additional end-system details.

**Virtual Device Identity**

If the end-system is a virtual machine, this section displays virtual device information, including VM name, ID, Guest Name, and manufacturer. Use the icon to quickly determine the virtual machine's operating system. If the end-system is not a virtual machine, this section is replaced by Custom Data.

**Custom Data**

Displays any custom information associated with the end-system. Custom information for an end-system is added in the [End-Systems tab](#) or End-Systems View. If the end-system is a virtual machine, this section is replaced by Virtual Device Identity.

**Identity and Access**

Displays the end-system's user name, authentication type, connection state, policy, and profile. Click to open the **End-System** tab where you can view additional end-system authentication session details.

## End-System Tab

This tab presents detailed information on the selected end-system's connection, authentication, and registration. Expand the sections using the arrow buttons to see additional information.

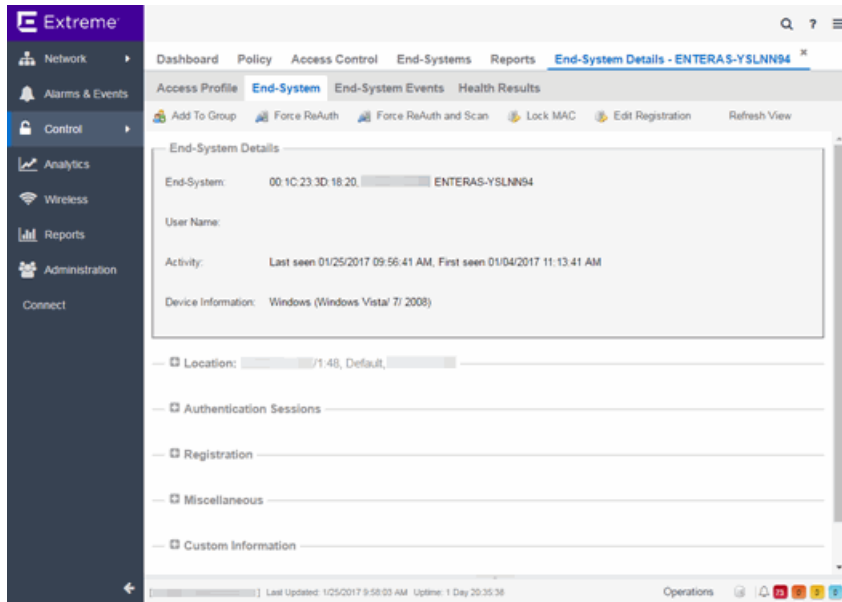

For a definition of various fields, see the End-Systems View [Column Definitions](#) section.

Changes to group membership do not require an enforce and will be synchronized with engines immediately. Changes will not affect the end-system until the next authentication or assessment occurs.

## End-System Events Tab

The End-System Events tab shows all the events for the selected end-system.

St...	Time Stamp	Access Con...	Profile	IP Address	MAC Address	User Name	Host Name	Device Family	Devic
✓	1/25/2017 8:...		Default NAC...	00:1C:23:3D...	00:1C:23:3D...		ENTERAS...	Windows	Wind
✓	1/25/2017 8:...		Default NAC...	00:1C:23:3D...	00:1C:23:3D...		ENTERAS...	Windows	Wind
✓	1/25/2017 8:...		Default NAC...	00:1C:23:3D...	00:1C:23:3D...		ENTERAS...	Windows	Wind
✓	1/25/2017 8:...		Default NAC...	00:1C:23:3D...	00:1C:23:3D...		ENTERAS...	Windows	Wind
✓	1/25/2017 8:...		Default NAC...	00:1C:23:3D...	00:1C:23:3D...		ENTERAS...	Windows	Wind
✓	1/25/2017 8:...		Default NAC...	00:1C:23:3D...	00:1C:23:3D...		ENTERAS...	Windows	Wind
✓	1/25/2017 8:...		Default NAC...	00:1C:23:3D...	00:1C:23:3D...		ENTERAS...	Windows	Wind
✓	1/25/2017 8:...		Default NAC...	00:1C:23:3D...	00:1C:23:3D...		ENTERAS...	Windows	Wind
✓	1/25/2017 8:...		Default NAC...	00:1C:23:3D...	00:1C:23:3D...		ENTERAS...	Windows	Wind
✓	1/25/2017 8:...		Default NAC...	00:1C:23:3D...	00:1C:23:3D...		ENTERAS...	Windows	Wind
✓	1/25/2017 8:...		Default NAC...	00:1C:23:3D...	00:1C:23:3D...		ENTERAS...	Windows	Wind
✓	1/25/2017 8:...		Default NAC...	00:1C:23:3D...	00:1C:23:3D...		ENTERAS...	Windows	Wind
✓	1/25/2017 8:...		Default NAC...	00:1C:23:3D...	00:1C:23:3D...		ENTERAS...	Windows	Wind
✓	1/25/2017 8:...		Default NAC...	00:1C:23:3D...	00:1C:23:3D...		ENTERAS...	Windows	Wind
✓	1/25/2017 8:...		Default NAC...	00:1C:23:3D...	00:1C:23:3D...		ENTERAS...	Windows	Wind

You can manipulate the table data in this window in several ways to customize the view for your own needs:

- Click on the column headings to perform an ascending or descending sort on the column data.
- Hide or display different columns by clicking on a column heading and selecting the column options from the menu.
- Rearrange columns by dragging a column heading to the desired position.
- Filter the data in each column in the table.

You can use the Search for Older Events to search for older events stored in the database outside of the end-system events cache. The maximum search parameters for this extended search are configured in the [End-System Event Cache options](#) in the Identity and Access Options view (Tools > Options). The search is ended when any one of the parameters is reached:

- Maximum number of results to return from search
- Maximum time to spend searching for events (in seconds)
- Maximum number of days to go back when searching

## Health Results Tab

The top table in the **Health Results** tab provides summary information on scan results obtained for the selected end-system. The bottom table presents the individual health result details for the scan selected in the top table. Double-click any row in the bottom table to open the Health Result Details window and view a description, solution, and result for the health result. Information is displayed in this tab only if assessment is enabled on the network and there are health results in the database.

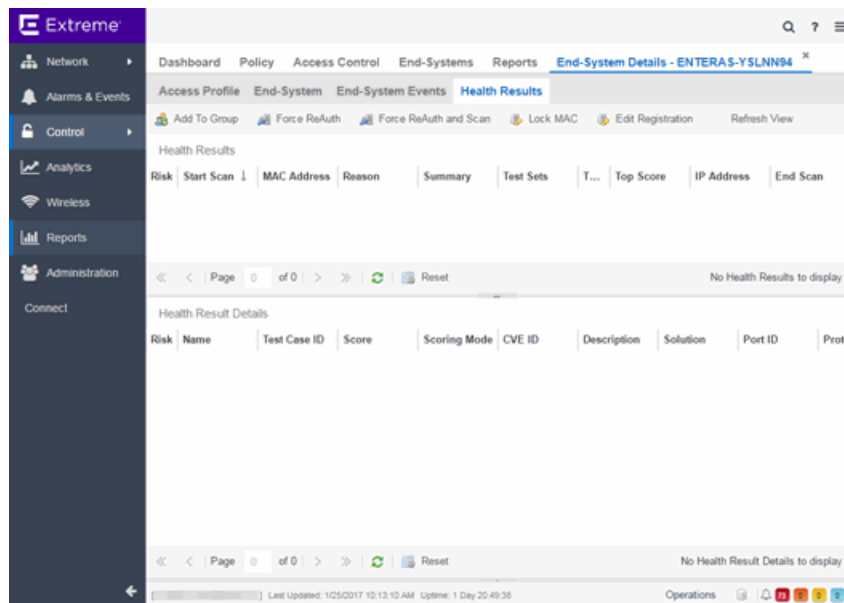

## Health Results

This table presents health results for all the scans performed on the end-system.

### Risk

The overall risk level assigned to the end-system based on the health result of the scan:

- Red - High Risk
- Orange - Medium Risk
- Yellow - Low Risk
- Green - No Risk
- Gray - Unknown

**Start Scan**

The date and time the scan started.

**MAC Address**

The end-system's MAC address.

**Reason**

The reason the health result was placed into the specified risk level. This is based on the risk level configuration that was used for the assessment, for example, if there was one or more health result detail with a score greater than 7. If the end-system is NAP capable, then this is based on the values returned from NAP.

**Summary**

A list of all the test cases that were run against the device during assessment. The test case name will be listed, or if that is not available, the test case ID will be listed.

**Test Sets**

The list of test sets that were run during assessment, for example, Default Nessus, Default Agent-less, and Default Agent-based. Test sets are defined as part of the assessment configuration. If the end-system is NAP capable, then this column displays Microsoft NAP indicating that NAP performed the assessment.

**Total Score**

The total sum of the scores for all the health details that were included as part of the quarantine decision, followed by the actual score in parenthesis. The actual score is what the total score would be if all the health details were included as part of the quarantine decision. It includes all scores, including those marked Informational and Warning. If the total score and the actual score are the same, only one score is shown.

**Top Score**

The highest score received for a health detail that was included as part of the quarantine decision. Scores that are marked as Informational or Warning are not considered.

**IP Address**

The end-system's IP address.

**End Scan**

The date and time the scan ended.

**Server Name**

The name of the assessment server. For on-board assessment servers, the name is determined by the name of the Extreme Access Control engine. For example, if you create an Extreme Access Control engine and name it MyAccessControlengine, then the on-board assessment server name will be listed as MyAccessControlengine as well.

**Server IP**

The IP address of the assessment server. For on-board assessment servers, the IP address is determined by the address of the Extreme Access Control engine. For example, if you create an Extreme Access Control engine with an IP address of 10.20.80.8, then the on-board assessment server IP address is listed as 10.20.80.8 as well.

**Server Port**

The port number on the assessment server to which the Extreme Access Control engine sends assessment requests.

**Host Unreachable**

Displays whether the end-system was unreachable and could not be scanned: Yes or No.

**Warning Count**

The total number of health result details that are marked as Warnings.

## Health Result Details

This table displays the individual health result details for the scan selected in the top table. Double-click any health result detail to open the Health Result Details window that displays a description, solution, and result for the health result.

**Risk**

The risk level assigned to the problem found on the port:

- Red - High (corresponds to a Hole)
- Orange - Medium (corresponds to a Warning)
- Yellow - Low (corresponds to a Note)
- Black - No Result Available

**Name**

This column lists the name of the test that is reported by the health result detail.



**Test Case ID**

The unique number assigned to the test case.

**Score**

The score assigned to the test case. The score is a value between 0.0 and 10.0. In the case of agent-based test cases, the score will be either 0.0 for a passed test, or 10.0 for a failed test, unless specifically overwritten by the scoring override configuration.

**Scoring Mode**

The scoring mode that was used at the time the test was performed.

- Applied - The score returned by this test was included as part of the quarantine decision.
- Informational - The score returned by this test was reported, but did not apply toward a quarantine decision.
- Warning - The score returned by this test was only used to provide end user assessment warnings via the Notification portal web page.

**CVE ID**

The CVE (Common Vulnerability and Exposures) ID assigned to the security vulnerability or exposure. For more information on CVE IDs, refer to the following URL: <http://www.cve.mitre.org/>.

**Description**

This column lists information about the health result detail.

**Solution**

A solution for the problem found in the health result detail.

**Port ID**

The port on the end-system that the security risk was detected on.

**Protocol ID**

The well-known number (ID) assigned to the IP Protocol Type.

**Value**

What this specific test case is testing or checking for on the end-system.

**Assessment Type**

The type of assessment server used in the test set.

## Remediation Success

For agent-based assessment, this column lists the results of remediation attempts: Remediation Successful, Remediation Failed, or Not Applicable.

## Type

A "type" is assigned to each security risk found on a port during an assessment, and is used to determine whether to Quarantine an end-system. Types are configurable on the assessment agent. There are three types:

- Hole - The port is vulnerable to attack.
- Warning - The port may be vulnerable to attack.
- Note - There may be a security risk on the port.

## Buttons and Paging Toolbar

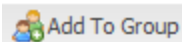

Lets you add the selected end-system to a specific end-system or user group. After adding an end-system to a group, any rules that have been created that involved that group will now apply to the end-system as well. Changes to end-system group membership do not require an enforce and will be synchronized with engines immediately. Changes will not affect the end-system until the next authentication or assessment occurs.



Forces the selected end-system to re-authenticate.



Opens the [Add MAC Lock window](#) where you can lock the MAC address of the selected end-system to a switch or switch and port.

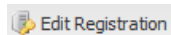

Opens a window where you can edit the expiration time and maximum registered device count for the end user.



Refreshes the page.



The Health Result tables are presented in pages. The paging toolbar provides four buttons that let you easily page through the table: first, previous, next, and last page.

It also displays an indicator of the current and total number of pages. Enter a page number in the Page field and press Enter to quickly move to that page.



Clears the search field and search results, clears all filters, and refreshes the table.

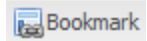

Use the bookmark button to save the search, sort, and filtering options you have currently set. It opens a new window for the current report with a link that can be bookmarked in your browser. You can then use the bookmark whenever you want the same search, sort, and filtering options.

---

## Related Information

For information on related tabs:

- [End-Systems Tab](#)

## Add/Edit Location Group

Use this window to add a new location group or edit an existing location group. Location Groups are rule components that allow you to specify network access requirements or restrictions based on the network location where the end-user is connecting. For example, in an enterprise environment, an engineer logging on to the network from the corporate cafeteria could receive different network access than an engineer logging on from the engineering development area.

You can access the Add/Edit Location Group window by accessing the **Extreme Access Control** tab and selecting Extreme Access Control Configurations > Group Editor > Location Groups in the left-panel menu and clicking the **Add** button in the right panel.

**NOTE:** Changes to rule components do not require an enforce. Changes are automatically synchronized with engines on the next status update. Changes do not affect end-systems until the next authentication and/or assessment occurs.

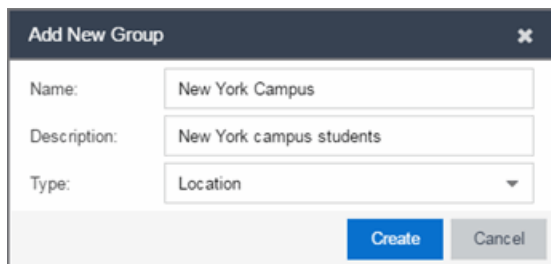

The screenshot shows a dialog box titled "Add New Group" with a close button (X) in the top right corner. It contains three input fields: "Name" with the text "New York Campus", "Description" with the text "New York campus students", and "Type" with a dropdown menu showing "Location". At the bottom right, there are two buttons: "Create" (highlighted in blue) and "Cancel".

### Name

Enter a name for a new location group. You cannot edit the name of a group.

### Description

Enter a description of the location group.

### Type

Select **Location** to create a Location group.

Click **Create** to display the Entry Editor section of the window. This section varies depending on the **Type** selected.

The screenshot shows a software window titled "Add New Group". It has a dark header bar with a close button. The main area contains three text input fields: "Name" (containing "New York Campus"), "Description" (containing "New York campus students"), and "Type" (containing "Location"). Below these is a section titled "Location Entry Editor". This section has a toolbar with icons for "Add...", "Edit...", "Delete", and "Show Filters". Underneath is a table with four columns: "Switch", "Port/SSID", "AP ID", and "Description". The table is currently empty. Below the table is a paging toolbar showing "Page 0 of 0", a "Reset" button, and the text "No entry to display". At the bottom of the window are three buttons: "Save & Close" (highlighted in blue), "Save", and "Cancel".

### Switch

The IP address of the switches added to the location.

### Port/SSID

The port or port range for a wired switch or the SSIDs for a wireless switch.

### AP ID

The access point identifiers for a wireless switch.

### Description

The description of the location group.

### Add Button Add...

Click the **Add** button to open the Add Entry window, from which you can add an entry to the Entry Editor section.

### Edit Button Edit..

Select an entry in the Entry Editor section of the window and click the **Edit** button to open the Edit Entry window, from which you can edit an existing entry.

### Delete Button Delete

Select an entry in the Entry Editor section of the window and click the **Delete** button to delete an existing entry.

### Save Button

Click the **Save** button to save the location group.

---

## Related Information

For information on related windows:

- [Create Rule Window](#)
- [Manage Rule Groups Window](#)

## Add/Edit User Group

Use this window to add a new user group or edit an existing user group. User groups are rule components that allow you to group together end users having similar network access requirements or restrictions. You can access the Add/Edit User Group window from the [Manage Rule Groups window](#) or from the user group field in the [Create Rule window](#).

**NOTE:** Changes to rule components do not require an enforce. Changes are automatically synchronized with engines on the next status update. Changes do not affect end-systems until the next authentication and/or assessment occurs.

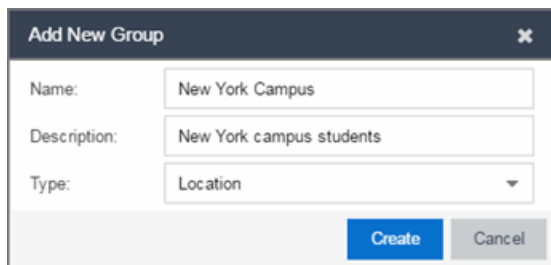

### Name

Enter a name for a new user group. You cannot edit the name of a group.

### Description

Enter a description of the user group.

### Type

Select **User** to create an end-system group. Specify whether the user group is based on:

- Username — a list of usernames which can be based on an exact match or a wild card.
- LDAP User Group — a list imported from an LDAP Server, organized by Organization Unit (OU), or a custom attribute lookup for any user or MAC address if they match a AAA configuration entry that assigns the request a valid LDAP Configuration.
- RADIUS User Group — a list of attributes returned by the RADIUS server.

Click **Create** to display the Entry Editor section of the window. This section varies depending on the **Type** selected.

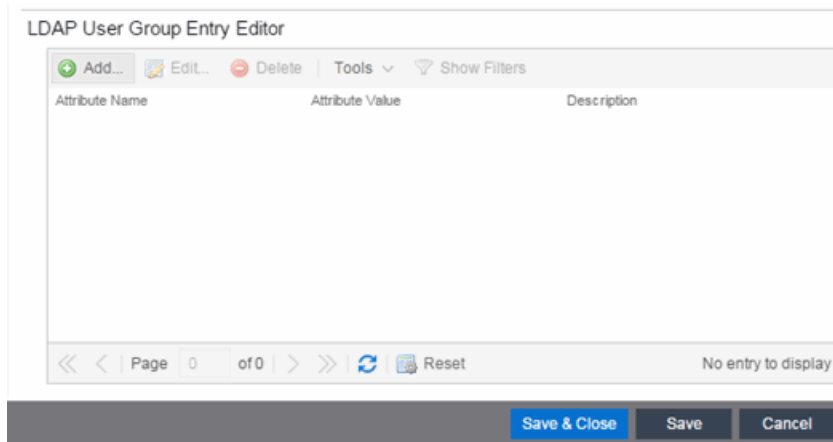

### Match Mode

For LDAP and RADIUS user groups, the **Match Mode** option lets you select whether to match any or match all of the LDAP or RADIUS User Group entries (attribute names) listed below.

For LDAP User Groups, you can also select **Exists**, as the username can be used to verify this criteria after the initial authentication (i.e., using Registration). The **Exists** mode is not available for RADIUS User Groups because they cannot be verified after an initial registration as the user credentials are not stored on the Extreme Access Control engine for re-verification.

### Attribute Name

The name of the LDAP or RADIUS Attribute.

### Value

The Attribute value of the user group or username.

### Add Button Add...

Click the **Add** button to open the Add Entry window, from which you can add an entry to the Entry Editor section.

### Edit Button Edit..

Select an entry in the Entry Editor section of the window and click the **Edit** button to open the Edit Entry window, from which you can edit an existing entry.

### Delete Button Delete

Select an entry in the Entry Editor section of the window and click the **Delete** button to delete an existing entry.



**Tools**

Use the **Tools** menu button to either open a window where you can select a file for importing usernames (if you are creating username entries) or open a window where you can configure an LDAP OU import (if you are creating an LDAP user group).

**Filter**

Use the Filter field to filter for a specific entry based on a numeric value or text.

---

**Related Information**

For information on related windows:

- [Create Rule Window](#)
- [Manage Rule Groups Window](#)

## Add/Edit User Group Window

Use this Extreme Access Control window to add a new user group or edit an existing user group. User groups are rule components that allow you to group together end-users having similar network access requirements or restrictions. You can access the Add/Edit User Group window from the [Group Editor](#) or from the user group field in the [Add Rule window](#).

**NOTE:** Changes to rule components do not require an enforce. Changes automatically synchronize with the engines on the next status update. Changes do not affect end-systems until the next authentication and/or assessment occurs.

The screenshot shows the 'Add/Edit User Group' window for a group named 'DEVLAB Users'. The 'Name' field is 'DEVLAB Users', the 'Description' is 'Users from the DEVLAB Windows domain.', the 'Type' is 'User: Username', and the 'Match Mode' is 'Any'. Below these fields is a 'Username Entry Editor' window. This editor has a toolbar with 'Add...', 'Edit...', 'Delete', and 'Show Filters' buttons. It displays a table with one entry: 'Value' is '\*@devlab.com' and 'Description' is empty. At the bottom of the editor, there are navigation arrows, 'Page 1 of 1', a 'Reset' button, and the text 'Displaying entry 1 - 1 of 1'. The main window has 'Save' and 'Cancel' buttons at the bottom right.

### Name

Enter a name for a new user group. You cannot edit the name of a group.

### Description

Enter a description of the user group.

### Type

Specify the criteria on which the user group is based:

- Username - a list of usernames which can be based on an exact match or a wild card.
- LDAP User Group - a list imported from an LDAP Server, organized by Organization Unit (OU), or a custom attribute lookup for any user or MAC

address if they match a AAA configuration entry that assigns the request a valid LDAP Configuration.

- RADIUS User Group - a list of attributes returned by the RADIUS server.

### **Match Mode**

For LDAP and RADIUS user groups, the Match Mode option lets you select whether to match any or match all of the LDAP or RADIUS User Group entries (attribute names) listed below.

For LDAP User Groups, you can also select "Exists", since the username can be used to verify this criteria after the initial authentication (i.e., using Registration). The "Exists" mode is not available for RADIUS User Groups because they cannot be verified after an initial registration as the user credentials are not stored on the Extreme Access Control engine for re-verification.

### **Username Entry Editor**

Use the buttons to add, edit, or delete entries in the group. Usernames can be an exact match or use wildcards.

### **Filter**

Use the Filter field to filter for a specific entry based on a numeric value or text.

---

## **Related Information**

For information on related windows:

- [Add/Edit Rule Window](#)
- [Group Editor](#)

## Switches

---

This tab provides information about the switches assigned to an Extreme Access Control Gateway engine or Extreme Access Control Engine Group. To access this tab, select a gateway or engine group in the left-panel tree, then click the **Switches** tab in the right panel.

You can right-click on one or more switch for a menu of options.

If you are using the **Policy** tab, you can also right-click on one or more switch and select from the options in the Policy menu.

Use the table options and tools to filter, sort, and customize table settings. You can access the options by clicking the down arrow in the right corner of any column header.

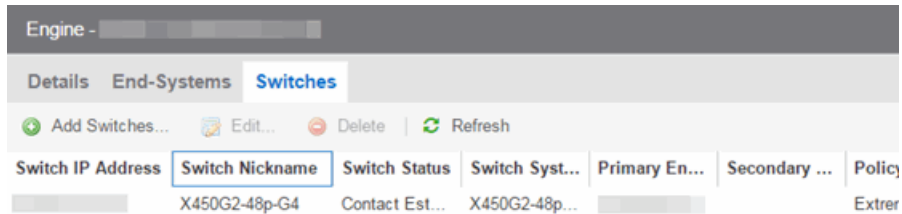

### Switch IP Address

The switch's IP address.

### Switch Nickname

The nickname assigned to the switch when it is added to the Extreme Management Center database.

### Switch Status

The current operational status of the switch, based on the Extreme Management Center device poll. If the device poll did not update the status of a switch, and a Verify RADIUS Configuration operation is performed on that switch, the switch status in the **Switches** tab may differ from the switch status in the Verify RADIUS Configuration window.

### Switch System Name

The assigned name of the device as stored in the device's sysName MIB object.

### Primary Gateway

The name and IP address of the switch's primary Extreme Access Control Gateway. If load balancing has been configured for the engine group, the Extreme Management Center server determines the primary and secondary gateways at Enforce, and this field displays "Determined by Load Balancer."

### Secondary Gateway

The name and IP address of the switch's secondary Extreme Access Control Gateway. If load balancing has been configured for the engine group, the Extreme Management Center server determines the primary and secondary gateways at Enforce, and this field displays "Determined by Load Balancer."

### Policy/VLAN

The RADIUS attributes included as part of the RADIUS response.

**Policy Domain**

The Policy Manager domain the switch is assigned to (if any). You can populate this field by right-clicking on a switch and selecting Policy > Verify Domain. This information does not automatically update if there are domain assignment changes. You need to re-select the menu option to update the domain information.

**Auth Access Type**

The type of authentication access allowed for this switch:

- **Any access** — the switch can authenticate users originating from any access type.
- **Management access** — the switch can only authenticate users that have requested management access via the console, Telnet, SSH, or HTTP, etc.
- **Network access** — the switch can only authenticate users accessing the network via the following authentication types: MAC, PAP, CHAP, and 802.1X. If RADIUS accounting is enabled, then the switch also monitors Auto Tracking, CEP (Convergence End Point), and Switch Quarantine sessions.
- **Monitoring - RADIUS Accounting** — the switch monitors Auto Tracking, CEP (Convergence End Point), and Switch Quarantine sessions. Extreme Access Control learns about these session via RADIUS accounting. This allows Extreme Access Control to be in a listen mode, and to display access control, location information, and identity information for end-systems without enabling authentication on the switch.
- **Manual RADIUS Configuration** — RADIUS configuration was performed manually on the switch using Policy Manager or CLI.

**Switch Type**

Specifies the switch type: a switch that authenticates layer 2 traffic via RADIUS to an out-of-band Extreme Access Control gateway, or a VPN concentrator being used in an [Extreme Access Control VPN deployment](#).

**Switch Location**

The physical location of the switch.

**Switch Contact**

The person responsible for the switch.

**Switch Description**

A description of the switch, which may include its manufacturer, model number, and firmware revision number.

**Management RADIUS Servers**

RADIUS servers used to authenticate requests for administrative access to the switch.

**RADIUS Accounting**

Displays whether RADIUS accounting is enabled or disabled on the switch. RADIUS accounting can be used to determine the connection state of the end-system sessions on the Extreme Access Control engine, providing real-time connection status in Extreme Management Center. RADIUS accounting is also used to monitor switches for Auto Tracking, CEP (Convergence End Point), and Switch Quarantine authentication sessions, when used in conjunction with the Monitoring or Network Access switch authentication access types. For more information, see the [Auth. Access Type](#) section of the Add/Edit Switch Window Help topics.

**IP Subnet for IP Resolution**

Displays the IP subnet that the switch is using as an inclusive list for MAC to IP resolution. Specifying an IP subnet in a static IP network allows for a router to be used for IP resolution in cases where it would not be discovered via DHCP. IP Subnets also contain an IP range which can be used to filter out secondary IP addresses that are not valid for the network.

**Policy Enforcement Points**

If the switch is a VPN device (see Switch Type column), this column displays the Policy Enforcement Points that are being used to provide authorization for the connecting end-systems.

**Add Switch**

Opens the [Add Switches to Extreme Access Control Engine Group window](#) where you can select switches to add to the engine or engine group.

**Edit**

Select a switch and click this button to open the [Edit Switches in Extreme Access Control Engine Group window](#) where you can change the switch's primary and secondary Extreme Access Control Gateway (Gateway), and also edit other switch attributes, if desired.

**Delete**

Select a switch and click this button to delete the switch from Extreme Management Center's device database. The switch's primary gateway enforces its own primary RADIUS server as both the primary and secondary RADIUS servers on the switch.

---

## Related Information

For information on related windows:

- [Add Switches to an Extreme Access Control Engine Group Window](#)
- [Edit Switches in Extreme Access Control Engine Group Window](#)

---

## Edit Switches in Extreme Access Control Engine Group

Use this window to change a switch's primary and secondary Extreme Access Control Gateway, and also edit other switch parameters including the switch's authentication access type and the RADIUS attributes to send, if desired.

You can access this window by selecting an engine or engine group in the left-panel tree. Then, in the right-panel [Switches tab](#), select the switches you wish to edit and click the **Edit** button.

The screenshot shows a window titled "Edit Device:" with a close button (X) in the top right corner. The window contains the following configuration options:

- Switch Type: Layer 2 Out-Of-Band
- Primary Engine: [Empty]
- Secondary Engine: None
- Auth. Access Type: Network Access
- Virtual Router Name: VR-Default
- RADIUS Attributes to Send: Extreme Policy
- RADIUS Accounting: Disabled
- Management RADIUS Server 1: None
- Management RADIUS Server 2: None
- Network RADIUS Server: None
- Policy Domain: Default Policy Domain

At the bottom of the window, there is a button labeled "Advanced Settings..." and two buttons labeled "Save" and "Close".

### Switch Type

Use the drop-down list to change the type of switch:

- **Layer 2 Out-Of-Band** — A switch that will do authentication on layer 2 traffic via RADIUS to an out-of-band Extreme Access Control gateway.

- **Layer 2 Out-Of-Band Data Center** — A switch within a data center where virtualization and mobility are a factor. If an end-system changes location but does not move to a different Extreme Access Control engine, Extreme Management Center removes the end-system authentication from their prior port/switch. This allows VMs that quickly move from one server to another and then back again to still have their location updated in Extreme Management Center, because only one authenticated session is allowed per end-system within Extreme Management Center.
- **Layer 2 RADIUS Only** — In this mode, Extreme Access Control does not require any information from the switch other than the end-system MAC address (from Calling-Station-Id or User-Name). The NAS-Port does not need to be specified. If the switch supports RFC 3576, you can set the Reauthentication Behavior in the Advanced Switch Settings window. IP resolution and reauthentication may not work in this mode.
- **VPN** — A VPN concentrator being used in an [Extreme Access Control VPN deployment](#). In this case, you should specify one or more Policy Enforcement Points below. If you do not specify a Policy Enforcement Point, then Extreme Access Control is unable to apply policies to restrict access after the user is granted access.

**Primary Gateway**

Use the drop-down menu to select the primary Extreme Access Control Gateway for the selected switches. If load balancing has been configured for the switch, this field is not displayed.

**Secondary Gateway**

Use the drop-down menu to select the secondary Extreme Access Control Gateway for the selected switches. If load balancing has been configured for the switch, this field is not displayed.

**Auth Access Type**

Use the drop-down menu to select the type of authentication access allowed for these switches. This feature allows you to have one set of switches for authenticating management access requests and a different set for authenticating network access requests.



**WARNING:** For ExtremeXOS devices only. Extreme Access Control uses CLI access to perform configuration operations on ExtremeXOS devices.

- Enabling an Auth type of "Any Access" or "Management Access" can restrict access to the switch after an enforce is performed. For management requests handled through Extreme Access Control, make sure that an appropriate administrative access configuration is in place by assigning a profile such as "Administrator Extreme Access Control Profile" to grant proper access to users. Also, verify that the current switch CLI credentials for the admin user are defined in the database against which Extreme Access Control authenticates management login attempts.
  - Switching from an Auth type of "Any Access" or "Management Access" back to "Network Access" can restrict access to the switch after an enforce is performed. Verify that the current switch CLI credentials for the admin user are defined locally on the switch.
- 
- **Any Access** — the switch can authenticate users originating from any access type.
  - **Management Access** — the switch can only authenticate users that have requested management access via the console, Telnet, SSH, or HTTP, etc.
  - **Network Access** - the switch can only authenticate users accessing the network via the following authentication types: MAC, PAP, CHAP, and 802.1X. If RADIUS accounting is enabled, then the switch also monitors Auto Tracking, CEP (Convergence End Point), and Switch Quarantine sessions. If there are multiple sessions for a single end-system, the session with the highest precedence will be displayed to provide the most accurate access control information for the user. The Extreme Access Control authentication type precedence from highest to lowest is: Switch Quarantine, 802.1X, CHAP, PAP, Kerberos, MAC, CEP, RADIUS Snooping, Auto Tracking.
  - **Monitoring - RADIUS Accounting** — the switch will monitor Auto Tracking, CEP (Convergence End Point), and Switch Quarantine sessions. Extreme Management Center learns about these session via RADIUS accounting. This allows Extreme Management Center to be in a listen mode, and to display access control, location information, and identity information for end-systems without enabling authentication on the switch. If there are multiple sessions for a single end-system, the session with the highest precedence displays to provide the most accurate access control information for the user. The

Extreme Access Control authentication type precedence from highest to lowest is: Switch Quarantine, 802.1X, CHAP, PAP, Kerberos, MAC, CEP, RADIUS Snooping, Auto Tracking.

- **Manual RADIUS Configuration** — Extreme Management Center does not perform any RADIUS configurations on the switch. Select this option if you want to configure the switch manually using the **Policy** tab or CLI.

### **Virtual Router Name**

Select the checkbox to enter the name of the Virtual Router. The default value for this field is **VR-Default**.

---

**WARNING:** For ExtremeXOS devices only. If Extreme Management Center has not detected and populated this field, enter the Virtual Router Name carefully. Incorrectly entering a value in this field causes the RADIUS configuration to fail, which is not reported when enforcing the configuration to the switch.

---

### **Gateway RADIUS Attributes to Send**

Use the drop-down menu to select the RADIUS attributes settings included as part of the RADIUS response from the Extreme Access Control engine to the switch.

### **RADIUS Accounting**

Use the drop-down menu to enable RADIUS accounting on the switch. RADIUS accounting can be used to determine the connection state of the end-system sessions on the Extreme Access Control engine, providing real-time connection status in Extreme Management Center. It also allows Extreme Access Control to monitor Auto Tracking, CEP (Convergence End Point), and Quarantine (anti-spoofing) sessions.

### **Management RADIUS Server**

Use the drop-down menu to specify RADIUS servers used to authenticate requests for administrative access to the selected switches. Select from the RADIUS servers you have configured in Extreme Management Center, or select **New** or **Manage** to open the Add/Edit RADIUS Server or Manage RADIUS Servers windows.

### **Network RADIUS Server**

This option lets you specify a backup RADIUS server to use for network authentication requests for the selected switches. This allows you to explicitly configure a network RADIUS server to use if there is only one Extreme Access Control engine. (This option is only available if a Secondary Gateway is not specified.) Select from the RADIUS servers you have configured in Extreme Control,

or select **New** or **Manage** to open the Add/Edit RADIUS Server or Manage RADIUS Servers windows.

### Policy Domain

Use this option to assign the switch to a **Policy** tab domain and enforce the domain configuration to the switch. The switch must be an Extreme Networks switch.

---

**NOTE:** Selecting -- **Do Not Set** -- for an Extreme Access Control engine on which a Policy Domain is configured does not unassign the Policy Domain. To unassign a Policy Domain, use the [Policy tab](#).

---

### Advanced Settings

Select this button to open the [Advanced Switch Settings window](#).

---

### Related Information

For information on related windows:

- [Switches Tab](#)
- [Add Switches to an Engine Group Window](#)
- [Advanced Switch Settings Window](#)

## Add Switches to Extreme Access Control Engine Group

---

Use this window to select switches to add to a gateway engine or engine group. The window allows you to select one or more switches from the device tree, and set the primary and secondary Extreme Access Control Gateways for the switches. It also lets you set other parameters including the authentication access type for the switches and the RADIUS attributes to send.

---

**NOTE:** If desired, you can set only the primary Extreme Access Control Gateway for the switches; Extreme Management Center does not require the secondary Extreme Access Control Gateway to be set. If only the primary Extreme Access Control Gateway is set, then by default that gateway uses its primary proxy RADIUS server as a secondary direct RADIUS server to the switch. This allows for redundancy without the requirement for a secondary Extreme Access Control Gateway. In this scenario, if contact with the Extreme Access Control Gateway fails, authentication traffic would bypass the Extreme Access Control gateway, but normal authentication would continue in the network, and still provide some security.

---

1. Access the **Control > Access Control** tab.
2. Select an engine or engine group from the left-panel
3. Click the **Add Switch** button in the right-panel [Switches tab](#).

## Device Tree

This area displays the device tree. Expand the tree and select the switches you want to add to the engine or engine group.

## Add Device

Opens the Add Device window where you can add a device to the Extreme Management Center database. The device is displayed in the My Network folder in the device tree.

## Switch Type

Use the drop-down menu to select the type of switch you are adding:

- **Layer 2 Out-Of-Band** — A switch that authenticates on layer 2 traffic via RADIUS to an out-of-band Extreme Access Control gateway.
- **Layer 2 Out-Of-Band Data Center** — A switch within a data center where virtualization and mobility are a factor. If an end-system changes location but does not move to a different Extreme Access Control engine, Extreme Access Control removes the end-system authentication from their prior port/switch. This allows VMs that quickly move from one server to another and then back

again to still have their location updated in Extreme Management Center, because only one authenticated session is allowed per end-system in Extreme Management Center.

- **Layer 2 RADIUS Only** — In this mode, Extreme Management Center does not require any information from the switch other than the end-system MAC address (from Calling-Station-Id or User-Name). The NAS-Port does not need to be specified. If the switch supports RFC 3576, you can set the Reauthentication Behavior in the [Advanced Switch Settings window](#). IP resolution and reauthentication may not work in this mode.
- **VPN** - A VPN concentrator being used in an [Extreme Access Control VPN deployment](#). In this case, you should specify one or more Policy Enforcement Points below. If you do not specify a Policy Enforcement Point, then Extreme Management Center is unable to apply policies to restrict access after the user is granted access.

### **Primary Gateway**

Use the drop-down menu to select the primary Extreme Access Control Gateway for the selected switches. If load balancing has been configured for the engine group, the Extreme Management Center server determines the primary and secondary gateways at Enforce, and this field displays **Determined by Load Balancer**.

### **Secondary Gateway**

Use the drop-down menu to select the secondary Extreme Access Control Gateway for the selected switches. If load balancing has been configured for the engine group, the Extreme Management Center server determines the primary and secondary gateways at Enforce, and this field displays **Determined by Load Balancer**.

---

**NOTE:** To configure additional redundant Extreme Access Control Gateways per switch (up to four), use the Display Counts option in the [Display options panel](#) (Administration > Options > Extreme Access Control).

---

### **Auth. Access Type**

Use the drop-down menu to select the type of authentication access allowed for these switches. This feature allows you to have one set of switches for authenticating management access requests and a different set for authenticating network access requests.

**WARNING:** For ExtremeXOS devices only. Extreme Access Control uses CLI access to perform configuration operations on ExtremeXOS devices.

- Enabling an Auth type of "Any Access" or "Management Access" can restrict access to the switch after an enforce is performed. Make sure that an appropriate administrative access configuration is in place by assigning a profile such as "Administrator Extreme Access Control Profile" to grant proper access to users. Also, verify that the current switch CLI credentials for the admin user are defined in the database that Extreme Management Center authenticates management login attempts against.
  - Switching from an Auth type of "Any Access" or "Management Access" back to "Network Access" can restrict access to the switch after an enforce is performed. Verify that the current switch CLI credentials for the admin user are defined locally on the switch.
- 
- **Any Access** - the switch can authenticate users originating from any access type.
  - **Management Access** - the switch can only authenticate users that have requested management access via the console, Telnet, SSH, or HTTP, etc.
  - **Network Access** - the switch can only authenticate users that are accessing the network via the following authentication types: MAC, PAP, CHAP, and 802.1X. If RADIUS accounting is enabled, then the switch also monitors Auto Tracking, CEP (Convergence End Point), and Switch Quarantine sessions. If there are multiple sessions for a single end-system, the session with the highest precedence displays to provide the most accurate access control information for the user. The Extreme Access Control authentication type precedence from highest to lowest is: Switch Quarantine, 802.1X, CHAP, PAP, Kerberos, MAC, CEP, RADIUS Snooping, Auto Tracking.
  - **Monitoring - RADIUS Accounting** - the switch monitors Auto Tracking, CEP (Convergence End Point), and Switch Quarantine sessions. Extreme Management Center learns about these session via RADIUS accounting. This allows Extreme Management Center to be in a listen mode, and to display access control, location information, and identity information for end-systems without enabling authentication on the switch. If there are multiple sessions for a single end-system, the session with the highest precedence displays to provide the most accurate access control information for the user. The Extreme Access Control authentication type precedence from highest to

lowest is: Switch Quarantine, 802.1X, CHAP, PAP, Kerberos, MAC, CEP, RADIUS Snooping, Auto Tracking.

- **Manual RADIUS Configuration** - Extreme Management Center does not perform any RADIUS configurations on the switch. Select this option if you want to configure the switch manually using the **Policy** tab or CLI.

### **Virtual Router Name**

Enter the name of the Virtual Router. The default value for this field is **VR-Default**.

---

**WARNING:** For ExtremeXOS devices only. If Extreme Management Center has not detected and populated this field, enter the Virtual Router Name carefully. Incorrectly entering a value in this field causes the RADIUS configuration to fail, which is not reported when enforcing the configuration to the switch.

---

### **Gateway RADIUS Attributes to Send**

Use the drop-down menu to select the RADIUS attributes included as part of the RADIUS response from the Extreme Access Control engine to the switch. You can also select **New** or **Manage** from the menu to open the RADIUS Attribute Settings window where you can define, edit, or delete the available attributes.

### **RADIUS Accounting**

Use the drop-down menu to enable RADIUS accounting on the switch. RADIUS accounting can be used to determine the connection state of the end-system sessions on the Extreme Access Control engine, providing real-time connection status in Extreme Management Center.

### **Management RADIUS Server 1 and 2**

Use the drop-down menu to specify RADIUS servers used to authenticate requests for administrative access to the selected switches. Select from the RADIUS servers you have configured in Extreme Management Center, or select **New** or **Manage** RADIUS Servers to open the Add/Edit RADIUS Server or Manage RADIUS Servers windows.

### **Network RADIUS Server**

This option lets you specify a backup RADIUS server to use for network authentication requests for the selected switches. This allows you to explicitly configure a network RADIUS server to use if there is only one Extreme Access Control engine. (This option is only available if a Secondary Gateway is not specified.) Select from the RADIUS servers you have configured in Extreme

Management Center, or select New or Manage RADIUS Servers to open the Add/Edit RADIUS Server or Manage RADIUS Servers windows.

### **Policy Enforcement Point 1 and 2**

Select the Policy Enforcement Points used to provide authorization for the end-systems connecting to the VPN device you are adding. The list is populated from the N-Series, S-Series, and K-Series devices in your Console device tree. If you do not specify a Policy Enforcement Point, then Extreme Access Control is unable to apply policies to restrict end user access after the user is granted access.

### **Policy Domain**

Use this option to assign the switch to a policy domain and enforce the domain configuration to the switch. The switch must be an Extreme Networks switch.

### **Advanced Settings**

Click the Advanced Settings button to open the [Advanced Switch Settings window](#).

---

## **Related Information**

For information on related windows:

- [Switches Tab](#)
- [Edit Switches in Engine Group Window](#)

## **Add Switches to Extreme Access Control Engine Group**

---

Use this window to [add switches](#) to a gateway engine or engine group. The window allows you to select one or more switches from the device tree, and set the primary and secondary Extreme Access Control Gateways for the switches. It also lets you set other parameters including the authentication access type for the switches and the RADIUS attributes to send.

---

**NOTE:** If desired, you can set only the primary Extreme Access Control Gateway for the switches; Extreme Management Center does not require the secondary Extreme Access Control Gateway to be set. If only the primary Extreme Access Control Gateway is set, then by default that gateway uses its primary proxy RADIUS server as a secondary direct RADIUS server to the switch. This allows for redundancy without the requirement for a secondary Extreme Access Control Gateway. In this scenario, if contact with the Extreme Access Control Gateway fails, authentication traffic would bypass the Extreme Access Control gateway, but normal authentication would continue in the network, and still provide some security.

---



You can access this window by selecting an engine or engine group and clicking the **Add Switch** button in the right-panel [Switches tab](#).

## Device Tree

This area displays the device tree. Expand the tree and select the switches you want to add to the engine or engine group.

## Add Device

Opens the Add Device window where you can add a device to the Extreme Management Center database. The device is displayed in the My Network folder in the device tree.

## Switch Type

Use the drop-down menu to select the type of switch you are adding:

- **Layer 2 Out-Of-Band** — A switch that authenticates on layer 2 traffic via RADIUS to an out-of-band Extreme Access Control gateway.
- **Layer 2 Out-Of-Band Data Center** — A switch within a data center where virtualization and mobility are a factor. If an end-system changes location but does not move to a different Extreme Access Control engine, Extreme Access Control removes the end-system authentication from their prior port/switch. This allows VMs that quickly move from one server to another and then back again to still have their location updated in Extreme Management Center,

because only one authenticated session is allowed per end-system in Extreme Management Center.

- **Layer 2 RADIUS Only** — In this mode, Extreme Management Center does not require any information from the switch other than the end-system MAC address (from Calling-Station-Id or User-Name). The NAS-Port does not need to be specified. If the switch supports RFC 3576, you can set the Reauthentication Behavior in the [Advanced Switch Settings window](#). IP resolution and reauthentication may not work in this mode.
- **VPN** - A VPN concentrator being used in an [Extreme Access Control VPN deployment](#). In this case, you should specify one or more Policy Enforcement Points below. If you do not specify a Policy Enforcement Point, then Extreme Management Center is unable to apply policies to restrict access after the user is granted access.

### **Primary Gateway**

Use the drop-down menu to select the primary Extreme Access Control Gateway for the selected switches. If load balancing has been configured for the engine group, the Extreme Management Center server determines the primary and secondary gateways at Enforce, and this field displays **Determined by Load Balancer**.

### **Secondary Gateway**

Use the drop-down menu to select the secondary Extreme Access Control Gateway for the selected switches. If load balancing has been configured for the engine group, the Extreme Management Center server determines the primary and secondary gateways at Enforce, and this field displays **Determined by Load Balancer**.

---

**NOTE:** To configure additional redundant Extreme Access Control Gateways per switch (up to four), use the Display Counts option in the [Display options panel](#) (Administration > Options > Extreme Access Control).

---

### **Auth. Access Type**

Use the drop-down menu to select the type of authentication access allowed for these switches. This feature allows you to have one set of switches for authenticating management access requests and a different set for authenticating network access requests.

**WARNING:** For ExtremeXOS devices only. Extreme Access Control uses CLI access to perform configuration operations on ExtremeXOS devices.

- Enabling an Auth type of "Any Access" or "Management Access" can restrict access to the switch after an enforce is performed. Make sure that an appropriate administrative access configuration is in place by assigning a profile such as "Administrator Extreme Access Control Profile" to grant proper access to users. Also, verify that the current switch CLI credentials for the admin user are defined in the database that Extreme Management Center authenticates management login attempts against.
  - Switching from an Auth type of "Any Access" or "Management Access" back to "Network Access" can restrict access to the switch after an enforce is performed. Verify that the current switch CLI credentials for the admin user are defined locally on the switch.
- 
- **Any Access** - the switch can authenticate users originating from any access type.
  - **Management Access** - the switch can only authenticate users that have requested management access via the console, Telnet, SSH, or HTTP, etc.
  - **Network Access** - the switch can only authenticate users that are accessing the network via the following authentication types: MAC, PAP, CHAP, and 802.1X. If RADIUS accounting is enabled, then the switch also monitors Auto Tracking, CEP (Convergence End Point), and Switch Quarantine sessions. If there are multiple sessions for a single end-system, the session with the highest precedence displays to provide the most accurate access control information for the user. The Extreme Access Control authentication type precedence from highest to lowest is: Switch Quarantine, 802.1X, CHAP, PAP, Kerberos, MAC, CEP, RADIUS Snooping, Auto Tracking.
  - **Monitoring - RADIUS Accounting** - the switch monitors Auto Tracking, CEP (Convergence End Point), and Switch Quarantine sessions. Extreme Management Center learns about these session via RADIUS accounting. This allows Extreme Management Center to be in a listen mode, and to display access control, location information, and identity information for end-systems without enabling authentication on the switch. If there are multiple sessions for a single end-system, the session with the highest precedence displays to provide the most accurate access control information for the user. The Extreme Access Control authentication type precedence from highest to

lowest is: Switch Quarantine, 802.1X, CHAP, PAP, Kerberos, MAC, CEP, RADIUS Snooping, Auto Tracking.

- **Manual RADIUS Configuration** - Extreme Management Center does not perform any RADIUS configurations on the switch. Select this option if you want to configure the switch manually using the **Policy** tab or CLI.

### **Virtual Router Name**

Enter the name of the Virtual Router. The default value for this field is **VR-Default**.

---

**WARNING:** For ExtremeXOS devices only. If Extreme Management Center has not detected and populated this field, enter the Virtual Router Name carefully. Incorrectly entering a value in this field causes the RADIUS configuration to fail, which is not reported when enforcing the configuration to the switch.

---

### **Gateway RADIUS Attributes to Send**

Use the drop-down menu to select the RADIUS attributes included as part of the RADIUS response from the Extreme Access Control engine to the switch. You can also select **New** or **Manage** from the menu to open the RADIUS Attribute Settings window where you can define, edit, or delete the available attributes.

### **RADIUS Accounting**

Use the drop-down menu to enable RADIUS accounting on the switch. RADIUS accounting can be used to determine the connection state of the end-system sessions on the Extreme Access Control engine, providing real-time connection status in Extreme Management Center.

### **Management RADIUS Server 1 and 2**

Use the drop-down menu to specify RADIUS servers used to authenticate requests for administrative access to the selected switches. Select from the RADIUS servers you have configured in Extreme Management Center, or select **New** or **Manage** RADIUS Servers to open the Add/Edit RADIUS Server or Manage RADIUS Servers windows.

### **Network RADIUS Server**

This option lets you specify a backup RADIUS server to use for network authentication requests for the selected switches. This allows you to explicitly configure a network RADIUS server to use if there is only one Extreme Access Control engine. (This option is only available if a Secondary Gateway is not specified.) Select from the RADIUS servers you have configured in Extreme

Management Center, or select New or Manage RADIUS Servers to open the Add/Edit RADIUS Server or Manage RADIUS Servers windows.

### **Policy Enforcement Point 1 and 2**

Select the Policy Enforcement Points used to provide authorization for the end-systems connecting to the VPN device you are adding. The list is populated from the N-Series, S-Series, and K-Series devices in your Console device tree. If you do not specify a Policy Enforcement Point, then Extreme Access Control is unable to apply policies to restrict end user access after the user is granted access.

### **Policy Domain**

Use this option to assign the switch to a policy domain and enforce the domain configuration to the switch. The switch must be an Extreme Networks switch.

### **Advanced Settings**

Click the Advanced Settings button to open the [Advanced Switch Settings window](#).

---

## **Related Information**

For information on related windows:

- [Switches Tab](#)
- [Edit Switches in Engine Group Window](#)

## Advanced Switch Settings

---

This window allows you to configure settings for switches that require a different configuration than your standard switch settings set in the Engine Settings window.

You can access the window from the [Add Switch to Extreme Access Control Engine Group window](#) or from the [Edit Switches in Extreme Access Control Engine Group window](#).

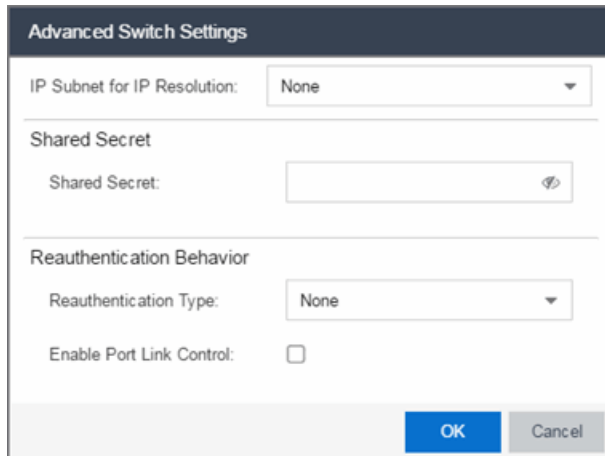

### IP Subnet for IP Resolution

Click the drop-down menu to display a list of the IP subnets configured in the Engine Settings window. If you select a subnet, the switch uses it as an inclusive list for MAC to IP resolution. Specifying an IP subnet in a static IP network allows for a router to be used for IP resolution in cases where it would not be discovered via DHCP. IP subnets also contain an IP range which can be used to filter out secondary IP addresses that are not valid for the network.

### Shared Secret

A string of alpha-numeric characters used to encrypt and decrypt communications between the switch and the Extreme Access Control engine. The shared secret is shown as a string of asterisks. When the Show Password option is selected, the shared secret is shown in text.

### Reauthentication Type

Select the reauthentication type for the switch:

- SNMP - uses SNMP to trigger reauthentication using various OIDs in different MIBs. The Extreme Access Control engine checks a series of proprietary Enterasys MIBs, standardized MIBs, and proprietary third-party MIBs to determine availability, and forces reauthentication using any available SNMP method.
- Session Timeout - causes Extreme Access Control to return a session timeout and terminate action to the end-system via RADIUS response attributes. The use of this mechanism causes the user to be automatically reauthenticated at a specified interval by the switch to which they are connected. Only use this option for wireless switches that do not have RFC 3576 support or wired switches that do not have SNMP support.

- RFC 3576 - a method of reauthenticating RADIUS sessions through the use of Disconnect-Request messages as defined by RFC 3576. (For more information, see <http://www.ietf.org/rfc/rfc3576.txt>). RFC 3576 configurations must be customized to work with the specific vendor implementation for each device type. To add, edit, or delete an RFC 3576 configuration, click the Manage RFC 3576 Configurations button.

### **Enable Port Link Control**

Port link control allows the toggle of the operational mode of a port. Select this option to enable port link control for specific switches.

---

### **Related Information**

For information on related windows:

- [Edit Switches in Extreme Access Control Engine Group Window](#)
- [Add Switches to Extreme Access Control Engine Group Window](#)

## **All Access Control Engines**

---

The **All Extreme Access Control Engines** tab is displayed in the right panel when you select the All Extreme Access Control Engine tree in the left panel or when you select the **Extreme Access Control Engines** tab when an Extreme Access Control Engine Group is selected. The panel displays a table of information about the engines in the folder or group. Right-click an engine for a menu of options.

Use the table options and tools to filter, sort, and customize table settings. You can access the options by clicking the down arrow in the right corner of any column header.

---

**NOTE:** The Extreme Access Control Engine administration web page allows you to access status and diagnostic information for an Extreme Access Control engine. Access the administration web page using the following URL: `https://Extreme Access ControlEngineIP:8444/Admin`. The default user name and password for access to this web page is "admin/Extreme@pp."

---

All Access Control Engines							
Access Control Engines		End-Systems					
Name	IP Address	Engine Type	Primary Count	Secondary Count	Model	Version	Serial Number
nac60-18884.nac2003.com		NAC Gateway	1	0	NAC-V	6.2.0.DEV	2HC0WD1
naca20-200-10.nac2003.com		NAC Gateway	3	0	NAC-A-20-2	6.3.0.DEV	370J3P1
naca2k-200-11.nac2003.com		NAC Gateway	0	2	NAC-A-2K	6.2.0.213	
naca2k-200-20.nac2003.com		NAC Gateway	2	0	NAC-A-2K	6.2.0.DEV	3TNVTH1
naca2k-200-21.nac2003.com		NAC Gateway	0	2	NAC-A-2K	6.3.0.DEV	
nacmsm-vpn-200-30.nac200...		Unknown	0	0	NAC-UNKOWN		

**Name**

The name of the Extreme Access Control engine (assigned when the engine is created).

**IP Address**

The Extreme Access Control engine's IP address.

**Engine Type**

The Extreme Access Control engine type: Extreme Access Control Gateway, Extreme Access Control Layer 2 (L2) Controller, or Extreme Access Control Layer 3 (L3) Controller.

**Primary Count**

The number of switches for which the Extreme Access Control engine is the primary engine.

**Secondary Count**

The number of switches for which the Extreme Access Control engine is the secondary engine.

**Model**

The Extreme Access Control engine's model number.

**Version**

The Extreme Access Control engine's version number.

**CPU Load (0-100%)**

The percentage of the engine's CPU currently being used. This value gives you an indication of how busy the engine is and helps you determine if your network needs additional engines, or if you need to change your network configuration so that the load is more evenly distributed among your existing engines.

**Memory Used**

The amount of memory used by the engine.



**Memory Available**

The amount of memory available on the engine.

**Connected Agents**

The number of assessment agents connected to the engine.

**Capacity**

The engine's current capacity, which is the number of end-systems that have authenticated within the last 24 hours out of the maximum number of authenticating end-systems supported for the engine.

---

**Related Information**

For information on related windows:

- [End-Systems Tab](#)

## Engine Settings Window

---

Engine settings provide advanced configuration options for Extreme Access Control engines. Extreme Management Center comes with a default engine settings configuration. If desired, you can edit these default settings or you can define your own settings to use for your Extreme Access Control engines.

You can launch the Engine Settings window by right-clicking an engine or engine group in the Extreme Access Control Engine Groups left-panel tree or by right-clicking an Extreme Access Control engine in the All Extreme Access Control Engines. The Engine Settings window opens with the following tabs available for configuration:

- [Credentials Tab](#)
- [Network Tab](#)
- [Auditing Tab](#)

---

**NOTE:** To access status and diagnostic information for an Extreme Access Control engine, launch the Extreme Access Control Engine administration web page by using the following URL: `https://<Extreme Access ControlEngineIP>:8444/Admin`. The default user name and password for access to this web page is "admin/Extreme@pp." The username and password can be changed in the Web Service Credentials field on the [Credentials Tab](#) in the Engine Settings window.

---

## Credentials

Use this tab to configure various parameters for your network engines including switch configuration, web service credentials, and EAP-TLS configuration.

Engine Settings - Default
✕

Credentials
Network Settings
Auditing

### Switch Configuration

Specify the shared secret to use when switches communicate with Access Control Engines.

Shared Secret:

RADIUS Timeout:

RADIUS Timeout Retry Count:

Use Primary RADIUS Server for Redundancy in a Single Engine Configuration. (Basic AAA Configuration only.)

SNMP Timeout:

---

### Admin Web Page Credentials

Changes to the credentials will be propagated to the Access Control Engines on Enforce.

Username:

Password:

---

### Admin Web Page Authentication

By default, the Access Control Engine Admin Web Page (<http://<Engine IP>:8080/>) uses the above Web Service Credentials for authentication. Selecting this option allows that page to use the AAA Configuration for authentication as well. For a user to log in, the Access Control Engine must also have a local user account matching their username.

Use AAA Configuration for Admin Web Page Authentication.

---

### EAP-TLS Configuration

Server Private Key Phrase:

## Switch Configuration

Enter the shared secret that switches uses when communicating with Extreme Access Control engines.

**Shared Secret**

A string of alpha-numeric characters used to encrypt and decrypt communications between the switch and the Extreme Access Control engine. The shared secret is shown as a string of asterisks. Click the **Eye** icon to view the shared secret.

**RADIUS Timeout**

The amount of time (in seconds) that a switch waits before re-sending a RADIUS request to the Extreme Access Control engine. The default is 15 seconds and the maximum is 60 seconds.

---

**NOTES:** The time specified should be long enough to allow the Extreme Access Control engine to receive a response from the RADIUS server.

Although this option allows a maximum of 60 seconds, the actual maximum time allowed varies depending on the switch model. If a switch does not support the timeout value specified here, then the value is not set on the switch and an error message displays in the Extreme Access Control engine log. Check your switch documentation to verify supported values.

---

**RADIUS Timeout Retry Count**

The number of times the switch attempts to contact an Extreme Access Control engine with a RADIUS request, when an attempted contact fails. The default setting is 3 retries, which means that the switch retries a timed-out request three times, making a total of four attempts to contact the engine.

**Use Primary RADIUS Server for Redundancy in Single Extreme Access Control Engine Configuration**

If your Extreme Access Control deployment has only one Extreme Access Control engine, this option allows you to configure redundancy by using the primary RADIUS server as a backup when configuring the switches. This option would not apply to Extreme Access Control deployments using advanced AAA configurations with more than one set of RADIUS servers, or if you have configured primary and secondary Extreme Access Control engines.

## Web Service Credentials

**Extreme Access Control Engine Web Service Credentials**

The credentials specified here provide access to the Extreme Access Control engine administration web page and the web services interface between the Extreme Management Center server and the Extreme Access Control engine. NAC Manager

provides default credentials that can be changed, if desired. Changes to the credentials are propagated to the Extreme Access Control engines on Enforce.

## Extreme Access Control Admin Web Page

By default, the Extreme Access Control engine administration web page (<https://<Extreme Access ControlEngineIP>:8444/Admin/>) uses the above Web Service Credentials for authentication. However, you can configure the web page to use the AAA Configuration assigned to that engine for authentication as well. This allows you to use LDAP or RADIUS authentication for the web page.

There are three steps for setting up the web page to use LDAP or RADIUS authentication:

1. Verify that the Extreme Access Control Configuration assigned to the engine has LDAP or RADIUS authentication configured in its AAA Configuration.
2. Create a local user account on the Extreme Access Control engine that matches the user name of the user logging in. Use the `useradd` command on the Extreme Access Control engine CLI to create the local user account.
3. Select the **Use Extreme Access Control AAA Configuration for Admin Web Page authentication** option here on the Credentials tab. Click **OK**. Enforce the change to the engine.

The Extreme Access Control engine begins using the AAA configuration for the administration web page authentication. Note that it may take the Linux operating system on the Extreme Access Control engine up to two minutes to recognize that the new user is valid.

## EAP-TLS Configuration

### Server Private Key Passphrase

The Server Private Key Passphrase is used to encrypt the private key created during certificate request generation of server certificates for use by Extreme Access Control engines during Local EAP-TLS Authentication. The passphrase must be identical for all Extreme Access Control engines, and must be configured properly, or Local EAP-TLS Authentication does not operate successfully.

## Network Settings

Use this tab to configure the following network services for the Extreme Access Control engine: DNS, NTP, SSH, and SNMP.

### Manage DNS Configuration

Select the **Manage DNS Configuration** checkbox and enter a list of search domains and DNS servers.

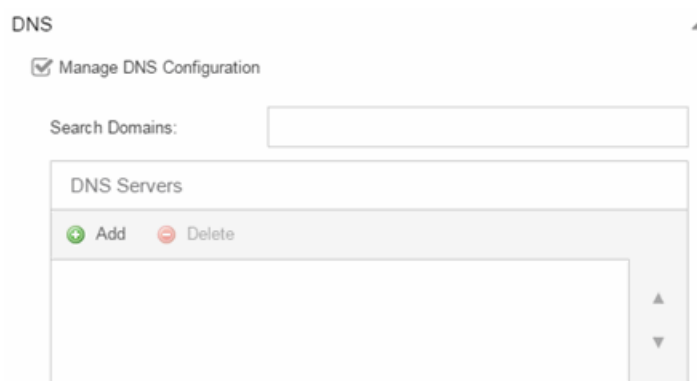

The screenshot shows the DNS configuration interface. At the top, the word "DNS" is displayed. Below it, the checkbox "Manage DNS Configuration" is checked. There is a "Search Domains:" label followed by an empty text input field. Below that is a section titled "DNS Servers". Inside this section, there are two buttons: a green "Add" button with a plus sign and a red "Delete" button with a minus sign. Below the buttons is a large empty rectangular area, likely for listing DNS servers, with up and down arrow icons on the right side.

#### Search Domains

A list of search domains used by the Extreme Access Control engine when doing lookups by hostname. When an attempt to resolve a hostname is made, these domain suffixes are appended to the hostname of the device. For example, if someone does a ping to server1, NAC Manager appends the search domains in an attempt to resolve the name: server1.domain1 server1.domain2, and so on.

#### DNS Servers

A list of DNS servers the Extreme Access Control engine sends DNS lookups to for name resolution. The list is used by both hostname resolution and by the DNS proxy. You can enter multiple servers for redundancy. Use the Up and Down arrows to list the servers in the order they should be used.

### Manage NTP Configuration

NTP (Network Time Protocol) configuration is important for protocols such as SNMPv3 and RFC3576 which incorporate playback protection. In addition,

having accurate time configured on the Extreme Access Control engine is essential for event logging and troubleshooting.

Select the **Manage NTP Configuration** checkbox, specify the appropriate time zone, and create a list of NTP servers.

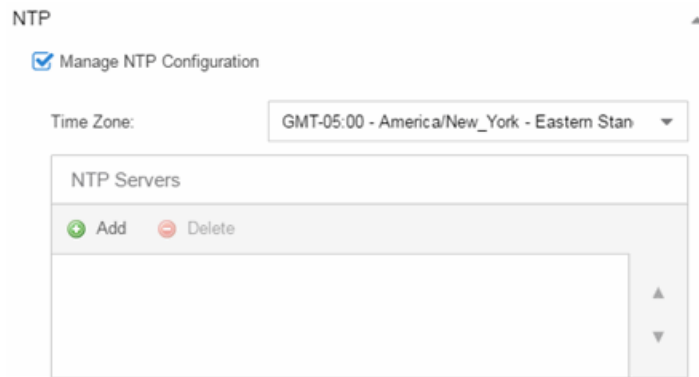

NTP

Manage NTP Configuration

Time Zone: GMT-05:00 - America/New\_York - Eastern Stan

NTP Servers

+ Add - Delete

### Time Zone

Select the appropriate time zone. This allows NAC Manager to manage all date/time settings.

### NTP Servers

A list of NTP servers. You can enter multiple servers for redundancy. Use the Up and Down arrows to list the servers in the order they should be used.

## Manage SSH Configuration

SSH configuration provides additional security features for the Extreme Access Control engine.

Select the **Manage SSH Configuration** checkbox and provide the following SSH information.

SSH

Manage SSH Configuration

Port:

Disable Remote root Access:

RADIUS Authentication

SSH Users		
Username	Type	Administrative User
<div style="display: flex; justify-content: space-between; align-items: center;"> <span>+</span> Create...           <span>✎</span> Edit...           <span>✖</span> Delete         </div>		

## Port

The port field allows you to configure a custom port to be used when launching SSH to the engine. The standard default port number is 22.

## Disable Remote root Access

Select this option to disable remote root access via SSH to the engine and force a user to first log in with a real user account and then su to root (or use sudo) to perform an action. When remote root access is allowed, there is no way to determine who is accessing the engine. With remote root access disabled, the /var/log/message file displays users who log in and su to root. The log messages look like these two examples:

```
sshd[19735]: Accepted password for <username> from
10.20.30.40 port 36777 ssh2
su[19762]: + pts/2 <username>-root
```

Enabling this option does not disable root access via the console. Do not disable root access unless you have configured RADIUS authentication or this disables remote access to the Extreme Access Control engine.

## RADIUS Authentication

This option lets you specify a centralized RADIUS server to manage user login credentials for users that are authorized to log into the engine using SSH. Select a primary and backup RADIUS server to use, and use the table below to create a list of authorized RADIUS users.

## SSH Users Table

Use the toolbar buttons to create a list of users allowed to log in to the Extreme Access Control engine using SSH. You can add Local and RADIUS



users and grant the user Administrative privileges, if appropriate. A user that is granted administrative rights can run sudo commands and commands that only a root user would be able to run. For example, some commands that require administrative rights to run would be:

```
sudo nacctl restart
sudo reboot
sudo nacdb
```

If a user is not granted administrative rights, they can log in, view files, and run some commands such a ping and ls.

## SNMP Configuration

The SNMP configuration section allows you to deploy SNMP credentials for the Extreme Access Control engine. The credentials can include different read/write credentials, for example, the read credential can be "public" and the write credential can be "private". In addition, basic host traps can be enabled from the Extreme Access Control engine.

Select the **Manage SNMP Configuration** checkbox and provide the following SSH information.

SNMP ▲

Manage SNMP Configuration

Profile:	<input type="text" value="EXTR_v2_Profile"/>
Trap Mode:	<input type="text" value="Disabled"/>
Trap Community Name:	<input type="text"/>
System Contact:	<input type="text"/>
System Location:	<input type="text"/>

### Profile

Use the drop-down menu to select a device access profile to use for the Extreme Access Control engine.

### Trap Mode

Set the trap mode.

### Trap Community Name

Supply the trap community name.

### System Contact

Enter the name of the system contact.

## System Location

Enter the location of the system.

## Auditing

Use this tab to enable auditing of users connected to the Extreme Access Control engine CLI via SSH.

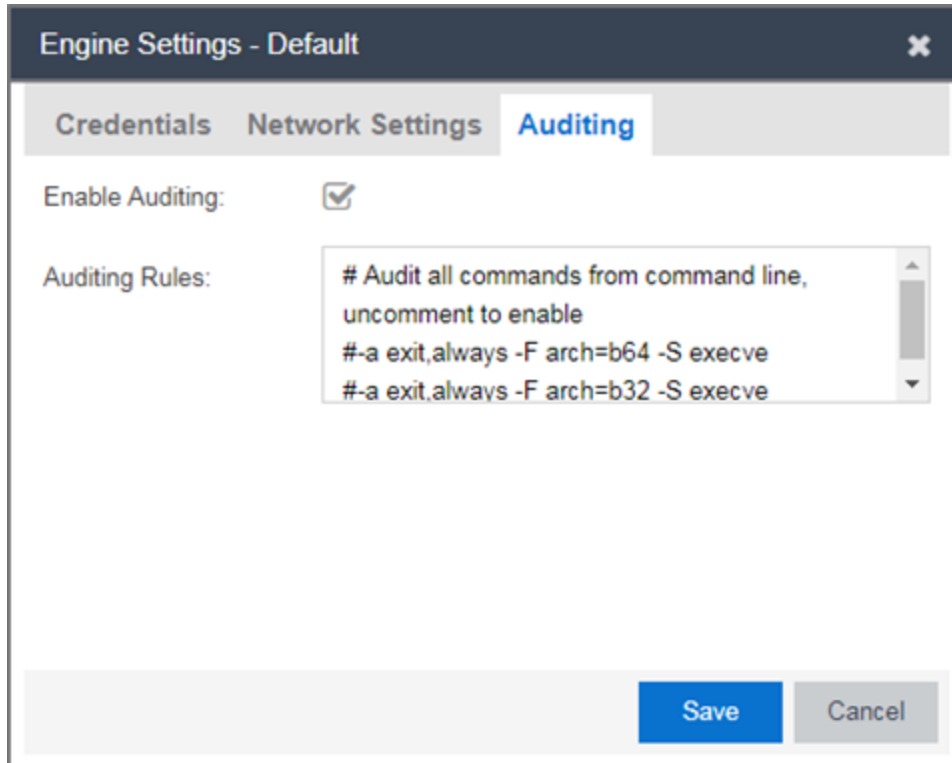

### Enable Auditing

Selecting the **Enable Auditing** option enables the **Auditing Rules** field, where you can configure Extreme Management Center to store all commands entered by a user connected to the Extreme Access Control engine CLI via SSH in the engine's local syslog file.

### Auditing Rules

Remove the # symbol from the beginning of a command line to enable the command and store user commands entered using the Extreme Access Control engine CLI.

## Related Information

For information on related windows:

- [All Extreme Access Control Engines](#)

## Details (Extreme Access Control Engine)

This tab provides information about an Extreme Access Control engine's configuration. The information changes depending on the type of engine selected in the left-panel tree.

To access this tab, select an Extreme Access Control engine in the left-panel tree, then click the **Details** tab in the right panel.

Engine - [Redacted]

**Details** End-Systems Switches

Status: **Not Started or Unreachable**

---

**Engine**

IP Address: [Redacted]  
 Type: Access Control Engine - IA-V  
 Version: 7.0.20 DEV  
 Serial Number: Unknown

---

**Management**

Server: Unknown  
 End-System Capacity: 0/3000 (0%)  
 Configuration: Default  
 Engine Settings: Using Group Settings

---

**Certificates**

[Manage...](#)

---

**Interface Summary**

<a href="#">Edit...</a>	Interface:	eth0	Management, Registration & Remediation	IP: [Redacted]
	Interface:	eth1	Listen Only	
<a href="#">Static Routes...</a>	Interface:	eth2	Listen Only	
	Interface:	lo	Off	IP: [Redacted]

---

**Bypass Configuration**

[Enable Authentication](#) Access Control Bypass will disable processing of authentication or assessment requests.

[Enable Assessment](#)

Authentication: Disabled  
 Assessment: Disabled

## General Information

This section displays general information about the Extreme Access Control engine, including its name, IP address, type (Extreme Access Control Gateway or Layer 2/Layer 3 Extreme Access Control Controller), the engine version, the IP address of

---

the Extreme Management Center Management server, and the Extreme Access Control engine status.

### **End-System Capacity**

This field lists the engine's current capacity, which is the number of end-systems that authenticated within the last 24 hours out of the maximum number of authenticating end-systems supported for the engine.

### **Extreme Access Control Configuration**

Displays the Extreme Access Control Configuration assigned to the engine. The Extreme Access Control Configuration determines the Extreme Access Control Profile assigned to an end-system connecting to the network.

### **Engine Settings**

Indicates whether the engine is using Group Settings or has an engine settings override configured.

### **Interface Summary**

Displays a summary of the current engine interface configuration.

Click **Edit** to open the [Interfaces window](#), where you can change the engine Host Name and Gateway..

Click **Static Routes** to open the [Static Routes window](#), where you can add or edit the static routes used for advanced routing configuration..

### **Extreme Access Control Bypass Configuration**

The Extreme Access Control Bypass Configuration feature allows you to bypass Extreme Access Control processing of authentication requests from end-systems connecting to the network and also disable the Extreme Access Control assessment process. For Extreme Access Control authentication bypass, Extreme Access Control either configures the switch to authenticate directly to a RADIUS server to which Extreme Access Control is configured to proxy authentication requests, or it disables RADIUS authentication on the switch. This capability is useful for troubleshooting purposes. For example, if there is a problem with an Extreme Access Control Configuration, the **Disable** button lets you remotely disable Extreme Access Control functionality until the problem is resolved. You can then use the **Enable** button to re-enable Extreme Access Control functionality on the engines. When Extreme Access Control authentication or assessment is disabled, the Extreme Access Control engine name and IP address display in red text in the left-panel tree indicating the engine is in Bypass mode.

**For Extreme Access Control Gateway engines**, when you select the option to disable Extreme Access Control authentication processing, if proxy

RADIUS servers are configured for authentication in a Basic AAA Configuration, the Extreme Access Control Engine configures the switches to send RADIUS packets directly to the primary and secondary RADIUS servers (from the Basic AAA Configuration), instead of talking to the RADIUS proxy through the Extreme Access Control gateway. RADIUS authentication is not disabled on the switch, and end users still need to authenticate in order to connect to the network. The switches must be defined in the back-end proxy RADIUS server as RADIUS clients with the same shared secret used by the Extreme Access Control Gateway engines. If there are no proxy RADIUS servers configured in a Basic AAA Configuration, or if an Advanced AAA Configuration is used, RADIUS authentication on the switch is disabled when Extreme Access Control authentication processing is disabled.

---

**NOTES:** If you have disabled Extreme Access Control authentication processing and then enforce with new switches, the new switches are configured to send RADIUS packets directly to the primary and secondary RADIUS servers. These switches are reconfigured to talk to the RADIUS proxy when you enable Extreme Access Control; a second enforce is not necessary.

Bypass is not an option for switches set to Manual RADIUS Configuration or ExtremeWireless controllers not configured for RADIUS strict mode.

---

**For Extreme Access Control Controller engines**, when you disable Extreme Access Control authentication, then the Extreme Access Control Controller does **not** send RADIUS packets directly to the RADIUS servers. Authentication **is** disabled on the Extreme Access Control Controller and end-systems do not need to authenticate to the network. Traffic from the end-systems bypass the Extreme Access Control Controller and go directly onto the network.

The **Status** fields provide the current status of the Extreme Access Control authentication or assessment process. The authentication status field also includes a link to the Verify RADIUS Configuration on Switches feature. This feature is available for Extreme Access Control Gateway engines and Layer 2 Extreme Access Control Controllers, and can be used to alert you to any RADIUS configurations that are out of sync and could cause RADIUS authentication problems on the network.

## Details (Extreme Access Control Engine Groups)

This tab provides information about the [Extreme Access Control Details](#) being used by your Extreme Access Control engines.

To access this tab, select an engine group from within the Engine Group tree in the left-panel tree, then click the **Details** tab in the right panel.

The screenshot displays the 'Access Control' configuration page. The left sidebar shows a tree view with 'Engine Groups' expanded to 'Default'. The main content area is titled 'Engine Group - Default' and has tabs for 'Details', 'Switches', 'End-Systems', and 'Access Control Engines'. The 'Details' tab is active, showing the following configuration:

- Status: OK
- Group:
  - RADIUS Monitor Clients: Disabled
  - Distributed End-System Cache: Enabled
  - Policy Domain: Default Policy Domain
- Engines:
  - Engine Settings...: Engine Settings: Default
  - Engine Count: 0
- Access Control Configuration - Default:
  - Edit Configuration...: Default Profile: Disabled
  - Registration: Disabled
  - Assessment/Remediation: Disabled
  - Portal Configuration: Default
  - AAA Configuration: Default
- Load Balancing:
  - Load Balancing: Disabled

At the bottom left, there are 'Enforce' and 'Refresh' buttons.

### RADIUS Monitor Clients

Displays whether RADIUS Monitor Clients are enabled for the Extreme Access Control engines in the folder.

### Distributed End-System Cache

Displays whether the [Distributed End-System Cache](#) option is enabled for the Extreme Access Control engines in the folder.

### Policy Domain

Displays the policy domain for the Extreme Access Control engines in the folder.

**Engine Settings**

The engine settings configuration being used by your Extreme Access Control engines. Engine settings are configurable through the Extreme Access Control Configurations view, by expanding the **Extreme Access Control Configurations** tree from the left panel.

**Engine Count**

The number of engines in the engine group.

**Configuration**

The name of the Extreme Access Control Configuration being used by your Extreme Access Control engines. The Extreme Access Control Configuration determines the Extreme Access Control Profile assigned to an end-system connecting to the network.

**Default Profile**

The name of the Default Profile specified in the Extreme Access Control Configuration. The Default Profile serves as a "catch-all" profile for any end-system that doesn't match one of the rules listed in the Extreme Access Control Configuration.

**Registration**

Whether a registration/web access feature is enabled or disabled for the Extreme Access Control Configuration.

**Assessment/Remediation**

Whether the assessment/remediation feature is enabled or disabled for the Extreme Access Control Configuration.

**Portal Configuration**

The name of the [Portal Configuration](#) specified in the Extreme Access Control Configuration. If your network is implementing Registration or Assisted Remediation, the Portal Configuration defines the branding and behavior of the website used by the end user during the registration or remediation process.

**AAA Configuration**

The name of the [AAA Configuration](#) specified in the Extreme Access Control Configuration.

**Load Balancing**

This section allows you to configure load balancing for the engine group. Extreme Management Center provides two different load balancing configuration options: either ExtremeXOS/EOS firmware on S-Series and K-Series devices, or utilizing

external load balancers. Load balancing allows you to evenly distribute authentication requests and switch configuration ownership among your Extreme Access Control gateway engines. This can be useful in Extreme Access Control deployments with a large number of switches, where manual delegation of switch resources would be cumbersome.



## Interface Configuration Window

Use this Extreme Management Center window to configure the interfaces on an Extreme Access Control engine. Interface configuration allows you to separate management traffic from end-system traffic, providing another layer of protection for sensitive data. It also provides the ability to snoop mirrored traffic on other ports.

This window is accessed from the **Control > Extreme Access Control** tab by selecting an Extreme Access Control engine, opening the **Details** tab, and clicking the **Edit** button in the Interface Summary section.

The screenshot shows a configuration window for interfaces. The title bar reads "Interfaces - [redacted]". The main content area is divided into sections for each interface. The first section is for "eth0". It contains the following fields and options:

- IP Address: [redacted]
- Mode: Management, Registrar (dropdown menu)
- Gateway: [redacted]
- Host Name: nacappliance
- Services: Management, Monitoring Services, Network Services, AAA Servers, Device, Portal: Management, End-System, Traffic Snooping
- DHCP/Kerberos Snooping
- Captive Portal HTTP Mirroring

Below the "eth0" section, there is a section for "eth1" which is currently empty. At the bottom right of the window, there are two buttons: "Save" (in blue) and "Cancel" (in grey).

## Interface Modes

There are five different modes that can be configured for an interface: Management, Registration & Remediation, Management Only, Registration & Remediation Only, Listening Only, Advanced Configuration, and Off. The mode determines the type of traffic allowed on the interface and the [services](#) provided by the interface.

You can configure all the interfaces on an engine; however, you cannot change the management interface and you are only allowed to configure one interface to allow management traffic.

**Management, Registration & Remediation** – This mode is the in-band management mode where both management traffic and registration, assessment, and remediation traffic use the same interface. In this mode, the engine does not limit traffic to each of the services.

**Management Only** – In this mode, the engine binds all management services to this interface. This includes:

- traffic to Extreme Management Center and other engines (JMS and HTTP)
- all traffic to switches
- all LDAP and RADIUS traffic
- traffic for the following services: SSH daemon, SNMP daemon, and RADIUS server
- traffic for captive portal administration, sponsorship, pre-registration, and screen preview (on ports 80 and 443)
- traffic for WebView pages and Extreme Management Center web services (on ports 8080 and 8443)

**Registration & Remediation Only** – In this mode, the engine binds all registration and remediation services to this interface. All traffic to end-systems is initiated through this interface, including:

- assessment traffic
- NetBIOS for IP and hostname resolution
- traffic for registration pages, remediation pages, and self-registration (on ports 80 and 443)
- all agent communication traffic (on ports 8080 and 8443)

**Listen Only** – In this mode, the engine allows DHCP and Kerberos snooping to be performed on the interface. No IP address or hostname can be assigned to the interface.

**Advanced Configuration** - This mode allows you to configure the services that are provided by the selected interface, using the link in the [Services](#) field. This is useful for [Extreme Access Control deployments in MSP or MSSP environments](#).

**Off** – The interface is disabled and not used in any way.

## Services

The Services field displays the services that are provided by the Extreme Access Control engine interface, as determined by the selected interface mode. Each mode provides a different set of services on the interface.

If the mode is set to Advanced Configuration, the services list becomes a link that launches an Edit window where you can select or deselect the services provided by the interface. This granularity is useful for [Extreme Access Control deployments in MSP or MSSP environments](#).

The following list describes the various services that are provided by the different modes:

- **Management** - The communication to and from the Extreme Management Center server. Sub-services include JMS, Web Services, and Syslog.  
**NOTE:** The Management service cannot be moved from eth0.
- **Monitoring Services** - The services used to monitor or contact an engine. Sub-services include the SSH daemon and SNMP agent.
- **Network Services** - The communication to external servers that provide networking services. Sub-services include DNS servers and NTP servers.  
**NOTE:** The Network Services service can only be applied to one interface.
- **AAA Servers** - The communication used by external servers for authentication and authorization. Sub-services include RADIUS servers and LDAP servers.  
**NOTE:** The AAA Servers service can only be applied to one interface.
- **Device** - The communication to and from a NAS (switch, router, VPN, or wireless controller). Sub-services include SNMP, RADIUS, RFC3576, SSH/Telnet, and TFTP.
- **Portal: Management** - the captive portal registration management services for an engine.
- **End-System** - The communication to and from end-systems. Sub-services include portal registration and remediation, assessment, NetBIOS, and DNS proxy.
- **Traffic Snooping** - DHCP and Kerberos snooping on the interface. This service is listed if the [DHCP/Kerberos Snooping option](#) is set to Enabled.

## DHCP/Kerberos Snooping

Use the DHCP/Kerberos Snooping option to enable or disable DHCP and Kerberos snooping on the interface. DHCP snooping is used for IP resolution and OS detection. Kerberos snooping is used for user name detection and [elevated access](#).

## Captive Portal HTTP Mirroring

This is an advanced option that allows the interface to accept mirrored HTTP traffic which is used to display the captive portal to end users. This option is an alternative to using Policy-Based Routing and DNS Proxy.

## Tagged VLANs

If the mirrored traffic includes an 802.1Q VLAN tag, then the list of VLANs to capture must be explicitly stated in this field by entering a comma-separated list of VLAN IDs from 1 to 4094. If the mirrored traffic is not tagged then this field can be left blank.

## Static Route Configuration Window

This window displays the static routes used for advanced routing configuration. Use the toolbar buttons to add, edit, or delete a route.

This window is accessed from the **Control > Extreme Access Control** tab by selecting an Extreme Access Control engine, opening the **Details** tab, and clicking the **Static Routes** button in the Interface Summary section.

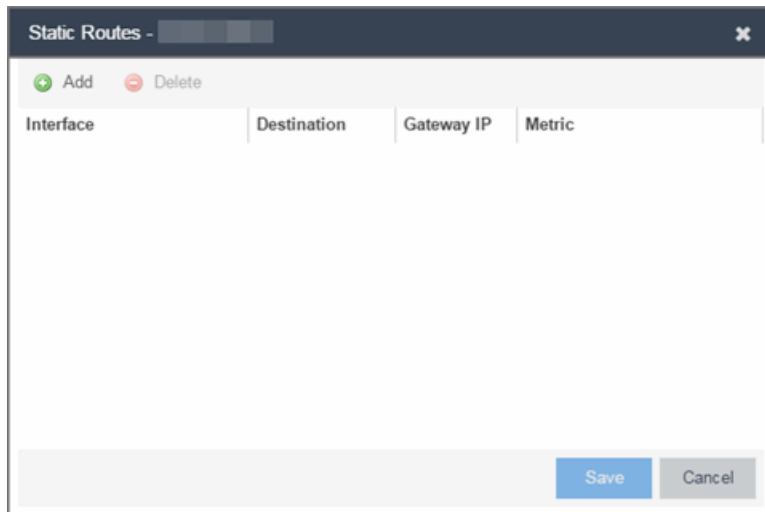

### Interface

The Extreme Access Control engine interface used for the static route.

### Destination

The IP address used to define the subnet or individual device whose traffic is assigned to the route.

### Gateway IP

The IP address of the device where traffic matching the Network value is sent.

### Metric

A number used to configure route precedence. The lower the number, the higher the precedence.

## How To Use Access Control

---

The **How To** section contains Help topics that give you instructions for performing tasks in the **Access Control** tab.

## How to Use Device Type Profiling

---

This Help topic describes how to set up device type profiling in your Extreme Access Control Configuration using device type rule groups. Device type profiling lets you assign Extreme Access Control profiles to end-systems based on operating system family, operating system, or hardware type. This allows you to use the end-system's device type to determine the end user's level of network access control and whether the end-system is scanned. For more information on device type groups, see the [Add/Edit Device Type Group Window](#) Help topic.

---

**NOTE:** Assessment provides the most accurate determination of device type. If the initial device type determination is not based on assessment results, it may be less reliable. For that reason, device type rule groups should be based on broad families of device types.

---

Here are some examples of how device type profiling can be used to determine network access:

- When an end user with valid credentials logs in to the network on a registered iPad versus a registered Windows 10 machine, they receive a lower level of network access.
- When an end user registers a Windows machine using its MAC address, another user cannot spoof that MAC address using a Linux system. (Device profiling does not resolve this issue in environments with dual boot machines.)
- If an end user exports a certificate from a corporate PC to an iPad and successfully authenticates with 802.1x, the iPad is not allowed full network access.

## Device Profiling Use Case

This section provides high-level instructions for configuring device type profiling for a sample use case. In this scenario, the network administrator has the following network access requirements:

- All Windows registered devices should be assigned the "Default Extreme Access Control Profile."
- All Windows 10 registered devices should be assigned the "Windows10 Profile."

- All Linux registered devices should be assigned the "Default Extreme Access Control Profile." In addition, a new Linux version called SuperLinux needs to be added to the Linux family device type.
- All HP Printers should be assigned the "HP Printer Profile."

To do this, create four rules in your Extreme Access Control configuration that use device type as criteria for matching rules to end-systems authenticating to the network. The following instructions assume that you already created your profiles: Basic Profile, Windows10 Profile, and HP Printer Profile.

1. Expand the Default left-panel tree (Control > Extreme Access Control > Extreme Access Control Configurations > Default).
2. Select the Rules left-panel option and click the **Add** button in the right panel.

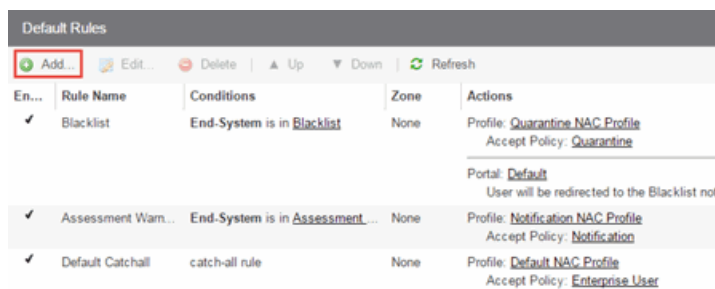

En...	Rule Name	Conditions	Zone	Actions
✓	Blacklist	End-System is in <u>Blacklist</u>	None	Profile: <u>Quarantine NAC Profile</u> Accept Policy: <u>Quarantine</u>  Portal: <u>Default</u> User will be redirected to the Blacklist not
✓	Assessment Warn...	End-System is in <u>Assessment...</u>	None	Profile: <u>Notification NAC Profile</u> Accept Policy: <u>Notification</u>
✓	Default Catchall	catch-all rule	None	Profile: <u>Default NAC Profile</u> Accept Policy: <u>Enterprise User</u>

3. Create a rule that assigns the Default Extreme Access Control Profile to all Registered Guests using Windows devices as shown below.

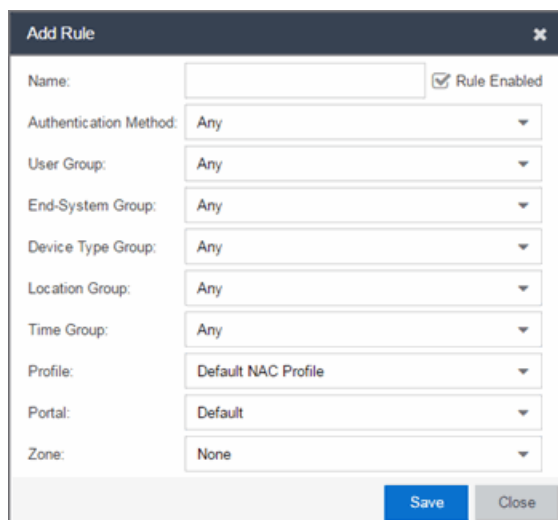

Name:	<input type="text"/>	<input checked="" type="checkbox"/> Rule Enabled
Authentication Method:	Any	▼
User Group:	Any	▼
End-System Group:	Any	▼
Device Type Group:	Any	▼
Location Group:	Any	▼
Time Group:	Any	▼
Profile:	Default NAC Profile	▼
Portal:	Default	▼
Zone:	None	▼



4. Create a rule that assigns the Windows10 Profile to all Windows 10 registered devices. To do this, you need to create a new Windows 10 device type group.
  - a. From the Extreme Access Control Configurations left-panel tree, expand the Group Editor tree.
  - b. Select Device Type Groups and click the **Add** button in the right panel.

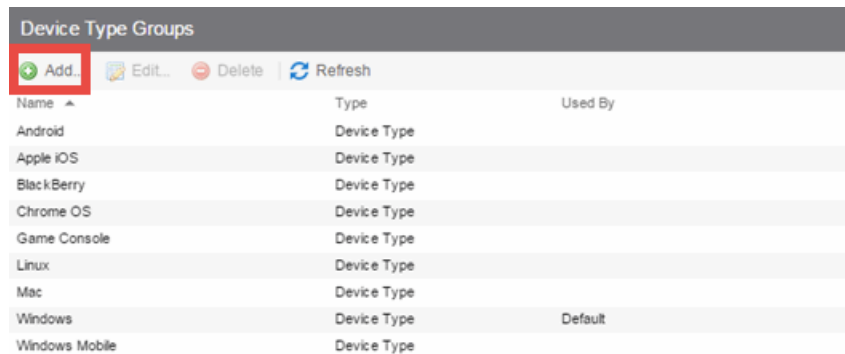

- c. Create a new device type group with the name Windows 10.

The screenshot shows the 'Add New Group' dialog box. It has three input fields: 'Name' with the value 'Windows 10', 'Description' with the value 'All Windows 10 devices', and 'Type' with a dropdown menu showing 'Device Type'. At the bottom, there are two buttons: 'Create' and 'Cancel'.

- d. Click **Create**. The Device Type Entry Editor appears.

The screenshot shows the 'Add New Group' dialog box. It has a title bar with a close button. Below the title bar are three input fields: 'Name' with the value 'Windows 10', 'Description' with the value 'All Windows 10 devices', and 'Type' with a dropdown menu showing 'Device Type'. Below these fields is a section titled 'Device Type Entry Editor'. This section has a toolbar with three buttons: 'Add...' (green plus), 'Edit...' (pencil), and 'Delete' (red minus). To the right of the toolbar is a 'Show Filters' button. Below the toolbar is a table with two columns: 'Value' and 'Description'. The table is currently empty. At the bottom of the table area, there is a pagination bar showing '<< < | Page 0 of 0 | > >>' and a 'Reset' button. Below the table area are three buttons: 'Save & Close' (blue), 'Save' (grey), and 'Cancel' (grey).

- e. Click the **Add** button. The Add Entry window appears.

The screenshot shows the 'Add Entry' dialog box. It has a title bar with a close button. Below the title bar are two input fields: 'Device Type:' and 'Entry Description:'. Below these fields is a button labeled 'Select from Existing Types'. At the bottom right of the dialog are two buttons: 'Add' (blue) and 'Cancel' (grey).

- f. Click the **Select from Existing Types** button and in the Select Device Types window, select Windows 10.

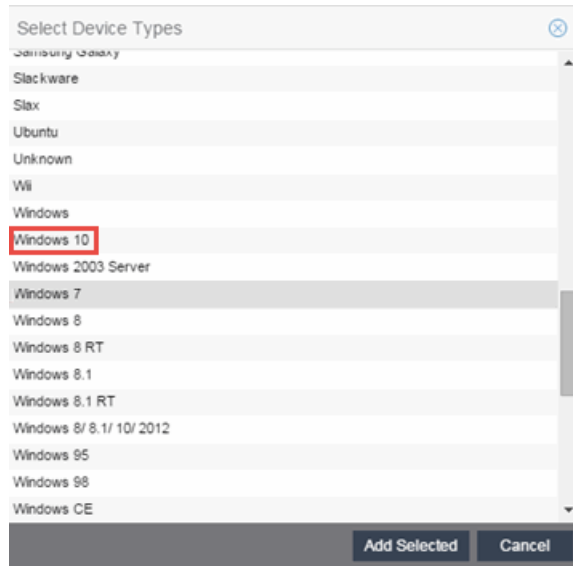

- g. Click the **Add Selected** button.
- h. Click the **Save & Close** button on the Add New Group window.
- i. You can then create the rule.
- j. Select the Extreme Access Control Configurations > Default > Rules left-panel option and click the **Add** button in the right panel.
- k. In the Profile drop-down menu, select **New**. The Create New Profile window appears.

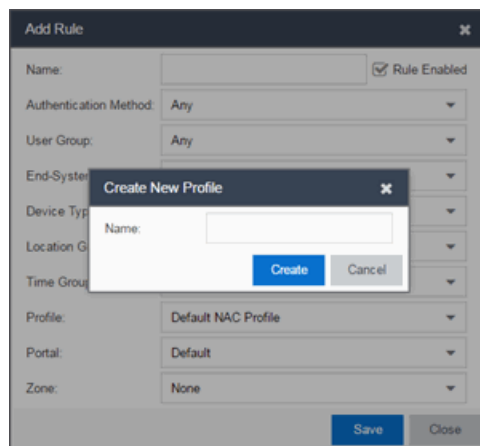

- l. Enter the name **Windows10** in the **Name** field and click the **Create** button.

The Extreme Access Control Profile window opens.

- m. Click **Save**.
- n. Configure the rule as shown in the screenshot below.

The screenshot shows the 'Add Rule' dialog box with the following configuration:

Name:	Registered Windows 10	<input checked="" type="checkbox"/> Rule Enabled
Authentication Method:	Any	
User Group:	Any	
End-System Group:	Registered Guests	<input type="checkbox"/> Invert
Device Type Group:	Windows 10	<input type="checkbox"/> Invert
Location Group:	Any	
Time Group:	Any	
Profile:	Windows10	
Portal:	Default	
Zone:	None	

Buttons: Save, Close

- o. Click **Save**.
5. Create a rule that assigns the Default Extreme Access Control Profile to all Linux registered devices and add the SuperLinux version to the Linux family device type. To do this, you need to create a new Linux device type group that includes SuperLinux.
- a. Create the My Linux device type group to include the devices in the Linux device type group using the **Select from Existing Types** button in the Add Entry window as discussed in step 4f above.

**Add New Group**

Name: My Linux

Description: Device Types in Linux Family

Type: Device Type

**Device Type Entry Editor**

Value	Description
Debian	
Fedora	
Linux	
Mandrake	
mandriva	
Red Hat	
Slackware	
Slax	
SUSE	
Ubuntu	

Page 1 of 1 | Reset | Displaying entry 1 - 10 of 10

Save & Close | Save | Cancel

- b. Click the **Add** button and in the Add Entry window, create the **SuperLinux** Device Type as shown below.

**Add Entry**

Device Type: SuperLinux

Entry Description: SuperLinux devices

Select from Existing Types

Add | Cancel

- c. Click **Add** to save the SuperLinux device type to the My Linux device type group.
- d. Click the **Save & Close** button on the Add New Group window.
6. Create a rule that assigns the HP Printer Profile to all HP printers on the network. To do this, create a new HP Printers device type group.
- a. Open the Add New Group window by clicking the **Add** button on the Extreme Access Control Configurations > Group Editor > Device Type Groups panel.

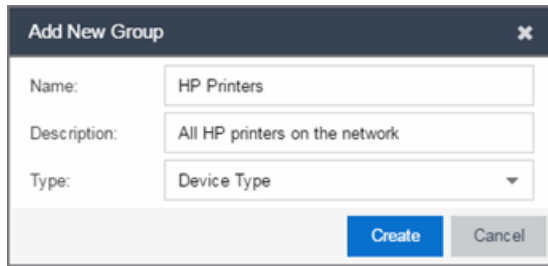

The screenshot shows a dialog box titled "Add New Group". It has three input fields: "Name" with the value "HP Printers", "Description" with the value "All HP printers on the network", and "Type" with a dropdown menu set to "Device Type". At the bottom right, there are two buttons: "Create" (highlighted in blue) and "Cancel".

- b. Click **Create**. The Device Type Entry Editor section appears.
- c. Add the HP Printers via the Add Entry window by clicking the **Add** button as shown below.

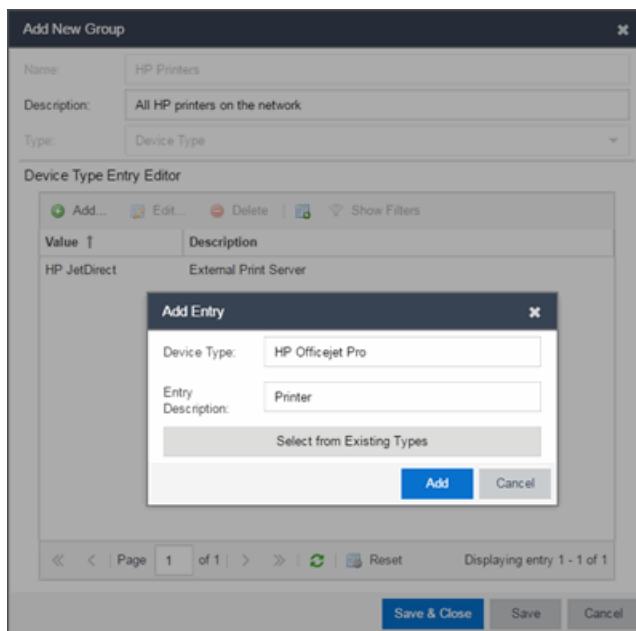

The screenshot shows the "Add New Group" dialog box with the "Device Type Entry Editor" section expanded. The "Add Entry" dialog is open, showing "Device Type" as "HP Officejet Pro" and "Entry Description" as "Printer". There are "Add" and "Cancel" buttons. The background shows a table with columns "Value" and "Description". The table has one entry: "HP JetDirect" with "External Print Server". There are also "Add...", "Edit...", "Delete", and "Show Filters" buttons at the top of the table. At the bottom of the dialog, there are "Save & Close", "Save", and "Cancel" buttons.

- d. Click **Save & Close** to save the HP Printers group.
- e. Select Rules in the left-panel tree (Extreme Access Control Configurations > Default > Rules).
- f. Click **Add** in the right-panel to open the Add Rule window.
- g. Click the New option in the Profile drop-down menu and create the **HP Printer Profile**.

h. Create the HP Printers rule using the following criteria.

Name:	HP Printers	<input checked="" type="checkbox"/> Rule Enabled
Authentication Method:	Any	
User Group:	Any	
End-System Group:	Any	
Device Type Group:	HP Printers	<input type="checkbox"/> Invert
Location Group:	Any	
Time Group:	Any	
Profile:	HP Printer Profile	
Portal:	Default	
Zone:	None	

i. Click **Save**.

7. Your Extreme Access Control Configuration now contains the following rules used to determine network access and assessment requirements based on device type.

---

## Related Information

- [Add/Edit Device Type Group Window](#)
- [Create Rule Window](#)
- [Manage Rule Groups Window](#)

# How to Configure LDAP for End Users and Hosts via Active Directory in Extreme Management Center

This Help topic provides instructions for creating LDAP configurations in Access Control that provide authentication and authorization for network end users and host machines via Active Directory.

In Access Control, you can create an Advanced AAA configuration that contains one mapping rule for your host machines and two mapping rules for your users. These mappings are the same except for their LDAP configuration. You need to create two LDAP configurations: one for the hosts mapping and one for the users mapping. The LDAP configurations are identical except for the User Search Attribute. When you have completed these instructions, Access Control uses the new AAA onfiguration to authenticate both end users and host machines via your Active Directory server.

1. Click **Control > Access Control > Configuration** tab.
2. In the left-panel tree, select the AAA tab to open the AAA Configuration window to the right.

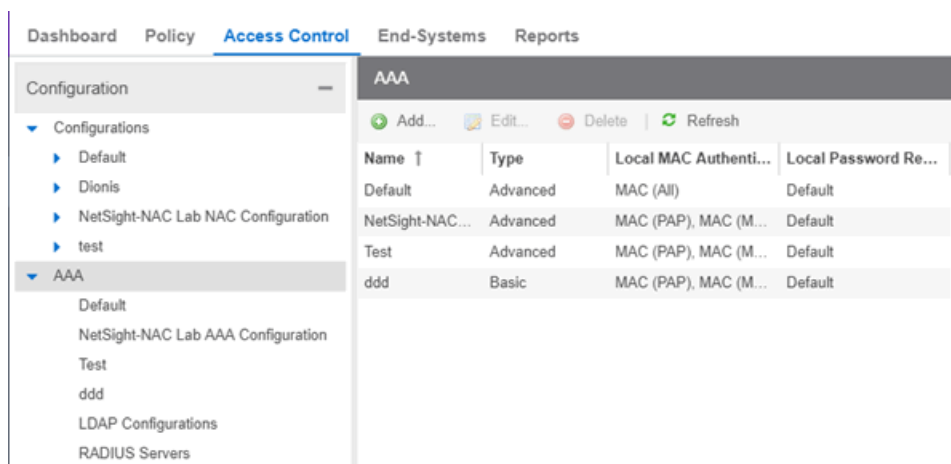

3. Click the **Add** button in the [AAA Configuration panel](#) create a new AAA Configuration.



4. Click LDAP Configuration in the left-panel tree to open the LDAP Configuration window.
5. Create an LDAP configuration for use with end users that authenticate to the network using the sample below as a guide. Click **Save**.



Configuration Name:

---

**LDAP Connection URLs**

Idap://

---

**Authentication Settings**

Administrator Username:

Administrator Password:

Timeout (seconds):

---

**Search Settings**

User Search Root:

Host Search Root:

OU Search Root:

---

**Schema Definition**

User Object Class:

User Search Attribute:

Keep Domain Name for User Lookup:

User Authentication Type:

User Password Attribute:

Host Object Class:

Host Search Attribute:

Use Fully Qualified Domain Name:

OU Object Classes:

---

Test... | Populate Default Values

6. Open the Add LDAP Configuration window to add another LDAP configuration that will be used for host machines that authenticate to the network using the sample below as a guide. Note that the only difference between the two LDAP configurations is the User Search Attribute. Click **Save**.



Configuration Name:

---

**LDAP Connection URLs**

Idap://

---

**Authentication Settings**

Administrator Username:

Administrator Password:

Timeout (seconds):

---

**Search Settings**

User Search Root:

Host Search Root:

OU Search Root:

---

**Schema Definition**

User Object Class:

User Search Attribute:

Keep Domain Name for User Lookup:

User Authentication Type:

User Password Attribute:

Host Object Class:

Host Search Attribute:

Use Fully Qualified Domain Name:

OU Object Classes:

---

Test... | Populate Default Values

- In the left-panel tree, click an AAA Configuration to open the [Advanced AAA Configuration](#) window.
- In the Authentication Rules panel of the Advanced AAA Configuration window, click the **Add** button to open the [Add User to Authentication Mapping](#) window.
- Create your first mapping rule to capture machine authentications using the sample below as a guide. In the example below, **host/\*nac2003.com** will capture the machine authentications for the NAC2003 active directory domain. Be sure to select the host LDAP Configuration that you created. Click OK.

**Edit User to Authentication Mapping** [X]

Authentication Type: 802.1X

User/MAC/Host:  Pattern  Group host/\*nac2003.com

Location: Any

Authentication Method: Proxy RADIUS (Failover)

Primary RADIUS Server: 10.20.80.40

Backup RADIUS Server: None

Tertiary RADIUS Server: None

Quaternary RADIUS Server: None

Inject Authentication Attrs: None

Inject Accounting Attrs: None

LDAP Configuration: NPSTEST Host LDAP Configuration

LDAP Policy Mapping: Default

OK Cancel

- Create your second mapping rule to capture end user authentications using the sample below as a guide. In the example below, **\*@nac2003.com** will capture all users logging in to the NAC2003 active directory domain when they authenticate

with their username in the format <username>@<domain>. Be sure to select the end user LDAP Configuration that you created. Click OK.

**Edit User to Authentication Mapping** ✕

Authentication Type: 802.1X

User/MAC/Host:  Pattern  Group \*@nac2003.com

Location: Any

Authentication Method: Proxy RADIUS (Failover)

Primary RADIUS Server: 10.20.80.40

Backup RADIUS Server: None

Tertiary RADIUS Server: None

Quaternary RADIUS Server: None

Inject Authentication Attrs: None

Inject Accounting Attrs: None

LDAP Configuration: NAC2003 User LDAP Configuration

LDAP Policy Mapping: Default

OK Cancel

11. Create your third mapping rule to capture other end user authentications using the sample below as a guide. In the example below, **NAC2003\\*** will capture all users logging in to the NAC2003 active directory domain when they authenticate with their username in the format <domain>\<username>. Be sure to select the end user LDAP Configuration that you created. Click OK.



**Edit User to Authentication Mapping** [X]

Authentication Type: 802.1X

User/MAC/Host:  Pattern  Group NAC2003\\*

Location: Any

Authentication Method: Proxy RADIUS (Failover)

Primary RADIUS Server: 10.20.80.40

Backup RADIUS Server: None

Tertiary RADIUS Server: None

Quaternary RADIUS Server: None

Inject Authentication Attrs: None

Inject Accounting Attrs: None

LDAP Configuration: NAC2003 User LDAP Configuration

LDAP Policy Mapping: Default

OK Cancel

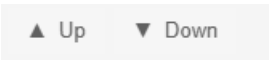
12. In the left-panel tree, click an AAA Configuration to open the [Advanced AAA Configuration](#) window. Use the Up and Down buttons (  ) to move your new mappings above the "Any" mappings in the list of mappings. Click **Save**.

You can configure your LDAP policy mappings and/or LDAP user groups based on the attributes from either your host or user LDAP configurations.

---

## Related Information

For information on related windows:

- [Add User to Authentication Mapping Window](#)
- [AAA Configuration Window](#)

---

## How to Change the Assessment Agent Adapter Password

---

This Help topic provides instructions for changing the password on the assessment agent adapter on your network assessment servers, including agent-less, Nessus, or a third-party assessment agent (an assessment agent not supplied or supported by Extreme Management Center). The assessment agent adapter enables communication between the Extreme Access Control engine and the assessment servers, and the password is used by the assessment agent adapter to authenticate Extreme Access Control engine assessment requests.

This password must match the password specified in the Extreme Access Control Options as the [Assessment Agent Adapter Credentials](#) (Administration > Options > Identity and Access > Assessment Server). If you change the password on the assessment agent adapter, change assessment agent adapter credentials in the Extreme Access Control options as well, or connection between the engine and assessment servers is lost and assessments is not performed.

To change the assessment agent adapter password:

1. Go to the install directory for the assessment agent adapter on the assessment server. This can be a Nessus server or the Extreme Access Control engine if you are using on-board agent-less assessment. On an Extreme Access Control engine, the install directory is `/opt/nac/saint`.
2. Run the `sha1.sh` script (on an Extreme Access Control engine, the script is located in `/opt/nac/saint/util`) using the new password as the argument. The script produces a hash string that looks something like:  
`9ba2db465ff11b0bdfd188f7ee87b10fc3a145dc`
3. Open the `users.properties` file (on an Extreme Access Control engine, the file is located in `/opt/nac/saint/users.properties`) and replace the existing hash string with the new one:  
`admin=<new string>`
4. Restart the assessment agent adapter. On an Extreme Access Control engine, the command is `aglsctl restart`.

## Related Information

For information on related tasks:

- [How to Install the Assessment Agent Adapter on a Nessus Server](#)
- [How to Set Extreme Access Control Options - Assessment Server](#)

For information on related windows:

- [Manage Assessment Settings Window](#)
- [Extreme Access Control Options - Assessment Server](#)

# How to Set Extreme Access Control Options

---

Use the Options window (**Administration > Options**) to set options for Extreme Access Control. In the Options window, the right-panel view changes depending on what you have selected in the left-panel tree. Expand the Extreme Access Control folder in the tree to view all the different options you can set.

Instructions on setting the following Extreme Access Control options:

- [Advanced Settings](#)
- [Assessment Server](#)
- [Data Persistence](#)
- [End-System Event Cache](#)
- [Enforce Warning Settings](#)
- [Features](#)
- [Notification Engine](#)
- [Policy Defaults](#)
- [Status Polling and Timeout](#)

## Advanced Settings

Use the [Advanced Settings panel](#) to configure advanced settings for Extreme Access Control. These settings apply to all users on all clients.

1. Select **Administration > Options** in Extreme Management Center. The Options window opens.
2. In the left-panel tree, expand the Extreme Access Control folder and select Advanced Settings.
3. Use the **Resource Allocation Capacity** option to configure the Extreme Management Center resources allocated to end-system and configuration processing services. The greater the number of end-systems and engines in your Extreme Access Control deployment, the more resources it requires.

- Low - For low performance shared systems.
  - Low-Medium - For medium performance shared systems, or low performance dedicated systems
  - Medium - For medium performance shared systems, or medium performance dedicated systems.
  - Medium-High - For high performance shared systems, or medium performance dedicated systems.
  - High - For high performance dedicated systems.
  - Maximum - For extremely high performance dedicated systems.
4. Use the **Hybrid Mode** option to enable Hybrid Mode for Layer 2 Controllers. Hybrid Mode allows a Layer 2 Extreme Access Control Controller engine to act as a RADIUS proxy for switches, like an Extreme Access Control Gateway engine. Select this option to enable Hybrid Mode for your Layer 2 Controllers at a global level. When the option is selected, the **Configuration** tab for a Layer 2 Controller displays an option to enable Hybrid Mode for that specific controller. Disabling Hybrid Mode at the global level when a controller has switches has a similar effect to deleting a gateway: the switches have the controller removed as a reference.
  5. The **Enable IPv6 Addresses for End-Systems** option allows Extreme Access Control to collect, report, and display IPv6 addresses for end-systems in the end-systems table. When this option is changed, you must enforce your engines before the new settings take effect. In addition, end-systems needs to rediscover their IP addresses in order to reflect the change in the end-system table. This can be done by either deleting the end-system or performing a Force Reauth on the end-system. Only end-systems with a valid IPv4 address as well as one or more IPv6 addresses are supported. End-systems that have only IPv6 addresses are not supported. End-system functionality support varies for IPv6 end-systems. For complete information, see Extreme Access Control Tab Support in the Extreme Management Center Configuration Considerations Help topic.
  6. Click **Save** or select the **Autosave** checkbox.

## Assessment Server

Use the [Assessment Server view](#) to provide assessment agent adapter credentials. The options apply to all users on all clients.

The assessment agent adapter credentials are used by the Extreme Access Control engine when attempting to connect to network assessment servers, including Extreme Networks Agent-less, Nessus, or a third-party assessment server (an assessment server that is not supplied or supported by Extreme Management Center). The password is used by the assessment agent adapter (installed on the assessment server) to authenticate assessment server requests. Extreme Access Control provides a default password you can change, if desired. However, if you change the password here, you need to change the password on the assessment agent adapter as well, or connection between the engine and assessment agent adapter is lost and assessments are not performed. For instructions, see [How to Change the Assessment Agent Adapter Password](#).

1. Select **Administration > Options**. The Options window opens.
2. In the left-panel tree, expand the Extreme Access Control folder and select Assessment Server.
3. Specify the assessment agent adapter credentials.
4. Click **Save** or select the **Autosave** checkbox.

## Data Persistence

Use the [Data Persistence view](#) to customize how Extreme Management Center ages-out or deletes end-systems, end-system events, and end-system health results (assessment results) from the tables and charts in the [End-Systems tab](#). These settings apply to all users on all clients.

1. Select **Administration > Options**. The Options window opens.
2. In the left-panel tree, expand the Extreme Access Control folder and select Data Persistence.
3. In the **Age End-Systems** section, enter the number of days the Data Persistence Check uses as criteria for aging end-systems. Each day, when the Data Persistence check runs, it searches the database for end-systems Extreme Management Center has not received an event for in the number of days specified (90 days by default). It removes those end-systems from the tables in the [End-Systems tab](#).
4. If you select the **Remove Associated MAC Locks and Occurrences in Groups** checkbox, the aging check also removes any MAC locks or group memberships associated with the end-systems being removed. The **Remove Associated**

**Registration Data** checkbox is selected by default, so the aging check also removes any registration data associated with the end-systems being removed.

5. In the **End-System Event Persistence** section, select the checkbox if you want Extreme Management Center to store non-critical end-system events, which are events caused by an end-system reauthenticating. End-system events are stored in the database. Each day, when the Data Persistence check runs, it removes end-system events which are older than the number of days specified (90 days by default).
6. In the **End-System Information Event** section, select the checkbox if you want Extreme Management Center to generate an Extreme Access Control event when end-system information is modified.
7. In the **Health Result Persistence** section, specify how many health result (assessment results) summaries and details are saved and displayed in the [End-Systems tab](#) for each end-system. By default, the Data Persistence check saves the last 30 health result summaries for each end-system along with detailed information for the last five health result summaries per end-system.  
There are two additional options:
  - You can specify to only save the health result details for quarantined end-systems (with the exception of agent-based health result details, which are always saved for all end-systems).
  - You can specify to save duplicate health result summaries and detail. By default, duplicate health results obtained during a single scan interval are **not** saved. For example, if the assessment interval is one week, and an end-system is scanned five times during the week with identical assessment results each time, the duplicate health results are not saved (with the exception of administrative scan requests such as Force Reauth and Scan, which are always saved). This reduces the number of health results saved to the database. If you select this option, all duplicate results are saved.
8. Set the time you would like the Data Persistence Check to be performed each day.
9. In the **Transient End-Systems** section, configure the number of days to keep transient end-systems in the database before they are deleted as part of the nightly database cleanup task. The default value is 1 day. A value of 0 disables the deletion of transient end-systems. Transient end-systems are Unregistered end-systems and have not been seen for the specified number of days. End-systems are not deleted if they are part of an End-System group or there are MAC locks associated with them. Select the **Delete Rejected End-Systems** checkbox if you want end-systems in the



Rejected state to be deleted as part of the cleanup. You can also delete transient end-systems using the Tools > End-System Operations > Data Persistence option.

10. Click **Save** or select the **Autosave** checkbox.

## End-System Event Cache

End-system events are stored daily in the database. In addition, the end-system event cache stores in memory the most recent end-system events and displays them in the [End-System Events tab](#). This cache allows Extreme Management Center to quickly retrieve and display end-system events without having to search through the database. Use the [End-System Event Cache view](#) to configure the amount of resources used by the end-system event cache. This setting applies to all users on all clients.

1. Select **Administration > Options** in the menu bar. The Options window opens.
2. In the left-panel tree, expand the Extreme Access Control folder and select End-System Event Cache.
3. Specify the parameters to use when searching for older events outside of the cache. (The search is initiated by using the **Search for Older Events** button in the [End-System Events tab](#).) The search is ended when any one of the parameters is reached.
  - Maximum number of days to go back when searching
  - Maximum number of results to return from search
  - Maximum time to spend searching for events
4. Specify the number of events to cache. Keep in mind the more events you cache, the faster data is returned, but caching uses more memory.
5. The End-System Event Cache also keeps a secondary cache of events by MAC address. This means a particular end-system's events can be more quickly accessed in subsequent requests. Specify the number of MAC addresses kept in the secondary cache. Keep in mind that the more MAC addresses you cache, the more memory used. Also, note the secondary cache may includes events not in the main cache, but were retrieved by scanning the database outside the cache boundary.
6. Click **Save** or select the **Autosave** checkbox.

## Enforce Warning Settings

Use the [Enforce Warning Settings view](#) to specify warning messages you don't want displayed during the Enforce engine audit.

When an engine configuration audit is performed during an Enforce operation, warning messages may display in the audit results listed in the Enforce window. If an engine has a warning associated with it, you are given the option to acknowledge the warning and proceed with the enforce anyway.

These settings allow you to select specific warning messages that you do not want to have displayed in the audit results. This allows you to proceed with the Enforce without having to acknowledge the warning message. For example, you may have an Extreme Access Control configuration that always results in one of these warning messages. By selecting that warning here, it is ignored in future audit results and you no longer have to acknowledge it before proceeding with the Enforce.

1. Select **Administration > Options** in the menu bar. The Options window opens.
2. In the left-panel tree, expand the Extreme Access Control folder and select Enforce Warnings. The Enforce Warnings view opens.
3. Select the checkbox in the Ignore column next to the warning messages you don't want displayed.
4. Click **Save** or select the **Autosave** checkbox.

## Setting Features Options

Use the [Features view](#) to automatically create new Policy mappings and profiles. If you are not using these features, you can disable them to remove sections that pertain only to those features from certain Extreme Management Center windows.

## Notification Engine Options

Use the [Notification Engine view](#) to define the default content contained in Extreme Access Control notification action messages. For example, with an email notification action, you can define the information contained in the email

subject line and body. With a syslog or trap notification action, you can specify certain information you want contained in the syslog or trap message. These settings apply to all users.

There are certain "keywords" that you can use in your email, syslog, and trap messages to provide specific information. Following is a list of the most common keywords used. For a complete list of available keywords for Extreme Access Control notifications, see the [Keywords](#) Help topic.

- \$type - the notification type.
- \$trigger - the notification trigger.
- \$conditions - a list of the conditions specified in the notification action.
- \$ipaddress - the IP address of the end-system that is the source of the event.
- \$macaddress - the MAC address of the end-system that is the source of the event.
- \$switchIP - the IP address of the switch where the end-system connected.
- \$switchPort - the port number on the switch where the end-system connected.
- \$username - the username provided by the end user upon connection to the network.

1. Select **Administration > Options**. The Options window opens.
2. In the left-panel tree, expand the Extreme Access Control folder and select Notification Engine. The Notification Engine view opens.
3. Use the fields to define the default content contained in notification action messages. For a definition of each field, see the [Notification Engine view](#) Help topic.
4. In the Advanced section, set parameters for the Action and Event queues processed by the Notification engine.
5. Click **Save** or select the **Autosave** checkbox.

## Policy Defaults

Use the [Policy Defaults view](#) to specify a default policy role for each of the four [access policies](#). These default policy roles display as the first selection in the drop-down lists when you create an Extreme Access Control profile. For example, if you specify an Assessment policy called "New Assessment" as the Policy Default, then "New Assessment" automatically displays as the first

selection in the Assessment Policy drop-down list in the [New Extreme Access Control Profile window](#).

Extreme Management Center supplies seven policy role names from which you can select. You can add more policies in the [Edit Policy Mapping window](#), where you can also define policy to VLAN associations for RFC 3580-enabled switches. Once a policy is added, it becomes available for selection in this view.

1. Select **Administration > Options**. The Options window opens.
2. In the left-panel tree, expand the Extreme Access Control folder and select Policy Defaults.
3. Select the desired policies.
  - The **Accept policy** is applied to an end-system when an end-system has been authorized locally by the Extreme Access Control Gateway and has passed an assessment (if an assessment was required), or the "Replace RADIUS Attributes with Accept Policy" option is used when authenticating the end-system.
  - The **Assessment policy** is applied to an end-system while it is being assessed (scanned).
  - The **Failsafe policy** is applied to an end-system when it is in an Error connection state. An Error state results if the end-system's IP address could not be determined from its MAC address, or if there was a scanning error and an assessment of the end-system could not take place.
  - The **Quarantine policy** is applied to an end-system if the end-system fails an assessment.
4. Click **Save** or select the **Autosave** checkbox.

## Status Polling and Timeout

Use the [Status Polling and Timeout view](#) to specify polling and timeout options for Extreme Access Control engines. These settings apply to all users on all clients.

1. Select **Administration > Options**. The Options window opens.
2. In the left-panel tree, expand the Extreme Access Control folder and select Status Polling and Timeout.

3. In the **Extreme Access Control Appliance Enforce Timeout** section, specify the amount of time Extreme Management Center waits for an enforce response from the engine before determining the Extreme Access Control engine is not responding. During an enforce, an Extreme Access Control engine responds every second to report that the enforce operation is either in-progress or complete. Typically, you do not need to increase this timeout value, unless you are experiencing network delays that require a longer timeout value.
  4. In the **Extreme Access Control Inactivity Check** section, you can enable a check to verify end-system Extreme Access Control activity is taking place on the network. If no end-system activity is detected, an Extreme Access Control Inactivity event is sent to the Extreme Access Control Events view. You can use the [Alarms and Events tab](#) to configure custom alarm criteria based on the Extreme Access Control Inactivity event to create an alarm, if desired.
  5. In the **Status Polling** section, select the **Length of Timeout**, which specifies the amount of time Extreme Management Center waits when communicating with Extreme Access Control engines for status polling before determining contact failed. If Extreme Management Center does not receive a response from an engine in the defined amount of time, Extreme Management Center considers the engine to be "down" and the engine icon changes from a green up-arrow to a red down-arrow in the left-panel tree. The engine status refers to Messaging connectivity, not SNMP connectivity. This means that if the engine is "down," Extreme Management Center is not able to enforce a new configuration to it.
  6. Specify the **Polling Interval**, which is the frequency Extreme Management Center polls the Extreme Access Control engines to determine engine status.
  7. Click **Save** or select the **Autosave** checkbox.
- 

## Related Information

For information on related windows:

- [Extreme Access Control Options](#)

## How to Configure Pre-Registration

---

This Help topic describes how to configure and use the Extreme Access Control pre-registration feature as a part of Secure Guest Access or Authenticated Registration. With pre-registration, guest users can be registered in advance and given a username and password, allowing for a more streamlined and simple registration process when the guest user connects to the network. This can be particularly useful in scenarios where guest users are attending a company presentation, sales seminar, or a training session.

Pre-registration allows IT to delegate control of the network registration process to less technical personnel such as company receptionists, administrative assistants, or training personnel. Using the pre-registration web portal, selected personnel can easily register guest users in advance of an event, and print out a registration voucher that provides the guest user with their appropriate registration credentials. The guest user then follows the instructions on the voucher to connect to the corporate network.

This topic includes information and instructions on:

- [Configuring Pre-Registration](#)
- [Pre-Registering Guest Users](#)
  - [Pre-Registering a Single User](#)
  - [Pre-Registering Multiple Users](#)

### Configuring Pre-Registration

Following are instructions for configuring pre-registration in your portal configuration.

1. Open the **Control > Access Control** tab.
2. Select **Portal Configurations > Website Configuration** in the left-panel navigation tree.
3. Click [Secure Guest Access](#) or [Authenticated Registration](#) (depending on the access type you are configuring).

**NOTE:** If neither panel is available in the Website Configuration navigation tree, click Website Configuration in the left-panel and select the appropriate configuration.

**Secure Guest Access**

Introduction Message:

Customize Fields:

---

**Secure Access Settings**

Credential Delivery Method:

SMS Gateway Email:

Message Strings:

Default Expiration:   (0 = never)

Default Max Registered Devices:

Enable Pre-Registration Portal:

Generate Password Characters:

Generate Password Length:

---

**Sponsorship**

End users will be assigned to the Registered Guests group by default. With optional sponsorship, a sponsor can elevate their access. If sponsorship is required, the end user has no access until the sponsor approves.

Sponsorship Mode:

Sponsored Registration Introduction:

Admin/Sponsor Email (Always Notified):

Sponsor Email Field:

Predefined Sponsors:

4. Select the **Enable Pre-Registration Portal** checkbox and specify whether personnel are able to register a single user, multiple users, or both single and multiple users.
5. Set the **Generate Password Characters** and **Generate Password Length** options. Extreme Access Control uses these options when generating passwords for guest users to use when connecting to the network. These settings are shared by Authenticated Registration and Secure Guest Access. Changing it for one access type also changes it for the other.
6. For Authenticated Registration, click on the [Network Settings](#) view to configure the connection URL specified on the Guest User Voucher (for example, www.ExtremeNetworks.com). Enter the URL in the **Redirection To URL** field. For Secure Guest Access, the Guest User Voucher provides instructions for connecting directly to the secure SSID.



7. Click **Save** to save your changes. Enforce your Extreme Access Control Configuration to your engines.
8. Access the Pre-Registration Portal by entering the following URL in a browser window:  
`https://<Extreme Access ControlEngineIP>/pre_registration`



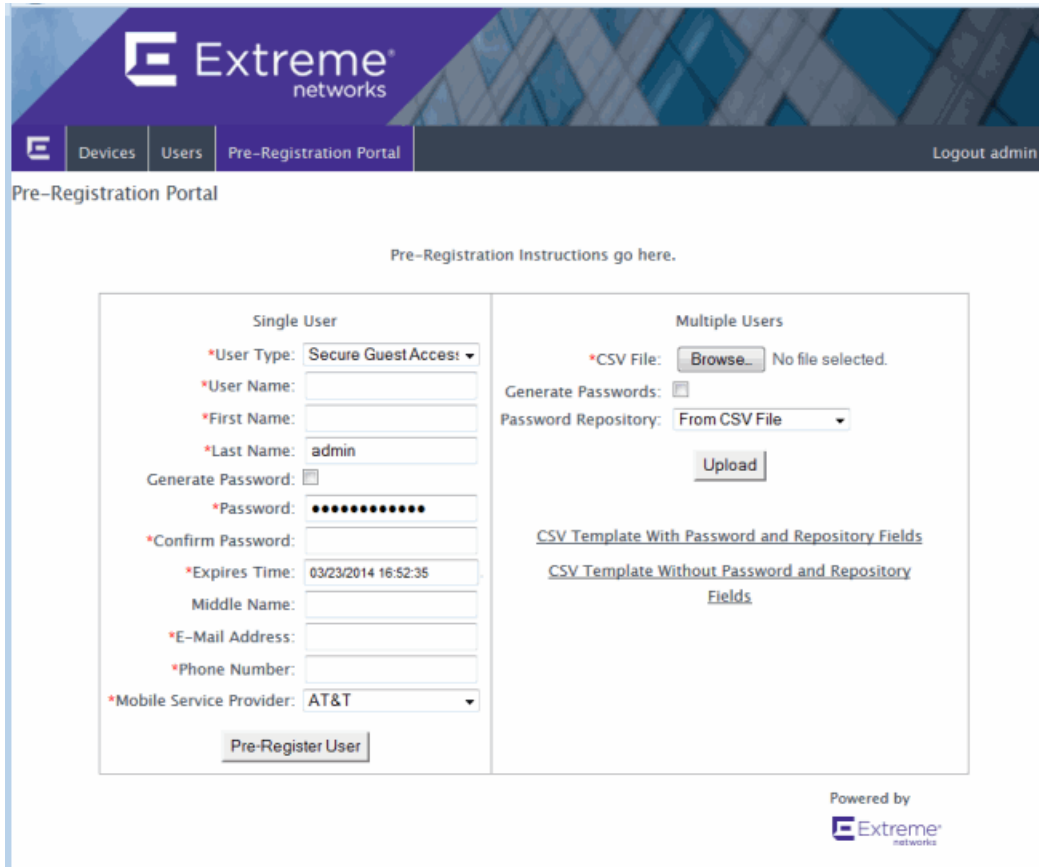

9. At the top of the portal web page are instructions for the people performing the pre-registrations. To modify and edit these instructions:
  - a. In the **Control > Access Control** tab, select I&A Configurations > Portal in the left-panel navigation tree.
  - b. Select a Portal Configuration and select Website Configuration > [Look & Feel](#) to open the Look & Feel panel.

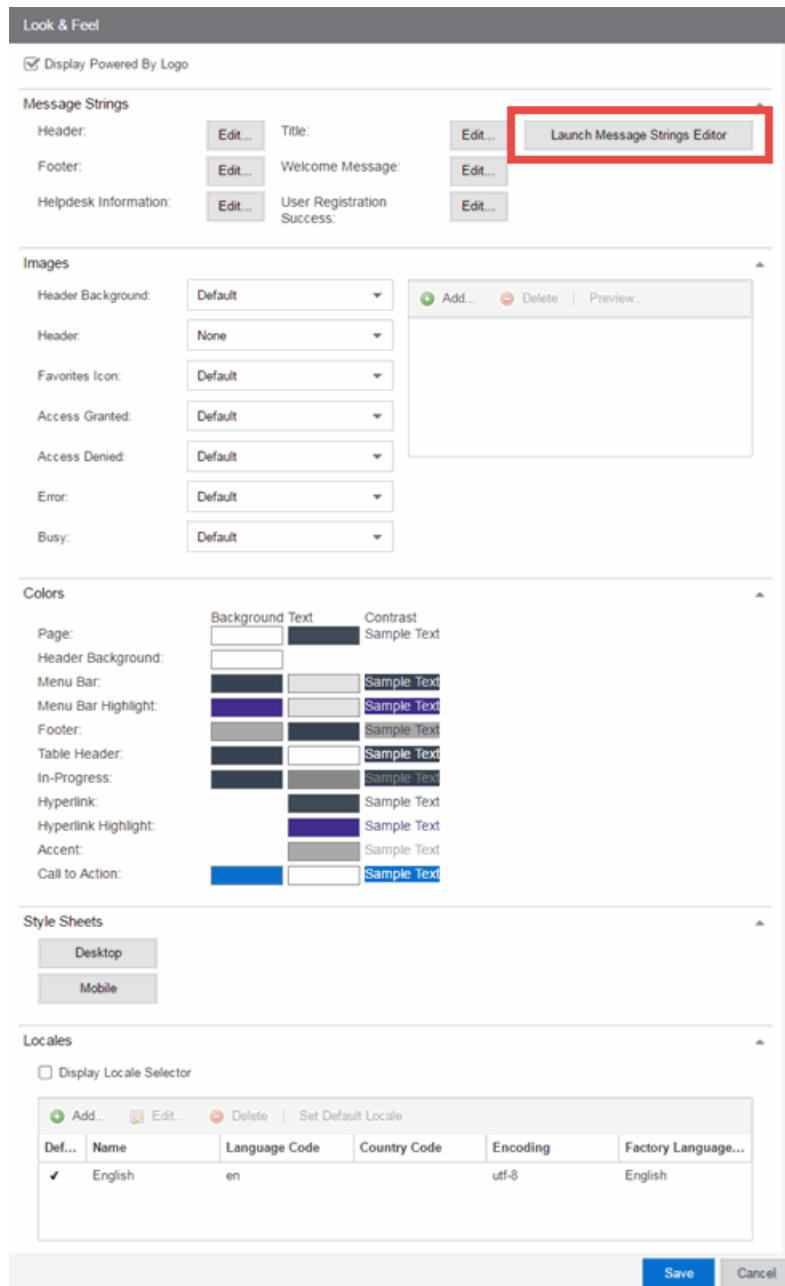

- c. Click on the Message Strings **Launch Message Strings Editor** button. The Message Strings Editor window opens.
- d. Scroll down to the "preregIntroMulti" or "preregIntroSingle" message key and double-click that line. The Modify Localized Entry window opens.

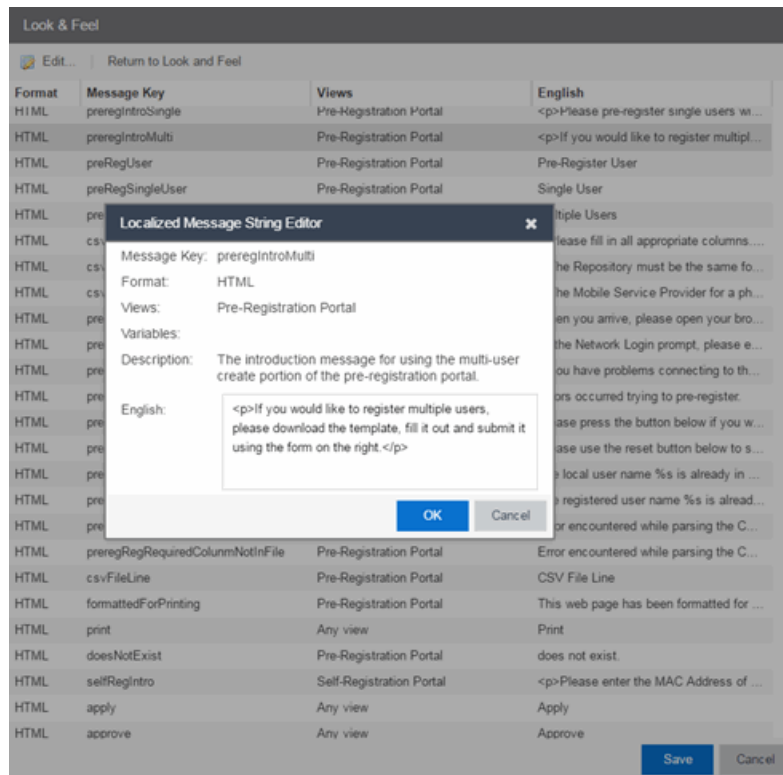

- e. Enter any changes or modifications you wish to make to the instructions, and click **OK** to close the window.
  - f. Enforce the changes to your engines.
  - g. Refresh the browser window to see the new instructions in the Pre-Registration Portal.
10. The following sections provides information on how to pre-register a single user (when you want to pre-register one user at time) or multiple users (when you have a larger group of users to pre-register).

## Pre-Registering Guest Users

After you have configured pre-registration, provide the URL for the Pre-Registration Portal ([https://<Extreme Access ControlEngineIP>/pre\\_registration](https://<Extreme Access ControlEngineIP>/pre_registration)) to the personnel who are pre-registering guests. This may be network administrators or it may be personnel such as company receptionists, administrative assistants, or training personnel. (These users must be configured with administrative login privileges to access the web page).

The following sections provide steps for pre-registering single or multiple users in the Pre-Registration Portal.

## Pre-Registering a Single User

Use the instructions in this section to pre-register a single end user using the Single User panel in the Pre-Registration Portal.

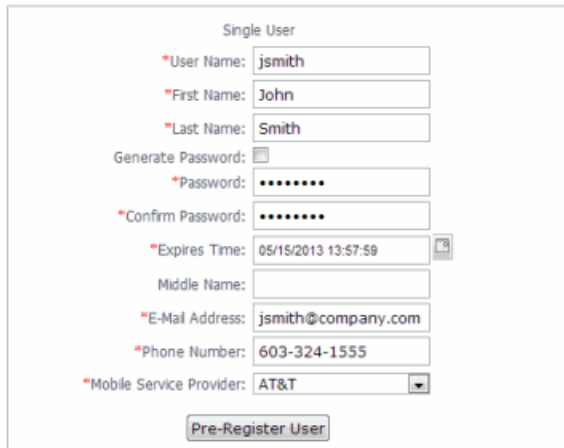

The screenshot shows a web form titled "Single User" with the following fields and values:

- \*User Name: jsmith
- \*First Name: John
- \*Last Name: Smith
- Generate Password:
- \*Password: \*\*\*\*\*
- \*Confirm Password: \*\*\*\*\*
- \*Expires Time: 05/15/2013 13:57:59
- Middle Name: (empty)
- \*E-Mail Address: jsmith@company.com
- \*Phone Number: 603-324-1555
- \*Mobile Service Provider: AT&T

A "Pre-Register User" button is located at the bottom of the form.

1. Enter the information for the guest user you want to pre-register. Fields with a red asterisk are required.
  - User Name — Enter the user name for the guest user when connecting to the network. Usernames must be unique and cannot already exist in the local password repository. Usernames are case sensitive. For example, "JSmith" and "jsmith" would be considered two different usernames.
  - First Name/Last Name — Enter the guest user's first and last name. The name is printed on the voucher along with their registration credentials.
  - Password/Confirm Password — Enter and confirm the password for the guest user connecting to the network. Select the **Generate Password** checkbox if you want Extreme Management Center to automatically generate a password for you.
  - Password Repository — When you pre-register the user, their credentials are automatically added to the local password repository specified here. Local Password Repositories are configured in the [AAA Configuration](#) window. (You only see this field if you have multiple repositories.)

- Expires Time — Select a registration expiration date from the calendar. The time is automatically set to 0:00:00, which is midnight. You can enter a specific time, if desired.

---

**NOTE:** You can add additional fields to be displayed here using the Manage Custom Fields window accessed from the Customize Fields link in the Edit Portal Configuration window's Authenticated Registration view or Secure Guest Access view. However the Pre-Registration web page always displays the First Name and Last Name fields even if they are not selected as visible/required in the Manage Custom Fields window. This is because it is important for the first and last name to be included on the pre-registration voucher printed out.

---

2. Click the **Pre-Register User** button to register the user. The user is added to the local password repository and added to the Registration Administration web page.
  3. A voucher (see [example](#) below) is generated that provides registration instructions and the guest user's registration credentials. Print out this voucher to give to the guest user.
- 

**IMPORTANT:** The voucher must be printed out immediately, as there is no way to go back and print out a voucher once you leave the web page. If you do not print out the voucher, the voucher needs to be created by hand. In the event that the "Generate Password" option was used, you need to modify the guest user password using the registration administration page or local repository administration.

---

4. To register another user, you must re-access the Pre-Registration page by using the browser's back button or re-entering the URL.

## Pre-Registering Multiple Users

Use the instructions in this section to pre-register multiple end users at one time using the Multiple Users panel in the Pre-Registration Portal. When pre-registering multiple users, create a CSV file to provide all the user credential information in table form. Then, upload the file to Extreme Management Center to perform the pre-registration.

Multiple Users

\*CSV File:  No file chosen

Generate Passwords:

Password Repository:

[CSV Template With Password and Repository Fields](#)  
[CSV Template Without Password and Repository Fields](#)

1. Click the CSV Template link to open a template CSV file where you create your list of guest users to pre-register. You can use a CSV template that includes password and password repository fields or not, depending on your network requirements. Do not change any of the column headings in the file.

	A	B	C	D	E	F	G
1	# Please fill in all appropriate columns. If you chose to Generate Passwords the Password column should						
2	# The Password Repository must be the same for all users. Maximum number of users is 50						
3	User Name	Password	Password Repository	First Name	Last Name		
4	User1	password1	Default	John	Smith		
5	User2	password2	Default	Jim	Brown		
6	User3	password3	Default	Susan	Thomas		
7	User4	password4	Default	Allen	Jones		
8	User5	password5	Default	Karen	Simon		
9							
10							
11							
12							
13							
14							

Following is an explanation of the columns that need to be filled in for each user, depending on the template you selected.

- User Name – Enter the username for the guest user connecting to the network. Usernames must be unique and cannot already exist in the local password repository. Usernames are case sensitive. For example, "JSmith" and "jsmith" would be considered two different usernames. (If you do try to pre-register existing usernames along with new usernames, you are notified of the error and given the option to continue registering the new names.)

- Password — Enter the password for the guest user connecting to the network. If you want Extreme Management Center to automatically generate end user passwords, leave the password column blank and select the **Generate Passwords** checkbox on the Multiple Users panel.
- Password Repository — When you pre-register the user, their credentials are automatically be added to the local password repository specified here. Local Password Repositories are configured in the [AAA Configuration](#) window. If you are using the Default repository, you can use the Password Repository drop-down menu (in the Multiple Users section) to select Default, and then you don't have to enter the Password Repository for each entry.
- First Name/Last Name — Enter the guest user's first and last name. The name is printed on the voucher along with their registration credentials.

---

**NOTE:** You can add additional columns to be included in the template using the Manage Custom Fields window accessed from the Customize Fields link in the Edit Portal Configuration window's Authenticated Registration view and Secure Guest Access view, however, the template always displays the First Name and Last Name fields even if they are not selected as visible/required in the Manage Custom Fields window. This is because it is important for the first and last name to be included on the pre-registration voucher you print.

---

2. When you have finished entering the guest user information, save and close the file.
3. Back in the Multiple Users panel, enter the path and filename for the CSV file by using the **Browse** button to browse to the file on your system.
4. If your CSV file includes a Password Repository, use the Password Repository drop-down list to specify whether to use the default repository or the repository specified in the file.
5. Click the **Upload** button. Users are added to the local password repository and to the Registration Administration web page.
6. Individual vouchers (see an [example](#) below) are generated that provide registration instructions and the guest user's registration credentials for each guest user. Print out these vouchers to give to the guest users.

---

**IMPORTANT:** Vouchers must be printed out immediately, as there is no way to go back and print out a voucher once you leave the web page. If you do not print out the vouchers, the vouchers have to be created by hand. In the event that the "Generate Password" option is used, you need to modify the guest user passwords using the registration administration page or local repository administration.

---

7. To register another user, you must re-access the Pre-Registration Portal by using the browser's back button or re-entering the URL.

### Sample Guest User Voucher

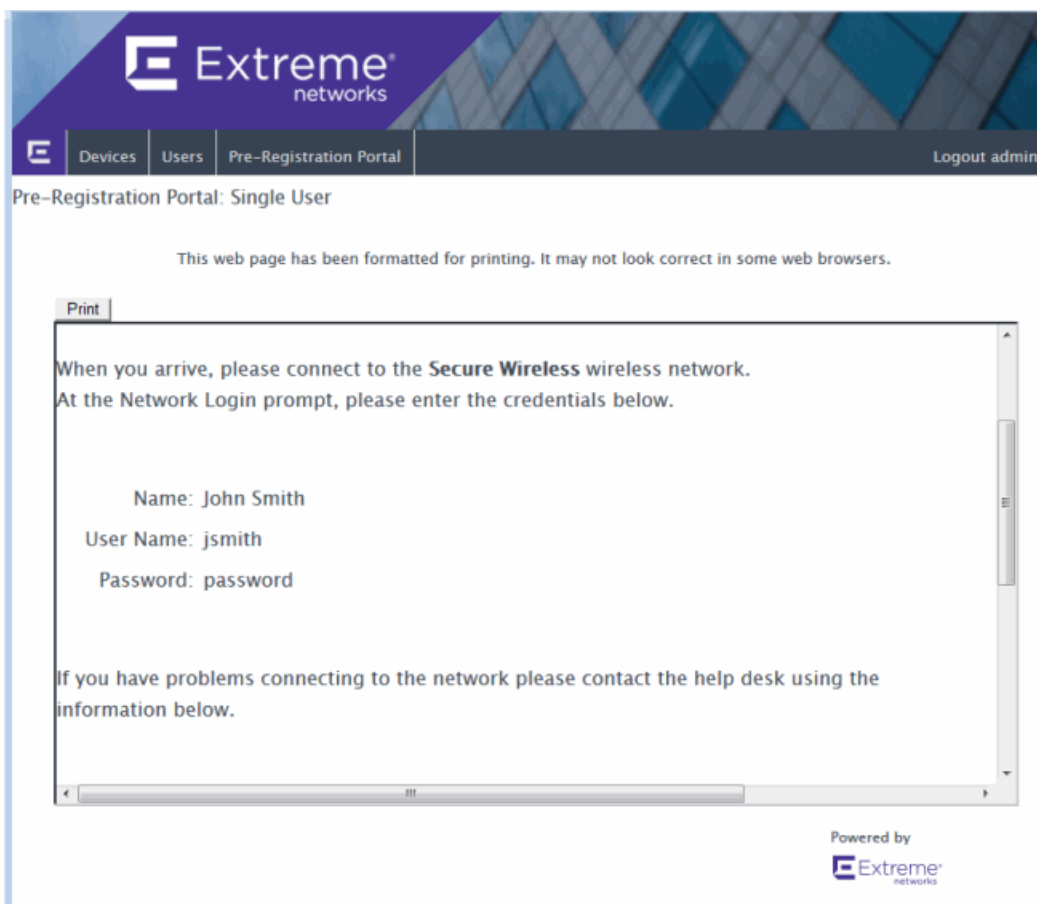

---

### Related Information

- [Portal Configuration](#)



## How to Enable RADIUS Accounting

---

This Help topic describes how to use RADIUS accounting to provide real-time end-system connection status in Extreme Management Center. RADIUS accounting collects various end-system session data that Extreme Management Center uses to determine connection status for each end-system session. This can be useful for compliance purposes, allowing you to determine both when an end-system session started and when it was terminated.

RADIUS accounting is also used to monitor switches for Auto Tracking, CEP (Convergence End Point), and Switch Quarantine authentication sessions, when used in conjunction with the Monitoring or Network Access switch authentication access types. (For more information, see the [Auth. Access Type](#) section of the Add/Edit Switch Window Help topics.)

You must be running Extreme Access Control engine version 4.0 or higher to take advantage of RADIUS accounting functionality in Extreme Management Center.

For Extreme Networks stackable and standalone devices (A-Series, B-Series, C-Series, D-Series, G-Series, and I-Series), Extreme Management Center uses a combination of SNMP and CLI (command line interface) to configure RADIUS accounting on the switch. Before enabling RADIUS accounting on these devices, please read through [Considerations for Fixed Switching Devices](#) below.

**NOTES:** RADIUS accounting is not supported on the Extreme Access Control Controller.

Use the following steps to enable RADIUS accounting:

1. Enable RADIUS accounting on your switches and controllers using the instructions appropriate for your devices.

For Extreme Networks devices or ExtremeWireless Controller devices running firmware version 9.21.x.x or newer:

- a. **If you are editing an existing device:** In the right-panel **Switches** tab, select the devices you want to perform RADIUS accounting and click the **Edit** button. The Edit Switches in Extreme Access Control Appliance Group window opens.  
**If you are adding a new device:** Click **Add** in the right-panel **Switches** tab and

the Add Switches to Extreme Access Control Appliance Group window opens.

**NOTE:** Wireless Controllers must be running in Strict mode to use RADIUS accounting.

- b. Set the RADIUS Accounting option to **Enabled**. Click **OK**.
- c. Enforce to your engines.

**For ExtremeWireless Controller devices running firmware versions older than 9.21.x.x:**

- a. RADIUS accounting must be enabled manually on the controller using the ExtremeWireless Assistant or the device CLI (command line interface).
- b. Be sure to configure the Extreme Access Control engine IP address as the IP address of the RADIUS server. Refer to your wireless controller User Guide for instructions on enabling RADIUS accounting via the ExtremeWireless Assistant, or the CLI Reference Guide for the exact CLI command syntax to use.

**For third-party switching devices:**

- a. RADIUS accounting must be enabled manually on the device using the device CLI (command line interface).
  - b. Be sure to configure the Extreme Access Control engine IP address as the RADIUS accounting server. Refer to your device documentation for the exact command syntax.
2. If you are doing RADIUS accounting in an Extreme Access Control environment where the primary RADIUS server is being used for redundancy in a single Extreme Access Control engine configuration (Basic AAA configuration only), then enable the Proxy RADIUS Accounting Requests option in the Edit RADIUS Server window.
- a. In the Edit Basic AAA Configurations window, use the Configuration Menu button in the Primary RADIUS Server field to open the Manage RADIUS Servers window.
  - b. Select the RADIUS Server and click **Edit**.
  - c. Enable the Proxy RADIUS Accounting Requests option. Click **OK**.
  - d. Enforce to your engine.

With RADIUS accounting enabled, you now see real-time connection status in the Extreme Management Center [End-Systems tab](#) and [Dashboard](#).

## Considerations for Fixed Switching Devices

Extreme Management Center uses a combination of SNMP and CLI (command line interface) to configure RADIUS accounting on Extreme Networks stackable and standalone devices (A-Series, B-Series, C-Series, D-Series, G-Series, and I-Series). Due to a limitation on the SNMP interface, the configuration can be read via SNMP, but must be written to the device via CLI. Before enabling RADIUS accounting on these devices, read through the following considerations.

---

**NOTE:** These considerations do not apply to A4, B5, and C5 devices running firmware version 6.81 and higher. Those devices support RADIUS accounting configuration using SNMP.

---

- The devices must be assigned a Device Access profile that provides Write access and includes CLI credentials for Telnet or SSH. Profiles and CLI credentials are configured using the Authorization/Device Access tool's **Profiles** tab.
- Before you enforce a new RADIUS server configuration to your fixed switching devices, you should verify that your CLI credentials are configured according to the settings in your new configuration. This is because the Enforce process first writes the RADIUS server configuration to the switch using SNMP, and then writes the RADIUS accounting configuration to the switch using Telnet or SSH. If CLI credentials are not configured according to the new RADIUS server configuration, then the RADIUS accounting configuration are not written to the switches.

For example, by default you can Telnet to a fixed switching device using username=admin (with no password or a blank password). But, if you configure a new RADIUS configuration with an Auth Access Type (or Realm Type)=Any, then you may need to change the Device Access for the switches to use the IAS credentials, in order for Extreme Management Center to successfully write the RADIUS accounting information to the switches during Enforce.

Fixed switches only allow one accounting server to be configured. If a primary and secondary Extreme Access Control gateway are configured for the switch, only the primary gateway's accounting configuration is written to the switch. If a secondary gateway is configured, a warning is displayed.

## Considerations for ExtremeXOS Devices

Extreme Management Center uses CLI access to perform RADIUS accounting configuration operations on ExtremeXOS devices. CLI credentials for the device are obtained from the device profile and must be configured in the Authorization/Device Access tool.

---

### Related Information

- [Add Switches to Extreme Access Control Engine Group Window](#)
- [Edit Switches in Extreme Access Control Engine Group Window](#)

## How to Set Up Access Policies and Policy Mappings

---

Access policies define the appropriate level of access to network resources allocated to a connecting end-system based on the end-system's authentication and/or assessment results. There are four access policies defined in an Extreme Access Control profile: Accept policy, Quarantine policy, Failsafe policy, and Assessment policy. When an end-system connects to the network, it is assigned one of these access policies, as determined by the Extreme Access Control profile assigned to the matching Extreme Access Control rule and the end-system state.

In your Extreme Access Control profiles, each access policy is associated to a *policy mapping* that defines exactly how an end-system's traffic is handled when the access policy is applied.

A policy mapping specifies the policy role (created in the **Policy** tab) and other RADIUS attributes included as part of a RADIUS response to a switch. The RADIUS attributes required by the switch are defined in the Gateway RADIUS Attributes to Send field configured in the [Edit Switch window](#). Policy mappings are configured in the [Edit Policy Mapping Configuration window](#).

How you set up your access policies depends on whether your network utilizes Extreme Access Control Controller engines and/or Extreme Access Control Gateway engines. In addition, if your network utilizes Extreme Access Control Gateway engines, your setup depends on whether your network contains EOS switches that support Policy, third-party switches that support RFC 3580, or switches that support RADIUS attributes that are defined manually.

### For Extreme Access Control Controllers:

If your network utilizes Extreme Access Control L2/L3 controller engines, the access policies specified in Extreme Access Control profiles are mapped to policy roles that are defined in a default policy configuration already configured on the controller. It is recommended that you review this default policy configuration using the **Policy** tab. To do this, you must create a policy domain in the **Policy** tab specifically for the Extreme Access Control Controller, assign the Extreme Access Control Controller to the domain, then import the policy configuration from the device into **Policy** tab. Review the policy roles and make

any rule changes required for your environment. When you have finished modifying the policy configuration, you must enforce it back to the Extreme Access Control Controller.

### For Extreme Access Control Gateway Appliances:

If your network utilizes Extreme Access Control Gateway engines, the access policies specified in Extreme Access Control profiles are mapped to policy roles that must be created and defined in the **Policy** tab and enforced to the policy-enabled switches in your network. If you have RFC 3580-enabled switches in your network, Extreme Management Center lets you associate your policy roles to a VLAN ID or VLAN Name using the Policy Mappings panel. This allows your Extreme Access Control Gateway engines to send the appropriate VLAN attribute instead of a policy role to those switches that are RFC 3580-enabled.

Policy mappings have a Location option that allows different VLAN IDs to be returned for a policy based on the location the authentication request originated from. This is useful in networks that may have a VoIP/voice VLAN that is defined on multiple switches, but that VLAN maps to a unique VLAN ID on each switch. (For more information, see the section on Location in the [Edit Policy Mapping Configuration Window](#) Help topic.)

---

**NOTE:** If you have RFC 3580-enabled switches in your network, be sure to verify that the DHCP Resolution Delay Time option is set correctly in your Appliance Settings (Tools > Manage Advanced Configurations > Global and Appliance Settings). This option specifies the number of seconds an Extreme Access Control engine waits after an authentication completes before attempting to resolve the end-system's IP address. When modifying this delay, keep in mind that for RFC 3580 devices, the engine links down/up a port to force the end-system to get a new IP address when Extreme Management Center determines that the VLAN has changed. If the delay time specified is less than the amount of time the end-system needs to renew its IP address, then the Extreme Access Control engine may resolve the end-system's IP address incorrectly (to the previously held IP), or additional delay may be introduced as the resolution process attempts to resolve the address based on the configured retry interval. This is a problem when either registration or assessment is enabled: the registration process may never complete or may take an unacceptable amount of time to complete, or the Extreme Access Control engine could attempt to scan the incorrect IP address. Be sure to take into account the amount of time required for an end-system to get a new IP address when setting the delay time value.

---

## Setting Up Your Access Policies

Before you begin working with the **Access Control** tab, use these steps to define the policy mapping criteria (policy roles, corresponding VLAN IDs, etc.) available for selection for each access policy.

1. For each Extreme Access Control profile, create a worksheet listing the four Extreme Access Control policies. For each access policy, associate a policy role (created in the **Policy** tab), and the policy role's corresponding VLAN ID, if you are using RFC 3580-enabled switches in your network. For a description of each access policy, and some guidelines for creating corresponding policy roles, see the section on [Access Policies](#) in the Concepts file.

---

**NOTE:** If your network uses Extreme Access Control Gateway engines with only RFC 3580-enabled switches, instead of listing policy roles, simply create a list of policy names that correspond to the VLANs you are using in your network. One tip is to use policy names that identify the corresponding VLAN name for ease of selection when you are creating your Extreme Access Control profiles.

---

Here's an example of a worksheet for an Extreme Access Control profile that contains both policy-enabled and RFC 3580 switches:

Access Policy	Policy Role	VLAN ID
Accept Policy	Enterprise User	[2] Enterprise User VLAN
Quarantine Policy	Quarantine	[4] Quarantine VLAN
Failsafe Policy	Failsafe	[5] Failsafe VLAN
Assessment Policy	Assessing - Strict	[6] Assessing - Strict VLAN

2. For Extreme Access Control Controllers, use the **Policy** tab to verify that the policy configuration contains the required policy roles, and that the configuration has been enforced to the Extreme Access Control Controller. See the [instructions](#) above.
3. For Extreme Access Control Gateways, verify each policy role listed on your worksheet is created in Extreme Management Center's **Policy** tab and enforced to the policy-enabled switches in your network. If you have RFC 3580-enabled switches in your network, verify that your VLANs have been created on the switches in your network.

4. Define the policy mappings that map each access policy to the appropriate policy role as specified in your worksheet.
  - a. Select a policy mapping configuration from the Extreme Access Control Configurations > Extreme Access Control Profiles > Policy Mappings left-panel option.
  - b. The Policy Mapping Configuration right-panel opens.

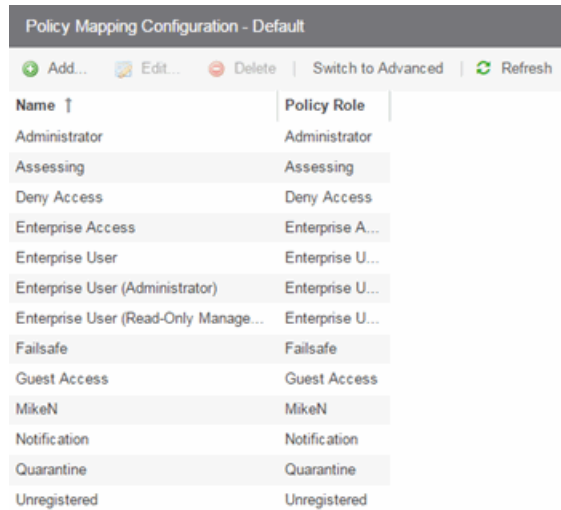

The screenshot shows the 'Policy Mapping Configuration - Default' window. At the top, there are buttons for 'Add...', 'Edit...', 'Delete', 'Switch to Advanced', and 'Refresh'. Below these is a table with two columns: 'Name' and 'Policy Role'.

Name ↑	Policy Role
Administrator	Administrator
Assessing	Assessing
Deny Access	Deny Access
Enterprise Access	Enterprise A...
Enterprise User	Enterprise U...
Enterprise User (Administrator)	Enterprise U...
Enterprise User (Read-Only Manage...	Enterprise U...
Failsafe	Failsafe
Guest Access	Guest Access
MikeN	MikeN
Notification	Notification
Quarantine	Quarantine
Unregistered	Unregistered

- c. Select between a Basic policy mapping and an Advanced policy mapping, depending on your network needs by selecting **Switch to Advanced** or **Switch to Basic** at the top of the panel. Typically, the Basic policy mapping configuration is used unless your devices require customization or when using locations in your mappings.

Extreme Access Control provides a list of default policy mappings you can use. Be aware if you use one of the default mappings, you still need to verify that the policy role specified in the mapping is part of your Extreme Access Control Controller policy configuration and/or is created and enforced to the policy-enabled switches in your network via the **Policy** tab.

- d. To add a new policy mapping, click the **Add** button to open the [Add Policy Mapping window](#).





**Policy Mapping Configuration - Default**

Add Policy Mapping

Name:

Map to Location:

Policy Role:

VLAN [ID] Name:

VLAN Egress:

Filter:

Port Profile:

Virtual Router:

Login-LAT-Group:

Login-LAT-Port:

Custom 1:

Custom 2:

Custom 3:

Custom 4:

Custom 5:

**RADIUS Attribute Lists**

Organization 1:

Organization 2:

Organization 3:

**Management**

Access:

Management:

Mgmt Service Type:

CLI Access:

For the new policy mapping, enter a mapping name and specify a policy role (created in the **Policy** tab) and other required RADIUS attributes included in the RADIUS response to a switch. Click **OK** to add the mapping. Note that the required RADIUS attributes for your switches are defined in the Gateway RADIUS Attributes to Send field configured in the [Edit Switch window](#), as shown below.

- e. Click **OK** to close the Edit Policy Mapping Configuration window.
5. In your Extreme Access Control profile, your policy mappings are available for selection when you define your Accept, Quarantine, Failsafe, or Assessment access policy.
- 

## Related Information

For information on related windows:

- [Edit Policy Mapping Configuration Window](#)
- [Add/Edit Policy Mapping window](#)
- [Access Policies, Concepts](#)

---

# How to Configure Credential Delivery for Secure Guest Access

---

Secure Guest Access provides secure network access for wireless guests via 802.1x PEAP by sending a unique username, password, and access instructions for the secure SSID to guests via an email address or mobile phone (via SMS text). Use the instructions in this Help topic to configure the method used to send guests their credentials and access instructions for the secure SSID.

## Configuration Steps

The Credential Delivery method is configured in your portal configuration. Depending on the method you specify, the appropriate custom fields must be configured for display on the Registration web page, so that end users can enter the required information.

The following table provides a description of each credential delivery method and lists their custom field requirements.

User Verification Method	Description	Custom Field Requirement
Captive Portal	The credential information is displayed on the Registration web page.	There are no Custom Field requirements.
Email	The end user must enter a valid email address on the Registration web page.	The Email Address Custom Field must be set to <b>Required</b> .
SMS Gateway	The SMS Gateway provider must support SMTP API. The SMS Gateway provider converts the email to an SMS text message. The end user must enter a mobile phone number on the Registration web page.	The Phone Number Custom Field must be set to <b>Required</b> .

---

User Verification Method	Description	Custom Field Requirement
SMS Gateway or Email	The SMS Gateway provider must support SMTP API. The SMS Gateway provider converts the email to an SMS text message. The end user must enter a mobile phone number or email address on the Registration web page.	The Phone Number and Email Address Custom Fields must be set to <b>Visible</b> .
SMS Text Message	The mobile provider converts the email to an SMS text message. The end user must enter a valid mobile phone number on the Registration web page.	The Phone Number Custom Field must be set to <b>Required</b> .
SMS Text or Email	The mobile provider converts the email to an SMS text message. The end user must enter a valid mobile phone number or email address on the Registration web page.	The Phone Number and Email Address Custom Fields must be set to <b>Visible</b> .

Use the following steps to configure credential delivery for Secure Guest Access in your portal configuration.

1. In the **Access Control** tab, [access the Portal Configuration](#). Click on the Secure Guest Access selection in the Portal Configuration tree. (If you don't see this selection, click Features in the tree and enable the Secure Guest Access feature.)
2. In the Secure Guest Access panel, use the drop-down menu to select the desired Credential Delivery Method (refer to the [table](#) above).

**Secure Guest Access**

Introduction Message: [Edit...](#)

Customize Fields: [Open Editor...](#)

**Secure Access Settings**

Credential Delivery Method: SMS Text Message

Service Providers: [Edit...](#)

Message Strings: [Edit...](#)

Default Expiration: 30 Days (0 = never)

Default Max Registered Devices: 2

Enable Pre-Registration Portal:  Multi and Single Use

Generate Password Characters: Alpha-Numeric With No Vowels

Generate Password Length: 8

**Sponsorship**

End users will be assigned to the Registered Guests group by default. With optional sponsorship, a sponsor can elevate their access. If sponsorship is required, the end user has no access until the sponsor approves.

Sponsorship Mode: Required

Sponsored Registration Introduction: [Edit...](#)

Admin/Sponsor Email (Always Notified):

Sponsor Email Field: User Specifies Any Email

Predefined Sponsors:

[Save](#) [Cancel](#)

3. If you selected the **SMS Text Message** or the **SMS Text or Email** Credential Delivery method, click the Service Providers **Edit** button to configure the list of mobile service providers from which end users can select on the Registration web page. The Mobile Service Provider List provides a default list of providers that can be edited to include the appropriate service providers for your geographic location.

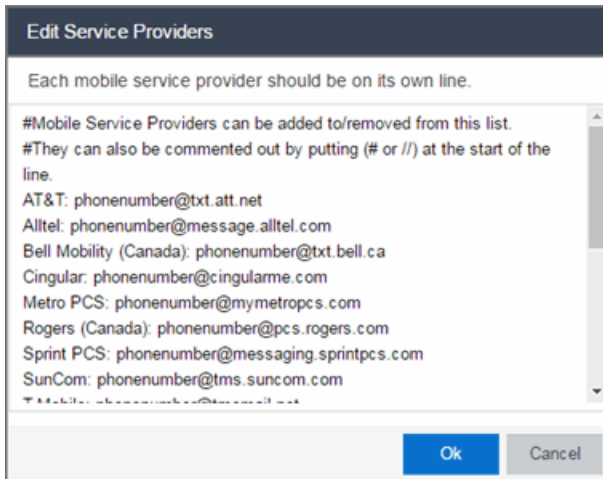

You can comment out entries by preceding each line with either a # or // to allow temporary editing of the file without removing the text.

The list requires one service provider entry per line, using the following format: <Provider>:phonenumber@<specificdomain>.

When the end user registers, they only see the <Provider> portion in the drop-down menu of providers on the Registration web page.

Click **OK** to close the window.

4. If you have selected the **SMS Gateway** or **SMS Gateway or Email** method, enter the SMS Gateway Email address provided by the SMS Gateway provider.

**Secure Guest Access**

Introduction Message: [Edit...](#)

Customize Fields: [Open Editor...](#)

**Secure Access Settings**

Credential Delivery Method:

SMS Gateway Email:

Message Strings: [Edit...](#)

Default Expiration:   (0 = never)

Default Max Registered Devices:

Enable Pre-Registration Portal:

Generate Password Characters:

Generate Password Length:

---

**Sponsorship**

End users will be assigned to the Registered Guests group by default. With optional sponsorship, a sponsor can elevate their access. If sponsorship is required, the end user has no access until the sponsor approves.

Sponsorship Mode:

[Save](#) [Cancel](#)

- For all methods, click on the Message Strings **Edit** button to open the [Message Strings Editor](#) where you can customize the text displayed on the Registration web page and the messages sent to the end user.

**Edit Message Strings**

[Edit...](#)

Format	Message Key	Views	English
HTML	secureGuestAccessMobileProviderF...	Guest Registration or Web Access	Mobile Service Provider
HTML	secureGuestAccessDescr	Guest Registration or Web Access	You will be sent a username and pass...
HTML	secureGuestAccessUserExists	Guest Registration or Web Access	A user was already registered for <b>...
HTML	secureGuestAccessUserExistsError	Guest Registration or Web Access	A user already exists with for <b>%s<...
HTML	secureGuestAccessInstructions	Secure Guest Access Please Wait	Please connect to the %s wireless net...
HTML	secureGuestAccessPreRegInstructi...	Pre-Registration Portal	When you arrive, please connect to th...
Plain Text	secureGuestAccessEmailSentFrom...	Secure Guest Access Please Wait	networkadmin@myco.com
Plain Text	secureGuestAccessEmailSentFrom...	Secure Guest Access Please Wait	Network Administrator
Plain Text	secureGuestAccessEmailSubject	Secure Guest Access Please Wait	Network Instructions

You need to modify different message strings sent to the end user, depending on the delivery method or methods you selected. Double-click on the message to open a window where you can edit the message text.



---

**NOTE:** When customizing message strings for text messaging (SMS Gateway or SMS Text Message) it is best to keep the message length as short as possible (under the maximum 160 characters limit). Some providers break long messages into multiple messages and other providers truncate the message, which could cause important information to be missing from the text message the guest receives.

---

- **Email** — This method uses the following strings:
  - `secureGuestAccessEmailMsgBody` — the default message shouldn't need to be changed.
  - `secureGuestAccessEmailSentFromAddress` — you need to change the default message to the appropriate email address for your company.
  - `secureGuestAccessEmailSentFromName` — the default message shouldn't need to be changed.
  - `secureGuestAccessEmailSubject` — the default message shouldn't need to be changed.
- **SMS Gateway** — Depending on your SMS Gateway provider and their required format, modify the following message strings using appropriate variables to customize the dynamic data such as phone number.
  - `secureGuestAccessSMSMsgBody`
  - `secureGuestAccessSMSSubject`
- **SMS Text Message** — This method uses the following strings. The default messages shouldn't need to be changed.
  - `secureGuestAccessSMSMsgBody`
  - `secureGuestAccessSMSSubject`

Click **OK** to close the window.

6. Click the Customize Fields **Open Editor** button to open the Manage Custom Fields window.

**Secure Guest Access**

Introduction Message: [Edit...](#)

**Customize Fields:** [Open Editor...](#)

---

**Secure Access Settings**

Credential Delivery Method:

SMS Gateway Email:

Message Strings: [Edit...](#)

Default Expiration:   (0 = never)

Default Max Registered Devices:

Enable Pre-Registration Portal:

Generate Password Characters:

Generate Password Length:

---

**Sponsorship**

End users will be assigned to the Registered Guests group by default. With optional sponsorship, a sponsor can elevate their access. If sponsorship is required, the end user has no access until the sponsor approves.

Sponsorship Mode:

[Save](#) [Cancel](#)

7. Set the appropriate custom fields to display on the Registration web page, depending on the delivery method you selected (refer to the [table](#) above). If you do not set these fields, Extreme Access Control automatically sets them for you based on your delivery method.

These settings are shared by Guest Web Access, Guest Registration, and Secure Guest Access. Changing them for one access type also changes them for the others. For more information, see the [Manage Custom Fields Window](#).

Manage Custom Fields

First Name:	Visible	<input checked="" type="checkbox"/> Required	
Middle Name:	Visible	<input type="checkbox"/> Required	
Last Name:	Visible	<input checked="" type="checkbox"/> Required	
Email Address:	Visible	<input checked="" type="checkbox"/> Required	
Phone Number:	Not Visible	<input type="checkbox"/> Required	
1st Custom:	Not Visible	<input type="checkbox"/> Required	Display String
2nd Custom:	Not Visible	<input type="checkbox"/> Required	Display String
3rd Custom:	Not Visible	<input type="checkbox"/> Required	Display String
4th Custom:	Not Visible	<input type="checkbox"/> Required	Display String
5th Custom:	Not Visible	<input type="checkbox"/> Required	Display String
Device Description:	Not Visible	<input type="checkbox"/> Required	Display String

Acceptable Use Policy

Policy Text:

Display

Note: Custom Display String fields are common between Unauthenticated and Authenticated Registration types. Modifying a Display String for one Registration type will affect the Display String in the other.

Only the Name, Email, and Acceptable Use Policy fields apply to Facebook

8. Click **OK** to close the window.
9. Back in the Portal Configuration, click **Save** to save your changes.
10. Enforce the new portal configuration to your engine(s).

Credential delivery is now configured for your secure guest access.

## How Secure Guest Access Works

When a guest attempts to access the network, the Registration web page asks for their email address and/or phone number, and any other required/configured information.

Welcome to the Enterprise Registration Center

You have been **denied** network access because this device is not registered to the network.

To obtain network access, you **must** complete registration using the form below

By registering to the network, you are **agreeing** to the terms and conditions explained in the [Enterprise Network and Computer Acceptable-Use Policy](#)

---

First Name*	
Middle Name	
Last Name*	
E-Mail Address*	
Phone Number*	
Mobile Service Provider*	AT&T ▼

**Complete Registration**

Please press the Complete Registration button only once.

When they click the **Complete Registration** button, they see the following screen that notifies them to check their email or phone for instructions on how to gain access to the network.

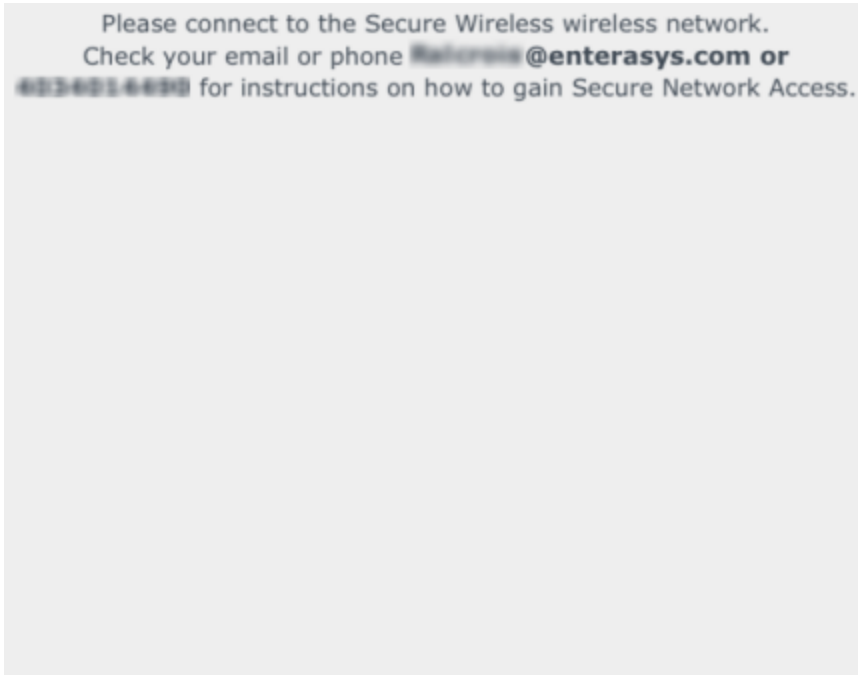

They are sent a username, password, and access instructions via an email or a phone text message.

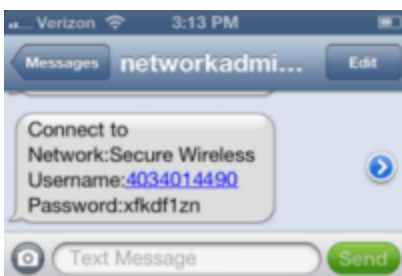
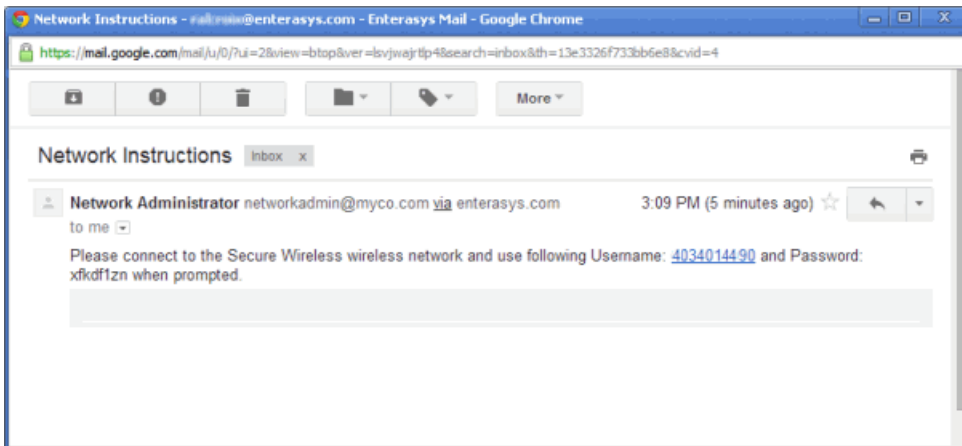

When they connect to the Secure Wireless network, they will enter their username and password in this screen to gain access to the network.

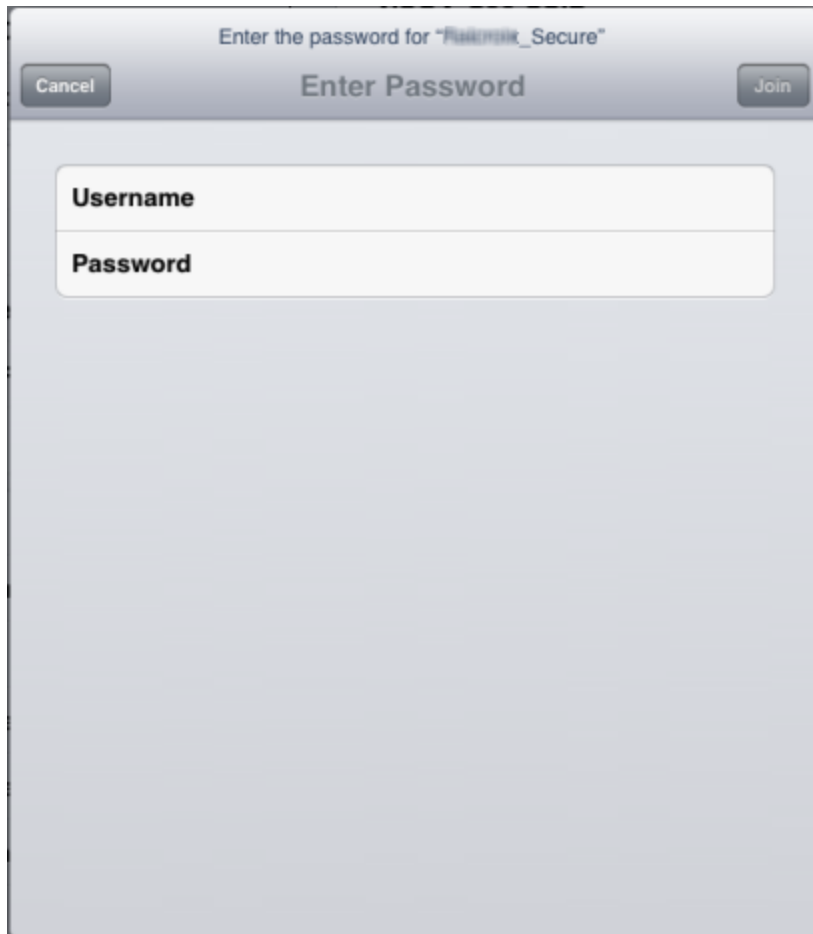

The screenshot shows a mobile application interface for entering a password. At the top, the text reads "Enter the password for 'Rakimik\_Secure'". Below this, there are two buttons: "Cancel" on the left and "Join" on the right. The main area is titled "Enter Password" and contains two input fields: "Username" and "Password". The "Password" field is currently empty and has a small eye icon to its right, indicating it is a password field. The background is a light gray gradient.

---

### Related Information

For information on related help topics:

- [Portal Configuration](#)

## How to Configure Verification for Guest Registration

Guest registration requires end users to enter their name and contact information on a Registration web page in order to gain access to the network. However, in many cases, end users provide false names and contact information because they don't want their personal information to be used for other purposes. In those cases, network administrators do not have a way to contact the user in the event of an Acceptable Use Policy (AUP) violation or in the case of an emergency.

With verification, guest end users registering to the network are required to enter a verification code that is sent to their email address or mobile phone (via SMS text) before gaining network access. This ensures that network administrators have at least one way to contact the end user.

### Configuration Steps

The verification feature is supported for both Guest Registration and Guest Web Access, and is configured using the Verification Method options in your portal configuration. Depending on the verification method you specify, the appropriate custom fields must be configured for display on the Registration web page, so that end users can enter the required information.

The following table provides a description of each verification method and lists their custom field requirements.

User Verification Method	Description	Custom Field Requirement
Email	The end user must enter a valid email address on the Registration web page or Guest Web Access login page.	The Email Address Custom Field must be set to <b>Required</b> .

User Verification Method	Description	Custom Field Requirement
SMS Gateway	The SMS Gateway provider must support SMTP API. The SMS Gateway provider converts the email to an SMS text message. The end user must enter a mobile phone number on the Registration web page or Guest Web Access login page.	The Phone Number Custom Field must be set to <b>Required</b> .
SMS Gateway or Email	The SMS Gateway provider must support SMTP API. The SMS Gateway provider converts the email to an SMS text message. The end user must enter a mobile phone number or email address on the Registration web page or Guest Web Access login page.	The Phone Number and Email Address Custom Fields must be set to <b>Visible</b> .
SMS Text Message	The mobile provider converts the email to an SMS test message. The end user must enter a valid mobile phone number on the Registration web page or Guest Web Access login page.	The Phone Number Custom Field must be set to <b>Required</b> .
SMS Text or Email	The mobile provider converts the email to an SMS test message. The end user must enter a valid mobile phone number or email address on the Registration web page or Guest Web Access login page.	The Phone Number and Email Address Custom Fields must be set to <b>Visible</b> .

Use the following steps to configure verification in your portal configuration.

1. In Extreme Management Center, [access the Portal Configuration](#). Click on the Guest Registration or Guest Web Access selection in the Portal tree, depending on what access type your network is using. (If you don't see these selections, click Website Configuration in the tree and enable the appropriate feature.)



2. In the Guest Registration or Guest Web Access panel, use the drop-down menu to select the desired Verification Method (refer to the [table](#) above). The Guest Registration panel is shown below.

The screenshot shows the 'Guest Registration' configuration interface. At the top, there are buttons for 'Edit...' and 'Open Editor...'. Below that is a 'Redirection' section with a dropdown menu set to 'To User's Requested URL'. The 'Registration Settings' section is highlighted with a red border and contains the following elements:

- Verification Method:** A dropdown menu currently set to 'Disabled'.
- Default Expiration:** A numeric input field set to '30' and a unit dropdown set to 'Days', with '(0 = never)' as a note.
- A list of registration providers, each with an unchecked checkbox:
  - Facebook Registration
  - Google Registration
  - Microsoft Registration
  - Yahoo Registration
  - Salesforce Registration
  - Provider 1 Registration
  - Provider 2 Registration

Below the registration settings is the 'Sponsorship' section, which includes a note: 'End users will be assigned to the Registered Guests group by default. With optional sponsorship, a sponsor can elevate their access. If sponsorship is required, the end user has no access until the sponsor approves.' and a dropdown menu for 'Sponsorship Mode' set to 'None'.

3. If you selected the **SMS Text Message** or the **SMS Text or Email User Verification** method, click the Service Providers link to configure the list of mobile service providers from which end users can select on the Registration web page or Guest Web Access login page. The Mobile Service Provider List provides a default list of providers that can be edited to include the appropriate service providers for your geographic location.

You can comment out entries by preceding each line with either a # or // to allow temporary editing of the file without removing the text.

The list requires one service provider entry per line, using the following format:  
 <Provider>:phonenumber@<specificdomain>.

When the end user registers, they will see only the <Provider> portion in the drop-down list of providers on the Registration web page.

Click **OK** to close the window.

4. If you have selected the **SMS Gateway** or **SMS Gateway or Email** method, enter the SMS Gateway Email address provided by the SMS Gateway provider.
5. For all methods, click on the Message Strings link to open the Message Strings Editor where you can customize the text displayed on the Registration web page or Guest Web Access login page, and the messages sent to the end user.

You need to modify different message strings sent to the end user, depending on the verification method or methods you selected. Double-click on the message to open a window where you can edit the message text.

- **Email** - This method uses the following strings:
  - registrationVerificationEmailMsgBody - the default message shouldn't need to be changed.
  - registrationVerificationEmailSentFromAddress - you need to change the default message to the appropriate email address for your company.
  - registrationVerificationEmailSentFromName - the default message shouldn't need to be changed.
  - registrationVerificationEmailSubject - the default message shouldn't need to be changed.
- **SMS Gateway** - Depending on your SMS Gateway provider and their required format, modify the following message strings using appropriate variables to customize the dynamic data such as phone number.
  - registrationVerificationSMSMsgBody
  - registrationVerificationSMSSubject
- **SMS Text Message** - This method uses the following strings. The default messages shouldn't need to be changed.
  - registrationVerificationSMSMsgBody
  - registrationVerificationSMSSubject

Click **OK** to close the window.

6. In the Web Page Customizations (Shared) section, click the Customize Fields link to open the Manage Custom Fields window.

- Set the appropriate custom fields to display on the Registration web page or Guest Web Access login page, depending on the verification method you selected (refer to the [table](#) above). When you save your portal changes, the correct configuration of the custom fields are verified. These settings are shared by Guest Web Access, Guest Registration, and Secure Guest Access. Changing them for one access type also changes them for the others. For more information, see the [Manage Custom Fields Window](#).

Click **OK** to close the window.

- Back in the Portal Configuration, click **Save** to save your changes. Close the Portal Configuration window. Enforce the new portal configuration to your engine(s). Verification is now configured for your guest registration.

## How User Verification Works

When a guest attempts to access the network, the Registration web page or Guest Web Access login page asks for their email address and/or phone number and mobile service provider, along with their normal contact information.

Welcome to the Enterprise Registration Center



You have been **denied** network access because this device is not registered to the network.

To obtain network access, you **must** complete registration using the form below

By registering to the network, you are **agreeing** to the terms and conditions explained in the [Enterprise Network and Computer Acceptable-Use Policy](#)

You will be **required** to enter in a verification code that will be sent to your specified contact information.

**Company's Acceptable Use Policy**

**Introduction**

This Acceptable Use Policy (AUP) sets forth the principles that govern the use by customers of the Web-based products and services provided by Company. This AUP is designed to help protect our customers, and the Internet community, from irresponsible, abusive or illegal activities.

\*First Name:

Middle Name:

\*Last Name:

E-Mail Address:

Phone Number:

\*Mobile Service Provider:

\*I agree to the Acceptable Use Policy

Please press the Complete Registration button only once.

When they click the **Complete Registration** button, they are sent a verification code via an email or a phone text message.

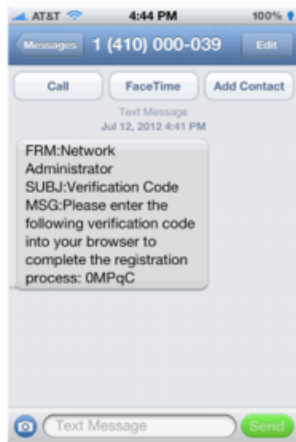
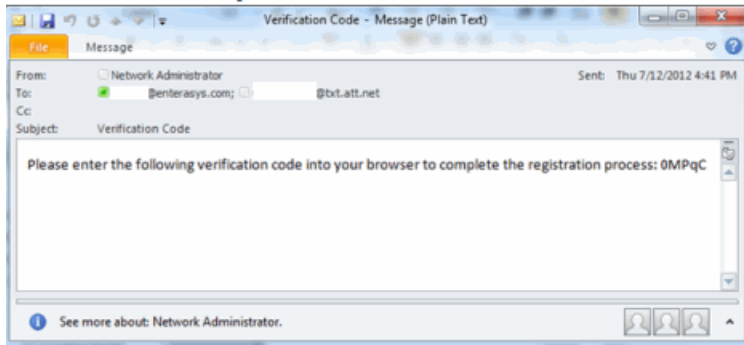

The web page then prompts them for the code. When they enter the correct code that was generated for them and click the **Complete Registration** button, they are allowed access to the network. The verification code is valid for 15 minutes and cannot be reused once it is validated.

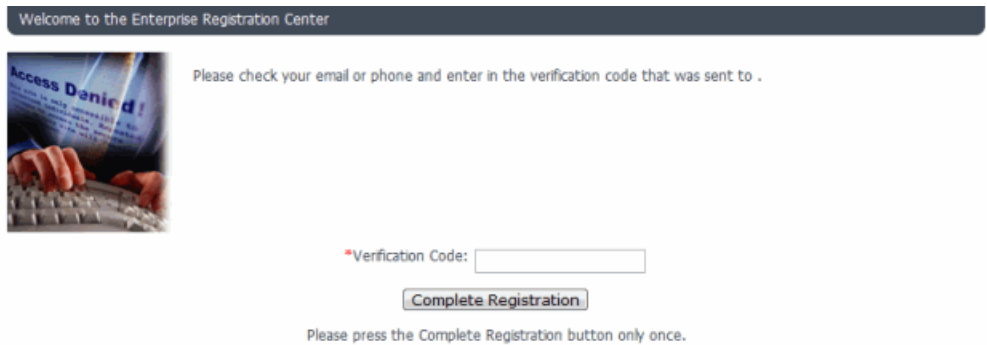

## **Related Information**

For information on related help topics:

- [Portal Configuration](#)

## How to Configure Sponsorship for Guest Registration

---

This topic describes how to configure sponsorship for Guest Registration and Secure Guest Access. Sponsorship is configured as part of your portal configuration, and is accessed from the Guest Registration and Secure Guest Access views in the Portal section of the [Portal Configuration panel](#).

With sponsored registration, end users are only allowed to register to the network when approved by a "sponsor," an internal trusted user to the organization. Sponsorship can provide the end user with a higher level of access than just guest access and allows the sponsor to fine-tune the level of access for individual end users. The end user registers and declares a sponsor's email address. The sponsor is notified and approves the registration, and can assign an elevated level of access, if desired.

To configure sponsorship:

1. Access the **Control > Access Control** tab.
2. In the left-panel tree, expand the **Access Control** Configurations > Portal and click on the [Guest Registration](#) view or the [Secure Guest Access](#) view (depending on the access type you are configuring). The screenshot below shows the Guest Registration view.

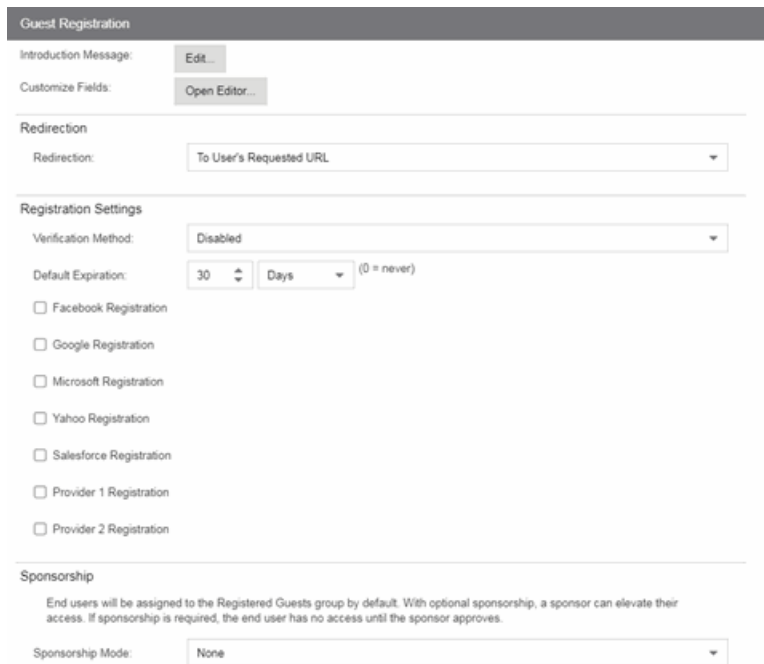

**Guest Registration**

Introduction Message: [Edit](#)

Customize Fields: [Open Editor...](#)

**Redirection**

Redirection:

**Registration Settings**

Verification Method:

Default Expiration:   (0 = never)

Facebook Registration

Google Registration

Microsoft Registration

Yahoo Registration

Salesforce Registration

Provider 1 Registration

Provider 2 Registration

**Sponsorship**

End users will be assigned to the Registered Guests group by default. With optional sponsorship, a sponsor can elevate their access. If sponsorship is required, the end user has no access until the sponsor approves.

Sponsorship Mode:

3. In the Sponsorship section, select the **Sponsorship Mode** required. Additional settings display when you select optional or required sponsorship.
  - **None** - Sponsorship is not required and the end user is assigned to the Registered Guests End-System Group.
  - **Optional** - The end user is assigned to the Registered Guests End-System Group until sponsored. At that time, the sponsor can assign elevated access, if desired.
  - **Required** - The end user has no access until the sponsor approves the registration. The end user is added to the Registration Pending Access end-system group and is presented the sponsorship pending page until approved.
4. **Sponsored Registration Introduction** - Click the **Edit** button to open a window where you can edit the introductory message displayed to the end user.
5. **Admin/Sponsor Email** - Enter the person or group to notify when an end user requests sponsorship, typically the network Extreme Access Control administrator, for example "IT@CompanyA.com." This email address is always notified, in addition to the sponsor email address entered by the end user when they register to the network.
6. **Sponsor Email Field** - Select an option for the sponsor email field on the registration web page.

- **Do Not Display** - The field is not displayed, and the end user is not required to enter a sponsor email address. In this case, only the admin/sponsor email address (defined above) is notified when the end user registers.
  - **Display Predefined Sponsor List** - The end user must select a sponsor email from a list of predefined sponsors (defined below). The end user sees a drop-down menu of sponsor email addresses and select the appropriate sponsor.
  - **User Specifies Any Email as Sponsor** - The end user can enter any email address as a sponsor's email address.
  - **User Must Specify Predefined Sponsor Email** - The end user must enter an email address that matches one of the predefined sponsors (defined below).
7. **Predefined Sponsors** - Enter one or more sponsor email addresses. If you have selected **Display Predefined Sponsor List** as your Sponsor Email Field option (above), these addresses are presented to the end user as a drop-down menu, allowing them to select a sponsor email address. If you have selected **User Must Specify Predefined Sponsor Email** as your Sponsor Email Field option, then the sponsor email address entered by the end user must match an email address listed here. Email addresses can be separated by semi-colons (;) or commas (,) for example, jdoe@CompanyA.com;rsmith@CompanyA.com. Because commas are accepted separators, they should not be used in actual email addresses.
8. In the Portal Configuration window, click **Save** to save your changes. You need to enforce the new portal configuration to your engine(s).
- 

## Related Information

For information on related help topics:

- [Portal Configuration](#)



# How to Implement Facebook Registration

---

This Help topic describes the steps for implementing guest registration using Facebook as a way to obtain end user information.

In this scenario, the Guest Registration portal provides the option to register as a guest or log into Facebook in order to complete the registration process. If the end user selects the Facebook option, Extreme Management Center OAuth to securely access the end user's Facebook account, obtain public end user data, and use that data to complete the registration process.

---

**NOTE:** Guest OAuth (e.g. Google, Yahoo) may not support native mobile browsers and display a "user agent" error. To access the network, use a standard browser application (e.g. Google Chrome).

---

Guest Registration using Facebook has two main advantages:

- It provides Extreme Management Center with a higher level of user information by obtaining information from the end user's Facebook account instead of relying on information entered by the end user.
- It provides an easier registration process for the end user. Extreme Management Center retrieves the public information from the end user's Facebook account and uses that information to populate the name and email registration fields.

This topic includes information and instructions on:

- [Requirements for Facebook Registration](#)
- [Creating a Facebook Application](#)
- [Portal Configuration for Facebook](#)
- [How Facebook Registration Works](#)
- [Special Deployment Considerations](#)
  - [Networks using DNS Proxy](#)

## Requirements

These are the configuration requirements for Facebook Registration.

- The Extreme Access Control engine must have Internet access in order to retrieve user information from Facebook.
- The Extreme Access Control Unregistered access policy must allow access to the Facebook site (either allow all SSL or make allowances for Facebook servers).
- A Unique Facebook application must be created on the Facebook Developers page (see instructions below).
- The Portal Configuration must have Facebook Registration enabled and include the Facebook Application ID and Secret (see instructions below).

## Creating a Facebook Application

When implementing guest registration using Facebook, you must first create a Facebook application. This generates an Application ID and Application Secret that are required as part of the Extreme Management Center OAuth process. Use the following steps to create a Facebook application.

1. Access the Facebook Developers page at <https://developers.facebook.com/apps/>. If you already have a Developers account you can log in, otherwise you must create a Developers account.
2. Once logged in, click the **Add a New App** button.

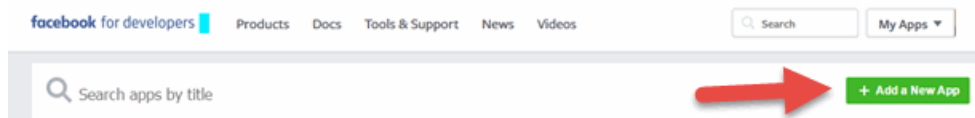

The Add a New App window opens.

3. Click the **basic setup** link at the bottom of the window.

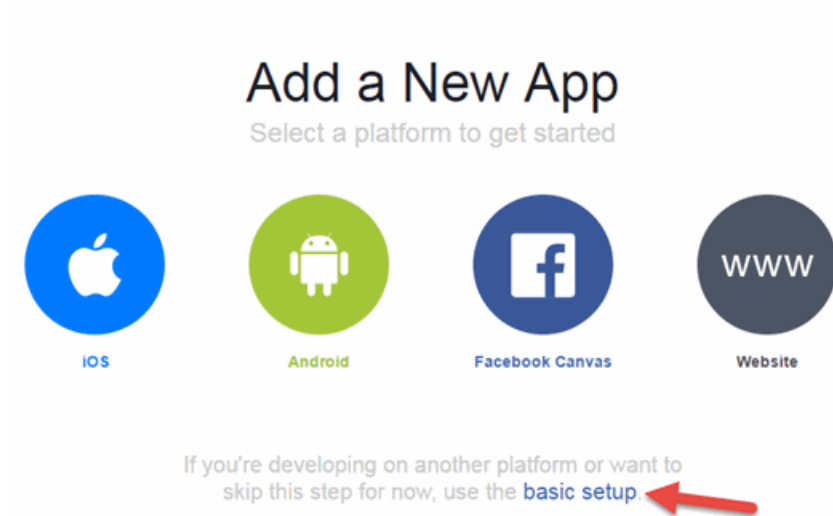

The Create a New App ID window opens.

4. Enter a **Display Name**, enter a **Contact Email**, and select a **Category** for your app.

The **Display Name** is the name of the app presented to the end-user when they grant Extreme Management Center access to their Facebook information and should clearly indicate what its purpose is, for example, Extreme Networks Guest Registration.

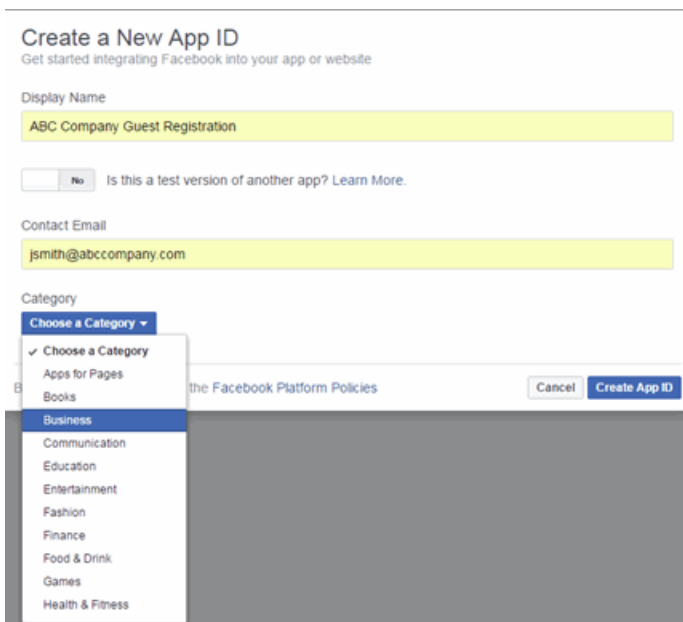

5. Click **Create App ID**.

The Dashboard panel opens and displays information about the new app including an App ID and an App Secret.

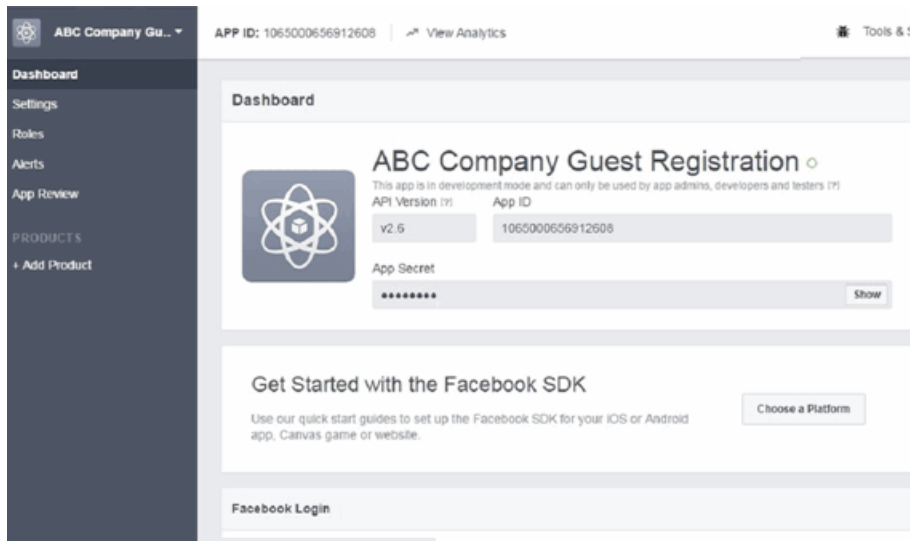

6. Select **Settings** in the left panel.

The Settings panel's **Basic** tab opens.

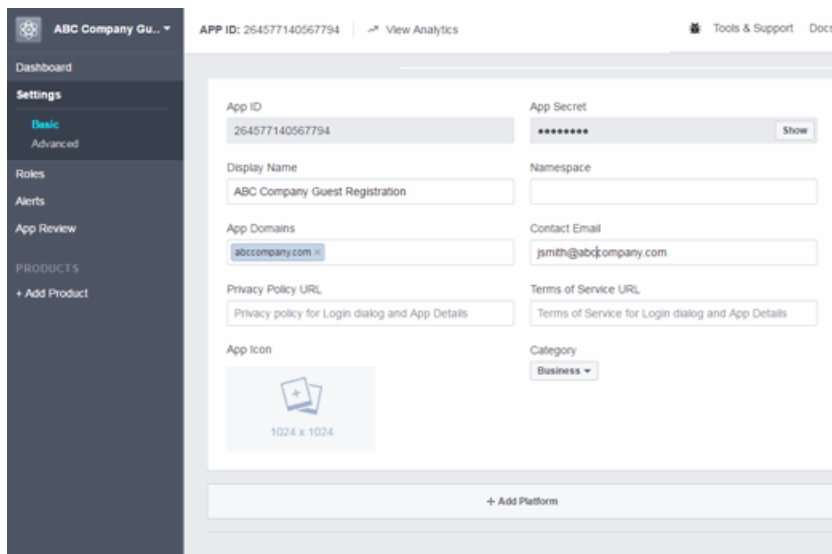

7. Enter in a valid domain name for the Extreme Access Control engines in the **App Domains** field. For example, if the Extreme Access Control engine to which users are

connecting is Extreme Access Control engine.AbcCompany.com, enter "abccompany.com" in the **App Domains** field.

8. Click **Add Platform**.

The Select Platform window opens.

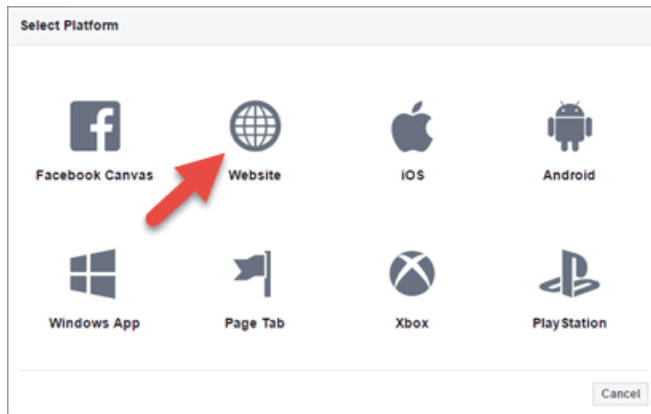

9. Select **Website**.

The Website panel displays on the **Basic** tab.



10. Enter the domain name you added in the **App Domains** field in step 7 in the **Site URL** field.
11. Click **Save Changes**.
12. Click **Add Product** in the left panel.

The Product Setup panel opens.

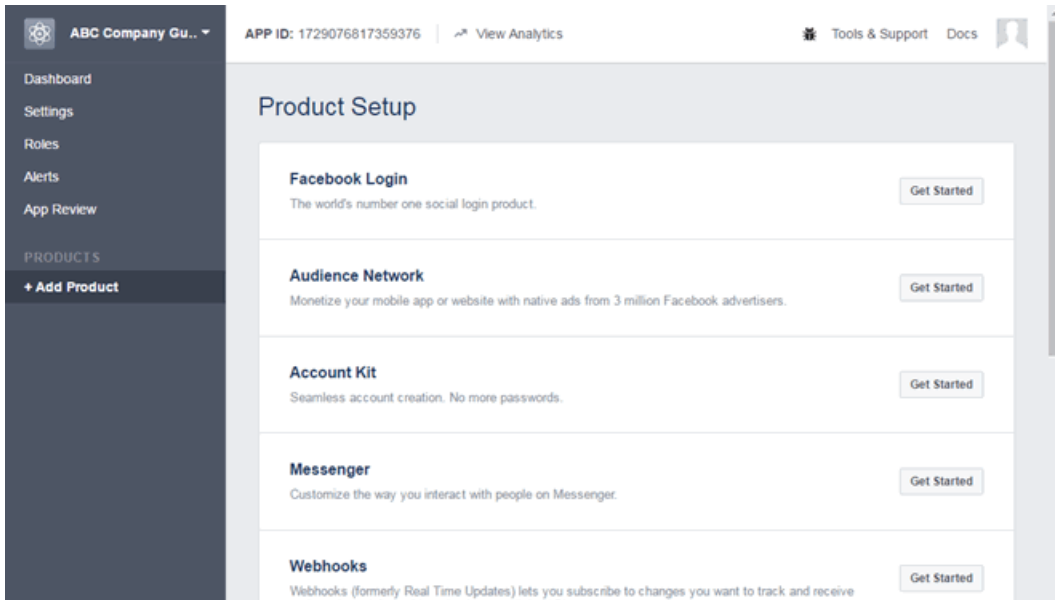

13. Click the Facebook Login **Get Started** button.

The Getting Started panel opens.

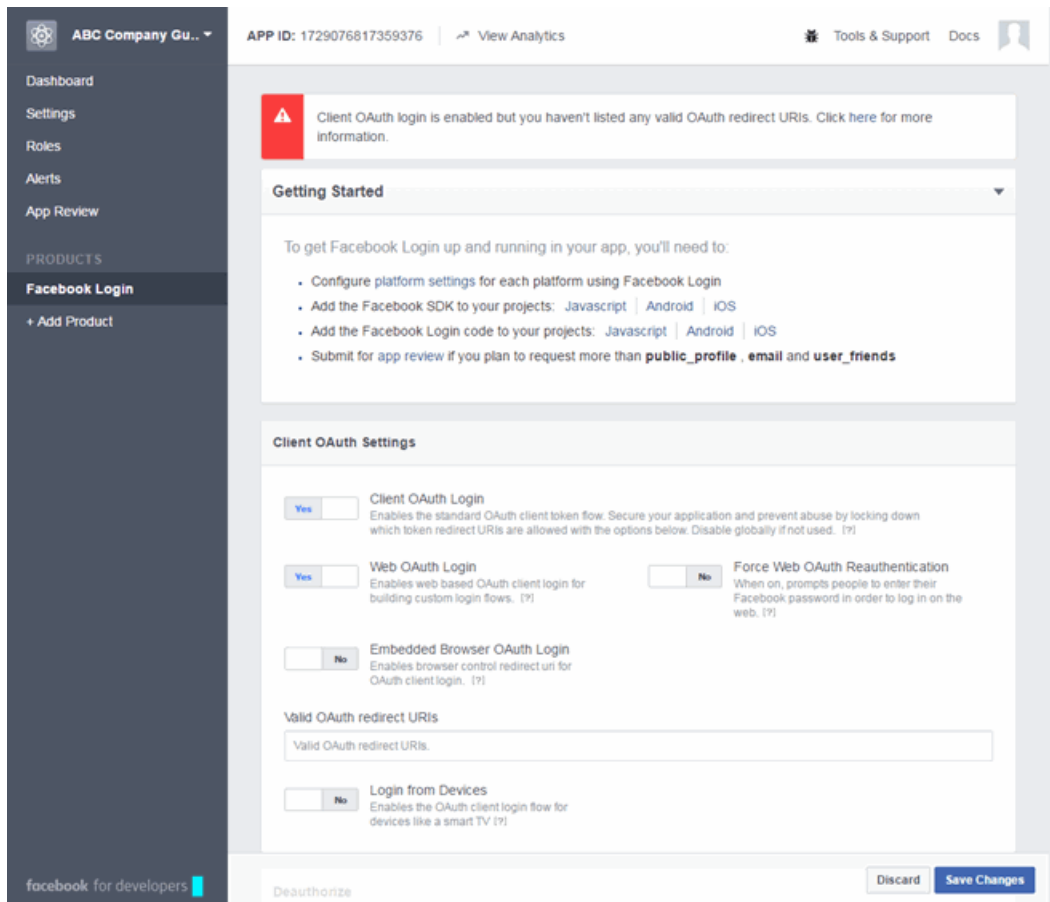

14. Enter the **Valid OAuth redirect URIs**. A redirect URI is required to redirect the user back to the engine with an Access Token Extreme Management Center uses to access the user account and retrieve the user data. The Redirection URI should be in the following format:

https://<Extreme Access ControlengineFQDN>/fb\_oauth

A Redirection URI must be added for each Extreme Access Control engine where end users can register via Facebook.

15. Click **Save Changes**.
16. Select **App Review** in the left panel.

The App Review panel opens.

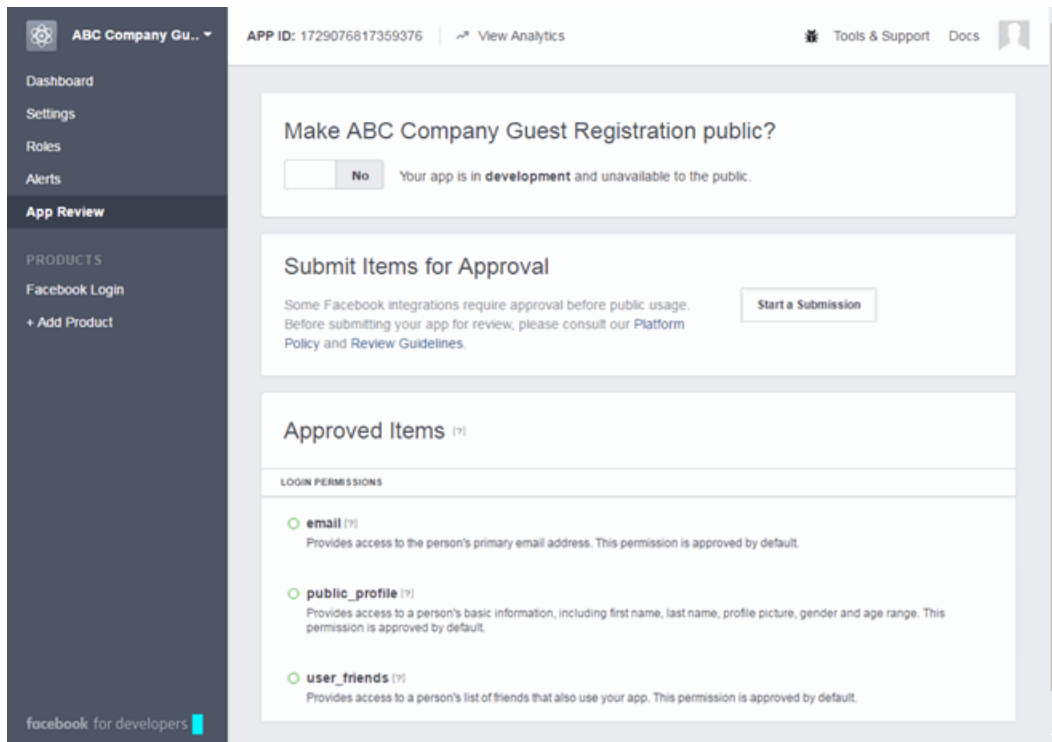

17. Click the **No** button in the **Make <Display Name> public** field to change the button to **Yes**.

A Confirmation window appears.

18. Click **Confirm**.

The Approved Items section displays a list of default permissions that provide access to end user data. (For more information on setting permissions, see <https://developers.facebook.com/docs/facebook-login/permissions#reference>.)

Your application is created and ready to use.

You need to add the App ID and App Secret to your portal configuration.

## Portal Configuration

The Application ID and Application Secret assigned during the creation of the Facebook application must be provided in the Portal Configuration in order for the entire process to complete properly.



1. Open the **Control > Access Control** tab.
2. In the left-panel tree, expand the Extreme Access Control Configurations > Portal tree and select Guest Registration.

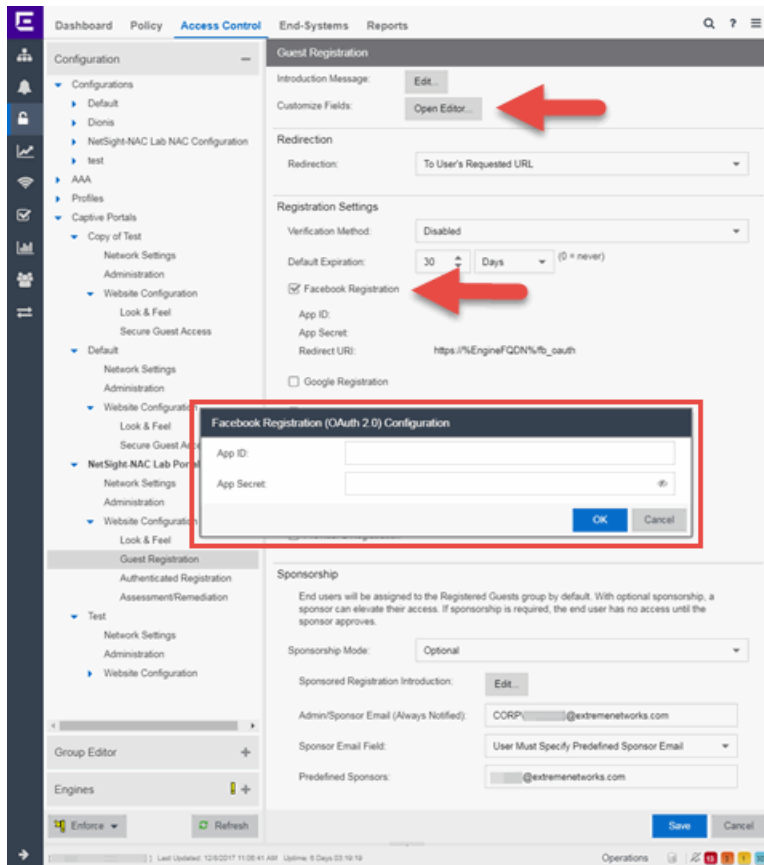

3. In the Customize Fields section, click the **Open Editor** button to open the [Manage Custom Fields window](#) where you can change registration portal fields. Facebook registration uses only the First Name, Last Name, and Email Address fields, and the Display Acceptable Use Policy (AUP) option. All other fields only apply to regular guest registration. If the Display AUP option is selected, the captive portal verifies that the AUP has been acknowledged before redirecting the user to Facebook.
4. Select the Facebook Registration checkbox.
5. Enter the Facebook App ID and Facebook App Secret.
6. Click **Save**. Warning messages display stating that Verification Method and Sponsorship are not used for Facebook registration, and that an FDQN is required will be enabled.
7. Enforce the new configuration to your engines.

## How Facebook Registration Works

Once you have configured Facebook registration using the steps above, this is how the registration process works:

1. The end user attempts to access an external Web site. Their HTTP traffic is redirected to the captive portal.
2. In the Guest Registration Portal, the end user selects the option to register using Facebook.
3. The end user is redirected to the Facebook login. If Acceptable Use Policy option is configured, the captive portal verifies that the AUP has been acknowledged before redirecting the user to Facebook.
4. Once logged in, the end user is presented with the information that Extreme Management Center receives from Facebook.
5. The end user grants Extreme Management Center access to the Facebook information and is redirected back to the captive portal where they see a "Registration in Progress" message.
6. Facebook provides the requested information to Extreme Management Center, which uses it to populate the user registration fields.
7. The registration process completes and network access is granted.
8. The word "Facebook" is added to the user name so you can easily search for Facebook registration via the Registration Administration web page.

## Special Deployment Considerations

Please read through the following deployment consideration prior to configuring Facebook Registration.

### Wireless Clients

To allow traffic to your network via a wireless connection, create an L7 host record for the **Unregistered Role** on your Wireless Controller for `facebook.com`.

## Networks using DNS Proxy

Facebook Registration for networks redirecting HTTP traffic to the captive portal using DNS Proxy requires additional configuration.

In order for Facebook Registration to work properly with DNS Proxy, **all** domains/URLs necessary to properly load the Facebook web page must be added to the Allowed URLs/Allowed Domains section of the captive portal configuration. Otherwise, the Extreme Access Control engine resolves DNS queries for these components to the Extreme Access Control engine IP causing the page to not load properly.

As of July 26, 2014, you must add the following domains in order for Facebook registration to work with DNS Proxy. These domains are subject to change and may vary based on location.

Facebook.com  
fbstatic-a.akamaihd.net  
fbcdn-profile-a.akamaihd.net  
fbcdn-photos-c-a.akamaihd.net

---

### Related Information

- [Portal Configuration](#)

# How to Implement Google Registration

---

This Help topic describes the steps for implementing guest registration using Google as a way to obtain end user information.

In this scenario, the Guest Registration portal provides the option to register as a guest or log into Google in order to complete the registration process. If the end user selects the Google option, Extreme Management Center OAuth to securely access the end user's Google account, obtain public end user data, and use that data to complete the registration process.

---

**NOTE:** Guest OAuth (e.g. Google, Yahoo) may not support native mobile browsers and display a "user agent" error. To access the network, use a standard browser application (e.g. Google Chrome).

---

Guest Registration using Google has two main advantages:

- It provides Extreme Management Center with a higher level of user information by obtaining information from the end user's Google account instead of relying on information entered by the end user.
- It provides an easier registration process for the end user. Extreme Management Center retrieves the public information from the end user's Google account and uses that information to populate the name and email registration fields.

This topic includes information and instructions on:

- [Requirements for Google Registration](#)
- [Creating a Google Application](#)
- [Portal Configuration for Google](#)
- [How Google Registration Works](#)
- [Special Deployment Considerations](#)
  - [Networks using DNS Proxy](#)

## Requirements

These are the configuration requirements for Google Registration.

- The Extreme Access Control engine must have Internet access in order to retrieve user information from Google.
- The Extreme Access Control Unregistered access policy must allow access to the Google site (either allow all SSL or make allowances for Google servers).
- The Extreme Access Control Unregistered access policy must allow access to HTTPS traffic to the Google OAuth servers.
- A Unique Google application must be created on the Google Developers page (see instructions below).
- The Portal Configuration must have Google Registration enabled and include the Google Application ID and Secret (see instructions below).

## Creating a Google Application

When implementing guest registration using Google, you must first create a Google application. This generates an Application ID and Application Secret that are required as part of the Extreme Management Center OAuth process. Use the following steps to create a Google application.

1. Access the Google Developers page at <https://console.developers.google.com/projectselector/apis/library>.
2. Log into your existing Developers account or create a new Developers account.
3. Click the **Create a project** button.

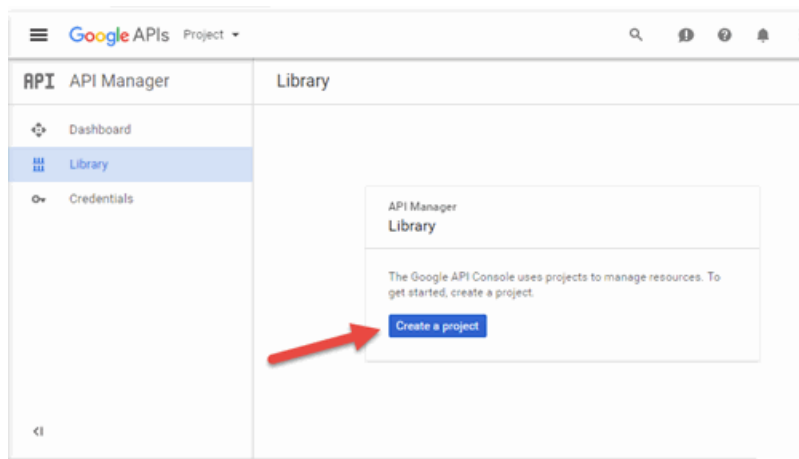

The New Project window opens.

4. Enter a **Project name** and click **Create**.

5. Click the **Credentials** link in the left-panel.

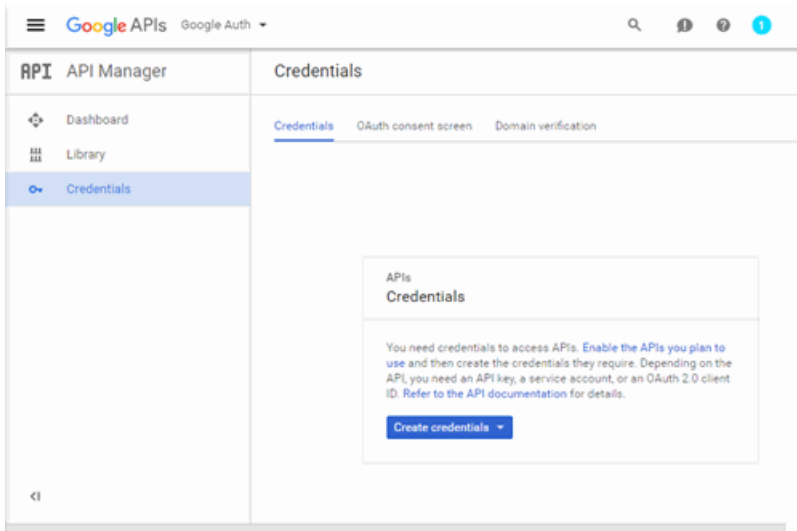

The Credentials panel opens.

6. Click the **Create credentials** button to open the drop-down menu and select **OAuth client ID**.

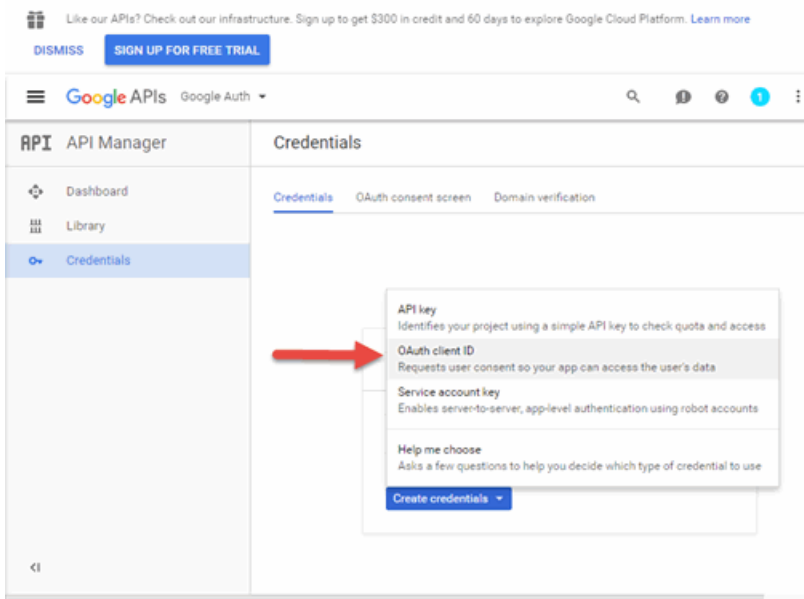

The Create client ID panel displays.

7. Click **Configure consent screen** to open the OAuth consent screen panel.

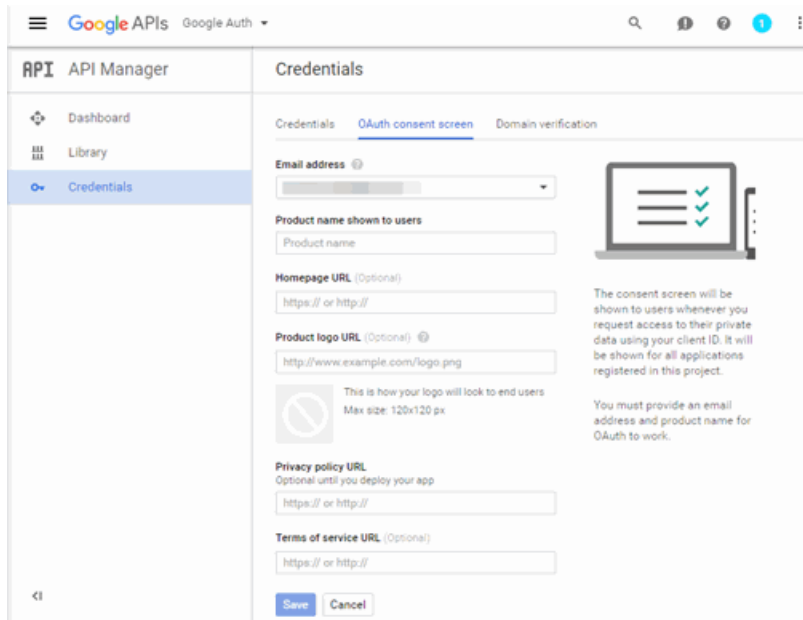

8. Select your email address, enter your product name, and enter the URL to any of the applicable resources for your company, then click **Save**.

The Create client ID panel opens.

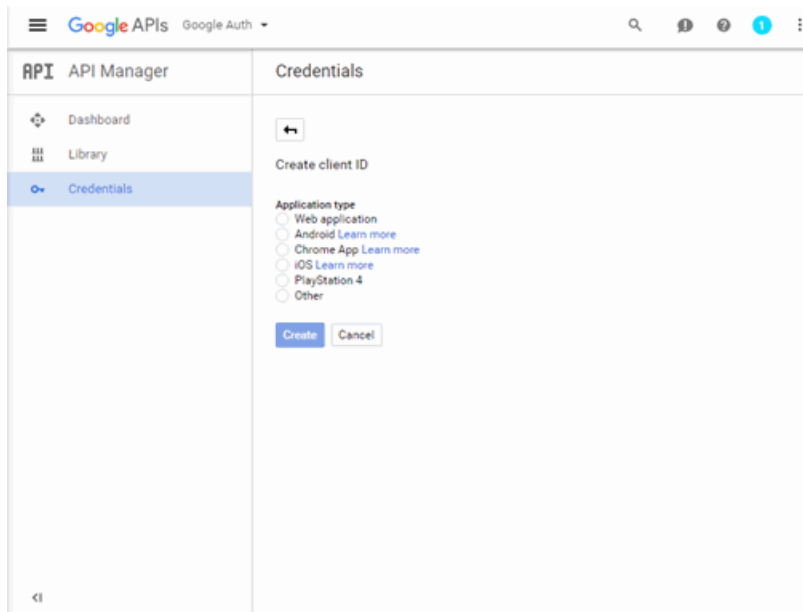

9. Select **Web application**.

The panel expands to display additional fields.

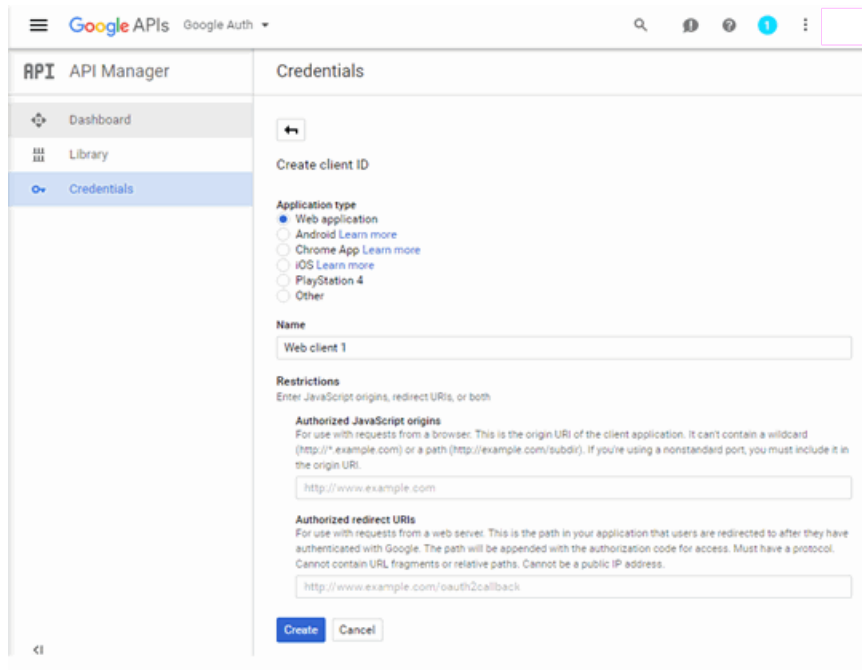

10. Enter a name for the application in the **Name** field. Use a name that clearly indicates what its purpose is, for example, Extreme Networks Guest Registration.
11. Enter an **Authorized redirect URI** in the following format `https://<AccessControlengineFQDN>/google_oauth`. Google uses the **Authorized redirect URI** to redirect the user back to the engine with an Access Token.

---

**NOTES:** Google OAuth APIs require your engine's FQDN resolves to a top level domain (.com, .net, .edu, .org, .mil, .gov, or .int). You cannot use a domain not classified as top level (e.g. MyGateway.MyCompany.Local) or the engines IP address, which may require you to reclassify your domain and hosts.

Use only lowercase when entering the host and domain suffix (e.g. .com).

12. Enter the **Authorized redirect URI** for any additional Extreme Access Control engines registering end-users via Google.
13. Click **Create**.

The **OAuth client** window appears, displaying your client ID and secret.





Your application is created and ready to use.

You need to add the client ID and client secret to your portal configuration.

## Portal Configuration

The client ID and client secret assigned during the creation of the Google application must be provided in the Portal Configuration in order for the entire process to complete properly.

1. Open the **Control** > **Access Control** tab.
2. In the left-panel tree, expand the Configuration > Captive Portals > Website Configuration > and select Guest Registration.

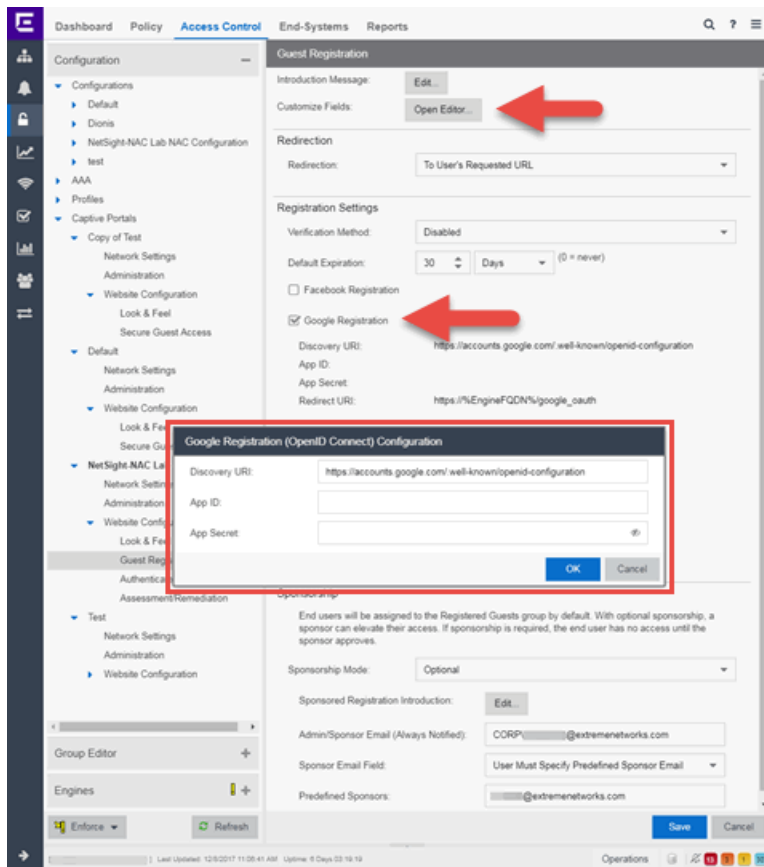

3. In the Customize Fields section, click the **Open Editor** button to open the [Manage Custom Fields window](#) where you can change registration portal fields. Google registration uses only the First Name, Last Name, and Email Address fields, and the Display Acceptable Use Policy (AUP) option. All other fields only apply to regular guest registration. If the Display AUP option is selected, the captive portal verifies that the AUP has been acknowledged before redirecting the user to Google.
4. Select the **Google Registration** checkbox.
5. Click **Edit**.
6. Enter the client ID in the **Google App ID** field and the client secret in the **App Secret** field.
7. Click **Save**. Warning messages display stating that Verification Method and Sponsorship are not used for Google registration, and that an FDQN is required will be enabled.
8. Enforce the new configuration to your engines.

## How Google Registration Works

Once you have configured Google registration using the steps above, this is how the registration process works:

1. The end user attempts to access an external Web site. Their HTTP traffic is redirected to the captive portal.
2. In the Guest Registration Portal, the end user selects the option to register using Google.
3. The end user is redirected to the Google login. If Acceptable Use Policy option is configured, the captive portal verifies that the AUP has been acknowledged before redirecting the user to Google.
4. Once logged in, the end user is presented with the information that Extreme Management Center receives from Google.
5. The end user grants Extreme Management Center access to the Google information and is redirected back to the captive portal where they see a "Registration in Progress" message.
6. Google provides the requested information to Extreme Management Center, which uses it to populate the user registration fields.
7. The registration process completes and network access is granted.
8. The word "Google" is added to the user name so you can easily search for Google registration via the Registration Administration web page.

## Special Deployment Considerations

Please read through the following deployment consideration prior to configuring Google Registration.

To allow traffic to your network via a wireless connection, create an L7 host record for the **Unregistered Role** on your Wireless Controller for `accounts.google.com` and `gstatic.com`.

## Networks using DNS Proxy

Google Registration for networks redirecting HTTP traffic to the captive portal using DNS Proxy requires additional configuration.

In order for Google Registration to work properly with DNS Proxy, **all** domains/URLs necessary to properly load the Google web page must be added to the Allowed URLs/Allowed Domains section of the captive portal configuration. Otherwise, the Extreme Access Control engine resolves DNS queries for these components to the Extreme Access Control engine IP causing the page to not load properly.

As of February 2017, you must add the following domains in order for Google registration to work with DNS Proxy. These domains are subject to change and may vary based on location.

Accounts.google.com

---

### **Related Information**

- [Portal Configuration](#)

# How to Implement Microsoft Registration

---

This Help topic describes the steps for implementing guest registration using Microsoft as a way to obtain end user information.

In this scenario, the Guest Registration portal provides the option to register as a guest or log into Microsoft in order to complete the registration process. If the end user selects the Microsoft option, Extreme Management Center OAuth to securely access the end user's Microsoft account, obtain public end user data, and use that data to complete the registration process.

---

**NOTE:** Guest OAuth (e.g. Google, Yahoo) may not support native mobile browsers and display a "user agent" error. To access the network, use a standard browser application (e.g. Google Chrome).

---

Guest Registration using Microsoft has two main advantages:

- It provides Extreme Management Center with a higher level of user information by obtaining information from the end user's Microsoft account instead of relying on information entered by the end user.
- It provides an easier registration process for the end user. Extreme Management Center retrieves the public information from the end user's Microsoft account and uses that information to populate the name and email registration fields.

This topic includes information and instructions on:

- [Requirements for Microsoft Registration](#)
- [Creating a Microsoft Application](#)
- [Portal Configuration for Microsoft](#)
- [How Microsoft Registration Works](#)
- [Special Deployment Considerations](#)
  - [Networks using DNS Proxy](#)

## Requirements

These are the configuration requirements for Microsoft Registration.

- The Extreme Access Control engine must have Internet access in order to retrieve user information from Microsoft.
- The Extreme Access Control Unregistered access policy must allow access to the Microsoft site (either allow all SSL or make allowances for Microsoft servers).
- The Extreme Access Control Unregistered access policy must allow access to HTTPS traffic to the Microsoft OAuth servers.
- A Unique Microsoft application must be created on the Microsoft Developers page (see instructions below).
- The Portal Configuration must have Microsoft Registration enabled and include the Microsoft Application ID and Secret (see instructions below).

## Creating a Microsoft Application

When implementing guest registration using Microsoft, you must first create a Microsoft application. This generates an Application ID and Application Secret that are required as part of the Extreme Management Center OAuth process. Use the following steps to create a Microsoft application.

1. Access the Microsoft Developers page at <https://apps.dev.microsoft.com/#/appList>.
2. Log into your existing account or create a new account by clicking the **Sign in** link in the top-right corner of the window.

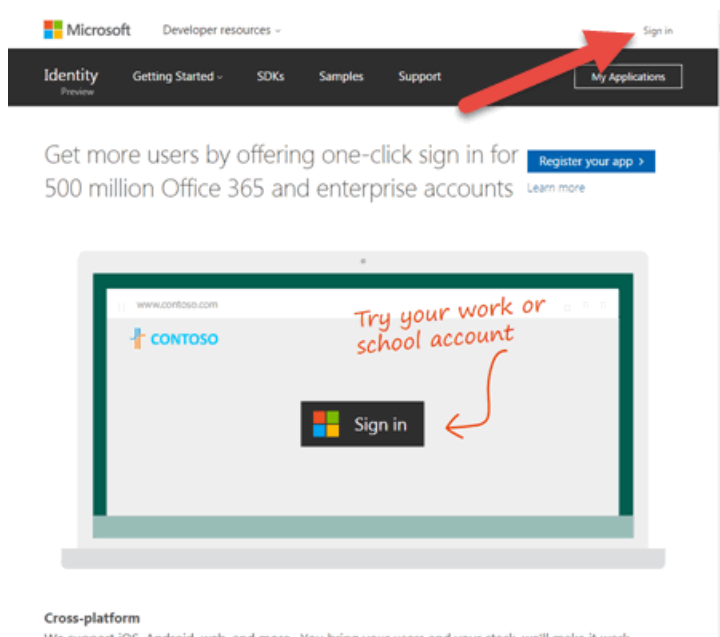

3. Click the **Add an app** button.

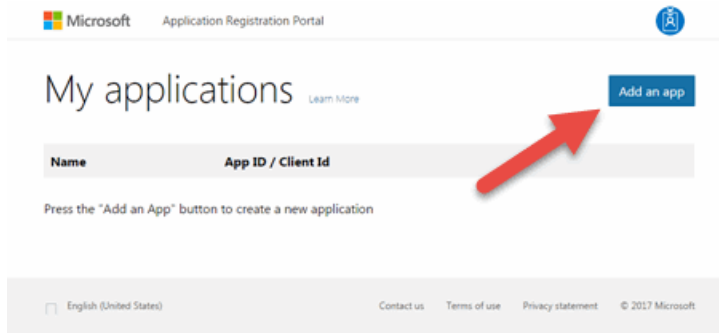

The New Application Registration window opens.

4. Enter a **Name** for the application. Use a name that clearly indicates it's purpose (e.g. Extreme Networks Guest Registration) and click **Create application**.

The Application Registration window opens.

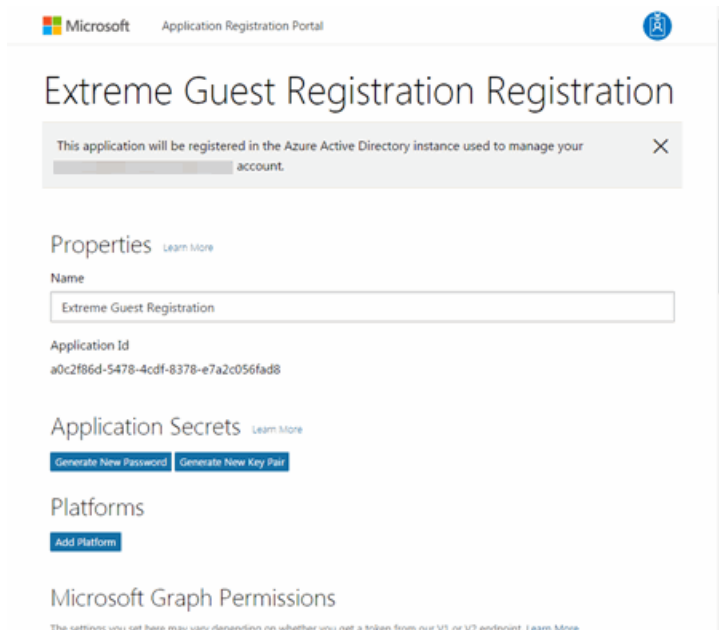

5. Click **Add Platforms** under Platforms.

The Add Platform window opens.

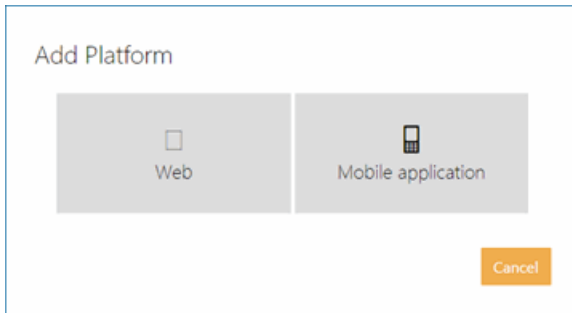

6. Click **Web**.

Additional fields display under Platforms allowing you to configure a web platform.

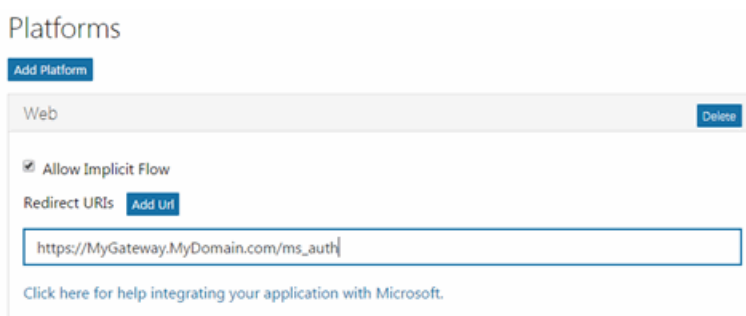

7. Enter a **Redirect URI** in the following format `https://<AccessControlengineFQDN>/ms_oauth`. Microsoft uses the **Redirect URI** to redirect the user back to the engine with an Access Token.

---

**NOTE:** Microsoft applications can only use a limited set of [redirect URI values](#).

---

8. Click **Add Url** to enter the **Redirect URI** for any additional Extreme Access Control engines registering end-users via Microsoft.



9. Copy the **Application Id** under Properties.

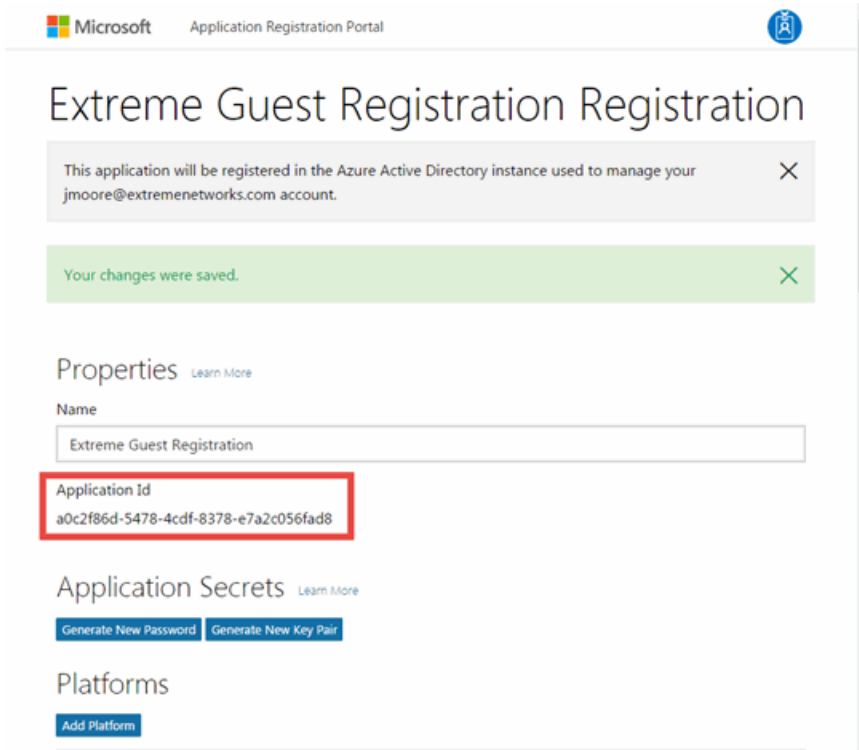

10. Click **Generate New Password** under Application Secrets.

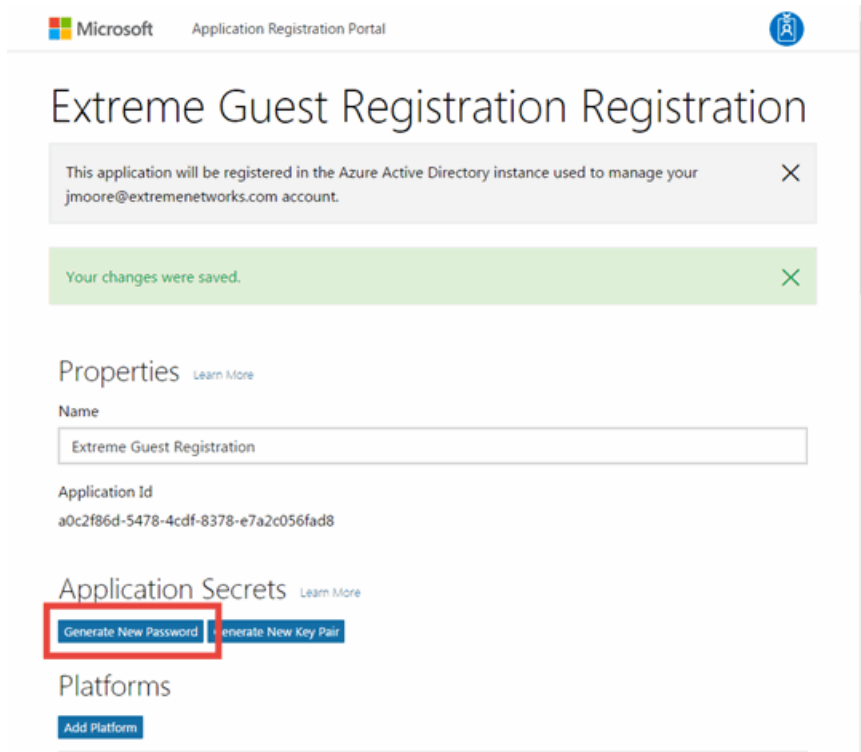

The **New password generated** window displays.

- Copy the application password.

---

**IMPORTANT:** Ensure you copy the password accurately. After the window is closed, you cannot access the password again.

---

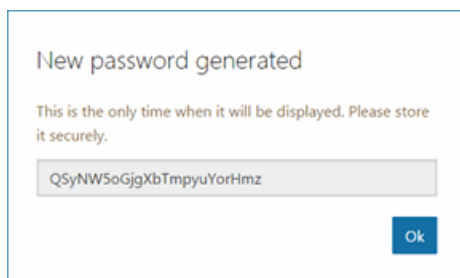

- Click **Save**.

Your application is created and ready to use.

You need to add the **Application Id** and application password to your portal configuration.

## Portal Configuration

The Application Id and application password assigned during the creation of the Microsoft application must be provided in the Portal Configuration in order for the entire process to complete properly.

1. Open the **Control > Access Control** tab.
2. In the left-panel tree, expand the Extreme Access Control Configurations > Portal tree and select Guest Registration.

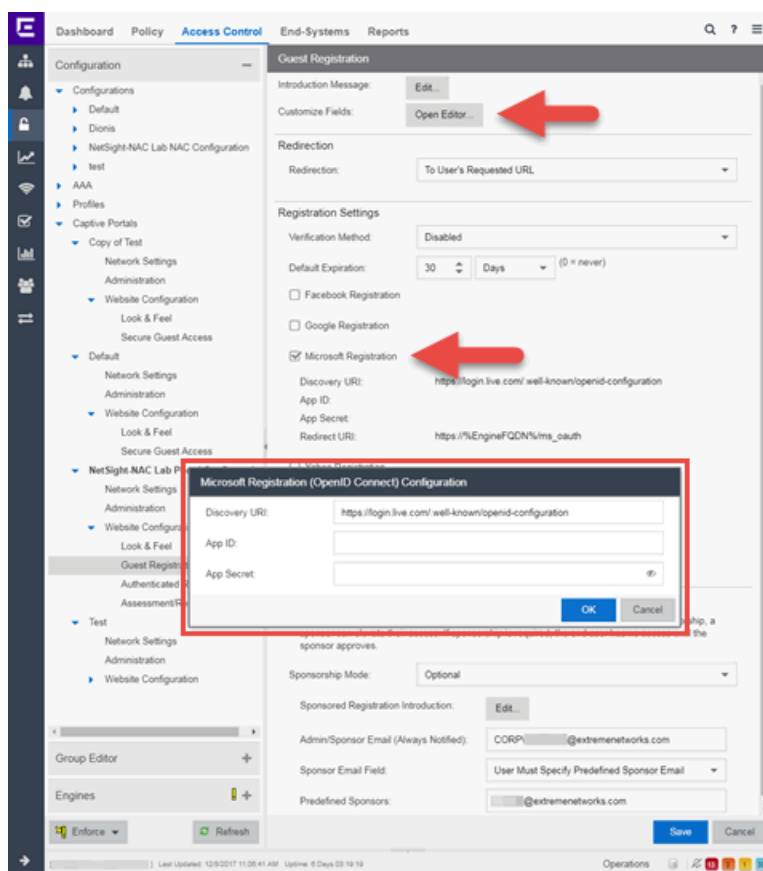

3. In the Customize Fields section, click the **Open Editor** button to open the [Manage Custom Fields window](#) where you can change registration portal fields. Microsoft registration uses only the First Name, Last Name, and Email Address fields, and the Display Acceptable Use Policy (AUP) option. All other fields only apply to regular guest registration. If the Display AUP option is selected, the captive portal verifies that the AUP has been acknowledged before redirecting the user to Microsoft.
4. Select the **Microsoft Registration** checkbox.

5. Click **Edit**.
6. Enter the Application Id in the **Microsoft App ID** field and the application password in the **Microsoft App Secret** field.
7. Click **Save**. Warning messages display stating that Verification Method and Sponsorship are not used for Microsoft registration, and that an FDQN is required and will be enabled.
8. Enforce the new configuration to your engines.

## How Microsoft Registration Works

Once you have configured Microsoft registration using the steps above, this is how the registration process works:

1. The end user attempts to access an external Web site. Their HTTP traffic is redirected to the captive portal.
2. In the Guest Registration Portal, the end user selects the option to register using Microsoft.
3. The end user is redirected to the Microsoft login. If Acceptable Use Policy option is configured, the captive portal verifies that the AUP has been acknowledged before redirecting the user to Microsoft.
4. Once logged in, the end user is presented with the information that Extreme Management Center receives from Microsoft.
5. The end user grants Extreme Management Center access to the Microsoft information and is redirected back to the captive portal where they see a "Registration in Progress" message.
6. Microsoft provides the requested information to Extreme Management Center, which uses it to populate the user registration fields.
7. The registration process completes and network access is granted.
8. The word "Microsoft" is added to the user name so you can easily search for Microsoft registration via the Registration Administration web page.

## Special Deployment Considerations

Please read through the following deployment consideration prior to configuring Microsoft Registration.

To allow traffic to your network via a wireless connection, create an L7 host record for the **Unregistered Role** on your Wireless Controller for `login.live.com` and `auth.gfx.ms`.

## Networks using DNS Proxy

Microsoft Registration for networks redirecting HTTP traffic to the captive portal using DNS Proxy requires additional configuration.

In order for Microsoft Registration to work properly with DNS Proxy, **all** domains/URLs necessary to properly load the Microsoft web page must be added to the Allowed URLs/Allowed Domains section of the captive portal configuration. Otherwise, the Extreme Access Control engine resolves DNS queries for these components to the Extreme Access Control engine IP causing the page to not load properly.

As of February 2017, you must add the following domains in order for Microsoft registration to work with DNS Proxy. These domains are subject to change and may vary based on location.

`Login.live.com`

---

### Related Information

- [Portal Configuration](#)

# How to Implement Yahoo Registration

---

This Help topic describes the steps for implementing guest registration using Yahoo as a way to obtain end user information.

In this scenario, the Guest Registration portal provides the option to register as a guest or log into Yahoo in order to complete the registration process. If the end user selects the Yahoo option, Extreme Management Center OpenID to securely access the end user's Yahoo account, obtain public end user data, and use that data to complete the registration process.

---

**NOTE:** Guest OAuth (e.g. Google, Yahoo) may not support native mobile browsers and display a "user agent" error. To access the network, use a standard browser application (e.g. Google Chrome).

---

Guest Registration using Yahoo has two main advantages:

- It provides Extreme Management Center with a higher level of user information by obtaining information from the end user's Yahoo account instead of relying on information entered by the end user.
- It provides an easier registration process for the end user. Extreme Management Center retrieves the public information from the end user's Yahoo account and uses that information to populate the name and email registration fields.

This topic includes information and instructions on:

- [Requirements for Yahoo Registration](#)
- [Creating a Yahoo Application](#)
- [Portal Configuration for Yahoo](#)
- [How Yahoo Registration Works](#)
- [Special Deployment Considerations](#)
  - [Networks using DNS Proxy](#)

## Requirements

These are the configuration requirements for Yahoo Registration.

- The Extreme Access Control engine must have Internet access in order to retrieve user information from Yahoo.
- The Extreme Access Control Unregistered access policy must allow access to the Yahoo site (either allow all SSL or make allowances for Yahoo servers).
- The Extreme Access Control Unregistered access policy must allow access to HTTPS traffic to the Yahoo OpenID servers.
- A Unique Yahoo application must be created on the Yahoo Developers page (see instructions below).
- The Portal Configuration must have Yahoo Registration enabled and include the Yahoo Application ID and Secret (see instructions below).

## Creating a Yahoo Application

When implementing guest registration using Yahoo, you must first create a Yahoo application. This generates an Application ID and Application Secret that are required as part of the Extreme Management Center OpenID process. Use the following steps to create a Yahoo application.

1. Log into your existing account or create a new account.
2. Access the Create Application page at <https://developer.yahoo.com/apps/create/>.

**YAHOO!**  
DEVELOPER NETWORK

## Create Application

**Application Name**

**Application Type**

Web Application

Installed Application

This application is accessed by a web browser. Requires a valid callback domain.

**Description (Optional)**

**Home Page URL (Optional)**

**Callback Domain (Optional)**

Please specify the domain to which your application will be returning after successfully authenticating. Yahoo OAuth flow will redirect users to a URL only on this domain after they authorize access to their private data.

**API Permissions**

Select private user data APIs that your application needs to access.

- Contacts
- Fantasy Sports
- Yahoo Gemini Advertising
- Messenger
- Profiles (Social Directory)
- Relationships (Social Directory)

By clicking Create App, you agree to be bound by the Yahoo Developer Network Terms of Use.

---

Products Blog My Apps Jobs Privacy Terms Policies

3. Enter a name for the application in the **Application Name** field. Use a name that clearly indicates what its purpose is, for example, Extreme Networks Guest Registration.
4. Select **Web Application** for the **Application Type**.
5. Enter an **Callback Domain** in the following format `https://<AccessControlengineFQDN>`. Yahoo uses the **Callback Domain** to redirect the user back to the engine with an Access Token.



**NOTES:** Yahoo OAuth APIs require your engine's FQDN resolves to a top level domain (.com, .net, .edu, .org, .mil, .gov, or .int). You cannot use a domain not classified as top level (e.g. MyGateway.MyCompany.Local) or the engines IP address, which may require you to reclassify your domain and hosts.

Use only lowercase when entering the host and domain suffix (e.g. .com).

6. Click **Create App**.

The Client ID and Client Secret display at the top of the window.

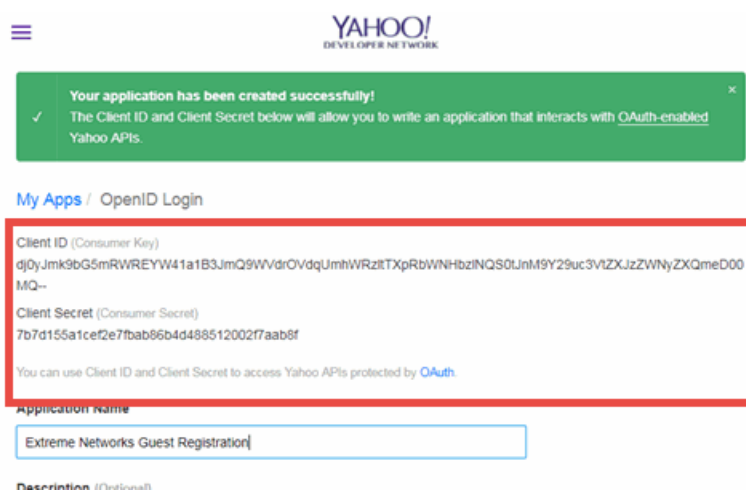

Your application is created and ready to use.

You need to add the client ID and client secret to your portal configuration.

## Portal Configuration

The client ID and client secret assigned during the creation of the Yahoo application must be provided in the Portal Configuration in order for the entire process to complete properly.

1. Open the **Control > Access Control** tab.
2. In the left-panel tree, expand the **Configuration > Captive Portals > Website Configuration >** and select **Guest Registration**.

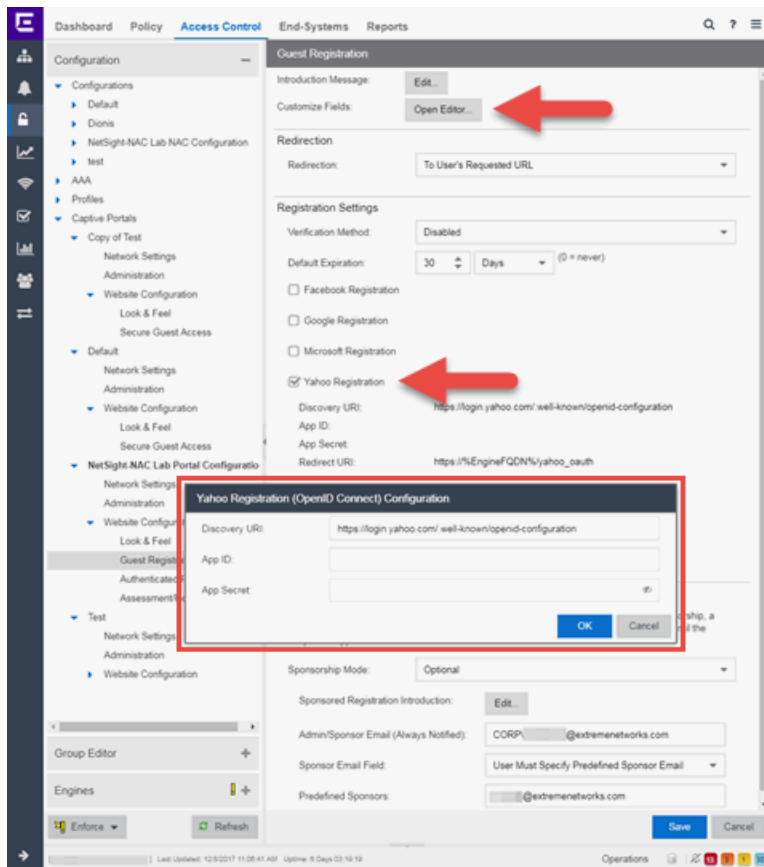

3. In the Customize Fields section, click the **Open Editor** button to open the [Manage Custom Fields window](#) where you can change registration portal fields. Yahoo registration uses only the First Name, Last Name, and Email Address fields, and the Display Acceptable Use Policy (AUP) option. All other fields only apply to regular guest registration. If the Display AUP option is selected, the captive portal verifies that the AUP has been acknowledged before redirecting the user to Yahoo.
4. Select the **Yahoo Registration** checkbox.
5. Click **Edit**.
6. Enter the Client ID in the **App ID** field and the Client Secret in the **App Secret** field.
7. Click **Save**. Warning messages display stating that Verification Method and Sponsorship are not used for Yahoo registration, and that an FDQN is required will be enabled.
8. Enforce the new configuration to your engines.

## How Yahoo Registration Works

Once you have configured Yahoo registration using the steps above, this is how the registration process works:

1. The end user attempts to access an external Web site. Their HTTP traffic is redirected to the captive portal.
2. In the Guest Registration Portal, the end user selects the option to register using Yahoo.
3. The end user is redirected to the Yahoo login. If Acceptable Use Policy option is configured, the captive portal verifies that the AUP has been acknowledged before redirecting the user to Yahoo.
4. Once logged in, the end user is presented with the information that Extreme Management Center receives from Yahoo.
5. The end user grants Extreme Management Center access to the Yahoo information and is redirected back to the captive portal where they see a "Registration in Progress" message.
6. Yahoo provides the requested information to Extreme Management Center, which uses it to populate the user registration fields.
7. The registration process completes and network access is granted.
8. The word "Yahoo" is added to the user name so you can easily search for Yahoo registration via the Registration Administration web page.

## Special Deployment Considerations

Please read through the following deployment consideration prior to configuring Yahoo Registration.

To allow traffic to your network via a wireless connection, create an L7 host record for the **Unregistered Role** on your Wireless Controller for `login.yahoo.com`.

## Networks using DNS Proxy

Yahoo Registration for networks redirecting HTTP traffic to the captive portal using DNS Proxy requires additional configuration.

In order for Yahoo Registration to work properly with DNS Proxy, **all** domains/URLs necessary to properly load the Yahoo web page must be added to the Allowed URLs/Allowed Domains section of the captive portal configuration. Otherwise, the Extreme Access Controlengine resolves DNS queries for these components to the Extreme Access Controlengine IP causing the page to not load properly.

As of February 2017, you must add the following domains in order for Yahoo registration to work with DNS Proxy. These domains are subject to change and may vary based on location.

login.yahoo.com

---

### **Related Information**

- [Portal Configuration](#)

# How to Implement Salesforce Registration

---

This Help topic describes the steps for implementing guest registration using Salesforce as a way to obtain end user information.

In this scenario, the Guest Registration portal provides the option to register as a guest or log into Salesforce in order to complete the registration process. If the end user selects the Salesforce option, Extreme Management Center uses OpenID to securely access the end user's Salesforce account, obtain public end user data, and use that data to complete the registration process.

---

**NOTE:** Guest OAuth (e.g. Google, Yahoo) may not support native mobile browsers and display a “user agent” error. To access the network, use a standard browser application (e.g. Google Chrome).

---

Guest Registration using Salesforce has two main advantages:

- It provides Extreme Management Center with a higher level of user information by obtaining information from the end user's Salesforce account instead of relying on information entered by the end-user.
- It provides an easier registration process for the end user. Extreme Management Center retrieves the public information from the end user's Salesforce account and uses that information to populate the name and email registration fields.

This topic includes information and instructions on:

- [Requirements for Salesforce Registration](#)
- [Creating a Salesforce Application](#)
- [Portal Configuration for Salesforce](#)
- [How Salesforce Registration Works](#)
- [Special Deployment Considerations](#)
  - [Networks using DNS Proxy](#)

## Requirements

These are the configuration requirements for Salesforce Registration.

- The Extreme Access Control engine must have Internet access in order to retrieve user information from Salesforce.
- The Extreme Access Control Unregistered access policy must allow access to the Salesforce site (either allow all SSL or make allowances for Salesforce servers).
- The Extreme Access Control Unregistered access policy must allow access to HTTPS traffic to the Salesforce OpenID servers.
- A Unique Salesforce application must be created on the Salesforce Developers page (see instructions below).
- The Portal Configuration must have Salesforce Registration enabled and include the Salesforce Application ID and Secret (see instructions below).

## Creating a Salesforce Application

When implementing guest registration using Salesforce, you must first create a Salesforce application. This generates an Application ID and Application Secret that are required as part of the Extreme Management Center OpenID process. Use the following steps to create a Salesforce application.

1. Access the Salesforce Developers page at <https://developer.salesforce.com/signup>.
2. Log into your existing Developers account or create a new Developers account.
3. Click the **My Developer Account** button from the profile drop-down menu.

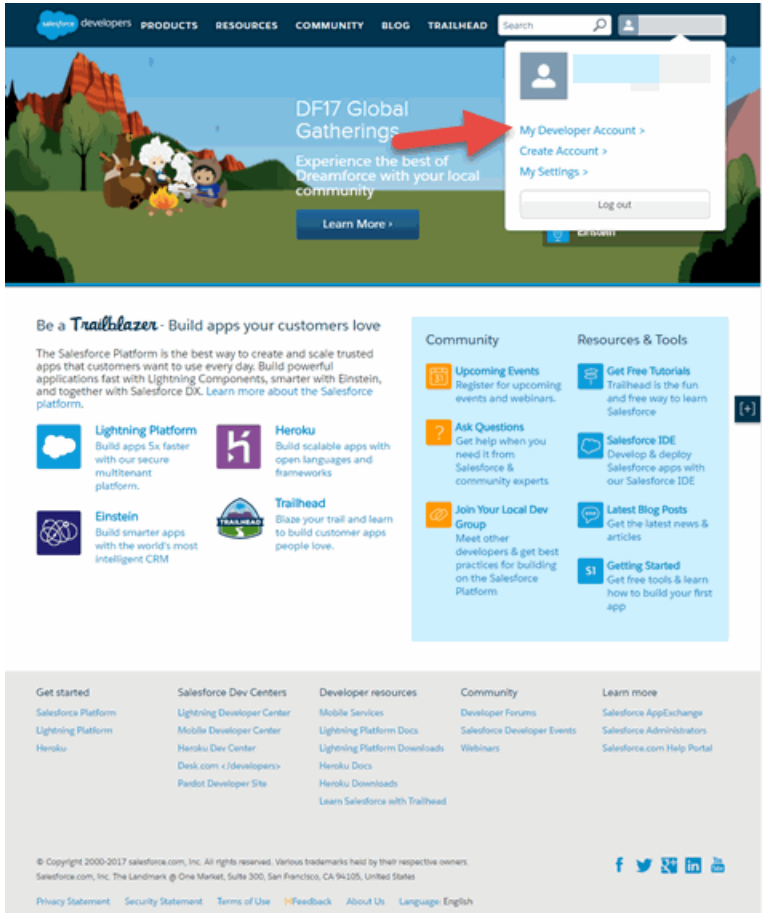

The Developer Account login window opens.

4. Click your account.

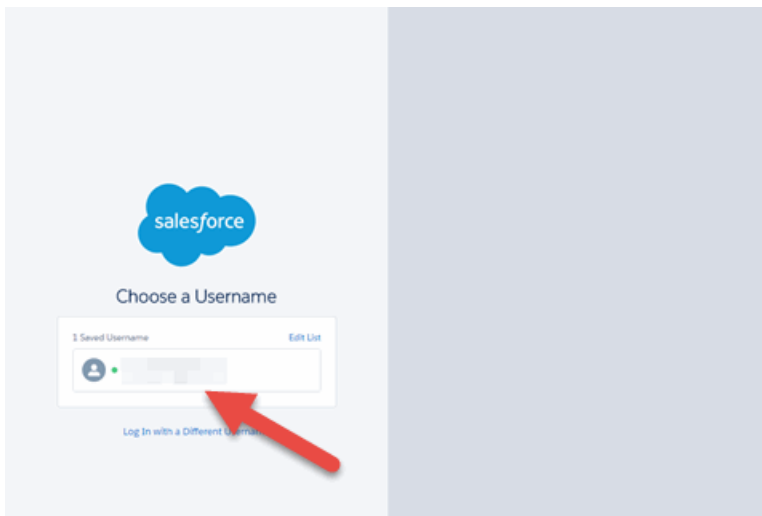

The **Developer Home** window opens.

5. Select **My Settings** from the Profile drop-down menu.

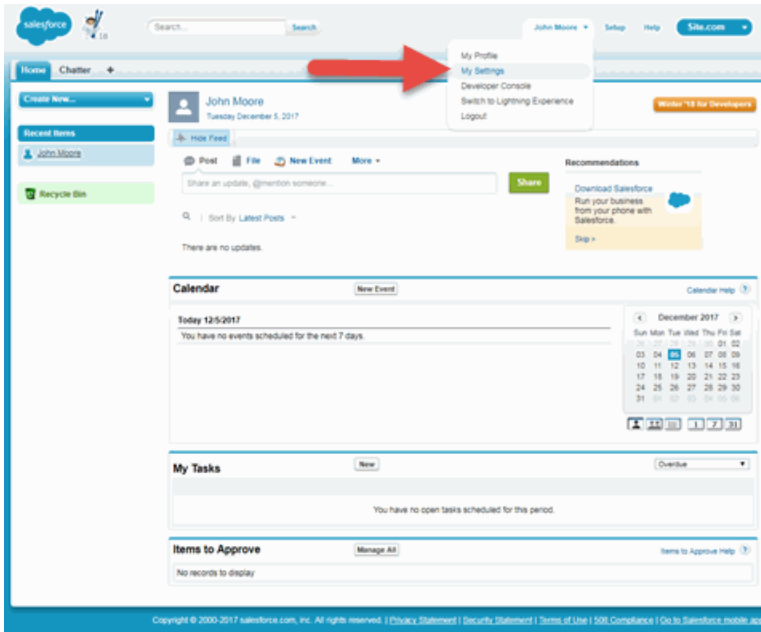

The **My Settings** window opens.

6. Click **App & Administration Setup**.



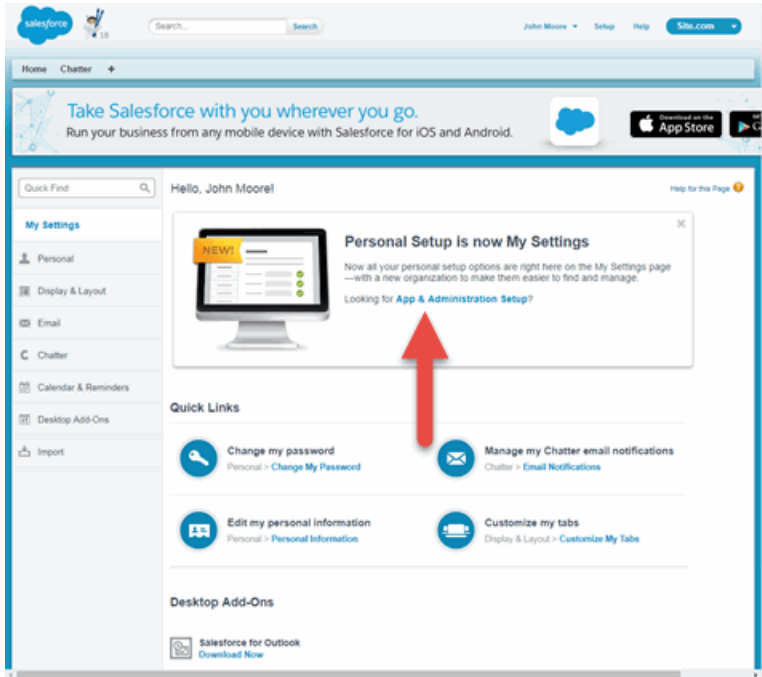

The App & Administration Setup window opens.

7. Click **Apps** from within the Build > Create menu.

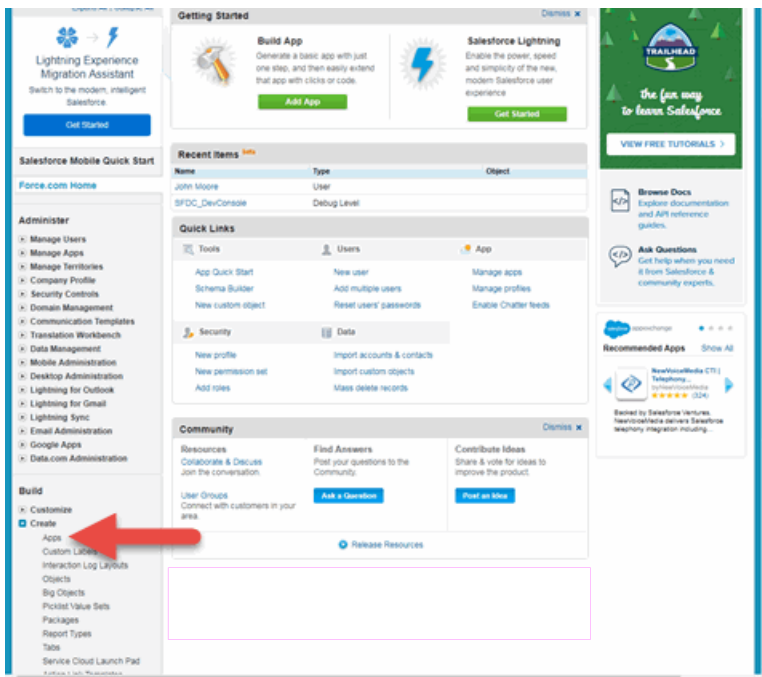

The Apps window opens.

- Click the **New** button in the Connected Apps section.

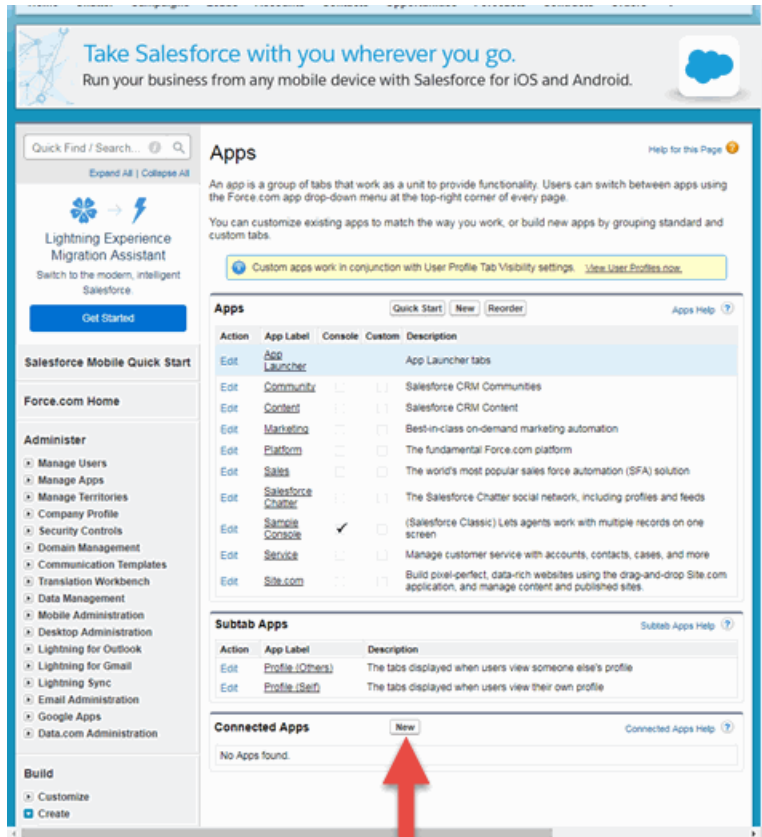

The New Connected App window opens.

- Enter a **Connected App Name**, **API Name**, **Contact Email**, and select the **Enable OAuth Settings** checkbox.

The API (Enable OAuth Settings) section of the window expands to display additional fields.

- Select **Enable OAuth Settings**.
- Enter a **Callback URL** in the following format `https://<AccessControlengineFQDN>/Salesforce_oauth`. Salesforce uses the **Authorized redirect URI** to redirect the user back to the engine with an Access Token.

---

**NOTES:** Salesforce OpenID APIs require your engine's FQDN resolves to a top level domain (.com, .net, .edu, .org, .mil, .gov, or .int. You cannot use a domain not classified as top level (e.g. MyGateway.MyCompany.Local) or the engines IP address, which may require you to reclassify your domain and hosts.

Use only lowercase when entering the host and domain suffix (e.g. .com).

---

12. Select **Access your basic information (id, profile, email, address, phone)**, **Full access (full)**, and **Allow access to your unique identifier (openid)**, then click the **Add** icon in the Selected OAuth Scopes section of the window to add the scopes to the Selected OAuth Scopes list.
13. Select the **Require Secret for Web Server Flow**, **Include ID Token** and **Include Standard Claims** checkboxes.

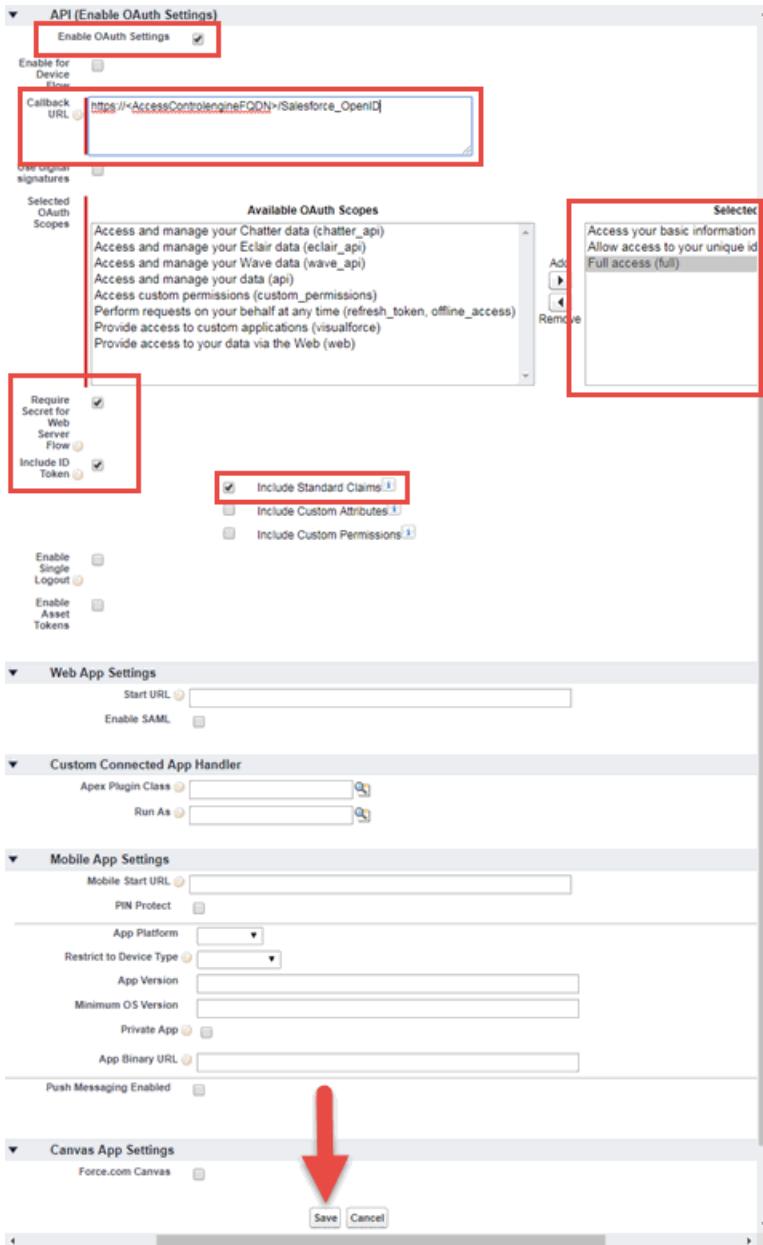

14. Click **Save**.

Your application is created and ready to use.

The **New Connected App** window opens.

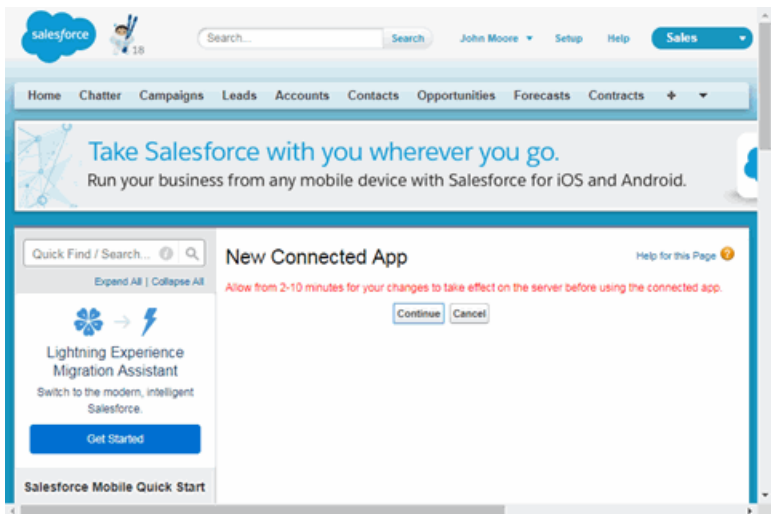

15. Click **Continue**.

The **Connected App** window opens.

16. Click the **Click to reveal** link in the **Consumer Secret** field and copy the **Consumer Secret** and **Consumer Key**.

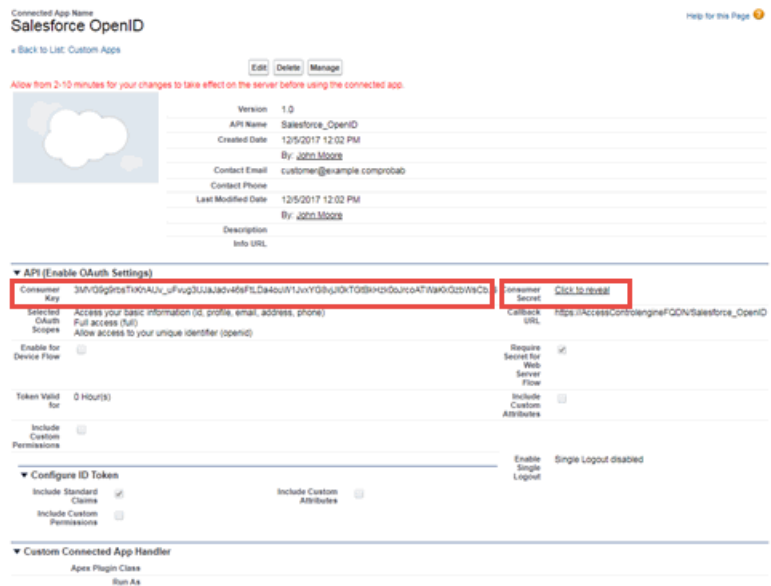

You need to add the **Consumer Key** and **Consumer Secret** to your portal configuration.

## Portal Configuration

The client ID and client secret assigned during the creation of the Salesforce application must be provided in the Portal Configuration in order for the entire process to complete properly.

1. Open the **Control > Access Control** tab.
2. In the left-panel tree, expand the Extreme Access Control Configurations > Portal tree and select Guest Registration.

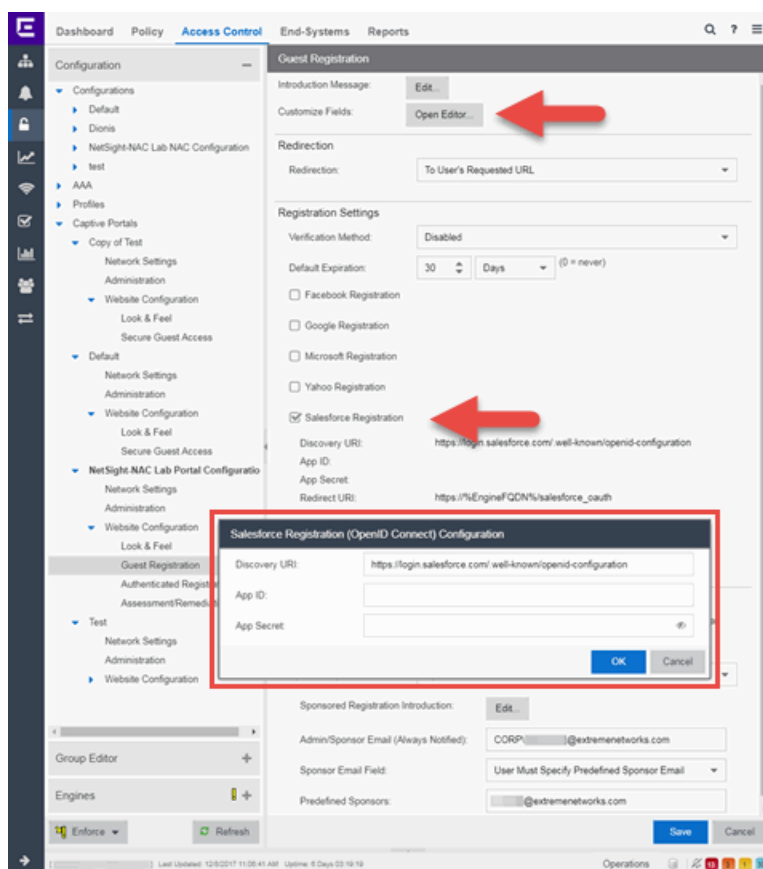

3. In the Customize Fields section, click the **Open Editor** button to open the [Manage Custom Fields window](#) where you can change registration portal fields. Salesforce registration uses only the First Name, Last Name, and Email Address fields, and the Display Acceptable Use Policy (AUP) option. All other fields only apply to regular guest registration. If the Display AUP option is selected, the captive portal verifies that the AUP has been acknowledged before redirecting the user to Salesforce.
4. Select the **Salesforce Registration** checkbox.

5. Enter the Consumer Key in the **App ID** field and the Consumer Secret in the **App Secret** field.
6. Click **Save**. Warning messages display stating that Verification Method and Sponsorship are not used for Salesforce registration, and that an FDQN is required will be enabled.
7. Enforce the new configuration to your engines.

## How Salesforce Registration Works

Once you have configured Salesforce registration using the steps above, this is how the registration process works:

1. The end user attempts to access an external Web site. Their HTTP traffic is redirected to the captive portal.
2. In the Guest Registration Portal, the end user selects the option to register using Salesforce.
3. The end user is redirected to the Salesforce login. If Acceptable Use Policy option is configured, the captive portal verifies that the AUP has been acknowledged before redirecting the user to Salesforce.
4. Once logged in, the end user is presented with the information that Extreme Management Center receives from Salesforce.
5. The end user grants Extreme Management Center access to the Salesforce information and is redirected back to the captive portal where they see a "Registration in Progress" message.
6. Salesforce provides the requested information to Extreme Management Center, which uses it to populate the user registration fields.
7. The registration process completes and network access is granted.
8. The word "Salesforce" is added to the user name so you can easily search for Salesforce registration via the Registration Administration web page.

## Special Deployment Considerations

Please read through the following deployment consideration prior to configuring Salesforce Registration.

To allow traffic to your network via a wireless connection, create an L7 host record for the **Unregistered Role** on your Wireless Controller for `login.Salesforce.com`.

## Networks using DNS Proxy

Salesforce Registration for networks redirecting HTTP traffic to the captive portal using DNS Proxy requires additional configuration.

In order for Salesforce Registration to work properly with DNS Proxy, **all** domains/URLs necessary to properly load the Salesforce web page must be added to the Allowed URLs/Allowed Domains section of the captive portal configuration. Otherwise, the Extreme Access Control engine resolves DNS queries for these components to the Extreme Access Control engine IP causing the page to not load properly.

As of February 2017, you must add the following domains in order for Salesforce registration to work with DNS Proxy. These domains are subject to change and may vary based on location.

`login.Salesforce.com`

---

### Related Information

- [Portal Configuration](#)

## End-Systems

---

The **End-Systems** tab presents end-system connection information for a single Extreme Access Control engine, all Extreme Access Control engines, or all the engines in an engine group, depending on what you select in the left-panel tree. You can also monitor end-system events and view the health results from an end-system's assessment.

The **End-Systems** tab is the first tab displayed when accessing the **Control > Access Control** tab. A high-level overview of the functionality found in the [Extreme Access Control tab](#) is also available.



To access this tab, select a single Extreme Access Control engine, the All Extreme Access Control Engines folder, or an engine group in the left-panel tree, then click the **End-Systems** tab in the right panel.

Use the table options and tools to filter, sort, and customize table settings. Access the options by clicking the down arrow in the right corner of any column header.

St...	Last Seen	IP Address	MAC Address	MAC OUI Vendor	Host Name	Device Family	Device Type	User
✓	1/24/2017 2:56...		00:1C:23:3D:18:20	Dell Inc.	ENTERAS...	Windows	Windows Vis...	

## End-Systems

This table displays the last known connection state for each end-system that has attempted connection.

### State

The end-system's connection state:

- Scan — The end-system is currently being scanned.
- Accept — The end-system is granted access with either the Accept policy or the attributes returned from the RADIUS server.
- Quarantine — The end-system is quarantined because the assessment failed.
- Reject — The end-system was rejected because the assigned Extreme Access Control profile was set to Reject, the MAC Locking test failed, or the RADIUS server was reachable but rejected the authentication request.
- Disconnected — All sessions for the end-system are disconnected. This state is only applicable for end-systems connected to switches that have RADIUS accounting enabled.
- Error — Indicates one of nine problems:
  - the MAC to IP resolution failed, if assessment is enabled
  - the MAC to IP resolution timed out, if assessment is enabled
  - all RADIUS servers are unreachable

- the RADIUS request was non-compliant
- all assessment servers are unavailable
- the assessment server can't reach the end-system
- no assessment servers are configured
- the assessment server is not compatible with the current version of Extreme Access Control
- the username and password configured in the [Assessment Server panel](#) of the Extreme Access Control options (Administration > Options > Extreme Access Control > Assessment Server) are incorrect for the assessment server.

### **MAC Address**

The end-system's MAC address. MAC addresses can be displayed as a full MAC address or with a MAC OUI (Organizational Unique Identifier) prefix.

### **MAC OUI Vendor**

The vendor associated with the MAC OUI.

### **IP Address**

The end-system's IP address.

### **Switch IP**

The IP address of the switch to which the end-system is connected. If the end-system is connected to an Extreme Access Control Controller engine, this is the Extreme Access Control Controller PEP (Policy Enforcement Point) IP address.

### **Switch Port**

The port alias (if defined) followed by the switch port number to which the end-system connected. If the end-system is connected to a Layer 2 Extreme Access Control Controller engine, this is the Extreme Access Control Controller PEP (Policy Enforcement Point) port. However, for Layer 3 Extreme Access Control Controller engines this column is blank.

If you add or update the port alias on the switch, you must enforce the Extreme Access Control engine in order for the new information to be displayed in the End-Systems table.

If you don't want the port alias displayed, remove the `PORT_DESCRIPTION_FORMAT` variable from the `/opt/nac/server/config/config.properties` file. If this variable is removed, only the switch port number is displayed.

**Username**

The username used to connect.

**Hostname**

The end-system's hostname.

**Device Family**

The hardware family or the operating system family for the end-system.

**Device Type**

The hardware type or the operating system type for the end-system.

**Authentication Type**

Identifies the latest [authentication method](#) used by the end-system to connect to the network. (For Layer 3 Extreme Access Control Controller engines, this column displays "IP.")

**Authorization**

The attributes returned by the RADIUS server for this end-system. If the end-system is connected to a switch that supports multi-authentication, then this column may not reflect the actual active policy for the authenticated user. For Layer 3 Extreme Access Control Controller engines, this column displays the policy assigned to the end-system for its authorization.

**Profile**

The name of the Extreme Access Control profile that was assigned to the end-system when it connected to the network.

**Risk**

The overall risk level assigned to the end-system based on the health result of the scan:

- Red — High Risk
- Orange — Medium Risk
- Yellow — Low Risk
- Green — No Risk
- Gray — Unknown

**Reason**

Provides additional information about the reasons why the end-system is in its particular connection state. It gives you an idea as to why a certain policy was applied to the end-system or why the end-system was rejected.

**Extended State**

Provides additional information about the end-system's connection state.

**State Description**

This column provides more details about the end-system state.

**Last Seen**

The last time the end-system was seen by the Extreme Access Control engine.

**First Seen**

The first time the end-system was seen by the Extreme Access Control engine.

**Last Scanned**

The last time an assessment (scan) was performed on the end-system.

**Last Scan Result**

The last scan result assigned to the end-system: Scan, Accept, Quarantine, Reject, Error. This is the state assigned to the end-system as a result of the last completed scan. This typically matches the end-system [State](#) if scanning is currently enabled and has been performed recently.

**Extreme Access Control Engines/Source IP**

The Extreme Access Control engine to which the end-system is connecting.

**Engine Group**

This column is only displayed if you have multiple engine groups. It displays what engine group the Extreme Access Control engine was in when the end-system event was generated. For example, if the engine was in Engine Group A when an end-system connected, but then later the engine was moved to Engine Group B, this column would still list Engine Group A for that end-system's entry.

**Switch Location**

The physical location of the switch to which the end-system connected. If the end-system is connected to an Extreme Access Control Controller engine, this is the Extreme Access Control Controller PEP (Policy Enforcement Point) location.

**All Authentication Types**

This column displays all the authentication methods the end-system has used to authenticate. The authentication types are listed in order of precedence from highest to lowest: Switch Quarantine, 802.1X, CHAP, PAP, Kerberos, MAC, CEP, RADIUS Snooping, Auto Tracking. View details about each authentication session (such as the Extreme Access Control profile that was assigned to the end-system for each authentication type) in the [End-System Events tab](#).

### **RFC3580 VLAN**

For end-systems connected to RFC 3580-enabled switches, this is the RFC3580 VLAN ID assigned to the end-system.

### **Score**

The total sum of the scores for all the health details that were included as part of the quarantine decision.

### **Top Score**

The highest score received for a health detail in the health result.

### **Actual Score**

The actual score is what the total score would be if all the health details including those marked Informational and Warning were included in the score.

### **Custom 1**

Use this column to add additional information you want to display. To add or edit custom information, right-click on the table and select **Edit Custom Information**. You can add information for up to four Custom columns. The columns for Custom 2, Custom 3, and Custom 4 are hidden by default. To display these columns, click the down arrow to the right of the table header and select Columns > Column 2, Column 3, or Column 4.

### **Groups**

Displays any end-system and/or user groups to which the end-system belongs.

### **Zone**

Displays the [end-system zone](#) to which the end-system is assigned.

## Actions

---

**TIP:** These actions are also available from the right-click menu off an end-system entry in the table.

---

### **Force Reauth**

Forces the selected end-system to re-authenticate. End-systems authenticated to a VPN device are disconnected from the VPN.

### **Force Reauth and Scan**

Forces the selected end-system to re-authenticate and undergo an assessment (scan). (End-systems authenticated to a VPN device are disconnected from the VPN.) The assessment only takes place if scanning is enabled in the Extreme Access Control profile assigned to the end-system.

### **Add to Group**

Lets you add the selected end-system to a specific end-system or user group. If the end-system is a registered device, it can be added to a registration group. After adding an end-system to a group, any rules created that involved that group apply to the end-system as well. Changes to end-system group membership do not require an enforce and are synchronized with engines immediately. Changes do not affect the end-system until the next authentication or assessment occurs.

### **Lock MAC**

Opens the [Add MAC Lock window](#) where you can lock the MAC address of the selected end-system to a switch or switch and port.

### **Show Details**

Opens the [End-System Details tab](#) where you can view summary information for the end-system selected in the table.

### **Delete**

Deletes the selected end-system entries from the table and also deletes the associated end-system events. You are given the option to delete any custom information, group assignment, MAC locks, and registration and web authentication associated with the end-systems.

The Force Delete of End-System option completely deletes the end-system from Extreme Management Center, regardless of whether the end-system reauthentication is successful when the delete is executed. The option is deselected by default. When deselected, it prevents possible synchronization conditions where the authentication session remains active on the switch even though the end-system has been deleted from Extreme Management Center. These conditions can occur when there are underlying issues that prevent the end-system reauthentication from completing properly.

---

**NOTES:** The Delete operation does not remove an end-system from the Blacklist group. Blacklist is a special group that requires end-systems to be manually removed using the [Edit End-System Group window](#).

Deleting an end-system from the table also deletes the user's current authentication. If the user is connected to the network at the time of the delete, they are forced to re-authenticate.

---

## Menu Buttons

The menu at the top of the window contains most of the options available via a right-click previously mentioned in the [Actions](#) section above, as well as the End-System Events button, described below.

### End-System Events

Opens the [End-System Events tab](#) where you can view information about events for the end-system selected in the table.

## End-System Events Tab

This tab displays historical connection information for the end-system selected in the table above. End-system events are stored daily in the database. In addition, the end-system event cache stores in memory the most recent end-system events and displays them here in this tab. This cache allows Extreme Management Center to quickly retrieve and display end-system events without having to search through the database. You can configure parameters for the event cache (such as the number of events to display) using the [End-System Event Cache options](#) in the Extreme Access Control Options view (Administration > Options > Extreme Access Control > End-Systems Event Cache).

**NOTE:** The **End-System Events** tab displays events up to the most recent delete event for the end-system, if one exists. If you want to see events that happened prior to the most recent delete event, use the **Search for Older Events** button.

State	Time Stamp	Access Con...	Profile	IP Address	MAC Address	User Name	Host Name	Device Family	Device Type	State Descr...	Extended S...
✓	1/22/2017 4:...		Default NAC...		00:1C:23:3D...		ENTERAS...	Windows	Windows Vis...	Resolving IP...	
✓	1/22/2017 4:...		Default NAC...		00:1C:23:3D...		ENTERAS...	Windows	Windows Vis...	No Error	
✓	1/22/2017 4:...		Default NAC...		00:1C:23:3D...		ENTERAS...	Windows	Windows Vis...	Resolving IP...	
✓	1/22/2017 4:...		Default NAC...		00:1C:23:3D...		ENTERAS...	Windows	Windows Vis...	No Error	
✓	1/22/2017 4:...		Default NAC...		00:1C:23:3D...		ENTERAS...	Windows	Windows Vis...	Resolving IP...	
✓	1/22/2017 4:...		Default NAC...		00:1C:23:3D...		ENTERAS...	Windows	Windows Vis...	No Error	
✓	1/22/2017 4:...		Default NAC...		00:1C:23:3D...		ENTERAS...	Windows	Windows Vis...	Resolving IP...	
✓	1/22/2017 4:...		Default NAC...		00:1C:23:3D...		ENTERAS...	Windows	Windows Vis...	No Error	
✓	1/22/2017 4:...		Default NAC...		00:1C:23:3D...		ENTERAS...	Windows	Windows Vis...	Resolving IP...	
✓	1/22/2017 4:...		Default NAC...		00:1C:23:3D...		ENTERAS...	Windows	Windows Vis...	No Error	
✓	1/22/2017 4:...		Default NAC...		00:1C:23:3D...		ENTERAS...	Windows	Windows Vis...	Resolving IP...	
✓	1/22/2017 4:...		Default NAC...		00:1C:23:3D...		ENTERAS...	Windows	Windows Vis...	No Error	

**State**

The end-system's connection state:

- Scan — The end-system was scanned.
- Accept — The end-system was granted access with either the Accept policy or the attributes returned from the RADIUS server.
- Quarantine — The end-system was quarantined because the assessment failed.
- Reject — The end-system was rejected because the assigned Extreme Access Control profile was set to Reject, the MAC Locking test failed, or the RADIUS server was reachable but rejected the authentication request.
- Disconnected — This end-system session was disconnected, however other sessions for the end-system may still be active. For example, the end-system may have a disconnected session with an authentication type of 802.1X, but still have an active MAC authentication session. This state is only applicable for end-systems connected to switches that have RADIUS accounting enabled.
- Error — Indicates one of nine problems:
  - the MAC to IP resolution failed
  - the MAC to IP resolution timed out
  - all RADIUS servers are unreachable
  - the RADIUS request was non-compliant
  - all assessment servers are unavailable
  - the assessment server can't reach the end-system
  - no assessment servers are configured
  - the assessment server is not compatible with the current version of Extreme Management Center
  - the username and password configured in the [Assessment Server panel](#) of the Extreme Access Control options (Administration > Options > Extreme Access Control > Assessment Server) are incorrect for the assessment server

**Time Stamp**

The date and time the end-system connected.

**IP Address**

The end-system's IP address.



**Switch IP**

The IP address of the switch to which the end-system connected. If the end-system is connected to an Extreme Access Control Controller engine, this is the Extreme Access Control Controller PEP (Policy Enforcement Point) IP address.

**Switch Nickname**

The nickname defined for the switch to which the end-system is connected.

**Switch Port**

The switch port number to which the end-system is connected. If the end-system is connected to a Layer 2 Extreme Access Control Controller engine, this is the Extreme Access Control Controller PEP (Policy Enforcement Point) port. However, for Layer 3 Extreme Access Control Controller engines this column is blank.

**Username**

The username used to connect.

**Hostname**

The end-system's host name.

**Device Family**

The hardware family or the operating system family for the end-system.

**Device Type**

The hardware type or the operating system type for the end-system.

**Authentication Type**

Identifies the authentication method used by the end-system to connect to the network. For Layer 3 Extreme Access Control Controller engines, this column shows IP.

**Authorization**

The attributes returned by the RADIUS server. If the end-system is connected to a switch that supports multi-authentication, then this column may not reflect the actual active policy for the authenticated user. For Layer 3 Extreme Access Control Controller engines, this column displays the policy assigned to the end-system for its authorization.

**Profile**

The name of the Extreme Access Control profile assigned to the end-system when it connected to the network.

**Reason**

Provides additional information about the reasons why the end-system is in its particular connection state. It provides information as to the reason a policy is applied to the end-system or the reason the end-system is rejected.

**Extended State**

Provides additional information about the end-system's connection state.

**State Description**

This column provides more details about the end-system state. For example, if the end-system's connection state is Reject, this column might list the RADIUS server (primary or secondary) that rejected the authentication request.

**Switch Location**

The physical location of the switch to which the end-system is connected. If the end-system is connected to an Extreme Access Control Controller engine, this is the Extreme Access Control Controller PEP (Policy Enforcement Point) location.

**Engine Group**

This column is only displayed if you have multiple engine groups. It displays what engine group the Extreme Access Control engine is in when the end-system event was generated. For example, if the engine began in Engine Group A when an end-system connected, then the engine is moved to Engine Group B, this column still lists Engine Group A for that end-system's entry.

**Zone**

Displays the end-system zone to which the end-system is assigned. For additional information, see [End-System Zones](#).

**Search for Older Events**

This button lets you search for older events stored in the database outside of the end-system events cache. The maximum search parameters for this extended search are configured in the [End-System Event Cache options](#) in the Extreme Access Control Options view (Administration > Options > Extreme Access Control > End-System Event Cache). The search is ended when any one of the parameters is reached.

- Maximum number of results to return from search
- Maximum time to spend searching for events (in seconds)
- Maximum number of days to go back when searching

## Related Information

For information on related topics:

- [Add MAC Lock Window](#)
- [End-System Details Tab](#)

## Add/Edit MAC Lock

Use this window to add a new locked MAC address or edit the settings for an existing locked MAC address. MAC Locking lets you lock a MAC address to a specific switch or port on a switch so that the end-system can only access the network from that port or switch. If the end-system tries to authenticate on a different switch/port, it is rejected or assigned a specific policy. You can add or edit MAC locks from the [End-Systems tab](#).

**NOTE:** MAC Locking to a specific port on a switch is based on the port interface name (e.g. fe5.1). If a switch board is moved to a different slot in a chassis, or if a stack reorders itself, this name changes and breaks the MAC Locking settings.

The screenshot shows the 'Add MAC Lock' dialog box. The 'MAC Address' field is filled with '00:1C:23:3D:18:20'. The 'Switch IP' field is empty. The 'Lock to Switch and Port' checkbox is checked. The 'Switch Port' field is filled with '1:48'. The 'Failed Action' section is expanded, showing the 'Reject' radio button selected and the 'Use Policy' radio button unselected. Below the radio buttons is a dropdown menu. The 'OK' button is highlighted in blue, and the 'Cancel' button is greyed out.

### MAC Address

Enter the MAC address that you want to lock.

### Switch IP

Enter the IP address of the switch on which you want to lock the MAC address.

### Lock to Switch and Port

Select this checkbox if you want to lock the MAC address to a specific port on the switch, and enter the port interface name.

### **Failed Action**

Select the action to take when this MAC address tries to authenticate on a different port and/or switch:

- Reject - The authentication request is rejected.
- Use Policy - Use the drop-down list to select the policy that you want applied. This policy must exist in the **Policy** tab and be enforced to the switches in your network.

---

### **Related Information**

For information on related windows:

- [End-Systems Tab](#)