

Brocade SLX-OS Layer 3 Configuration Guide, 17s.1.00

Supporting the Brocade SLX 9140 and SLX 9240 Switches

© 2017, Brocade Communications Systems, Inc. All Rights Reserved.

Brocade, the B-wing symbol, and MyBrocade are registered trademarks of Brocade Communications Systems, Inc., in the United States and in other countries. Other brands, product names, or service names mentioned of Brocade Communications Systems, Inc. are listed at www.brocade.com/en/legal/brocade-Legal-intellectual-property/brocade-legal-trademarks.html. Other marks may belong to third parties.

Notice: This document is for informational purposes only and does not set forth any warranty, expressed or implied, concerning any equipment, equipment feature, or service offered or to be offered by Brocade. Brocade reserves the right to make changes to this document at any time, without notice, and assumes no responsibility for its use. This informational document describes features that may not be currently available. Contact a Brocade sales office for information on feature and product availability. Export of technical data contained in this document may require an export license from the United States government.

The authors and Brocade Communications Systems, Inc. assume no liability or responsibility to any person or entity with respect to the accuracy of this document or any loss, cost, liability, or damages arising from the information contained herein or the computer programs that accompany it.

The product described by this document may contain open source software covered by the GNU General Public License or other open source license agreements. To find out which open source software is included in Brocade products, view the licensing terms applicable to the open source software, and obtain a copy of the programming source code, please visit <http://www.brocade.com/support/oscd>.

Contents

Preface	13
Document conventions.....	13
Notes, cautions, and warnings.....	13
Text formatting conventions.....	13
Command syntax conventions.....	14
Brocade resources.....	14
Document feedback.....	14
Contacting Brocade Technical Support.....	15
Brocade customers.....	15
Brocade OEM customers.....	15
About This Document	17
What's new in this document.....	17
Supported hardware and software.....	17
ARP	19
Basic ARP configuration.....	19
Modifying the ARP aging timeout.....	19
Creating static ARP entries.....	20
Creating a VRF static ARP entry.....	20
Proxy ARP.....	20
ARP show and clear commands.....	21
Dynamic ARP Inspection (DAI).....	22
ARP poisoning.....	22
DAI functionality.....	22
DAI implementation.....	23
DAI show and clear commands.....	25
IP Addressing	27
IP addressing overview.....	27
IPv4 address classes.....	27
IP Interfaces.....	27
The ARP cache.....	28
31-bit subnet masks on point-to-point networks.....	28
Basic IP parameters and defaults.....	28
Parameter changes in effect.....	28
IP interface parameters.....	29
Assigning IP addresses to interfaces.....	30
Assigning an IP address to a loopback.....	30
Assigning IP addresses to Ethernet interfaces.....	30
Deleting an IP address from an interface.....	31
Router-ID IP addresses.....	32
Assigning a router-ID IP address.....	32
DNS.....	32
DNS Server.....	33
DNS Resolver.....	33
DNS Gateway Addresses.....	33
Configuring DNS.....	33

Source IP address for various packet types.....	34
Telnet packets.....	34
IPv4 MTU settings.....	35
IPv4 MTU and maximum frame size.....	35
Changing IPv4 MTU on an interface.....	35
IP addressing Show and Clear commands.....	36
IPv6 Addressing.....	37
IPv6 addressing overview.....	37
Configuring an IPv6 address on a Brocade device.....	38
IPv6 management.....	38
Configuring IPv6 management ACLs.....	38
Specifying an IPv6 SNMP trap receiver.....	38
Secure Shell, SCP, and IPv6.....	39
IPv6 Telnet.....	39
Establishing a Telnet session from an IPv6 host.....	39
IPv6 traceroute.....	39
Restricting Web management access.....	39
IPv6 neighbor discovery configuration.....	39
IPv6 neighbor discovery configuration notes.....	40
Router advertisement and solicitation messages.....	40
Neighbor redirect messages.....	40
Duplicate Address Detection (DAD).....	41
Configuring IPv6 static neighbor entries.....	41
IPv6 router advertisement parameters.....	41
Setting IPv6 router advertisement parameters.....	42
Setting flags in IPv6 router advertisement messages.....	42
Sending or Suppressing IPV6 Router Advertisements and Addresses.....	43
IPv6 router advertisement preference support.....	43
Configuring IPv6 RA preference.....	43
Reachable time for remote IPv6 nodes.....	44
Configuring reachable time for remote IPv6 nodes.....	44
Configuring an IPv6 domain name and server.....	44
IPv6 MTU.....	44
Changing IPv6 MTU.....	45
Information about IPv6 prefix list.....	45
Configuring an IPv6 prefix list.....	45
Displaying prefix list information.....	46
Displaying global IPv6 information.....	46
Displaying IPv6 interface information.....	46
Displaying IPv6 neighbor information.....	46
Displaying the IPv6 route table.....	47
Clearing global IPv6 information.....	47
Clearing IPv6 neighbor information.....	47
Clearing IPv6 routes from the IPv6 route table.....	47
IPv4 Static Routing.....	49
Overview of static routing.....	49
Static route states follow port states.....	50
Configuring a basic IP static route.....	50
Adding metrics to a static route.....	51

Configuring a physical interface as next hop.....	51
Configuring a virtual interface as next hop.....	52
Configuring a static route with a VRF as next hop.....	52
Configuring a static route for use with a route map.....	53
Configuring a null route.....	53
Configuring a default static route.....	55
Configuring load sharing and redundancy.....	55
Displaying IPv4 static routes.....	57
IPv6 Static Routing.....	59
Overview of static routing.....	59
Static route states follow port states.....	60
Configuring a basic IPv6 static route.....	60
Removing an IPv6 static route.....	61
Removing an IPv6 static route in a non-default VRF.....	62
Configuring an interface as next hop.....	62
Configuring a virtual interface as next hop.....	63
Configuring a VRF as next hop for an IPv6 static route.....	64
Adding metrics to an IPv6 static route.....	64
Configuring a null route.....	65
Configuring a default static route.....	67
Configuring load sharing and redundancy.....	67
Adding an IPv6 static route tag for use with route-maps.....	69
Displaying information on IPv6 static routes.....	70
DHCPv4.....	71
DHCPv4 overview.....	71
IP DHCP Relay function.....	71
Configuring IP DHCP Relay.....	72
DHCP relay agent supported user scenarios.....	74
DHCP server local.....	74
DHCP server remote.....	74
DHCP servers in a network.....	74
Multiple DHCP servers.....	74
DHCP server in different VRFs.....	75
DHCP relay agent information option 82.....	75
Enabling the DHCP Relay Agent Information option.....	76
Configuring DHCP relay gateway address.....	76
VRF support.....	77
Supported VRF configuration examples.....	77
VRF configuration examples to avoid.....	78
Displaying IP DHCP Relay statistics.....	78
Displaying IP DHCP Relay addresses on specific devices.....	79
Displaying IP DHCP relay addresses for an interface.....	79
Clearing IP DHCP relay statistics.....	79
DHCPv6.....	81
DHCPv6 overview.....	81
DHCP relay agent for IPv6.....	81
DHCPv6 multicast addresses and UDP ports.....	81
Multicast addresses.....	81
UDP ports.....	82

DHCPv6 address assignment.....	82
Basic DHCPv6 relay assignment.....	82
DHCPv6 prefix delegation.....	82
Relay chaining.....	82
Relay-message option.....	82
Remote-ID option.....	82
Interface-ID option.....	82
DHCPv6 message format.....	82
Configuring IPv6 DHCP relay.....	84
Displaying DHCPv6 relay addresses on specific devices.....	85
Displaying DHCPv6 relay addresses for an interface.....	85
Displaying IPv6 DHCP relay statistics.....	86
Clearing IP DHCPv6 relay statistics.....	86
BFD.....	87
Bidirectional Forwarding Detection overview.....	87
General BFD considerations and limitations.....	88
BFD for Layer 3 protocols.....	88
BFD considerations and limitations for Layer 3 protocols.....	89
BFD for Layer 3 protocols on virtual Ethernet interfaces.....	90
Configuring BFD on an interface.....	90
Disabling BFD on an interface.....	90
BFD for BGP.....	91
BFD for BGP session creation and deletion.....	91
Configuring BFD session parameters for BGP.....	92
Enabling BFD sessions for a specified BGP neighbor.....	92
Enabling BFD sessions for a specified BGP neighbor in a nondefault VRF.....	93
Enabling BFD sessions for a specified BGP peer group.....	94
BFD for OSPF.....	94
BFD for OSPF session creation and deletion.....	95
Enabling BFD on a specified OSPFv2-enabled interface.....	95
Configuring BFD for OSPFv2 globally.....	96
Configuring BFD for OSPFv2 globally in a nondefault VRF instance.....	96
Enabling BFD on a specified OSPFv3-enabled interface.....	97
Configuring BFD for OSPFv3 globally.....	97
Configuring BFD for OSPFv3 globally in a nondefault VRF instance.....	98
BFD for static routes.....	98
BFD considerations and limitations for static routes.....	99
BFD for static routes configuration.....	99
Configuring BFD on an IP static route.....	100
Configuring BFD on an IP static route in a nondefault VRF instance.....	101
Configuring BFD on an IPv6 static route.....	101
Configuring BFD on an IPv6 static route in a nondefault VRF instance.....	102
Displaying BFD information.....	103
BGP4.....	107
BGP4 overview.....	108
BGP4 peering.....	108
BGP4 message types.....	108
OPEN message.....	109
UPDATE message.....	109

NOTIFICATION message.....	110
KEEPALIVE message.....	110
REFRESH message.....	110
BGP4 attributes.....	111
BGP4 best path selection algorithm.....	111
Device ID.....	112
BGP global mode	112
Configuring a local AS number.....	113
IPv4 unicast address family.....	113
Neighbor configuration.....	114
Configuring BGP4 neighbors.....	115
Peer groups.....	115
Configuring BGP4 peer groups.....	116
Advertising the default BGP4 route.....	116
Four-byte AS numbers.....	117
Enabling ASN capability globally.....	117
Enabling ASN capability for a BGP4 neighbor.....	118
Cooperative BGP4 route filtering.....	118
BGP4 parameters.....	119
Route redistribution.....	120
Redistributing routes into BGP4.....	120
Advertised networks.....	120
Importing routes into BGP4.....	121
Static networks.....	121
Configuring a static network.....	121
Route reflection.....	122
Configuring a cluster ID for a route reflector.....	122
Configuring a route reflector client.....	123
Route flap dampening.....	123
Aggregating routes advertised to BGP neighbors.....	124
Advertising the default BGP4 route.....	124
Advertising the default BGP4 route to a specific neighbor.....	125
Multipath load sharing.....	125
Specifying the weight added to received routes.....	126
Using the IPv4 default route as a valid next hop for a BGP4 route.....	126
Adjusting defaults to improve routing performance.....	127
Next-hop recursion.....	127
Enabling next-hop recursion.....	127
Route filtering.....	128
Timers.....	128
Enabling BGP4 in a non-default VRF.....	128
BGP4 outbound route filtering.....	129
Configuring BGP4 outbound route filtering.....	129
Enabling BGP4 cooperative route filtering.....	130
BGP4 confederations.....	131
Configuring BGP4 confederations.....	131
Auto shutdown of BGP neighbors on initial configuration.....	132
Configuring auto shutdown of BGP neighbors on initial configuration.....	132
Disabling the BGP4 peer shutdown state.....	133
Generalized TTL Security Mechanism support.....	133

Assumptions and limitations.....	133
Configuring GTSM for BGP4.....	134
Disabling the BGP AS_PATH check function.....	134
Using route maps.....	135
Matching on an AS-path.....	136
Matching on a community ACL.....	136
Matching on a destination network.....	137
Matching on a BGP4 static network.....	137
Matching on a next-hop device.....	138
Matching on an interface.....	139
Using route-map continue statements.....	139
Route-map continue statement for BGP4 routes.....	140
Using a route map to configure dampening.....	140
Clearing diagnostic buffers.....	141
Displaying BGP4 statistics.....	142
Displaying BGP4 neighbor statistics.....	145
Clearing BGP4 dampened paths.....	149
BGP4+.....	151
BGP4+ overview.....	151
BGP global mode	151
IPv6 unicast address family.....	152
BGP4+ neighbors.....	153
Configuring BGP4+ neighbors using global IPv6 addresses.....	153
Configuring BGP4+ neighbors using link-local addresses.....	154
BGP4+ peer groups.....	155
Configuring BGP4+ peer groups.....	155
Configuring a peer group with IPv4 and IPv6 peers.....	156
Enabling ASN capability globally.....	157
Enabling ASN capability for a BGP4+ neighbor.....	157
Importing routes into BGP4+.....	158
Advertising the default BGP4+ route.....	159
Advertising the default BGP4+ route to a specific neighbor.....	159
Using the IPv6 default route as a valid next hop for a BGP4+ route.....	160
BGP4+ next hop recursion.....	160
Enabling next-hop recursion.....	161
BGP4+ NLRIs and next hop attributes.....	161
BGP4+ route reflection.....	162
Configuring a cluster ID for a route reflector.....	162
Configuring a route reflector client.....	163
BGP4+ route aggregation.....	163
Aggregating routes advertised to BGP neighbors.....	163
BGP4+ multipath.....	164
Enabling load-balancing across different paths.....	164
Route maps.....	165
Configuring a route map for BGP4+ prefixes.....	165
Redistributing prefixes into BGP4+.....	166
Redistributing routes into BGP4+.....	167
Specifying the weight added to BGP4+ received routes.....	167
Enabling BGP4+ in a non-default VRF.....	168
BGP4+ outbound route filtering.....	168

Configuring BGP4+ outbound route filtering.....	169
BGP4+ confederations.....	170
Configuring BGP4+ confederations.....	170
Auto shutdown of BGP neighbors on initial configuration.....	171
Configuring auto shutdown of BGP neighbors on initial configuration.....	171
Disabling the BGP4+ peer shutdown state.....	172
Generalized TTL Security Mechanism support.....	172
Assumptions and limitations.....	172
Configuring GTSM for BGP4+.....	173
Disabling the BGP AS_PATH check function.....	173
Displaying BGP4+ statistics.....	174
Displaying BGP4+ neighbor statistics.....	176
Clearing BGP4+ dampened paths.....	178
OSPFv2.....	181
OSPFv2 overview.....	181
Autonomous System.....	181
OSPFv2 components and roles.....	182
Area Border Routers.....	182
Autonomous System Boundary Routers.....	183
Designated routers.....	183
Enabling OSPFv2.....	184
Backbone area.....	184
Assigning OSPFv2 areas.....	184
Area range.....	185
Assigning an area range.....	185
Area types.....	186
Stub area and totally stubby area.....	186
Disabling summary LSAs for a stub area.....	187
Not-so-stubby area (NSSA).....	187
Configuring an NSSA.....	188
Configuring a summary-address for the NSSA.....	189
Assigning interfaces to an area.....	189
Link state advertisements.....	190
Configuring an MD5 password and authentication change hold time for an OSPFv2 interface.....	190
Virtual links.....	190
Configuring virtual links.....	191
Default route origination.....	192
External route summarization.....	193
Modifying Shortest Path First timers.....	193
OSPFv2 administrative distance.....	194
Configuring administrative distance based on route type.....	194
OSPFv2 LSA refreshes.....	195
Configuring the OSPFv2 LSA pacing interval.....	195
Redistributing routes into OSPFv2.....	196
OSPFv2 type 3 LSA filtering.....	196
Usage and configuration guidelines.....	197
Configuring OSPFv2 type 3 LSA filtering.....	198
OSPFv2 over VRF.....	198
Enabling OSPFv2 in a non-default VRF.....	199
Configuring the OSPFv2 Max-Metric Router LSA.....	199

Re-enabling OSPFv2 compatibility with RFC 1583.....	200
Changing default settings.....	200
Disabling and re-enabling OSPFv2 event logging.....	200
Understanding the effects of disabling OSPFv2.....	201
Displaying OSPFv2 results.....	201
OSPFv3.....	203
OSPFv3 overview.....	203
Configuring the router ID.....	204
Enabling OSPFv3.....	204
Configuring OSPFv3.....	204
OSPFv3 areas.....	205
Backbone area.....	205
Area range.....	205
Area types.....	205
Assigning OSPFv3 areas.....	206
Assigning OSPFv3 areas to interfaces.....	206
Stub area and totally stubby area.....	207
Configuring a stub area.....	208
Not-so-stubby area.....	208
Configuring an NSSA.....	209
LSA types for OSPFv3.....	209
Virtual links.....	210
Virtual link source address assignment.....	212
Configuring virtual links.....	212
OSPFv3 route redistribution.....	213
Redistributing routes into OSPFv3.....	214
Default route origination.....	215
Configuring default external routes.....	215
Filtering OSPFv3 routes.....	215
SPF timers.....	216
Modifying SPF timers.....	216
OSPFv3 administrative distance.....	217
Configuring administrative distance based on route type.....	217
Changing the reference bandwidth for the cost on OSPFv3 interfaces.....	218
OSPFv3 LSA refreshes.....	218
Configuring the OSPFv3 LSA pacing interval.....	219
External route summarization.....	219
OSPFv3 over VRF.....	220
Enabling OSPFv3 in a non-default VRF.....	220
Setting all OSPFv3 interfaces to the passive state.....	220
OSPFv3 max-metric router LSA.....	221
Configuring the OSPFv3 max-metric router LSA.....	221
IPsec for OSPFv3.....	222
IPsec for OSPFv3 configuration.....	223
Configuring IPsec on an OSPFv3 area.....	223
Configuring IPsec on an OSPFv3 interface.....	224
Configuring IPsec on OSPFv3 virtual links.....	224
Specifying the key rollover and key add-remove timers.....	225
Displaying OSPFv3 results.....	226

Multi-VRF.....	229
Multi-VRF overview.....	229
Configuring Multi-VRF.....	231
Configuring a VRF instance.....	231
Starting a routing process for a VRF.....	231
Assigning a Layer 3 interface to a VRF.....	232
Assigning a loopback interface to a VRF.....	232
Verifying a Multi-VRF configuration.....	233
Removing a VRF configuration.....	233
Configuring the maximum number of routes.....	234
Multi-VRF configuration example.....	234
Multi-VRF with eBGP and OSPF: Configuring PE1.....	236
Multi-VRF with eBGP and OSPF: Configuring PE2.....	239
Multi-VRF with eBGP and OSPF: Configuring CE1 and CE2.....	240
Multi-VRF with eBGP and OSPF: Configuring CE3 and CE4.....	240
Inter-VRF route leaking.....	240
Dynamic route-leak restrictions.....	241
Inter-VRF route conflicts	241
Configuring static inter-VRF route leaking.....	242
Configuring dynamic inter-VRF route leaking.....	245
VRRPv2.....	249
VRRPv2 overview.....	249
VRRP terminology.....	251
SLX-OS VRRP and VRRP-E interoperability.....	252
VRRP hold timer.....	252
VRRP interval timers.....	253
VRRP authentication.....	253
ARP and VRRP control packets.....	253
Enabling a master VRRP device.....	254
Enabling a backup VRRP device.....	255
VRRP multigroup clusters.....	256
Configuring multigroup VRRP routing.....	257
Tracked ports and track priority with VRRP and VRRP-E.....	259
Configuring VRRP port tracking.....	259
VRRP owner preemption and interface tracking.....	261
Enabling VRRP owner preemption and interface tracking.....	261
VRRP backup preemption.....	262
Enabling VRRP backup preemption.....	262
Virtual router MAC address.....	263
Configuring unique virtual MAC addresses per VRID.....	264
VRRP-Ev2 overview.....	265
Enabling a VRRP-E device.....	266
Configuring MD5 authentication on IPv4 VRRP-E interfaces.....	267
Track routes and track priority with VRRP-E.....	268
Configuring VRRP-E route tracking.....	269
VRRP-E load-balancing using short-path forwarding.....	270
Packet routing with short-path forwarding to balance traffic load.....	270
Short-path forwarding with revert priority.....	271
Configuring VRRP-E load-balancing using short-path forwarding.....	272
Displaying VRRPv2 information.....	272

Clearing VRRPv2 statistics.....	274
VRRPv3.....	277
VRRPv3 overview.....	277
Enabling IPv6 VRRPv3.....	278
Enabling IPv4 VRRPv3.....	279
Tracked ports and track priority with VRRP and VRRP-E.....	280
Port tracking using IPv6 VRRPv3.....	280
VRRP hold timer.....	281
Configuring VRRP hold timer support.....	281
Alternate VRRPv2 checksum for VRRPv3 IPv4 sessions.....	283
Enabling the v2 checksum computation method in a VRRPv3 IPv4 session.....	283
VRRPv3 router advertisement suppression.....	284
Disabling VRRPv3 router advertisements.....	284
Displaying VRRPv3 statistics.....	284
Clearing VRRPv3 statistics.....	286
VRRP-Ev3 Overview.....	287
Enabling IPv6 VRRP-Ev3.....	287
Configuring MD5 authentication on IPv6 VRRP-Ev3 interfaces.....	288
VRRP-E load-balancing using short-path forwarding.....	289
Packet routing with short-path forwarding to balance traffic load.....	289
Short-path forwarding with revert priority.....	290
Configuring VRRP-Ev3 load-balancing.....	291
Displaying and clearing VRRP-Ev3 statistics.....	291

Preface

- Document conventions..... 13
- Brocade resources..... 14
- Document feedback..... 14
- Contacting Brocade Technical Support..... 15

Document conventions

The document conventions describe text formatting conventions, command syntax conventions, and important notice formats used in Brocade technical documentation.

Notes, cautions, and warnings

Notes, cautions, and warning statements may be used in this document. They are listed in the order of increasing severity of potential hazards.

NOTE

A Note provides a tip, guidance, or advice, emphasizes important information, or provides a reference to related information.

ATTENTION

An Attention statement indicates a stronger note, for example, to alert you when traffic might be interrupted or the device might reboot.



CAUTION

A Caution statement alerts you to situations that can be potentially hazardous to you or cause damage to hardware, firmware, software, or data.



DANGER

A Danger statement indicates conditions or situations that can be potentially lethal or extremely hazardous to you. Safety labels are also attached directly to products to warn of these conditions or situations.

Text formatting conventions

Text formatting conventions such as boldface, italic, or Courier font may be used to highlight specific words or phrases.

Format	Description
bold text	Identifies command names. Identifies keywords and operands. Identifies the names of GUI elements.
<i>italic text</i>	Identifies text to enter in the GUI. Identifies emphasis. Identifies variables.
Courier font	Identifies document titles. Identifies CLI output.

Format	Description
	Identifies command syntax examples.

Command syntax conventions

Bold and italic text identify command syntax components. Delimiters and operators define groupings of parameters and their logical relationships.

Convention	Description
bold text	Identifies command names, keywords, and command options.
<i>italic text</i>	Identifies a variable.
value	In Fibre Channel products, a fixed value provided as input to a command option is printed in plain text, for example, <code>--show WWN</code> .
[]	Syntax components displayed within square brackets are optional. Default responses to system prompts are enclosed in square brackets.
{ x y z }	A choice of required parameters is enclosed in curly brackets separated by vertical bars. You must select one of the options. In Fibre Channel products, square brackets may be used instead for this purpose.
x y	A vertical bar separates mutually exclusive elements.
< >	Nonprinting characters, for example, passwords, are enclosed in angle brackets.
...	Repeat the previous element, for example, <code>member[member...]</code> .
\	Indicates a "soft" line break in command examples. If a backslash separates two lines of a command input, enter the entire command at the prompt without the backslash.

Brocade resources

Visit the Brocade website to locate related documentation for your product and additional Brocade resources.

White papers, data sheets, and the most recent versions of Brocade software and hardware manuals are available at www.brocade.com. Product documentation for all supported releases is available to registered users at MyBrocade.

Click the **Support** tab and select **Document Library** to access product documentation on MyBrocade or www.brocade.com. You can locate documentation by product or by operating system.

Release notes are bundled with software downloads on MyBrocade. Links to software downloads are available on the MyBrocade landing page and in the Document Library.

Document feedback

Quality is our first concern at Brocade, and we have made every effort to ensure the accuracy and completeness of this document. However, if you find an error or an omission, or you think that a topic needs further development, we want to hear from you. You can provide feedback in two ways:

- Through the online feedback form in the HTML documents posted on www.brocade.com
- By sending your feedback to documentation@brocade.com

Provide the publication title, part number, and as much detail as possible, including the topic heading and page number if applicable, as well as your suggestions for improvement.

Contacting Brocade Technical Support

As a Brocade customer, you can contact Brocade Technical Support 24x7 online or by telephone. Brocade OEM customers should contact their OEM/solution provider.

Brocade customers

For product support information and the latest information on contacting the Technical Assistance Center, go to www.brocade.com and select **Support**.

If you have purchased Brocade product support directly from Brocade, use one of the following methods to contact the Brocade Technical Assistance Center 24x7.

Online	Telephone
<p>Preferred method of contact for non-urgent issues:</p> <ul style="list-style-type: none"> • Case management through the MyBrocade portal. • Quick Access links to Knowledge Base, Community, Document Library, Software Downloads and Licensing tools 	<p>Required for Sev 1-Critical and Sev 2-High issues:</p> <ul style="list-style-type: none"> • Continental US: 1-800-752-8061 • Europe, Middle East, Africa, and Asia Pacific: +800-AT FIBREE (+800 28 34 27 33) • Toll-free numbers are available in many countries. • For areas unable to access a toll-free number: +1-408-333-6061

Brocade OEM customers

If you have purchased Brocade product support from a Brocade OEM/solution provider, contact your OEM/solution provider for all of your product support needs.

- OEM/solution providers are trained and certified by Brocade to support Brocade® products.
- Brocade provides backline support for issues that cannot be resolved by the OEM/solution provider.
- Brocade Supplemental Support augments your existing OEM support contract, providing direct access to Brocade expertise. For more information, contact Brocade or your OEM.
- For questions regarding service levels and response times, contact your OEM/solution provider.

About This Document

- [What's new in this document.....](#) 17
- [Supported hardware and software.....](#) 17

What's new in this document

This document is the first version of the *Brocade SLX-OS Layer 3 Configuration Guide* for the Brocade SLX-OS 17s.1.00 release.

Supported hardware and software

In those instances in which procedures or parts of procedures documented here apply to some devices but not to others, this guide identifies exactly which devices are supported and which are not.

Although many different software and hardware configurations are tested and supported by Brocade Communications Systems, Inc. for SLX-OS Release 17s.1.00, documenting all possible configurations and scenarios is beyond the scope of this document.

The following hardware platforms are supported by this release:

- Brocade SLX 9140 switch
- Brocade SLX 9240 switch

NOTE

Some of the commands in this document use a slot/port designation. Because the Brocade SLX 9140 switch and the Brocade SLX 9240 switch do not contain line cards, the slot designation must always be "0" (for example, 0/1 for port 1).

To obtain information about other Brocade OS versions, refer to the documentation specific to that version.

ARP

- [Basic ARP configuration](#).....19
- [Dynamic ARP Inspection \(DAI\)](#).....22

Basic ARP configuration

The Address Resolution Protocol (ARP) maps IP network addresses to MAC hardware addresses.

When forwarding traffic, a device needs to know the destination MAC address, because each IP packet is encapsulated in an Ethernet frame. MAC addresses are needed not only for the packet's final destination but also for a next hop towards the destination. A device first searches its ARP cache; a match for the IP address supplies the corresponding MAC address. Otherwise, the device broadcasts an ARP request. The network devices receive such ARP requests, and the host with a matching IP address sends an ARP reply that includes its MAC address.

After a matching ARP reply is received by the device, the following events occur:

- The packet is sent towards its destination.
- The IP address/MAC address pair is added to the ARP cache, as a dynamic ARP entry.

An aging timer—by default 240 minutes—is triggered when a dynamic entry is added to the ARP cache and is reset if an ARP reply is received. The aging timer ensures that the ARP cache does not retain learned entries that are no longer valid. An entry can become invalid when the device with the MAC address of the entry is no longer on the network.

You can also add static ARP entries to the cache. Static entries do not time out. They are useful to preconfigure an entry for a device not yet connected or to prevent an entry from aging out.

Modifying the ARP aging timeout

The ARP aging timeout configured for an interface overrides the global aging timeout (240 minutes).

1. Enter **configure terminal** to access global configuration mode.

```
device# configure terminal
```

2. Access the interface on which you are modifying the ARP aging timeout.

```
device(config)# interface ethernet 0/1
```

3. Enter the **ip arp-aging-timeout** command, specifying the new value.

```
device(conf-if-eth-0/1)# ip arp-aging-timeout 100
```

Values range from 0 through 240 minutes.

The following example changes an interface ARP aging timeout to 100 minutes.

```
device# configure terminal
device(config)# interface ethernet 0/1
device(conf-if-eth-0/1)# ip arp-aging-timeout 100
```

Creating static ARP entries

Static ARP entries are useful to preconfigure an entry for a device not yet connected or to prevent an entry from aging out.

NOTE

You can define a static ARP entry for a physical interface or for a VE. The flow in this topic is for a physical interface.

1. Enter **configure terminal** to access global configuration mode.

```
device# configure terminal
```

2. Enter the **arp** command, specifying the IP address, the MAC address, and the interface.

```
device(config)# arp 10.53.4.2 1245.7654.2348 interface ethernet 0/2
```

The example creates a static ARP entry for IP address 10.53.4.2 and associates it with MAC address 1245.7654.2348 and physical port 0/2.

Creating a VRF static ARP entry

In a VRF instance, static ARP entries are useful to preconfigure an entry for a device not yet connected or to prevent an entry from aging out.

1. Enter **configure terminal** to access global configuration mode.

```
device# configure terminal
```

2. Enter the **vrf** command to access VRF configuration mode.

```
device(config)# vrf test
```

3. Enter the **address-family** command, specifying the needed parameters.

```
device(config-vrf-test)# address-family ipv4 unicast
```

4. Enter the **arp** command, specifying the IP address, the MAC address, and the interface.

```
device(vrf-test-ipv4-unicast)# arp 10.6.6.7 0001.0001.0001 interface ethernet 0/1
```

The following example accesses a VRF instance, specifies the address family, and defines a static ARP.

```
device# configure terminal
device(config)# vrf test
device(config-vrf-test)# address-family ipv4 unicast
device(vrf-test-ipv4-unicast)# arp 10.6.6.7 0001.0001.0001 interface ethernet 0/1
```

Proxy ARP

Proxy ARP allows a device to answer ARP requests from devices in one network on behalf of devices in another network.

Because ARP requests are MAC-layer broadcasts, they reach only the devices that are directly connected to the sender of the ARP request. ARP requests do not cross routers.

However, if Proxy ARP is enabled on a device connected to two subnets, the device can respond to an ARP request from the other subnet. For example, if it is connected to the two subnets 10.10.10.0/24 and 10.20.20.0/24, the device can respond to an ARP

request from 10.10.10.69 for the MAC address of the device with the IP address 10.20.20.69. In standard ARP, a request from a device in the 10.10.10.0/24 subnet cannot reach a device in the 10.20.20.0 subnet. Consequently, the request is not answered.

The ARP reply returned contains the device's MAC address instead of the MAC address of the target host. In this transaction, the traffic sent to the target host is forwarded through Layer 3 rather than being switched through Layer 2.

NOTE

Under some Layer 2 configurations such as an uplink switch or private VLAN, broadcast packets are not flooded to every port in a VLAN. In these configurations, an ARP request from one host may not reach another host. Enabling Proxy ARP locally on a port directs the device to reply on behalf of a target host if it exists.

Enabling Proxy ARP on an interface

Complete the following steps to enable Proxy ARP on a physical or VE interface.

NOTE

Proxy ARP is enabled by default.

1. Enter **configure terminal** to access global configuration mode.

```
device# configure terminal
```

2. Access the interface on which you are enabling Proxy ARP.

```
device(config)# interface ethernet 0/1
```

3. Enter the **ip proxy-arp** command.

```
device(conf-if-eth-0/1)# ip proxy-arp
```

The following example enables Proxy ARP.

```
device# configure terminal
device(config)# interface ethernet 0/1
device(conf-if-eth-0/1)# ip proxy-arp
```

ARP show and clear commands

There are ARP show and clear commands, listed here with descriptions.

TABLE 1 ARP show commands in the *SLX-OS Command Reference*

Command	Description
show arp	Displays the Address Resolution Protocol (ARP) entries. You can filter the display by interface or VRF. You can also display only dynamic or only static ARP entries.

TABLE 2 ARP clear commands in the *SLX-OS Command Reference*

Command	Description
clear arp	The clear arp option clears ARP entries, triggering ARP requests for the cleared entries. The clear arp no-refresh option clears ARP entries without such requests. You can limit the clearing by interface or VRF. You can also clear for a specified next-hop IP address.

Dynamic ARP Inspection (DAI)

Dynamic ARP Inspection (DAI) is a security feature that validates address resolution protocol (ARP) packets in a subnet, and discards packets with invalid IP address and MAC address bindings.

ARP poisoning

An ARP poisoning attack, also known as ARP spoofing, targets the ARP caches of devices connected to the subnet, with the goal of intercepting traffic. A malicious host might use one of the following tactics:

- Send ARP packets claiming to have an IP address that actually belongs to another host.
- Reply to an ARP request with its own MAC address, thereby causing other hosts on the subnet to store this information in their ARP tables, even replacing an existing ARP entry.
- Send gratuitous replies without having received any ARP requests.

If the poisoning succeeds, traffic intended for the device under attack is instead routed to the attacker computer. The attacker has various options:

- Not forward any traffic to the computer under attack or forward some of the traffic, but not all of it (denial-of-service attacks).
- Forward inspected traffic to the compromised device (interception).
- Modify the traffic and then forward it (man-in-the-middle attack).

DAI functionality

NOTE

DAI is currently supported only in non-DHCP environments.

On VLANs, Dynamic ARP Inspection (DAI) can examine incoming ARP packets. DAI discards packets with invalid IP/MAC address bindings, guarding against ARP-poisoning attacks; only valid ARP requests and responses are relayed. You specify valid, static IP/MAC address bindings in the **permit** statements of ARP ACLs.

Towards enabling DAI, you need to decide which ports you are defining as trusted and which as untrusted. ARP packets on trusted ports bypass all DAI validations and are forwarded as required. DAI examines ARP packets only on untrusted ports.

When DAI is implemented on a VLAN, it monitors untrusted ports as follows:

- Intercepts ARP requests and responses
- Compares the IP/MAC address bindings with the **permit** statements in the ACL applied to the VLAN
- Drops invalid packets
- Forwards valid packets to the appropriate destination

The following table summarizes DAI enablement/disablement on trusted/untrusted ports:

TABLE 3 DAI on trusted and untrusted ports

VLAN setting	Port setting	Action
DAI disabled	Trusted or untrusted	All incoming ARP packets are hardware-forwarded.
DAI enabled	Trusted	All incoming ARP packets are trapped to the CPU and then software-forwarded.

TABLE 3 DAI on trusted and untrusted ports (continued)

VLAN setting	Port setting	Action
DAI enabled	Untrusted	All incoming ARP packets are trapped to the CPU. Following DAI, the packets are software-forwarded or dropped.

DAI implementation

Address Resolution Protocol (ARP) access control lists (ACLs), applied to untrusted ports, permit only ARP packets with specified IP/MAC address bindings. Such ACLs implement Dynamic ARP Inspection (DAI).

DAI configuration guidelines

Follow these guidelines when implementing ARP ACLs for DAI.

- DAI is available on Layer 2 VLANs.
- VLANs supported for DAI include:
 - 802.1Q VLANs
 - VE interfaces under virtual routing and forwarding (VRF). Both default and non-default VRFs are supported.
- DAI is not supported for management interfaces.
- DAI is not supported on a VLAN to which a VE is bound.
- On a VLAN with DAI enabled, the following types of member ports are supported for DAI:
 - Physical interfaces (in switchport mode)
 - Port-channel interfaces (LAGs or MLAGs) (in switchport mode)
- On DAI-enabled VLANs, the rate limit per chip is 64 ARP packets per second (pps).

Creating an ARP ACL

Use this procedure to create an ARP ACL and **permit ip host** rules.

1. Enter **configure terminal** to access global configuration mode.

```
device# configure terminal
```

2. Enter the **arp access-list** command to create the ACL.

```
device(config)# arp access-list arpACL1
```

3. For each ACL rule, enter a **permit ip host** command.

```
device(config-arp-acl)# permit ip host 1.1.1.1 mac host 0020.2222.2222
device(config-arp-acl)# permit ip host 1.1.1.2 mac host 0020.2222.2223
```

Applying an ARP ACL to a VLAN

Use this procedure to apply an ARP ACL to a VLAN.

NOTE

To replace an ARP ACL on a VLAN, there is no need to remove a previously applied ACL. The most recent ACL applied replaces any previous ACL.

1. Enter **configure terminal** to change to global configuration mode.

```
device# configure terminal
```

2. Enter the **vlan** command to access the VLAN.

```
device(config)# vlan 200
```

3. Enter the **ip arp inspection filter** command, specifying the ACL.

```
device(config-vlan-200)# ip arp inspection filter ARP_ACL_01
```

4. To return to global configuration mode, (for example, to define trusted and untrusted interfaces and to enable DAI), enter **exit**.

```
device(config-vlan-200)# exit
```

Defining trusted and untrusted interfaces under DAI

Use this procedure to specify untrusted and trusted interfaces under Dynamic ARP Inspection (DAI).

1. Enter **configure terminal** to change to global configuration mode.

```
device# configure terminal
```

2. For each interface that you need to define as trusted or untrusted, complete the following steps:

- a) Enter the **interface** command to access interface configuration mode.

```
device(config)# interface ethernet 0/3
```

- b) To define the interface as trusted, enter the **ip arp inspection trust** command.

```
device(conf-if-eth-0/3)# ip arp inspection trust
```

- c) To redefine a currently trusted interface as untrusted (default), enter the **no ip arp inspection trust** command.

```
device(conf-if-eth-0/3)# no ip arp inspection trust
```

The following example defines a port-channel interface as trusted.

```
device# configure terminal
device(config)# interface port-channel 200
device(config-Port-channel-200)# ip arp inspection trust
```

Enabling and disabling DAI

Use this procedure to enable Dynamic ARP Inspection (DAI) on a VLAN.

1. Enter **configure terminal** to change to global configuration mode.

```
device# configure terminal
```

2. Enter the **vlan** command to access configuration mode on the VLAN for which you are enabling DAI.

```
device(config)# vlan 1001
```

3. To enable DAI, enter the **ip arp inspection** command.

```
device(config-vlan-1001)# ip arp inspection
```

4. To disable DAI, enter the **no ip arp inspection** command.

```
device(config-vlan-1001)# no ip arp inspection
```

DAI show and clear commands

There is a full range of Dynamic ARP Inspection (DAI) show and clear commands, listed here with descriptions.

TABLE 4 DAI show commands in the *SLX-OS Command Reference*

Command	Description
show arp access-list	For one or all ARP ACLs defined on a device, displays ACL names and their permit statements.
show ip arp inspection interfaces	For VLANs enabled for DAI, displays a list of trusted interfaces.
show ip arp inspection statistics	Displays DAI statistics for one or more DAI-enabled VLANs.
show ip arp inspection	Displays DAI information for one or more VLANs.

TABLE 5 DAI clear commands in the *SLX-OS Command Reference*

Command	Description
clear ip arp inspection statistics	Clears DAI statistics for all DAI-enabled VLANs.

IP Addressing

• IP addressing overview.....	27
• Basic IP parameters and defaults.....	28
• Assigning IP addresses to interfaces.....	30
• Router-ID IP addresses.....	32
• DNS.....	32
• Source IP address for various packet types.....	34
• IPv4 MTU settings.....	35
• IP addressing Show and Clear commands.....	36

IP addressing overview

IPv4 uses a 32-bit addressing system designed for use in packet-switched networks. IPv4 routing is enabled by default on Brocade devices that operate at Layer 3 and cannot be disabled.

IPv4 is an Internet protocol used to deliver packets of data from a source to a destination across an interconnected system of networks. IPv4 uses a fixed-length 32-bit addressing system and is represented in a 4-byte dotted decimal format: x.x.x.x.

IP uses four main mechanisms to provide service:

- Type of Service (ToS)—Indicates the Quality of Service (QoS) required for a specific traffic type or network and enables a higher priority to be given to voice traffic, for example, that is more sensitive to dropped packets.
- Time to Live (TTL)—The time period for which a packet can exist before it reaches its final destination. If the TTL expires before the packet reaches its destination, the packet is destroyed. The period is set by the packet sender.
- Options—Control mechanisms such as timestamps, security, and other special routing functions that are optional.
- Header Checksum—Used to verify that the packet contents have transmitted correctly. If the checksum algorithm fails, the packet is dropped immediately.

IP does not provide a reliable communication function. No acknowledgments are sent and the only error control is the header checksum. There are not flow-control mechanisms or retransmissions. Errors detected may be reported via the Internet Control Message Protocol (ICMP).

IPv4 address classes

An IP address is divided into two sections:

- Network—Identifies the network on which the device is configured.
- Host—Identifies the host device.

IP Interfaces

Brocade devices operating at Layer 3 allow IP addresses to be configured on the following types of interfaces:

- Ethernet ports
- Virtual routing interfaces
- Loopback interfaces

You can configure up to 128 IP addresses on each interface.

NOTE

After you configure a port as a "switchport," you cannot configure Layer 3 interface parameters on that port. The parameters must be configured on the appropriate virtual routing interface.

The ARP cache

The ARP cache contains entries that map IP addresses to MAC addresses.

ARP cache entries are added in one of the following ways:

- From devices that are directly attached to the Layer 3 device.
- From an interface-based static IP route that goes to a destination two or more router hops away. The MAC address is either of the destination device or the router interface answering an ARP request on behalf of the device, using proxy ARP.

The ARP cache can contain both dynamic (learned) entries and static (user-configured) entries. The software places an entry in the ARP cache:

- Dynamic—when the Layer 3 device learns a device MAC address from an ARP request or ARP reply from the device.
- Static—When the interface with proper IP address comes up.

31-bit subnet masks on point-to-point networks

To conserve IPv4 address space, a 31-bit subnet mask can be assigned to point-to-point networks. Support for an IPv4 address with a 31-bit subnet mask is described in RFC 3021.

With IPv4, four IP addresses with a 30-bit subnet mask are allocated on point-to-point networks. In contrast, a 31-bit subnet mask uses only two IP addresses: all zero bits and all one bits in the host portion of the IP address. The two IP addresses are interpreted as host addresses, and do not require broadcast support because any packet that is transmitted by one host is always received by the other host at the receiving end. Therefore, directed broadcast on a point-to-point interface is eliminated.

When the 31-bit subnet mask address is configured on a point-to-point link, using network addresses for broadcast purposes is not allowed. For example, in an IPV4 broadcast scheme, the following subnets can be configured:

- 10.10.10.1 - Subnet for directed broadcast: {*Network-number*, -1}
- 10.10.10.0 - Subnet for network address: {*Network-number*, 0}

In a point-to-point link with a 31-bit subnet mask, the previous two addresses are interpreted as host addresses and packets are not rebroadcast.

Basic IP parameters and defaults

The following protocols are disabled by default:

- Route exchange protocols (OSPF, BGP4)
- Multicast protocols
- Router redundancy protocols (VRRP-E, VRRP)

Parameter changes in effect

Most IP parameters described in this chapter are dynamic. They take effect immediately, as soon as you enter the CLI command. You can verify that a dynamic change has taken effect by displaying the running configuration.

To display the running configuration, enter the **show running-config** command.

To save a configuration change permanently so that the change remains in effect following a system reset or software reload, save the configuration to the startup configuration file.

To change the memory allocation, you must reload the software after you save the changes to the startup configuration file.

IP interface parameters

The following table lists the interface-level IP parameters, their default values, and where to find configuration information.

TABLE 6 IP interface parameters

Parameter	Description	Default
IP state	The Internet Protocol, version 4	Enabled Note: You cannot disable IP.
IP address	A Layer 3 network interface address The Brocade device has separate IP addresses on individual interfaces.	None configured
Encapsulation type	The format of the packets in which the device encapsulates IP datagrams. The encapsulation format can be one of the following: <ul style="list-style-type: none"> Ethernet 	Ethernet
IP Maximum Transmission Unit (MTU)	The maximum length (number of bytes) of an encapsulated IP datagram the device can forward.	1500 for Ethernet II encapsulated packets
ARP age	Locally overrides the global setting. Refer to #unique_32 .	240 minutes
Directed broadcast forwarding	Locally overrides the global setting. Refer to #unique_32 .	Disabled
ICMP Redirect messages	Locally overrides the global setting. Refer to #unique_32 .	Enabled
UDP broadcast forwarding	The device can forward UDP broadcast packets for UDP applications such as BootP. By forwarding the UDP broadcasts, the device enables clients on one subnet to find servers attached to other subnets. Note: To completely enable a client's UDP application request to find a server on another subnet, you must configure an IP helper address consisting of the server's IP address or the directed broadcast address for the subnet that contains the server. Refer to the next row.	The device helps forward broadcasts for the following UDP application protocols: <ul style="list-style-type: none"> bootps dns netbios-dgm netbios-ns tacacs tftp time
IP helper address	The IP address of a UDP application server (such as a BootP or DHCP server) or a directed broadcast address. IP helper addresses allow the device to forward requests for certain UDP applications from a client on one subnet to a server on another subnet.	None configured

Assigning IP addresses to interfaces

Use the topics in this section to assign IP addresses to interfaces and to remove them.

Assigning an IP address to a loopback

IP addresses can be assigned to a loopback interface, using Classless Interdomain Routing (CIDR) network masks. Loopback interfaces add stability to a network, because they do not incur route flap problems due to unstable links between devices.

IPv4 routing is enabled by default on Brocade devices that operate at Layer 3 and cannot be disabled. IP addresses must be assigned to interfaces on the device to allow IPv4-based protocols to operate across the network.

1. From privileged EXEC mode, enter global configuration mode.

```
device# configure terminal
```

2. Access the interface to which you are assigning the IP addresses.

```
device(config)# interface loopback 1
```

3. Assign an IP address on the interface.

NOTE

You can define only one IP address per loopback. The only valid mask value is **/32**.

```
device(config-Loopback-1)# ip address 1.1.1.1/32
```

4. Use the **no shutdown** command to activate the interface.

```
device(config-Loopback-1)# no shutdown
```

5. To verify that the IP address is assigned to the interface, enter the **show ip interface** command.

```
device(config-Loopback-1)# do show ip interface loopback 1
Loopback 1 is up protocol is up
Primary Internet Address is 1.1.1.1/32
IP MTU is 1500
Proxy Arp is not Enabled
ICMP unreachable are always sent
ICMP mask replies are never sent
IP fast switching is enabled
Vrf : default-vrf
```

The following example configures an IP address on a loopback interface.

```
device# configure terminal
device(config)# interface loopback 1
device(config-Loopback-1)# ip address 1.1.1.1/32
device(config-Loopback-1)# no shutdown
device(config-Loopback-1)# do show ip interface loopback 1
```

Assigning IP addresses to Ethernet interfaces

IP addresses can be assigned to an Ethernet interface, using Classless Interdomain Routing (CIDR) network masks.

1. From privileged EXEC mode, enter global configuration mode.

```
device# configure terminal
```

2. Access the interface to which you are assigning the IP addresses.

```
device(config)# interface ethernet 0/1
```

3. Enter one or more IP addresses, with a CIDR network mask.

```
device(config-if-eth-0/1)# ip address 11.1.1.11/24
device(config-if-eth-0/1)# ip address 11.11.1.11/24
```

4. To assign a secondary IP address, include the **secondary** keyword.

```
device(config-if-eth-0/1)# ip address 10.53.5.4/24 secondary
```

NOTE

To configure a secondary IP address, you must configure the primary IP address configured within the same subnet.

5. Use the **no shutdown** command to activate the interface.

```
device(config-if-eth-0/1)# no shutdown
```

6. To verify that the IP address is assigned to the interface, enter the **show ip interface** command.

```
device(config-if-eth-0/1)# do show ip interface ethernet 3/14
Ethernet 3/14 is up protocol is up
Primary Internet Address is 11.1.1.11/24 broadcast is 11.1.1.255
Primary Internet Address is 11.11.1.11/24 broadcast is 11.11.1.255
Secondary Internet Address is 11.11.1.12/24 broadcast is 11.11.1.255
IP MTU is 1500
Proxy Arp is Enabled
ICMP unreachable are always sent
ICMP mask replies are never sent
IP fast switching is enabled
Vrf : default-vrf
```

Deleting an IP address from an interface

You can delete a specified IP address, or all IP addresses, from an interface.

1. From privileged EXEC mode, enter global configuration mode.

```
device# configure terminal
```

2. Access the interface from which you are deleting the IP address.

```
device(config)# interface ethernet 1/5
```

3. To delete a specified IP address from the interface, enter the **no ip address** command, specifying the address and the CIDR mask.

```
device(config-if-eth-1/5)# no ip address 10.53.5.3/24
```

4. To delete all IP addresses defined on the interface, enter **no ip address**.

```
device(config-if-eth-1/5)# no ip address
```

Router-ID IP addresses

Certain routing protocols—for example, OSPF and BGP4—have algorithms that specify which configured IP address identifies the device.

In general, a device has IP addresses assigned to various interfaces. However, some routing protocols identify the device by the router ID, rather than by the IP addresses assigned to the interfaces connected by the protocol. If a router ID is not specified, such protocols use the following algorithm to select a router ID:

1. If the device has loopback interfaces, the router ID is the IP address configured on the lowest numbered loopback interface. For example, if you configure loopback interfaces 1, 2, and 3 as follows, the default router ID is 10.9.9.9/32:
 - Loopback 1: 10.9.9.9/32
 - Loopback 2: 10.4.4.4/32
 - Loopback 3: 10.1.1.1/32
2. If a loopback interface is not configured, then the lowest IP address configured on a physical interface becomes the router ID.

You can also specify a router-id IP address, using the **ip router-id** command.

Assigning a router-ID IP address

For routing protocols that decide which configured IP address identifies the device—for example, OSPF and BGP4—an IP address that you apply under global configuration takes precedence.

NOTE

If you change the router ID, all current BGP4 sessions are cleared.

1. Enter the **configure terminal** command to access global configuration mode.

```
device# configure terminal
```

2. Enter the **ip router-id** command, specifying the device-level IP address.

```
device(config)# ip router-id 10.11.12.13
```

NOTE

You can specify an IP address that is also assigned to an interface on that device. But make sure that the router-ID IP address is not assigned on another network device.

DNS

The Domain Name System (DNS) operates as a hierarchical naming system that assigns a name (such as a company name) to an Internet entity to represent the real IP address of the entity. An entity can be a gateway router and is referred to as a domain.

A domain name (for example, brocade.router.com) can be used in place of an IP address for certain operations such as IP pings, trace routes, and Telnet management connections to the router. Instead of having to remember all the numbers of the IP address, a domain name is easier to remember. DNS is comprised of the following:

- DNS Server
- DNS Resolver
- DNS gateway addresses

DNS Server

A DNS server stores the information about a DNS domain. DNS servers are a key element of DNS because they respond to queries against its database. When a DNS domain is defined on a Brocade device to recognize all hosts within that domain, the Brocade device automatically appends the appropriate domain to the host address and forwards it to the domain name server.

DNS Resolver

The DNS resolver is a feature in a Layer 2 or Layer 3 device that sends and receives queries to and from the DNS server on behalf of a client. You can create a list of domain names that can be used to resolve host names. This list can have more than one domain name. When a client performs a DNS query, all hosts within the domains in the list can be recognized and queries can be sent to any domain on the list. After you define a domain name, the Brocade device automatically appends the appropriate domain to a host and forwards it to the DNS servers for resolution.

DNS Gateway Addresses

Gateway IP addresses assigned to the device through enable clients attached to the device to reach DNS.

Configuring DNS

A Domain Name System (DNS) domain and DNS gateway addresses can be configured to resolve host names to IP addresses.

1. Enter global configuration mode.

```
device# configure terminal
```

2. Use the **ip dns domain-name** to configure a domain name.

```
device(config)# ip dns domain-name mycompany.com
```

3. Use the **ip dns name-server** command to configure the default DNS gateway address for DNS servers.

```
device(config)# ip dns name-server 10.157.22.199
```

4. Use the **ip dns name-server** command to configure the secondary DNS gateway address for DNS servers.

```
device(config)# ip dns name-server 10.96.7.15
```

5. Use the **exit** command to return to privileged EXEC mode.

```
device(config)# exit
```

6. (Optional) Use the **traceroute** command to verify the DNS configuration.

```
device# traceroute mycompany.com

Sending DNS Query to 10.157.22.199
Tracing Route to IP node 10.157.22.80
To ABORT Trace Route, Please use stop-traceroute command.
Traced route to target IP node 10.157.22.80:
  IP Address      Round Trip Time1    Round Trip Time2
  10.95.6.30      93 msec             121 msec
```

The output shows that 10.157.22.199 is the IP address of the domain name server (default DNS gateway address), and 10.157.22.80 represents the IP address of the mycompany.com host.

The following example configures a DNS domain; and default and secondary DNS gateway addresses for DNS servers

```
device# configure terminal
device(config)# ip dns domain-name mycompany.com
device(config)# ip dns name-server 10.157.22.199
device(config)# exit
device(config)# ip dns name-server 10.96.7.15
```

Source IP address for various packet types

When a device originates a packet of one of the following types, the default source address of the packet is the lowest-numbered IP address on the interface that sends the packet:

- Telnet
- TACACS/TACACS+
- TFTP
- RADIUS
- Syslog
- SNTP

You can configure the device to always use the lowest-numbered IP address on a specific Ethernet, loopback, or virtual interface as the source addresses for these packets. When configured, the device uses the same IP address as the source for all packets of the specified type, regardless of the ports that actually sends the packets.

Designating a source IP address provides the following benefits:

- If your server is configured to accept packets only from specific IP addresses, you can configure the device to always send the packets from the same link or source address.
- If you specify a loopback interface as the single source for specified packets, servers can receive the packets regardless of the states of individual links. Thus, if a link to the server becomes unavailable, but can be reached through another link, the client or server still receives the packets, and the packets still have the source IP address of the loopback interface.

There are separate CLI commands for specifying the source interface for specific packets. You can configure a source interface for one or more of these types of packets separately.

The following sections show the syntax for specifying a single source IP address for specific packet types.

Telnet packets

To specify the lowest-numbered IP address configured on a virtual interface as the device source for all Telnet packets, enter commands such as the following.

```
(config)# interface loopback 2
(config-Loopback-2)# ip address 10.0.0.2/24
(config-Loopback-2)# exit
(config)# ip telnet source-interface loopback 2

(config)# interface ethernet 1/1/4
(config-if-1/1/4)# ip address 10.157.22.110/24
(config-if-1/1/4)# exit
(config)# ip telnet source-interface ethernet 1/1/4
```

IPv4 MTU settings

By increasing the IPv4 maximum transmission unit (MTU), you can reduce packet fragmentation.

The IPv4 MTU is the maximum length of an IPv4 packet that a Layer 2 frame can contain. If an IPv4 packet is larger than the MTU allowed by the frame, the device fragments the IP packet into multiple parts that will fit into frames, and sends the parts of the fragmented IP packet separately, in different frames. The device that receives the multiple fragments of the IP packet reassembles the fragments into the original packet. The default IPv4 MTU is 1500 bytes for Ethernet II packets. You can change the MTU for individual IP interfaces. However, IPv4 MTU cannot be set higher than the maximum frame size, minus 18.

NOTE

For multicast data traffic, frames are not fragmented and the IP MTU setting is ignored.

For jumbo packets, the device supports hardware forwarding. Unicast jumbo packets received on a port that supports the frame's IPv4 MTU size and forwarded to another port that also supports the frame's MTU size are forwarded in hardware.

IPv4 MTU and maximum frame size

Because raising MTU demands system resources, increase MTU only on the IP interfaces that need it.

For example, if you have one interface connected to a server that uses jumbo frames and two other interfaces connected to clients that can support the jumbo frames, you might increase the MTU only on those three IP interfaces.

Because you need to allow for the Ethernet header and CRC, IP MTU must always be less than the maximum frame size, as follows:

- 18 bytes for untagged packets
- 22 bytes for single-tagged packets
- 26 bytes for dual-tagged packets

Changing IPv4 MTU on an interface

You can change the size of the IPv4 maximum transmission unit (MTU) on each L3 interface. IP MTU configuration is not supported on a port-channel.

By default, IPv4 MTU is 1500 bytes. The IPv4 MTU ranges from 1300 through 9194 bytes.

1. From privileged EXEC mode, enter global configuration mode.

```
device# configure terminal
```

2. Access the interface on which you need to modify the IPv4 MTU.

```
device(config)# interface ethernet 0/1
```

3. Enter the **ip mtu** command, specifying the relevant value.

```
device(config-if-eth-0/1)# ip mtu 2000
```

The following example changes the IPv4 MTU on an Ethernet interface.

```
device# configure terminal
device(config)# interface ethernet 0/1
device(config-if-eth-0/1)# ip mtu 2000
```

NOTE

If the interface is part of a VE, change the IPv4 MTU only at the VE interface and not at the physical port. Switchports have only the MTU value configured. They do not inherit from IP MTU of Ve. Brocade recommends that you configure both MTU and IP MTU to be the same value.

To change the IPv4 MTU at the VE interface, enter the following commands:

```
device# configure terminal
device(config)# interface ve 103
device(config-ve-103)# ip mtu 2000
```

IP addressing Show and Clear commands

There is a full range of IP addressing show and clear commands. They are documented in the command reference, and listed here with descriptions.

TABLE 7 IP addressing Show commands in the command reference

Command	Description
show ip interface	Displays the IP address, status, and configuration for a specified Ethernet, loopback, or VE interface. You can also display a brief summary of such information for all interfaces.
show ip route	Displays IP route information.

TABLE 8 IP addressing Clear commands in the command reference

Command	Description
clear ip route	Clears a specified route or all IP routes in the IP routing tables.

IPv6 Addressing

- IPv6 addressing overview..... 37
- Configuring an IPv6 address on a Brocade device..... 38
- IPv6 management..... 38
- IPv6 neighbor discovery configuration..... 39
- Configuring an IPv6 domain name and server..... 44
- IPv6 MTU..... 44
- Information about IPv6 prefix list..... 45
- Displaying global IPv6 information..... 46
- Clearing global IPv6 information..... 47

IPv6 addressing overview

IPv6 increases the number of network address bits from 32 (IPv4) to 128 bits, which provides more unique IP addresses to support increasing number of network devices.

An IPv6 address comprise 8 fields of 16-bit hexadecimal values separated by colons (:). The following figure shows the IPv6 address format.

FIGURE 1 IPv6 address format

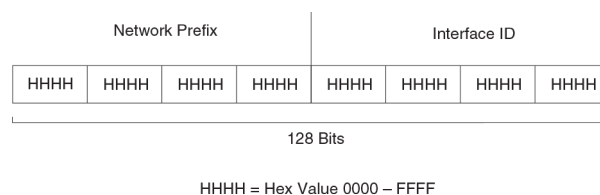

As shown in the above figure, HHHH is a 16-bit hexadecimal value, while H is a 4-bit hexadecimal value. The following is an example of an IPv6 address.

2001:0000:0000:0200:002D:D0FF:FE48:4672

Note that this IPv6 address includes hexadecimal fields of zeros. To make the address manageable, you can:

- Omit the leading zeros. For example, 2001:0:0:200:2D:D0FF:FE48:4672.
- Compress the successive groups of zeros at the beginning, middle, or end of an IPv6 address to two colons (::) once per address. For example, 2001::200:2D:D0FF:FE48:4672.

When specifying an IPv6 address in a command syntax, consider the following:

- You can use the two colons (::) only once in the address to represent the longest successive hexadecimal fields of zeros.
- The hexadecimal letters in IPv6 addresses are not case-sensitive.

As shown in [Figure 1](#), the IPv6 network prefix is composed of the left-most bits of the address. As with an IPv4 address, you can specify the IPv6 prefix using the prefix/prefix-length format, where the following applies.

The prefix parameter is specified as 16-bit hexadecimal values separated by a colon.

The prefix-length parameter is specified as a decimal value that indicates the network portion of the IPV6 address.

The following is an example of an IPv6 prefix.

2001:DB8:49EA:D088::/64

Configuring an IPv6 address on a Brocade device

You can configure global and link-local IPv6 addresses at the interface level.

1. Enter global configuration mode.

```
device# configure terminal
```

2. Enter interface configuration mode.

```
device(config)# interface ethernet 0/1
```

3. Configure a global IPv6 address for the interface.

```
device(config-if-eth-0/1)# ipv6 address 2001:DB8:12D:1300:240:D0FF:FE48:4672/64
```

4. Configure a link-local IPv6 address for the interface. Link-local addresses are not forwarded outside the local network.
5. Return to Privileged EXEC mode.

The following example configures both a global IPv6 address and a link-local IPv6 address for the Ethernet interface.

IPv6 management

On the management interface of the Brocade device, the IPv6 routing functionality is not enabled.

Configuring IPv6 management ACLs

When you enter the **ipv6 access-list** command, the Brocade device enters the IPv6 Access List configuration level, where you can access several commands for configuring IPv6 ACL entries. After configuring the ACL entries, you can apply them to network management access features such as Telnet, SSH, Web, and SNMP.

NOTE

Unlike IPv4, there is no distinction between standard and extended ACLs in IPv6.

```
device(config)#ipv6 access-list netw  
device(config-ipv6-access-list-netw)#
```

Syntax: **[no] ipv6 access-list** *ACL-name*

The *ACL-name* variable specifies a name for the IPv6 ACL. An IPv6 ACL name cannot start with a numeral, for example, 1access. Also, an IPv4 ACL and an IPv6 ACL cannot share the same name.

Specifying an IPv6 SNMP trap receiver

Specify an IPv6 host as a trap receiver to ensure that all SNMP traps sent by the device go to the same SNMP trap receiver or set of receivers.

1. Enter the configure terminal.

```
device# configure terminal
```

- Use the **snmp-server host** command to specify an IPv6 host as a trap receiver.

```
device(config)# snmp-server host ipv6 2001:DB8:89::13
```

Secure Shell, SCP, and IPv6

Secure Shell (SSH) is a mechanism that allows secure remote access to management functions on the Brocade device. SSH provides a function similar to Telnet. You can log in to and configure a Brocade device using a publicly or commercially available SSH client program, just as you can with Telnet. However, unlike Telnet, which provides no security, SSH provides a secure, encrypted connection to the Brocade device.

IPv6 Telnet

Telnet sessions can be established between a Brocade device to a remote IPv6 host, and from a remote IPv6 host to the Brocade device using IPv6 addresses.

The **telnet** command establishes a Telnet connection from a Brocade device to a remote IPv6 host using the console. Up to five read-access Telnet sessions are supported on the router at one time. Write-access through Telnet is limited to one session, and only one outgoing Telnet session is supported on the router at one time.

Establishing a Telnet session from an IPv6 host

To establish a Telnet session from an IPv6 host to the Brocade device, open your Telnet application and specify the IPv6 address of the device. The following example shows how to establish a Telnet session.

Use the **telnet** command to establish a Telnet session to a Brocade device.

```
device# telnet 2001:DB8:3de2:c37::6
```

IPv6 traceroute

Use the **traceroute** command to trace a path from the Brocade device to an IPv6 host.

```
device# traceroute ipv6 2001:DB8:349e:a384::34
```

The **traceroute** command displays trace route information for each hop as soon as the information is received. The traceroute requests display all responses of a minimum TTL of 1 second and a maximum TTL of 30 seconds. In addition, if there are multiple equal-cost routes to the destination, the Brocade device displays up to three responses.

Restricting Web management access

You can restrict Web management access to include only management functions on a Brocade device that is acting as an IPv6 host, or restrict access so that the Brocade host can be reached by a specified IPv6 device.

IPv6 neighbor discovery configuration

The neighbor discovery feature for IPv6 uses IPv6 ICMP messages to perform the following tasks:

- Determine the link-layer address of a neighbor on the same link.

- Verify that a neighbor is reachable.
- Track neighbor routers.

An IPv6 host is required to listen for and recognize the following addresses that identify itself:

- Link-local address.
- Assigned unicast address.
- Loopback address.
- All-nodes multicast address.
- Solicited-node multicast address.
- Multicast address to all other groups to which it belongs.

You can adjust the following IPv6 neighbor discovery features:

- Neighbor solicitation messages for duplicate address detection.
- Router advertisement messages:
 - Interval between router advertisement messages.
 - Value that indicates a router is advertised as a default router (for use by all nodes on a given link).
 - Prefixes advertised in router advertisement messages.
 - Flags for host stateful autoconfiguration.
- Amount of time during which an IPv6 node considers a remote node reachable (for use by all nodes on a given link).

IPv6 neighbor discovery configuration notes

NOTE

For all solicitation and advertisement messages, Brocade uses seconds as the unit of measure instead of milliseconds.

- Neighbor discovery is not supported on tunnel interfaces.

Router advertisement and solicitation messages

Router advertisement and solicitation messages enable a node on a link to discover the routers on the same link.

Each configured router interface on a link sends out a router advertisement message, which has a value of 134 in the Type field of the ICMP packet header, periodically to the all-nodes link-local multicast address (FF02::1).

A configured router interface can also send a router advertisement message in response to a router solicitation message from a node on the same link. This message is sent to the unicast IPv6 address of the node that sent the router solicitation message.

At system startup, a host on a link sends a router solicitation message to the all-routers multicast address (FF01). Sending a router solicitation message, which has a value of 133 in the Type field of the ICMP packet header, enables the host to automatically configure its IPv6 address immediately instead of awaiting the next periodic router advertisement message.

Because a host at system startup typically does not have a unicast IPv6 address, the source address in the router solicitation message is usually the unspecified IPv6 address (0:0:0:0:0:0:0:0). If the host has a unicast IPv6 address, the source address is the unicast IPv6 address of the host interface sending the router solicitation message.

Neighbor redirect messages

After forwarding a packet, by default, a router can send a neighbor redirect message to a host to inform it of a better first-hop router. The host receiving the neighbor redirect message will then readdress the packet to the better router.

A router sends a neighbor redirect message only for unicast packets, only to the originating node, and to be processed by the node.

A neighbor redirect message has a value of 137 in the Type field of the ICMP packet header.

Duplicate Address Detection (DAD)

Although the stateless auto configuration feature assigns the 64-bit interface ID portion of an IPv6 address using the MAC address of the host's NIC, duplicate MAC addresses can occur. Therefore, the duplicate address detection feature verifies that a unicast IPv6 address is unique before it is assigned to a host interface by the stateless auto configuration feature. Duplicate address detection verifies that a unicast IPv6 address is unique.

If duplicate address detection identifies a duplicate unicast IPv6 address, the address is not used. If the duplicate address is the link-local address of the host interface, the interface stops processing IPv6 packets.

In the DAD NS message, the source address field in the IPv6 header is set to the unspecified address (::). The address being queried for duplication cannot be used until it is determined that there are no duplicates. In the neighbor advertisement (NA) reply to a DAD NS message, the destination address in the IPv6 header is set to the link-local all-nodes multicast address (FF02::1). The Solicited flag in the NA message is set to 0. Because the sender of the DAD NS message is not using the desired IP address, it cannot receive unicast NA messages. Therefore, the NA message is multicast.

Upon receipt of the multicast NA message with the target address field set to the IP address for which duplication is being detected, the node disables the use of the duplicate IP address on the interface. If the node does not receive an NA message that defends the use of the address, it initializes the address on the interface.

Configuring IPv6 static neighbor entries

In some cases a neighbor cannot be reached by means of Neighbor Discovery. To resolve this you can add a static entry to the ND cache, causing a neighbor to be reachable at all times. (A static IPv6 ND entry is like a static IPv4 ARP entry.)

For example, use the **ipv6 neighbor** command in interface subtype configuration mode to add a static entry for a neighbor with IPv6 address 2001:db8:2678::2 and link-layer address 0000.002b.8641, reachable through interface ethernet 3/5.

```
switch(config-if-eth-0/1)# ipv6 neighbor 2001:db8:2678::2 0000.002b.8641
```

IPv6 router advertisement parameters

You can adjust the following parameters for router advertisement messages:

- The interval (in seconds) at which an interface sends router advertisement messages. By default, an interface sends a router advertisement message every 200 to 600 seconds.
- The "router lifetime" value, which is included in router advertisements sent from a particular interface. The value (in seconds) indicates if the router is advertised as a default router on this interface. If you set the value of this parameter to 0, the router is not advertised as a default router on an interface. If you set this parameter to a value that is not 0, the router is advertised as a default router on this interface. By default, the router lifetime value included in router advertisement messages sent from an interface is 1800 seconds.
- The hop limit to be advertised in the router advertisement.

Setting IPv6 router advertisement parameters

When adjusting these parameter settings, Brocade recommends that the interval between router advertisement transmission be less than or equal to the router lifetime value if the router is advertised as a default route. To configure the IPv6 router advertisement parameters, perform the following tasks.

1. Enter global configuration mode.

```
device# configure terminal
```

2. Use the **interface** command to enter the interface configuration mode.

```
device# interface ethernet 0/1
```

3. Use the **ipv6 nd ra-lifetime** command to configure the router advertisement lifetime.

```
device(config-if-eth-0/1)# ipv6 nd ra-lifetime 1900
```

4. Use the **ipv6 nd ra-interval** command to set a maximum interval range and minimum interval at which RA messages are sent.

```
device(config-if-eth-0/1)# ipv6 nd ra-interval 1200 min 400
```

5. Use the **ipv6 nd ra-lifetime** command to set the RA message lifetime.

```
device(config-if-eth-0/1)# ipv6 nd ra-lifetime 1900
```

6. Use the **ipv6 nd hoplimit** command to specify a nondefault hop limit.

```
device(config-if-eth-0/1)# ipv6 nd hoplimit 32
```

7. Use the **ipv6 nd mtu** command to specify a nondefault MTU.

```
device(config-if-eth-0/1)# ipv6 nd mtu 2400
```

Setting flags in IPv6 router advertisement messages

By default, the managed address configuration and other stateful configuration flags are not set in router advertisement messages.

1. Enter global configuration mode.

```
device# configuration terminal
```

2. Use the **interface** command to enter interface configuration mode.

```
device (config)# interface ethernet 0/1
```

3. Use the **ipv6 nd managed-config-flag** command to configure the managed address configuration flag.

```
device(conf-if-eth-0/1)# ipv6 nd managed-config-flag
```

4. Use the **ipv6 nd other-config-flag** command to configure the other stateful configuration flag.

```
device(conf-if-eth-0/1)# ipv6 nd other-config-flag
```

To remove either flag from router advertisement messages sent on an interface, use the **no** form of the corresponding command.

Sending or Suppressing IPV6 Router Advertisements and Addresses

When IPv6 address is configured on an Ethernet interface, the interface sends router advertisement (RA) messages by default.

1. Enter interface configuration mode.

```
device# configure terminal
```

2. Use the **ipv6 nd global-suppress-ra** to enable the sending of RA messages on all interfaces.

```
device(config)# ipv6 nd global-suppress-ra
```

NOTE

The interface specific command overrides this global configuration.

3. Use the **ipv6 nd send-ra** to allow the user to keep some selected interfaces sending RA messages when **ipv6 nd global-suppress-ra** command is set.

```
device (conf-if-eth-0/1)# ipv6 nd suppress-ra
```

4. Use the **ipv6 nd suppress-ra** command to allow the user to selectively stop interfaces from sending RA messages when **ipv6 nd global-suppress-ra** command is not set.

```
device (conf-if-eth-0/1)# ipv6 nd suppress-ra
```

5. Use the **ipv6 nd address** command to allow a user to specify an address to be suppressed or all the addresses to be suppressed on a given interface.

```
device (conf-if-eth-0/1)# ipv6 nd address 2001:DB8:12D:1300:240:D0FF:FE48:4672 suppress
```

IPv6 router advertisement preference support

IPv6 router advertisement (RA) preference enables IPv6 RA messages to communicate default router preferences from IPv6 routers to IPv6 hosts in network topologies where the host has multiple routers on its Default Router List. This improves the ability of the IPv6 hosts to select an appropriate router for an off-link destination.

Configuring IPv6 RA preference

Configuring IPv6 RA preference

If IPv6 unicast routing is enabled on an Ethernet interface, by default, this interface sends IPv6 router advertisement messages. The IPv6 router sets the preference field based on the configured value on IPv6 RA and sends it periodically to the IPv6 host or as a response to the router solicitations.

1. Enter global configuration mode.

```
device# configuration terminal
```

2. Use the **ipv6 nd router-preference** command to configure IPv6 RA preference for the IPv6 router.

```
device(config)# interface ethernet 0/1
device(conf-if-eth-0/1)# ipv6 nd router-preference medium
```

Reachable time for remote IPv6 nodes

The router advertisement messages sent by a router interface include the duration of time specified so that nodes on a link use the same reachable time duration. By default, the messages include a default value of 0.

Brocade recommends configuring a longer reachable time duration, because a short duration causes the IPv6 network devices to process the information at a greater frequency.

Configuring reachable time for remote IPv6 nodes

You can configure the duration (in seconds) that a router considers a remote IPv6 node reachable. By default, a router interface uses 30 seconds.

1. Enter global configuration mode.

```
device# configuration terminal
```

2. Use the **ipv6 nd reachable-time** command to configure the reachable time.

```
device(config)# interface ethernet 0/1  
device (conf-if-eth-0/1)# ipv6 nd reachable-time 600
```

NOTE

The actual reachable time will be from 0.5 to 1.5 times the configured or default value.

Configuring an IPv6 domain name and server

You can configure a maximum number of 4 DNS Recursive Server addresses and corresponding lifetime . If you configure at least one DNS Recursive Server on the interface, it overrides all the configurations of the DNS Recursive Server addresses at system level for this interface. Configuring DNS attributes take effect in the next scheduled RA as specified by the interval value.

1. Use the **ipv6 nd ra-dns-server** command to configure an IPv6 domain name and server.

```
device(conf-if-eth-0/1)# ipv6 nd ra-dns-server 2001:DB8:0:ee44::1 lifetime 200
```

2. Use the **ipv6 nd ra-domain-name** command to configure a DNS Recursive domain name.

```
device(conf-if-eth-0/1)# ipv6 nd ra-dns-server 2001:DC8:200::3 lifetime 200
```

IPv6 MTU

The IPv6 maximum transmission unit (MTU) is the maximum length of an IPv6 packet that can be transmitted on a particular interface. If an IPv6 packet is longer than an MTU, the host that originated the packet fragments the packet and transmits its contents in multiple packets that are shorter than the configured MTU.

MTU supported values are 1300, 1500, 9194 and default value is 1500. The previous lower value will be selected when user configures other than above 3 values.

Hardware supports only one MTU value at interface though CLI allows different value for v4 and v6. Last configured value will be programmed into hardware. It is recommended to configure same MTU value for v4 and v6 in case of dual stack.

By default, the MTU size is 1548 bytes. The maximum Ethernet MTU size is 9216.

Changing IPv6 MTU

You can configure the IPv6 MTU on individual interfaces.

To change the IPv6 MTU value, perform the following tasks.

1. Enter global configuration mode.

```
device# configure terminal
```

2. Use the **interface** command to enter the interface Ethernet configuration mode.

```
device# interface ethernet 0/1
```

3. Use the **ipv6 mtu** command to change the MTU.

```
device(conf-if-eth-0/1)# ipv6 mtu 1300
```

You cannot configure IPv6 MTU globally.

Information about IPv6 prefix list

An IPv6 prefix list comprises one or more conditional statements that pose an action (permit or deny) if a route matches a specified prefix. In prefix lists with multiple statements, you can specify a sequence number for each statement. The specified sequence number determines the order in which the statement appears in the prefix.

You can configure an IPv6 prefix list on a global basis and use it as input to other commands or processes, such as route aggregation, route redistribution, route distribution, route maps, and so on. When a Brocade device sends or receives an IPv6 route, it applies the statements within the IPv6 prefix list in their order of appearance to the packet. When a match occurs, the device takes the specified action (permit or deny the packet) and stops further comparison for that route.

You can use permit statements in the prefix list to specify the route that you want to send to the other feature. If you use deny statements, the route specified by the deny statements is not supplied to the other feature.

Brocade devices support IPv6 prefix lists, which you can use for basic route filtering. You can configure up to 100 IPv6 prefix lists. You must specify the `ipv6-prefix` parameter in hexadecimal using 16-bit values between colons as documented in RFC 4291. You must specify the `prefix-length` parameter as a decimal value. A slash mark (/) must follow the `ipv6-prefix` parameter and precede the `prefix-length` parameter.

Configuring an IPv6 prefix list

To configure IPv6 prefix lists for use in basic traffic filtering, perform the following tasks.

1. Enter global configuration mode.

```
device# configure terminal
```

2. Use the **ipv6 prefix-list** command to configure an IPv6 prefix list.

```
(config)# ipv6 prefix-list prefix-filter-1 permit FE80::/10 ge 25 le 25
```

The **ge** *ge-value* or **le** *le-value* that you specify must meet the following condition for prefix-length:

`ge-value <= le-value <= 128`

If you do not specify **ge** *ge-value* or **le** *le-value*, the prefix list matches only on the exact prefix you specify with the `ipv6-prefix/prefix-length` parameter.

Displaying prefix list information

```
device# show ipv6 prefix-list routesfor2001
ipv6 prefix-list routesfor2001: 2 entries
seq 5 permit 2001::/16
seq 10 permit 2001:db8::/32
```

Displaying global IPv6 information

You can display output for the following global IPv6 parameters:

- IPv6 interfaces
- IPv6 neighbors
- IPv6 route table

Displaying IPv6 interface information

Use the **show ipv6 interface** command to display IPv6 interface information.

```
device# show ipv6 interface brief
```

Interface	IPv6-Address	Vrf	Status	Protocol
Loopback 1	3911::4/128	default-vrf	up	up
Ethernet 0/1	3002::4/64	default-vrf	up	up
Ve 2	a1a1:0:2::2/64	default-vrf	up	down
Ve 3	a1a1:0:3::2/64	default-vrf	up	down
Ve 4		default-vrf	up	down

Displaying IPv6 neighbor information

Use the **show ipv6 neighbor** command to display the IPv6 neighbor table.

```
device# show ipv6 neighbor
```

Address	Age	Type	Mac-address	Interface	MacResolved
a1a1:0:3::1	10:25:32	Dynamic	609c.9f02.1f15	Ve 3	no
fe80::21b:edff:fe9f:1900	00:02:36	Dynamic	001b.ed9f.1900	Eth 0/1	yes
fe80::629c:9fff:fe02:1f15	10:25:32	Dynamic	609c.9f02.1f15	Ve 2	no
fe80::629c:9fff:fe02:1f15	10:25:42	Dynamic	609c.9f02.1f15	Ve 3	no
fe80::629c:9fff:fe02:1f15	10:32:04	Dynamic	609c.9f02.1f15	Ve 4	no
fe80::629c:9fff:fe02:1f15	10:32:05	Dynamic	609c.9f02.1f15	Ve 5	no

Displaying the IPv6 route table

Use the **show ipv6 route** command to display the IPv6 route table.

```
device# show ipv6 route
IPv6 Routing Table for VRF "default-vrf"
Total number of IPv6 routes: 5
'*' denotes best ucast next-hop
'[x/y]' denotes [preference/metric]

3002::/64, attached
  *via ::, Eth 1/1, [0/0], 10h19m, direct, tag 0
3002::4/128, attached
  *via ::, Eth 1/1, [0/0], 10h19m, local, tag 0
3911::4/128, attached
  *via ::, Lo 1, [0/0], 12h6m, direct, tag 0
fe80::/10, attached
  *via ::, , [0/0], 12h6m, local, tag 0
ff00::/8, attached
  *via ::, Null0, [0/0], 12h6m, local, tag 0
```

Clearing global IPv6 information

You can clear the following global IPv6 information from a Brocade device:

- Entries from the IPv6 neighbor table
- IPv6 routes from the IPv6 route table

Clearing IPv6 neighbor information

You can remove all entries from the IPv6 neighbor table or to specify an entry based on the IPv6 prefix, IPv6 address, and interface type.

Use the **clear ipv6 neighbor** command to remove the IPv6 neighbor table entries.

```
device # clear ipv6 neighbor 2000:7838::1 force-delete
```

Clearing IPv6 routes from the IPv6 route table

You can clear all IPv6 routes or only those routes associated with a particular IPv6 prefix from the IPv6 route table and reset the routes.

Use the **clear ipv6 route** command to clear IPv6 routes.

```
device# clear ipv6 route 2000:7838::/32
```

Use the all key word to clear all ipv6 routes. Use the slot keyword to clear IPv6 route on a specific slot (LP).

IPv4 Static Routing

• Overview of static routing.....	49
• Configuring a basic IP static route.....	50
• Adding metrics to a static route.....	51
• Configuring a physical interface as next hop.....	51
• Configuring a virtual interface as next hop.....	52
• Configuring a static route with a VRF as next hop.....	52
• Configuring a static route for use with a route map.....	53
• Configuring a null route.....	53
• Configuring a default static route.....	55
• Configuring load sharing and redundancy.....	55
• Displaying IPv4 static routes.....	57

Overview of static routing

Static routes are manually configured entries in the IP routing table.

The IP route table can receive routes from several sources, including static routes. Other route sources include directly connected networks, OSPF and BGP4 protocols.

Static routes can be used to specify desired routes, backup routes, or routes of last resort. Static routing can help provide load balancing and can use routing information learned from other protocols.

In setting up static routes, you can specify several types of destinations:

- Destination network, using an IP address and prefix length
- Default network route
- Next-hop router
- Ethernet interface, typically used for directly attached destination networks
- Virtual interface
- Null interface

You can influence the preference a route is given in the following ways:

- By setting a route metric higher than the default metric
- By giving the route an administrative distance
- By specifying a route tag for use with a route map.

Static routes can be configured to serve as any of the following:

- Default routes
- Primary routes
- Backup routes
- Null routes for intentionally dropping traffic when the desired connection fails
- Alternative routes to the same destination to help load balance traffic.

Static route states follow port states

IP static routes remain in the IP route table only as long as the port or virtual interface used by the route is available and the next-hop IP address is valid; otherwise, the software removes the static route from the IP route table. If the port or virtual routing interface becomes available again later and the next-hop is valid, the software adds the route back to the route table.

This feature allows the router to adjust to changes in network topology. The router does not continue trying to use routes on unavailable paths but instead uses routes only when their paths are available.

In the following example, a static route is configured on Switch A. The route configuration is shown following the figure.

FIGURE 2 Example of static route

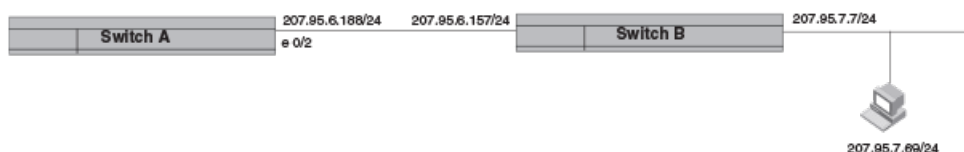

The following command configures a static route to 207.95.7.0 destinations, using 207.95.6.157 as the next-hop gateway.

```
device(config)# ip route 207.95.7.0/24 207.95.6.157
```

When you configure a static IP route, you specify the destination address for the route and the next-hop gateway or Layer 3 interface through which the Layer 3 device can reach the route. The device adds the route to the IP route table. In this case, Switch A knows that 207.95.6.157 is reachable through port 0/2, and also assumes that local interfaces within that subnet are on the same port. Switch A deduces that IP interface 207.95.7.0 is also on port 0/2.

The software automatically removes a static IP route from the IP route table if the port used by that route becomes unavailable or the IP address is not valid. When the port becomes available again, the software automatically re-adds the route to the IP route table.

Configuring a basic IP static route

To configure a basic IP static route, perform these steps.

1. Enter global configuration mode.

```
device# configure terminal
```

2. Enter the IP address and prefix length for the route destination network. On the same command line, enter the IP address for the next hop.

```
device(config)# ip route 10.0.0.0/24 10.1.1.1
```

This example configures an IP static route with a destination network address of 10.0.0.0, a prefix length of /24, and a next hop address of 10.1.1.1.

NOTE

Prefix lengths must be used as part of the address. Network masks cannot be used. The prefix length of /8 is equivalent to a network mask of 255.0.0.0. The prefix length of /24 (equivalent to the mask 255.255.255.0) matches all hosts within the Class C subnet address specified in the destination IP address.

The following example configures an IP static route with a destination network address of 10.0.0.0, a prefix length of 24 bits, and a next hop address of 10.1.1.1.

```
device# configure terminal
device(config)# ip route 10.0.0.0/24 10.1.1.1
```

Adding metrics to a static route

You can influence route preference by adding a cost metric or an administrative distance to a static route.

Follow these steps to create an IP static route with cost metrics.

1. Enter global configuration mode.

```
device# configure terminal
```

2. Designate the route destination and next hop, and add a route priority parameter.

Option	Description
Cost metric	The value is compared to the metric for other static routes in the IPv4 route table to the same destination. Two or more routes to the same destination with the same metric load share traffic to the destination. The value may range from 1 through 16. The default is 1. A route with a cost of 16 is considered unreachable.
Administrative distance	This value is compared to the administrative distance of all routes to the same destination. Static routes by default take precedence over learned protocol routes. However, to give a static route a lower priority than a dynamic route, give the static route the higher administrative distance. The value is preceded by the keyword distance and can range from 1 to 254. The default is 1. A value of 255 is considered unreachable.

```
device(config)# ip route 10.128.2.71/24 10.111.10.1 distance 10
```

This example configures a static route with an administrative distance of 10.

NOTE

The device replaces a static route if it receives a route to the same destination with a lower administrative distance.

```
device(config)# ip route 10.128.2.69/24 10.111.10.1 2
```

This example configures a static route with a metric of 2.

The following example configures a static route to destinations with an IP address beginning with 10.0.0.0. The route uses IP address 10.111.10.1 as the next hop. The static route is assigned an administrative distance of 3.

```
device# configure terminal
device(config)# ip route 10.0.0.0/24 10.111.10.1 distance 3
```

Configuring a physical interface as next hop

The interface you use for the static route's next hop must have at least one IP address configured on it. The address does not need to be in the same subnet as the destination network.

NOTE

ARP will be generated for a forwarded packet destination IP address when an interface is configured as the next hop.

To configure an IP static route with an IP physical interface as the next hop, follow these steps.

1. Enter global configuration mode.

```
device# configure terminal
```

2. Enter the IP address and prefix length for the route destination network. On the same command line, enter the keyword **ethernet** followed by the interface number to be used as next hop.

```
device(config)# ip route 10.128.2.69/24 ethernet 0/4
```

This example configures an IP static route with a destination network address of 10.128.2.69, a prefix length of /24, and Ethernet port 0/4 as the next hop.

The following example configures an IP static route to destination network addresses beginning with 10.0.0.0 through the next-hop interface 0/1.

```
device# configure terminal
device(config)# ip route 10.0.0.0/24 ethernet 0/1
```

Configuring a virtual interface as next hop

The virtual interface you use for the static route's next hop must have at least one IP address configured on it. The address does not need to be in the same subnet as the destination network.

To configure an IP static route that uses a virtual interface as the next hop, follow these steps.

1. Enter global configuration mode.

```
device# configure terminal
```

2. Enter the IP destination address and the prefix-length. On the same command line, enter the keyword **ve** followed by the appropriate VLAN number.

```
device(config)# ip route 10.128.2.0/24 ve 3
```

The following example configures an IP static route with a destination address of 10.128.2.0, a prefix-length of /24, and a virtual interface (ve 3) as the next hop.

```
device# configure terminal
device(config)# ip route 10.128.2.0/24 ve 3
```

Configuring a static route with a VRF as next hop

A VRF can be designated as the next hop toward a destination via a valid port, IP address, or virtual interface.

The VRF must be an existing VRF, and any physical port referenced in the next hop must have a valid IP address for the route to be added to the routing table.

To configure an IP static route that uses a VRF as the next hop, follow these steps.

1. Enter global configuration mode.

```
device# configure terminal
```

2. Enter the IP destination address and the prefix-length. On the same command line, enter the keyword **next-hop-vrf** followed by the appropriate VRF name. Then specify the next hop as an IP address, physical interface, virtual interface, or null route.

NOTE

Using a VRF with a physical port as next hop allows for VRF route leaking for all incoming traffic intended for the destination IP address.

```
device(config)# ip route 10.0.0.0/24 next-hop-vrf red ethernet 0/1
```

This example routes traffic for IP address 10.0.0.0/24 through VRF red over port 0/1.

```
device(config)# ip route 10.0.0.0/24 next-hop-vrf red 11.1.2.3
```

This example routes traffic for IP address 10.0.0.0/24 through VRF red via IP address 11.1.2.3.

```
device(config)# ip route 10.0.0.0/24 next-hop-vrf red ve 3
```

This example routes traffic for IP address 10.0.0.0/24 through VRF red over virtual interface 3.

```
device(config)# ip route 10.0.0.0/24 next-hop-vrf red null 0
```

This example discards the traffic for IP address 10.0.0.0/24 through VRF red using a null route.

The following example creates a static route to destinations with 10.0.0.0 IP addresses through VRF red via port 0/1.

```
device(config)# ip route 10.0.0.0/24 next-hop-vrf red ethernet 0/1
```

Configuring a static route for use with a route map

You can configure a static route with a tag that can be referenced in a route map.

Perform these steps to configure a static route with a tag that can be referenced in a route map.

1. Enter global configuration mode.

```
device# configure terminal
```

2. Enter the **ip route** command followed by the destination network IP address and prefix-length and the next-hop IP address. On the same line, enter the keyword **tag** followed by a decimal tag number.

```
device(config)# ip route 10.0.0.0/24 10.1.1.1 tag 3
```

The following example creates an IP static route to destination IP addresses beginning with 10.0.0.0 through the next-hop address 10.1.1.1. The static route includes the tag "3" for later use in a route map.

```
device# configure terminal
device(config)# ip route 10.0.0.0/24 10.1.1.1 tag 3
```

Configuring a null route

You can configure a null static route to drop packets to a certain destination. This is useful when the traffic should not be forwarded if the preferred route is unavailable.

The following figure depicts how a null static route works with a standard route to the same destination.

FIGURE 3 Null route and standard route to same destination

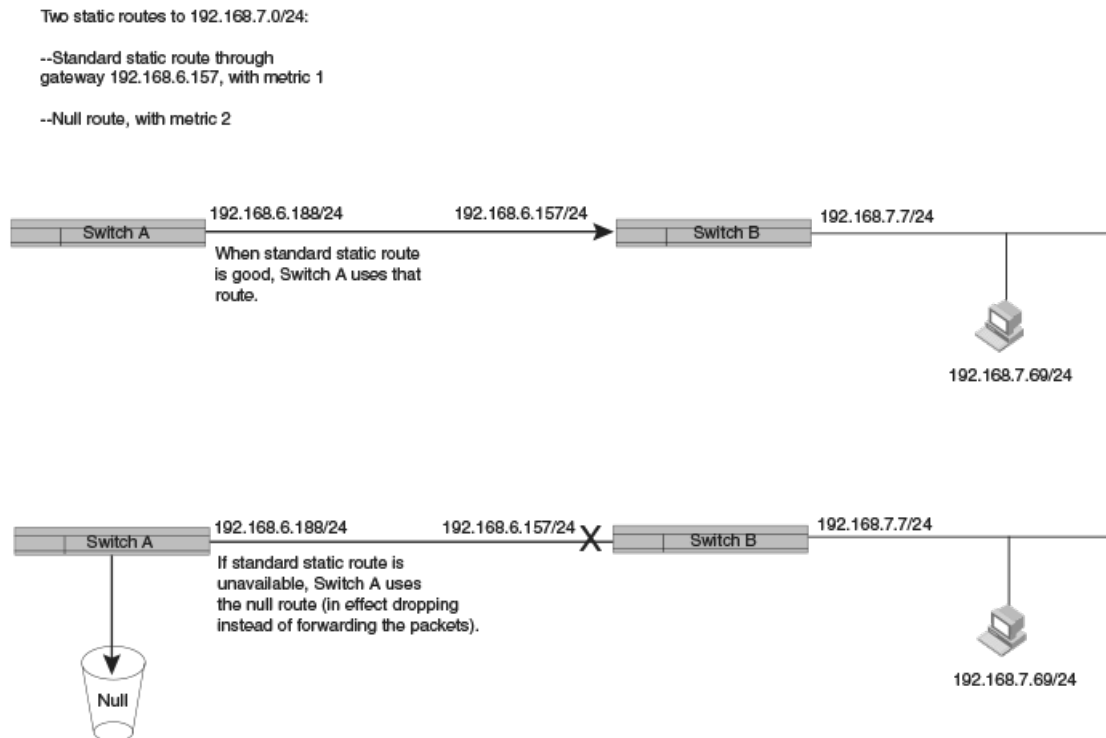

To configure a null route with a lower priority than the preferred route, perform the following steps.

1. Enter global configuration mode.

```
device# configure terminal
```

2. Configure the preferred route to a destination.

```
device(config)# ip route 192.168.7.0/24 192.168.6.157
```

This example creates a static route to destination network addresses that have an IP address beginning with 192.168.7.0. These destinations are routed through the next-hop gateway 192.168.6.157. The route carries the default metric of 1.

3. Configure a route to the same destination, followed by the keyword **null**, a space, and a zero. On the same line, enter a cost metric that is higher than the metric for the preferred route.

```
device(config)# ip route 192.168.7.0/24 null 0 2
```

This example creates a null static route to the same destination. The metric is set higher so that the preferred route is used if it is available. When the preferred route becomes unavailable, the null route is used, and traffic to the destination is dropped.

The following example creates a primary route to all destinations beginning with 192.168.7.0. It creates an alternative null route to drop the packets when the primary route is not available.

```
device# configure terminal
device(config)# ip route 192.168.7.0/24 192.168.6.157
device(config)# ip route 192.168.7.0/24 null 0 2
```

Configuring a default static route

You can manually create a default static route that the router uses if there are no other default routes to a destination.

Perform these steps to configure a default route.

1. Enter global configuration mode.

```
device# configure terminal
```

2. Enter 0.0.0.0/0 as the destination route and prefix-length. On the same line, add the next-hop as an IP address, or enter the key phrase **null 0** to create a null route.

```
device(config)# ip route 0.0.0.0/0 10.24.4.1
```

The example creates a default route through IP address 10.24.4.1.

```
device(config)# ip route 0.0.0.0/0 null 0
```

The example creates a default route that is a null route.

NOTE

You cannot create a default route to a virtual or physical interface.

The following example configures a network default static route that uses IP address 10.24.4.1 as the next hop.

```
device# configure terminal
device(config)# ip route 0.0.0.0/0 10.24.4.1
```

Configuring load sharing and redundancy

You can configure multiple IP static routes to the same destination to set up load sharing or backup routes.

If you configure more than one static route to the same destination with different next-hop gateways but the same metrics, the router load balances among the routes using a basic round-robin method.

If you configure multiple static IP routes to the same destination with different next-hop gateways and different metrics, the router always uses the route with the lowest metric. If this route becomes unavailable, the router fails over to the static route with the next-lowest metric. The following figure depicts two routes with different metrics configured for the same destination.

FIGURE 4 Two static routes to same destination

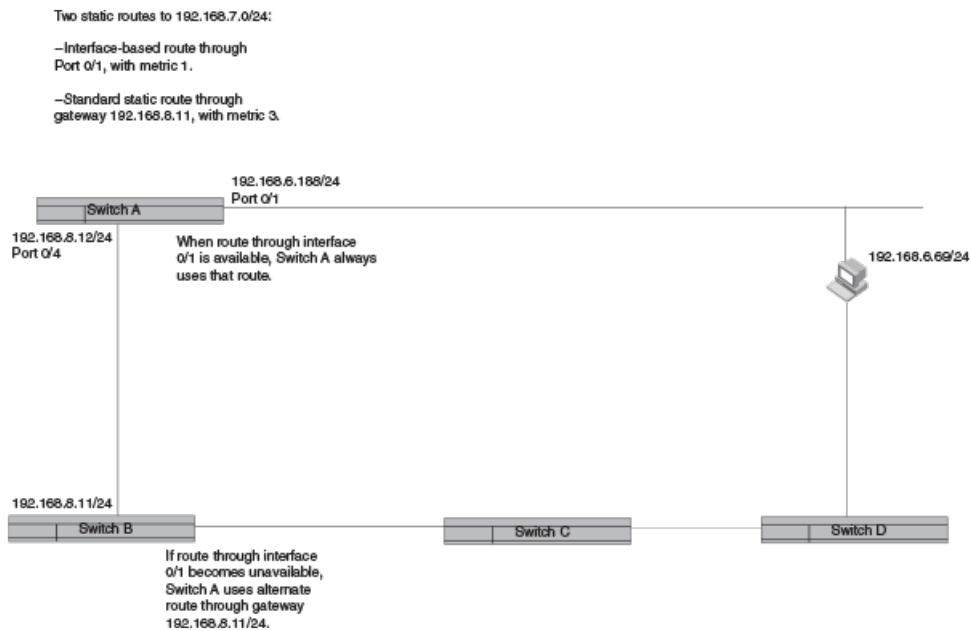

To set up multiple routes for load sharing or redundancy, perform the following steps.

NOTE

You can also use administrative distance to set route priority; however, be sure to give a static route a lower administrative distance than other types of routes, unless you want other route types to be preferred over the static route.

1. Enter global configuration mode.

```
device# configure terminal
```

2. Enter multiple routes to the same destination using different next hops.

```
device(config)# ip route 10.128.2.0/24 10.157.22.1
device(config)# ip route 10.128.2.0/24 10.111.10.1
device(config)# ip route 10.128.2.0/24 10.1.1.1
```

This example creates three next-hop gateways to the destination. Traffic will alternate among the three paths through next-hop 10.157.22.1, next-hop 10.111.10.1, and next hop 10.1.1.1.

3. To prioritize the three routes, use different metrics for each of the three potential next hops.

```
device(config)# ip route 10.128.2.0/24 10.157.22.1
device(config)# ip route 10.128.2.0/24 10.111.10.1 2
device(config)# ip route 10.128.2.0/24 10.1.1.1 3
```

This example creates three alternate routes to the destination. The primary next hop is 10.157.22.1, which has the default metric of 1 (the default metric is not entered in the CLI). If this path is not available, traffic is directed to 10.111.10.1, which has the next lowest metric of 2. If the second path fails, traffic is directed to 10.1.1.1, which has a metric of 3.

Displaying IPv4 static routes

You can check configured IPv4 routes, static routes, directly connected routes, routes configured for different protocols, the cost associated with each route, and the time the route has been available.

1. To show the IP static routes as configured, enter the **show running-config ip route** command.

The following example shows default routes, null routes, and routes configured to physical and virtual interfaces.

```
device# show running-config ip route
ip route 0.0.0.0/0 11.1.1.20
ip route 0.0.0.0/0 12.1.1.20
ip route 11.16.1.0/24 11.1.1.20
ip route 11.12.1.0/24 null 0 2 distance 4 tag 10
ip route 11.13.1.0/24 null 0
ip route 11.14.1.0/24 ethernet 0/14
ip route 11.15.1.0/24 ve 10
ip route 11.17.1.0/24 ethernet 0/14 4 distance 5 tag 6
device#
```

2. To display a list of active static routes and their connection times, at the device prompt, enter the **show ip route static** command.

The following example displays only static routes available on the device, including a default route at the top.

```
device# show ip route static
IP Routing Table for VRF "default-vrf"
Total number of IP routes: 8
'*' denotes best ucast next-hop
'[x/y]' denotes [preference/metric]

0.0.0.0/0
  *via 11.1.1.20, Eth 0/14, [1/1], 5m32s, static, tag 0
11.12.1.0/24
  *via DIRECT, Null0, [4/2], 16m57s, static, tag 10
11.13.1.0/24
  *via DIRECT, Null0, [1/1], 16m12s, static, tag 0
11.14.1.0/24
  *via DIRECT, Eth 0/14, [1/1], 11m58s, static, tag 0
11.16.1.0/24
  *via 11.1.1.20, Eth 0/14, [1/1], 9m46s, static, tag 0
11.17.1.0/24
  *via DIRECT, Eth 0/14, [5/4], 9m2s, static, tag 6
device#
```

- To narrow the output to information for a particular route, enter the **show ip route static** command followed by the destination IP address without the mask or prefix-length.

The following example displays information on a static route with IP address 11.18.1.0/24 using VRF t1 and Ethernet port 0/9 as the next hop.

```
device# configure terminal
device(conf)# ip route 11.18.1.0/24 next-hop-vrf t1 ethernet 0/9
device(conf)# exit

device# show ip route 11.18.1.0
IP Routing Table for VRF "default-vrf"
Total number of IP routes: 13
'*' denotes best ucast next-hop
'[x/y]' denotes [preference/metric]

11.18.1.0/24
  *via DIRECT, Eth 0/9, [1/1], 0m51s, static+(t1), tag 0  <-- "static+(t1)" indicates
                                                         route leaking over VRF t1

device#
device# show ip route static vrf t1
Total number of IP routes: 0
device#
device# show run int e 0/9
interface Ethernet 0/9
vrf forwarding t1
ip proxy-arp
ip address 17.1.1.11/24
no shutdown
!
```

- To show all active IP routes and their connection times, enter the **show ip route** command.

The following example shows six static routes of eight available IP routes on the device, along with the times the routes have been active.

```
device# show ip route
IP Routing Table for VRF "default-vrf"
Total number of IP routes: 8
'*' denotes best ucast next-hop
'[x/y]' denotes [preference/metric]

0.0.0.0/0
  *via 11.1.1.20, Eth 0/14, [1/1], 5m19s, static, tag 0
11.1.1.0/24, attached
  *via DIRECT, Eth 0/14, [0/0], 17m46s, direct, tag 0
11.1.1.11/24, attached
  *via DIRECT, Eth 0/14, [0/0], 17m46s, local, tag 0
11.12.1.0/24
  *via DIRECT, Null0, [4/2], 16m44s, static, tag 10
11.13.1.0/24
  *via DIRECT, Null0, [1/1], 15m59s, static, tag 0
11.14.1.0/24
  *via DIRECT, Eth 0/14, [1/1], 11m45s, static, tag 0
11.16.1.0/24
  *via 11.1.1.20, Eth 0/14, [1/1], 9m33s, static, tag 0
11.17.1.0/24
  *via DIRECT, Eth 0/14, [5/4], 8m49s, static, tag 6
device#
```

IPv6 Static Routing

• Overview of static routing.....	59
• Configuring a basic IPv6 static route.....	60
• Removing an IPv6 static route.....	61
• Configuring an interface as next hop.....	62
• Configuring a virtual interface as next hop.....	63
• Configuring a VRF as next hop for an IPv6 static route.....	64
• Adding metrics to an IPv6 static route.....	64
• Configuring a null route.....	65
• Configuring a default static route.....	67
• Configuring load sharing and redundancy.....	67
• Adding an IPv6 static route tag for use with route-maps.....	69
• Displaying information on IPv6 static routes.....	70

Overview of static routing

Static routes can be used to specify desired routes, backup routes, or routes of last resort. Static routing can help provide load balancing.

Static routes are manually configured entries in the existing IPv6 routing table. In setting up static routes, you can specify several types of destinations:

- Destination network, using an IP address and prefix length
- Default network route
- Next hop router
- VRF for the next hop
- Ethernet interface, typically used for directly attached destination networks
- Virtual interface
- Null interface

You can influence the preference a route is given in the following ways:

- By setting a route metric higher than the default metric
- By giving the route an administrative distance

Static routes can be configured to serve as any of the following:

- Default routes
- Primary routes
- Backup routes
- Null routes for intentionally dropping traffic when the desired connection fails
- Alternative routes to the same destination to help load balance traffic.

Static route states follow port states

IP static routes remain in the IP route table only as long as the port or virtual interface used by the route is available. If the port or virtual routing interface becomes unavailable, the software removes the static route from the IP route table. If the port or virtual routing interface becomes available again later, the software adds the route back to the route table. This feature allows the router to adjust to changes in network topology. The router does not continue trying to use routes on unavailable paths but instead uses routes only when their paths are available.

In the following example, a static route is configured on Switch A.

FIGURE 5 Example of static route

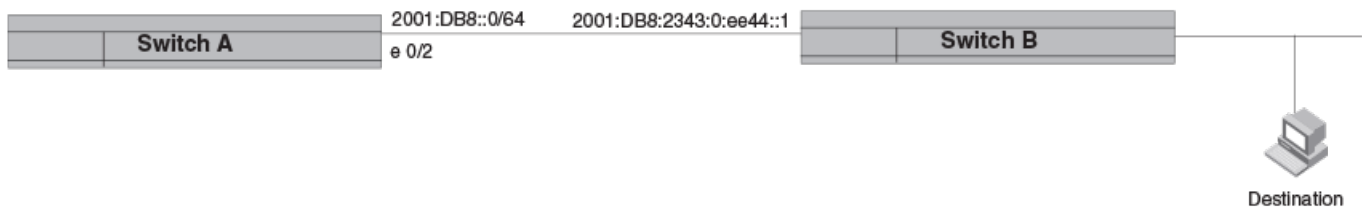

```
device(config)# ipv6 route 2001:DB8::0/64 2001:DB8:2343:0:ee44::1
```

When you configure a static IP route, you specify the destination address for the route and the next-hop gateway or Layer 3 interface through which the Layer 3 device can reach the route. The device adds the route to the IP route table. In this case, Switch A knows that 2001:DB8:2343:0:ee44::1 is reachable through port 0/2, and also assumes that local interfaces within that subnet are on the same port. Switch A deduces that IP interface 2001:DB8::0/64 is also on port 0/2.

Configuring a basic IPv6 static route

To configure a basic IPv6 static route, specify the IPv6 destination address, the address mask, and the IPv6 address of the next hop.

Before configuring a static IPv6 route, you must enable IPv6 on at least one interface by configuring an IPv6 address or explicitly enabling IPv6 on that interface.

To configure a basic IPv6 static route, perform these steps.

1. Enter global configuration mode.

```
device# configure terminal
```

2. Designate the route destination as an IPv6 address in hexadecimal with 16-bit values between colons, as specified in RFC 2373, and include the address prefix length preceded by a slash. On the same command line, enter the IPv6 global address or link-local-address of the next-hop gateway.

```
device(config)# ipv6 route 2001:DB8::0/64 2001:DB8:0:ee44::1
```

The following example configures an IPv6 static route for a destination network with the prefix 2001:DB8::0/64 and a next-hop gateway with the global address 2001:DB8:0:ee44::1

```
device# configure terminal
device(config)# ipv6 route 2001:DB8::0/64 2001:DB8:0:ee44::1
```

Removing an IPv6 static route

The **no** form of the `ipv6 route` command must be entered with exact parameters to remove the command. If the route is configured in a non-default VRF, the **no** form of the `ipv6 route` command must be entered in VRF configuration mode.

Follow these steps to remove an IPv6 static route.

1. (Optional) To view configured routes and confirm exact parameters, enter the command **show ipv6 route** to display the IPv6 route table.

```
device# show ipv6 route
```

This example displays an IPv6 route table with 11 routes in the default VRF.

```
device# show ipv6 route
IPv6 Routing Table for VRF "default-vrf"
Total number of IPv6 routes: 11
'*' denotes best ucast next-hop
'[x/y]' denotes [preference/metric]

1200:1201::/64, attached
  *via ::, Eth 0/40, [0/0], 45m29s, direct, tag 0
1200:1201::1:1/128, attached
  *via ::, Eth 0/40, [0/0], 45m29s, local, tag 0
1200:1202::/64, attached
  *via ::, Ve 2, [0/0], 45m26s, direct, tag 0
1200:1202::1:1/128, attached
  *via ::, Ve 2, [0/0], 45m26s, local, tag 0
2221::/64
  *via 1200:1201::1:2, Eth 0/40, [100/10], 11m41s, static, tag 300
2222::/64
  *via fe80::205:33ff:fee6:a531, Eth 0/40, [1/1], 43m44s, static, tag 0
2222::1/128
  *via fe80::205:33ff:fee6:a531, Eth 0/40, [110/1], 0m7s, ospfv3, intra, tag 0
2223::/64
  *via 1200:1202::1:2, Ve 2, [1/1], 3m45s, static, tag 0
2224::1/128
  *via fe80::205:33ff:fee6:a501, Ve 2, [1/1], 43m41s, static, tag 0
fe80::/10, attached
  *via ::, , [0/0], 6h30m, local, tag 0
ff00::/8, attached
  *via ::, Null0, [0/0], 6h30m, local, tag 0
```

2. (Optional) Enter the **show ipv6 static route** command to narrow the output to static routes only.

```
device# show ipv6 static route
IPv6 Configured Static Routes for VRF "default-vrf"

3002:7::/64-> 1200:3::1:2 preference: 1
  nh_vrf (default-vrf)

3002:9::/64-> 1200:4::1:2 preference: 1
  nh_vrf (default-vrf)
device#
```

3. Enter global configuration mode.

```
device# configure terminal
```

4. Enter **no** followed by the **ipv6 route** command, including destination and next-hop, as shown in the following example. (You do not need to include cost metric, distance, or tag parameters.)

```
device(config)# no ipv6 route 2224::1/128 fe80::205:33ff:fee6:a501 ve 2
```

This example removes the IPv6 route specified.

Removing an IPv6 static route in a non-default VRF

Follow these steps to remove an IPv6 static route from a non-default VRF.

1. (Optional) Enter the **show ipv6 route** command to display route information for the non-default vrf.

```
device# show ipv6 route 2225::/64 vrf blue
IPv6 Routing Table for VRF "blue"
Total number of IPv6 routes: 10
'*' denotes best ucast next-hop
'[x/y]' denotes [preference/metric]

2225::/64
  *via 1200:3::1:2, Eth 0/40, [1/1], 0m5s, static, tag 0

device# show ipv6 route 2225::/64 vrf blue
Total number of IP routes: 0
device#
```

2. Enter VRF configuration mode.

```
device# configure terminal
device(config)# vrf blue
device(config-vrf-blue)# address-family ipv6 unicast
device(vrf-blue-ipv6-unicast)#
```

3. Enter **no** followed by the **ipv6 route** command, including destination and next-hop, as shown in the following example. (You do not need to include cost metric, distance, or tag parameters.)

```
device(vrf-blue-ipv6-unicast)# no ipv6 route 2225::/64 1200:3::1:2
```

4. (Optional) Enter the **show ipv6 route** command for the non-default VRF again to confirm the route has been removed.

```
device# show ipv6 route 2225::/64 vrf blue
Total number of IP routes: 0
device#
```

The following example verifies a route to be removed, enters VRF configuration mode for the non-default VRF "Blue" to remove the IPv6 route, and confirms that the route has been removed.

```
device# show ipv6 route 2225::/64 vrf blue
IPv6 Routing Table for VRF "blue"
Total number of IPv6 routes: 10
'*' denotes best ucast next-hop
'[x/y]' denotes [preference/metric]

2225::/64
  *via 1200:3::1:2, Eth 0/40, [1/1], 0m5s, static, tag 0

device# configure terminal
device(config)# vrf blue
device(config-vrf-blue)# address-family ipv6 unicast
device(vrf-blue-ipv6-unicast)# no ipv6 route 2225::/64 1200:3::1:2
device(vrf-blue-ipv6-unicast)# end

device# show ipv6 route 2225::/64 vrf blue
Total number of IP routes: 0
device#
```

Configuring an interface as next hop

Before configuring a static IPv6 route, you must enable IPv6 on at least one interface by configuring an IPv6 address or explicitly enabling IPv6 on that interface.

To configure an IPv6 static route with an interface as the next hop as depicted in the following illustration, perform these steps.

FIGURE 6 IPv6 static route with an interface as next hop

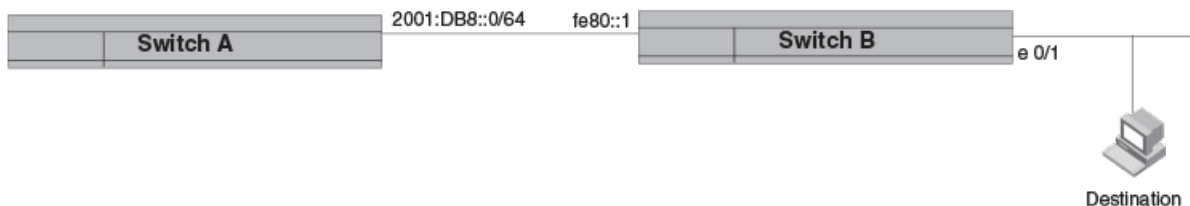

1. Enter global configuration mode.

```
device# configure terminal
```

2. Designate the route destination. On the same command line, enter the link-local IPv6 address followed by the keyword **ethernet** and the interface number for the next hop.

```
device(config)# ipv6 route 2001:DB8::0/64 fe80::1 ethernet 0/1
```

The following example configures a static IPv6 route for a destination network with the prefix 2001:DB8::0/64 and a next-hop gateway with the link-local address fe80::1 that the Layer 3 switch can access through Ethernet interface 0/1.

```
device# configure terminal
device(config)# ipv6 route 2001:DB8::0/64 fe80::1 ethernet 0/1
```

Configuring a virtual interface as next hop

Before configuring a static IPv6 route, you must enable IPv6 on at least one interface by configuring an IPv6 address or explicitly enabling IPv6 on that interface.

To configure a basic IPv6 static route with a virtual interface as a next hop, perform these steps.

1. Enter global configuration mode.

```
device# configure terminal
```

2. Enter the IP address prefix and prefix length for the route destination network.

```
device(config)# ipv6 route 2001:DB8::0/64
```

This example shows the first half of the command, the route destination, IPv6 2001:DB8::0/64 network addresses.

3. On the same command line, enter the link-local address for the destination, followed by the keyword **ve** and the virtual interface ID to be used as the next hop.

```
device# configure terminal
device(config)# ipv6 route 2001:DB8::0/64 fe80::1 ve 3
```

This example shows the next-hop destination as virtual interface (ve) 3, with a link-local address of fe80::1.

The following example configures an IPv6 static route to IPv6 2001:DB8::0/64 destinations through next-hop virtual interface 3.

```
device# configure terminal
device(config)# ipv6 route 2001:DB8::0/64 fe80::1 ve 3
```

Configuring a VRF as next hop for an IPv6 static route

A non-default VRF can be configured as the next-hop gateway for an IPv6 static route.

Before configuring a static IPv6 route, you must enable IPv6 on at least one interface by configuring an IPv6 address or explicitly enabling IPv6 on that interface.

NOTE

The VRF designated in the procedure must be a valid VRF.

To configure a VRF as the next hop for an IPv6 static route, follow these steps.

1. Enter global configuration mode.

```
device# configure terminal
```

2. Enter the **ipv6 route** command followed by the IPv6 destination address and prefix length. On the same command line, enter the keyword **next-hop-vrf** followed by the name of the VRF that contains the next-hop gateway router and its IPv6 address.

```
device(config)# ipv6 route 2001:DB8::0/64 next-hop-vrf partners 2001:DB8:0:ee44::1
```

This example creates an IPv6 static route to IPv6 2001:DB8::0/64 destinations through the VRF named "partners" and the next-hop router with the IPv6 address 2001:DB8:0:ee44::1.

Adding metrics to an IPv6 static route

You can influence how likely a static route is to be used by modifying the cost metric or the administrative distance.

Before configuring a static IPv6 route, you must enable IPv6 on at least one interface by configuring an IPv6 address or explicitly enabling IPv6 on that interface.

Follow these steps to create an IPv6 static route with cost metrics.

1. Enter global configuration mode.

```
device# configure terminal
```

- Designate the route destination and next hop, and add a route priority parameter.

Option	Description
Cost metric	The value is compared to the metric for other static routes in the IPv6 route table to the same destination. Two or more routes to the same destination with the same metric load share traffic to the destination. The value may range from 1 through 16. The default is 1. A route with a cost of 16 is considered unreachable.
Administrative distance	This value is compared to the administrative distance of all routes to the same destination. Static routes by default take precedence over learned protocol routes. However, to give a static route a lower priority than a dynamic route, give the static route the higher administrative distance. The value is preceded by the keyword distance and can range from 1 to 254. The default is 1. A value of 255 is considered unreachable.

```
device(config)# ipv6 route 2001:DB8::0/64 2001:DB8:2343:0:ee44::1 2
```

This example configures a static IPv6 route for a destination network with the prefix 2001:DB8::0/64 and a next-hop gateway with the global address 2001:DB8:0:ee44::1 and assigns the route a metric of 2.

```
device(config)# ipv6 route 2001:DB8::0/64 2001:DB8:2343:0:ee44::1 distance 254
```

This example configures a static route with an administrative distance of 254.

The following example configures an IPv6 static route for a destination network with the prefix 2001:DB8::0/64 and a next-hop gateway with the global address 2001:DB8:0:ee44::1. The static route is assigned an administrative distance of 3.

```
device# configure terminal
device(config)# ipv6 route 2001:DB8::0/64 2001:DB8:0:ee44::1 distance 3
```

Configuring a null route

You can configure a null static route to drop packets to a certain destination. This is useful when the traffic should not be forwarded if the preferred route is unavailable.

NOTE

You cannot add a null or interface-based static route to a network if there is already a static route of any type with the same metric you specify for the null or interface-based route.

The following figure depicts how a null static route works with a standard route to the same destination.

FIGURE 7 Null route and standard route to same destination

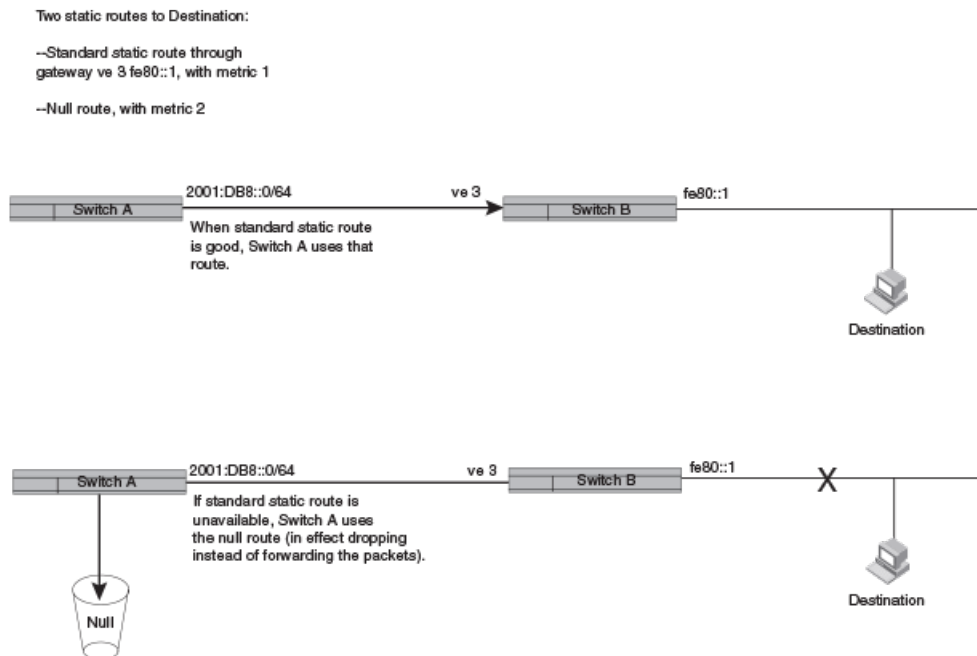

The following procedure creates a preferred route and a null route to the same destination. The null route drops packets when the preferred route is not available.

1. Enter global configuration mode.

```
device# configure terminal
```

2. Configure the preferred route to a destination.

```
device(config)# ipv6 route 2001:DB8::0/64 fe80::1 ve 3
```

This example creates a static route to IPv6 2001 : DB8 : : 0/64 destination addresses. These destinations are routed through link-local address fe80::1 and the next hop gateway virtual interface (ve) 3. The route uses the default cost metric of 1.

3. Configure the null route to the same destination with a higher metric.

```
device(config)# ipv6 route 2001:DB8::0/64 null 0 2
```

This example creates a null static route to the same destination. The metric is set higher so that the preferred route is used if it is available.

The following example creates a primary route to all 2001 : DB8 : : 0/64 destinations through virtual interface (ve) 3. It creates an alternative null route to drop the packets when the primary route is not available.

```
device# configure terminal
device(config)# ipv6 route 2001 : DB8 : : 0/64 fe80::1 ve 3
device(config)# ipv6 route 2001 : DB8 : : 0/64 null 0 2
```

Configuring a default static route

You can manually create a default static route that the router uses if there are no other default routes to a destination.

Perform these steps to configure a default route.

1. Enter global configuration mode.

```
device# configure terminal
```

2. Enter the following destination route and network mask followed by a valid next-hop address.

```
device(config)# ipv6 route ::/0 2001:DB8:0:ee44::1
```

The following example configures a default static route to global IPv6 address 2001:DB8:0:ee44::1.

```
device# configure terminal
device(config)# ipv6 route ::/0 2001:DB8:0:ee44::1
```

Configuring load sharing and redundancy

You can configure multiple IP static routes to the same destination to set up load sharing or backup routes.

If you configure more than one static route to the same destination with different next-hop gateways but the same metrics, the router load balances among the routes using a basic round-robin method.

If you configure multiple static IP routes to the same destination with different next-hop gateways and different metrics, the router always uses the route with the lowest metric. If this route becomes unavailable, the router fails over to the static route with the next-lowest metric. The following figure depicts multiple routes with different metrics configured for the same destination.

FIGURE 8 Two static routes to same destination

Two static routes to 2001:DB8::0/64:

--Primary static route through gateway 2001:1:DB8:2343:0:ee44::1, with default metric 1.

--Standard static route through gateway 2001:DB8:2344:0:ee44::2, with metric 2.

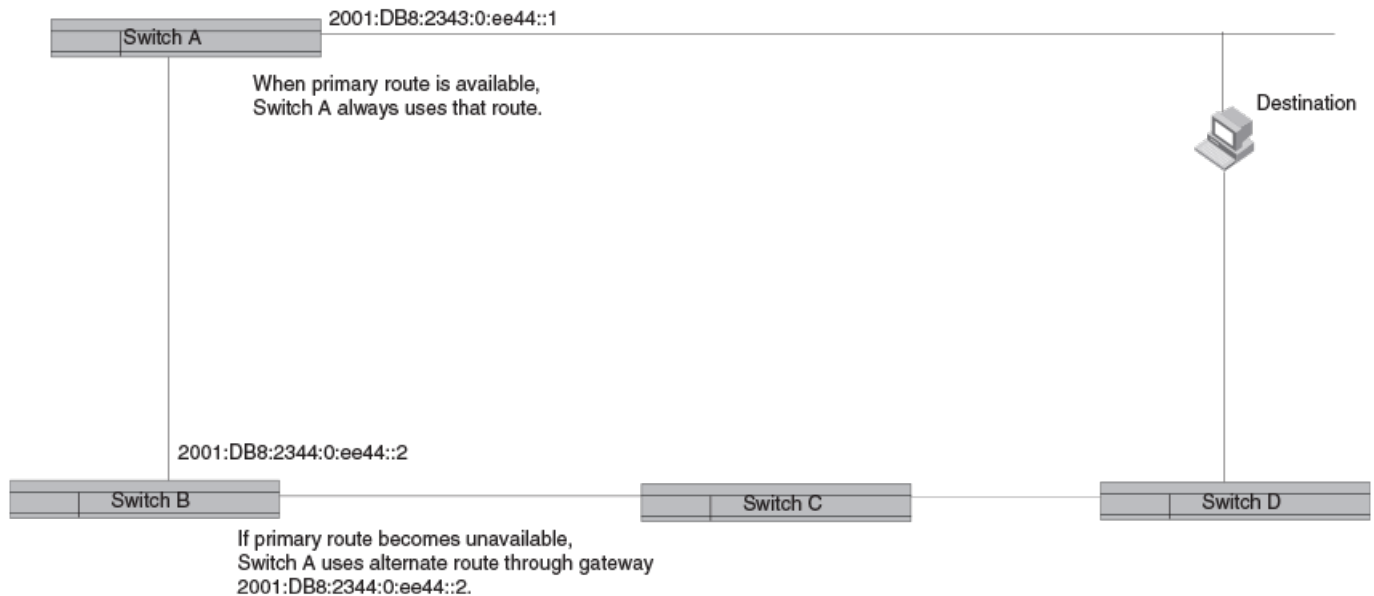

To set up multiple routes for load sharing or redundancy, perform the following steps.

NOTE

You can also use administrative distance to set route priority; however, be sure to give a static route a lower administrative distance than other types of routes, unless you want other route types to be preferred over the static route.

1. Enter global configuration mode.

```
device# configure terminal
```

2. Enter multiple routes to the same destination using different next hops.

```
device(config)# ipv6 route 2001:DB8::0/64 2001:DB8:2343:0:ee44::1
device(config)# ipv6 route 2001:DB8::0/64 2001:DB8:2344:0:ee44::2
```

This example creates two next-hop gateways for all 2001:DB8::0/64 destinations. Traffic will alternate between the two paths.

3. To prioritize multiple routes, use different metrics for each possible next hop.

```
device(config)# ipv6 route 2001:DB8::0/64 2001:DB8:2343:0:ee44::1
device(config)# ipv6 route 2001:DB8::0/64 2001:DB8:2344:0:ee44::2 2
```

This example creates an alternate route to all 2001:DB8::0/64 destinations. The primary route uses 2001:DB8:2343:0:ee44::1 as the next hop. The route has the default metric of 1. If this path is not available, traffic is directed through 2001:DB8:2344:0:ee44::2, which has the next lowest metric (2).

Adding an IPv6 static route tag for use with route-maps

Before configuring a static IPv6 route, you must enable IPv6 on at least one interface by configuring an IPv6 address or explicitly enabling IPv6 on that interface.

To configure an IPv6 static route with a tag that can be referenced in a route-map, follow these steps.

1. Enter global configuration mode.

```
device# configure terminal
```

2. Configure the IPv6 static route destination address and next-hop address. On the same command line, enter the keyword tag, followed by the decimal number to be referenced later in a route-map.

```
device(config)# ipv6 route 2001:DB8::0/64 2001:DB8:0:ee44::1 tag 3
```

The following example configures an IPv6 route to IPv6 2001:DB8::0/64 destinations through next-hop 2001:DB8:0:ee44::1. The route has the tag ID "3," which can be referenced later in a route-map.

```
device# configure terminal
device(config)# ipv6 route 2001:DB8::0/64 2001:DB8:0:ee44::1 tag 3
```

Displaying information on IPv6 static routes

You can consult the IPv6 route table for information on connected, static, and protocol routes.

To display information on IPv6 static routes, use the following commands.

1. To display the IPv6 route table information, enter the **show ipv6 route** command.

```
device# show ipv6 route
IPv6 Routing Table for VRF "default-vrf"
Total number of IPv6 routes: 11
'*' denotes best ucast next-hop
'[x/y]' denotes [preference/metric]

1200:1201::/64, attached
  *via ::, Eth 0/40, [0/0], 45m29s, direct, tag 0
1200:1201::1:1/128, attached
  *via ::, Eth 0/40, [0/0], 45m29s, local, tag 0
1200:1202::/64, attached
  *via ::, Ve 2, [0/0], 45m26s, direct, tag 0
1200:1202::1:1/128, attached
  *via ::, Ve 2, [0/0], 45m26s, local, tag 0
2221::/64
  *via 1200:1201::1:2, Eth 0/40, [100/10], 11m41s, static, tag 300
2222::/64
  *via fe80::205:33ff:fee6:a531, Eth 0/40, [1/1], 43m44s, static, tag 0
2222::1/128
  *via fe80::205:33ff:fee6:a531, Eth 0/40, [110/1], 0m7s, ospfv3, intra, tag 0
2223::/64
  *via 1200:1202::1:2, Ve 2, [1/1], 3m45s, static, tag 0
2224::1/128
  *via fe80::205:33ff:fee6:a501, Ve 2, [1/1], 43m41s, static, tag 0
fe80::/10, attached
  *via ::, , [0/0], 6h30m, local, tag 0
ff00::/8, attached
  *via ::, Null0, [0/0], 6h30m, local, tag 0
```

In the IPv6 route table, connected, static, RIP, OSPF, and BGP routes are listed, along with the destination address, the next hop router, the interface used toward the destination, and the administrative distance and cost for each route.

2. To narrow the display to static routes, enter the **show ipv6 static route** command.

```
device# show ipv6 static route
IPv6 Configured Static Routes for VRF "default-vrf"

3002:7::/64-> 1200:3::1:2 preference: 1
  nh_vrf (default-vrf)

3002:9::/64-> 1200:4::1:2 preference: 1
  nh_vrf (default-vrf)
device#
```

The example shows two IPv6 static routes in the default VRF.

DHCPv4

- DHCPv4 overview..... 71
- IP DHCP Relay function..... 71
- Configuring IP DHCP Relay..... 72
- DHCP relay agent supported user scenarios..... 74
- DHCP relay agent information option 82..... 75
- Enabling the DHCP Relay Agent Information option..... 76
- Configuring DHCP relay gateway address..... 76
- VRF support..... 77
- Displaying IP DHCP Relay statistics..... 78
- Displaying IP DHCP Relay addresses on specific devices..... 79
- Displaying IP DHCP relay addresses for an interface..... 79
- Clearing IP DHCP relay statistics..... 79

DHCPv4 overview

The Dynamic Host Configuration Protocol for DHCPv4 enables DHCP servers to pass configuration parameters such as IPv4 addresses to IPv4 hosts.

The Dynamic Host Configuration Protocol (DHCP) is based on the Bootstrap Protocol (BOOTP) and provides configuration parameters such as IP addresses, default routes, DNS server addresses, access control, QoS policies, and security policies stored in DHCP server databases to DHCP clients upon request. DHCP enables the automatic configuration of client systems. DHCP removes the need to configure devices individually. Clients can set network properties by connecting to the DHCP server instead. This protocol consists of two components; a protocol to deliver host-specific configuration parameters from a DHCP server to a host, and a mechanism to allocate network addresses to hosts.

DHCP is built on a client-server model, where designated DHCP server hosts allocate network addresses and deliver configuration parameters to dynamically configured hosts.

IP DHCP Relay function

DHCP relays are an important feature for large networks as they allow communication between DHCP servers and clients located on different subnets.

In small networks with only one IP subnet, DHCP clients can communicate directly with DHCP servers. Clients located on a different subnet than the DHCP server cannot communicate with that server without obtaining an IP address with appropriate routing information.

By installing a DHCP relay agent on different subnets in a large network, broadcast DHCP packets can be forwarded from a DHCP client to locate a DHCP server on a remote subnet. The relay agent's IP address is stored in the gateway IP address (GIADDR) field of the DHCP packet. The DHCP server uses the GIADDR field to find the subnet where the relay agent received the broadcast, and then assigns IP addresses to that subnet. The DHCP server replies to the client with a unicast message to the relay agent's IP address and the relay agent will forward the response to the local network.

If a relay agent is configured on a Ve interface, Ve 100, which acts over two physical interfaces, ethernet 1/1 and ethernet 1/2, corresponding to two client circuit C1 and C2, then broadcast replies from the server will be forwarded to both the circuits, irrespective of the circuit from which the client packet is received by the relay agent, when both the circuits belong to the same broadcast network.

FIGURE 9 IP DHCP relay function

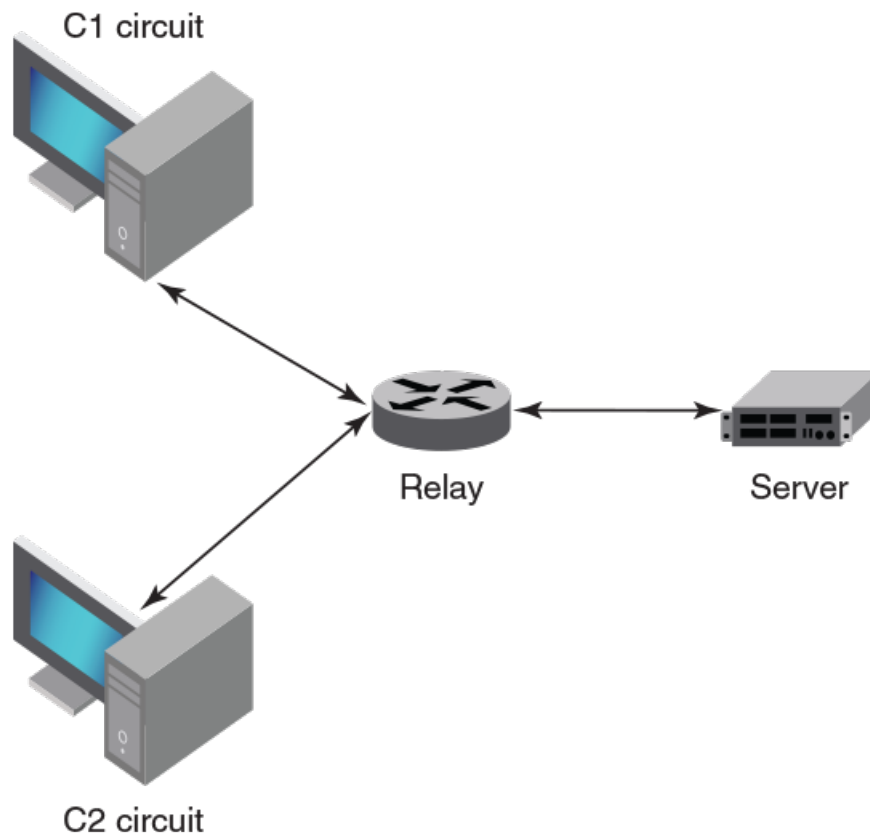

In the above scenario, C1 is connected to Eth 1/1 and C2 is connected to Eth 1/2 physical interfaces. The relay agent is configured at Ve 100. Ve 100 is configured on VLAN 100, where Eth 1/1 and 1/2 ports are tagged. In such a configuration, broadcast responses from the server will be received by both C1 and C2.

Configuring IP DHCP Relay

Configure the IP DHCP Relay agent on any Layer 3 interface using the IP address of the DHCP server where client requests are to be forwarded.

Layer 3 interfaces can be a virtual Ethernet (VE), or physical interfaces.

You can configure the IP DHCP Relay agent using the **ip dhcp relay address** command followed by the IP address of the DHCP server. Use the **use-vrf vrf-name** parameter if the DHCP server and client interface are on different Virtual Forwarding and Routing (VRF) instances.

The following are considerations and limitations when configuring the IP DHCP Relay agent:

- You can configure up to sixteen DHCP server IP addresses per interface. When multiple addresses are configured, the relay agent relays the packets to all server addresses. The total number of addresses configurable on the router is 4000.
- The DHCP server and clients it communicates with can be attached to different VRF instances. When clients and the DHCP server are on different VRFs, use the **use-vrf vrf-name** option with the **ip dhcp relay address** command, where *vrf-name* is the

VRF where the DHCP server is located. For more information on VRF support for the IP DHCP Relay, refer to [VRF support](#) on page 77.

Perform the following steps to configure an IP DHCP Relay:

1. In privileged EXEC mode, enter the **configure terminal** command to enter the global configuration mode.

```
device# configure
```

2. Enter the interface configuration mode.

```
device(config)# interface ethernet 0/1
```

3. Enter the IP address of the DHCP server.

```
device(config-if-eth-0/1)# ip dhcp relay address 100.1.1.2
```

4. Enter the **ip dhcp relay address *ip-addr* use-vrf *vrf-name*** command where *ip-addr* is the IP address of the DHCP server. Use the **use-vrf *vrf-name*** option if the DHCP server is on a different VRF instance than the interface where the client is connected.

```
(config)# int ve 100
device(config-Ve-100)# ip dhcp relay 100.1.1.2 use-vrf blue
```

5. To remove the IP DHCP Relay address enter the **no ip dhcp relay address *ip-addr* use-vrf *vrf-name*** command.

The following example removes an IP DHCP Relay address using the **no** option in the **ip dhcp relay address *ip-addr*** command:

```
device(config-if)# no ip dhcp relay address 200.1.1.2
```

The following example removes an IP DHCP Relay address using the **no** option in the **ip dhcp relay address *ip-addr* use-vrf *vrf-name*** command:

```
device(config-ve-103)# no ip dhcp relay address 10.1.2.255 use-vrf blue
```

DHCP relay agent supported user scenarios

The following examples illustrate the network environments where the DHCP relay agent is supported.

FIGURE 10 DHCP relay agent user scenarios

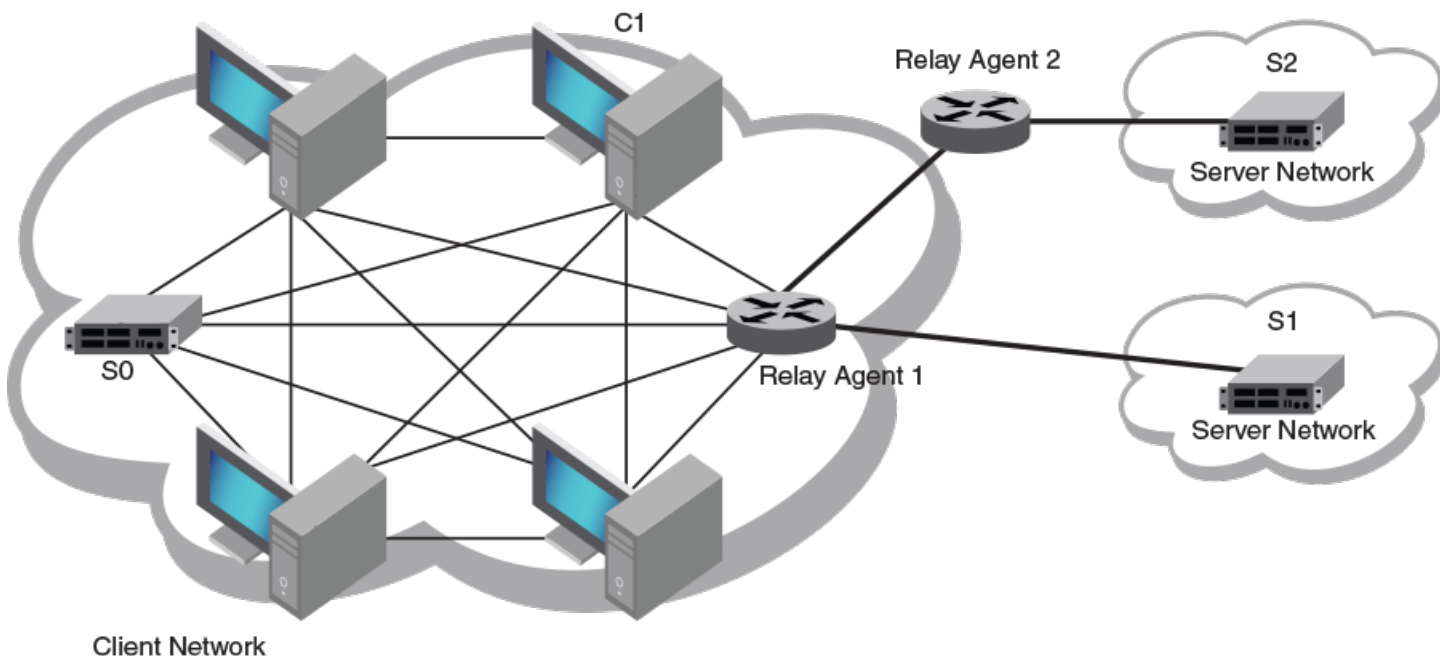

DHCP server local

Client 1 and Server 0 (S0) are on the same subnet (same broadcast domain). A relay agent is not required in this scenario, because the server will receive broadcast discover messages from the client directly; a configured relay agent in this scenario is redundant, as the relay agent would relay (unicast) the received DHCP packet again to the destination server or client, and as a result both parties receive multiple packets.

DHCP server remote

Client 1 (C1) and Server 1 (S1) are on different subnets but directly linked through a relay agent.

DHCP servers in a network

Client 1 (C1) and Server 2 (S2) are on different subnets and connected through relay chaining (relay multi-hops).

Multiple DHCP servers

Server 1 (S1) and Server 2 (S2) are two server addresses on different subnets configured at relay agent 1.

DHCP server in different VRFs

Client 1 (C1) and Server 1 (S1) are on different VRFs.

DHCP relay agent information option 82

When DHCP relay agent information option 82 is enabled, relay agent information option-82 is inserted by the relay agent before relaying DHCP client requests to the server.

The relay agent information option-82 allows the DHCP server to select a sub-range in the DHCP server address pool. The DHCP server echos the option 82 in the DHCP reply packet. The DHCP relay agent validates and removes the option 82 information, and then sends the response to the DHCP client.

Adding option 82 to the DHCP client helps address the following security issues:

- Allows the relay agent to identify the circuit to which to forward replies.
- Prevents DHCP IP address exhaustion attacks. IP address exhaustion occurs when an attacker requests all available IP addresses from a DHCP server by sending requests with fake client MAC addresses.
- Prevents permanently assigning an IP address to a particular user or modem.
- Prevents spoofing of client identifier fields used to assign IP addresses.
- Prevents denial of service (DoS) attacks.

The DHCP Relay Agent Information Option is a container option for specific agent-supplied sub-options. The format of the relay agent information option is as follows:

Code	Len	Agent Information Field					
82	N	i1	i2	i3	i4	...	iN

NOTE

The length N represents the total number of octets in the Agent Information Field. The Agent Information field consists of a sequence of SubOpt/Length/Value tuples for each sub-option.

Relay Agent Circuit ID sub-option

Sub-option type (1 byte)	Length (1 byte)	VLAN ID <string> (4 bytes)	IF-description string (4 bytes)
2	68		

NOTE

The circuit ID is a combination of the VLAN-ID and the interface description string. If the interface description is not configured, the default string "Brocade" is used in the circuit ID.

Agent remote ID sub-option

Sub-option type (1 byte)	Length (1 byte)	VLAN ID (2 bytes)	MAC address (6 bytes)
2	8		

Relay agent operation with Option 82 enabled

When Option 82 is enabled, the relay agent performs the following actions:

- If the client receives a DHCP packet with the GIADDR field set to zero, but with the Option 82 already present, the relay agent discards the packet and increments the error count.
- If the client receives a DHCP packet with the GIADDR field set to a GIADDR implemented by the local agent, the packet is discarded.
- Adds the IP address of the relay agent (in the GIADDR field).
- Inserts the Option 82 information as the last option in a request packet. Option 82 information contains the remote ID sub-option and the circuit ID sub-option.
- Relays the packet to the DHCP server.
- Removes Option 82 from the received packets from the DHCP server after validation.
- Forwards the packet to the client.

Configuration considerations

The following configuration considerations apply to DHCP Option 82:

- The relay agent does not monitor the client requests during the renewal phase. Also, the device forwards request packets with a non-zero GIADDR from a different relay agent.
- You cannot configure each sub-option separately. Enabling Option 82 enables the insertion of the circuit ID and remote ID sub-options.
- DHCP relay Option 82 can be enabled or disabled globally. You cannot enable or disable this option at the interface level.

Enabling the DHCP Relay Agent Information option

Complete the following steps to enable insertion or removal of DHCP relay information option-82 present in the DHCP client and server packets respectively.

1. Enter the global configuration mode.

```
device# configure
```

2. Enter the **ip dhcp relay information option** command to enable option-82.

```
device(config)# ip dhcp relay information option
```

Configuring DHCP relay gateway address

When the DHCP relay agent forwards a BootP or DHCP request, the relay agent stamps the Gateway Address field.

The default value the relay agent uses to stamp the packet is the lowest-numbered primary IP address configured on the interface that received the request.

The following considerations apply to DHCP relay gateway address configuration:

- If the DHCP relay gateway address is configured, but no IP address is configured on the interface, the DHCP relay agent will not relay the requests until IP address is configured on the interface.

- When the IP DHCP relay gateway address is configured, but does not match the IP addresses configured on the interface, the DHCP relay agent uses the default value, the lowest-numbered IP address configured on the interface. When the gateway address is one of the IP addresses configured on the interface, it will be used to stamp the requests.
- Virtual IP addresses or local subnet broadcast addresses must not be used as the DHCP relay gateway address.
- Any primary or secondary IP address configured on the interface can be used as the DHCP relay gateway address.

The following steps change the DHCP relay gateway address used for stamping BootP or DHCP requests received on a Layer 3 interface.

1. Enter the global configuration mode.

```
device# configure terminal
```

2. Enter the interface configuration mode.

```
device(config)# interface ethernet 0/1
```

3. Enter the **ip dhcp relay gateway** command followed by the IP address used for stamping BootP or DHCP requests received on a Layer 3 interface.

```
device(conf-if-eth-0/1)# ip dhcp relay gateway 10.50.22.26
```

The relay agent places the IP address 10.50.22.26 in the Gateway Address field of BootP or DHCP requests that the router receives on port 0/1 and forwards to the BootP or DHCP server.

VRF support

Virtual Routing and Forwarding (VRF) is a technology that controls information flow within a network by partitioning the network into different logical VRF domains to isolate traffic. This allows a single device to have multiple containers of routing tables or Forwarding Information Bases (FIBs), with one routing table for each VRF instance. This permits a VRF-capable router to function as a group of multiple virtual routers on the same physical router.

Inter-VRF route leaking allows leaking of specific route prefixes from one VRF instance to another on the same physical router, which eliminates the need for external routing.

The IP DHCP Relay is supported in configurations where the DHCP server is on the same or different VRF instances than the interface through which the client is connected. When the DHCP server and client are on different VRFs, this is called inter-VRF deployment. For inter-VRF deployment, use the `use-vrf vrf-name` option with the **ip dhcp relay address** command, where *vrf-name* is the VRF where the DHCP server is located.

Supported VRF configuration examples

Following are examples of VRF configurations that are supported for IP DHCP Relay:

- Client interface and DHCP server are on the same VRF instance. For example:
 - VE interface 100 in VRF "red"
 - IP address of interface - 3.1.1.1/24
 - IP DHCP Relay address (20.1.1.2)
- Client interface and DHCP servers are on different VRF instances. For example:
 - VE interface 100 in default VRF
 - IP address of interface - 3.1.1.1/24
 - IP DHCP Relay address (100.1.1.2) in VRF "blue"

- IP DHCP Relay address (1.2.3.4.6) in VRF "red"

A maximum of 128 of these inter-VRF IP DHCP Relay address configurations is allowed per node. A VRF route leak configuration is required for these configurations. In the preceding example, a VRF route leak configuration is required on the default VRF as follows:

- ip route 100.1.1.2/32 next-hop-vrf blue <exit interface/next-hop-ip>
- ip route 12.3.4.6/32 next-hop-vrf red <exit interface/next-hop-ip>

VRF configuration examples to avoid

The following examples of VRF configurations are not recommended for IP DHCP Relay.

- The same IP DHCP Relay address configured on different VRFs. As an example:
 - VE interface 100 in default VRF
 - IP address of interface - 3.1.1.1/24
 - IP DHCP Relay address (30.1.1.2) in VRF "blue"
 - IP DHCP Relay address (30.1.1.2) in VRF "red"

Displaying IP DHCP Relay statistics

Display information about the DHCP Relay function, such as the DHCP Server IP address configured on the device and the number of DHCP packets received and dropped by the interface configured for IP DHCP Relay.

Use the **show ip dhcp relay statistics** command to display the following information about the IP DHCP Relay function:

- DHCP Server IP Address configured in the device.
 - Number of DHCP DISCOVERY, OFFER, REQUEST, ACK, NAK, DECLINE, and INFORM packets received.
 - Number of DHCP client packets received (on port 67) and relayed by the Relay Agent.
 - Number of DHCP server packets received (on port 68) and relayed by the Relay Agent.
 - Number of DHCP client packets dropped by the Relay Agent.
 - Number of DHCP server packets dropped by the Relay Agent.
1. Access a device where an IP DHCP Relay has been configured on an interface.
 2. In privileged EXEC mode, enter **show ip dhcp relay statistics**.

The following example displays statistics for the device.

```
device# show ip dhcp relay statistics

Address  Disc.  Offer  Req.   Ack   Nak   Decline  Inform
-----  -
2.3.4.5   300    100   1211  1201   0     0         0
10.0.1.2  300    100   1211  1207   0     0         0

Client Packets: 2701
Server Packets: 2932
Client Packets Dropped: 0
Server Packets Dropped: 0
```

Displaying IP DHCP Relay addresses on specific devices

Use the **show ip dhcp relay address** command to display all IP DHCP Relay addresses configured on specific devices.

1. Access a device where an IP DHCP Relay has been configured.
2. In privileged EXEC mode, enter the **show ip dhcp relay address** command.

The following example displays addresses configured on the interfaces of the device.

```
device# show ip dhcp relay address
DHCP Relay Information Option: Enabled

-----
Interface                Relay Address          VRF Name
-----
eth0/18                  105.0.0.10            default-vrf
eth0/18                  107.0.0.1             default-vrf
ve 200                   107.0.0.1             default-vrf
```

Displaying IP DHCP relay addresses for an interface

You can display IP DHCP relay addresses configured on specific interfaces of a device.

To display the IP DHCP relay addresses configured for an interface, use the **show ip dhcp relay address interface** command followed by the interface ID to display IP DHCP relay addresses configured on a specific interface.

1. Access a device where an IP DHCP relay has been configured on an interface.
2. In privileged EXEC mode, enter the **show ip dhcp relay address interface** command followed by the interface ID.

The following example displays addresses configured on interface 0/24.

```
device# show ip dhcp relay address interface eth 0/24

Interface                Relay Address          VRF Name
-----
eth 0/24                 10.3.4.5              Blue
eth 0/24                 10.5.1.1              Blue
```

The following example displays addresses configured on VE 200.

```
device# show ip dhcp relay address interface ve 200
DHCP Relay Information Option: Enabled
DHCP Remote ID (Type:Length:Vlan:Mac): 00:08:0000:000000f8003d

Interface                Relay Address          VRF Name
-----
ve 200                   107.0.0.1             default-vrf
```

Clearing IP DHCP relay statistics

Use the **clear ip dhcp relay statistics** command to clear all IP DHCP Relay statistics for specific relay IP addresses.

1. Access a device where an IP DHCP Relay has been configured on an interface.
2. In privileged EXEC mode, issue the **clear ip dhcp relay statistics ip-address** *ip-address*.

Clearing IP DHCP relay statistics

The following command clears statistics for IP DHCP Relay address 105.0.0.10.

```
device# clear ip dhcp relay statistics ip-address 105.0.0.10
```

DHCPv6

• DHCPv6 overview.....	81
• DHCP relay agent for IPv6.....	81
• DHCPv6 multicast addresses and UDP ports.....	81
• DHCPv6 address assignment.....	82
• DHCPv6 message format.....	82
• Configuring IPv6 DHCP relay.....	84
• Displaying DHCPv6 relay addresses on specific devices.....	85
• Displaying DHCPv6 relay addresses for an interface.....	85
• Displaying IPv6 DHCP relay statistics.....	86
• Clearing IP DHCPv6 relay statistics.....	86

DHCPv6 overview

The Dynamic Host Configuration Protocol for IPv6 (DHCP) enables DHCP servers to pass configuration parameters such as IPv6 network addresses to IPv6 nodes.

The DHCPv6 protocol offers the capability of automatic allocation of reusable network addresses and additional configuration flexibility.

DHCP relay agent for IPv6

A client locates a DHCPv6 server using a reserved, link-scoped multicast address. Direct communication between the client and server requires that they are attached by the same link. In some situations where ease-of-management, economy, and scalability are concerns, you can allow a DHCPv6 client to send a message to a DHCPv6 server using a DHCPv6 relay agent.

A DHCPv6 relay agent, which may reside on the client link, but is transparent to the client, relays messages between the client and the server. Multiple DHCPv6 relay agents can exist between the client and server. DHCPv6 relay agents can also receive relay-forward messages from other relay agents; these messages are forwarded to the DHCPv6 server specified as the destination.

When the relay agent receives a message, it creates a new relay-forward message, inserts the original DHCPv6 message, and sends the relay-forward message as the DHCPv6 server.

DHCPv6 multicast addresses and UDP ports

The relay agent uses specific multicast addresses and UDP ports for the DHCPv6 functionality.

Multicast addresses

All_DHCP_Relay_Agents_and_Servers (FF02::1:2) is a link-scoped multicast address used by the client to communicate with neighboring (for example, on-link) relay agents and servers. All servers and relay agents are members of this multicast group.

All_DHCP_Servers (FF05::1:3) is a site-scoped multicast address used by the relay agent to communicate with servers, either because the relay agent wants to send messages to all servers or because it does not know the unicast addresses of the servers. To use this address a relay agent must have an address of sufficient scope to be reachable by the servers. All servers within the site are members of this multicast group.

UDP ports

The relay agent listens on UDP ports 546 and 547 for packets sent by clients and servers. The relayed packets use the source port 547.

DHCPv6 address assignment

The DHCPv6 relay agent informs hosts to use one of the following address assignment methods.

Basic DHCPv6 relay assignment

The DHCPv6 Relay agent relays the DHCP messages from clients and other relay agents to a list of destination addresses, which includes unicast IPv6 addresses, the All_DHCP_Servers multicast address, or other user-defined IPv6 multicast group address, on the same VRF as the interface on which the client resides or on a different VRF.

DHCPv6 prefix delegation

The DHCPv6 relay agent relays all the DHCPv6 messages (which may or may not contain the DHCPv6 options) that are to be relayed across the DHCPv6 client and the server. The relay agent will not access or extract the information present in the prefix delegation option.

Relay chaining

DHCPv6 messages can be relayed through multiple relay agents. The Relay-Reply message from the server will be relayed back to the client in the same path it took to reach the server.

Relay-message option

The DHCPv6 relay agent includes the relay message option in all the RELAY-FORW messages.

Remote-ID option

The DHCPv6 relay agent supports the Remote-ID option (option code 37). No user configuration is necessary for this method. The DHCPv6 unique identifier (DUID) of relay agent is used as the remote ID.

Interface-ID option

The DHCPv6 relay agent supports the Interface-ID option to identify the interface on which the client message was received. No user configuration is necessary for this method.

DHCPv6 message format

The DHCPv6 message format varies from the DHCPv4 message format. This section describes the events that occur when a DHCPv6 client sends a Solicit message to locate DHCPv6 servers.

- Solicit (1) - A DHCPv6 client sends a Solicit message to locate DHCPv6 servers.

- Advertise (2) - A server sends an Advertise message to indicate that it is available for DHCP service, in response to a Solicit message received from a client.
- Request (3) - A client sends a Request message to request configuration parameters, including IP addresses or delegated prefixes, from a specific server.
- Confirm (4) - A client sends a Confirm message to any available server to determine whether the addresses it was assigned are still appropriate to the link to which the client is connected. This could happen when the client detects either a link-layer connectivity change or if it is powered on and one or more leases are still valid. The confirm message confirms whether the client is still on the same link or whether it has been moved. The actual lease(s) are not validated; just the prefix portion of the addresses or delegated prefixes.
- Renew (5) - A client sends a Confirm message to any available server to determine whether the addresses it was assigned are still appropriate to the link to which the client is connected. This could happen when the client detects either a link-layer connectivity change or if it is powered on and one or more leases are still valid. The confirm message confirms whether the client is still on the same link or whether it has been moved. The actual lease(s) are not validated; just the prefix portion of the addresses or delegated prefixes.
- Rebind (6) - A client sends a Rebind message to any available server to extend the lifetimes on the addresses assigned to the client and to update other configuration parameters; this message is sent after a client receives no response to a Renew message.
- Reply (7) - A server sends a Reply message containing assigned addresses and configuration parameters in response to a Solicit, Request, Renew, Rebind message received from a client. A server sends a Reply message containing configuration parameters in response to an Information-request message. A server sends a Reply message in response to a Confirm message confirming or denying that the addresses assigned to the client are appropriate to the link to which the client is connected. A server sends a Reply message to acknowledge receipt of a Release or Decline message.
- Release (8) - A client sends a Release message to the server that assigned addresses to the client to indicate that the client will no longer use one or more of the assigned addresses.
- Decline (9) - A client sends a Decline message to a server to indicate that the client has determined that one or more addresses assigned by the server are already in use on the link to which the client is connected.
- Reconfigure (10) - A server sends a Reconfigure message to a client to inform the client that the server has new or updated configuration parameters, and that the client needs to initiate a Renew/Reply or Information-request/Reply transaction with the server in order to receive the updated information.
- Information-request (11) - A client sends an Information-request message to a server to request configuration parameters without the assignment of any IP addresses to the client.
- Relay-forward (12) - A relay agent sends a Relay-forward message to relay messages to servers, either directly or through another relay agent. The received message, either a client message or a Relay-forward message from another relay agent, is encapsulated in an option in the Relay-forward message.
- Relay-reply - A server sends a Relay-reply message to a relay agent containing a message that the relay agent delivers to a client. The Relay-reply message may be relayed by other relay agents for delivery to the destination.

NOTE

The **show ipv6 dhcp relay statistics** command does not display the show packet count in the statistics for DHCPv6 Advertise and Re-configure messages, as it is sent from the DHCPv6 server to DHCPv6 client directly, not through the relay server.

The table lists the DHCPv4 and DHCPv6 message types:

TABLE 9 DHCPv4 message versus DHCPv6 message

DHCPv6 message type	DHCPv4 message type
Solicit (1)	DHCPDISCOVER
Advertise (2)	DHCPOFFER

TABLE 9 DHCPv4 message versus DHCPv6 message (continued)

DHCPv6 message type	DHCPv4 message type
Request (3), Renew (5), Rebind (6)	DHCPREQUEST
Reply (7)	DHCPPACK/DHCPNAK
Release (8)	DHCPRELEASE
Information-Request (11)	DHCPINFORM
Decline (9)	DHCPDECLINE
Confirm (4)	None
Reconfigure (10)	DHCPFORCERENEW
Relay-Forward(12), Relay-Reply (13)	None

Configuring IPv6 DHCP relay

Configure the IPv6 DHCP relay agent on any Layer 3 (L3) interface using the IP address of the DHCP server where client requests are to be forwarded.

Layer 3 interfaces can be a virtual Ethernet (VE), or physical interfaces.

You can configure the IPv6 DHCP relay agent using the **ipv6 dhcp relay address** command followed by the IP address of the DHCP server. Use the **use-vrf vrf-name** parameter if the DHCP server and client interface are on different Virtual Forwarding and Routing (VRF) instances. You can configure up to 16 relay destination addresses per interface.

The following scalability numbers apply to IPv6 DHCP relay:

- The total number of DHCPv6 server addresses is 4000.
- The total number of DHCPv6 server addresses per interface is 16.
- The total number of inter-vrf Client-Server configurations for DHCPv4 and v6 relay is 128.

Perform the following steps to configure an IPv6 DHCP Relay:

1. In privileged EXEC mode, issue the **configure terminal** command to enter the global configuration mode.

```
device# configure
```

2. Enter the **interface** command followed by the interface ID to enter the interface configuration mode where you want to configure the IP DHCP Relay.

```
device# interface ethernet 0/4
```

3. Enter the IP address of the DHCP server followed by the interface number.

```
device(conf-if-eth-0/4)# ipv6 dhcp relay address 2000::10
device(conf-if-eth-0/4)# ipv6 dhcp relay address fe80::1016 interface ethernet 0/6
```

4. Enter the **ipv6 dhcp relay address ip-addr use-vrf vrf-name** command where *ip-addr* is the IP address of the DHCP server. Use the **use-vrf vrf-name** option if the DHCP server is on a different VRF instance than the interface where the client is connected.

```
(config)# int ve 100
device(config-Ve-100)# ipv6 dhcp relay address 2001::1122:AABB:CCDD:3344 use-vrf blue
```

Displaying DHCPv6 relay addresses on specific devices

Use the **show ipv6 dhcp relay address** command to display all IP DHCP Relay addresses configured on specific devices.

1. Access a device where an IP DHCPv6 Relay has been configured.
2. In privileged EXEC mode, execute the **show ipv6 dhcp relay address** command.

The following example displays addresses configured on the interfaces of a device.

```
device# show ipv6 dhcp relay address

DHCPv6 unique identifier(DUID): 0102f8f10027f8d43dfb

Interface          Relay Address          VRF Name          Outgoing Interface
-----          -
eth 0/17           2002::10               default-vrf
eth 0/17           2000::10               default-vrf        eth 0/9
eth 0/17           2019::10               test                ve 102
ve 94              2011::10               default-vrf
```

Displaying DHCPv6 relay addresses for an interface

You can display IPv6 DHCP Relay addresses configured on a specific interfaces of the device.

To display the IPv6 DHCP Relay addresses configured for an interface, use the **show ipv6 dhcp relay address interface** command followed by the specific interface to display IP DHCP Relay addresses configured on a specific interface.

1. Access a device where an IP DHCP Relay has been configured on an interface.
2. In privileged EXEC mode, execute the **show ip dhcp relay address interface** command followed by the interface ID.

The following example displays the IPv6 DHCP Relay addresses configured on interface 0/4.

```
device# show ipv6 dhcp relay address interface ethernet 0/4

DHCPv6 unique identifier(DUID): 01021025768ef804e005

Interface          Relay Address          VRF Name          Outgoing Interface
-----          -
Eth 0/4            2019::10               default-vrf
```

The following example displays the IPv6 DHCP Relay addresses configured on interface ve 109.

```
device# show ipv6 dhcp relay address interface ve 109

DHCPv6 unique identifier(DUID): 01021025768ef804e005

Interface          Relay Address          VRF Name          Outgoing Interface
-----          -
Ve 109             2020::20               default-vrf
```

Displaying IPv6 DHCP relay statistics

Display information about the DHCP Relay function, such as the DHCP Server IP address configured on the device and the number of various DHCP packets received by the interface configured for IP DHCP Relay.

Use the **show ipv6 dhcp relay statistics** command to display the following information about the IPv6 DHCP Relay function:

- Number of SOLICIT, REQUEST, CONFIRM, RENEW, REBIND, RELEASE, DECLINE, INFORMATION-REQUEST, RELAY-FORWARD, RELAY-REPLY packets received.
 - Number of RELAY-FORWARD and REPLY packets sent and packets dropped.
1. Access a device where an IPv6 DHCP Relay has been configured on an interface.
 2. In privileged EXEC mode, enter **show ipv6 dhcp relay statistics**.

The following example displays DHCP relay statistics on the device.

```
device# show ipv6 dhcp relay statistics

DHCPv6 Relay Statistics
-----
Packets dropped : 0
Error : 0
Packets received : 60
SOLICIT : 6
REQUEST : 6
CONFIRM : 0
RENEW : 2
REBIND : 0
RELEASE : 6
DECLINE : 0
INFORMATION-REQUEST : 0
RELAY-FORWARD : 0
RELAY-REPLY : 40
Packets sent : 60
RELAY-FORWARD : 20
REPLY : 40
```

Clearing IP DHCPv6 relay statistics

Use the **clear ip dhcpv6 relay statistics** command to clear all IPv6 DHCP Relay statistics globally.

1. Access a device where an IPv6 DHCP Relay has been configured on an interface.
2. In privileged EXEC mode, issue the **clear ipv6 dhcp relay statistics ip-address ip-address** command.

The following command clears the IPv6 DHCP Relay address statistics globally.

```
device# clear ipv6 dhcp relay statistics
```

BFD

- Bidirectional Forwarding Detection overview..... 87
- General BFD considerations and limitations..... 88
- BFD for Layer 3 protocols..... 88
- BFD considerations and limitations for Layer 3 protocols..... 89
- BFD for Layer 3 protocols on virtual Ethernet interfaces..... 90
- Configuring BFD on an interface..... 90
- Disabling BFD on an interface..... 90
- BFD for BGP..... 91
- BFD for OSPF..... 94
- BFD for static routes..... 98
- Displaying BFD information..... 103

Bidirectional Forwarding Detection overview

Bidirectional Forwarding Detection (BFD) is a unified detection mechanism used to rapidly detect link faults. BFD improves network performance by providing fast forwarding path failure detection times.

BFD provides rapid detection of the failure of a forwarding path by checking that the next-hop device is alive. When BFD is not enabled, it can take from 3 to 30 seconds to detect that a neighboring device is not operational. This causes packet loss due to incorrect routing information at a level unacceptable for real-time applications such as VOIP and video over IP.

Using BFD, you can detect a forwarding path failure in 150 milliseconds.

A BFD session is automatically established when a neighbor is discovered for a protocol, provided that BFD is enabled on the interface on which the neighbor is detected and BFD is also enabled for the protocol at the interface level or globally. Once a session is established, each device transmits control messages at a high rate of speed that is negotiated by the devices during the session setup. To provide a detection time of 150 milliseconds, it is necessary to process 20 messages per second of about 70 to 100 bytes each per session. A similar number of messages also need to be transmitted out per session. Once a session is established, that same message is continuously transmitted at the negotiated rate and a check is made that the expected control message is received at the agreed frequency from the neighbor. If the agreed upon messages are not received from the neighbor within a negotiated timeout period, the neighbor is considered to be down.

BFD can provide failure detection on any kind of path between systems, including direct physical links, multihop routed paths, and tunnels. Multiple BFD sessions can be established between the same pair of systems when multiple paths between them are present in at least one direction, even if a lesser number of paths are available in the other direction.

For a single-hop session, the BFD Control Message is a UDP message with destination port 3784. For a multihop session, the BFD Control Message is a UDP message with destination port 4784 sent over IPv4 or IPv6, depending on which data forwarding path failure BFD is trying to detect.

NOTE

The source port for BFD control packets is in the range 49152 through 65535. The source port number is unique among all BFD sessions on the system.

NOTE

For single-hop sessions, all BFD control packets are sent with a time to live (TTL) or hop limit value of 255. All received BFD control packets are discarded if the received TTL or hop limit is not equal to 255.

General BFD considerations and limitations

There are a number of general points to consider when configuring BFD:

- BFD protocol version 1 is supported. BFD version 0 is not supported. BFD version 1 and BFD version 0 are not compatible.
- BFD single-hop sessions always use the primary IP address as the source address. Secondary IP addresses cannot be used as source addresses on single-hop sessions.

Refer to [BFD considerations and limitations for Layer 3 protocols](#) on page 89 and the *BFD considerations and limitations for static routes* section of the “IP Route Policy” chapter for more information on BFD considerations and limitations.

BFD for Layer 3 protocols

BFD can be used by Layer 3 protocols for rapid failure detection in the forwarding path between two adjacent routers, including the interfaces, data links, and forwarding planes.

BFD can be configured for use with the following protocols:

- OSPFv2
- OSPFv3
- BGP4
- BGP4+

BFD must be enabled at both the interface and routing protocol levels. BFD asynchronous mode, which depends on the sending of BFD control packets between two systems to activate and maintain BFD neighbor sessions between routers, is supported. Therefore, in order for a BFD session to be created, BFD must be configured on both BFD peers.

Once BFD is enabled on the interfaces and at the router level for the appropriate routing protocols, a BFD session is created. BFD timers are then negotiated, and the BFD peers begin to send BFD control packets to each other at the negotiated interval.

BFD provides a single point of forwarding path monitoring. This means that when more than one Layer 3 application wants to monitor a single host, BFD runs a single session for that host and provides the status to multiple applications, instead of multiple applications running individual sessions to the host.

By sending rapid failure detection notices to the routing protocols in the local device to initiate the routing table recalculation process, BFD contributes to greatly reducing overall network convergence time.

The following figure shows the establishment of a BFD session where OSPF discovers a neighbor and sends a request to BFD requesting that a BFD neighbor session be created with the OSPF neighbor router.

FIGURE 11 Establishing a BFD neighbor session

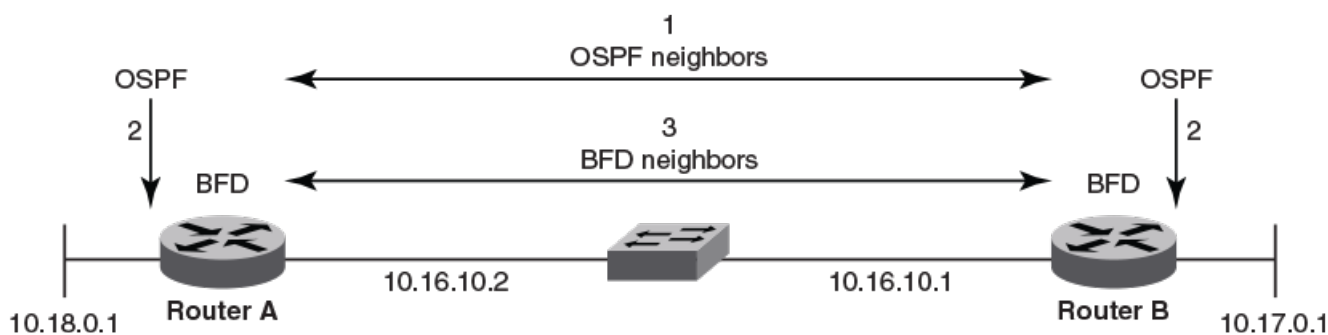

The following figure shows the termination of a BFD neighbor session after a failure occurs in the network.

FIGURE 12 Termination of a BFD neighbor session

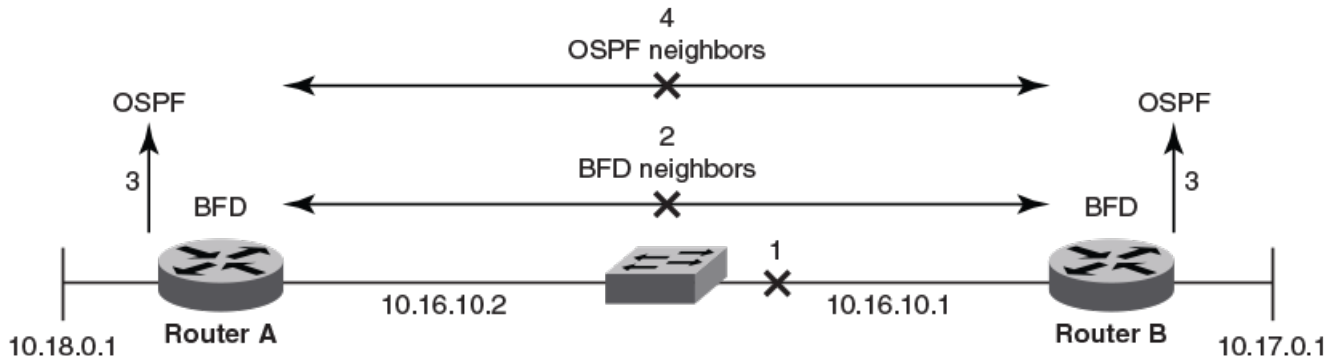

BFD considerations and limitations for Layer 3 protocols

There are a number of things to consider when configuring BFD for Layer 3 protocols:

- BFD supports both single-hop and multihop sessions.
- For single-hop sessions, the IP address that matches the subnet of the destination IP address is always used as the source IP address of the BFD control packet. If the source IP address is changed, the session is brought down unless another corresponding address with the same subnet is available.
- For single-hop sessions, an IPv6 address that matches the prefix and scope of the destination IPv6 address is used as the source IPv6 address of the BFD control packet.
- For multihop sessions, BFD clients provide the source IP address and BGP is notified of any change to the source IP address of the BFD control packet.
- Multicast or anycast address IP addresses can not be used as source IP addresses.
- BFD establishes only a single BFD session per data protocol path (IPv4 or IPv6) regardless of the number of protocols that want to utilize it.
- Registration is global across all VRFs, even if a neighbor does not support BFD.
- Inactive sessions are created when BFD is not enabled on a remote device that contains the destination IP address. Sessions created are in the Admin Down state and are transmitted at a slower rate than configured values.
- BFD sessions can be established on both primary and secondary IP and IPv6 addresses.
- BFD sessions can be established on link-local IPv6 addresses.
- Changing the BFD parameters does not reset the current BFD session.
- When BFD notifies BGP or OSPF that a session has transitioned from up to down, the protocol does not immediately bring down the session if the holdover timer is configured. The protocol waits until the period of time specified for the holdover timer has expired. If BFD declares a session up before this period of time expires, no action is taken by the protocol.
- If you unconfigure a BFD session that is in the up state, OSPF or BGP tell BFD to delete the session and set the reason as Admin Down. Upon receipt of this notification, BFD deletes the session and communicates this change to the remote BFD peer. The remote BFD neighbor keeps the session in the down state and propagates Remote Admin Down event to the routing protocols.

BFD for Layer 3 protocols on virtual Ethernet interfaces

BFD can be configured for Layer 3 protocols on virtual Ethernet (VE) interfaces.

When configuring BFD for Layer 3 protocols on VE interfaces, one of the physical ports is chosen to set up the session. The physical port used for setting up the BFD session is allocated after Address Resolution Protocol (ARP) is resolved for that neighbor.

If a member of a VE port goes down and a new egress port is identified, the session is moved to another physical port. If a new egress port is not identified, BFD tries to locate a destination IPv4 or IPv6 address. If the new egress port is not learned within the BFD detection time, the session is declared as down.

Configuring BFD on an interface

BFD can be configured on device interfaces. Repeat the steps in this procedure for each interface on which you want to configure BFD sessions.

NOTE

This task does not result in BFD session creation, but configures BFD session parameters for the interface.

1. Enter the **configure terminal** command to access global configuration mode.

```
device# configure terminal
```

2. Enter the **interface** command and specify an interface.

```
device(config)# interface ethernet 0/4
```

3. Enter the **bfd interval** command with the **min-rx** and **multiplier** keywords to configure BFD session parameters on the interface.

```
device(config-if-eth-0/4)# bfd interval 110 min-rx 120 multiplier 15
```

The following example configures BFD on a specific Ethernet interface by setting the baseline BFD session parameters on that interface.

```
device# configure terminal
device(config)# interface ethernet 0/4
device(config-if-eth-0/4)# bfd interval 110 min-rx 120 multiplier 15
```

Disabling BFD on an interface

BFD can be disabled on device interfaces. Repeat the steps in this procedure for each interface onThe following figure which you want to disable BFD sessions.

1. Enter the **configure terminal** command to access global configuration mode.

```
device# configure terminal
```

2. Enter the **interface** command and specify an interface.

```
device(config)# interface ethernet 0/4
```

3. Enter the **bfd shutdown** command to disable BFD on the interface.

```
device(config-if-eth-0/4)# bfd shutdown
```

The following example disables BFD on a specific Ethernet interface.

```
device# configure terminal
device(config)# interface ethernet 0/4
device(config-if-eth-0/4)# bfd shutdown
```

BFD for BGP

BFD support for BGP4 and BGP4+ can be configured so that BGP is a registered protocol with BFD and receives forwarding path detection failure messages from BFD.

BFD is supported for BGP and is disabled by default. BFD rapidly detects faults on links between BGP peers and reports faults to BGP. BFD for BGP is supported for both for single-hop and multihop iBGP and eBGP sessions with either IPv4 or IPv6 neighbors in the default VRF and nondefault VRF instances. BFD behavior is identical for iBGP and eBGP single-hop and multihop sessions, and for IPv4 and IPv6 neighbors.

Consider the following when configuring BFD for BGP:

- Registration is global across all VRFs once BGP sends a registration message to BFD.
- BFD sessions for remote BGP neighbors are not triggered if BFD is not configured on these neighbors. Each neighbor can have its own transmit interval, receive interval, and detect multiplier. If the value is not configured, the configured global value is inherited.
- As soon as a BGP session enters the Established state, BGP requests that BFD start a BFD session.

BFD for BGP session creation and deletion

When BGP requests that BFD start a BFD session, each session has associated BFD session parameters configured. Session parameter values are selected according to a specific hierarchy.

Session parameter values are selected according to the following hierarchy:

- BFD session values configured at neighbor level.
- BFD session values configured at BGP neighbor group level.
- BFD session values configured at global BGP level.
- Default values.

BFD sessions are deleted for a particular source or destination IPv4 or IPv6 address when a BGP session moves from the Established state to another BGP state.

BFD sessions are deleted when a BGP session for a neighbor is unconfigured locally. If you unconfigure a BGP session that is in an Established state and running a BFD session with a neighbor that is up, BGP sends a Cease message to the peer and deletes the BFD session. Upon receipt of this Cease message, the neighbor deletes the BFD session and moves to an Idle state.

Configuring BFD session parameters for BGP

BFD session parameters can be set globally for BGP-enabled interfaces.

1. Enter the **configure terminal** command to access global configuration mode.

```
device# configure terminal
```

2. Enter the **router bgp** command to enable BGP routing.

```
device(config)# router bgp
```

3. Enter the **bfd interval** command with the **min-rx** and **multiplier** keywords to configure BFD session parameters globally for BGP-enabled interfaces.

```
device(config-bgp-router)# bfd interval 110 min-rx 120 multiplier 15
```

NOTE

The **bfd interval** command is used for multihop sessions only. For single-hop sessions, configuration at the interface level is considered.

4. Enter the **bfd holdover-interval** command and specify a value to set the BFD holdover interval globally for BGP-enabled interfaces.

```
device(config-bgp-router)# bfd holdover-interval 15
```

The following example configures BFD session parameters globally for BGP-enabled interfaces.

```
device# configure terminal
device(config)# router bgp
device(config-bgp-router)# bfd interval 110 min-rx 120 multiplier 15
device(config-bgp-router)# bfd holdover-interval 15
```

Enabling BFD sessions for a specified BGP neighbor

BFD sessions can be configured for specified BGP neighbors.

1. Enter the **configure terminal** command to access global configuration mode.

```
device# configure terminal
```

2. Enter the **router bgp** command to enable BGP routing.

```
device(config)# router bgp
```

3. Enter the **neighbor bfd** command, specifying an IP address, to enable BFD sessions for the specified neighbor.

```
device(config-bgp-router)# neighbor 10.10.1.1 bfd
```

4. Enter the **neighbor bfd** command, specifying an IP address, with the **interval**, **min-rx**, and **multiplier** keywords to set the BFD session timer values for the specified BGP neighbor.

```
device(config-bgp-router)# neighbor 10.10.1.1 bfd interval 120 min-rx 140 multiplier 10
```

NOTE

The **neighbor bfd interval** command is used for multihop sessions only. For single-hop sessions, configuration at the interface level is considered.

5. Enter the **neighbor bfd holdover-interval** command, specifying an IP address, and enter a value to set the BFD holdover interval for the specified BGP neighbor.

```
device(config-bgp-router)# neighbor 10.10.1.1 bfd holdover-interval 12
```

The following example enables a BFD session for a BGP neighbor with the IP address 10.10.1.1 and configures the BFD session parameters.

```
device# configure terminal
device(config)# router bgp
device(config-bgp-router)# neighbor 10.10.1.1 bfd
device(config-bgp-router)# neighbor 10.10.1.1 bfd interval 120 min-rx 140 multiplier 10
device(config-bgp-router)# neighbor 10.10.1.1 bfd holdover-interval 12
```

Enabling BFD sessions for a specified BGP neighbor in a nondefault VRF

BFD sessions can be configured for specified BGP neighbors in a nondefault VRF instance.

1. Enter the **configure terminal** command to access global configuration mode.

```
device# configure terminal
```

2. Enter the **router bgp** command to enable BGP routing.

```
device(config)# router bgp
```

3. Enter the **address-family ipv4 unicast** command with the **vrf** keyword, specifying a VRF name, to enter BGP address-family IPv4 unicast VRF configuration mode.

```
device(config-bgp-router)# address-family ipv4 unicast vrf green
```

4. Enter the **neighbor bfd** command, specifying an IP address, to enable BFD sessions for the specified neighbor in a nondefault VRF instance.

```
device(config-bgp-ipv4u-vrf)# neighbor 10.10.1.1 bfd
```

5. Enter the **neighbor bfd** command, specifying an IP address, with the **interval**, **min-rx**, and **multiplier** keywords to set the BFD session timer values for the specified BGP neighbor in a nondefault VRF instance.

```
device(config-bgp-ipv4u-vrf)# neighbor 10.10.1.1 bfd interval 120 min-rx 140 multiplier 10
```

6. Enter the **neighbor bfd holdover-interval** command, specifying an IP address, and enter a value to set the BFD holdover interval for the specified BGP neighbor in a nondefault VRF instance.

```
device(config-bgp-ipv4u-vrf)# neighbor 10.10.1.1 bfd holdover-interval 12
```

The following example enables a BFD session for a BGP neighbor with the IP address 10.10.1.1 and configures the BFD session parameters in VRF instance "green".

```
device# configure terminal
device(config)# router bgp
device(config-bgp-router)# address-family ipv4 unicast vrf green
device(config-bgp-ipv4u-vrf)# neighbor 10.10.1.1 bfd
device(config-bgp-ipv4u-vrf)# neighbor 10.10.1.1 bfd interval 120 min-rx 140 multiplier 10
device(config-bgp-ipv4u-vrf)# neighbor 10.10.1.1 bfd holdover-interval 12
```

Enabling BFD sessions for a specified BGP peer group

BFD sessions can be configured for specified BGP peer groups.

1. Enter the **configure terminal** command to access global configuration mode.

```
device# configure terminal
```

2. Enter the **router bgp** command to enable BGP routing.

```
device(config)# router bgp
```

3. Enter the **neighbor peer-group-name peer-group** command to create a peer group.

```
device(config-bgp-router)# neighbor pg1 peer-group
```

4. Enter the **neighbor bfd** command, specifying a peer group, to enable BFD sessions for the specified peer group.

```
device(config-bgp-router)# neighbor pg1 bfd
```

5. Enter the **neighbor bfd** command, specifying a peer group, with the **interval**, **min-rx**, and **multiplier** keywords to set the BFD session timer values for the specified BGP peer group.

```
device(config-bgp-router)# neighbor pg1 bfd interval 200 min-rx 220 multiplier 25
```

6. Enter the **neighbor bfd holdover-interval** command, specifying a peer group, and enter a value to set the BFD holdover interval for the specified BGP peer group.

```
device(config-bgp-router)# neighbor pg1 bfd holdover-interval 17
```

The following example enables a BFD session for a BGP peer group called "pg1" and configures the BFD session parameters.

```
device# configure terminal
device(config)# router bgp
device(config-bgp-router)# neighbor pg1 peer-group
device(config-bgp-router)# neighbor pg1 bfd
device(config-bgp-router)# neighbor pg1 bfd interval 200 min-rx 220 multiplier 25
device(config-bgp-router)# neighbor pg1 bfd holdover-interval 17
```

BFD for OSPF

BFD support for OSPFv2 and OSPFv3 can be configured so that OSPF is a registered protocol with BFD and receives forwarding path detection failure messages from BFD.

BFD sessions can rapidly detect link faults and notify OSPF so that it quickly responds to network topology changes. BFD is supported for OSPF and is disabled by default.

Consider the following when configuring BFD for OSPF:

- OSPF uses single-hop BFD sessions.
- Virtual links are not supported.
- BFD for OSPF can be enabled in interface subtype configuration mode, OSPF VRF configuration mode, or OSPFv3 configuration mode. BFD must be enabled at both the interface level and global level to enable BFD for OSPF sessions.
- OSPF sends BFD a registration message even if BFD is not enabled on an interface or globally at the router OSPF level.
- Registration is global across all VRFs.
- BFD sessions are maintained across OSPF graceful restart.

- BFD for OSPF does not support authentication for BFD.

BFD for OSPF session creation and deletion

OSPF neighbors are discovered dynamically using the OSPF hello protocol. However, in the case of non-broadcast multiple access (NBMA) and point to multipoint (P2MP), neighbors must be manually configured. Regardless of whether neighbors are discovered dynamically or statically configured, all neighbors are associated with an interface. When BFD is enabled on an interface and at the global level, BFD sessions are created for all OSPF neighbors that are in greater than the 2-way state. A BFD session is created once it progresses to the INIT state.

Each interface can have its own BFD timers. OSPF does not influence the BFD timer value for the session. The configured BFD value, or the default value, is used by the BFD module when creating the session. A single-hop session is created for OSPF neighbors.

NOTE

When BFD for an OSPF session is configured, the normal OSPF hello mechanism is not disabled.

NOTE

OSPF neighbor sessions do not flap when BFD is enabled or disabled on the interface where the OSPF session is associated.

NOTE

OSPF assumes full connectivity between all systems on multi-access media such as LANs. If BFD is running on only a subset of systems on such a network, the assumptions of the control protocol may be violated, with unpredictable results.

OSPF BFD session deletion can happen in the following instances:

- If an OSPF neighbor session moves to a state below 2-way, OSPF triggers a BFD session deletion setting the reason as Path Down. When BFD receives this notification, it deletes the corresponding session. The remote BFD neighbor detects this as a detection timer expiry and propagates this session down to OSPF to terminate the session.
- If OSPF is disabled on an interface, all BFD sessions associated with each neighbor are deleted.
- If BFD is administratively disabled on an interface, BFD reports this event as a port change notification to OSPF. Upon receipt of this notification, a BFD session deletion for each neighbor is sent and BFD removes these sessions if no other client is using the same sessions. BFD communicates this change to the remote peer. When the remote BFD peer receives this Remote Admin Down event, it propagates this event to the OSPF protocol. OSPF does not provide any action for this event.

Enabling BFD on a specified OSPFv2-enabled interface

BFD sessions can be configured on one or more OSPFv2-enabled interfaces.

BFD sessions are initiated on specified OSPFv2-enabled interfaces only if BFD is enabled globally using the **bfd** command in OSPF VRF configuration mode.

1. Enter the **configure terminal** command to access global configuration mode.

```
device# configure terminal
```

2. Enter the **interface** command and specify an interface.

```
device(config)# interface ethernet 0/4
```

3. Enter the **ip ospf bfd** command to enable BFD on the specified interface.

```
device(config-if-eth-0/4)# ip ospf bfd
```

The following example enables BFD on a specified OSPFv2-enabled Ethernet interface.

```
device# configure terminal
device(config)# interface ethernet 0/4
device(config-if-eth-0/4)# ip ospf bfd
```

Configuring BFD for OSPFv2 globally

BFD for OSPFv2 can be configured globally on interfaces where BFD has been configured.

BFD must be configured using the **ip ospf bfd** command on each OSPFv2 interface to initiate BFD sessions.

1. Enter the **configure terminal** command to access global configuration mode.

```
device# configure terminal
```

2. Enter the **router ospf** command to enter OSPF router configuration mode and enable OSPFv2 on the device.

```
device(config)# router ospf
```

3. Enter the **bfd** command to enable BFD globally.

```
device(config-router-ospf-vrf-default-vrf)# bfd
```

4. Enter the **bfd holdover-interval** command to set the BFD holdover interval.

```
device(config-router-ospf-vrf-default-vrf)# bfd holdover-interval 12
```

The following example enables BFD globally and sets the BFD holdover interval to 12.

```
device# configure terminal
device(config)# router ospf
device(config-router-ospf-vrf-default-vrf)# bfd
device(config-router-ospf-vrf-default-vrf)# bfd holdover-interval 12
```

Configuring BFD for OSPFv2 globally in a nondefault VRF instance

BFD for OSPFv2 can be configured globally on interfaces where BFD has been configured in nondefault VRF instances.

BFD must be configured using the **ip ospf bfd** command on each OSPFv2 interface to initiate BFD sessions.

1. Enter the **configure terminal** command to access global configuration mode.

```
device# configure terminal
```

2. Enter the **router ospf** command and specify a VRF name to enable OSPFv2 in a nondefault VRF instance.

```
device(config)# router ospf vrf red
```

3. Enter the **bfd** command to enable BFD.

```
device(config-router-ospf-vrf-red)# bfd
```

4. Enter the **bfd holdover-interval** command to set the BFD holdover interval.

```
device(config-router-ospf-vrf-red)# bfd holdover-interval 12
```

The following example enables BFD globally and sets the BFD holdover interval to 12 for VRF “red”.

```
device# configure terminal
device(config)# router ospf vrf red
device(config-router-ospf-vrf-red)# bfd
device(config-router-ospf-vrf-red)# bfd holdover-interval 12
```

Enabling BFD on a specified OSPFv3-enabled interface

BFD sessions can be configured on one or more OSPFv3-enabled interfaces.

BFD sessions are initiated on specified OSPFv3-enabled interfaces only if BFD is enabled globally using the **bfd** command in OSPFv3 VRF configuration mode.

1. Enter the **configure terminal** command to access global configuration mode.

```
device# configure terminal
```

2. Enter the **interface** command and specify an interface.

```
device(config)# interface ve 24
```

3. Enter the **ipv6 ospf bfd** command to enable BFD on the specified OSPFv3-enabled interface.

```
device(config-if-Ve-24)# ipv6 ospf bfd
```

The following example enables BFD on an OSPFv3-enabled virtual Ethernet (VE) interface.

```
device# configure terminal
device(config)# interface ve 24
device(config-if-Ve-24)# ipv6 ospf bfd
```

Configuring BFD for OSPFv3 globally

BFD for OSPFv3 can be configured globally on interfaces where BFD has been configured.

BFD must be configured using the **ipv6 ospf bfd** command on each OSPFv3 interface to initiate BFD sessions.

1. Enter the **configure terminal** command to access global configuration mode.

```
device# configure terminal
```

2. Enter the **ipv6 router ospf** command to enter OSPFv3 router configuration mode and enable OSPFv3.

```
device(config)# ipv6 router ospf
```

3. Enter the **bfd** command to enable BFD globally.

```
device(config-ipv6-router-ospf-vrf-default-vrf)# bfd
```

4. Enter the **bfd holdover-interval** command to set the BFD holdover interval.

```
device(config-ipv6-router-ospf-vrf-default-vrf)# bfd holdover-interval 20
```

The following example enables BFD and sets the BFD holdover interval to 20.

```
device# configure terminal
device(config)# ipv6 router ospf
device(config-ipv6-router-ospf-vrf-default-vrf)# bfd
device(config-ipv6-router-ospf-vrf-default-vrf)# bfd holdover-interval 20
```

Configuring BFD for OSPFv3 globally in a nondefault VRF instance

BFD for OSPFv3 can be configured globally on interfaces where BFD has been configured in nondefault VRF instances.

BFD must be configured using the **ipv6 ospf bfd** command on each OSPFv3 interface to initiate BFD sessions.

1. Enter the **configure terminal** command to access global configuration mode.

```
device# configure terminal
```

2. Enter the **ipv6 router ospf** command and specify a VRF name to enable OSPFv3 in a nondefault VRF instance.

```
device(config)# ipv6 router ospf vrf orange
```

3. Enter the **bfd** command to enable BFD.

```
device(config-ipv6-router-ospf-vrf-orange)# bfd
```

4. Enter the **bfd holdover-interval** command to set the BFD holdover interval.

```
device(config-ipv6-router-ospf-vrf-orange)# bfd holdover-interval 22
```

The following example enables BFD and sets the BFD holdover interval to 22 for VRF "orange".

```
device# configure terminal
device(config)# ipv6 router ospf vrf orange
device(config-ipv6-router-ospf-vrf-orange)# bfd
device(config-ipv6-router-ospf-vrf-orange)# bfd holdover-interval 22
```

BFD for static routes

Unlike dynamic routing protocols, such as OSPF and BGP, static routing has no method of peer discovery and fault detection. BFD for IPv4 and IPv6 static routes provides rapid detection of failure in the bidirectional forwarding path between BFD peers.

BFD for static routes allows you to detect failures that impact the forwarding path of a static route. This feature supports both single-hop and multihop BFD static routes for both IPv4 and IPv6. Unless the BFD session is up, the gateway for the static route is considered unreachable, and the affected routes are not installed in the routing table. BFD can remove the associated static route from the routing table if the next-hop becomes unreachable indicating that the BFD session has gone down.

Static routes and BFD neighbors are configured separately. A static route is automatically associated with a static BFD neighbor if the static route's next-hop exactly matches the neighbor address of the static BFD neighbor and BFD monitoring is enabled for the static route.

When a static BFD neighbor is configured, BFD asks the routing table manager if there is a route to the BFD neighbor. If a route exists, and if the next-hop is directly connected, BFD initiates a single-hop session. If the next-hop is not directly connected, BFD establishes a multihop session.

When a BFD session goes down because the BFD neighbor is no longer reachable, static routes monitored by BFD are removed from the routing table manager. The removed routes can be added back if the BFD neighbor becomes reachable again. Single-hop BFD sessions use the BFD timeout values configured on the outgoing interface. Timeout values for multihop BFD sessions are specified along with each BFD neighbor. Multiple static routes going to the same BFD neighbor use the same BFD session and timeout values.

BFD considerations and limitations for static routes

There are a number of things to consider when configuring BFD for IPv4 and IPv6 static routes.

- BFD is not supported on interface-based static routes because BFD requires that the next-hop address matches the address of the BFD neighbor.
- Only one static route BFD session for a neighbor is created at any instance. This is always based on the best path for the neighbor.
- Static BFD for a multihop BFD neighbor reachable by way of an Equal-Cost Multi-Path (ECMP) is not supported. Static BFD must be configured explicitly for each next-hop corresponding to each path.
- When an interface goes down, multihop IPv4 static route sessions are not deleted. Multihop IPv6 static route sessions are deleted.
- BFD for static routes is supported in both Local-only mode and Distributed mode.
- BFD sessions can be single-hop or multihop sessions.
- A BFD multihop session is supported for a next-hop resolved through OSPF or BGP.
- If a BFD session goes down and the BFD neighbor had Layer 3 direct connectivity, associated static routes are removed from the routing table so that data packets can use the available alternate path.
- If a BFD neighbor is not directly connected and a BFD session goes down, associated static routes are removed only if an alternate path to the neighbor exists.
- BFD for static routes is supported in both default and nondefault VRFs.
- BFD for IPv6 static routes is supported in both associated and unassociated mode.
- BFD for Link-local IPv6 addresses is supported.
- When configuring BFD for Link-local IPv6 static routes, the source IPv6 address must be link-local and an interface must be provided.

BFD for static routes configuration

Single-hop BFD IPv4 static route sessions use the timer values configured for the outgoing interface to the directly connected neighbors. Multihop BFD IPv4 static route sessions use the timer values configured using the **ip route static bfd** and **ip route static bfd holdover-interval** commands. If the timer values configured conflict with the timer values set for BGP for the same next-hop, BFD uses the smaller value to meet the more stringent requirement.

Single-hop BFD IPv6 static route sessions use the timer values configured for the outgoing interface to the directly connected neighbors. Multihop BFD IPv6 static route sessions use the timer values configured using the **ipv6 route static bfd** and **ipv6 route static bfd holdover-interval** commands. If the timer values configured conflict with the timer values set for BGP for the same next-hop, BFD uses the smaller value to meet the more stringent requirement.

If you remove a static BFD session, the corresponding session is removed by BFD without removing static routes from the routing table and ongoing traffic is not disrupted. If a BFD session goes down because a BFD neighbor is no longer reachable, all associated static routes are removed from the routing table. Existing traffic on these static routes is interrupted.

The following figure shows a single-hop static BFD session. A1 has a static route to 10.168.20.0/24 with the next-hop as 10.20.20.2. A2 has a static route to 10.168.10.0/24 with the next-hop as 10.20.20.1. A switch is connected between the routers. BFD can be configured to monitor next-hop 10.20.20.2 on A1 and 10.20.20.1 on A2.

FIGURE 13 Single-hop static BFD session

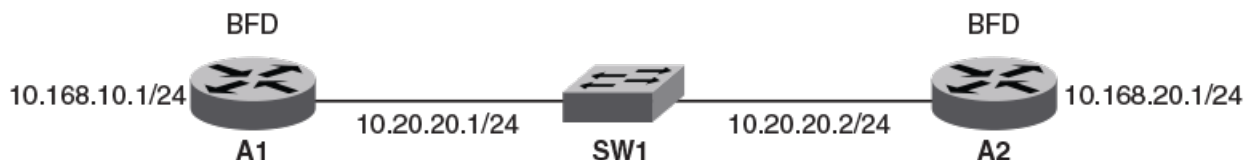

The following figure shows a multihop static BFD session. Static routes are configured on A1 to reach the 10.1.1.0/24 subnet by way of 10.168.20.1. 10.168.20.1 is reachable by way of the intermediate routers IR1 and IR2. A static route is configured on A2 to reach the 10.1.1.0/24 subnet by way of 10.168.10.1. This next-hop is reachable in turn by way of the intermediate routers IR1 and IR2. If one BFD session goes down, the corresponding route is removed from the routing table and the data packets take another path.

FIGURE 14 Multihop ECMP static BFD session

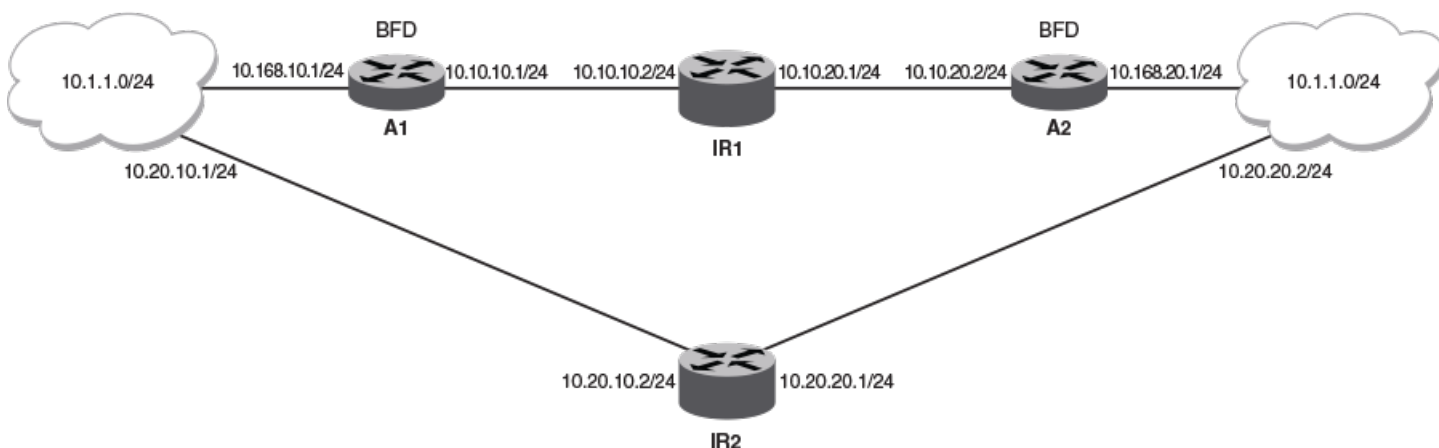
**NOTE**

When configuring BFD for static routes, static routes are already installed in the routing table and traffic is running on those static routes. When you configure BFD on these static routes, a similar BFD configuration also occurs on BFD neighbors. If BFD session creation fails or a BFD session does not come up, associated static routes are not removed from the routing table; therefore ongoing traffic on these static routes is not interrupted. A BFD session may not be established if a neighbor is busy or if the maximum number of sessions has been reached on the neighbor. Ongoing traffic on installed static routes is not interrupted.

Configuring BFD on an IP static route

BFD can be configured globally on IP static routes. Repeat the steps in this procedure on each BFD neighbor.

1. Enter the **configure terminal** command to access global configuration mode.

```
device# configure terminal
```

2. Enter the **ip route static bfd** command, specifying a source and destination IP address, and use the **interval**, **min-rx**, and **multiplier** keywords to configure BFD session parameters on an IP static route.

```
device(config)# ip route static bfd 10.0.2.1 10.1.1.1 interval 500 min-rx 500 multiplier 5
```

3. Enter the **ip route static bfd holdover-interval** command and specify an interval to set the BFD holdover interval globally for IP static routes.

```
device(config)# ip route static bfd holdover-interval 15
```

The following example configures BFD session parameters on an IP static route where the destination IP address is 10.0.2.1 and the source IP address is 10.1.1.1. The BFD holdover interval is set globally to 15 for IP static routes.

```
device# configure terminal
device(config)# ip route static bfd 10.0.2.1 10.1.1.1 interval 500 min-rx 500 multiplier 5
device(config)# ip route static bfd holdover-interval 15
```

Configuring BFD on an IP static route in a nondefault VRF instance

BFD can be configured on IP static routes in a nondefault VRF instance. Repeat the steps in this procedure on each BFD neighbor.

1. Enter the **configure terminal** command to access global configuration mode.

```
device# configure terminal
```

2. Enter the **vrf** command and specify a VRF name to enter Virtual Routing and Forwarding (VRF) configuration mode.

```
device(config)# vrf green
```

3. Enter the **address-family ipv4 unicast** command to enter IPv4 address-family unicast configuration mode..

```
device(config-vrf-green)# address-family ipv4 unicast
```

4. Enter the **ip route static bfd** command, specifying a source and destination IP address, and use the **interval**, **min-rx**, and **multiplier** keywords to configure BFD session parameters on an IP static route in a nondefault VRF instance.

```
device(vrf-ipv4-unicast)# ip route static bfd 10.0.0.1 10.1.1.2 interval 500 min-rx 500 multiplier 5
```

The following example configures BFD session parameters on an IP static route in a nondefault VRF instance, where the destination IP address is 10.0.0.1 and the source IP address is 10.1.1.2.

```
device# configure terminal
device(config)# vrf green
device(config-vrf-green)# address-family ipv4 unicast
device(vrf-ipv4-unicast)# ip route static bfd 10.0.0.1 10.1.1.2 interval 500 min-rx 500 multiplier 5
```

Configuring BFD on an IPv6 static route

BFD can be configured globally on IPv6 static routes. Repeat the steps in this procedure on each BFD neighbor.

1. Enter the **configure terminal** command to access global configuration mode.

```
device# configure terminal
```

2. Enter the **ipv6 route static bfd** command, specifying a source and destination IPv6 address and an interface type, and use the **interval**, **min-rx**, and **multiplier** keywords to configure BFD session parameters on an IPv6 static route.

```
device(config)# ipv6 route static bfd fe80::a fe80::b ve 20 interval 100 min-rx 100 multiplier 10
```

3. Enter the **ipv6 route static bfd holdover-interval** command and specify an interval to set the BFD holdover interval globally for IPv6 static routes.

```
device(config)# ipv6 route static bfd holdover-interval 25
```

The following example configures BFD session parameters on an IPv6 static route where the destination IPv6 address is fe80::a and the source IPv6 address is fe80::b. A VE interface is specified and the BFD holdover interval is set globally to 25 for IPv6 static routes.

```
device# configure terminal
device(config)# ipv6 route static bfd fe80::a fe80::b ve 20 interval 100 min-rx 100 multiplier 10
device(config)# ipv6 route static bfd holdover-interval 25
```

Configuring BFD on an IPv6 static route in a nondefault VRF instance

BFD can be configured on IPv6 static routes in a nondefault VRF instance. Repeat the steps in this procedure on each BFD neighbor.

1. Enter the **configure terminal** command to access global configuration mode.

```
device# configure terminal
```

2. Enter the **vrf** command and specify a VRF name to enter Virtual Routing and Forwarding (VRF) configuration mode.

```
device(config)# vrf blue
```

3. Enter the **address-family ipv6 unicast** command to enter IPv6 address-family unicast configuration mode..

```
device(config-vrf-blue)# address-family ipv6 unicast
```

4. Enter the **ipv6 route static bfd** command, specifying a source and destination IPv6 address and an interface type, and use the **interval**, **min-rx**, and **multiplier** keywords to configure BFD session parameters on an IPv6 static route in a nondefault VRF instance.

```
device(vrf-ipv6-unicast)# ipv6 route static bfd fe70::a fe60::b ve 10 interval 1000 min-rx 2000
multiplier 20
```

The following example configures BFD session parameters on an IPv6 static route in a nondefault VRF instance, where the destination IPv6 address is fe80::a and the source IPv6 address is fe80::b. A VE interface is specified.

```
device# configure terminal
device(config)# vrf blue
device(config-vrf-blue)# address-family ipv6 unicast
device(vrf-ipv6-unicast)# ipv6 route static bfd fe70::a fe60::b ve 10 interval 1000 min-rx 2000 multiplier
20
```

Displaying BFD information

Various **show** commands verify information about BFD configurations.

Use one or more of the following commands to verify BFD information. The commands do not have to be entered in this order.

1. Enter the **show bfd** command.

```
device# show bfd

BFD State: ENABLED, Version: 1
Supported Protocols: bgp, static-ip, tunnel, ospf, ospf6
All Sessions: Current: 72 Max Allowed: 250 Max Exceeded Count: 0

Port          MinTx      MinRx      Mult Sessions
====          =====
Eth 0/51      500        500        3 1
Eth 0/54      500        500        3 1
Ve 3001       500        500        3 2
Ve 3009       500        500        3 2
Ve 3011       500        500        3 2
```

This example output displays BFD information.

2. Enter the **show bfd neighbors** command.

```
device# show bfd neighbors

OurAddr          NeighAddr          State      Int
=====          =====
118.113.0.0      118.113.0.1       DOWN      Eth 0/54
113.113.113.113 118.118.118.118   UP         Lo 1
```

This example output displays BFD neighbor information for the default VRF.

3. Enter the **show bfd neighbors application** command with the **ospf** and **details** keywords.

```
device# show bfd neighbors application ospf details

OurAddr          NeighAddr          State      Int
=====          =====
31.81.181.3      31.81.181.8       UP         Ve 3181

Local   State: UP          Diag: 0          Demand mode: 0   Poll: 0
Received State: UP   Diag: 0          Demand mode: 0   Poll: 0   Final: 0
Local   MinTxInt (ms): 500  MinRxInt (ms): 500  Multiplier: 3
Received MinTxInt (ms): 500  MinRxInt (ms): 500  Multiplier: 3
Rx Count: 127097          Tx Count: 142393
LD/RD:          3/81          Heard from Remote: Y
Current Registered Protocols: ospf
Uptime: 0 day 15 hour 53 min 12 sec 939 msec
```

This example displays detailed information about neighbor OSPF sessions.

4. Enter the **show bfd neighbors dest-ip** command with the **details** keyword.

```
device# show bfd neighbors dest-ip 118.118.118.118 details

OurAddr          NeighAddr          State      Int
=====          =====          =====
113.113.113.113  118.118.118.118   UP         Lo 1

Local   State: UP           Diag: 0           Demand mode: 0   Poll: 0
Received State: UP     Diag: 0           Demand mode: 0   Poll: 0   Final: 0
Local   MinTxInt(ms): 500   MinRxInt(ms): 500 Multiplier: 3
Received MinTxInt(ms): 500 MinRxInt(ms): 500 Multiplier: 3
Rx Count: 941487       Tx Count: 1016042
LD/RD:      2/69       Heard from Remote: Y
Current Registered Protocols: static-ip
Uptime: 0 day 15 hour 54 min 20 sec 683 msec
```

This example shows detailed neighbor information about a destination device.

5. Enter the **show bfd neighbors interface** command with the **ve** and **details** keywords.

```
device# show bfd neighbors interface Ve 3009 details

OurAddr          NeighAddr          State      Int
=====          =====          =====
30.9.1.3         30.9.1.8          UP         Ve 3009

Local   State: UP           Diag: 0           Demand mode: 0   Poll: 0
Received State: UP     Diag: 0           Demand mode: 0   Poll: 0   Final: 1
Local   MinTxInt(ms): 500   MinRxInt(ms): 500 Multiplier: 3
Received MinTxInt(ms): 500 MinRxInt(ms): 500 Multiplier: 3
Rx Count: 147322       Tx Count: 142636
LD/RD:      6/84       Heard from Remote: Y
Current Registered Protocols: bgp
Uptime: 0 day 15 hour 54 min 52 sec 989 msec
```

This example shows detailed neighbor information about a specified VE interface.

6. Enter the **show bfd neighbors vrf** command and specify a VRF.

```
device# show bfd neighbors vrf v3001

OurAddr          NeighAddr          State      Int
=====          =====          =====
30.9.1.3         30.9.1.8          UP         Ve 3009
30.1.1.3         30.1.1.8          UP         Ve 3001
fdcd:3001:3009:1::113 fdcd:3001:3009:1::118 UP         Ve 3009
fe80::629c:9fff:fe5b:601 fe80::629c:9fff:fe87:3601 UP         Ve 3001
```

This example shows BFD neighbor information for the default VRF.

7. Enter the **show ip ospf** command.

```

device# show ip ospf

OSPF Version                Version 2
Router Id                   113.113.113.113
ASBR Status                 No
ABR Status                  No          (0)
Redistribute Ext Routes from
Initial SPF schedule delay  0          (msecs)
Minimum hold time for SPF  0          (msecs)
Maximum hold time for SPF  0          (msecs)
External LSA Counter       0
External LSA Checksum Sum  0
Originate New LSA Counter  2
Rx New LSA Counter         1
External LSA Limit         14913080
Administrative Distance
- External Routes:        110
- Intra Area Routes:     110
- Inter Area Routes:     110
- Route Map:              0
  - Route Map Name:
  - Source IP:
  - Source IP Mask:
Database Overflow Interval  0
Database Overflow State :  NOT OVERFLOWED
RFC 1583 Compatibility :   Disabled
NSSA Translator:          Enabled

None

```

This output displays OSPF information including configured BFD information.

8. Enter the **show ip ospf** command with the **extensive** keyword.

```

device# show ip ospf neighbor extensive

Number of Neighbors is 1, in FULL state 1

Port      Address      Pri State      Neigh Address  Neigh ID      Ev      Opt      Cnt
Ve 3011   30.11.11.3   1  FULL/DR      30.11.11.8    30.11.11.8   5      --O-----E- 0
Neighbor is known for 0d:15h:57m:39s and up for 0d:15h:57m:39s
Neighbor BFD State:UP      , HoldoverInterval(sec):Configured:0 Current:0

```

This output displays detailed information about all neighbors including configured BFD information.

9. Enter the **show ipv6 ospf neighbor detail** command.

```

device# show ipv6 ospf neighbor detail

Total number of neighbors in all states: 1
Number of neighbors in state Full      : 1

RouterID      Pri State  DR          BDR          Interface    [State]
30.11.11.8    1 Full     30.11.11.8  30.11.11.3  Ve 3011     [BDR]
Option: 00-00-00  QCount: 0  Timer: 725
BFD State: UP, BFD HoldoverInterval(sec):Configured: 0 Current: 0

```

This output displays detailed OSPF neighbor information including configured BFD information.

BGP4

• BGP4 overview.....	108
• BGP4 peering.....	108
• BGP4 message types.....	108
• BGP4 attributes.....	111
• BGP4 best path selection algorithm.....	111
• Device ID.....	112
• BGP global mode	112
• Configuring a local AS number.....	113
• IPv4 unicast address family.....	113
• Neighbor configuration.....	114
• Peer groups.....	115
• Advertising the default BGP4 route.....	116
• Four-byte AS numbers.....	117
• Cooperative BGP4 route filtering.....	118
• BGP4 parameters.....	119
• Route redistribution.....	120
• Advertised networks.....	120
• Importing routes into BGP4.....	121
• Static networks.....	121
• Route reflection.....	122
• Route flap dampening.....	123
• Aggregating routes advertised to BGP neighbors.....	124
• Advertising the default BGP4 route.....	124
• Advertising the default BGP4 route to a specific neighbor.....	125
• Multipath load sharing.....	125
• Specifying the weight added to received routes.....	126
• Using the IPv4 default route as a valid next hop for a BGP4 route.....	126
• Adjusting defaults to improve routing performance.....	127
• Next-hop recursion.....	127
• Route filtering.....	128
• Timers.....	128
• Enabling BGP4 in a non-default VRF.....	128
• BGP4 outbound route filtering.....	129
• BGP4 confederations.....	131
• Auto shutdown of BGP neighbors on initial configuration.....	132
• Generalized TTL Security Mechanism support.....	133
• Disabling the BGP AS_PATH check function.....	134
• Using route maps.....	135
• Matching on an AS-path.....	136
• Matching on a community ACL.....	136
• Matching on a destination network.....	137
• Matching on a BGP4 static network.....	137
• Matching on a next-hop device.....	138
• Matching on an interface.....	139
• Using route-map continue statements.....	139
• Route-map continue statement for BGP4 routes.....	140
• Using a route map to configure dampening.....	140
• Clearing diagnostic buffers.....	141
• Displaying BGP4 statistics.....	142

- [Displaying BGP4 neighbor statistics.....](#)145
- [Clearing BGP4 dampened paths.....](#) 149

BGP4 overview

Border Gateway Protocol version 4 (BGP4) is an exterior gateway protocol that performs inter-autonomous system (AS) or inter-domain routing. It peers to other BGP-speaking systems over TCP to exchange network reachability and routing information. BGP primarily performs two types of routing: inter-AS routing, and intra-AS routing. BGP peers belonging to different autonomous systems use the inter-AS routing, referred as Exterior BGP (eBGP). On the other hand, within an AS BGP can be used to maintain a consistent view of network topology, to provide optimal routing, or to scale the network.

BGP is a path vector protocol and implements this scheme on large scales by treating each AS as a single point on the path to any given destination. For each route (destination), BGP maintains the AS path and uses this to detect and prevent loops between autonomous systems.

Devices within an AS can use different Interior Gateway Protocols (IGPs) such as OSPF to communicate with one another. However, for devices in different autonomous systems to communicate, they need to use an EGP. BGP4 is the standard EGP used by Internet devices and therefore is the EGP implemented on Brocade devices.

BGP4 peering

Unlike OSPF or other IGP protocols, BGP4 does not have neighbor detection capability. BGP4 neighbors (or peers) must be configured manually. A device configured to run BGP4 is called a BGP "speaker." A BGP speaker connects to another speaker (either in the same or a different AS) by using a TCP connection to port 179 (the well-known BGP port), to exchange the routing information. The TCP connection is maintained throughout the peering session. While the connection between BGP peers is alive, two peers communicate by means of the following types of messages:

- OPEN
- UPDATE
- KEEPALIVE
- NOTIFICATION
- ROUTE REFRESH

BGP4 peering can be internal or external, depending on whether the two BGP peers belong to the same AS or different ASs. A BGP4 session between peers within a single AS is referred to as an Interior BGP (iBGP) session; a session between peers belonging to different ASs is referred to as an Exterior BGP (eBGP) session.

In order to establish a TCP connection between two iBGP peers, the IP reachability should be established either by means of the underlying IGP protocol (e.g. OSPF) or by means of static routes. When routes are advertised within iBGP peers, the following primary actions are taken in contrast to eBGP peering:

- Routes learned from an iBGP peer are not usually advertised to other iBGP peers, in order to prevent loops within an AS.
- Path attributes are not usually changed, in order to maintain the best path selection at other nodes within an AS.
- The AS path and next hop are not normally changed.

BGP4 message types

All BGP4 messages use a common packet header, with the following byte lengths:

Marker	Length	Type	Data
16	2	1	variable

NOTE

All values in the following tables are in bytes.

Type can be OPEN, UPDATE, NOTIFICATION, KEEPALIVE, or ROUTE-REFRESH, as described below.

OPEN message

After establishing TCP connection, BGP peers exchange OPEN message to identify each other.

Version	Autonomous System	Hold-Time	BGP Identifier	Optional Parameter Len	Optional Parameters
1	2 or 4	2	4	1	4

Version

Only BGP4 version 4 is supported.

Autonomous System

Both 2-byte and 4-byte AS numbers are supported.

KEEPALIVE and HOLDTIME messages

A BGP **timer** command specifies both **keep-alive** and **hold-time** operands that manage the intervals for BGP KEEPALIVE and HOLDTIME messages. The keep alive time specifies how frequently the device sends KEEPALIVE messages to its BGP4 neighbors. The hold time specifies how long the device waits for a KEEPALIVE or UPDATE message from a neighbor before concluding that the neighbor is dead. When two neighbors have different hold-time values, the lowest value is used. A hold-time value of 0 means "always consider neighbor to be active."

BGP Identifier

Indicates the router (or device) ID of the sender. When router-id is not configured, device-id is taken from the loopback interface. Otherwise, the lowest IP address in the system is used.

Parameter List

Optional list of additional parameters used in peer negotiation.

UPDATE message

The UPDATE message is used to advertise new routes, withdraw previously advertised routes, or both.

WithdrawnRoutesLength	WithdrawnRoutes	Total PathAttributes Len	Path Attributes	NLRI
2	variable	2	variable	variable

Withdrawn Routes Length

Indicates the length of next (withdrawn routes) field. It can be 0.

Withdrawn Routes

Contains list of routes (or IP-prefix/Length) to indicate routes being withdrawn.

Total Path Attribute Len

Indicates length of next (path attributes) field. It can be 0.

Path Attributes

Indicates characteristics of the advertised path. Possible attributes: Origin, AS Path, Next Hop, MED (Multi-Exit Discriminator), Local Preference, Atomic Aggregate, Aggregator, Community, extended-Communities.

NLRI

Network Layer Reachability Information — the set of destinations whose addresses are represented by one prefix. This field contains a list of IP address prefixes for the advertised routes.

NOTIFICATION message

In case of an error that causes the TCP connection to close, the closing peer sends a notification message to indicate the type of error.

Error Code	ErrorSubcode	Error Data
1	1	variable

Error Code

Indicates the type of error, which can be one of following:

- Message header error
- Open message error
- Update message error
- Hold timer expired
- Finite state-machine error
- Cease (voluntarily)

Error Subcode

Provides specific information about the error reported.

Error Data

Contains data based on error code and subcode.

KEEPALIVE message

Because BGP does not regularly exchanges route updates to maintain a session, KEEPALIVE messages are sent to keep the session alive. A KEEPALIVE message contains just the BGP header without data field. Default KEEPALIVE time is 60 seconds and is configurable.

REFRESH message

A REFRESH message is sent to a neighbor requesting that the neighbor resend the route updates. This is useful when the inbound policy has been changed.

BGP4 attributes

BGP4 attributes are passed in UPDATE messages to describe the characteristics of a BGP path by the advertising device. At a high level, there are only two types of attributes: well-known and optional. All of the well-known attributes, as described in RFC 4271, are supported.

BGP4 best path selection algorithm

The BGP decision process is applied to the routes contained in the Routing Information Base, Incoming (RIB-In) which contains routes learned from inbound update messages. The output of the decision process is the set of routes that will be advertised to BGP speakers in local or remote autonomous systems and are stored in the Adjacency RIB, Outgoing (RIB-Out).

When multiple paths for the same route prefix are known to a BGP4 device, the device uses the following algorithm to weigh the paths and determine the optimal path for the route. The optimal path depends on various parameters, which can be modified.

1. Verify that the next hop can be resolved by means of Interior Gateway Protocol (IGP).
2. Use the path with the largest weight.
3. If the weights are the same, prefer the path with the largest local preference.
4. Prefer the route that was self-originated locally.
5. If the local preferences are the same, prefer the path with the shortest AS-path. An AS-SET counts as 1. A confederation path length, if present, is not counted as part of the path length.

The **as-path ignore** command disables the comparison of the AS path lengths of otherwise equal paths.

NOTE

This step can be skipped if the **as-path-ignore** command is configured.

6. If the AS-path lengths are the same, prefer the path with the lowest origin type. From low to high, route origin types are valued as follows:
 - IGP is lowest.
 - EGP is higher than IGP but lower than INCOMPLETE.
 - INCOMPLETE is highest.
7. If the paths have the same origin type, prefer the path with the lowest MED.

The device compares the MEDs of two otherwise equivalent paths if and only if the routes were learned from the same neighboring AS. This behavior is called deterministic MED. Deterministic MED is always enabled and cannot be disabled.

To ensure that the MEDs are always compared, regardless of the AS information in the paths, the **always-compare-med** command can be used. This option is disabled by default.

The **med-missing-as-worst** command can be used to make the device regard a BGP4 route with a missing MED attribute as the least-favorable path when the MEDs of the route paths are compared.

MED comparison is not performed for internal routes that originate within the local AS or confederation, unless the **compare-med-empty-aspath** command is configured.

8. Prefer paths in the following order:
 - Routes received through eBGP from a BGP4 neighbor outside of the confederation
 - Routes received through eBGP from a BGP4 device within the confederation *or* routes received through IBGP.
9. If all the comparisons above are equal, prefer the route with the lowest IGP metric to the BGP4 next hop. This is the closest internal path inside the AS to reach the destination.

10. If the internal paths also are the same and BGP4 load sharing is enabled, load-share among the paths. Otherwise go to Step 11.

NOTE

For eBGP routes, load sharing applies only when the paths are from neighbors within the same remote AS. eBGP paths from neighbors in different ASs are not compared, unless multipath multi-as is enabled.

11. If **compare-routerid** is enabled, prefer the path that comes from the BGP4 device with the lowest device ID. If a path contains originator ID attributes, then the originator ID is substituted for the router ID in the decision.
12. Prefer the path with the minimum cluster-list length.
13. Prefer the route that comes from the lowest BGP4 neighbor address.

Device ID

BGP automatically calculates the device identifier it uses to specify the origin in routes it advertises. If a router-id configuration is already present in the system, then device-id is used as the router-id. Otherwise, the device first checks for a loopback interface, and the IP address configured on that interface is chosen as the device-id. However, if a loopback interface is not configured, the device-id is chosen from lowest-numbered IP interface address configured on the device. Once device-id is chosen, the device identifier is not calculated unless the IP address configured above is deleted.

BGP global mode

After using the **router bgp** command you enter into BGP global configuration mode.

Configurations that are not specific to address-family configuration are available in the BGP global configuration mode:

```
device(config-bgp-router)# ?
Possible completions:
  address-family          Enter Address Family command mode
  always-compare-med      Allow comparing MED from different neighbors
  as-path-ignore          Ignore AS_PATH length for best route selection
  auto-shutdown-new-neighbors Auto shutdown new neighbor
  bfd                     Set BFD global parameters for BGP
  capability              Set capability
  cluster-id              Configure Route-Reflector Cluster-ID
  compare-med-empty-aspah Allow comparing MED from different neighbors
                          even with empty as-path attribute
  compare-routerid        Compare router-id for identical BGP paths
  confederation           Configure AS confederation parameters
  default-local-preference Configure default local preference value
  distance                Define an administrative distance
  enforce-first-as        Enforce the first AS for EBGp routes
  fast-external-fallover  Reset session if link to EBGp peer goes down
  install-igp-cost        Install igp cost to nexthop instead of MED
                          value as BGP route cost
  local-as                Configure local AS number
  log-dampening-debug     Log dampening debug messages
  maxas-limit             Impose limit on number of ASes in AS-PATH attribute
  med-missing-as-worst    Consider routes missing MED attribute as least desirable
  neighbor                Specify a neighbor router
  timers                  Adjust routing timers
```

Configuring a local AS number

The local AS number (ASN) identifies the AS in which the BGP device resides. The following task configures the local ASN in which the device resides.

NOTE

Use well-known private ASNs in the range from 64512 through 65535 if the AS number of the organization is not known.

1. Enter the **configure terminal** command to access global configuration mode.

```
device# configure terminal
```

2. Enter the **router bgp** command to enable BGP routing.

```
device(config)# router bgp
```

3. Enter the **local-as** command to configure the autonomous system number (ASN) in which your device resides.

```
device(config-bgp-router)# local-as 1000
```

The following example configures the local ASN for a device.

```
device# configure terminal
device(config)# router bgp
device(config-bgp-router)# local-as 1000
```

IPv4 unicast address family

The IPv4 unicast address family configuration level provides access to commands that allow you to configure BGP4 unicast routes. The commands that you enter at this level apply only to the IPv4 unicast address family.

BGP4 supports the IPv4 address family configuration level. This configuration is applied in the IPv4 address-family unicast submode of BGP.

```
device(config-bgp-router)# address-family ipv4 unicast
device(config-bgp-ipv4u)#
```

The commands that you can access while at the IPv4 unicast address family configuration level are also available at the IPv6 unicast address family configuration levels. Each address family configuration level allows you to access commands that apply to that particular address family only.

Where relevant, this chapter discusses and provides IPv4-unicast-specific examples.

The following configuration options are allowed under BGP IPv4 address family unicast configuration mode:

```
device(config-bgp-router)# address-family ipv4 unicast

device(config-bgp-ipv4u)# ?
Possible completions:
  aggregate-address          Configure BGP aggregate entries
  always-propagate          Allow readvertisement of best BGP routes not
                             in IP Forwarding table
  bgp-redistribute-internal  Allow redistribution of iBGP routes into IGPs
  client-to-client-reflection  Configure client to client route reflection
  dampening                  Enable route-flap dampening
  default-information-originate  Originate Default Information
  default-metric              Set metric of redistributed routes
  graceful-restart            Enables the BGP graceful restart capability
  maximum-paths               Forward packets over multiple paths
  multipath                   Enable multipath for ibgp or ebgp neighbors
```

	only
neighbor	Specify a neighbor router
network	Specify a network to announce via BGP
next-hop-enable-default	Enable default route for BGP next-hop lookup
next-hop-recursion	Perform next-hop recursive lookup for BGP route
redistribute	Redistribute information from another routing protocol
rib-route-limit	Limit BGP rib count in routing table
static-network	Special network that do not depends on IGP and always treat as best route in BGP
table-map	Map external entry attributes into routing table
update-time	Configure igp route update interval

Neighbor configuration

For each neighbor a device is going to peer with, there must be a neighbor configuration that specifies an IP address (which must be the primary IP address of interface connection to get established) and an AS number of the neighbor. For each neighbor, you can specify a set of attributes. However, in cases where a set of neighbors share the same set of attributes, it is advisable to create a peer-group.

The neighbor configuration appears in both the global and address-family modes of BGP. The neighbor parameters that are common to all of the address families appear in BGP global configuration mode, while the parameters that are specific to an address family appear within the BGP address-family submode.

The following neighbor configuration options are allowed under BGP global configuration mode:

```
device(config-bgp-router)# neighbor 10.1.1.1 ?
Possible completions:
  advertisement-interval  Minimum interval between sending BGP routing updates
  as-override             Override matching AS-number while sending update
  bfd                    Enable BFD session for the neighbor
  capability              Advertise capability to the peer
  description             Neighbor by description
  ebgp-btsh              Enable EBGp TTL Security Hack Protection
  ebgp-multihop          Allow EBGp neighbors not on directly connected
                        networks
  enforce-first-as       Enforce the first AS for EBGp routes
  local-as               Assign local-as number to neighbor
  maxas-limit            Impose limit on number of ASes in AS-PATH attribute
  next-hop-self          Disable the next hop calculation for this neighbor
  password               Enable TCP-MD5 password protection
  peer-group             Assign peer-group to neighbor
  remote-as              Specify a BGP neighbor
  remove-private-as      Remove private AS number from outbound updates
  shutdown               Administratively shut down this neighbor
  soft-reconfiguration   Per neighbor soft reconfiguration
  static-network-edge    Neighbor as special service edge, static-network
                        shall not be advertised if installed as DROP
  timers                 BGP per neighbor timers
  update-source          Source of routing updates
```

The following neighbor configuration options are allowed under BGP IPv4 address family unicast configuration mode:

```
device(config-bgp-ipv4u)# neighbor 10.1.1.1 ?
Possible completions:
  activate                Allow exchange of route in the current family mode
  allowas-in              Disables the AS_PATH check of the routes learned
                        from the AS
  capability              Advertise capability to the peer
  default-originate       Originate default route to peer
  filter-list             Establish BGP filters
  maximum-prefix          Maximum number of prefix accept from this peer
  prefix-list             Prefix List for filtering routes
  route-map               Apply route map to neighbor
  route-reflector-client Configure a neighbor as Route Reflector client
```

<code>send-community</code>	Send community attribute to this neighbor
<code>unsuppress-map</code>	Route-map to selectively unsuppress suppressed routes
<code>weight</code>	Set default weight for routes from this neighbor

Configuring BGP4 neighbors

BGP4 neighbors can be configured using this procedure.

1. Enter the **configure terminal** command to access global configuration mode.

```
device# configure terminal
```

2. Enter the **router bgp** command to enable BGP routing.

```
device(config)# router bgp
```

3. Enter the **local-as** command to configure the autonomous system number (ASN) in which your device resides.

```
device(config-bgp-router)# local-as 1000
```

4. Enter the **neighbor remote-as** command, and specify an IP address, to specify the ASN in which the remote neighbor resides.

```
device(config-bgp-router)# neighbor 10.1.1.1 remote-as 1001
```

The following example configures a BGP4 neighbor.

```
device# configure terminal
device(config)# router bgp
device(config-bgp-router)# local-as 1000
device(config-bgp-router)# neighbor 10.1.1.1 remote-as 1001
```

Peer groups

Neighbors having the same attributes and parameters can be grouped together by means of the **neighbor peer-group** command. You must first create a peer-group, after which you can associate neighbor IP addresses with the peer-group. All of the attributes that are allowed on a neighbor are also allowed on a peer-group.

The benefits of peer groups are:

- Simplified neighbor configuration - You can configure a set of neighbor parameters and then apply them to multiple neighbors. You do not need to configure the common parameters individually on each neighbor.
- Flash memory conservation - Using peer groups instead of individually configuring all the parameters for each neighbor requires fewer configuration commands in the startup configuration file.

You can perform the following tasks on a peer-group basis:

- Reset neighbor sessions
- Perform soft-outbound resets (the device updates outgoing route information to neighbors but does not entirely reset the sessions with those neighbors)
- Clear BGP4 message statistics
- Clear error buffers

An attribute value configured explicitly for a neighbor takes precedence over the attribute value configured for a peer-group. If neither the peer-group nor the individual neighbor has the attribute configured, the default value for the attribute is used.

For the parameters of a peer group to take effect, the peer group must be activated in the IPv4 or IPv6 address-family. By default, only IPv4 unicast address family is activated for a peer-group. A user needs to explicitly activate a peer-group in the IPv6 unicast address-family configuration mode when used with IPv6 peers.

Configuring BGP4 peer groups

A peer group can be created and neighbor IPv4 addresses can be associated with the peer group.

1. Enter the **configure terminal** command to access global configuration mode.

```
device# configure terminal
```

2. Enter the **router bgp** command to enable BGP routing.

```
device(config)# router bgp
```

3. Enter the **local-as** command to configure the autonomous system number (ASN) in which your device resides.

```
device(config-bgp-router)# local-as 1000
```

4. Enter the **neighbor peer-group-name peer-group** command to create a peer group.

```
device(config-bgp-router)# neighbor mypeergroup1 peer-group
```

5. Enter the **neighbor peer-group-name remote-as** command to specify the ASN of the peer group.

```
device(config-bgp-router)# neighbor mypeergroup1 remote-as 11
```

6. Enter the **neighbor ip-address peer-group** command to associate a neighbor with the peer group.

```
device(config-bgp-router)# neighbor 10.2.2.2 peer-group mypeergroup1
```

7. Enter the **neighbor ip-address peer-group** command to associate another neighbor with the peer group.

```
device(config-bgp-router)# neighbor 10.3.3.3 peer-group mypeergroup1
```

The following example creates a peer group and specifies two neighbors to belong to the peer group.

```
device# configure terminal
device(config)# router bgp
device(config-bgp-router)# local-as 1000
device(config-bgp-router)# neighbor mypeergroup1 peer-group
device(config-bgp-router)# neighbor mypeergroup1 remote-as 11
device(config-bgp-router)# neighbor 10.2.2.2 peer-group mypeergroup1
device(config-bgp-router)# neighbor 10.3.3.3 peer-group mypeergroup1
```

Advertising the default BGP4 route

By default, a BGP device does not originate and advertise a default route using BGP4. A BGP4 default route is the IP address 0.0.0.0 and the route prefix 0 or network mask 0.0.0.0. For example, 0.0.0.0/0 is a default route. A BGP device can be configured to advertise the default IPv4 route to all BGP4 neighbors and to install that route in the local BGP4 route table.

The default route must be present in the local IPv4 route table.

1. Enter the **configure terminal** command to access global configuration mode.

```
device# configure terminal
```

2. Enter the **router bgp** command to enable BGP routing.

```
device(config)# router bgp
```

3. Enter the **address-family ipv4 unicast** command to enter IPv4 address family unicast configuration mode.

```
device(config-bgp-router)# address-family ipv4 unicast
```

4. Enter the **default-information-originate** command to advertise the default IPv4 route to all BGP4 neighbors and to install that route in the local BGP4 route table.

```
device(config-bgp-ipv4u)# default-information-originate
```

The following example enables a BGP4 device to advertise the default IPv4 route to all BGP4 neighbors and to install that route in the local BGP4 route table.

```
device# configure terminal
device(config)# router bgp
device(config-bgp-router)# address-family ipv4 unicast
device(config-bgp-ipv4u)# default-information-originate
```

Four-byte AS numbers

Four-byte autonomous system numbers (ASNs) can be optionally configured on a device, peer-group, or neighbor. If this is enabled, the device announces and negotiates "AS4" capability with its neighbors.

You can configure AS4 capability to be enabled or disabled either at the BGP global level or at the neighbor or peer-group level.

You can configure AS4 capability to be enabled for a neighbor while still keeping AS4 numbers disabled at the global level, or vice-versa. The neighbor AS4 capability configuration takes precedence. If AS4 capability is not configured on the neighbor, then the peer-group configuration takes effect. The global configuration is used if AS4 capability is configured neither at the neighbor nor at the peer-group level. If a device having a 4-byte ASN tries to connect to a device that does not have AS4 support, peering will not be established.

Enabling ASN capability globally

Four-byte autonomous system numbers (ASNs) can be configured on a device. The following task enables 4-byte autonomous system number (ASN) capability at the BGP global level.

1. Enter the **configure terminal** command to access global configuration mode.

```
device# configure terminal
```

2. Enter the **router bgp** command to enable BGP routing.

```
device(config)# router bgp
```

3. Enter the **capability as4-enable** command to enable 4-byte autonomous system number (ASN) capability globally.

```
device(config-bgp-router)# capability as4-enable
```

The following example enables 4-byte autonomous system number (ASN) capability globally.

```
device# configure terminal
device(config)# router bgp
device(config-bgp-router)# capability as4-enable
```

Enabling ASN capability for a BGP4 neighbor

Four-byte autonomous system numbers (ASNs) can be configured for a neighbor or peer-group. The following task enables 4-byte autonomous system number (ASN) capability for a neighbor.

1. Enter the **configure terminal** command to access global configuration mode.

```
device# configure terminal
```

2. Enter the **router bgp** command to enable BGP routing.

```
device(config)# router bgp
```

3. Enter the **local-as** command to configure the autonomous system number (ASN) in which your device resides.

```
device(config-bgp-router)# local-as 1000
```

4. Enter the **neighbor capability as4** command with the **enable** parameter, and specify an IP address, to enable 4-byte autonomous system number (ASN) capability for a specific neighbor.

```
device(config-bgp-router)# neighbor 10.1.2.3 capability as4 enable
```

The following example enables 4-byte autonomous system number (ASN) capability for a specific neighbor.

```
device# configure terminal
device(config)# router bgp
device(config-bgp-router)# local-as 1000
device(config-bgp-router)# neighbor 10.1.2.3 capability as4 enable
```

Cooperative BGP4 route filtering

By default, the device performs all filtering of incoming routes locally, on the device itself. You can use cooperative BGP4 route filtering to cause the filtering to be performed by a neighbor before it sends the routes to the device. Cooperative filtering conserves resources by eliminating unnecessary route updates and filter processing. For example, the device can send a deny filter to a neighbor, which the neighbor uses to filter out updates before sending them to the device. The neighbor saves the resources it would otherwise use to generate the route updates, and the device saves the resources it would use to filter out the routes.

When you enable cooperative filtering, the device advertises this capability in its Open message to the neighbor when initiating the neighbor session. The Open message also indicates whether the device is configured to send filters, receive filters, or both, and the types of filters it can send or receive. The device sends the filters as Outbound Route Filters (ORFs) in route refresh messages.

To configure cooperative filtering, perform the following tasks on the device and on the BGP4 neighbor:

- Configure the filter.

NOTE

Cooperative filtering is currently supported only for filters configured using IP prefix lists.

- Apply the filter as an inbound filter to the neighbor.
- Enable the cooperative route filtering feature on the device. You can enable the device to send ORFs to the neighbor, to receive ORFs from the neighbor, or both. The neighbor uses the ORFs you send as outbound filters when it sends routes to the device. Likewise, the device uses the ORFs it receives from the neighbor as outbound filters when sending routes to the neighbor.
- Reset the BGP4 neighbor session to send and receive ORFs.
- Perform these steps on the other device.

NOTE

If the device has inbound filters, the filters are still processed even if equivalent filters have been sent as ORFs to the neighbor.

BGP4 parameters

Some parameter changes take effect immediately while others do not take full effect until the device sessions with its neighbors are reset. Some parameters do not take effect until the device is rebooted.

The following parameter changes take effect immediately:

- Enable or disable BGP4.
- Set or change the local AS.
- Add neighbors.
- Change the update timer for route changes.
- Disable or enable fast external failover.
- Specify individual networks that can be advertised.
- Change the default local preference, default information originate setting, or administrative distance.
- Enable or disable use of a default route to resolve a BGP4 next-hop route.
- Enable or disable MED (metric) comparison.
- Require the first AS in an update from an EBGP neighbor to be the neighbor AS.
- Change MED comparison parameters.
- Disable comparison of the AS-Path length.
- Enable comparison of the device ID.
- Enable next-hop recursion.
- Change the default metric.
- Disable or re-enable route reflection.
- Configure confederation parameters.
- Disable or re-enable load sharing.
- Change the maximum number of load sharing paths.
- Change other load-sharing parameters.
- Define route flap dampening parameters.
- Add, change, or negate redistribution parameters (except changing the default MED).
- Add, change, or negate route maps (when used by the **network** command or a redistribution command).
- Apply maximum AS path limit settings for UPDATE messages.
- Aggregate routes

The following parameter changes take effect only after the BGP4 sessions on the device are cleared, or reset using the "soft" clear option:

- Change the Hold Time or Keep Alive Time.
- Apply maximum AS path limit settings to the RIB.

The following parameter change takes effect only after you disable and then re-enable redistribution:

- Change the default MED (metric).

Route redistribution

The redistribution of static, connected, and OSPF routes into BGP is supported. Similarly, routes learned through BGP can also be redistributed into OSPF.

An optional route-map can be specified, and this map will be consulted before routes are added to BGP. Management routes are not redistributed.

Redistributing routes into BGP4

Various routes can be redistributed into BGP. This task redistributes connected routes into BGP4.

1. Enter the **configure terminal** command to access global configuration mode.

```
device# configure terminal
```

2. Enter the **router bgp** command to enable BGP routing.

```
device(config)# router bgp
```

3. Enter the **address-family ipv4 unicast** command to enter BGP IPv4 address family unicast configuration mode.

```
device(config-bgp-router)# address-family ipv4 unicast
```

4. Enter the **redistribute** command using the **connected** keyword to redistribute connected routes.

```
device(config-bgp-ipv4u)# redistribute connected
```

The following example redistributes connected routes into BGP4.

```
device# configure terminal
device(config)# router bgp
device(config-bgp-router)# address-family ipv4 unicast
device(config-bgp-ipv4u)# redistribute connected
```

Advertised networks

As previously described, you can advertise routes into BGP by redistributing static, connected, or OSPF routes.

However, you can explicitly specify routes to be advertised by BGP4 by using the **network** command in IPv4 address-family unicast configuration mode.

With the exception of static network routes, the routing table must have this route already installed before BGP4 can advertise this route. You can also specify a route to be local. If the same route is received by means of eBGP, the local IGP route will be preferred. You can also specify a weight that the device adds to routes that are received from the specified BGP neighbor. BGP4 prefers larger weights over smaller weights.

Refer to the *Brocade SLX-OS Command Reference* for more information.

Importing routes into BGP4

Routes can be explicitly specified for advertisement by BGP.

With the exception of static network routes, the routes imported into BGP4 must first exist in the IPv4 unicast route table.

1. Enter the **configure terminal** command to access global configuration mode.

```
device# configure terminal
```

2. Enter the **router bgp** command to enable BGP routing.

```
device(config)# router bgp
```

3. Enter the **neighbor remote-as** command to specify the ASN in which the remote neighbor resides.

```
device(config-bgp-router)# neighbor 10.2.2.2 remote-as 1001
```

4. Enter the **address-family ipv4 unicast** command to enter address family IPv4 unicast configuration mode.

```
device(config-bgp-router)# address-family ipv4 unicast
```

5. Enter the **network** command and specify a *network/mask* to import the specified prefix into the BGP4 database.

```
device(config-bgp-ipv4u)# network 10.1.1.1/32
```

The following example imports the 10.1.1.1/32 prefix in to the BGP4 database for advertising.

```
device# configure terminal
device(config)# router bgp
device(config-bgp-router)# neighbor 10.2.2.2 remote-as 1001
device(config-bgp-router)# address-family ipv4 unicast
device(config-bgp-ipv4u)# network 10.1.1.1/32
```

Static networks

Before advertising any route, BGP checks for its existence in the routing table. BGP can be configured to advertise a stable route that does not depend on its existence in the routing table.

This allows you to configure a static network in BGP4, creating a stable BGP4 network in the core. While a route configured with this feature will never flap unless it is manually deleted, a "static" BGP4 network will not interrupt the normal BGP4 decision process on other learned routes being installed into the Routing Table Manager (RTM). Consequently, when there is a route that can be resolved, it will be installed into the RTM.

When the configured route is lost, BGP installs the "null0" route in the routing table. Later, when the route is resolved, the null0 route is removed.

Configuring a static network

BGP can be configured to advertise a stable route that does not depend on its existence in the routing table. The following task configures a static network and sets the administrative distance.

1. Enter the **configure terminal** command to access global configuration mode.

```
device# configure terminal
```

2. Enter the **router bgp** command to enable BGP routing.

```
device(config)# router bgp
```

3. Enter the **local-as** command to configure the autonomous system number (ASN) in which your device resides.

```
device(config-bgp-router)# local-as 1000
```

4. Enter the **address-family ipv4 unicast** command to enter IPv4 address family configuration mode.

```
device(config-bgp-router)# address-family ipv4 unicast
```

5. Enter the **static-network** command with the **distance** parameter, and specify a value, to configure a static network and set an administrative distance.

```
device(config-bgp-ipv4u)# static-network 10.11.12.0/32 distance 200
```

The following example configures a static network and sets an administrative distance of 200.

```
device# configure terminal
device(config)# router bgp
device(config-bgp-router)# local-as 1000
device(config-bgp-router)# address-family ipv4 unicast
device(config-bgp-ipv4u)# static-network 10.11.12.0/32 distance 200
```

Route reflection

A BGP device can act as a route-reflector client or as a route reflector. You can configure a BGP peer as a route-reflector client from the device that is going to reflect the routes and act as the route reflector using the **neighbor route-reflector-client** command.

When there is more than one route reflector, they should all belong to the same cluster. By default, the value for **cluster-id** is used as the device ID. The device ID can be changed using the **cluster-id** command.

The route-reflector server reflects the routes as follows:

- Routes from the client are reflected to the client as well as to nonclient peers.
- Routes from nonclient peers are reflected only to client peers.

If route-reflector clients are connected in a full iBGP mesh, you can disable client-to-client reflection on the route reflector using the **no client-to-client-reflection** command.

A BGP device advertises only those routes that are preferred ones and are installed into the Routing Table Manager (RTM). When a route cannot be installed into the RTM because the routing table is full, the route reflector may not reflect that route. In cases where the route reflector is not placed directly in the forwarding path, you can configure the route reflector to reflect routes even though those routes are not in the RTM using the **always-propagate** command.

Configuring a cluster ID for a route reflector

The cluster ID can be changed if there is more than one route reflector, so that all route reflectors belong to the same cluster.

1. Enter the **configure terminal** command to access global configuration mode.

```
device# configure terminal
```

2. Enter the **router bgp** command to enable BGP routing.

```
device(config)# router bgp
```

3. Enter the **local-as** command to configure the autonomous system number (ASN) in which your device resides.

```
device(config-bgp-router)# local-as 1000
```

4. Enter the **cluster-id** command and specify a value to change the cluster ID of a device from the default device ID.

```
device(config-bgp-router)# cluster-id 321
```

The following example changes the cluster ID of a device from the default device ID to 321.

```
device# configure terminal
device(config)# router bgp
device(config-bgp-router)# cluster-id 321
```

Configuring a route reflector client

A BGP peer can be configured as a route reflector client.

1. Enter the **configure terminal** command to access global configuration mode.

```
device# configure terminal
```

2. Enter the **router bgp** command to enable BGP routing.

```
device(config)# router bgp
```

3. Enter the **local-as** command to configure the autonomous system number (ASN) in which your device resides.

```
device(config-bgp-router)# local-as 1000
```

4. Enter the **address-family ipv4 unicast** command to enter IPv4 address family configuration mode.

```
device(config-bgp-router)# address-family ipv4 unicast
```

5. Enter the **neighbor route-reflector-client** command to configure a specified neighbor to be a route reflector client.

```
device(config-bgp-ipv4u)# neighbor 10.1.1.1 route-reflector-client
```

The following example configures a neighbor with the IPv4 address 10.1.1.1 to be a route reflector client.

```
device# configure terminal
device(config)# router bgp
device(config-bgp-router)# local-as 1000
device(config-bgp-router)# address-family ipv4 unicast
device(config-bgp-ipv4u)# neighbor 10.1.1.1 route-reflector-client
```

Route flap dampening

A route flap is a change in the state of a route, from up to down or down to up. A route state change causes changes in the route tables of the devices that support the route.

Frequent route state changes can cause Internet instability and add processing overhead to the devices that support the route. Route flap dampening helps reduce the impact of route flap by changing the way a BGP4 device responds to route state changes. When route flap dampening is configured, the device suppresses unstable routes until the number of route state changes drops enough to meet an acceptable degree of stability.

The route flap dampening mechanism is based on penalties. When a route exceeds a configured penalty value, the device stops using that route and stops advertising it to other devices. The mechanism also allows route penalties to reduce over time if route stability improves.

Aggregating routes advertised to BGP neighbors

A device can be configured to aggregate routes in a range of networks into a single IP prefix.

1. Enter the **configure terminal** command to access global configuration mode.

```
device# configure terminal
```

2. Enter the **router bgp** command to enable BGP routing.

```
device(config)# router bgp
```

3. Enter the **address-family ipv4 unicast** command to enter BGP address family IPv4 unicast configuration mode.

```
device(config-bgp-router)# address-family ipv4 unicast
```

4. Enter the **aggregate-address** command to aggregate the routes from a range of networks into a single network prefix.

```
device(config-bgp-ipv4u)# aggregate-address 10.1.1.1/32
```

The following example enables a BGP4 device to advertise the default route and send the default route to a specified neighbor.

```
device# configure terminal
device(config)# router bgp
device(config-bgp-router)# address-family ipv4 unicast
device(config-bgp-ipv4u)# aggregate-address 10.1.1.1/32
```

Advertising the default BGP4 route

By default, a BGP device does not originate and advertise a default route using BGP4. A BGP4 default route is the IP address 0.0.0.0 and the route prefix 0 or network mask 0.0.0.0. For example, 0.0.0.0/0 is a default route. A BGP device can be configured to advertise the default IPv4 route to all BGP4 neighbors and to install that route in the local BGP4 route table.

The default route must be present in the local IPv4 route table.

1. Enter the **configure terminal** command to access global configuration mode.

```
device# configure terminal
```

2. Enter the **router bgp** command to enable BGP routing.

```
device(config)# router bgp
```

3. Enter the **address-family ipv4 unicast** command to enter IPv4 address family unicast configuration mode.

```
device(config-bgp-router)# address-family ipv4 unicast
```

4. Enter the **default-information-originate** command to advertise the default IPv4 route to all BGP4 neighbors and to install that route in the local BGP4 route table.

```
device(config-bgp-ipv4u)# default-information-originate
```

The following example enables a BGP4 device to advertise the default IPv4 route to all BGP4 neighbors and to install that route in the local BGP4 route table.

```
device# configure terminal
device(config)# router bgp
device(config-bgp-router)# address-family ipv4 unicast
device(config-bgp-ipv4u)# default-information-originate
```

Advertising the default BGP4 route to a specific neighbor

A BGP device can be configured to advertise the default IPv4 route to a specific neighbor.

1. Enter the **configure terminal** command to access global configuration mode.

```
device# configure terminal
```

2. Enter the **router bgp** command to enable BGP routing.

```
device(config)# router bgp
```

3. Enter the **local-as** command to configure the autonomous system number (ASN) in which your device resides.

```
device(config-bgp-router)# local-as 1000
```

4. Enter the **address-family ipv4 unicast** command to enter IPv4 address family configuration mode.

```
device(config-bgp-router)# address-family ipv4 unicast
```

5. Enter the **neighbor default-originate** command and specify an IP address to enable the BGP4 device to advertise the default IPv4 route to a specific neighbor.

```
device(config-bgp-ipv4u)# neighbor 10.4.4.4 default-originate
```

The following example enables a BGP4 device to advertise the default IPv4 route to a specific neighbor.

```
device# configure terminal
device(config)# router bgp
device(config-bgp-router)# local-as 1000
device(config-bgp-router)# address-family ipv4 unicast
device(config-bgp-ipv4u)# neighbor 10.4.4.4 default-originate
```

Multipath load sharing

Unlike IGP, BGP does not perform multipath load sharing by default. Therefore, the maximum number of paths across which BGP can balance the traffic is set to 1 by default. You can change this value by using the **maximum-paths** command.

By default, when BGP4 multipath load sharing is enabled, both iBGP and eBGP paths are eligible for load sharing, while paths from different neighboring autonomous systems are not eligible. You can change load sharing to apply only to iBGP or eBGP paths, or to support load sharing among paths from different neighboring autonomous systems.

Specifying the weight added to received routes

The weight that the device adds to received routes can be specified. The following task changes the weight from the default for routes that are received from a specified BGP neighbor.

1. Enter the **configure terminal** command to access global configuration mode.

```
device# configure terminal
```

2. Enter the **router bgp** command to enable BGP routing.

```
device(config)# router bgp
```

3. Enter the **local-as** command to configure the autonomous system number (ASN) in which your device resides.

```
device(config-bgp-router)# local-as 65520
```

4. Enter the **address-family ipv4 unicast** command to enter address family IPv4 unicast configuration mode.

```
device(config-bgp-router)# address-family ipv4 unicast
```

5. Enter the **neighbor weight** command and specify an *ip address* and a weight value to specify a weight that the device adds to routes that are received from the specified BGP4 neighbor.

```
device(config-bgp-ipv4u)# neighbor 10.11.12.13 weight 100
```

The following example specifies a weight of 100 that the device adds to routes that are received from the specified BGP4 neighbor.

```
device# configure terminal
device(config)# router bgp
device(config-bgp-router)# local-as 65520
device(config-bgp-router)# address-family ipv4 unicast
device(config-bgp-ipv4u)# neighbor 10.11.12.13 weight 100
```

Using the IPv4 default route as a valid next hop for a BGP4 route

In certain cases, such as when a device is acting as an edge device, it can be configured to use the default route as a valid next hop.

By default, a device does not use a default route to resolve a BGP4 next-hop route. If the IPv4 route lookup for the BGP4 next-hop does not result in a valid IGP route (including static or direct routes), the BGP4 next-hop is considered to be unreachable and the BGP4 route is not used. You can configure the device to use the default route as a valid next hop.

1. Enter the **configure terminal** command to access global configuration mode.

```
device# configure terminal
```

2. Enter the **router bgp** command to enable BGP routing.

```
device(config)# router bgp
```

3. Enter the **address-family ipv4 unicast** command to enter IPv4 address family unicast configuration mode.

```
device(config-bgp-router)# address-family ipv4 unicast
```

4. Enter the **next-hop-enable-default** command to configure the device to use the default route as a valid next hop.

```
device(config-bgp-ipv4u)# next-hop-enable-default
```

The following example configures a BGP4 device to use the default route as a valid next hop.

```
device# configure terminal
device(config)# router bgp
device(config-bgp-router)# address-family ipv4 unicast
device(config-bgp-ipv4u)# next-hop-enable-default
```

Adjusting defaults to improve routing performance

The following examples illustrate a variety of options for enabling and fine-tuning route flap dampening.

The following example enables default dampening as an address-family function.

```
device# configure terminal
device(config)# router bgp
device(config-bgp-router)# address-family ipv4 unicast
device(config-bgp-ipv4u)# dampening
```

The following example changes all dampening values.

```
device# configure terminal
device(config)# router bgp
device(config-bgp-router)# address-family ipv4 unicast
device(config-bgp-ipv4u)# dampening 20 200 2500 40
```

Next-hop recursion

For each BGP4 route learned, the device performs a route lookup to obtain the IPv4 address of the next hop for the route. A BGP4 route is eligible for addition in the IPv4 route table only if the following conditions are true:

- The lookup succeeds in obtaining a valid next-hop IPv4 address for the route.
- The path to the next-hop IP address is an IGP path or a static route path.

By default, only one lookup is performed for the next-hop IPv4 address for the BGP4 route. If the next hop lookup does not result in a valid next hop IPv4 address, or the path to the next hop IPv4 address is a BGP4 path, the BGP4 route destination is considered unreachable. The route is not eligible to be added to the IPv4 route table.

The BGP4 route table can contain a route with a next hop IPv4 address that is not reachable through an IGP route, even though the device can reach a hop farther away through an IGP route. This can occur when the IGP does not learn a complete set of IGP routes, so the device learns about an internal route through iBGP instead of through an IGP. In this case, the IPv4 route table does not contain a route that can be used to reach the BGP4 route destination.

When next-hop recursion is enabled, if the lookup for the next hop IP address results in an iBGP path that originated in the same AS, then the next hop is considered as resolved and BGP4 depended routes are eligible for addition in the IPv4 route table.

Enabling next-hop recursion

Next hop recursion can be enabled so that a device can find the IGP route to the next hop gateway for a BGP4 route.

1. Enter the **configure terminal** command to access global configuration mode.

```
device# configure terminal
```

2. Enter the **router bgp** command to enable BGP routing.

```
device(config)# router bgp
```

3. Enter the **address-family ipv4 unicast** command to enter IPv4 address family configuration mode.

```
device(config-bgp-router)# address-family ipv4 unicast
```

4. Enter the **next-hop-recursion** command to enable recursive next hop lookups.

```
device(config-bgp-ipv4u)# next-hop-recursion
```

The following example enables recursive next hop lookups.

```
device# configure terminal
device(config)# router bgp
device(config-bgp-router)# address-family ipv4 unicast
device(config-bgp-ipv4u)# next-hop-recursion
```

Route filtering

The following route filters are supported:

- AS-path filter
- Community filter
- Prefix list
- Route map
- Table map

Timers

The keep alive time specifies how frequently the device sends KEEPALIVE messages to its BGP4 neighbors. The hold time specifies how long the device waits for a KEEPALIVE or UPDATE message from a neighbor before concluding that the neighbor is dead. When the device concludes that a BGP4 neighbor is dead, the device ends the BGP4 session and closes the TCP connection to the neighbor.

A hold-time value of 0 means that the device waits indefinitely for messages from a neighbor without tearing down the session.

Enabling BGP4 in a non-default VRF

When BGP4 is enabled in a non-default VRF instance, the device enters BGP address-family IPv4 unicast VRF configuration mode. Several commands can then be accessed that allow the configuration of BGP4 for the non-default VRF instance.

A non-default VRF instance has been configured.

1. Enter the **configure terminal** command to access global configuration mode.

```
device# configure terminal
```

2. Enter the **router bgp** command to enable BGP routing globally.

```
device(config)# router bgp
```

3. Enter the **address-family ipv4 unicast** command with the **vrf** parameter, and specify a VRF name, to enter BGP address-family IPv4 unicast VRF configuration mode.

```
device(config-bgp-router)# address-family ipv4 unicast vrf red
```

The following example enables BGP address-family IPv4 unicast VRF configuration mode where several commands can be accessed that allow the configuration of BGP4 for the non-default VRF instance..

```
device# configure terminal
device(config)# router bgp
device(config-bgp-router)# address-family ipv4 unicast vrf red
device(config-bgp-ipv4u-vrf)#
```

BGP4 outbound route filtering

The BGP4 Outbound Route Filtering Capability (ORF) feature is used to minimize the number of BGP updates sent between BGP peers.

When the ORF feature is enabled, unwanted routing updates are filtered out, reducing the amount of system resources required for generating and processing routing updates. The ORF feature is enabled through the advertisement of ORF capabilities to peer routers. The locally configured BGP4 inbound prefix filters are sent to the remote peer so that the remote peer applies the filter as an outbound filter for the neighbor.

The ORF feature can be configured with send and receive ORF capabilities. The local peer advertises the ORF capability in send mode, indicating that it will accept a prefix list from a neighbor and apply the prefix list to locally configured ORFs. The local peer exchanges the ORF capability in send mode with a remote peer for a prefix list that is configured as an inbound filter for that peer locally. The remote peer only sends the first update once it receives a ROUTEREFRESH request or BGP ORF with IMMEDIATE from the peer. The local and remote peers exchange updates to maintain the ORF on each router.

Configuring BGP4 outbound route filtering

The BGP4 Outbound Route Filtering (ORF) prefix list capability can be configured in receive mode, send mode, or both send and receive modes, minimizing the number of BGP updates exchanged between BGP peers.

1. Enter the **configure terminal** command to access global configuration mode.

```
device# configure terminal
```

2. Enter the **router bgp** command to enable BGP routing.

```
device(config)# router bgp
```

3. Enter the **address-family ipv4 unicast** command to enter IPv4 address family configuration mode.

```
device(config-bgp-router)# address-family ipv4 unicast
```

4. Enter the **neighbor prefix-list** command and specify the **in** keyword to filter the incoming route updates from a specified BGP neighbor.

```
device(config-bgp-ipv4u)# neighbor 10.1.2.3 prefix-list myprefixlist in
```

5. Do one of the following:

- Enter the **neighbor capability orf prefixlist** command and specify the **send** keyword to advertise ORF send capabilities.

```
device(config-bgp-ipv4)# neighbor 10.1.2.3 capability orf prefixlist send
```

- Enter the **neighbor capability orf prefixlist** command and specify the **receive** keyword to advertise ORF receive capabilities.

```
device(config-bgp-ipv4)# neighbor 10.1.2.3 capability orf prefixlist receive
```

- Enter the **neighbor capability orf prefixlist** command to configure ORF capability in both send and receive modes.

```
device(config-bgp-ipv4)# neighbor 10.1.2.3 capability orf prefixlist
```

The following example configures ORF in receive mode.

```
device# configure terminal
device(config)# router bgp
device(config-bgp-router)# address-family ipv4 unicast
device(config-bgp-ipv4)# neighbor 10.1.2.3 capability orf prefixlist receive
```

The following example configures ORF in send mode.

```
device# configure terminal
device(config)# router bgp
device(config-bgp-router)# address-family ipv4 unicast
device(config-bgp-ipv4)# 10.1.2.3 prefix-list myprefixlist in
device(config-bgp-ipv4)# 10.1.2.3 capability orf prefixlist send
```

The following example configures ORF in both send and receive modes.

```
device# configure terminal
device(config)# router bgp
device(config-bgp-router)# address-family ipv4 unicast
device(config-bgp-ipv4)# neighbor 10.1.2.3 prefix-list myprefixlist in
device(config-bgp-ipv4)# neighbor 10.1.2.3 capability orf prefixlist
```

Enabling BGP4 cooperative route filtering

You can use cooperative BGP4 route filtering to cause the filtering to be performed by a neighbor before it sends the routes to the device, conserving resources by eliminating unnecessary route updates and filter processing. The following task enables cooperative route filtering.

1. Enter the **configure terminal** command to access global configuration mode.

```
device# configure terminal
```

2. Enter the **ip prefix-list** command to to configure the IP prefix list instance.

```
device(config)# ip prefix-list Routesfrom10234 deny 10.20.0.0/24
device(config)# ip prefix-list Routesfrom10234 permit 10.0.0.0/0 le 32
```

3. Enter the **router bgp** command to enable BGP routing.

```
device(config)# router bgp
```

4. Enter the **address-family ipv4 unicast** command to enter IPv4 address family configuration mode.

```
device(config-bgp-router)# address-family ipv4 unicast
```

5. Enter the **neighbor prefix-list** command with the **in** parameter and specify a prefix-list to filter the incoming route updates from the specified BGP neighbor.

```
device(config-bgp-ipv4u)# neighbor 10.2.3.4 prefix-list Routesfrom1234 in
```

6. Enter the **capability orf prefixlist** command with the **send** parameter to enable the ORF prefix list capability in send mode.

```
device(config-bgp-ipv4u)# neighbor 10.2.3.4 capability orf prefixlist send
```

The following example enables BGP4 cooperative route filtering.

```
device# configure terminal
device(config)# ip prefix-list Routesfrom10234 deny 10.20.0.0/24
device(config)# ip prefix-list Routesfrom10234 permit 10.0.0.0/0 le 32
device(config)# router bgp
device(config-bgp-router)# address-family ipv4 unicast
device(config-bgp-ipv4u)# neighbor 10.2.3.4 prefix-list Routesfrom1234 in
device(config-bgp-ipv4u)# neighbor 10.2.3.4 capability orf prefixlist send
```

BGP4 confederations

A large autonomous system (AS) can be divided into multiple subautonomous systems and grouped into a single BGP4 confederation.

Each subautonomous system must be uniquely identified within the confederation AS by a subautonomous system number. Within each subautonomous system, all the rules of internal BGP (iBGP) apply. For example, all BGP routers inside the subautonomous system must be fully meshed. Although eBGP is used between subautonomous systems, the subautonomous systems within the confederation exchange routing information like iBGP peers. Next hop, Multi Exit Discriminator (MED), and local preference information is preserved when crossing subautonomous system boundaries. To the outside world, a confederation looks like a single AS.

The AS path list is a loop-avoidance mechanism used to detect routing updates leaving one subautonomous system and attempting to re-enter the same subautonomous system. A routing update attempting to re-enter a subautonomous system it originated from is detected because the subautonomous system sees its own subautonomous system number listed in the update's AS path.

Configuring BGP4 confederations

BGP4 confederations, composed of multiple subautonomous systems, can be created.

1. Enter the **configure terminal** command to access global configuration mode.

```
device# configure terminal
```

2. Enter the **router bgp** command to enable BGP routing.

```
device(config)# router bgp
```

3. Enter the **local-as** command to configure the autonomous system number (ASN) in which your device resides.

```
device(config-bgp-router)# local-as 65520
```

4. Enter the **confederation identifier** command and specify an ASN to configure a BGP confederation identifier.

```
device(config-bgp-router)# confederation identifier 100
```

5. Enter the **confederation peers** command and specify as many ASNs as needed to list all BGP peers that will belong to the confederation.

```
device(config-bgp-router)# confederation peers 65520 65521 65522
```

The following example creates a confederation with the confederation ID "100" and adds three subautonomous systems to the confederation.

```
device# configure terminal
device(config)# router bgp
device(config-bgp-router)# local-as 65520
device(config-bgp-router)# confederation identifier 100
device(config-bgp-router)# confederation peers 65520 65521 65522
```

Auto shutdown of BGP neighbors on initial configuration

The auto shutdown of BGP neighbors on initial configuration feature prevents a BGP peer from attempting to establish connections with remote peers when the BGP peer is first configured. Sessions are only initiated when the entire configuration for the BGP peer is complete.

When the auto shutdown of BGP neighbors on initial configuration feature is enabled, the value of the shutdown parameter for any existing configured neighbor is not changed. Any new BGP neighbor configured after the feature is enabled has the shutdown state set to the configured value. When the feature is enabled and a new BGP neighbor is configured, the shutdown parameter of the BGP neighbor is automatically set to enabled. When all the BGP neighbor parameters are configured and it is ready to start the establishment of BGP session with the remote peer, the shutdown parameter of the BGP neighbor is then disabled.

Any new neighbor configured and added to a peer group has the shutdown flag enabled by default. Additionally, any new neighbor configured with the autonomous system (AS) in which that remote neighbor resides specified using the **neighbor remote-as** command has the shutdown flag enabled by default.

Configuring auto shutdown of BGP neighbors on initial configuration

Follow this procedure to enable auto shutdown of BGP neighbors on initial configuration.

1. Enter the **configure terminal** command to access global configuration mode.

```
device# configure terminal
```

2. Enter the **router bgp** command to enable BGP routing.

```
device(config)# router bgp
```

3. Enter the **local-as** command to configure the autonomous system number (ASN) in which your device resides.

```
device(config-bgp-router)# local-as 65520
```

4. Enter the **auto-shutdown-new-neighbors** command to prevent the BGP peer from attempting to establish connections with remote peers until all BGP neighbor parameters are configured.

```
device(config-bgp-router)# auto-shutdown-new-neighbors
```

The following example enables auto shutdown of BGP neighbors on initial configuration.

```
device# configure terminal
device(config)# router bgp
device(config-bgp-router)# local-as 65520
device(config-bgp-router)# auto-shutdown-new-neighbors
```

Disabling the BGP4 peer shutdown state

When the auto shutdown of BGP4 neighbors on initial configuration feature is enabled, a BGP4 peer is prevented from attempting to establish connections with remote peers when the BGP4 peer is first configured. Once all of the configuration parameters for the peer are complete, you can start the BGP4 session establishment process and disable the peer shutdown state. Follow this procedure to disable the peer shutdown state.

1. Enter the **configure terminal** command to access global configuration mode.

```
device# configure terminal
```

2. Enter the **router bgp** command to enable BGP routing.
3. Enter the **local-as** command to configure the autonomous system number (ASN) in which your device resides.
4. Enter the **no neighbor shutdown** command, specifying an IP address, to disable the peer shutdown state and begin the BGP4 session establishment process.

Generalized TTL Security Mechanism support

Generalized TTL Security Mechanism (GTSM) is a lightweight security mechanism that protects external Border Gateway Protocol (eBGP) peering sessions from CPU utilization-based attacks using forged IP packets. GTSM prevents attempts to hijack the eBGP peering session by a host on a network segment that is not part of either BGP network, or by a host on a network segment that is not between the eBGP peers.

GTSM is enabled by configuring a minimum Time To Live (TTL) value for incoming IP packets received from a specific eBGP peer. BGP establishes and maintains the session only if the TTL value in the IP packet header is equal to or greater than the TTL value configured for the peering session. If the value is less than the configured value, the packet is silently discarded and no Internet Control Message Protocol (ICMP) message is generated.

In the case of directly connected neighbors, the device expects the BGP control packets received from the neighbor to have a TTL value of either 254 or 255. For multihop peers, the device expects the TTL for BGP control packets received from the neighbor to be greater than or equal to 255, minus the configured number of hops to the neighbor. If the BGP control packets received from the neighbor do not have the expected value, the device drops them.

Assumptions and limitations

- GTSM is supported for both directly connected peering sessions and multihop eBGP peering sessions.
- GTSM is supported for eBGP only.
- GTSM does not protect the integrity of data sent between eBGP peers and does not validate eBGP peers through any authentication method.
- GTSM validates only the locally configured TTL count against the TTL field in the IP packet header.
- GTSM should be configured on each participating device to maximize the effectiveness of this feature.
- When GTSM is enabled, the eBGP session is secured in the incoming direction only and has no effect on outgoing IP packets or the remote device.

Configuring GTSM for BGP4

Generalized TTL Security Mechanism (GTSM) can be configured to protect external Border Gateway Protocol (eBGP) peering sessions.

1. Enter the **configure terminal** command to access global configuration mode.

```
device# configure terminal
```

2. Enter the **router bgp** command to enable BGP routing.

```
device(config)# router bgp
```

3. Enter the **local-as** command to configure the autonomous system number (ASN) in which your device resides.

```
device(config-bgp-router)# local-as 65520
```

4. Enter the **neighbor remote-as** command to add a neighbor.

```
device(config-bgp-router)# neighbor 10.10.10.1 remote-as 2
```

5. Enter the **neighbor ebgp-btsh** command, specifying an IP address, to enable GTSM.

```
device(config-bgp-router)# neighbor 10.10.10.1 ebgp-btsh
```

The following example enables GTSM between a device and a neighbor with the IP address 10.10.10.1.

```
device# configure terminal
device(config)# router bgp
device(config-bgp-router)# local-as 65520
device(config-bgp-router)# neighbor 10.10.10.1 remote-as 2
device(config-bgp-router)# neighbor 10.10.10.1 ebgp-btsh
```

Disabling the BGP AS_PATH check function

A device can be configured so that the AS_PATH check function for routes learned from a specific location is disabled, and routes that contain the recipient BGP speaker's AS number are not rejected.

1. Enter the **configure terminal** command to access global configuration mode.

```
device# configure terminal
```

2. Enter the **router bgp** command to enable BGP routing.

```
device(config)# router bgp
```

3. Enter the **address-family ipv4 unicast** command to enter BGP IPv4 address family unicast configuration mode.

```
device(config-bgp-router)# address-family ipv4 unicast
```

4. Enter the **neighbor allows-in** command and specify a **number** to disable the BGP AS_PATH check function, and specify the number of times that the AS path of a received route may contain the recipient BGP speaker's AS number and still be accepted.

```
device(config-bgp-ipv6u)# neighbor 10.1.1.1 allows-in 3
```

The following example specifies that the AS path of a received route may contain the recipient BGP speaker's AS number three times and still be accepted.

```
device# configure terminal
device(config)# router bgp
device(config-bgp-router)# address-family ipv4 unicast
device(config-bgp-ipv4u)# neighbor 10.1.1.1 allowas-in 3
```

Using route maps

A route map is a named set of match conditions and parameter settings that the device can use to modify route attributes and to control redistribution of the routes into other protocols. A route map consists of a sequence of instances, the equivalent of rows in a table. The device evaluates a route according to route map instances in ascending numerical order. The route is first compared against instance 1, then against instance 2, and so on. When a match is found, the device stops evaluating the route.

- If the route map contains a **permit** statement, a route that matches a match statement is permitted; otherwise, the route is denied.
- If the route map contains a **deny** statement, a route that matches a match statement is denied.
- If a route does not match any **match** statements in the route map, then the route is denied. This is the default action. To change the default action, configure the last **match** statement in the last instance of the route map to **permit any any**.
- If there is no **match** statement, the software considers the route to be a match.

If the route map contains **set** statements, routes that are permitted by the route map **match** statements are modified according to the **set** statements.

Match statements

Match statements compare the route against one or more of the following:

- The route BGP4 MED (metric)
- The IP address of the next hop device
- The route tag
- For OSPF routes only, the route type (internal, external type 1, or external type 2)
- An AS-path access control list (ACL)
- A community ACL
- An IP prefix list
- An extended-community-based ACL

Set statements

For routes that match all of the **match** statements, for all the routes that are permitted by the route-map match statements, the route map **set** statements can perform one or more of the following modifications to the route attributes:

- Prepend AS numbers to the front of the route AS-path. By adding AS numbers to the AS-path, you can cause the route to be less preferred when compared to other routes based on the length of the AS-path.
- Add a user-defined tag or an automatically calculated tag to the route.
- Set the community attributes.
- Set the extended community attributes.
- Set the local preference.
- Set the MED (metric).
- Set the IP address of the next-hop device.

- Set the origin to IGP or INCOMPLETE.
- Set the weight.

When you configure parameters for redistributing routes into BGP4, one of the optional parameters is a route map. If you specify a route map as one of the redistribution parameters, the device matches the route against the match statements in the route map. If a match is found and if the route map contains **set** statements, the device sets the attributes in the route according to the set statements.

Refer to the following commands in the *Brocade SLX-OS Command Reference* for more information on creating and using route maps:

- continue
- match (route-map)
- route-map
- set as-path prepend

Matching on an AS-path

A route map that matches on a specified AS-path access control list (ACL) can be configured.

An AS-path ACL must be configured using the **ip as-path access-list** command.

1. Enter the **configure terminal** command to access global configuration mode.

```
device# configure terminal
```

2. Enter the **route-map** command using the **permit** parameter and specifying a route map name to create a route map instance and allow a matching pattern.

```
device(config)# route-map myaclroutemap1 permit 10
```

3. Enter the **match** command and specify an ACL name to configure the route map to match on the specified AS-path ACL.

```
device(config-route-map-myclroutemap1/permit/10)# match as-path myaspath
```

The following example configures a route map instance that matches on AS-path ACL "myaspath".

```
device# configure terminal
device(config)# route-map myaclroutemap1 permit 10
device(config-route-map-myclroutemap1/permit/10)# match as-path myaspath
```

Matching on a community ACL

A route map instance that matches on a specified community access control list (ACL) can be configured.

1. Enter the **configure terminal** command to access global configuration mode.

```
device# configure terminal
```

2. Enter the **ip community-list standard** command, specifying a community number and using the **permit** parameter to create a community ACL that permits traffic.

```
device(config)# ip community-list standard 1 permit 123:2
```

3. Enter the **route-map** command using the **permit** parameter and specifying a route map name to create a route map instance and allow a matching pattern.

```
device(config)# route-map mycommroutemap1 permit 10
```

4. Enter the **match community** command, and specify a community number to match the BGP community access list name in the configured route-map instance.

```
device(config-route-map-mycommroutemap1/permit/10)# match community 1
```

The following example matches community ACL "1" for route map instance "mycommroutemap1".

```
device# configure terminal
device(config)# ip community-list standard 1 permit 123:2
device(config)# route-map mycommroutemap1 permit 10
device(config-route-map-mycommroutemap1/permit/10)# match community 1
```

Matching on a destination network

A route map that matches on a destination network can be configured.

1. Enter the **configure terminal** command to access global configuration mode.

```
device# configure terminal
```

2. Enter the **route-map** command using the **permit** parameter and specifying a route map name to create a route map instance and allow a matching pattern.

```
device(config)# route-map mynetroutemap1 permit 10
```

3. Enter the **match** command with the **ip address** parameter. Specify a prefix list using the **ip prefix-list string** parameter to configure the route map to match on the specified prefix.

```
device(config-route-map-mynetroutemap1/permit/10)# match ip address prefix-list mylist
```

The following example configures a route map instance that matches on a specified destination network.

```
device# configure terminal
device(config)# route-map mynetroutemap1 permit 10
device(config-route-map-mynetroutemap1/permit/10)# match ip address prefix-list mylist
```

Matching on a BGP4 static network

A route map that matches on a static network can be configured. In this task, a route-map is configured to match on the BGP4 static network. The device is then configured to filter the outgoing route updates to a specified BGP neighbor according to the set of attributes defined in the configured route map.

1. Enter the **configure terminal** command to access global configuration mode.

```
device# configure terminal
```

2. Enter the **route-map** command using the **permit** parameter and specifying a route map name to create a route map instance and allow a matching pattern.

```
device(config)# route-map mystaticroutemap3 permit 1
```

3. Enter the **match** command with the **protocol bgp static-network** parameter to match on BGP4 static network routes.

```
device(config-routemap-mystaticroutemap3/permit/1)# match protocol bgp static-network
```

4. Enter the **set local-preference** command and enter a value to set a BGP local-preference path attribute in the route-map instance.

```
device(config-routemap-mystaticroutemap3/permit/1)# set local-preference 150
```

5. Enter the **set community** command with the **no export** parameter to set the BGP community attribute for the route-map instance not to export to the next AS.

```
device(config-routemap-mystaticroutemap3/permit/1)# set community no-export
```

6. Enter the **exit** command to exit route map configuration mode.

```
device(config-routemap-mystaticroutemap3/permit/1)# exit
```

7. Enter the **router bgp** command to enable BGP routing.

```
device(config)# router bgp
```

8. Enter the **address-family ipv4 unicast** command to enter IPv4 address family configuration mode.

```
device(config-bgp-router)# address-family ipv4 unicast
```

9. Enter the **neighbor ip-address route-map** command and specify the **out** keyword, specifying the route map name, to filter the outgoing route updates to a specified BGP neighbor according to the set of attributes defined in the configured route map.

```
device (config-bgp-ipv4u)# neighbor 10.1.2.3 route-map out mystaticroutemap3
```

The following example configures a route map instance that matches on a BGP4 static network and configures the device to filter the outgoing route updates to a specified BGP neighbor according to the set of attributes defined in the configured route map.

```
device# configure terminal
device(config)# route-map mystaticroutemap3 permit 1
device(config-routemap-mystaticroutemap3/permit/1)# match protocol bgp static-network
device(config-routemap-mystaticroutemap3/permit/1)# set local-preference 150
device(config-routemap-mystaticroutemap3/permit/1)# set community no-export
device(config-routemap-mystaticroutemap3/permit/1)# exit
device(config)# router bgp
device(config-bgp)# address-family ipv4 unicast
device(config-bgp-ipv4u)# neighbor 10.1.2.3 route-map out mystaticroutemap3
```

Matching on a next-hop device

A route map that matches on a next-hop device can be configured.

A prefix list must be configured using the **ip prefix-list** command.

1. Enter the **configure terminal** command to access global configuration mode.

```
device# configure terminal
```

2. Enter the **route-map** command using the **permit** parameter and specifying a route map name to create a route map instance and allow a matching pattern.

```
device(config)# route-map myhoproutemap1 permit 10
```

3. Enter the **match** command, using the **next-hop** parameter and specify a prefix-list, to match IP next-hop match conditions for a specified prefix list in a route-map instance.

```
device(config-route-map-myhoproutemap1/permit/10)# match ip next-hop prefix-list mylist
```

The following example configures a route map and specifies a prefix list to match on a next-hop device.

```
device# configure terminal
device(config)# route-map myhoproutemap1 permit 10
device(config-route-map-myhoproutemap1/permit/10)# match ip next-hop prefix-list mylist
```

Matching on an interface

To configure a route map that matches on an interface:

```
device# configure terminal
device(config)# route-map myintroutemap1 permit 99
device(config-route-map-myintroutemap1/permit/99)# match interface ethernet 0/1 loopback 1
```

Using route-map continue statements

Continuation statements can be configured in a route map. This task configures a route map instance and adds two route-map continue statements to the route map instance.

1. Enter the **configure terminal** command to access global configuration mode.

```
device# configure terminal
```

2. Enter the **route-map** command using the **permit** parameter and specifying a route map name to create a route map instance and allow a matching pattern.

```
device(config)# route-map mcontroutemap1 permit 1
```

3. Enter the **match** command with the metric parameter and specify a value to match a route metric in the route-map instance.

```
device(config-route-map-mcontroutemap1/permit/1)# match metric 10
```

4. Enter the **set weight** command and specify a value to set a BGP weight for the routing table in the route-map instance.

```
device(config-route-map-mcontroutemap1/permit/1)# set weight 10
```

5. Enter the **continue** command and specify a value to configure a route-map instance number that goes in a continue statement in the route-map instance.

```
device(config-routemap-mycontroutemap/permit/1)# continue 2
```

6. Enter the **exit** command to exit route map configuration mode.

```
device(config-routemap-mycontroutemap/permit/1)# exit
```

7. Enter the **route-map** command using the **permit** parameter and specifying a route map name to create a route map instance and allow a matching pattern.

```
device(config)# route-map mcontroutemap1 permit 2
```

- Enter the **match** command with the metric parameter and specify a value to match a route metric in the route-map instance.

```
device(config-route-map-mcontroutemap1/permit/2)# match metric 10
```

- Enter the **set weight** command and specify a value to set a BGP weight for the routing table in the route-map instance.

```
device(config-route-map-mcontroutemap1/permit/2)# set weight 20
```

- Enter the **continue** command and specify a value to configure a route-map instance number that goes in a continue statement in the route-map instance.

```
device(config-routemap-mycontroutemap/permit/2)# continue 3
```

The following example configures a route map instance and adds two route-map continue statements to the route map instance.

```
device# configure terminal
device(config)# route-map mcontroutemap1 permit 1
device(config-routemap-mycontroutemap1/permit/1)# match metric 10
device(config-routemap-mycontroutemap1/permit/1)# set weight 10
device(config-routemap-mycontroutemap1/permit/1)# match metric 10
device(config-routemap-mycontroutemap1/permit/1)# continue 2
device(config-routemap-mycontroutemap1/permit/1)# exit
device(config)# route-map mcontroutemap1 permit 2
device(config-routemap-mycontroutemap1/permit/2)# match tag 10
device(config-routemap-mycontroutemap1/permit/2)# set weight 20
```

Route-map continue statement for BGP4 routes

A continue statement in a route-map directs program flow to skip over route-map instances to another, user-specified instance. If a matched instance contains a continue statement, the system looks for the instance that is identified in the statement.

The continue statement in a matching instance initiates another traversal at the instance specified. The system records all of the matched instances and, if no deny statements are encountered, proceeds to execute the set clauses of the matched instances.

If the system scans all route-map instances but finds no matches, or if a deny condition is encountered, then it does not update the routes. Whenever a matched instance contains a deny statement, the current traversal terminates, and none of the updates specified in the set statements of the matched instances in both current and previous traversals are applied to the routes.

This supports a more programmable route-map configuration and route filtering scheme for BGP4 peering. It can also execute additional instances in a route map after an instance is executed by means of successful match statements. You can configure and organize more-modular policy definitions to reduce the number of instances that are repeated within the same route map.

This feature currently applies to BGP4 routes only. For protocols other than BGP4, continue statements are ignored.

Using a route map to configure dampening

You can set a BGP route-flap dampening penalty in a route-map instance..

- Enter the **configure terminal** command to access global configuration mode.

```
device# configure terminal
```

- Enter the **route-map** command using the **permit** parameter and specifying a route map name to create a route map instance and allow a matching pattern.

```
device(config)# route-map myroutemap permit 1
```

3. Enter the **set dampening** command and specify a value name to set the BGP route-flap dampening penalty for the route-map instance.

```
device(config-route-map-myroutemap/permit/1)# set dampening 20
```

The following example configures a route map instance and sets a BGP route-flap dampening penalty of 20.

```
device# configure terminal
device(config)# route-map myroutemap permit 1
device(config-route-map-myroutemap/permit/1)# set dampening 20
```

Clearing diagnostic buffers

The device stores the following BGP4 diagnostic information in buffers:

- The first 400 bytes of the last packet received that contained an error
- The last NOTIFICATION message either sent or received by the device

This information can be useful if you are working with Brocade Technical Support to resolve a problem. The buffers do not identify the system time when the data was written to the buffer. If you want to ensure that diagnostic data in a buffer is recent, you can clear the buffers. You can clear the buffers for a specific neighbor or for all neighbors.

If you clear the buffer containing the first 400 bytes of the last packet that contained errors, all the bytes are changed to zeros. The Last Connection Reset Reason field of the BGP4 neighbor table also is cleared.

If you clear the buffer containing the last NOTIFICATION message sent or received, the buffer contains no data.

You can clear the buffers for all neighbors, for an individual neighbor, or for all the neighbors within a specific peer group.

Refer to the *Brocade SLX-OS Command Reference* for more information.

Displaying BGP4 statistics

Various **show ip bgp** commands verify information about BGP4 configurations.

Use one or more of the following commands to verify BGP4 information. The commands do not have to be entered in this order.

1. Enter the **show ip bgp summary** command.

```
device# show ip bgp summary

BGP4 Summary
Router ID: 1.1.1.1   Local AS Number: 100
Confederation Identifier: not configured
Confederation Peers:
Maximum Number of IP ECMP Paths Supported for Load Sharing: 64
Number of Neighbors Configured: 65, UP: 65
Number of Routes Installed: 491790, Uses 47211840 bytes
Number of Routes Advertising to All Neighbors: 964418 (45204 entries), Uses 2712240 bytes
Number of Attribute Entries Installed: 130, Uses 13520 bytes
Neighbor Address  AS#      State      Time      Rt:Accepted  Filtered  Sent      ToSend
52.0.0.2          2        ESTAB      5h57m22s  7500         0         7568     0
53.0.0.1          200      ESTAB      5h57m15s  7566         0         15068    0
53.0.1.1          200      ESTAB      5h57m15s  7566         0         15068    0
53.0.2.1          200      ESTAB      5h57m15s  7566         0         15068    0
53.0.3.1          200      ESTAB      5h57m15s  7566         0         15068    0
53.0.4.1          200      ESTAB      5h57m15s  7566         0         15068    0
53.0.5.1          200      ESTAB      5h57m15s  7566         0         15068    0
53.0.6.1          200      ESTAB      5h57m15s  7566         0         15068    0
53.0.7.1          200      ESTAB      5h57m15s  7566         0         15068    0
53.0.8.1          200      ESTAB      5h57m16s  7566         0         15068    0
53.0.9.1          200      ESTAB      5h57m15s  7566         0         15068    0
...
```

This example output gives summarized BGP4 information.

2. Enter the **show ip bgp routes** command.

```
device# show ip bgp routes

Total number of BGP Routes: 491790
Status A:AGGREGATE B:BEST b:NOT-INSTALLED-BEST C:CONFED_EBGP D:DAMPED
E:EBGP H:HISTORY I:IBGP L:LOCAL M:MULTIPATH m:NOT-INSTALLED-MULTIPATH
S:SUPPRESSED F:FILTERED s:STALE
Prefix          Next Hop      MED      LocPrf    Weight  Status
1  1.1.1.1/32    0.0.0.0      0         100      32768  BL
   AS_PATH:
2  2.2.2.2/32    53.0.16.1    0         100      0      BME
   AS_PATH: 200
3  2.2.2.2/32    53.0.17.1    0         100      0      ME
   AS_PATH: 200
4  2.2.2.2/32    53.0.18.1    0         100      0      ME
   AS_PATH: 200
5  2.2.2.2/32    53.0.19.1    0         100      0      ME
   AS_PATH: 200
6  2.2.2.2/32    53.0.20.1    0         100      0      ME
   AS_PATH: 200
7  2.2.2.2/32    53.0.21.1    0         100      0      ME
   AS_PATH: 200
8  2.2.2.2/32    53.0.22.1    0         100      0      ME
   AS_PATH: 200
9  2.2.2.2/32    53.0.23.1    0         100      0      ME
   AS_PATH: 200
...
```

This example shows general BGP4 route information.

3. Enter the **show ip bgp** command.

```
device# show ip bgp

Total number of BGP Routes: 491790
Status codes: s suppressed, d damped, h history, * valid, > best, i internal, S stale
Origin codes: i - IGP, e - EGP, ? - incomplete

```

Network	Next Hop	MED	LocPrf	Weight	Path
*> 1.1.1.1/32	0.0.0.0	0	100	32768	?
*> 2.2.2.2/32	53.0.16.1	0	100	0	200 ?
* 2.2.2.2/32	53.0.17.1	0	100	0	200 ?
* 2.2.2.2/32	53.0.18.1	0	100	0	200 ?
* 2.2.2.2/32	53.0.19.1	0	100	0	200 ?
* 2.2.2.2/32	53.0.20.1	0	100	0	200 ?
* 2.2.2.2/32	53.0.21.1	0	100	0	200 ?
* 2.2.2.2/32	53.0.22.1	0	100	0	200 ?
* 2.2.2.2/32	53.0.23.1	0	100	0	200 ?
* 2.2.2.2/32	53.0.24.1	0	100	0	200 ?
* 2.2.2.2/32	53.0.25.1	0	100	0	200 ?
* 2.2.2.2/32	53.0.26.1	0	100	0	200 ?
* 2.2.2.2/32	53.0.27.1	0	100	0	200 ?
* 2.2.2.2/32	53.0.28.1	0	100	0	200 ?
* 2.2.2.2/32	53.0.29.1	0	100	0	200 ?
* 2.2.2.2/32	53.0.30.1	0	100	0	200 ?
* 2.2.2.2/32	53.0.31.1	0	100	0	200 ?
* 2.2.2.2/32	53.0.8.1	0	100	0	200 ?

...

This example shows general BGP4 information.

4. Enter the **show ip bgp attribute-entries** command.

```
device# show ip bgp attribute-entries

Total number of BGP Attribute Entries: 130
1      Next Hop : 53.0.38.1      MED :0      Origin:INCOMP
      Originator:0.0.0.0      Cluster List:None
      Aggregator:AS Number :0      Router-ID:0.0.0.0      Atomic:None
      Local Pref:100      Communities:Internet
      AS Path :200 (length 3)
      AsPathLen: 1 AsNum: 1, SegmentNum: 1, Neighboring As: 200, Source As 200
      Address: 0x645146ec Hash:255 (0x03000292)
      Links: 0x64514e5c, 0x00000000
      Reference Counts: 66:0:0, Magic: 53
2      Next Hop : 53.0.39.1      MED :0      Origin:IGP
      Originator:0.0.0.0      Cluster List:None
      Aggregator:AS Number :0      Router-ID:0.0.0.0      Atomic:None
      Local Pref:100      Communities:Internet
      AS Path :200 1 (length 5)
      AsPathLen: 2 AsNum: 2, SegmentNum: 1, Neighboring As: 200, Source As 1
      Address: 0x64514e5c Hash:255 (0x0100039a)
      Links: 0x6451635c, 0x645146ec
      Reference Counts: 7500:0:0, Magic: 70
...
```

This example shows information about one route-attribute entry that is stored in device memory.

5. Enter the **show ip bgp peer-group** command.

```
device# show ip bgp peer-group

1  BGP peer-group is pg_vrf10, Remote AS: 4001183001
   Description: bgp_vrf4@-4001183001
   MD5 Password: $MiJTfXJVRzMxTTNRUVpaVzhRUVo=
   Address family : IPV4 Unicast
   activate
   Address family : IPV6 Unicast
   no activate
   Currently there are no members.

2  BGP peer-group is pg_vrf11, Remote AS: 4001183011
   Description: bgp_vrf4@-4001183011
   MD5 Password: $MiJTfXJVRzMxTTNRUVpaVzhRWlo=
   Address family : IPV4 Unicast
   activate
   Address family : IPV6 Unicast
   no activate
   Currently there are no members.
```

This example shows output for two BGP peer groups, called "pg" and "pg6".

6. Enter the **show ip bgp routes** command using the **summary** keyword.

```
device# show ip bgp routes summary

Total number of BGP routes (NLRIs) Installed      : 491790
Distinct BGP destination networks                 : 15068
Filtered bgp routes for soft reconfig             : 0
Routes originated by this router                   : 66
Routes selected as BEST routes                    : 15068
Routes Installed as BEST routes                   : 15068
BEST routes not installed in IP forwarding table  : 0
Static routes not installed in IP forwarding table : 0
Unreachable routes (no IGP route for NEXTHOP)    : 0
IBGP routes selected as best routes               : 0
EBGP routes selected as best routes               : 15002
BEST routes not valid for IP forwarding table     : 0
```

This example shows summarized BGP4 route information.

Displaying BGP4 neighbor statistics

Various **show ip bgp neighbor** commands verify information about BGP4 neighbor configurations.

Use one or more of the following commands to verify BGP4 neighbor information. The commands do not have to be entered in this order.

1. Enter the **show ip bgp neighbors** command.

```

device# show ip bgp neighbors

Total number of BGP routes (NLRIs) Installed      : 491790
Distinct BGP destination networks                 : 15068
Filtered bgp routes for soft reconfig             : 0
Routes originated by this router                  : 66
Routes selected as BEST routes                   : 15068
Routes Installed as BEST routes                   : 15068
BEST routes not installed in IP forwarding table  : 0
Static routes not installed in IP forwarding table : 0
Unreachable routes (no IGP route for NEXTHOP)   : 0
IBGP routes selected as best routes              : 0
EBGP routes selected as best routes              : 15002
BEST routes not valid for IP forwarding table     : 0
F115# show ip bgp neighbors
Total number of BGP Neighbors: 65
1  IP Address: 52.0.0.2, AS: 2 (EBGP), RouterID: 192.0.137.54, VRF: default-vrf
State: ESTABLISHED, Time: 6h5m58s, KeepAliveTime: 30, HoldTime: 90
  KeepAliveTimer Expire in 8 seconds, HoldTimer Expire in 63 seconds
Minimal Route Advertisement Interval: 0 seconds
  GracefulRestartCapability: Received
    Restart Time 90 sec, Restart bit 0
    afi/safi 1/1, Forwarding bit 0
  GracefulRestartCapability: Sent
    Restart Time 120 sec, Restart bit 0
    afi/safi 1/1, Forwarding bit 0
Messages:   Open      Update  KeepAlive  Notification  Refresh-Req
Sent       : 1        28      817        0              0
Received: 1         9       733        0              0
Last Update Time: NLRI                               Withdraw      NLRI                               Withdraw
                  Tx: 6h5m55s                        ---            Rx: 6h5m57s                        ---
Last Connection Reset Reason:Unknown
Notification Sent:      Unspecified
Notification Received: Unspecified
Neighbor NLRI Negotiation:
  Peer Negotiated IPV4 unicast capability
  Peer configured for IPV4 unicast Routes
Neighbor AS4 Capability Negotiation:
Outbound Policy Group:
  ID: 2, Use Count: 65
  Last update time was 21972 sec ago
BFD:Disabled
Byte Sent: 47157, Received: 0
Local host: 52.0.0.1, Local Port: 179
Remote host: 52.0.0.2, Remote Port: 61808

2  IP Address: 53.0.0.1, AS: 200 (EBGP), RouterID: 2.2.2.2, VRF: default-vrf
State: ESTABLISHED, Time: 6h5m56s, KeepAliveTime: 60, HoldTime: 180
  KeepAliveTimer Expire in 0 seconds, HoldTimer Expire in 125 seconds
Minimal Route Advertisement Interval: 0 seconds
  RefreshCapability: Received
  GracefulRestartCapability: Received
    Restart Time 120 sec, Restart bit 0
    afi/safi 1/1, Forwarding bit 0
  GracefulRestartCapability: Sent
    Restart Time 120 sec, Restart bit 0
    afi/safi 1/1, Forwarding bit 0
Messages:   Open      Update  KeepAlive  Notification  Refresh-Req
Sent       : 1        46      414        0              0
Received: 1         45      411        0              0
Last Update Time: NLRI                               Withdraw      NLRI                               Withdraw
                  Tx: 6h5m56s                        ---            Rx: 6h5m51s                        6h5m55s
Last Connection Reset Reason:Unknown
Notification Sent:      Unspecified
Notification Received: Unspecified
Neighbor NLRI Negotiation:

```

```

Peer Negotiated IPV4 unicast capability
Peer configured for IPV4 unicast Routes
Neighbor AS4 Capability Negotiation:
Outbound Policy Group:
  ID: 2, Use Count: 65
  Last update time was 21977 sec ago
BFD:Disabled
Byte Sent: 70268, Received: 0
Local host: 53.0.0.2, Local Port: 8128
Remote host: 53.0.0.1, Remote Port: 179

```

This example output gives general information about BGP4 neighbors.

2. Enter the **show ip bgp neighbors advertised-routes** command.

```

device# show ip bgp neighbors 52.0.0.2 advertised-routes

      There are 7568 routes advertised to neighbor 52.0.0.2
Status A:AGGREGATE B:BEST b:NOT-INSTALLED-BEST E:EBGP I:IBGP L:LOCAL
Prefix      Next Hop      MED      LocPrf      Weight  Status
1    101.0.0.0/24    52.0.0.1    none      0          BME
   AS_PATH: 100 200 1
2    101.0.1.0/24    52.0.0.1    none      0          BME
   AS_PATH: 100 200 1
3    101.0.2.0/24    52.0.0.1    none      0          BME
   AS_PATH: 100 200 1
4    101.0.3.0/24    52.0.0.1    none      0          BME
   AS_PATH: 100 200 1
5    101.0.4.0/24    52.0.0.1    none      0          BME
   AS_PATH: 100 200 1
6    101.0.5.0/24    52.0.0.1    none      0          BME
   AS_PATH: 100 200 1
7    101.0.6.0/24    52.0.0.1    none      0          BME
   AS_PATH: 100 200 1
8    101.0.7.0/24    52.0.0.1    none      0          BME
   AS_PATH: 100 200 1
9    101.0.8.0/24    52.0.0.1    none      0          BME
   AS_PATH: 100 200 1
10   101.0.9.0/24    52.0.0.1    none      0          BME
   AS_PATH: 100 200 1
...

```

This example shows information about all the routes the BGP4 networking device advertised to the neighbor.

3. Enter the **show ip bgp neighbors last-packet-with-error** command.

```

device# show ip bgp neighbors 118.113.0.1 last-packet-with-error

Received Message Length: 19
BGP Message:
 0xffffffff 0xffffffff 0xffffffff 0xffffffff 0x001304

BGP Header
Marker: 0xffffffff 0xffffffff 0xffffffff 0xffffffff
Message Length: (0x0013) 19
Message Type: (0x04) KEEPALIVE

```

This example shows information about the last packet that contained an error from any of a device's neighbors.

4. Enter the **show ip bgp neighbors received-routes** command.

```

device# show ip bgp neighbors 118.113.0.1 received-routes

      There are 106 received routes from neighbor 118.113.0.1
Status A:AGGREGATE B:BEST b:NOT-INSTALLED-BEST C:CONFED_EBGP D:DAMPED
      E:EBGP H:HISTORY I:IBGP L:LOCAL M:MULTIPATH m:NOT-INSTALLED-MULTIPATH
      S:SUPPRESSED F:FILTERED s:STALE
Prefix      Next Hop      MED      LocPrf      Weight  Status
 1  101.34.0.0/24    118.113.0.1    none      100         0       E
      AS_PATH: 118 2
 2  102.34.0.0/24    118.113.0.1    none      100         0       E
      AS_PATH: 118 2
 3  112.113.114.0/28 118.113.0.1    none      100         0       E
      AS_PATH: 118 2
 4  114.4.1.0/31     118.113.0.1    none      100         0       E
      AS_PATH: 118 2
 5  114.114.114.114/32 118.113.0.1    none      100         0       E
      AS_PATH: 118 2
 6  118.114.0.0/31   118.113.0.1    none      100         0       E
      AS_PATH: 118 2
 7  119.219.32.0/20  118.113.0.1    1         100         0       BE
      AS_PATH: 118
 8  119.219.48.0/20  118.113.0.1    1         100         0       BE
      AS_PATH: 118
 9  119.219.64.0/20  118.113.0.1    1         100         0       BE
      AS_PATH: 118
10  119.219.80.0/20  118.113.0.1    1         100         0       BE
      AS_PATH: 118

```

This example lists all route information received in route updates from BGP4 neighbors of the device since the soft-reconfiguration feature was enabled.

5. Enter the **show ip bgp neighbors rib-out-routes** command.

```

device# show ip bgp neighbors 53.0.5.1 rib-out-routes

      There are 15068 RIB_out routes for neighbor 53.0.5.1
Status A:AGGREGATE B:BEST b:NOT-INSTALLED-BEST E:EBGP I:IBGP L:LOCAL
Prefix      Next Hop      MED      LocPrf      Weight  Status
 1  101.0.0.0/24     53.0.16.1     none      100         0       BME
      AS_PATH: 200 1
 2  101.0.1.0/24     53.0.16.1     none      100         0       BME
      AS_PATH: 200 1
 3  101.0.2.0/24     53.0.16.1     none      100         0       BME
      AS_PATH: 200 1
 4  101.0.3.0/24     53.0.16.1     none      100         0       BME
      AS_PATH: 200 1
 5  101.0.4.0/24     53.0.16.1     none      100         0       BME
      AS_PATH: 200 1
 6  101.0.5.0/24     53.0.16.1     none      100         0       BME
      AS_PATH: 200 1
 7  101.0.6.0/24     53.0.16.1     none      100         0       BME
      AS_PATH: 200 1
 8  101.0.7.0/24     53.0.16.1     none      100         0       BME
      AS_PATH: 200 1
 9  101.0.8.0/24     53.0.16.1     none      100         0       BME
      AS_PATH: 200 1
10  101.0.9.0/24     53.0.16.1     none      100         0       BME
      AS_PATH: 200 1
...

```

This example shows information about BGP4 outbound RIB routes.

Clearing BGP4 dampened paths

BGP4 suppressed routes can be reactivated using a CLI command.

The **show ip bgp dampened-paths** command is entered to verify that there are BGP4 dampened routes. The **clear ip bgp dampening** command is entered to reactivate all suppressed BGP4 routes. The **show ipv6 bgp dampened-paths** command is re-entered to verify that the suppressed BGP4 routes have been reactivated.

1. Enter the **exit** command until you return to Privileged EXEC mode.

```
device(config)# exit
```

2. Enter the **show ip bgp dampened-paths** command to display all BGP4 dampened routes.

```
device# show ip bgp dampened-paths

      Status Code >:best d:damped h:history *:valid
      Network          From          Flp Since          Reuse          Pnlty rIdx dBlk
*d 101.0.99.0/24      12.12.1.2          3 0 :1 :34          0 :29:0          2818 5 0
*d 101.0.98.0/24      12.12.1.2          3 0 :1 :34          0 :29:0          2818 5 0
*d 101.0.97.0/24      12.12.1.2          3 0 :1 :34          0 :29:0          2818 5 0
*d 101.0.96.0/24      12.12.1.2          3 0 :1 :34          0 :29:0          2818 5 0
*d 101.0.95.0/24      12.12.1.2          3 0 :1 :34          0 :29:0          2818 5 0
*d 101.0.94.0/24      12.12.1.2          3 0 :1 :34          0 :29:0          2818 5 0
*d 101.0.93.0/24      12.12.1.2          3 0 :1 :34          0 :29:0          2818 5 0
*d 101.0.92.0/24      12.12.1.2          3 0 :1 :34          0 :29:0          2818 5 0
*d 101.0.91.0/24      12.12.1.2          3 0 :1 :34          0 :29:0          2818 5 0
*d 101.0.90.0/24      12.12.1.2          3 0 :1 :34          0 :29:0          2818 5 0
*d 101.0.89.0/24      12.12.1.2          3 0 :1 :34          0 :29:0          2818 5 0
*d 101.0.88.0/24      12.12.1.2          3 0 :1 :34          0 :29:0          2818 5 0
*d 101.0.87.0/24      12.12.1.2          3 0 :1 :34          0 :29:0          2818 5 0
*d 101.0.86.0/24      12.12.1.2          3 0 :1 :34          0 :29:0          2818 5 0
*d 101.0.85.0/24      12.12.1.2          3 0 :1 :34          0 :29:0          2818 5 0
```

3. Enter the **clear ip bgp dampening** command to reactivate all suppressed BGP4 routes.

```
device# clear ip bgp dampening
```

4. Enter the **show ip bgp dampened-paths** command to verify that there are no BGP4 dampened routes.

```
device# show ip bgp dampened-paths
device#
```

The following example reactivates all suppressed BGP4 routes and verifies that there are no suppressed routes.

```
device(config-bgp-router)# exit
device(config)# exit
device# show ip bgp dampened-paths
device# clear ip bgp dampening
device# show ip bgp dampened-paths
```

BGP4+

• BGP4+ overview.....	151
• BGP global mode	151
• IPv6 unicast address family.....	152
• BGP4+ neighbors.....	153
• BGP4+ peer groups.....	155
• Enabling ASN capability globally.....	157
• Enabling ASN capability for a BGP4+ neighbor.....	157
• Importing routes into BGP4+.....	158
• Advertising the default BGP4+ route.....	159
• Advertising the default BGP4+ route to a specific neighbor.....	159
• Using the IPv6 default route as a valid next hop for a BGP4+ route.....	160
• BGP4+ next hop recursion.....	160
• BGP4+ NLRIs and next hop attributes.....	161
• BGP4+ route reflection.....	162
• BGP4+ route aggregation.....	163
• BGP4+ multipath.....	164
• Route maps.....	165
• Redistributing prefixes into BGP4+.....	166
• Redistributing routes into BGP4+.....	167
• Specifying the weight added to BGP4+ received routes.....	167
• Enabling BGP4+ in a non-default VRF.....	168
• BGP4+ outbound route filtering.....	168
• BGP4+ confederations.....	170
• Auto shutdown of BGP neighbors on initial configuration.....	171
• Generalized TTL Security Mechanism support.....	172
• Disabling the BGP AS_PATH check function.....	173
• Displaying BGP4+ statistics.....	174
• Displaying BGP4+ neighbor statistics.....	176
• Clearing BGP4+ dampened paths.....	178

BGP4+ overview

The implementation of IPv6 supports multiprotocol BGP (MBGP) extensions that allow Border Gateway Protocol version 4 plus (BGP4+) to distribute routing information. BGP4+ supports all of the same features and functionality as IPv4 BGP (BGP4).

IPv6 MBGP enhancements include:

- An IPv6 unicast address family and network layer reachability information (NLRI)
- Next hop attributes that use IPv6 addresses

BGP global mode

Configurations that are not specific to address family configuration are available in the BGP global configuration mode.

```
device(config-bgp-router)# ?
```

```
Possible completions:
```

```
address-family
```

```
Enter Address Family command mode
```

always-compare-med	Allow comparing MED from different neighbors
as-path-ignore	Ignore AS_PATH length for best route selection
auto-shutdown-new-neighbors	Auto shutdown new neighbor
bfd	Set BFD global parameters for BGP
capability	Set capability
cluster-id	Configure Route-Reflector Cluster-ID
compare-med-empty-aspath	Allow comparing MED from different neighbors even with empty as-path attribute
compare-routerid	Compare router-id for identical BGP paths
confederation	Configure AS confederation parameters
default-local-preference	Configure default local preference value
describe	Display transparent command information
distance	Define an administrative distance
enforce-first-as	Enforce the first AS for EBGp routes
fast-external-fallover	Reset session if link to EBGp peer goes down
install-igp-cost	Install igp cost to nexthop instead of MED value as BGP route cost
local-as	Configure local AS number
log-dampening-debug	Log dampening debug messages
maxas-limit	Impose limit on number of ASes in AS-PATH attribute
med-missing-as-worst	Consider routes missing MED attribute atleast desirable
neighbor	Specify a neighbor router
timers	Adjust routing timers

The following neighbor configuration options are allowed under BGP global configuration mode:

```
device(config-bgp-router)# neighbor 2001:2018:8192::125 ?
```

Possible completions:

advertisement-interval	Minimum interval between sending BGP routing updates
as-override	Override matching AS-number while sending update
bfd	Enable BFD session for the neighbor
capability	Advertise capability to the peer
description	Neighbor by description
ebgp-btsh	Enable EBGp TTL Security Hack Protection
ebgp-multihop	Allow EBGp neighbors not on directly connected networks
enforce-first-as	Enforce the first AS for EBGp routes
local-as	Assign local-as number to neighbor
maxas-limit	Impose limit on number of ASes in AS-PATH attribute
next-hop-self	Disable the next hop calculation for this neighbor
password	Enable TCP-MD5 password protection
peer-group	Create Peer Group
remote-as	Specify a BGP neighbor
remove-private-as	Remove private AS number from outbound updates
shutdown	Administratively shut down this neighbor
soft-reconfiguration	Per neighbor soft reconfiguration
static-network-edge	Neighbor as special service edge, static-network shall not be advertised if installed as DROP
timers	BGP per neighbor timers
update-source	Source of routing updates

IPv6 unicast address family

The IPv6 unicast address family configuration level provides access to commands that allow you to configure BGP4+ unicast routes. The commands that you enter at this level apply only to the IPv6 unicast address family.

BGP4+ supports the IPv6 address family configuration level.

The commands that you can access while at the IPv6 unicast address family configuration level are also available at the IPv4 unicast address family configuration levels. Each address family configuration level allows you to access commands that apply to that particular address family only.

The following configuration options are allowed under BGP IPv6 address family unicast mode:

The following neighbor configuration options are allowed under BGP IPv6 address family unicast mode:

```
device(config-bgp-ipv6u)# neighbor 2001:2018:8192::125 ?

Possible completions:
  activate                Allow exchange of route in the current family mode
  allowas-in              Disables the AS_PATH check of the routes learned
                          from the AS
  capability               Advertise capability to the peer
  default-originate       Originate default route to peer
  filter-list              Establish BGP filters
  maximum-prefix           Maximum number of prefix accept from this peer
  prefix-list              Prefix List for filtering routes
  route-map                Apply route map to neighbor
  route-reflector-client  Configure a neighbor as Route Reflector client
  send-community           Send community attribute to this neighbor
  unsuppress-map           Route-map to selectively unsuppress suppressed
                          routes
  weight                  Set default weight for routes from this neighbor
```

BGP4+ neighbors

BGP4+ neighbors can be configured using link-local addresses or global addresses.

BGP4+ neighbors can be created using link-local addresses for peers in the same link. For link-local peers, the neighbor interface over which the neighbor and local device exchange prefixes is specified through the **neighbor update-source** command, and a route map is configured to set up a global next hop for packets destined for the neighbor.

To configure BGP4+ neighbors that use link-local addresses, you must do the following:

- Add the IPv6 address of a neighbor in a remote autonomous system (AS) to the BGP4+ neighbor table of the local device.
- Identify the neighbor interface over which the neighbor and local device will exchange prefixes using the **neighbor update-source** command.
- Configure a route map to set up a global next hop for packets destined for the neighbor.

The neighbor should be activated in the IPv6 address family configuration mode using the **neighbor activate** command.

BGP4+ neighbors can also be configured using a global address. The global IPv6 address of a neighbor in a remote AS must be added, and the neighbor should be activated in the IPv6 address family configuration mode using the **neighbor activate** command.

Configuring BGP4+ neighbors using global IPv6 addresses

BGP4+ neighbors can be configured using global IPv6 addresses.

1. Enter the **configure terminal** command to access global configuration mode.

```
device# configure terminal
```

2. Enter the **router bgp** command to enable BGP routing.

```
device(config)# router bgp
```

3. Enter the **local-as** command to configure the autonomous system number (ASN) in which your device resides.

```
device(config-bgp-router)# local-as 1000
```

4. Enter the **neighbor remote-as** command, specifying an IPv6 address, to specify the ASN in which the remote neighbor resides.

```
device(config-bgp-router)# neighbor 2001:db8:93e8:cc00::1 remote-as 1001
```

5. Enter the **address family ipv6 unicast** command to enter IPv6 address family configuration mode.

```
device(config-bgp-router)# address-family ipv6 unicast
```

6. Enter the **neighbor activate** command to enable the exchange of information with the neighbor.

```
device(config-bgp-ipv6u)# neighbor 2001:db8:93e8:cc00::1 activate
```

The following example configures a neighbor using a global IPv6 address.

```
device# configure terminal
device(config)# router bgp
device(config-bgp-router)# local-as 1000
device(config-bgp-router)# neighbor 2001:db8:93e8:cc00::1 remote-as 1001
device(config-bgp-router)# address-family ipv6 unicast
device(config-bgp-ipv6u)# neighbor 2001:db8:93e8:cc00::1 activate
```

Configuring BGP4+ neighbors using link-local addresses

BGP4+ neighbors can be configured using link-local addresses.

1. Enter the **configure terminal** command to access global configuration mode.

```
device# configure terminal
```

2. Enter the **router bgp** command to enable BGP routing.

```
device(config)# router bgp
```

3. Enter the **local-as** command to configure the autonomous system number (ASN) in which your device resides.

```
device(config-bgp-router)# local-as 1000
```

4. Enter the **neighbor remote-as** command, specifying an IPv6 address, to specify the ASN in which the remote neighbor resides.

```
device(config-bgp-router)# neighbor fe80:4398:ab30:45de::1 remote-as 1001
```

5. Enter the **neighbor update-source** command to specify an interface.

```
device(config-bgp-router)# neighbor fe80:4398:ab30:45de::1 update-source ethernet 0/1
```

6. Enter the **address-family ipv6 unicast** command to enter IPv6 address family configuration mode.

```
device(config-bgp-router)# address-family ipv6 unicast
```

7. Enter the **neighbor activate** command to enable the exchange of information with the neighbor.

```
device(config-bgp-ipv6u)# neighbor fe80:4398:ab30:45de::1 activate
```

8. Enter the **neighbor route-map** command and specify the **out** keyword to apply a route map to outgoing routes.

```
device(config-bgp-ipv6u)# neighbor fe80:4398:ab30:45de::1 route-map out myroutemap
```

9. Enter the **exit** command until you return to global configuration mode.

```
device(config-bgp-ipv6u)# exit
```

10. Enter the **route-map name permit** command to define the route map and enter route map configuration mode.

```
device(config)# route-map myroutemap permit 10
```

11. Enter the **set ipv6 next-hop** command and specify an IPv6 address to set the IPv6 address of the next hop.

```
device(config-routemapmap-myroumap/permit/10)# set ipv6 next-hop 2001::10
```

The following example configures a neighbor using a link-local address and configures a route map to set up a global next hop for packets destined for the neighbor.

```
device# configure terminal
device(config)# router bgp
device(config-bgp-router)# local-as 1000
device(config-bgp-router)# neighbor fe80:4398:ab30:45de::1 remote-as 1001
device(config-bgp-router)# neighbor fe80:4398:ab30:45de::1 update-source ethernet 0/1
device(config-bgp-router)# address-family ipv6 unicast
device(config-bgp-ipv6u)# neighbor fe80:4398:ab30:45de::1 activate
device(config-bgp-ipv6u)# neighbor fe80:4398:ab30:45de::1 route-map out myroumap
device(config-bgp-ipv6u)# exit
device(config)# route-map myroumap permit 10
device(config-routemapmap-myroumap/permit/10)# set ipv6 next-hop 2001::10
```

BGP4+ peer groups

Neighbors having the same attributes and parameters can be grouped together by means of the **neighbor peer-group** command.

You must first create a peer group, after which you can associate neighbor IPv6 addresses with the peer group. All of the attributes that are allowed on a neighbor are allowed on a peer group as well.

BGP4+ peers and peer groups are activated in the IPv6 address family configuration mode to establish the BGP4+ peering sessions.

An attribute value configured explicitly for a neighbor takes precedence over the attribute value configured on the peer group. In the case where neither the peer group nor the individual neighbor has the attribute configured, the default value for the attribute is used.

NOTE

BGP4 neighbors are established and the prefixes are advertised using the **neighbor IP address remote-as** command in router BGP mode. However, when establishing BGP4+ peer sessions and exchanging IPv6 prefixes, neighbors must also be activated using the **neighbor IPv6 address activate** command in IPv6 address family configuration mode.

Configuring BGP4+ peer groups

A peer group can be created and neighbor IPv6 addresses can be associated with the peer group. The peer group is then activated in the IPv6 address family configuration mode.

1. Enter the **configure terminal** command to access global configuration mode.

```
device# configure terminal
```

2. Enter the **router bgp** command to enable BGP routing.

```
device(config)# router bgp
```

3. Enter the **local-as** command to configure the autonomous system number (ASN) in which your device resides.

```
device(config-bgp-router)# local-as 1000
```

4. Enter the **neighbor peer-group** command to create a peer group.

```
device(config-bgp-router)# neighbor mypeergr01 peer-group
```

5. Enter the **neighbor remote-as** command, specifying a peer group, to specify the ASN of the peer group.

```
device(config-bgp-router)# neighbor mypeergroup1 remote-as 11
```

6. Enter the **neighbor peer-group** command to associate a neighbor with the peer group.

```
device(config-bgp-router)# neighbor 2001:2018:8192::125 peer-group mypeergroup1
```

7. Enter the **neighbor peer-group** command to associate another neighbor with the peer group.

```
device(config-bgp-router)# neighbor 2001:2018:8192::124 peer-group mypeergroup1
```

8. Enter the **address-family ipv6 unicast** command to enter IPv6 address family configuration mode.

```
device(config-bgp-router)# address-family ipv6 unicast
```

9. Enter the **neighbor activate** command to establish an IPv6 BGP session with the peer group.

```
device(config-bgp-ipv6u)# neighbor mypeergroup1 activate
```

The following example creates a peer group, specifying two neighbors to belong to the peer group, and activates the peer group.

```
device# configure terminal
device(config)# router bgp
device(config-bgp-router)# local-as 1000
device(config-bgp-router)# neighbor mypeergroup1 peer-group
device(config-bgp-router)# neighbor mypeergroup1 remote-as 11
device(config-bgp-router)# neighbor 2001:2018:8192::125 peer-group mypeergroup1
device(config-bgp-router)# neighbor 2001:2018:8192::124 peer-group mypeergroup1
device(config-bgp-router)# address-family ipv6 unicast
device(config-bgp-ipv6u)# neighbor mypeergroup1 activate
```

Configuring a peer group with IPv4 and IPv6 peers

A peer group that contains both IPv4 and IPv6 peers can be configured.

1. Enter the **configure terminal** command to access global configuration mode.

```
device# configure terminal
```

2. Enter the **router bgp** command to enable BGP routing.

```
device(config)# router bgp
```

3. Enter the **local-as** command to configure the autonomous system number (ASN) in which your device resides.

```
device(config-bgp-router)# local-as 1000
```

4. Enter the **neighbor peer-group** command, specifying a peer group, to create a peer group.

```
device(config-bgp-router)# neighbor p1 peer-group
```

5. Enter the **neighbor remote-as** command to specify the ASN of the peer group.

```
device(config-bgp-router)# neighbor p1 remote-as 11
```

6. Enter the **neighbor peer-group** command, specifying an IPv6 address, to associate a neighbor with the peer group.

```
device(config-bgp-router)# neighbor 2001:2018:8192::124 peer-group p1
```

7. Enter the **neighbor peer-group** command, specifying a different IPv6 address, to associate another neighbor with the peer group.

```
device(config-bgp-router)# neighbor 10.0.0.1 peer-group p1
```

8. Enter the **address-family ipv6 unicast** command to enter IPv6 address family configuration mode.

```
device(config-bgp-router)# address-family ipv6 unicast
```

9. Enter the **neighbor activate** command to establish an IPv6 BGP session with the peer group.

```
device(config-bgp-ipv6u)# neighbor p1 activate
```

The following example creates a peer group with both IPv6 and IPv4 peers and activates the peer group in the IPv6 address family.

```
device# configure terminal
device(config)# router bgp
device(config-bgp-router)# local-as 1000
device(config-bgp-router)# neighbor p1 peer-group
device(config-bgp-router)# neighbor p1 remote-as 11
device(config-bgp-router)# neighbor 2001:2018:8192::124 peer-group p1
device(config-bgp-router)# neighbor 10.0.0.1 peer-group p1
device(config-bgp-router)# address-family ipv6 unicast
device(config-bgp-ipv6u)# neighbor p1 activate
```

Enabling ASN capability globally

Four-byte autonomous system numbers (ASNs) can be configured on a device. The following task enables 4-byte autonomous system number (ASN) capability at the BGP global level.

1. Enter the **configure terminal** command to access global configuration mode.

```
device# configure terminal
```

2. Enter the **router bgp** command to enable BGP routing.

```
device(config)# router bgp
```

3. Enter the **capability as4-enable** command to enable 4-byte autonomous system number (ASN) capability globally.

```
device(config-bgp-router)# capability as4-enable
```

The following example enables 4-byte autonomous system number (ASN) capability globally.

```
device# configure terminal
device(config)# router bgp
device(config-bgp-router)# capability as4-enable
```

Enabling ASN capability for a BGP4+ neighbor

Four-byte autonomous system numbers (ASNs) can be configured for a neighbor or peer-group. The following task enables 4-byte autonomous system number (ASN) capability for a BGP4+ neighbor.

1. Enter the **configure terminal** command to access global configuration mode.

```
device# configure terminal
```

2. Enter the **router bgp** command to enable BGP routing.

```
device(config)# router bgp
```

3. Enter the **local-as** command to configure the autonomous system number (ASN) in which your device resides.

```
device(config-bgp-router)# local-as 1000
```

4. Enter the **neighbor capability as4** command with the **enable** parameter, and specify an IPv6 address, to enable 4-byte autonomous system number (ASN) capability for a specific neighbor.

```
device(config-bgp-router)# neighbor 2001:db8:93e8:cc00::1 capability as4 enable
```

The following example enables 4-byte autonomous system number (ASN) capability for a specific BGP4+ neighbor.

```
device# configure terminal
device(config)# router bgp
device(config-bgp-router)# local-as 1000
device(config-bgp-router)# neighbor 2001:db8:93e8:cc00::1 capability as4 enable
```

Importing routes into BGP4+

Routes can be explicitly specified for advertisement by BGP.

The routes imported into BGP4+ must first exist in the IPv6 unicast route table.

1. Enter the **configure terminal** command to access global configuration mode.

```
device# configure terminal
```

2. Enter the **router bgp** command to enable BGP routing.

```
device(config)# router bgp
```

3. Enter the **neighbor remote-as** command, specifying an IPv6 address, to specify the ASN in which the remote neighbor resides.

```
device(config-bgp-router)# neighbor fe80:4398:ab30:45de::1 remote-as 1001
```

4. Enter the **address-family ipv6 unicast** command to enter IPv6 address family configuration mode.

```
device(config-bgp-router)# address-family ipv6 unicast
```

5. Enter the **network** command and specify a *network/mask* to import the specified prefix into the BGP4+ database.

```
device(config-bgp-ipv6u)# network 2001:db8::/32
```

The following example imports the 2001:db8::/32 prefix in to the BGP4+ database for advertising.

```
device# configure terminal
device(config)# router bgp
device(config-bgp-router)# neighbor fe80:4398:ab30:45de::1 remote-as 1001
device(config-bgp-router)# address-family ipv6 unicast
device(config-bgp-ipv6u)# network 2001:db8::/32
```

Advertising the default BGP4+ route

A BGP device can be configured to advertise the default IPv6 route to all BGP4+ neighbors and to install that route in the local BGP4+ route table.

The default route must be present in the local IPv6 route table.

1. Enter the **configure terminal** command to access global configuration mode.

```
device# configure terminal
```

2. Enter the **router bgp** command to enable BGP routing.

```
device(config)# router bgp
```

3. Enter the **address-family ipv6 unicast** command to enter IPv6 address family unicast configuration mode.

```
device(config-bgp-router)# address-family ipv6 unicast
```

4. Enter the **default-information-originate** command to advertise the default IPv6 route to all BGP4+ neighbors and to install that route in the local BGP4+ route table.

```
device(config-bgp-ipv6u)# default-information-originate
```

The following example enables a BGP4+ device to advertise the default IPv6 route to all BGP4+ neighbors and to install that route in the local BGP4+ route table.

```
device# configure terminal
device(config)# router bgp
device(config-bgp-router)# address-family ipv6 unicast
device(config-bgp-ipv6u)# default-information-originate
```

Advertising the default BGP4+ route to a specific neighbor

A BGP device can be configured to advertise the default IPv6 route to a specific neighbor.

1. Enter the **configure terminal** command to access global configuration mode.

```
device# configure terminal
```

2. Enter the **router bgp** command to enable BGP routing.

```
device(config)# router bgp
```

3. Enter the **local-as** command to configure the autonomous system number (ASN) in which your device resides.

```
device(config-bgp-router)# local-as 1000
```

4. Enter the **address-family ipv6 unicast** command to enter IPv6 address family configuration mode.

```
device(config-bgp-router)# address-family ipv6 unicast
```

5. Enter the **neighbor default-originate** command and specify an IPv6 address to enable the BGP4+ device to advertise the default IPv6 route to a specific neighbor.

```
device(config-bgp-ipv6u)# neighbor 2001:db8:93e8:cc00::1 default-originate
```

The following example enables a BGP4+ device to advertise the default IPv6 route to a specific neighbor.

```
device# configure terminal
device(config)# router bgp
device(config-bgp-router)# local-as 1000
device(config-bgp-router)# address-family ipv6 unicast
device(config-bgp-ipv6u)# neighbor 2001:db8:93e8:cc00::1 default-originate
```

Using the IPv6 default route as a valid next hop for a BGP4+ route

In certain cases, such as when a device is acting as an edge device, it can be configured to use the default route as a valid next hop.

By default, a device does not use a default route to resolve a BGP4+ next-hop route. If the IPv6 route lookup for the BGP4+ next-hop does not result in a valid IGP route (including static or direct routes), the BGP4+ next-hop is considered to be unreachable and the BGP4+ route is not used. You can configure the device to use the default route as a valid next hop.

1. Enter the **configure terminal** command to access global configuration mode.

```
device# configure terminal
```

2. Enter the **router bgp** command to enable BGP routing.

```
device(config)# router bgp
```

3. Enter the **address-family ipv6 unicast** command to enter IPv6 address family configuration mode.

```
device(config-bgp-router)# address-family ipv6 unicast
```

4. Enter the **next-hop-enable-default** command to configure the device to use the default route as a valid next hop.

```
device(config-bgp-ipv6u)# next-hop-enable-default
```

The following example configures a BGP4+ device to use the default route as a valid next hop.

```
device# configure terminal
device(config)# router bgp
device(config-bgp-router)# address-family ipv6 unicast
device(config-bgp-ipv6u)# next-hop-enable-default
```

BGP4+ next hop recursion

A device can find the IGP route to the next-hop gateway for a BGP4+ route.

For each BGP4+ route learned, the device performs a route lookup to obtain the IPv6 address of the next hop for the route. A BGP4+ route is eligible for addition in the IPv6 route table only if the following conditions are true:

- The lookup succeeds in obtaining a valid next-hop IPv6 address for the route.
- The path to the next-hop IPv6 address is an IGP path or a static route path.

By default, the software performs only one lookup for the next-hop IPv6 address for the BGP4+ route. If the next hop lookup does not result in a valid next hop IPv6 address, or the path to the next hop IPv6 address is a BGP4+ path, the BGP4+ route destination is considered unreachable. The route is not eligible to be added to the IPv6 route table.

The BGP4+ route table can contain a route with a next hop IPv6 address that is not reachable through an IGP route, even though the device can reach a hop farther away through an IGP route. This can occur when the IGP does not learn a complete set of IGP routes, so the device learns about an internal route through IBGP instead of through an IGP. In this case, the IPv6 route table will not contain a route that can be used to reach the BGP4+ route destination.

To enable the device to find the IGP route to the next-hop gateway for a BGP4+ route, enable recursive next-hop lookups. With this feature enabled, if the first lookup for a BGP4+ route results in an IBGP path that originated within the same AS, rather than an IGP path or static route path, the device performs a lookup on the next hop IPv6 address for the next hop gateway. If this second lookup results in an IGP path, the software considers the BGP4+ route to be valid and adds it to the IPv6 route table. Otherwise, the device performs another lookup on the next hop IPv6 address of the next hop for the next hop gateway, and so on, until one of the lookups results in an IGP route.

You must configure a static route or use an IGP to learn the route to the EBGP multihop peer.

Enabling next-hop recursion

Next hop recursion can be enabled so that a device can find the IGP route to the next hop gateway for a BGP4+ route.

1. Enter the **configure terminal** command to access global configuration mode.

```
device# configure terminal
```

2. Enter the **router bgp** command to enable BGP routing.

```
device(config)# router bgp
```

3. Enter the **address-family ipv6 unicast** command to enter IPv6 address family configuration mode.

```
device(config-bgp-router)# address-family ipv6 unicast
```

4. Enter the **next-hop-recursion** command to enable recursive next hop lookups.

```
device(config-bgp-ipv6u)# next-hop-recursion
```

The following example enables recursive next hop lookups.

```
device# configure terminal
device(config)# router bgp
device(config-bgp-router)# address-family ipv6 unicast
device(config-bgp-ipv6u)# next-hop-recursion
```

BGP4+ NLRI and next hop attributes

BGP4+ introduces new attributes to handle multiprotocol extensions for BGP.

Multiprotocol BGP (MBGP) is an extension to BGP that enables BGP to carry routing information for multiple address families.

BGP4+ introduces new attributes to handle multiprotocol extensions for BGP:

- Multiprotocol reachable Network Layer Reachability Information (MP_REACH_NLRI): Used to carry the set of reachable destinations, together with the next hop information, to be used for forwarding to these destinations.
- Multiprotocol unreachable NLRI (MP_UNREACH_NLRI): Used to carry the set of unreachable destinations.

MP_REACH_NLRI and MP_UNREACH_NLRI are optional and non-transitive, so that a BGP4+ speaker that does not support the multiprotocol capabilities ignores the information carried in these attributes, and does not pass it to other BGP4+ speakers. A BGP speaker that uses multiprotocol extensions for IPv6 uses the capability advertisement procedures to determine whether the speaker can use multiprotocol extensions with a particular peer.

The next hop information carried in the MP_REACH_NLRI path attribute defines the network layer address of the border router that will be used as the next hop to the destinations listed in the MP_NLRI attribute in the UPDATE message.

MP_REACH_NLRI and MP_UNREACH_NLRI carry IPv6 prefixes.

BGP4+ route reflection

A BGP device can act as a route-reflector client or as a route reflector. You can configure a BGP peer as a route-reflector client from the device that is going to reflect the routes and act as the route reflector using the **neighbor route-reflector-client** command.

When there is more than one route reflector, they should all belong to the same cluster. By default, the value for **cluster-id** is used as the device ID. The device ID can be changed using the **cluster-id** command.

The route-reflector server reflects the routes as follows:

- Routes from the client are reflected to the client as well as to nonclient peers.
- Routes from nonclient peers are reflected only to client peers.

If route-reflector clients are connected in a full IBGP mesh, you can disable client-to-client reflection on the route reflector using the **no client-to-client-reflection** command.

A BGP device advertises only those routes that are preferred ones and are installed into the Routing Table Manager (RTM). When a route cannot be installed into the RTM because the routing table is full, the route reflector may not reflect that route. In cases where the route reflector is not placed directly in the forwarding path, you can configure the route reflector to reflect routes even though those routes are not in the RTM using the **always-propagate** command.

Configuring a cluster ID for a route reflector

The cluster ID can be changed if there is more than one route reflector, so that all route reflectors belong to the same cluster.

1. Enter the **configure terminal** command to access global configuration mode.

```
device# configure terminal
```

2. Enter the **router bgp** command to enable BGP routing.

```
device(config)# router bgp
```

3. Enter the **local-as** command to configure the autonomous system number (ASN) in which your device resides.

```
device(config-bgp-router)# local-as 1000
```

4. Enter the **cluster-id** command and specify a value to change the cluster ID of a device from the default device ID.

```
device(config-bgp-router)# cluster-id 321
```

The following example changes the cluster ID of a device from the default device ID to 321.

```
device# configure terminal
device(config)# router bgp
device(config-bgp-router)# cluster-id 321
```

Configuring a route reflector client

A BGP peer can be configured as a route reflector client.

1. Enter the **configure terminal** command to access global configuration mode.

```
device# configure terminal
```

2. Enter the **router bgp** command to enable BGP routing.

```
device(config)# router bgp
```

3. Enter the **local-as** command to configure the autonomous system number (ASN) in which your device resides.

```
device(config-bgp-router)# local-as 1000
```

4. Enter the **address-family ipv6 unicast** command to enter IPv6 address family configuration mode.

```
device(config-bgp-router)# address-family ipv6 unicast
```

5. Enter the **neighbor route-reflector-client** command, specifying an IPv6 address, to configure a specified neighbor to be a route reflector client.

```
device(config-bgp-ipv6u)# neighbor 2001:db8:e0ff:783a::4 route-reflector-client
```

The following example configures a neighbor with the IPv6 address 2001:db8:e0ff:783a::4 to be a route reflector client.

```
device# configure terminal
device(config)# router bgp
device(config-bgp-router)# local-as 1000
device(config-bgp-router)# address-family ipv6 unicast
device(config-bgp-ipv6u)# neighbor 2001:db8:e0ff:783a::4 route-reflector-client
```

BGP4+ route aggregation

A device can be configured to aggregate routes in a range of networks into a single IPv6 prefix.

By default, a device advertises individual BGP4+ routes for all the networks. The aggregation feature allows you to configure a device to aggregate routes in a range of networks into a single IPv6 prefix. For example, without aggregation, a device will individually advertise routes for networks 2001:db8:0001:0000::/64, 2001:db8:0002:0000::/64, 2001:db8:0003:0000::/64, and so on. You can configure the device to send a single, aggregate route for the networks instead so that the aggregate route would be advertised as 2001:db8::/32 to BGP4 neighbors.

Aggregating routes advertised to BGP neighbors

A device can be configured to aggregate routes in a range of networks into a single IPv6 prefix.

The route-map should already be defined.

You can aggregate BGP4+ routes, for example 2001:db8:0001:0000::/64, 2001:db8:0002:0000::/64, 2001:db8:0003:0000::/64 into a single network prefix: 2001:db8::/24.

1. Enter the **configure terminal** command to access global configuration mode.

```
device# configure terminal
```

2. Enter the **router bgp** command to enable BGP routing.

```
device(config)# router bgp
```

3. Enter the **address-family ipv6 unicast** command to enter IPv6 address family configuration mode.

```
device(config-bgp-router)# address-family ipv6 unicast
```

4. Enter the **aggregate-address** command to aggregate the routes from a range of networks into a single network prefix.

```
device(config-bgp-ipv6u)# aggregate-address 2001:db8::/32
```

The following example enables a BGP4+ device to advertise the default route and send the default route to a specified neighbor.

```
device# configure terminal
device(config)# router bgp
device(config-bgp-router)# address-family ipv6 unicast
device(config-bgp-ipv6u)# aggregate-address 2001:db8::/32
```

BGP4+ multipath

The BGP4+ multipath feature can be used to enable load-balancing across different paths.

BGP4+ selects only one best path for each IPv6 prefix it receives before installing it in the IP routing table. If you need load-balancing across different paths, you must enable BGP4+ multipath using the **maximum-paths** command under IPv6 address family configuration mode.

IBGP paths and EBGP paths can be exclusively selected, or a combination of IBGP and EBGP paths can be selected.

The following attributes of parallel paths must match for them to be considered for multipathing:

- Weight
- Local Preference
- Origin
- AS-Path Length
- MED
- Neighbor AS (EBGP multipath)
- AS-PATH match (for IBGP multipath)
- IGP metric to BGP next hop

Enabling load-balancing across different paths

The BGP4+ multipath feature can be configured, enabling load-balancing across different paths.

1. Enter the **configure terminal** command to access global configuration mode.

```
device# configure terminal
```

2. Enter the **router bgp** command to enable BGP routing.

```
device(config)# router bgp
```

3. Enter the **address-family ipv6 unicast** command to enter IPv6 address family configuration mode.

```
device(config-bgp-router)# address-family ipv6 unicast
```

4. Do one of the following:

- Enter the **maximum-paths** command and specify a value to set the maximum number of BGP4+ shared paths.
- Enter the **maximum-paths** command using the **use-load-sharing** keyword to set the maximum number of BGP4+ shared paths to that of the value already configured by means of the **ip load-sharing** command.

```
device(config-bgp-ipv6u)# maximum-paths 8
```

or

```
device(config-bgp-ipv6u)# maximum-paths use-load-sharing
```

The following example sets the maximum number of BGP4+ shared paths to 8.

```
device# configure terminal
device(config)# router bgp
device(config-bgp-router)# address-family ipv6 unicast
device(config-bgp-ipv6u)# maximum-paths 8
```

Route maps

Route maps must be applied to IPv6 unicast address prefixes in IPv6 address family configuration mode.

By default, route maps that are applied under IPv4 address family configuration mode using the **neighbor route-map** command are applied to only IPv4 unicast address prefixes. To apply route maps to IPv6 unicast address prefixes, the **neighbor route-map** command must be used in IPv6 address family configuration mode. The route maps are applied as the inbound or outbound routing policy for neighbors under the specified address family. Configuring separate route maps under each address family type simplifies managing complicated or different policies for each address family.

Configuring a route map for BGP4+ prefixes

Route maps can be applied to IPv6 unicast address prefixes either as the inbound or outbound routing policy for neighbors under the specified address family.

1. Enter the **configure terminal** command to access global configuration mode.

```
device# configure terminal
```

2. Enter the **ipv6 prefix-list** command and enter a name to configure an IPv6 prefix list.

```
device(config)# ipv6 prefix-list myprefixlist seq 10 permit 2001:db8::/32
```

The prefix list name, sequence number, and permits packets are specified.

3. Enter the **route-map** command with the **permit** keyword, and specify a route map name, to define the route map and enter route map configuration mode.

```
device(config)# route-map myroutemap permit 10
```

4. Enter the **match ipv6 address** command and specify the name of a prefix list.

```
device(config-route-map-myroutemap/permit/10)# match ipv6 address prefix-list myprefixlist
```

5. Enter the **exit** command to return to global configuration mode.

```
device(config-route-map-myroumap/permit/10)# exit
```

6. Enter the **router bgp** command to enable BGP routing.

```
device(config)# router bgp
```

7. Enter the **local-as** command to configure the autonomous system number (ASN) in which your device resides.

```
device(config-bgp-router)# local-as 1000
```

8. Enter the **neighbor remote-as** command, specifying an IPv6 address, to specify the ASN in which the remote neighbor resides.

```
device(config-bgp-router)# neighbor fe80:4398:ab30:45de::1 remote-as 1001
```

9. Enter the **address-family ipv6 unicast** command to enter IPv6 address family configuration mode.

```
device(config-bgp-router)# address-family ipv6 unicast
```

10. Enter the **neighbor activate** command to enable the exchange of information with the neighbor.

```
device(config-bgp-ipv6u)# neighbor fe80:4398:ab30:45de::1 activate
```

11. Enter the **neighbor route-map** command and specify the **out** keyword to apply a route map to outgoing routes.

```
device(config-bgp-ipv6u)# neighbor fe80:4398:ab30:45de::1 route-map out myroumap
```

The following example applies a route map, "myroumap", as the outbound routing policy for a neighbor.

```
device# configure terminal
device(config)# ipv6 prefix-list myprefixlist seq 10 permit 2001:db8::/32
device(config)# route-map myroumap permit 10
device(config-route-map-myroumap/permit/10)# match ipv6 address prefix-list myprefixlist
device(config-route-map-myroumap/permit/10)# exit
device(config)# router bgp
device(config-bgp-router)# local-as 1000
device(config-bgp-router)# neighbor fe80:4398:ab30:45de::1 remote-as 1001
device(config-bgp-router)# address-family ipv6 unicast
device(config-bgp-ipv6u)# neighbor fe80:4398:ab30:45de::1 activate
device(config-bgp-ipv6u)# neighbor fe80:4398:ab30:45de::1 route-map out myroumap
```

Redistributing prefixes into BGP4+

Various routes can be redistributed into BGP.

Static, connected, and OSPF routes can be redistributed into BGP. This task redistributes OSPFv3 routes into BGP4+.

1. Enter the **configure terminal** command to access global configuration mode.

```
device# configure terminal
```

2. Enter the **router bgp** command to enable BGP routing.

```
device(config)# router bgp
```

3. Enter the **address-family ipv6 unicast** command to enter IPv6 address family configuration mode.

```
device(config-bgp-router)# address-family ipv6 unicast
```

4. Enter the **redistribute** command using the **ospf** and **external1** keywords to redistribute IPv6 OSPF external type 1 routes.

```
device(config-bgp-ipv6u)# redistribute ospf match external1
```

The following example redistributes OSPF external type 1 routes into BGP4+.

```
device# configure terminal
device(config)# router bgp
device(config-bgp-router)# address-family ipv6 unicast
device(config-bgp-ipv6u)# redistribute ospf match external1
```

Redistributing routes into BGP4+

Various routes can be redistributed into BGP. This task redistributes connected routes into BGP.

1. Enter the **configure terminal** command to access global configuration mode.

```
device# configure terminal
```

2. Enter the **router bgp** command to enable BGP routing.

```
device(config)# router bgp
```

3. Enter the **address-family ipv6 unicast** command to enter IPv6 address family unicast configuration mode.

```
device(config-bgp-router)# address-family ipv6 unicast
```

4. Enter the **redistribute** command using the **connected** keyword to redistribute connected routes into BGP4+.

```
device(config-bgp-ipv6u)# redistribute connected
```

The following example redistributes connected routes into BGP4+.

```
device# configure terminal
device(config)# router bgp
device(config-bgp-router)# address-family ipv6 unicast
device(config-bgp-ipv6u)# redistribute connected
```

Specifying the weight added to BGP4+ received routes

The weight that the device adds to received routes can be specified. The following task changes the weight from the default for routes that are received from a specified BGP4+ neighbor.

1. Enter the **configure terminal** command to access global configuration mode.

```
device# configure terminal
```

2. Enter the **router bgp** command to enable BGP routing.

```
device(config)# router bgp
```

3. Enter the **local-as** command to configure the autonomous system number (ASN) in which your device resides.

```
device(config-bgp-router)# local-as 65520
```

4. Enter the **address-family ipv6 unicast** command to enter address family IPv6 unicast configuration mode.

```
device(config-bgp-router)# address-family ipv6 unicast
```

5. Enter the **neighbor weight** command and specify an *ipv6 address* and a weight value to specify a weight that the device adds to routes that are received from the specified BGP4+ neighbor.

```
device(config-bgp-ipv6u)# neighbor 2001:db8:e0ff:783a::4 weight 200
```

The following example specifies a weight of 200 that the device adds to routes that are received from the specified BGP4+ neighbor.

```
device# configure terminal
device(config)# router bgp
device(config-bgp-router)# local-as 65520
device(config-bgp-router)# address-family ipv6 unicast
device(config-bgp-ipv6u)# neighbor 2001:db8:e0ff:783a::4 weight 200
```

Enabling BGP4+ in a non-default VRF

When BGP4+ is enabled in a non-default VRF instance, the device enters BGP address-family IPv6 unicast VRF configuration mode. Several commands can then be accessed that allow the configuration of BGP4+ for the non-default VRF instance.

A non-default VRF instance has been configured.

1. Enter the **configure terminal** command to access global configuration mode.

```
device# configure terminal
```

2. Enter the **router bgp** command to enable BGP routing globally.

```
device(config)# router bgp
```

3. Enter the **address-family ipv6 unicast** command with the **vrf** parameter, and specify a VRF name, to enter BGP address-family IPv6 unicast VRF configuration mode.

```
device(config-bgp-router)# address-family ipv6 unicast vrf green
```

The following example enables BGP address-family IPv6 unicast VRF configuration mode where several commands can be accessed that allow the configuration of BGP4+ for the non-default VRF instance..

```
device# configure terminal
device(config)# router bgp
device(config-bgp-router)# address-family ipv6 unicast vrf green
device(config-bgp-ipv6u-vrf)#
```

BGP4+ outbound route filtering

The BGP4+ Outbound Route Filtering Capability (ORF) feature is used to minimize the number of BGP updates sent between BGP peers.

When the ORF feature is enabled, unwanted routing updates are filtered out, reducing the amount of system resources required for generating and processing routing updates. The ORF feature is enabled through the advertisement of ORF capabilities to peer routers. The locally configured BGP4+ inbound prefix filters are sent to the remote peer so that the remote peer applies the filter as an outbound filter for the neighbor.

The ORF feature can be configured with send and receive ORF capabilities. The local peer advertises the ORF capability in send mode, indicating that it will accept a prefix list from a neighbor and apply the prefix list to locally configured ORFs. The local peer exchanges the ORF capability in send mode with a remote peer for a prefix list that is configured as an inbound filter for that peer locally. The remote peer only sends the first update once it receives a ROUTEREFRESH request or BGP ORF with IMMEDIATE from the peer. The local and remote peers exchange updates to maintain the ORF on each router.

Configuring BGP4+ outbound route filtering

The BGP4+ Outbound Route Filtering (ORF) prefix list capability can be configured in receive mode, send mode, or both send and receive modes, minimizing the number of BGP updates exchanged between BGP peers.

1. Enter the **configure terminal** command to access global configuration mode.

```
device# configure terminal
```

2. Enter the **router bgp** command to enable BGP routing.

```
device(config)# router bgp
```

3. Enter the **address-family ipv6 unicast** command to enter IPv6 address family configuration mode.

```
device(config-bgp-router)# address-family ipv6 unicast
```

4. Enter the **neighbor activate** command, specifying an IPv6 address, to add a neighbor.

```
device(config-bgp-ipv6u)# neighbor 2001:db8:e0ff:783a::4 activate
```

5. Enter the **neighbor prefix-list** command, specify an IPv6 address and the **in** keyword to filter the incoming route updates from a specified BGP neighbor.

```
device(config-bgp-ipv6u)# neighbor 2001:db8:e0ff:783a::4 prefix-list myprefixlist in
```

6. Do one of the following:

- Enter the **neighbor capability orf prefixlist** command and specify the **send** keyword to advertise ORF send capabilities.

```
device(config-bgp-ipv6u)# neighbor 2001:db8:e0ff:783a::4 capability orf prefixlist send
```

- Enter the **neighbor capability orf prefixlist** command and specify the **receive** keyword to advertise ORF receive capabilities.

```
device(config-bgp-ipv6u)# neighbor 2001:db8:e0ff:783a::4 capability orf prefixlist receive
```

- Enter the **neighbor capability orf prefixlist** command to configure ORF capability in both send and receive modes.

```
device(config-bgp-ipv6u)# neighbor 2001:db8:e0ff:783a::4 capability orf prefixlist
```

The following example configures ORF in receive mode.

```
device# configure terminal
device(config)# router bgp
device(config-bgp-router)# address-family ipv6 unicast
device(config-bgp-ipv6u)# neighbor 2001:db8:e0ff:783a::4 activate
device(config-bgp-ipv6u)# neighbor 2001:db8:e0ff:783a::4 capability orf prefixlist receive
```

The following example configures ORF in send mode.

```
device# configure terminal
device(config)# router bgp
device(config-bgp-router)# address-family ipv6 unicast
device(config-bgp-ipv6u)# neighbor 2001:db8:e0ff:783a::4 activate
device(config-bgp-ipv6u)# neighbor 2001:db8:e0ff:783a::4 prefix-list myprefixlist in
device(config-bgp-ipv6u)# neighbor 2001:db8:e0ff:783a::4 capability orf prefixlist send
```

The following example configures ORF in both send and receive modes.

```
device# configure terminal
device(config)# router bgp
device(config-bgp-router)# address-family ipv6 unicast
device(config-bgp-ipv6u)# neighbor 2001:db8:e0ff:783a::4 activate
device(config-bgp-ipv6u)# neighbor 2001:db8:e0ff:783a::4 prefix-list myprefixlist in
device(config-bgp-ipv6u)# neighbor 2001:db8:e0ff:783a::4 capability orf prefixlist
```

BGP4+ confederations

A large autonomous system (AS) can be divided into multiple subautonomous systems and grouped into a single BGP4+ confederation.

Each subautonomous system must be uniquely identified within the confederation AS by a subautonomous system number. Within each subautonomous system, all the rules of internal BGP (IBGP) apply. For example, all BGP routers inside the subautonomous system must be fully meshed. Although EBGP is used between subautonomous systems, the subautonomous systems within the confederation exchange routing information like IBGP peers. Next hop, Multi Exit Discriminator (MED), and local preference information is preserved when crossing subautonomous system boundaries. To the outside world, a confederation looks like a single AS.

The AS path list is a loop-avoidance mechanism used to detect routing updates leaving one subautonomous system and attempting to re-enter the same subautonomous system. A routing update attempting to re-enter a subautonomous system it originated from is detected because the subautonomous system sees its own subautonomous system number listed in the update's AS path.

Configuring BGP4+ confederations

BGP4+ confederations, composed of multiple subautonomous systems, can be created.

1. Enter the **configure terminal** command to access global configuration mode.

```
device# configure terminal
```

2. Enter the **router bgp** command to enable BGP routing.

```
device(config)# router bgp
```

3. Enter the **local-as** command to configure the autonomous system number (ASN) in which your device resides.

```
device(config-bgp-router)# local-as 65520
```

4. Enter the **confederation identifier** command and specify an ASN to configure a BGP confederation identifier.

```
device(config-bgp-router)# confederation identifier 100
```

5. Enter the **confederation peers** command and specify as many ASNs as needed to list all BGP peers that will belong to the confederation.

```
device(config-bgp-router)# confederation peers 65520 65521 65522
```

The following example creates a confederation with the confederation ID “100” and adds three subautonomous systems to the confederation.

```
device# configure terminal
device(config)# router bgp
device(config-bgp-router)# local-as 65520
device(config-bgp-router)# confederation identifier 100
device(config-bgp-router)# confederation peers 65520 65521 65522
```

Auto shutdown of BGP neighbors on initial configuration

The auto shutdown of BGP neighbors on initial configuration feature prevents a BGP peer from attempting to establish connections with remote peers when the BGP peer is first configured. Sessions are only initiated when the entire configuration for the BGP peer is complete.

When the auto shutdown of BGP neighbors on initial configuration feature is enabled, the value of the shutdown parameter for any existing configured neighbor is not changed. Any new BGP neighbor configured after the feature is enabled has the shutdown state set to the configured value. When the feature is enabled and a new BGP neighbor is configured, the shutdown parameter of the BGP neighbor is automatically set to enabled. When all the BGP neighbor parameters are configured and it is ready to start the establishment of BGP session with the remote peer, the shutdown parameter of the BGP neighbor is then disabled.

Any new neighbor configured and added to a peer group has the shutdown flag enabled by default. Additionally, any new neighbor configured with the autonomous system (AS) in which that remote neighbor resides specified using the **neighbor remote-as** command has the shutdown flag enabled by default.

Configuring auto shutdown of BGP neighbors on initial configuration

Follow this procedure to enable auto shutdown of BGP neighbors on initial configuration.

1. Enter the **configure terminal** command to access global configuration mode.

```
device# configure terminal
```

2. Enter the **router bgp** command to enable BGP routing.

```
device(config)# router bgp
```

3. Enter the **local-as** command to configure the autonomous system number (ASN) in which your device resides.

```
device(config-bgp-router)# local-as 65520
```

4. Enter the **auto-shutdown-new-neighbors** command to prevent the BGP peer from attempting to establish connections with remote peers until all BGP neighbor parameters are configured.

```
device(config-bgp-router)# auto-shutdown-new-neighbors
```

The following example enables auto shutdown of BGP neighbors on initial configuration.

```
device# configure terminal
device(config)# router bgp
device(config-bgp-router)# local-as 65520
device(config-bgp-router)# auto-shutdown-new-neighbors
```

Disabling the BGP4+ peer shutdown state

When the auto shutdown of BGP4+ neighbors on initial configuration feature is enabled, a BGP4+ peer is prevented from attempting to establish connections with remote peers when the BGP4+ peer is first configured. Once all of the configuration parameters for the peer are complete, you can start the BGP4+ session establishment process and disable the peer shutdown state. Follow this procedure to disable the peer shutdown state.

1. Enter the **configure terminal** command to access global configuration mode.

```
device# configure terminal
```

2. Enter the **router bgp** command to enable BGP routing.
3. Enter the **local-as** command to configure the autonomous system number (ASN) in which your device resides.
4. Enter the **no neighbor shutdown** command, specifying an IPv6 address, to disable the peer shutdown state and begin the BGP4+ session establishment process.

The following example disables the peer shutdown state and begins the BGP4+ session establishment process.

Generalized TTL Security Mechanism support

Generalized TTL Security Mechanism (GTSM) is a lightweight security mechanism that protects external Border Gateway Protocol (eBGP) peering sessions from CPU utilization-based attacks using forged IP packets. GTSM prevents attempts to hijack the eBGP peering session by a host on a network segment that is not part of either BGP network, or by a host on a network segment that is not between the eBGP peers.

GTSM is enabled by configuring a minimum Time To Live (TTL) value for incoming IP packets received from a specific eBGP peer. BGP establishes and maintains the session only if the TTL value in the IP packet header is equal to or greater than the TTL value configured for the peering session. If the value is less than the configured value, the packet is silently discarded and no Internet Control Message Protocol (ICMP) message is generated.

In the case of directly connected neighbors, the device expects the BGP control packets received from the neighbor to have a TTL value of either 254 or 255. For multihop peers, the device expects the TTL for BGP control packets received from the neighbor to be greater than or equal to 255, minus the configured number of hops to the neighbor. If the BGP control packets received from the neighbor do not have the expected value, the device drops them.

Assumptions and limitations

- GTSM is supported for both directly connected peering sessions and multihop eBGP peering sessions.
- GTSM is supported for eBGP only.
- GTSM does not protect the integrity of data sent between eBGP peers and does not validate eBGP peers through any authentication method.
- GTSM validates only the locally configured TTL count against the TTL field in the IP packet header.
- GTSM should be configured on each participating device to maximize the effectiveness of this feature.
- When GTSM is enabled, the eBGP session is secured in the incoming direction only and has no effect on outgoing IP packets or the remote device.

Configuring GTSM for BGP4+

Generalized TTL Security Mechanism (GTSM) can be configured to protect external Border Gateway Protocol (eBGP) peering sessions .

1. Enter the **configure terminal** command to access global configuration mode.

```
device# configure terminal
```

2. Enter the **router bgp** command to enable BGP routing.

```
device(config)# router bgp
```

3. Enter the **local-as** command to configure the autonomous system number (ASN) in which your device resides.

```
device(config-bgp-router)# local-as 65520
```

4. Enter the **neighbor remote-as** command, specifying an IPv6 address, to add a neighbor.

```
device(config-bgp-router)# neighbor 2001:2018:8192::125 remote-as 2
```

5. Enter the **neighbor ebgp-btsh** command, specifying an IPv6 address, to enable GTSM.

```
device(config-bgp-router)# neighbor 2001:2018:8192::125 ebgp-btsh
```

The following example enables GTSM between a device and a neighbor with the IPv6 address 2001:2018:8192::125.

```
device# configure terminal
device(config)# router bgp
device(config-bgp-router)# local-as 65520
device(config-bgp-router)# neighbor 2001:2018:8192::125 remote-as 2
device(config-bgp-router)# neighbor 2001:2018:8192::125 ebgp-btsh
```

Disabling the BGP AS_PATH check function

A device can be configured so that the AS_PATH check function for routes learned from a specific location is disabled, and routes that contain the recipient BGP speaker's AS number are not rejected.

1. Enter the **configure terminal** command to access global configuration mode.

```
device# configure terminal
```

2. Enter the **router bgp** command to enable BGP routing.

```
device(config)# router bgp
```

3. Enter the **address-family ipv6 unicast** command to enter IPv6 address family unicast configuration mode.

```
device(config-bgp-router)# address-family ipv6 unicast
```

4. Enter the **neighbor allowas-in** command with an IPv6 address and specify a **number** to disable the BGP AS_PATH check function, and specify the number of times that the AS path of a received route may contain the recipient BGP speaker's AS number and still be accepted.

```
device(config-bgp-ipv6u)# neighbor 2001:db8:e0ff:783a::4 allowas-in 3
```

The following example specifies that the AS path of a received route may contain the recipient BGP speaker's AS number three times and still be accepted.

```
device# configure terminal
device(config)# router bgp
device(config-bgp-router)# address-family ipv6 unicast
device(config-bgp-ipv6u)# neighbor 2001:db8:e0ff:783a::4 allowas-in 3
```

Displaying BGP4+ statistics

Various **show ipv6 bgp** commands verify information about BGP4+ configurations.

Use one or more of the following commands to verify BGP4+ information. The commands do not have to be entered in this order.

1. Enter the **show ipv6 bgp summary** command.

```
device# show ipv6 bgp summary

BGP4 Summary
Router ID: 30.1.1.8   Local AS Number: 4001183001
Confederation Identifier: not configured
Confederation Peers:
Maximum Number of IP ECMP Paths Supported for Load Sharing: 1
Number of Neighbors Configured: 3, UP: 3
Number of Routes Installed: 200, Uses 19200 bytes
Number of Routes Advertising to All Neighbors: 400 (200 entries), Uses 12000 bytes
Number of Attribute Entries Installed: 1, Uses 104 bytes
Neighbor Address  AS#           State      Time      Rt:Accepted  Filtered  Sent      ToSend
fd80:3001:4031:1::225
    4031           ESTAB      8h12m 5s   200        0           0         0
fdcd:3001:3009:1::113
    4001133001    ESTAB      8h 6m47s   0           0           200       0
fdcd:3001:3009:1::114
    4001143001    ESTAB      6h40m33s   0           0           200       0
```

This example output gives summarized BGP4+ information.

2. Enter the **show ipv6 bgp attribute-entries** command.

```
device# show ipv6 bgp attribute-entries

Total number of BGP Attribute Entries: 1
1  Next Hop  : fd80:3001:4031:1::225           MED      :0
Origin:IGP
Originator:0.0.0.0           Cluster List:None
Aggregator:AS Number :0           Router-ID:0.0.0.0           Atomic:None
Local Pref:100               Communities:Internet
AS Path  :4031 (length 4)
    AsPathLen: 1  AsNum: 1, SegmentNum: 1, Neighboring As: 4031, Source As 4031
Address: 0x0a5e1e18  Hash:6995 (0x01002080)
Links: 0x00000000, 0x00000000
Reference Counts: 200:0:400, Magic: 13
```

This example shows information about an route-attribute entry that is stored in device memory.

3. Enter the **show ipv6 bgp peer-group** command.

```

device# show ipv6 bgp peer-group

1  BGP peer-group is pg_vrf11, Remote AS: 4001143011
   Description: bgp_vrf4@-4001183011
   MD5 Password: $MiJTfXJVRzMxTTNRUVpaVzhRWlo=
   Address family : IPV4 Unicast
   activate
   Address family : IPV6 Unicast
   no activate
   Currently there are no members.

2  BGP peer-group is pg_vrf12, Remote AS: 4001143021
   Description: bgp_vrf4@-4001183021
   MD5 Password: $MiJTfXJVRzMxTTNRUVpaVzhRfFo=
   Address family : IPV4 Unicast
   activate
   Address family : IPV6 Unicast
   no activate
   Currently there are no members.

```

This example shows output for two peer groups, called “pg” and “pg6”.

4. Enter the **show ipv6 bgp routes** command.

```

device# show ipv6 bgp routes

Total number of BGP Routes: 6
Status A:AGGREGATE B:BEST b:NOT-INSTALLED-BEST C:CONFED_EBGP D:DAMPED
       E:EBGP H:HISTORY I:IBGP L:LOCAL M:MULTIPATH m:NOT-INSTALLED-MULTIPATH
       S:SUPPRESSED F:FILTERED s:STALE
Prefix      Next Hop      MED      LocPrf      Weight Status
1  fd70::/128    fd80:3001:4031:1::225
                        none                100          0        BE
   AS_PATH: 4031
2  fd70::1/128  fd80:3001:4031:1::225
                        none                100          0        BE
   AS_PATH: 4031
3  fd70::2/128  fd80:3001:4031:1::225
                        none                100          0        BE
   AS_PATH: 4031
4  fd70::3/128  fd80:3001:4031:1::225
                        none                100          0        BE
   AS_PATH: 4031
5  fd70::4/128  fd80:3001:4031:1::225
                        none                100          0        BE
   AS_PATH: 4031
6  fd70::5/128  fd80:3001:4031:1::225
                        none                100          0        BE
   AS_PATH: 4031

```

This example shows general BGP4+ route information.

- Enter the **show ipv6 bgp routes** command, using the **summary** keyword.

```
device# show ipv6 bgp routes summary

Total number of BGP routes (NLRIs) Installed      : 200
Distinct BGP destination networks                 : 200
Filtered bgp routes for soft reconfig             : 0
Routes originated by this router                  : 0
Routes selected as BEST routes                    : 200
Routes Installed as BEST routes                   : 200
BEST routes not installed in IP forwarding table  : 0
Static routes not installed in IP forwarding table : 0
Unreachable routes (no IGP route for NEXTHOP)    : 0
IBGP routes selected as best routes               : 0
EBGP routes selected as best routes               : 200
BEST routes not valid for IP forwarding table     : 0
```

This example shows summarized BGP4+ route information.

Displaying BGP4+ neighbor statistics

Various **show ipv6 bgp neighbor** commands verify information about BGP4+ neighbor configurations.

Use one or more of the following commands to verify BGP4+ neighbor information. The commands do not have to be entered in this order.

- Enter the **show ipv6 bgp neighbors** command.

```
device# show ipv6 bgp neighbors

Total number of BGP Neighbors: 3
1  IP Address: fd80:3001:4031:1::225, AS: 4031 (EBGP), RouterID: 40.31.1.230, VRF: v3001
   State: ESTABLISHED, Time: 8h17m2s, KeepAliveTime: 30, HoldTime: 90
     KeepAliveTimer Expire in 1 seconds, HoldTimer Expire in 60 seconds
   Minimal Route Advertisement Interval: 0 seconds
   Messages:      Open      Update  KeepAlive Notification Refresh-Req
     Sent       : 1        0      1110      0          0
     Received: 1        3      995      0          0
   Last Update Time: NLRI                               Withdraw      NLRI                               Withdraw
                   Tx: ---                               ---           Rx: 8h17mls    ---
   Last Connection Reset Reason: User Reset Peer Session
   Notification Sent:      Unspecified
   Notification Received: Unspecified
   Neighbor NLRI Negotiation:
     Peer Negotiated IPV6 unicast capability
     Peer configured for IPV6 unicast Routes
   Neighbor AS4 Capability Negotiation:
     Peer configured for AS4 capability
   Outbound Policy Group:
     ID: 5, Use Count: 7
     Byte Sent: 21143, Received: 0
     Local host: fd80:3001:4031:1::118, Local Port: 8084
     Remote host: fd80:3001:4031:1::225, Remote Port: 179
   ...
```

This example output gives summarized information about a BGP4+ neighbor.

2. Enter the **show ipv6 bgp neighbors advertised-routes** command.

```
device# show ipv6 bgp neighbors fdcd:3001:3009:1::113 advertised-routes

      There are 6 routes advertised to neighbor fdcd:3001:3009:1::113
Status A:AGGREGATE B:BEST b:NOT-INSTALLED-BEST E:EBGP I:IBGP L:LOCAL
Prefix      Next Hop      MED      LocPrf      Weight      Status
1  fd70::/128      fdcd:3001:3009:1::118
                               none
                               0          BE
      AS_PATH: 4001183001 4031
2  fd70::1/128     fdcd:3001:3009:1::118
                               none
                               0          BE
      AS_PATH: 4001183001 4031
3  fd70::2/128     fdcd:3001:3009:1::118
                               none
                               0          BE
      AS_PATH: 4001183001 4031
4  fd70::3/128     fdcd:3001:3009:1::118
                               none
                               0          BE
      AS_PATH: 4001183001 4031
5  fd70::4/128     fdcd:3001:3009:1::118
                               none
                               0          BE
      AS_PATH: 4001183001 4031
6  fd70::5/128     fdcd:3001:3009:1::118
                               none
                               0          BE
      AS_PATH: 4001183001 4031
```

This example shows information about all the routes the BGP4+ networking device advertised to the neighbor.

3. Enter the **show ipv6 bgp neighbors last-packet-with-error** command.

```
device# show ipv6 bgp neighbors last-packet-with-error

      Total number of BGP Neighbors: 3
1  IP Address: fdcd:3001:3009:1::113
      Last error:
      BGP4: 19 bytes hex dump of packet that contains error
      ffffffff ffffffff ffffffff ffffffff 00130404
2  IP Address: fdcd:3001:3009:1::114
      Last error:
      BGP4: 19 bytes hex dump of packet that contains error
      ffffffff ffffffff ffffffff ffffffff 00130404
...
```

This example shows information about the last packet that contained an error from any of a device's neighbors.

4. Enter the **show ipv6 bgp neighbors received-routes** command.

```
device# show ipv6 bgp neighbors fd80:3001:4031:1::225 received-routes

      There are 6 received routes from neighbor fd80:3001:4031:1::225
Status A:AGGREGATE B:BEST b:NOT-INSTALLED-BEST C:CONFED_EBGP D:DAMPED
      E:EBGP H:HISTORY I:IBGP L:LOCAL M:MULTIPATH m:NOT-INSTALLED-MULTIPATH
      S:SUPPRESSED F:FILTERED s:STALE
Prefix      Next Hop      MED      LocPrf      Weight  Status
1  fd70::/128      fd80:3001:4031:1::225
      none      100      0      BE
      AS_PATH: 4031
2  fd70::1/128      fd80:3001:4031:1::225
      none      100      0      BE
      AS_PATH: 4031
3  fd70::2/128      fd80:3001:4031:1::225
      none      100      0      BE
      AS_PATH: 4031
4  fd70::3/128      fd80:3001:4031:1::225
      none      100      0      BE
      AS_PATH: 4031
5  fd70::4/128      fd80:3001:4031:1::225
      none      100      0      BE
      AS_PATH: 4031
6  fd70::5/128      fd80:3001:4031:1::225
      none      100      0      BE
      AS_PATH: 4031
```

This example lists all route information received in route updates from BGP4+ neighbors of the device since the soft-reconfiguration feature was enabled.

5. Enter the **show ipv6 bgp neighbors rib-out-routes** command.

```
device# show ipv6 bgp neighbors fdcd:3001:3009:1::113 rib-out-routes vrf v3001

      There are 200 RIB_out routes for neighbor fdcd:3001:3009:1::113
Status A:AGGREGATE B:BEST b:NOT-INSTALLED-BEST E:EBGP I:IBGP L:LOCAL
Prefix      Next Hop      MED      LocPrf      Weight  Status
1  fd70::/128      fd80:3001:4031:1::225
      none      100      0      BE
      AS_PATH: 4031
2  fd70::1/128      fd80:3001:4031:1::225
      none      100      0      BE
      AS_PATH: 40
```

This example shows information about BGP4+ outbound RIB routes.

Clearing BGP4+ dampened paths

BGP4+ suppressed routes can be reactivated using a CLI command.

The **show ipv6 bgp dampened-paths** command is entered to verify that there are BGP4+ dampened routes. The **clear ipv6 bgp dampening** command is entered to reactivate all suppressed BGP4+ routes. The **show ipv6 bgp dampened-paths** command is re-entered to verify that the suppressed BGP4+ routes have been reactivated.

1. Enter the **exit** command until you return to Privileged EXEC mode.

```
device(config)# exit
```

2. Enter the **show ipv6 bgp dampened-paths** command to display all BGP4+ dampened routes.

```
device# show ipv6 bgp dampened-paths

      Status Code >:best d:damped h:history *:valid
      Network                               From                               Flaps
Since      Reuse      Path
*d 110:110:110:4::/64                       160:160:160::10                   36  0 :
2 :54      0 :10:10    111
*d 110:110:110:3::/64                       160:160:160::10                   36  0 :
2 :54      0 :10:10    111
*d 110:110:110:2::/64                       160:160:160::10                   36  0 :
2 :54      0 :10:10    111
*d 110:110:110:1::/64                       160:160:160::10                   36  0 :
2 :54      0 :10:10    111
*d 110:110:110::/64                         160:160:160::10                   36  0 :
2 :54      0 :10:10    111
```

3. Enter the **clear ipv6 bgp dampening** command to reactivate all suppressed BGP4+ routes.

```
device# clear ipv6 bgp dampening
```

4. Enter the **show ipv6 bgp dampened-paths** command to verify that there are no BGP4+ dampened routes.

```
device# show ipv6 bgp dampened-paths
device#
```

The following example reactivates all suppressed BGP4+ routes and verifies that there are no suppressed routes.

```
device(config-bgp-router)# exit
device(config)# exit
device# show ipv6 bgp dampened-paths
device# clear ipv6 bgp dampening
device# show ipv6 bgp dampened-paths
```

OSPFv2

• OSPFv2 overview.....	181
• Autonomous System.....	181
• OSPFv2 components and roles.....	182
• Enabling OSPFv2.....	184
• Backbone area.....	184
• Assigning OSPFv2 areas.....	184
• Area range.....	185
• Area types.....	186
• Stub area and totally stubby area.....	186
• Not-so-stubby area (NSSA).....	187
• Assigning interfaces to an area.....	189
• Link state advertisements.....	190
• Configuring an MD5 password and authentication change hold time for an OSPFv2 interface.....	190
• Virtual links.....	190
• Default route origination.....	192
• External route summarization.....	193
• Modifying Shortest Path First timers.....	193
• OSPFv2 administrative distance.....	194
• OSPFv2 LSA refreshes.....	195
• Redistributing routes into OSPFv2.....	196
• OSPFv2 type 3 LSA filtering.....	196
• OSPFv2 over VRF.....	198
• Configuring the OSPFv2 Max-Metric Router LSA.....	199
• Re-enabling OSPFv2 compatibility with RFC 1583.....	200
• Changing default settings.....	200
• Disabling and re-enabling OSPFv2 event logging.....	200
• Understanding the effects of disabling OSPFv2.....	201
• Displaying OSPFv2 results.....	201

OSPFv2 overview

Open Shortest Path First Version 2 (OSPFv2) is a link-state routing protocol that uses link-state advertisements (LSAs) to update neighboring routers about a router's interfaces. Each router maintains an identical area-topology database to determine the shortest path to any neighboring router.

OSPF is built upon a hierarchy of network components and areas. The highest level of the hierarchy is the autonomous system. An autonomous system is defined as a number of networks, all of which share the same routing and administration characteristics. A backbone area forms the core of the network, connecting all other areas. Details of these and other OSPF components are provided below.

Autonomous System

An Autonomous System can be divided into multiple areas. Each area represents a collection of contiguous networks and hosts. Areas limit the amount of advertisements sent within the network. This is known as flooding. An area is represented in OSPFv2 by either an IP address or a number.

FIGURE 15 OSPF operating in a network

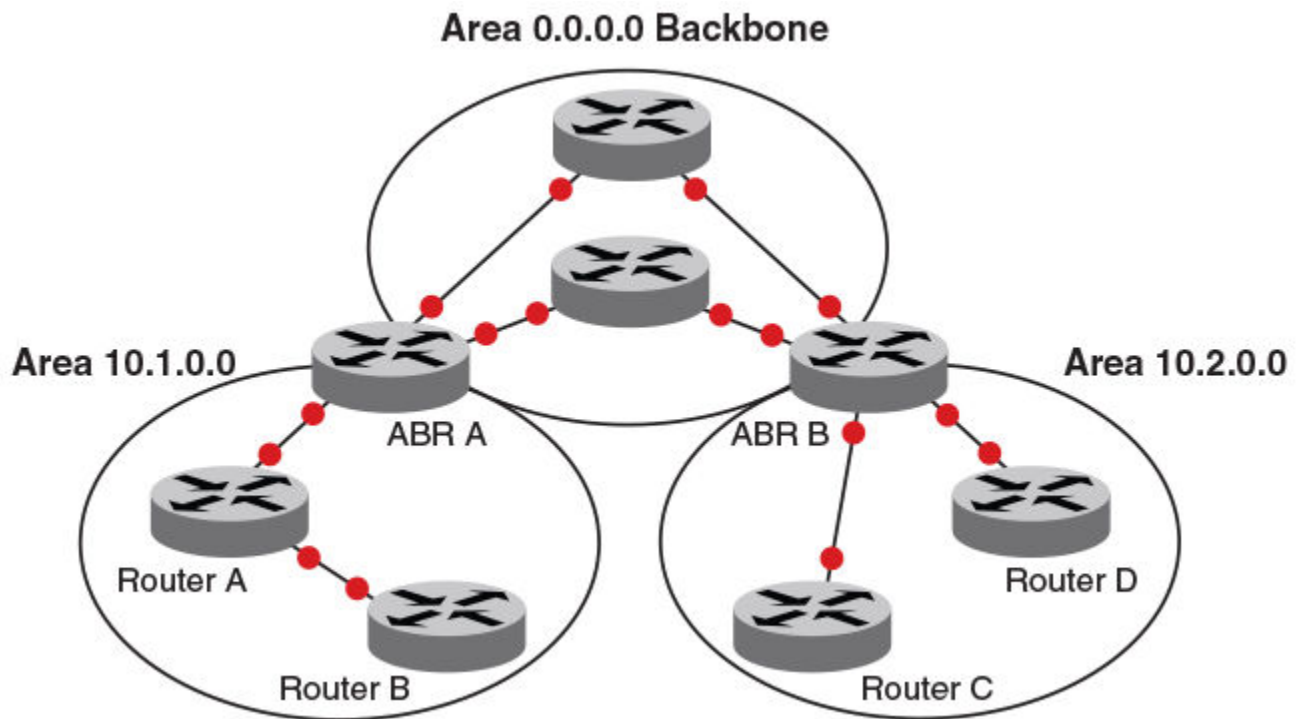
**NOTE**

For details of components and virtual links, refer to [OSPFv2 components and roles](#) on page 182 and [Virtual links](#) on page 190, respectively.

Once OSPFv2 is enabled on the system, the user assigns an IP address or number as the *area ID* for each area. The area ID is representative of all IP addresses (subnets) on a router port. Each port on a router can support one area.

OSPFv2 components and roles

OSPFv2 can be configured on either a point-to-point or broadcast network.

Devices can take a variety of roles in an OSPFv2 topology, as discussed below.

Area Border Routers

An OSPF router can be a member of multiple areas. Routers with membership in multiple areas are known as Area Border Routers (ABRs). All ABRs must have either a direct or indirect link to an OSPF backbone area (also known as area 0 or area 0.0.0.0). Each ABR maintains a separate topological database for each area the router is in. Each topological database contains all LSA databases for each router within a given area. The routers within the same area have identical topological databases. An ABR is responsible for forwarding routing information or changes among its border areas.

For more information on OSPFv2 areas, refer to the *OSPFv2 areas* section.

Autonomous System Boundary Routers

An Autonomous System Boundary Router (ASBR) is a router that is running multiple protocols and serves as a gateway to routers outside the OSPF domain and those operating with different protocols. The ASBR is able to import and translate different protocol routes into OSPF through a process known as redistribution.

Designated routers

In an OSPF broadcast network, OSPF elects one router to serve as the designated router (DR) and another router on the segment to act as the backup designated router (BDR). This minimizes the amount of repetitive information that is forwarded on the network. OSPF forwards all messages to the designated router.

On broadcast networks such as LAN links, all routers on the LAN other than the DR and BDR form full adjacencies with the DR and BDR and pass LSAs only to them. The DR forwards updates received from one neighbor on the LAN to all other neighbors on that same LAN. One of the main functions of a DR is to ensure that all the routers on the same LAN have identical LSDBs. Therefore, on broadcast networks, an LSDB is synchronized between a DROther (a router that is not a DR or a BDR) and its DR and BDR.

NOTE

In an OSPF point-to-point network, where a direct Layer 3 connection exists between a single pair of OSPF routers, there is no need for designated or backup designated routers.

In a network with no designated router and no backup designated router, the neighboring router with the highest priority is elected as the DR, and the router with the next highest priority is elected as the BDR, as shown in the figure below. Priority is a configurable option at the interface level; refer to the `ip ospf priority` command in the *Brocade SLX-OS Command Reference*.

FIGURE 16 Designated and backup router election

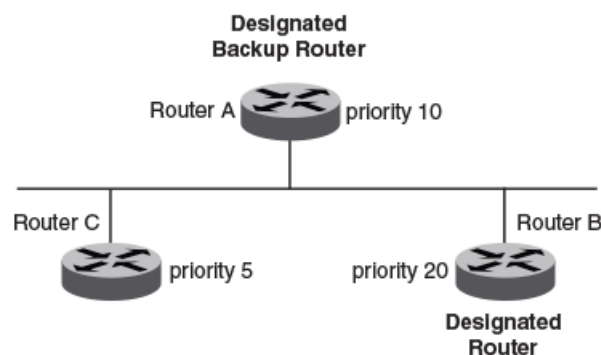

If the DR goes off line, the BDR automatically becomes the DR. The router with the next highest priority becomes the new BDR.

If two neighbors share the same priority, the router with the highest router ID is designated as the DR. The router with the next highest router ID is designated as the BDR. The DR and BDRs are recalculated after the OSPF protocol is disabled and re-enabled by means of the `[no] router ospf` command.

NOTE

By default, the Brocade device's router ID is the IP address configured on the lowest numbered loopback interface. If the device does not have a loopback interface, the default router ID is the lowest numbered IP address configured on the device.

When multiple routers on the same network are declaring themselves DRs, then both the priority and router ID are used to select the designated router and backup designated routers.

The DR and BDR election process is performed when one of the following events occurs:

- An interface is in a waiting state and the wait time expires.
- An interface is in a waiting state and receives a hello packet that addresses the BDR.
- A change in the neighbor state occurs, such as the following:
 - A neighbor state transitions from ATTEMPT state to a higher state.
 - Communication to a neighbor is lost.
 - A neighbor declares itself to be the DR or BDR for the first time.

Enabling OSPFv2

A number of steps are required when enabling OSPFv2 on a device.

Consider the following when enabling OSPFv2 on a device.

- Redistribution must be enabled on devices configured to operate as ASBRs.
 - All device ports must be assigned to one of the defined areas on an OSPF device. When a port is assigned to an area, all corresponding subnets on that port are automatically included in the assignment.
1. Enter the **router ospf** command in global configuration mode to enable OSPF on the device.
 2. Assign the areas to which the device will be attached.
 3. Assign individual interfaces to the OSPF areas.
 4. Assign a virtual link to any ABR that does not have a direct link to the OSPF backbone area.
 5. Refer to [Changing default settings](#) on page 200.

Backbone area

The backbone area (also known as area 0 or area 0.0.0.0) forms the core of OSPF networks. All other areas should be connected to the backbone area either by a direct link or by virtual link configuration. Routers that have interfaces in both backbone area and (at least one) non-backbone area are called Area Border Routers (ABR). Inter area routing happens via ABRs.

The backbone area is the logical and physical structure for the OSPF domain and is attached to all non-zero areas in the OSPF domain.

The backbone area is responsible for distributing routing information between non-backbone areas. The backbone must be contiguous, but it does not need to be physically contiguous; backbone connectivity can be established and maintained through the configuration of virtual links.

Assigning OSPFv2 areas

Areas can be assigned as OSPFv2 areas.

1. Enter the **configure terminal** command to access global configuration mode.

```
device# configure terminal
```

2. Enter the **router ospf** command to enter OSPF router configuration mode and enable OSPFv2 on the device.

```
device(config)# router ospf
```

3. Enter the **area** command to define an OSPFv2 area ID.

```
device(config-router-ospf-vrf-default-vrf)# area 0
```

4. Enter the **area** command to define a second OSPFv2 area ID.

```
device(config-router-ospf-vrf-default-vrf)# area 10.1.1.1
```

The following example assigns an OSPFv2 ID to two areas. One of the areas is assigned by decimal number. The second area is assigned by IP address.

```
device# configure terminal
device(config)# router ospf
device(config-router-ospf-vrf-default-vrf)# area 0
device(config-router-ospf-vrf-default-vrf)# area 10.1.1.1
```

Area range

You can further consolidate routes at an area boundary by defining an area range. The area range allows you to assign an aggregate address to a range of IP and IPv6 addresses.

This aggregate value becomes the address that is advertised instead of all the individual addresses it represents being advertised. Only this aggregate or summary address is advertised into other areas instead of all the individual addresses that fall in the configured range. Area range configuration can considerably reduce the number of Type 3 summary LSAs advertised by a device. You have the option of adding the cost to the summarized route. If you do not specify a value, the cost value is the default range metric calculation for the generated summary LSA cost. You can temporarily pause route summarization from the area by suppressing the type 3 LSA so that the component networks remain hidden from other networks.

You can assign up to 32 ranges in an OSPFv2 area.

Assigning an area range

Ranges for an area can be assigned. Ranges allow a specific IP address and mask to represent a range of IP addresses within an area, so that only that reference range address is advertised to the network, instead of all the addresses within that range. Each area can have up to 32 range addresses.

1. Enter the **configure terminal** command to access global configuration mode.

```
device# configure terminal
```

2. Enter the **router ospf** command to enter OSPF router configuration mode and enable OSPFv2 on the device.

```
device(config)# router ospf
```

3. Enter the **area range** command, specifying an area ID, and enter the range. Use the **cost** parameter to specify the cost value for the area range. Repeat as necessary.

```
device(config-ospf-router)# area 10.0.0.10 range 10.45.0.0 10.255.0.0 cost 20
device(config-ospf-router)# area 10.0.0.20 range 10.45.0.0 10.255.0.0 cost 20
```

The following example defines an area range for subnets on 10.0.0.10 and 10.0.0.20 and sets a cost of 20 for the area range.

```
device# configure terminal
device(config)# router ospf
device(config-ospf-router)# area 10.0.0.10 range 10.45.0.0 10.255.0.0 cost 20
device(config-ospf-router)# area 10.0.0.20 range 10.45.0.0 10.255.0.0 cost 20
```

Area types

OSPFv2 areas can be normal, a stub area, a totally stubby area (TSA), or a not-so-stubby area (NSSA).

- Normal: OSPFv2 devices within a normal area can send and receive external link-state advertisements (LSAs).
- Stub: OSPFv2 devices within a stub area cannot send or receive external LSAs. In addition, OSPFv2 devices in a stub area must use a default route to the area's Area Border Router (ABR) to send traffic out of the area.
- NSSA: The Autonomous System Boundary Router (ASBR) of an NSSA can import external route information into the area.
 - ASBRs redistribute (import) external routes into the NSSA as type 7 LSAs. Type 7 External LSAs are a special type of LSA generated only by ASBRs within an NSSA, and are flooded to all the routers within only that NSSA.
 - ABRs translate type 7 LSAs into type 5 External LSAs, which can then be flooded throughout the autonomous system. The NSSA translator converts a type 7 LSA to a type 5 LSA if F-bit and P-bit are set and there is a reachable forwarding address. You can configure summary-addresses on the ABR of an NSSA so that the ABR converts multiple type 7 external LSAs received from the NSSA into a single type 5 external LSA.

When an NSSA contains more than one ABR, OSPFv2 elects one of the ABRs to perform the LSA translation for NSSA. OSPFv2 elects the ABR with the highest router ID. If the elected ABR becomes unavailable, OSPFv2 automatically elects the ABR with the next highest router ID to take over translation of LSAs for the NSSA. The election process for NSSA ABRs is automatic.

- TSA: Similar to a stub area, a TSA does not allow summary routes in addition to not having external routes.

Stub area and totally stubby area

A stub area is an area in which advertisements of external routes are not allowed, reducing the size of the database. A totally stubby area (TSA) is a stub area in which summary link-state advertisement (type 3 LSAs) are not sent. A default summary LSA, with a prefix of 0.0.0.0/0 is originated into the stub area by an ABR, so that devices in the area can forward all traffic for which a specific route is not known, via ABR.

A stub area disables advertisements of external routes. By default, the ABR sends summary LSAs (type 3 LSAs) into stub areas. You can further reduce the number of LSAs sent into a stub area by configuring the device to stop sending type 3 LSAs into the area. You can disable the summary LSAs to create a TSA when you are configuring the stub area or after you have configured the area.

The ABR of a totally stubby area disables origination of summary LSAs into this area, but still accepts summary LSAs from OSPF neighbors and floods them to other neighbors.

When you enter the **area stub** command with the **no-summary** keyword and specify an area to disable the summary LSAs, the change takes effect immediately. If you apply the option to a previously configured area, the device flushes all the summary LSAs it has generated (as an ABR) from the area with the exception of the default summary LSA originated. This default LSA is needed for the internal routers, since external routes are not propagated to them.

NOTE

Stub areas and TSAs apply only when the device is configured as an Area Border Router (ABR) for the area. To completely prevent summary LSAs from being sent to the area, disable the summary LSAs on each OSPF router that is an ABR for the area.

Disabling summary LSAs for a stub area

LSAs can be disabled for a stub area.

1. Enter the **configure terminal** command to access global configuration mode.

```
device# configure terminal
```

2. Enter the **router ospf** command to enter OSPF router configuration mode and enable OSPFv2 on the device.

```
device(config)# router ospf
```

3. Enter the **area stub** command, specifying an area and a cost, followed by the **no-summary** parameter to set an additional cost on a specified stub area and prevent any Type 3 and Type 4 summary LSAs from being injected into the area.

```
device(config-router-ospf-vrf-default-vrf)# area 40 stub 99 no-summary
```

The following example configures a stub area, specifying a cost of 99 and preventing any Type 3 and Type 4 summary LSAs from being injected into the area.

```
device# configure terminal
device(config)# router ospf
device(config-router-ospf-vrf-default-vrf)# area 40 stub 99 no-summary
```

Not-so-stubby area (NSSA)

The OSPFv2 not-so-stubby area (NSSA) enables you to configure OSPFv2 areas that provide the benefits of stub areas, but that also are capable of importing external route information. OSPFv2 does not flood external routes from other areas into an NSSA, but does translate and flood route information from the NSSA into other areas such as the backbone. Since external routes are not published, a Type 7 default LSA with a prefix of `::/0` and a cost of 10 is originated into the NSSA area by the ABR to ensure that traffic passes through.

NSSAs are especially useful when you want to summarize type 5 External LSAs (external routes) before forwarding them into an OSPFv2 area. The OSPFv2 specification prohibits summarization of type 5 LSAs and requires OSPFv2 to flood type 5 LSAs throughout a routing domain. When you configure an NSSA, you can specify a summary-address for aggregating the external routes that the NSSA's ABR exports into other areas.

The figure below shows an example of an OSPFv2 network containing an NSSA.

FIGURE 17 OSPF network containing an NSSA

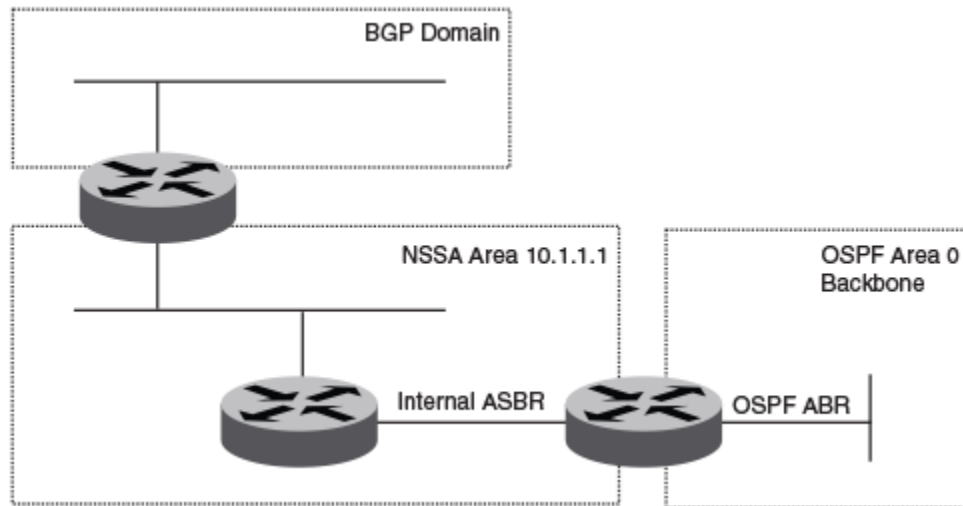

This example shows two routing domains, a BGP domain and an OSPF domain. The ASBR inside the NSSA imports external routes from BGP into the NSSA as type 7 LSAs, which the ASBR floods throughout the NSSA.

The ABR translates the type 7 LSAs into type 5 LSAs. If a summary-address is configured for the NSSA, the ABR also summarizes the LSAs into an aggregate LSA before flooding the type 5 LSAs into the backbone.

Because the NSSA is partially stubby the ABR does not flood external LSAs from the backbone into the NSSA. To provide access to the rest of the Autonomous System (AS), the ABR generates a default type 7 LSA into the NSSA.

ABRs of an NSSA area can be configured with the `no-summary` parameter to prevent the generation of type 3 and type 4 summary LSAs into the area. The only exception is the default type 3 LSA, with a prefix of 0.0.0.0/0. The default type 7 LSA is not originated in this case.

Configuring an NSSA

OSPFv2 areas can be defined as NSSA areas with modifiable parameters.

1. Enter the **configure terminal** command to access global configuration mode.

```
device# configure terminal
```

2. Enter the **router ospf** command to enter OSPF router configuration mode and enable OSPFv2 on the device.

```
device(config)# router ospf
```

3. Enter the **area nssa** command and specify an area address and a cost.

```
device(config-router-ospf-vrf-default-vrf)# area 10.1.1.1 nssa 1
```

Area 10.1.1.1 is defined as an NSSA.

The following example configures OSPF area 10.1.1.1 as an NSSA.

```
device# configure terminal
device(config)# router ospf
device(config-router-ospf-vrf-default-vrf)# area 10.1.1.1 nssa 1
```

Configuring a summary-address for the NSSA

If you want the ABR that connects the NSSA to other areas to summarize the routes in the NSSA before translating them into type 5 LSAs and flooding them into the other areas, configure an address range summary-address. The ABR creates an aggregate value based on the address range. The aggregate value becomes the address that the ABR advertises instead of advertising the individual addresses represented by the aggregate. You can configure up to 32 ranges in an OSPFv2 area.

1. Enter the **configure terminal** command to access global configuration mode.

```
device# configure terminal
```

2. Enter the **router ospf** command to enter OSPF router configuration mode and enable OSPFv2 on the device.

```
device(config)# router ospf
```

3. Enter the **area nssa** command, specifying an area and a cost.

```
device(config-router-ospf-vrf-default-vrf)# area 10.1.1.1 nssa 10
```

4. Enter the **summary-address** command, followed by the IP address and mask for the summary route.

The following example configures a summary-address in NSSA 10.1.1.1.

```
device# configure terminal
device(config)# router ospf
device(config-router-ospf-vrf-default-vrf)# area 10.1.1.1 nssa 10
device(config-router-ospf-vrf-default-vrf)# summary-address 10.10.1.0 10.10.2.0
```

Assigning interfaces to an area

Once you define OSPFv2 areas, you can assign interfaces to the areas. All device ports must be assigned to one of the defined areas on an OSPFv2 device. When a port is assigned to an area, all corresponding subnets on that port are automatically included in the assignment.

To assign a loopback interface to an area with the IP address of 10.5.0.0, perform the following task:

1. Enter the **configure terminal** command to access global configuration mode.

```
device# configure terminal
```

2. Enter the **interface** command and specify an interface.

```
device(config)# interface loopback 2
```

3. Enter the **ip ospf area** command followed by the IP address of the area.

```
device(config-Loopback-2)# ip ospf area 10.5.0.0
```

The following example assigns a loopback interface to an area with the IP address of 10.5.0.0.

```
device# configure terminal
device(config)# interface loopback 2
device(config-Loopback-2)# ip ospf area 10.5.0.0
```

Link state advertisements

Communication among areas is provided by means of link state advertisements (LSAs). The LSAs supported for each area type are as follows:

- Backbone (area 0) supports LSAs 1, 2, 3, 4, and 5.
- Nonbackbone, supports LSAs 1, 2, 3, 4, and 5.
- Stub area supports LSAs 1, 2, and 3.
- Totally stubby area (TSA) supports LSAs 1 and 2, and also supports a single LSA 3 per ABR, advertising a default route.
- No so stubby area (NSSA) supports LSAs 1, 2, 3, and 7.

Configuring an MD5 password and authentication change hold time for an OSPFv2 interface

An MD5 password and authentication change hold time can be configured. This task sets an MD5 password and sets an authentication change hold time for an OSPFv2 Ethernet interface

1. Enter the **configure terminal** command to access global configuration mode.

```
device# configure terminal
```

2. Enter the **interface** command and specify an interface.

```
device(config)# interface ethernet 0/1
```

3. Enter the **ip ospf md5-authentication** command with the **key-activation-wait-time** parameter, and specify a time interval, to set the time that OSPFv2 waits before activating a new MD5 key.

```
device(conf-if-eth-0/1)# ip ospf md5-authentication key-activation-wait-time 240
```

4. Enter the **ip ospf md5-authentication** command with the **key-id** and **key** parameters to set the MD5 key ID and a password.

```
device(conf-if-eth-0/1)# ip ospf md5-authentication key-id 22 key myospfpassword
```

The following example sets the time that OSPFv2 waits before activating a new MD5 key to 240 seconds on an Ethernet interface, and sets the MD5 key ID to 22 and a password "myospfpassword" on an Ethernet interface.

```
device# configure terminal
device(config)# interface ethernet 0/1
device(conf-if-eth-0/1)# ip ospf md5-authentication key-activation-wait-time 240
device(conf-if-eth-0/1)# ip ospf md5-authentication key-id 22 key myospfpassword
```

Virtual links

All ABRs must have either a direct or indirect link to the OSPFv2 backbone area (0.0.0.0 or 0). If an ABR does not have a physical link to the area backbone, the ABR can configure a virtual link to another router within the same area, which has a physical connection to the area backbone.

The path for a virtual link is through an area shared by the neighbor ABR (router with a physical backbone connection), and the ABR requires a logical connection to the backbone.

Two parameters fields must be defined for all virtual links—transit area ID and neighbor router:

- The transit area ID represents the shared area of the two ABRs and serves as the connection point between the two routers. This number should match the area ID value.
- The neighbor router field is the router ID (IP address) of the router that is physically connected to the backbone, when assigned from the router interface requiring a logical connection. When assigning the parameters from the router with the physical connection, be aware that the router ID is the IP address of the router requiring a logical connection to the backbone.

NOTE

By default, a device's router ID is the IP address configured on the lowest numbered loopback interface. If the device does not have a loopback interface, the default router ID is the lowest numbered IP address configured on the device. When you establish an area virtual link, you must configure it on both of the routers (both ends of the virtual link).

Virtual links cannot be configured in stub areas and NSSAs.

The following figure shows an OSPF area border router, Device A, that is cut off from the backbone area (area 0). To provide backbone access to Device A, you can add a virtual link between Device A and Device C using Area 1 as a transit area. To configure the virtual link, you define the link on the router that is at each end of the link. No configuration for the virtual link is required on the routers in the transit area.

FIGURE 18 Defining OSPF virtual links within a network

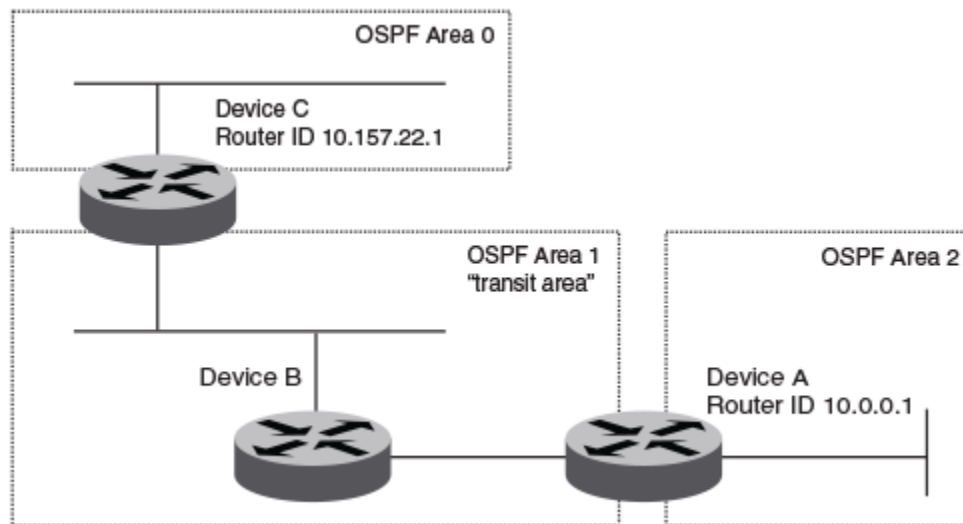

Configuring virtual links

If an Area Border Router (ABR) does not have a physical link to a backbone area, a virtual link can be configured between that ABR and another device within the same area that has a physical link to a backbone area.

A virtual link is configured, and a virtual link endpoint on two devices, ABR1 and ABR2, is defined.

1. On ABR1, enter the **configure terminal** command to access global configuration mode.

```
device# configure terminal
```

2. Enter the **router ospf** command to enter OSPF router configuration mode and enable OSPFv2 on the device.

```
device(config)# router ospf
```

3. Enter the **area** command to assign an OSPFv2 area ID.

```
device(config-router-ospf-vrf-default-vrf)# area 0
```

4. Enter the **area** command to assign an OSPFv2 area ID.

```
device(config-router-ospf-vrf-default-vrf)# area 1
```

5. Enter the **area virtual-link** command and the ID of the OSPFv2 device at the remote end of the virtual link to configure the virtual link endpoint.

```
device(config-router-ospf-vrf-default-vrf)# area 1 virtual-link 10.2.2.2
```

6. On ABR2, enter the **configure terminal** command to access global configuration mode.

```
device# configure terminal
```

7. Enter the **router ospf** command to enter OSPFv2 router configuration mode and enable OSPFv2 on the device.

```
device(config)# router ospf
```

8. Enter the **area** command to assign an OSPFv2 area ID.

```
device(config-router-ospf-vrf-default-vrf)# area 1
```

9. Enter the **area** command to assign an OSPFv2 area ID.

```
device(config-router-ospf-vrf-default-vrf)# area 2
```

10. Enter the **area virtual-link** command and the ID of the OSPFv2 device at the remote end of the virtual link to configure the virtual link endpoint.

```
device(config-router-ospf-vrf-default-vrf)# area 1 virtual-link 10.1.1.1
```

The following example configures a virtual link between two devices.

```
ABR1:
device1# configure terminal
device1(config)# router ospf
device1(config-router-ospf-vrf-default-vrf)# area 0
device1(config-router-ospf-vrf-default-vrf)# area 1
device1(config-router-ospf-vrf-default-vrf)# area 1 virtual-link 10.2.2.2
```

```
ABR2:
device2# configure terminal
device2(config)# router ospf
device2(config-router-ospf-vrf-default-vrf)# area 1
device2(config-router-ospf-vrf-default-vrf)# area 2
device2(config-router-ospf-vrf-default-vrf)# area 1 virtual-link 10.1.1.1
```

Default route origination

When the device is an OSPFv2 Autonomous System Boundary Router (ASBR), you can configure it to automatically generate a default external route into an OSPFv2 routing domain.

By default, a device does not advertise the default route into the OSPFv2 domain. If you want the device to advertise the OSPFv2 default route, you must explicitly enable default route origination. When you enable OSPFv2 default route origination, the device advertises a type 5 default route that is flooded throughout the autonomous system, with the exception of stub areas.

The device advertises the default route into OSPFv2 even if OSPFv2 route redistribution is not enabled, and even if the default route is learned through an iBGP neighbor when default-information-originate is configured. The device does not, however, originate the default route if the active default route is learned from an OSPFv2 device in the same domain.

NOTE

The device does not advertise the OSPFv2 default route, regardless of other configuration parameters, unless you explicitly enable default route origination.

If default route origination is enabled and you disable it, the default route originated by the device is flushed. Default routes generated by other OSPFv2 devices are not affected. If you re-enable the default route origination, the change takes effect immediately and you do not need to reload the software.

External route summarization

An ASBR can be configured to advertise one external route as an aggregate for all redistributed routes that are covered by a specified address range.

When you configure a summary address range, the range takes effect immediately. All the imported routes are summarized according to the configured summary address range. Imported routes that have already been advertised and that fall within the range are flushed out of the autonomous system and a single route corresponding to the range is advertised.

If a route that falls within a configured summary address range is imported by the device, no action is taken if the device has already advertised the aggregate route; otherwise, the device advertises the aggregate route. If an imported route that falls within a configured summary address range is removed by the device, no action is taken if there are other imported routes that fall within the same summary address range; otherwise, the aggregate route is flushed.

You can configure up to 32 summary address ranges. The device sets the forwarding address of the aggregate route to 0 and sets the tag to 0. If you delete a summary address range, the advertised aggregate route is flushed and all imported routes that fall within the range are advertised individually. If an external link-state database (LSDB) overflow condition occurs, all aggregate routes and other external routes are flushed out of the autonomous system. When the device exits the external LSDB overflow condition, all the imported routes are summarized according to the configured summary address ranges.

NOTE

If you use redistribution filters in addition to summary address ranges, the device applies the redistribution filters to routes first, and then applies them to the summary address ranges.

NOTE

If you disable redistribution, all the aggregate routes are flushed, along with other imported routes.

NOTE

Only imported, type 5 external LSA routes are affected. A single type 5 LSA is generated and flooded throughout the autonomous system for multiple external routes.

Modifying Shortest Path First timers

The Shortest Path First (SPF) throttle timers can be modified.

1. Enter the **configure terminal** command to access global configuration mode.

```
device# configure terminal
```

2. Enter the **router ospf** command to enter OSPF router configuration mode and enable OSPFv2 globally.

```
device(config)# router ospf
```

3. Enter the **timers** command with the **throttle spf** keyword and specify the SPF delay, the hold time, and the maximum wait time.

```
device(config-router-ospf-vrf-default-vrf)# timers throttle spf 100 500 5000
```

The following example sets the SPF initial delay to 100 milliseconds, the hold time to 500 milliseconds, and the maximum wait time to 5000 milliseconds.

```
device# configure terminal
device(config)# router ospf
device(config-router-ospf-vrf-default-vrf)# timers throttle spf 100 500 5000
```

OSPFv2 administrative distance

Devices can learn about networks from various protocols and select a route based on the source of the route information. This decision can be influenced if the default administrative distance for OSPFv2 routes is changed. Consequently, the routes to a network may differ depending on the protocol from which the routes were learned.

You can influence the device's decision by changing the default administrative distance for OSPFv2 routes. You can configure a unique administrative distance for each type of OSPFv2 route. For example, you can configure the Brocade device to prefer a static route over an OSPFv2 inter-area route and to prefer OSPFv2 intra-area routes over static routes. The distance you specify influences the choice of routes when the device has multiple routes to the same network from different protocols. The device prefers the route with the lower administrative distance.

You can specify unique default administrative distances for the following OSPFv2 route types:

- External routes
- Intra-area routes
- Inter-area routes
- Route maps

NOTE

The choice of routes within OSPFv2 is not influenced. For example, an OSPFv2 intra-area route is always preferred over an OSPFv2 inter-area route, even if the intra-area route's distance is greater than the inter-area route's distance.

Configuring administrative distance based on route type

The default administrative distances for intra-area routes, inter-area routes, route maps, and external routes can be altered.

1. Enter the **configure terminal** command to access global configuration mode.

```
device# configure terminal
```

2. Enter the **ipv6 router ospf** command to enter OSPFv3 router configuration mode and enable OSPFv3 globally.

```
device(config)# ipv6 router ospf
```

3. Enter the **distance** command with the **intra-area** parameter.

```
device(config-ipv6-router-ospf-vrf-default-vrf)# distance intra-area 80
```

The administrative distance for intra-area routes is changed from the default to 80.

4. Enter the **distance** command with the **inter-area** parameter.

```
device(config-ipv6-router-ospf-vrf-default-vrf)# distance inter-area 90
```

The administrative distance for inter-area routes is changed from the default to 90.

5. Enter the **distance** command with the **route-map** parameter.

```
device(config-ipv6-router-ospf-vrf-default-vrf)# distance route-map 85
```

The administrative distance for inter-area routes is changed from the default to 85.

6. Enter the **distance** command with the **external** parameter.

```
device(config-ipv6-router-ospf-vrf-default-vrf)# distance external 100
```

The administrative distance for external routes is changed from the default to 100.

The following example changes the default administrative distances for intra-area routes, inter-area routes, and external routes.

```
device# configure terminal
device(config)# ipv6 router ospf
device(config-ipv6-router-ospf-vrf-default-vrf)# distance intra-area 80
device(config-ipv6-router-ospf-vrf-default-vrf)# distance inter-area 90
device(config-ipv6-router-ospf-vrf-default-vrf)# distance route-map 85
device(config-ipv6-router-ospf-vrf-default-vrf)# distance external 100
```

OSPFv2 LSA refreshes

To prevent a refresh from being performed each time an individual LSA's refresh timer expires, OSPFv2 LSA refreshes are delayed for a specified time interval. This pacing interval can be altered.

The device paces OSPFv2 LSA refreshes by delaying the refreshes for a specified time interval instead of performing a refresh each time an individual LSA's refresh timer expires. The accumulated LSAs constitute a group, which the device refreshes and sends out together in one or more packets.

The pacing interval, which is the interval at which the device refreshes an accumulated group of LSAs, is configurable in a range from 10 through 1800 seconds (30 minutes). The default is 240 seconds (4 minutes). Thus, every four minutes, the device refreshes the group of accumulated LSAs and sends the group together in the same packets.

The pacing interval is inversely proportional to the number of LSAs the device is refreshing and aging. For example, if you have approximately 10,000 LSAs, decreasing the pacing interval enhances performance. If you have a very small database (40 to 100 LSAs), increasing the pacing interval to 10 to 20 minutes may enhance performance only slightly.

Configuring the OSPFv2 LSA pacing interval

The interval between OSPFv2 LSA refreshes can be modified.

1. Enter the **configure terminal** command to access global configuration mode.

```
device# configure terminal
```

2. Enter the **router ospf** command to enter OSPF router configuration mode and enable OSPFv2 globally.

```
device(config)# router ospf
```

3. Enter the **timers** command with the **lsa-group-pacing** parameter.

```
device(config-router-ospf-vrf-default-vrf)# timers lsa-group-pacing 120
```

The OSPFv2 LSA pacing interval is changed to 120 seconds (2 minutes).

The following example changes the OSPFv2 LSA pacing interval is changed to 120 seconds (2 minutes).

```
device# configure terminal
device(config)# router ospf
device(config-router-ospf-vrf-default-vrf)# timers lsa-group-pacing 120
```

Redistributing routes into OSPFv2

OSPFv2 routes can be redistributed, and the routes to be redistributed can be specified.

The redistribution of BGP, connected, and static IP routes into OSPFv2 is configured on a device.

1. Enter the **configure terminal** command to access global configuration mode.

```
device# configure terminal
```

2. Enter the **router ospf** command to enter OSPFv2 router configuration mode and enable OSPFv2 on the device.

```
device(config)# router ospf
```

3. Enter the **redistribute** command with the **static** parameter to redistribute static routes.

```
device(config-router-ospf-vrf-default-vrf)# redistribute static
```

4. Enter the **redistribute** command with the **connected** parameter to redistribute static routes.

```
device(config-router-ospf-vrf-default-vrf)# redistribute connected
```

5. Enter the **redistribute** command with the **bgp** parameter to redistribute BGP routes.

```
device(config-router-ospf-vrf-default-vrf)# redistribute bgp
```

The following example redistributes static and BGP routes into OSPFv2 on a device.

```
device# configure terminal
device(config)# router ospf
device(config-router-ospf-vrf-default-vrf)# redistribute static
device(config-router-ospf-vrf-default-vrf)# redistribute connected
device(config-router-ospf-vrf-default-vrf)# redistribute bgp
```

OSPFv2 type 3 LSA filtering

OSPFv2 type 3 LSA filtering provides an ABR that is running the OSPFv2 protocol with the ability to filter type 3 link-state advertisements (LSAs) that are sent between different OSPFv2 areas. Filtering of routes can be defined using prefix-list filters to either permit or deny certain prefixes. Only specified prefixes can be sent from one area to another area and all other prefixes are prohibited. OSPFv2 type 3 LSA filtering can be applied for the LSAs coming into a specific OSPFv2 area or going out of a specific OSPFv2 area, or into and out of the same OSPFv2 areas concurrently. Any change in the prefix-list used for type 3 filtering may result in the advertisement of new summary LSAs or the withdrawal of previously advertised summary LSAs.

Type 3 LSAs refer to summary links and are sent by ABRs to advertise destinations outside the area. OSPFv2 type 3 LSA filtering gives the administrator improved control of route distribution between OSPFv2 areas.

In certain situations, reachability for some IP network prefixes from outside of an area or to a specific area should be restricted. Such a situation is illustrated in the figure below where a device called R3 is advertising stub networks that belong to the non-backbone area (Area1). An ABR, R2, will generate summary routes for these prefixes. If OSPFv2 type 3 LSA filtering is not configured, all the stub networks are seen as summary LSAs in the backbone area (Area 0) and are flooded to all applicable OSPFv2 devices. These type 3 LSAs can be filtered out using the OSPFv2 type3 LSA Filter.

FIGURE 19 OSPFv2 type 3 LSA filtering

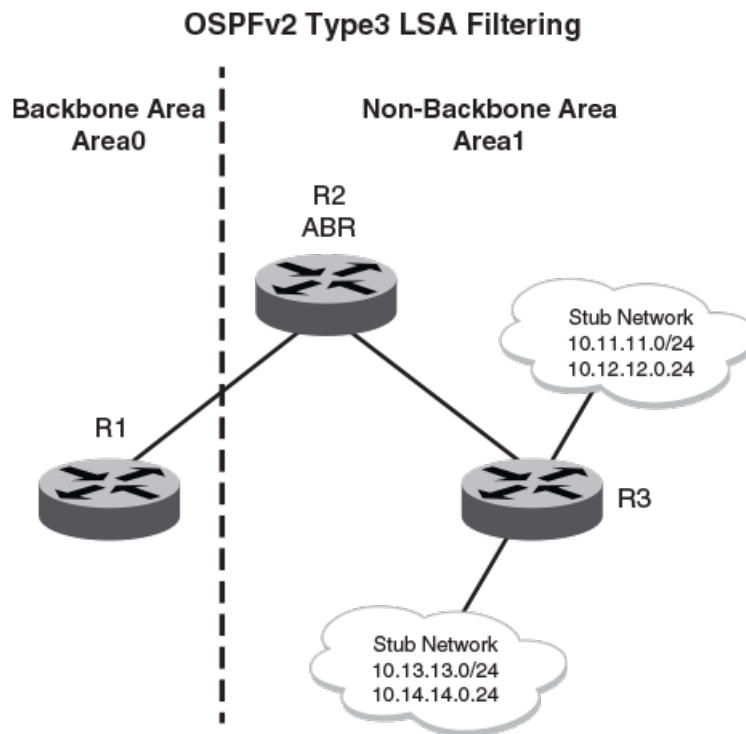

Usage and configuration guidelines

- OSPFv2 type 3 LSA filtering is only applicable to ABRs. Configurations are accepted prior to the device becoming an ABR but OSPFv2 type 3 LSA filtering only occurs once the device becomes an ABR.
- When OSPFv2 type 3 LSA filtering is enabled in the "in" direction, all type 3 LSAs originated by the ABR to this area are filtered by the prefix list, based on information from all other areas. Type 3 LSAs, originated as a result of the **area range** command in a different area, are treated like any other individually originated type 3 LSA. Any prefix that does not match an entry in the prefix list is implicitly denied.
- When OSPFv2 type 3 LSA filtering is enabled in the "out" direction, all type 3 LSAs advertised by the ABR are filtered by the prefix list, based on information from this area to all other areas. If the **area range** command has been used to configure type 3 LSAs for this area, these type 3 LSAs that correspond to these configurations are treated like any other type 3 LSA. Prefixes that do not match are implicitly denied.
- Type 3 LSAs received from other devices are not filtered out. The OSPFv2 type 3 LSA filter is only applied when the ABR generates summary routes to advertise.
- If a prefix-list used in type 3 LSA filtering is not created or defined, all summary LSAs are discarded.
- OSPFv2 type 3 LSA filtering is supported for both default VRFs and non-default VRFs.

Configuring OSPFv2 type 3 LSA filtering

An IP prefix list can be configured and applied to an OSPFv2 area.

1. Enter the **configure terminal** command to access global configuration mode.

```
device# configure terminal
```

2. Enter the **ip prefix-list** command and specify a name.

```
device(config)# ip prefix-list mylist permit 10.1.0.0/16
```

Configures an IP prefix list named "mylist" that permits routes to network 10.1.0.0/16.

3. Enter the **router ospf** command to enter OSPF router configuration mode and enable OSPFv2 on the device.

```
device(config)# router ospf
```

4. Enter the **area** command to define an OSPFv2 area ID.

```
device(config-router-ospf-vrf-default-vrf)# area 1
```

5. Enter the **area prefix-list** command and specify an area address and a prefix-list.

```
device(config-router-ospf-vrf-default-vrf)# area 1 prefix-list mylist out
```

Configures the device to use the IP prefix list "mylist" to determine which routes from Area 1 are advertised to other areas. The device advertises routes that fall within the 10.1.0.0/16 range to other areas because the IP prefix list explicitly permits these routes to be sent to other areas from Area 1.

The following example configures an IP prefix list named "mylist" that permits routes to network 10.1.0.0/16. This list is used to determine which routes to send to Area 1.

```
device# configure terminal
device(config)# ip prefix-list mylist permit 10.1.0.0/16
device(config)# router ospf
device(config-router-ospf-vrf-default-vrf)# area 1
device(config-router-ospf-vrf-default-vrf)# area 1 prefix-list mylist out
```

OSPFv2 over VRF

OSPFv2 can run over multiple Virtual Routing and Forwarding (VRF) instances. All OSPFv2 commands are available over default and non-default OSPF instances.

OSPFv2 maintains multiple instances of the routing protocol to exchange route information among various VRF instances. A multi-VRF-capable device maps an input interface to a unique VRF, based on user configuration. These input interfaces can be physical or a virtual interface. By default, all input interfaces are attached to the default VRF instance.

Multi-VRF for OSPF (also known as VRF-Lite for OSPF) provides a reliable mechanism for trusted VPNs to be built over a shared infrastructure. The ability to maintain multiple virtual routing or forwarding tables allows overlapping private IP addresses to be maintained across VPNs.

Enabling OSPFv2 in a non-default VRF

When OSPFv2 is enabled in a non-default VRF instance, the device enters OSPF router VRF configuration mode. Several commands can then be accessed that allow the configuration of OSPFv2.

A non-default VRF instance has been configured.

1. Enter the **configure terminal** command to access global configuration mode.

```
device# configure terminal
```

2. Enter the **router ospf** command and specify a VRF name to enter OSPF router VRF configuration mode and enable OSPFv2 on a non-default VRF.

```
device(config)# router ospf vrf green
```

The following example enables OSPFv2 in a non-default VRF.

```
device# configure terminal
device(config)# router ospf vrf green
device(config-router-ospf-vrf-green)#
```

Configuring the OSPFv2 Max-Metric Router LSA

By configuring the OSPFv2 max-metric router LSA you can enable OSPFv2 to advertise its locally generated router LSAs with a maximum metric.

NOTE

You can configure OSPFv2 max-metric router LSA in either startup or non-startup mode. When you configure max-metric in non-startup mode, it only applies once and is not persistent across reloads or after the **clear ip ospf all** command is issued.

1. Enter the **configure terminal** command to access global configuration mode.

```
device# configure terminal
```

2. Enter the **router ospf** command to enter OSPF router configuration mode and enable OSPFv2 on the device.

```
device(config)# router ospf
```

3. Enter the **max-metric router-lsa** command with the **all-lsas** parameter to set the summary-lsa and external-lsa parameters to the corresponding default max-metric value. .

```
device(config-router-ospf-vrf-default-vrf)# max-metric router-lsa all-lsas
```

The following example configures an OSPFv2 device to advertise the maximum metric value using the **all-lsas** parameter.

```
device# configure terminal
device(config)# router ospf
device(config-router-ospf-vrf-default-vrf)# max-metric router-lsa all-lsas
```

Re-enabling OSPFv2 compatibility with RFC 1583

OSPFv2 is compatible with RFC 1583 and maintains a single best route to an autonomous system (AS) boundary router in the OSPF routing table. Disabling this compatibility causes the OSPF routing table to maintain multiple intra-AS paths, which helps prevent routing loops. You can re-enable OSPFv2 compatibility with RFC 1583 if it has been disabled.

1. Enter the **configure terminal** command to access global configuration mode.

```
device# configure terminal
```

2. Enter the **ip router ospf** command to enter OSPF router configuration mode and enable OSPFv2 on the device.

```
device(config)# router ospf
```

3. Enter the **rfc1583-compatibility** command to re-enable OSPFv2 compatibility with RFC 1583.

```
device(config-router-ospf-vrf-default-vrf)# rfc1583-compatibility
```

The following example re-enables OSPFv2 compatibility with RFC 1583.

```
device# configure terminal
device(config)# router ospf
device(config-router-ospf-vrf-default-vrf)# rfc1583-compatibility
```

Changing default settings

Refer to the relevant Command Reference for other commands you can use to change default OSPF settings. Some commonly configured items include the following:

- Changing reference bandwidth to change interface costs by using the **auto-cost reference-bandwidth** command.
- Defining redistribution filters for the Autonomous System Boundary Router (ASBR) by using the **redistribute** command.

Disabling and re-enabling OSPFv2 event logging

OSPFv2 event logging can be configured, disabled, and re-enabled.

1. Enter the **configure terminal** command to access global configuration mode.

```
device# configure terminal
```

2. Enter the **router ospf** command to enter OSPF router configuration mode and enable OSPFv2 globally.

```
device(config)# router ospf
```

3. Enter the **no log all** command to disable the logging of all OSPFv2 events.

```
device(config-router-ospf-vrf-default-vrf)# no log all
```

The following example re-enables the logging of all OSPFv2 events.

```
device# configure terminal
device(config)# router ospf
device(config-router-ospf-vrf-default-vrf)# log all
```

Understanding the effects of disabling OSPFv2

Consider the following before disabling OSPFv2 on a device:

- If you disable OSPFv2, the device removes all the configuration information for the disabled protocol from the running configuration. Moreover, when you save the configuration to the running configuration file after disabling one of these protocols, all the configuration information for the disabled protocol is removed from the running configuration file.
- If you are testing an OSPFv2 configuration and are likely to disable and re-enable the protocol, you might want to make a backup copy of the running configuration file containing the protocol's configuration information. This way, if you remove the configuration information by saving the configuration after disabling the protocol, you can restore the configuration by copying the backup copy of the startup configuration file into the flash memory.

Displaying OSPFv2 results

The **show ip ospf** command and its variations can be used to display information about OSPFv2 configurations.

Use one or more of the following commands to verify OSPFv2 information. Using the **show ip ospf** command is optional, and the variations of the command can be entered in any order.

1. In privileged EXEC mode, enter the **show ip ospf** command to display general OSPFv2 information.

```
device# show ip ospf
```

The example output displays general OSPFv2 information and indicates that the device is not operating as an ASBR. If the device is not operating as an ASBR, there is no information about redistribution in the output.

2. Enter the **show ip ospf area** command to display information about an OSPFv2 area.

```
device# show ip ospf area
```

The example output displays detailed output for OSPFv2 Area 0.

3. Enter the **show ip ospf interface** command to display OSPFv2 interface information.

```
device# show ip ospf interface
```

The example output displays detailed output for OSPFv2 interfaces.

4. Enter the **show ip ospf interface** command with the **brief** parameter to display summarized OSPFv2 interface information.

```
device# show ip ospf interface brief
```

The example output displays summarized output for OSPFv2 interfaces.

5. Enter the **show ip ospf neighbor** command to display OSPFv2 neighbor information for the device.

```
device# show ip ospf neighbor
```

The example output displays output for an OSPFv2 neighbor.

6. Enter the **show ip ospf routes** command to display information about OSPFv2 routes.

```
device# show ip ospf routes
```

7. Enter the **show ip ospf summary** command to display summary output for OSPFv2 sessions.

```
device# show ip ospf summary
```

8. Enter the **show ip ospf traffic** command to display OSPF traffic details.

```
device# show ip ospf traffic
```

OSPFv3

• OSPFv3 overview.....	203
• Configuring the router ID.....	204
• Enabling OSPFv3.....	204
• Configuring OSPFv3.....	204
• OSPFv3 areas.....	205
• Virtual links.....	210
• OSPFv3 route redistribution.....	213
• Default route origination.....	215
• Filtering OSPFv3 routes.....	215
• SPF timers.....	216
• OSPFv3 administrative distance.....	217
• Changing the reference bandwidth for the cost on OSPFv3 interfaces.....	218
• OSPFv3 LSA refreshes.....	218
• External route summarization.....	219
• OSPFv3 over VRF.....	220
• Setting all OSPFv3 interfaces to the passive state.....	220
• OSPFv3 max-metric router LSA.....	221
• IPsec for OSPFv3.....	222
• Displaying OSPFv3 results.....	226

OSPFv3 overview

Open Shortest Path First (OSPF) is a link-state routing protocol. Each OSPF device originates link-state advertisement (LSA) packets to describe its link information. These LSAs are flooded throughout the OSPF area. The flooding algorithm ensures that every device in the area has an identical database. Each device in the area then calculates a Shortest Path Tree (SPT) that shows the shortest distance to every other device in the area, using the topology information in the Link State database..

IPv6 supports OSPF Version 3 (OSPFv3), which functions similarly to OSPFv2, the version that IPv4 supports, except for the following enhancements:

- Support for IPv6 addresses and prefixes.
- Ability to configure several IPv6 addresses on a device interface. (While OSPFv2 runs per IP subnet, OSPFv3 runs per link. In general, you can configure several IPv6 addresses on a router interface, but OSPFv3 forms one adjacency per interface only, using the link local address of the interface as the source for OSPF protocol packets. On virtual links, OSPFv3 uses the global IP address as the source. OSPFv3 imports all or none of the address prefixes configured on a router interface. You cannot select the addresses to import.)
- Ability to run one instance of OSPFv2 and one instance of OSPFv3 concurrently on a link.
- Support for IPv6 link-state advertisements (LSAs).

NOTE

Although OSPFv2 and OSPFv3 function in a similar manner, Brocade has implemented the user interface for each version independently of the other. Therefore, any configuration of OSPFv2 features will not affect the configuration of OSPFv3 features and vice versa.

Configuring the router ID

When configuring OSPFv3, the router ID for a device must be specified.

1. Enter the **configure terminal** command to access global configuration mode.

```
device# configure terminal
```

2. Enter the **ip router-id** command to specify the router ID.

```
device(config) ip router-id 10.11.12.13
```

The following example configures the router ID for a device.

```
device# configure terminal
device(config)# ip router-id 10.11.12.13
```

Enabling OSPFv3

When OSPFv3 is enabled on a device, the device enters OSPFv3 router configuration mode. Several commands can then be accessed that allow the configuration of OSPFv3.

1. Enter the **configure terminal** command to access global configuration mode.

```
device# configure terminal
```

2. Enter the **ip router-id** command to specify the router ID.

```
device(config) ip router-id 10.11.12.13
```

3. Enter the **ipv6 router ospf** command to enter OSPFv3 router configuration mode and enable OSPFv3 on the device.

```
device(config)# ipv6 router ospf
```

The following example enables OSPFv3 on a device.

```
device# configure terminal
device(config)# ip router-id 10.11.12.13
device(config)# ipv6 router ospf
device(config-ipv6-router-ospf-vrf-default-vrf)#
```

Configuring OSPFv3

A number of steps are required when configuring OSPFv3:

- Configure the router ID.
- Enable OSPFv3 globally.
- Assign OSPFv3 areas.
- Assign OSPFv3 areas to interfaces.

OSPFv3 areas

After OSPFv3 is enabled, you can assign OSPFv3 areas. You can specify the area id in plain number format , such as "area 1", or in ipv4 address format, such as 10.1.1.1. Each device interface can support one area.

NOTE

You can assign only one area on a device interface.

NOTE

You are required to configure a router ID when running only IPv6 routing protocols.

NOTE

By default, the router ID is the IPv4 address configured on the lowest-numbered loopback interface. If the device does not have a loopback interface, the default router ID is the highest-numbered IPv4 address configured on the device. You can also configure router id using the **ip router-id** command.

Backbone area

The backbone area (also known as area 0 or area 0.0.0.0) forms the core of OSPF networks. All other areas should be connected to the backbone area either by a direct link or by virtual link configuration. Routers that have interfaces in both backbone area and (at least one) non-backbone area are called Area Border Routers (ABR). Inter area routing happens via ABRs.

The backbone area is the logical and physical structure for the OSPF domain and is attached to all non-zero areas in the OSPF domain.

The backbone area is responsible for distributing routing information between non-backbone areas. The backbone must be contiguous, but it does not need to be physically contiguous; backbone connectivity can be established and maintained through the configuration of virtual links.

Area range

You can further consolidate routes at an area boundary by defining an area range. The area range allows you to assign an aggregate address to a range of IP and IPv6 addresses.

This aggregate value becomes the address that is advertised instead of all the individual addresses it represents being advertised. Only this aggregate or summary address is advertised into other areas instead of all the individual addresses that fall in the configured range. Area range configuration can considerably reduce the number of Type 3 summary LSAs advertised by a device. You have the option of adding the cost to the summarized route. If you do not specify a value, the cost value is the default range metric calculation for the generated summary LSA cost. You can temporarily pause route summarization from the area by suppressing the type 3 LSA so that the component networks remain hidden from other networks.

You can assign up to 4 ranges in an OSPFv3 area.

Area types

OSPFv3 areas can be normal, a stub area, a totally stubby area (TSA), or a not-so-stubby area (NSSA).

- Normal: OSPFv3 devices within a normal area can send and receive external link-state advertisements (LSAs).
- Stub: OSPFv3 devices within a stub area cannot send or receive External LSAs. In addition, OSPF devices in a stub area must use a default route to the area's Area Border Router (ABR) to send traffic out of the area.
- TSA: A form of stub area, where Type 3 summary routes are also not propagated in addition to Type 5 external routes.

- NSSA: A form of stub area, where Type 5 external routes by Autonomous System Boundary Routers (ASBRs) outside this area are not propagated, but where it is allowed to have an ASBR in the area, that can advertise external information.
 - ASBRs redistribute (import) external routes into the NSSA as type 7 LSAs. Type 7 External LSAs are a special type of LSA generated only by ASBRs within an NSSA, and are flooded to all the routers within only that NSSA.
 - One of the ABRs of the NSSA area is selected as a NSSA translator, and this router translates the area-specific Type 7 LSAs to Type 5 external LSAs which can be flooded throughout the Autonomous System (except NSSA and stub areas).

When an NSSA contains more than one ABR, OSPFv3 elects one of the ABRs to perform the LSA translation for NSSA. OSPF elects the ABR with the highest router ID. If the elected ABR becomes unavailable, OSPFv3 automatically elects the ABR with the next highest router ID to take over translation of LSAs for the NSSA. The election process for NSSA ABRs is automatic.

Assigning OSPFv3 areas

Areas can be assigned as OSPFv3 areas.

Enable IPv6 on each interface on which you plan to enable OSPFv3. You enable IPv6 on an interface by configuring an IP address or explicitly enabling IPv6 on that interface.

1. Enter the **configure terminal** command to access global configuration mode.

```
device# configure terminal
```

2. Enter the **ip router-id** command to specify the router ID.

```
device(config) ip router-id 10.11.12.13
```

3. Enter the **ipv6 router ospf** command to enter OSPFv3 router configuration mode and enable OSPFv3 on the device.

```
device(config)# ipv6 router ospf
```

4. Enter the **area** command to define an OSPFv3 area ID.

```
device(config-ipv6-router-ospf-vrf-default-vrf)# area 0
```

5. Enter the **area** command to define a second OSPFv3 area ID.

```
device(config-ipv6-router-ospf-vrf-default-vrf)# area 10.1.1.1
```

The following example assigns an OSPFv3 ID to two areas. One of the areas is assigned by decimal number. The second area is assigned by IP address.

```
device# configure terminal
device(config)# ip router-id 10.11.12.13
device(config)# ipv6 router ospf
device(config-ipv6-router-ospf-vrf-default-vrf)# area 0
device(config-ipv6-router-ospf-vrf-default-vrf)# area 10.1.1.1
```

Assigning OSPFv3 areas to interfaces

Defined OSPFv3 areas can be assigned to device interfaces.

Ensure that OSPFv3 areas are assigned.

NOTE

All device interfaces must be assigned to one of the defined areas on an OSPFv3 device. When an interface is assigned to an area, all corresponding subnets on that interface are automatically included in the assignment.

1. Enter the **configure terminal** command to access global configuration mode.

```
device# configure terminal
```

2. Enter the **interface** command and specify an interface.

```
device(config)# interface ethernet 0/1
```

3. Enter the **ipv6 address** command to add an IPv6 address to the interface.

```
device(config-if-eth-0/1)# ipv6 address 2001:1:0::1:1/64
```

4. Enter the **ipv6 ospf area** command.

```
device(config-if-eth-0/1)# ipv6 ospf area 0
```

Area 0 is assigned to the specified interface with the IPv6 address of 2001:1:0:1::1/64.

5. Enter the **exit** command to return to global configuration mode.

```
device(config-if-eth-0/1)# exit
```

6. Enter the **interface** command and specify an interface.

```
device(config)# interface ethernet 0/2
```

7. Enter the **ipv6 address** command to add an IPv6 address to the interface.

```
device(config-if-eth-0/2)# ipv6 address 2001:1:0::2:1/64
```

8. Enter the **ipv6 ospf area** command.

```
device(config-if-eth-0/2)# ipv6 ospf area 1
```

Area 1 is assigned to the specified interface with the IPv6 address of 2001:1:0:2::1/64.

The following example configures and enables OSPFv3 on two specified interfaces, and assigns an interface to two router areas.

```
device# configure terminal
device(config)# interface ethernet 0/1
device(config-if-eth-0/1)# ipv6 address 2001:1:0::1:1/64
device(config-if-eth-0/1)# ipv6 ospf area 0
device(config-if-eth-0/1)# exit
device(config)# interface ethernet 0/2
device(config-if-eth-0/2)# ipv6 address 2001:1:0::2:1/64
device(config-if-eth-0/2)# ipv6 ospf area 1
```

Stub area and totally stubby area

A stub area is an area in which advertisements of external routes are not allowed, reducing the size of the database. A totally stubby area (TSA) is a stub area in which summary link-state advertisement (type 3 LSAs) are not sent. A default summary LSA, with a prefix of 0.0.0.0/0 is originated into the stub area by an ABR, so that devices in the area can forward all traffic for which a specific route is not known, via ABR.

A stub area disables advertisements of external routes. By default, the ABR sends summary LSAs (type 3 LSAs) into stub areas. You can further reduce the number of LSAs sent into a stub area by configuring the device to stop sending type 3 LSAs into the area. You can disable the summary LSAs to create a TSA when you are configuring the stub area or after you have configured the area.

The ABR of a totally stubby area disables origination of summary LSAs into this area, but still accepts summary LSAs from OSPF neighbors and floods them to other neighbors.

When you enter the **area stub** command with the **no-summary** keyword and specify an area to disable the summary LSAs, the change takes effect immediately. If you apply the option to a previously configured area, the device flushes all the summary LSAs it has generated (as an ABR) from the area with the exception of the default summary LSA originated. This default LSA is needed for the internal routers, since external routes are not propagated to them.

NOTE

Stub areas and TSAs apply only when the device is configured as an Area Border Router (ABR) for the area. To completely prevent summary LSAs from being sent to the area, disable the summary LSAs on each OSPF router that is an ABR for the area.

Configuring a stub area

OSPFv3 areas can be defined as stub areas with modifiable parameters.

1. Enter the **configure terminal** command to access global configuration mode.

```
device# configure terminal
```

2. Enter the **ip router-id** command to specify the router ID.

```
device(config) ip router-id 10.4.4.4
```

3. Enter the **ipv6 router ospf** command to enter OSPFv3 router configuration mode and enable OSPFv3 on the device.

```
device(config)# ipv6 router ospf
```

4. Enter the **area stub** command and specify a metric value.

```
device(config-ipv6-router-ospf-vrf-default-vrf)# area 4 stub 100
```

Area 4 is defined as a stub area with an additional cost of 100.

The following example sets an additional cost of 100 on a stub area defined as 4.

```
device# configure terminal
device(config)# ip router-id 10.4.4.4
device(config)# ipv6 router ospf
device(config-ipv6-router-ospf-vrf-default-vrf)# area 4 stub 100
```

Not-so-stubby area

A not-so-stubby-area (NSSA) is an OSPFv3 area that provides the benefits of stub areas with the extra capability of importing external route information. OSPFv3 does not flood external routes from other areas into an NSSA, but does translate and flood route information from the NSSA into other areas such as the backbone.

NSSAs are especially useful when you want to aggregate type 5 External LSAs (external routes) before forwarding them into an OSPFv3 area. When you configure an NSSA, you can specify an address range for aggregating the external routes that the ABR of the NSSAs exports into other areas.

If the router is an ABR, you can prevent any type 3 and type 4 LSA from being injected into the area by configuring a nssa with the **no-summary** parameter. The only exception is that a default route is injected into the NSSA by the ABR, and strictly as a type 3 LSA. The default type 7 LSA is not originated in this case.

By default, the device's NSSA translator role is set to candidate and the router participates in NSSA translation election, if it is an ABR. You can also configure the NSSA translator role.

In the case where an NSSA ABR is also an ASBR, the default behavior is that it originates type 5 LSAs into normal areas and type 7 LSAs into an NSSA. But you can prevent an NSSA ABR from generating type 7 LSAs into an NSSA by configuring the **no-redistribution** parameter.

Configuring an NSSA

OSPFv3 areas can be defined as NSSA areas with configurable parameters.

1. Enter the **configure terminal** command to access global configuration mode.

```
device# configure terminal
```

2. Enter the **ip router-id** command to specify the router ID.

```
device(config) ip router-id 10.3.3.3
```

3. Enter the **ipv6 router ospf** command to enter OSPFv3 router configuration mode and enable OSPFv3 on the device.

```
device(config)# ipv6 router ospf
```

4. Enter the **area nssa** command with the **default-information-originate** keyword and specify a cost.

```
device(config-ipv6-router-ospf-vrf-default-vrf)# area 3 nssa default-information-originate metric 33
```

Area 3 is defined as an NSSA with the default route option and an additional cost of 33.

The following example sets an additional cost of 33 on an NSSA defined as 3.

```
device# configure terminal
device(config)# ip router-id 10.3.3.3
device(config)# ipv6 router ospf
device(config-ipv6-router-ospf-vrf-default-vrf)# area 3 nssa default-information-originate metric 33
```

LSA types for OSPFv3

Communication among OSPFv3 areas is provided by means of link-state advertisements (LSAs). OSPFv3 supports a number of types of LSAs:

- Router LSAs (Type 1)
- Network LSAs (Type 2)
- Interarea-prefix LSAs for ABRs (Type 3)
- Interarea-router LSAs for ASBRs (Type 4)
- Autonomous system External LSAs (Type 5)
- NSSA External LSAs (Type 7)
- Link LSAs (Type 8)
- Intra-area-prefix LSAs (Type 9)

For more information about these LSAs, refer to RFC 5340.

Virtual links

All ABRs must have either a direct or indirect link to an OSPFv3 backbone area (0 or 0.0.0.0). If an ABR does not have a physical link to a backbone area, you can configure a virtual link from the ABR to another router within the same area that has a physical connection to the backbone area.

The path for a virtual link is through an area shared by the neighbor ABR (router with a physical backbone connection) and the ABR requiring a logical connection to the backbone.

In the following figure, a virtual link has been created between ABR1 and ABR2. ABR1 has a direct link to the backbone area, while ABR2 has an indirect link to the backbone area through Area 1.

FIGURE 20 OSPFv3 virtual link

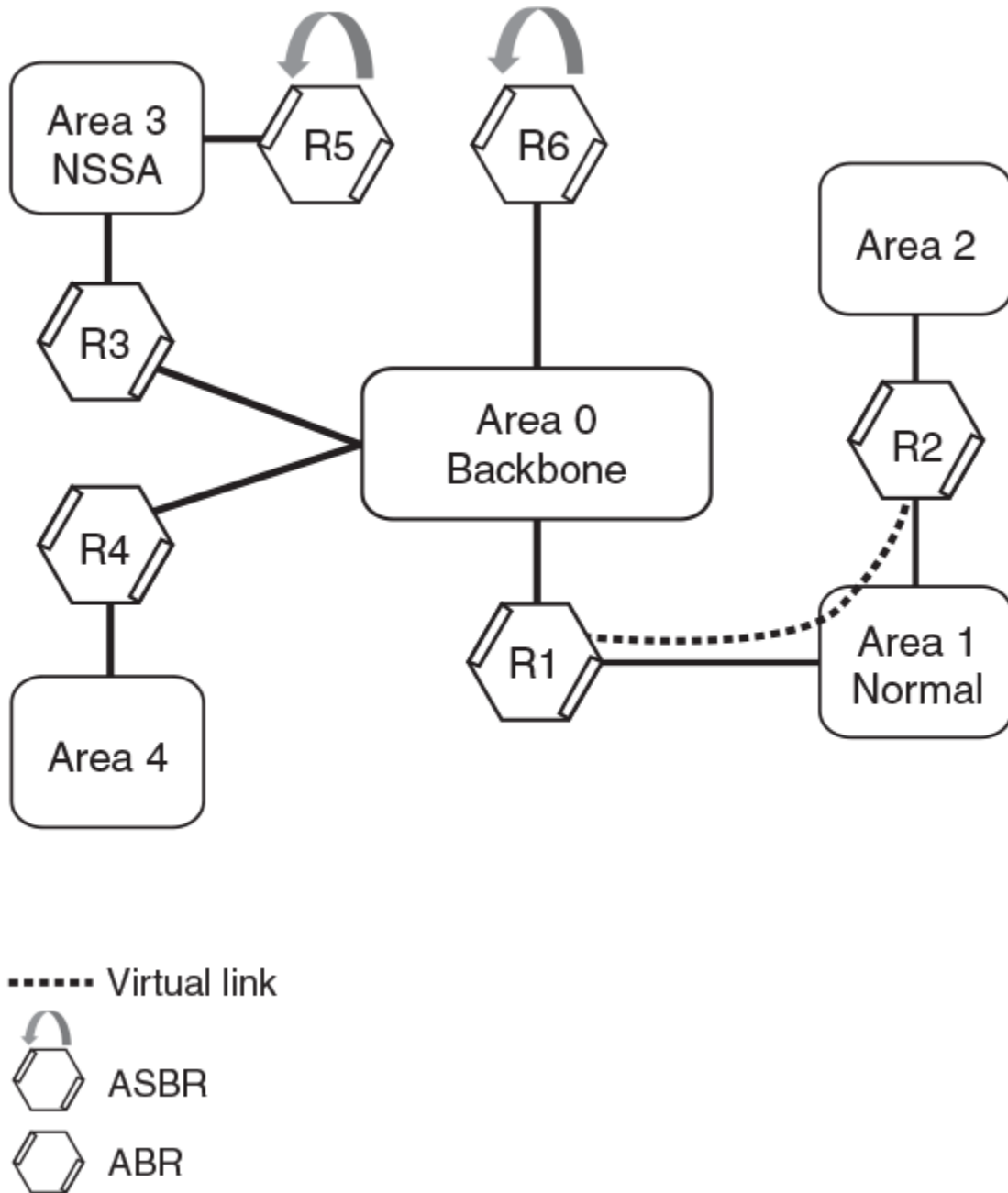

Two parameters must be defined for all virtual links—transit area ID and neighbor router:

- The transit area ID represents the shared area of the two ABRs and serves as the connection point between the two routers. This number should match the area ID value.
- The neighbor router is the router ID of the device that is physically connected to the backbone when assigned from the router interface requiring a logical connection. The neighbor router is the router ID (IPv4 address) of the router requiring a logical connection to the backbone when assigned from the router interface with the physical connection.

When you establish an area virtual link, you must configure it on both ends of the virtual link. For example, imagine that ABR1 in Area 1 and Area 2 is cut off from the backbone area (Area 0). To provide backbone access to ABR1, you can add a virtual link between ABR1 and ABR2 in Area 1 using Area 1 as a transit area. To configure the virtual link, you define the link on the router that is at each end of the link. No configuration for the virtual link is required on the routers in the transit area.

Virtual links cannot be configured in stub areas and NSSAs.

Virtual link source address assignment

When devices at both ends of a virtual link communicate with one another, a global IPv6 address is automatically selected for each end device and this address is advertised into the transit area as an intra-area-prefix LSA.

The automatically selected global IPv6 address for that router is the first global address of any loopback interface in that transit area. If no global IPv6 address is available on a loopback interface in the area, the first global IPv6 address of the lowest-numbered interface in the UP state (belonging to the transit area) is assigned. If no global IPv6 address is configured on any of the OSPFv3 interfaces in the transit area, the virtual links in the transit area do not operate. The automatically selected IPv6 global address is updated whenever the previously selected IPv6 address of the interface changes, is removed, or if the interface goes down.

NOTE

The existing selected virtual link address does not change because the global IPv6 address is now available on a loopback interface or a lower-numbered interface in the transit area. To force the global IPv6 address for the virtual link to be the global IPv6 address of a newly configured loopback, or a lower-numbered interface in the area, you must either disable the existing selected interface or remove the currently selected global IPv6 address from the interface.

Configuring virtual links

If an Area Border Router (ABR) does not have a physical link to a backbone area, a virtual link can be configured between that ABR and another device within the same area that has a physical link to a backbone area.

A virtual link is configured, and a virtual link endpoint on two devices, ABR1 and ABR2, is defined.

1. On ABR1, enter the **configure terminal** command to access global configuration mode.

```
device# configure terminal
```

2. Enter the **ip router-id** command to specify the router ID.

```
device(config) ip router-id 10.1.1.1
```

3. Enter the **ipv6 router ospf** command to enter OSPFv3 router configuration mode and enable OSPFv3 on the device.

```
device(config)# ipv6 router ospf
```

4. Enter the **area** command to assign an OSPFv3 area ID.

```
device(config-ipv6-router-ospf-vrf-default-vrf)# area 0
```

5. Enter the **area** command to assign an OSPFv3 area ID.

```
device(config-ipv6-router-ospf-vrf-default-vrf)# area 1
```

6. Enter the **area virtual-link** command and the ID of the OSPFv3 device at the remote end of the virtual link to configure the virtual link endpoint.

```
device(config-ipv6-router-ospf-vrf-default-vrf)# area 1 virtual-link 10.2.2.2
```

- On ABR2, enter the **configure terminal** command to access global configuration mode.

```
device# configure terminal
```

- Enter the **ip router-id** command to specify the router ID.

```
device(config) ip router-id 10.2.2.2
```

- Enter the **ipv6 router ospf** command to enter OSPFv3 router configuration mode and enable OSPFv3 on the device.

```
device(config)# ipv6 router ospf
```

- Enter the **area** command to assign an OSPFv3 area ID.

```
device(config-ipv6-router-ospf-vrf-default-vrf)# area 1
```

- Enter the **area** command to assign an OSPFv3 area ID.

```
device(config-ipv6-router-ospf-vrf-default-vrf)# area 2
```

- Enter the **area virtual-link** command and the ID of the OSPFv3 device at the remote end of the virtual link to configure the virtual link endpoint.

```
device(config-ipv6-router-ospf-vrf-default-vrf)# area 1 virtual-link 10.1.1.1
```

The following example configures a virtual link between two devices.

```
ABR1:
device1# configure terminal
device1(config)# ip router-id 10.1.1.1
device1(config)# ipv6 router ospf
device1(config-ipv6-router-ospf-vrf-default-vrf)# area 0
device1(config-ipv6-router-ospf-vrf-default-vrf)# area 1
device1(config-ipv6-router-ospf-vrf-default-vrf)# area 1 virtual-link 10.2.2.2

ABR2:
device2# configure terminal
device2(config)# ip router-id 10.2.2.2
device2(config)# ipv6 router ospf
device2(config-ipv6-router-ospf-vrf-default-vrf)# area 1
device2(config-ipv6-router-ospf-vrf-default-vrf)# area 2
device2(config-ipv6-router-ospf-vrf-default-vrf)# area 1 virtual-link 10.1.1.1
```

OSPFv3 route redistribution

Routes from various sources can be redistributed into OSPFv3. These routes can be redistributed in a number of ways.

You can configure the device to redistribute routes from the following sources into OSPFv3:

- IPv6 static routes
- Directly connected IPv6 networks
- BGP4+

You can redistribute routes in the following ways:

- By route types. For example, the device redistributes all IPv6 static routes.
- By using a route map to filter which routes to redistribute. For example, the device redistributes specified IPv6 static routes only.

NOTE

You must configure the route map before you configure a redistribution filter that uses the route map.

NOTE

For an external route that is redistributed into OSPFv3 through a route map, the metric value of the route remains the same unless the metric is set by the **set metric** command inside the route map or the **default-metric** command. For a route redistributed without using a route map, the metric is set by the metric parameter if set or the **default-metric** command if the metric parameter is not set.

Redistributing routes into OSPFv3

OSPFv3 routes can be redistributed, and the routes to be redistributed can be specified.

The redistribution of both static routes and BGP routes into OSPFv3 is configured on device1. The redistribution of connected routes into OSPFv3 is configured on device2, and the connected routes to be redistributed are specified.

1. On device1, enter the **configure terminal** command to access global configuration mode.

```
device# configure terminal
```

2. Enter the **ipv6 router ospf** command to enter OSPFv3 router configuration mode and enable OSPFv3 on the device.

```
device(config)# ipv6 router ospf
```

3. Enter the **redistribute** command with the **static** parameter to redistribute static routes.

```
device(config-ipv6-router-ospf-vrf-default-vrf)# redistribute static
```

4. Enter the **redistribute** command with the **bgp** parameter to redistribute static routes.

```
device(config-ipv6-router-ospf-vrf-default-vrf)# redistribute bgp
```

5. On device2, enter the **configure terminal** command to access global configuration mode.

```
device# configure terminal
```

6. Enter the **ipv6 router ospf** command to enter OSPFv3 router configuration mode and enable OSPFv3 on the device.

```
device(config)# ipv6 router ospf
```

7. Enter the **redistribute** command with the **connected** and **route-map** parameters to redistribute connected routes and specify a route map.

```
device(config-ipv6-router-ospf-vrf-default-vrf)# redistribute connected route-map rmap1
```

The following example redistributes static and BGP routes into OSPFv3 on a device.

```
device# configure terminal
device(config)# ipv6 router ospf
device(config-ipv6-router-ospf-vrf-default-vrf)# redistribute static
device(config-ipv6-router-ospf-vrf-default-vrf)# redistribute bgp
```

The following example redistributes connected routes into OSPFv3 on a device and specifies a route map.

```
device# configure terminal
device(config)# ipv6 router ospf
device(config-ipv6-router-ospf-vrf-default-vrf)# redistribute connected route-map rmap1
```

Default route origination

When the device is an OSPFv3 Autonomous System Boundary Router (ASBR), you can configure it to automatically generate a default external route into an OSPFv3 routing domain.

By default, a device does not advertise the default route into the OSPFv3 domain. If you want the device to advertise the OSPFv3 default route, you must explicitly enable default route origination. When you enable OSPFv3 default route origination, the device advertises a type 5 default route that is flooded throughout the autonomous system, with the exception of stub areas.

The device advertises the default route into OSPFv3 even if OSPFv3 route redistribution is not enabled, and even if the default route is learned through an IBGP neighbor. The device does not, however, originate the default route if the active default route is learned from an OSPFv3 router in the same domain.

NOTE

The device does not advertise the OSPFv3 default route, regardless of other configuration parameters, unless you explicitly enable default route origination.

If default route origination is enabled and you disable it, the default route originated by the device is flushed. Default routes generated by other OSPFv3 devices are not affected. If you re-enable the default route origination, the change takes effect immediately and you do not need to reload the software.

Configuring default external routes

OSPFv3 default routes can be created and advertised.

1. Enter the **configure terminal** command to access global configuration mode.

```
device# configure terminal
```

2. Enter the **ipv6 router ospf** command to enter OSPFv3 router configuration mode and enable OSPFv3 globally.

```
device(config)# ipv6 router ospf
```

3. Enter the **default-information-originate** command with the **always**, **metric**, and **metric-type** parameters.

```
device(config-ipv6-router-ospf-vrf-default-vrf)# default-information-originate always metric 2
metric-type type1
```

A default type 1 external route with a metric of 2 is created and advertised.

The following example creates and advertises a default route with a metric of 2 and a type 1 external route.

```
device# configure terminal
device(config)# ipv6 router ospf
device(config-ipv6-router-ospf-vrf-default-vrf)# default-information-originate always metric 2 metric-type
type1
```

Filtering OSPFv3 routes

You can filter the routes to be placed in the OSPFv3 route table by configuring distribution lists.

The functionality of OSPFv3 distribution lists is similar to that of OSPFv2 distribution lists. Refer to the **OSPFv2** chapter for more information.

SPF timers

The device uses an SPF delay timer and an SPF hold-time timer to calculate the shortest path for OSPFv3 routes. The values for both timers can be changed.

The device uses the following timers when calculating the shortest path for OSPFv3 routes:

- **SPF delay:** When the device receives a topology change, it waits before starting a Shortest Path First (SPF) calculation. By default, the device waits 0 seconds. You can configure the SPF delay to a value from 0 through 65535 seconds. When the SPF delay is set to 0 seconds, the device immediately begins the SPF calculation after receiving a topology change.
- **SPF hold time:** The device waits a specific amount of time between consecutive SPF calculations. By default, it waits 0 seconds. You can configure the SPF hold time to a value from 0 through 65535 seconds. When the SPF hold time is set to 0 seconds, the device does not wait between consecutive SPF calculations.

You can set the SPF delay and hold time to lower values to cause the device to change to alternate paths more quickly if a route fails. Note that lower values for these parameters require more CPU processing time.

You can change one or both of the timers.

NOTE

If you want to change only one of the timers, for example, the SPF delay timer, you must specify the new value for this timer as well as the current value of the SPF hold timer, which you want to retain. The device does not accept only one timer value.

Modifying SPF timers

The Shortest Path First (SPF) delay and hold time can be modified.

1. Enter the **configure terminal** command to access global configuration mode.

```
device# configure terminal
```

2. Enter the **ipv6 router ospf** command to enter OSPFv3 router configuration mode and enable OSPFv3 globally.

```
device(config)# ipv6 router ospf
```

3. Enter the **timers** command with the **spf** parameter.

```
device(config-ipv6-router-ospf-vrf-default-vrf)# timers spf 1 5
```

The SPF delay is changed to 1 second and the SPF hold time is changed to 5 seconds.

The following example changes the SPF delay and hold time.

```
device# configure terminal
device(config)# ipv6 router ospf
device(config-ipv6-router-ospf-vrf-default-vrf)# timers spf 1 5
```

OSPFv3 administrative distance

Devices can learn about networks from various protocols and select a route based on the source of the route information. This decision can be influenced if the default administrative distance for OSPFv3 routes is changed. Consequently, the routes to a network may differ depending on the protocol from which the routes were learned.

You can influence the device's decision by changing the default administrative distance for OSPFv3 routes. You can configure a unique administrative distance for each type of OSPFv3 route. For example, you can configure the Brocade device to prefer a static route over an OSPFv3 inter-area route and to prefer OSPFv3 intra-area routes over static routes. The distance you specify influences the choice of routes when the device has multiple routes to the same network from different protocols. The device prefers the route with the lower administrative distance.

You can specify unique default administrative distances for the following OSPFv3 route types:

- Intra-area routes
- Inter-area routes
- External routes

NOTE

The choice of routes within OSPFv3 is not influenced. For example, an OSPFv3 intra-area route is always preferred over an OSPFv3 inter-area route, even if the intra-area route's distance is greater than the inter-area route's distance.

Configuring administrative distance based on route type

The default administrative distances for intra-area routes, inter-area routes, and external routes can be altered.

1. Enter the **configure terminal** command to access global configuration mode.

```
device# configure terminal
```

2. Enter the **ipv6 router ospf** command to enter OSPFv3 router configuration mode and enable OSPFv3 globally.

```
device(config)# ipv6 router ospf
```

3. Enter the **distance** command with the **intra-area** parameter.

```
device(config-ipv6-router-ospf-vrf-default-vrf)# distance intra-area 80
```

The administrative distance for intra-area routes is changed from the default to 80.

4. Enter the **distance** command with the **inter-area** parameter.

```
device(config-ipv6-router-ospf-vrf-default-vrf)# distance inter-area 90
```

The administrative distance for inter-area routes is changed from the default to 90.

5. Enter the **distance** command with the **external** parameter.

```
device(config-ipv6-router-ospf-vrf-default-vrf)# distance external 100
```

The administrative distance for external routes is changed from the default to 100.

The following example changes the default administrative distances for intra-area routes, inter-area routes, and external routes.

```
device# configure terminal
device(config)# ipv6 router ospf
device(config-ipv6-router-ospf-vrf-default-vrf)# distance intra-area 80
device(config-ipv6-router-ospf-vrf-default-vrf)# distance inter-area 90
device(config-ipv6-router-ospf-vrf-default-vrf)# distance external 100
```

Changing the reference bandwidth for the cost on OSPFv3 interfaces

The reference bandwidth for OSPFv3 can be altered, resulting in various costs.

1. Enter the **configure terminal** command to access global configuration mode.

```
device# configure terminal
```

2. Enter the **ipv6 router ospf** command to enter OSPFv3 router configuration mode and enable OSPFv3 globally.

```
device(config)# ipv6 router ospf
```

3. Enter the **auto-cost reference-bandwidth** command to change the reference bandwidth.

```
device(config-ipv6-router-ospf-vrf-default-vrf)# auto-cost reference-bandwidth 500
```

The following example changes the auto-cost reference bandwidth to 500.

```
device# configure terminal
device(config)# ipv6 router ospf
device(config-ipv6-router-ospf-vrf-default-vrf)# auto-cost reference-bandwidth 500
```

The reference bandwidth specified in this example results in the following costs:

- 10-Mbps port cost = $500/10 = 50$
- 100-Mbps port cost = $500/100 = 5$
- 1000-Mbps port cost = $500/1000 = 0.5$, which is rounded up to 1
- 155-Mbps port cost = $500/155 = 3.23$, which is rounded up to 4
- 622-Mbps port cost = $500/622 = 0.80$, which is rounded up to 1
- 2488-Mbps port cost = $500/2488 = 0.20$, which is rounded up to 1

The costs for 10-Mbps, 100-Mbps, and 155-Mbps ports change as a result of the changed reference bandwidth. Costs for higher-speed interfaces remain the same.

OSPFv3 LSA refreshes

To prevent a refresh from being performed each time an individual LSA's refresh timer expires, OSPFv3 LSA refreshes are delayed for a specified time interval. This pacing interval can be altered.

The device paces OSPFv3 LSA refreshes by delaying the refreshes for a specified time interval instead of performing a refresh each time an individual LSA's refresh timer expires. The accumulated LSAs constitute a group, which the device refreshes and sends out together in one or more packets.

The pacing interval, which is the interval at which the device refreshes an accumulated group of LSAs, is configurable in a range from 10 through 1800 seconds (30 minutes). The default is 240 seconds (4 minutes). Thus, every four minutes, the device refreshes the group of accumulated LSAs and sends the group together in the same packets.

The pacing interval is inversely proportional to the number of LSAs the device is refreshing and aging. For example, if you have approximately 10,000 LSAs, decreasing the pacing interval enhances performance. If you have a very small database (40 to 100 LSAs), increasing the pacing interval to 10 to 20 minutes may enhance performance only slightly.

Configuring the OSPFv3 LSA pacing interval

The interval between OSPFv3 LSA refreshes can be modified.

1. Enter the **configure terminal** command to access global configuration mode.

```
device# configure terminal
```

2. Enter the **ipv6 router ospf** command to enter OSPFv3 router configuration mode and enable OSPFv3 globally.

```
device(config)# ipv6 router ospf
```

3. Enter the **timers** command with the **lsa-group-pacing** parameter.

```
device(config-ipv6-router-ospf-vrf-default-vrf)# timers lsa-group-pacing 120
```

The OSPFv3 LSA pacing interval is changed to 120 seconds (two minutes).

The following example restores the pacing interval to the default value of 240 seconds (4 minutes).

```
device# configure terminal
device(config)# ipv6 router ospf
device(config-ipv6-router-ospf-vrf-default-vrf)# no timers lsa-group-pacing
```

External route summarization

An ASBR can be configured to advertise one external route as an aggregate for all redistributed routes that are covered by a specified IPv6 summary address range.

When you configure a summary address range, the range takes effect immediately. All the imported routes are summarized according to the configured summary address range. Imported routes that have already been advertised and that fall within the range are flushed out of the autonomous system and a single route corresponding to the range is advertised.

If a route that falls within a configured summary address range is imported by the device, no action is taken if the device has already advertised the aggregate route; otherwise, the device advertises the aggregate route. If an imported route that falls within a configured summary address range is removed by the device, no action is taken if there are other imported routes that fall within the same summary address range; otherwise, the aggregate route is flushed.

You can configure up to 32 summary address ranges.

The device sets the forwarding address of the aggregate route to 0 and sets the tag to 0. If you delete a summary address range, the advertised aggregate route is flushed and all imported routes that fall within the range are advertised individually. If an external link-state database (LSDB) overflow condition occurs, all aggregate routes and other external routes are flushed out of the autonomous system. When the device exits the external LSDB overflow condition, all the imported routes are summarized according to the configured address ranges.

NOTE

If you use redistribution filters in addition to summary address ranges, the device applies the redistribution filters to routes first, and then applies them to the summary address ranges.

NOTE

If you disable redistribution, all the aggregate routes are flushed, along with other imported routes.

NOTE

Only imported, type 5 external LSA routes are affected. A single type 5 LSA is generated and flooded throughout the autonomous system for multiple external routes.

OSPFv3 over VRF

OSPFv3 can run over multiple Virtual Routing and Forwarding (VRF) instances. OSPFv3 maintains multiple instances of the routing protocol to exchange route information among various VRF instances. A multi-VRF-capable router maps an input interface to a unique VRF, based on user configuration. These input interfaces can be physical or a virtual interface. By default, all input interfaces are attached to the default VRF instance. All OSPFv3 commands are available over default and nondefault VRF instances.

Multi-VRF for OSPF (also known as VRF-Lite for OSPF) provides a reliable mechanism for trusted VPNs to be built over a shared infrastructure. The ability to maintain multiple virtual routing or forwarding tables allows overlapping private IP addresses to be maintained across VPNs.

Enabling OSPFv3 in a non-default VRF

When OSPFv3 is enabled in a non-default VRF instance, the device enters OSPFv3 router VRF configuration mode. Several commands can then be accessed that allow the configuration of OSPFv3.

A non-default VRF instance has been configured.

1. Enter the **configure terminal** command to access global configuration mode.

```
device# configure terminal
```

2. Enter the **ipv6 router ospf** command and specify a VRF name to enter OSPF router VRF configuration mode and enable OSPFv2 on a non-default VRF.

```
device(config)# ipv6 router ospf vrf green
```

The following enables OSPFv3 in a non-default VRF.

```
device# configure terminal
device(config)# ipv6 router ospf vrf green
device(config-ipv6-router-ospf-vrf-green)#
```

Setting all OSPFv3 interfaces to the passive state

All OSPFv3 interfaces can be set as passive, causing them to drop all OSPFv3 control packets.

1. Enter the **configure terminal** command to access global configuration mode.

```
device# configure terminal
```

2. Enter the **ipv6 router ospf** command to enter OSPFv3 router configuration mode and enable OSPFv3 globally.

```
device(config)# ipv6 router ospf
```

3. Enter the **default-passive-interface** command to mark all interfaces passive by default.

```
device(config-ipv6-router-ospf-vrf-default-vrf)# default-passive-interface
```

The following example sets all OSPFv3 interfaces as passive, causing them to drop all the OSPFv3 control packets.

```
device# configure terminal
device(config)# ipv6 router ospf
device(config-ipv6-router-ospf-vrf-default-vrf)# default-passive-interface
```

OSPFv3 max-metric router LSA

OSPFv3 can be configured to advertise its locally generated router LSAs with a maximum metric to direct transit traffic away from the device, while still routing for directly connected networks.

By advertising the maximum metric, the device does not attract transit traffic. A device which does not handle transit traffic, and only forwards packets destined for its directly connected links, is known as a stub router. In OSPFv3 networks, a device could be placed in a stub router role by advertising large metrics for its connected links, so that the cost of a path through the device becomes larger than that of an alternative path.

You can configure OSPFv3 max-metric router LSA in either startup or non-startup mode. Configuring max-metric on startup may be helpful on ASBRs where protocols such as BGP converge after OSPF converges. Configuring max-metric on non-startup may be helpful in database overflow scenarios.

Configuring the OSPFv3 max-metric router LSA

By configuring the OSPFv3 max-metric router LSA feature you can enable OSPFv3 to advertise its locally generated router LSAs with a maximum metric.

NOTE

You can configure OSPFv3 max-metric router LSA in either startup or non-startup mode. Configuring max-metric with non-startup mode, it is only applied once and is not persistent across reloads, or after the **clear ip ospf all** command is issued.

1. Enter the **configure terminal** command to access global configuration mode.

```
device# configure terminal
```

2. Enter the **ip router-id** command to specify the router ID.

```
device(config)# ip router-id 10.11.12.13
```

3. Enter the **ipv6 router ospf** command to enter OSPFv3 router configuration mode and enable OSPFv3 on the device.

```
device(config)# ipv6 router ospf
```

4. Enter the **max-metric router-lsa** command with the **external-lsa** keyword and specify a value to configure the maximum metric value for all external type-5 and type-7 LSAs .

```
device(config-ipv6-router-ospf-vrf-default-vrf)# max-metric router-lsa external-lsa 1500
```

5. Enter the **max-metric router-lsa** command with the **on-startup** keyword and specify a value to specify a period of time to advertise a maximum metric after a restart before advertising with a normal metric.

```
device(config-ipv6-router-ospf-vrf-default-vrf)# max-metric router-lsa on-startup 85
```

The following example configures an OSPFv3 device to advertise a maximum metric and sets the maximum metric value for all external type-5 and type-7 LSAs to 1500, and configures the device to advertise a maximum metric for 85 seconds after a restart before advertising with a normal metric.

```
device# configure terminal
device(config)# ip router-id 10.11.12.13
device(config)# ipv6 router ospf
device(config-ipv6-router-ospf-vrf-default-vrf)# max-metric router-lsa external-lsa 1500
device(config-ipv6-router-ospf-vrf-default-vrf)# max-metric router-lsa on-startup 85
```

IPsec for OSPFv3

IP Security (IPsec) secures OSPFv3 communications by authenticating and encrypting each IP packet of a communication session.

IPsec provides security features such as authentication of data origin, data integrity, replay protection, and message confidentiality. You can use IPsec to secure specific OSPFv3 areas and interfaces and protect OSPFv3 virtual links.

IPsec for OSPFv3 constitutes two basic protocols to authenticate routing information between peers:

- **Authentication header (AH):** AH provides data origin authentication and connectionless integrity, as well as providing the optional replay protection feature. AH authenticates as much of the IP header as possible, as well as the upper-level protocol data such as source IPv6 address, destination IPv6 address, flags, and IP payload. However, some IP header fields, such as TTL and checksum are often modified in transit and, therefore, cannot be protected by AH.
- **Encapsulating Security Payload (ESP):** ESP can provide message confidentiality, connectionless data integrity, and optional replay protection. ESP has both a header and a trailer. The authentication data of ESP cannot protect the outer IP header, only the payload that is being encrypted.

IPsec is available for OSPFv3 traffic only and only for packets that are “for-us”. A for-us packet is addressed to one of the IPv6 addresses on the device or to an IPv6 multicast address.

Brocade devices support the following components of IPsec for IPv6-addressed packets:

- Authentication through AH
- Authentication through ESP in transport mode
- Hashed Message Authentication Code-Secure Hash Algorithm 1 (HMAC-SHA-1) as the authentication algorithm
- Hashed Message Authentication Code-Message Digest 5 (HMAC-MD5) as the authentication algorithm
- Security parameter index (SPI)
- Manual configuration of keys
- Configurable rollover timer

IPsec can be enabled on the following logical entities:

- Interface
- Area
- Virtual link

IPsec is based on security associations (SAs). With respect to traffic classes, this implementation of IPsec uses a single security association between the source and destination to support all traffic classes and does not differentiate between the different classes of traffic that the DSCP bits define.

IPsec on a virtual link is a global configuration. Interface and area IPsec configurations are more granular.

Among the entities that can have IPsec protection, the interfaces and areas can overlap. The interface IPsec configuration takes precedence over the area IPsec configuration when an area and an interface within that area use IPsec. Therefore, if you configure IPsec

for an interface and an area configuration also exists that includes this interface, the interface's IPsec configuration is used by that interface. However, if you disable IPsec on an interface, IPsec is disabled on the interface even if the interface has its own specific authentication.

For IPsec, the system generates two types of databases. The Security Association Database (SAD) contains a security association for each interface or one global database for a virtual link. Even if IPsec is configured for an area, each interface that uses the area's IPsec still has its own security association in the SAD. Each SA in the SAD is a generated entry that is based on your specifications of an authentication protocol, destination address, and a security parameter index (SPI). The SPI number is user-specified according to the network plan. Consideration for the SPI values to specify must apply to the whole network.

The system-generated security policy databases (SPDs) contain the security policies against which the system checks the for-us packets. For each for-us packet that has an ESP header, the applicable security policy in the security policy database (SPD) is checked to see if this packet complies with the policy. The IPsec task drops the non-compliant packets. Compliant packets continue on to the OSPFv3 task.

IPsec for OSPFv3 configuration

IPsec authentication can be enabled on both default and nondefault VRFs. IPsec authentication is disabled by default.

The following IPsec parameters are configurable:

- AH security protocol
- ESP protocol
- Authentication
- Hashed Message Authentication Code-Message Digest 5 (HMAC-MD5) authentication algorithm
- Hashed Message Authentication Code-Secure Hash Algorithm 1 (HMAC-SHA-1) authentication algorithm
- Security parameter index (SPI)
- A 40-character key using hexadecimal characters
- Key rollover timer
- Specifying the key add remove timer

Configuring IPsec on an OSPFv3 area

IPsec can be configured to secure communications on an OSPFv3 area.

NOTE

When IPsec is configured for an area, the security policy is applied to all the interfaces in the area.

1. Enter the **configure terminal** command to access global configuration mode.

```
device# configure terminal
```

2. Enter the **ip router-id** command to specify the router ID.

```
device(config)# ip router-id 10.11.12.13
```

3. Enter the **ipv6 router ospf** command to enter OSPFv3 configuration mode and enable OSPFv3 on the device.

```
device(config)# ipv6 router ospf
```

4. Enter **area authentication spi spi ah hmac-md5 key**, specifying an area, and enter a 40-character hexadecimal key.

```
device(config-ipv6-router-ospf-vrf-default-vrf)# area 0 authentication spi 600 ah hmac-md5 key
abcef12345678901234fedcba098765432109876
```

IPsec is configured in OSPFv3 area 0 with a security parameter index (SPI) value of 600, and the authentication header (AH) protocol is selected. Message Digest 5 (MD5) authentication on the area is enabled.

The following example enables AH and MD5 authentication for the OSPFv3 area, setting an SPI value of 600.

```
device# configure terminal
device(config)# ip router-id 10.11.12.13
device(config)# ipv6 router ospf
device(config-ipv6-router-ospf-vrf-default-vrf)# area 0 authentication spi 600 ah hmac-md5 key
abcef12345678901234fedcba098765432109876
```

Configuring IPsec on an OSPFv3 interface

IPsec can be configured to secure communications on an OSPFv3 interface.

For IPsec to work, the IPsec configuration must be the same on all the routers to which an interface connects.

NOTE

Ensure that OSPFv3 areas are assigned. All device interfaces must be assigned to one of the defined areas on an OSPFv3 router. When an interface is assigned to an area, all corresponding subnets on that interface are automatically included in the assignment.

1. Enter the **configure terminal** command to access global configuration mode.

```
device# configure terminal
```

2. Enter the **interface** command and specify an interface.

```
device(config)# interface ethernet 0/1
```

3. Enter the **ipv6 ospf area** command to assign a specified area to the interface.

```
device(config-if-eth-0/1)# ipv6 ospf area 0
```

4. Enter **ipv6 ospf authentication spi value esp null hmac-sha1** and specify a 40-character hexadecimal key.

```
device(config-if-eth-0/1)# ipv6 ospf authentication spi 512 esp null hmac-sha1 key
abcef12345678901234fedcba098765432109876
```

IPsec is configured on the specified interface with a security parameter index (SPI) value of 512, and the Encapsulating Security Payload (ESP) protocol is selected. Secure Hash Algorithm 1 (SHA-1) authentication is enabled.

The following example enables ESP and SHA-1 on a specified OSPFv3 Ethernet interface.

```
device# configure terminal
device(config)# interface ethernet 0/1
device(config-if-eth-0/1)# ipv6 ospf area 0
device(config-if-eth-0/1)# ipv6 ospf authentication spi 512 esp null hmac-sha1 key
abcef12345678901234fedcba098765432109876
```

Configuring IPsec on OSPFv3 virtual links

IP Security (IPsec) can be configured for virtual links.

An OSPFv3 virtual link must be configured.

The virtual link IPsec security associations (SAs) and policies are added to all interfaces of the transit area for the outbound direction. For the inbound direction, IPsec SAs and policies for virtual links are added to the global database.

1. Enter the **configure terminal** command to access global configuration mode.

```
device# configure terminal
```

2. Enter the **ip router-id** command to specify the router ID.

```
device(config)# ip router-id 10.1.1.1
```

3. Enter the **ipv6 router ospf** command to enter OSPFv3 configuration mode and enable OSPFv3 on the router.

```
device(config)# ipv6 router ospf
```

4. Enter **area virtual-link authentication spi value ah hmac-sha1** key, specifying an area address and the ID of the OSPFv3 device at the remote end of the virtual link.

```
device(config-ipv6-router-ospf-vrf-default-vrf)# area 1 virtual-link 10.1.1.1 authentication spi 512 ah hmac-sha1 key 1134567890223456789012345678901234567890
```

IPsec is configured on the specified virtual link in OSPF area 1. The device ID associated with the virtual link neighbor is 10.1.1.1, the SPI value is 512, and the authentication header (AH) protocol is selected. Secure Hash Algorithm 1 (SHA-1) authentication is enabled. The 40-character key is not encrypted in **show** command displays.

The following example configures IPsec on an OSPFv3 area.

```
device# configure terminal
device(config)# ip router-id 10.1.1.1
device(config)# ipv6 router ospf
device(config-ipv6-router-ospf-vrf-default-vrf)# area 1 virtual-link 10.1.1.1 authentication spi 512 ah hmac-sha1 key 1134567890223456789012345678901234567890
```

Specifying the key rollover and key add-remove timers

The key rollover timer can be configured so that rekeying takes place on all the nodes at the same time and the security parameters are consistent across all the nodes. The timing of the authentication key add-remove interval can also be altered.

1. Enter the **configure terminal** command to access global configuration mode.

```
device# configure terminal
```

2. Enter the **ip router-id** command to specify the router ID.

```
device(config)# ip router-id 10.11.12.13
```

3. Enter the **ipv6 router ospf** command to enter OSPFv3 router configuration mode and enable OSPFv3 on the device.

```
device(config)# ipv6 router ospf
```

4. Enter the **key-add-remove-interval** command and specify the desired interval to set the timing of the authentication key add-remove interval.

```
device(config-ipv6-router-ospf-vrf-default-vrf)# key-add-remove-interval 240
```

5. Enter the **key-rollover-interval** command and specify the desired interval to set the timing of the configuration changeover.

```
device(config-ipv6-router-ospf-vrf-default-vrf)# key-rollover-interval 240
```

The following example sets the key add-remove interval to 240 seconds (4 minutes) and sets the timing of the configuration changeover to 240 seconds (4 minutes).

```
device# configure terminal
device(config)# ip router-id 10.11.12.13
device(config)# ipv6 router ospf
device(config-ipv6-router-ospf-vrf-default-vrf)# key-add-remove-interval 240
device(config-ipv6-router-ospf-vrf-default-vrf)# key-rollover-interval 240
```

Displaying OSPFv3 results

The **show ipv6 ospf** command and its variations can be used to display information about OSPFv3 configurations.

Use one or more of the following commands to verify OSPFv3 information. Using the **show ipv6 ospf** command is optional, and the variations of the command can be entered in any order.

1. Enter the **show ipv6 ospf** command to display general OSPFv3 information.

```
device# show ipv6 ospf

OSPFv3 Process number 0 with Router ID 0x01010101(1.1.1.1)
Running 0 days 0 hours 0 minutes 40 seconds
Number of AS scoped LSAs is 0
Sum of AS scoped LSAs Checksum is 00000000
External LSA Limit is 250000
Database Overflow Interval is 10
Database Overflow State is NOT OVERFLOWED
Route calculation executed 3 times
Pending outgoing LSA count 2
Authentication key rollover interval 300 seconds
Number of areas in this router is 1
High Priority Message Queue Full count: 0
BFD is disabled, BFD HoldoverInterval: 0
Graceful restart helper is enabled, strict lsa checking is disabled
Nonstop Routing is enabled
Administrative Distance
- External Routes: 110
- Intra Area Routes: 110
- Inter Area Routes: 110
Maximum Paths: 8
```

The example output offers general OSPFv3 information and indicates that the device is not operating as an ASBR. If the device is not operating as an ASBR, there is no information about redistribution in the output.

2. The following example of the **show ipv6 ospf summary** command shows summary output for the one IPv6 OSPF session that is configured.

```
device# show ipv6 ospf summary

Total number of IPv6 OSPF instances: 1

Seq Instance                Intfs  Nbrs  Nbrs-Full LSAs  Routes
1  default-vrf                1      1      1           6         1
```

3. The following example of the **show ipv6 ospf area** command shows detailed output for assigned OSPFv3 Area 0.

```
device# show ipv6 ospf area
Area 0:
Authentication: Not Configured
Active interface(s) attached to this area: Ve 200
Inactive interface(s) attached to this area: None
Number of Area scoped LSAs is 4
Sum of Area LSAs Checksum is 0004a7a5
Statistics of Area 0:
SPF algorithm executed 4 times
SPF last updated: 76 sec ago
Current SPF node count: 3
Router: 2 Network: 1
Maximum of Hop count to nodes: 2
```

4. The following example of the **show ipv6 ospf interface brief** command shows limited OSPFv3 interface information.

```
device# show ipv6 ospf interface brief

Interface      Area      Status Type Cost  State  Nbrs (F/C)
Ve 200         0         up     BCST 1    BDR    1/1
```

5. The following example of the **show ipv6 ospf neighbor** command shows OSPFv3 neighbor information for the device.

```
device# show ipv6 ospf neighbor

Total number of neighbors in all states: 1
Number of neighbors in state Full      : 1

RouterID      Pri State  DR          BDR          Interface    [State]
2.2.2.2       1 Full   2.2.2.2    1.1.1.1     Ve 200       [BDR]
```

6. The following example of the **show ipv6 ospf routes** command shows output for OSPFv3 routes.

```
device# show ipv6 ospf routes

Current Route count: 1
Intra: 1 Inter: 0 External: 0 (Type1 0/Type2 0)
Equal-cost multi-path: 0
OSPF Type: IA- Intra, OA - Inter, E1 - External Type1, E2 - External Type2
Destination      Cost      E2Cost      Tag      Flags      Dis
IA 2001::/64      1         0           0        00000003 110
Next_Hop_Router  Outgoing_Interface Adv_Router
::              Ve 200          2.2.2.2
```

7. The following example of the **show ipv6 ospf database** command shows information about different OSPFv3 LSAs.

```
device# show ipv6 ospf database

LSA Key - Rtr:Router Net:Network Inap:InterPrefix Inar:InterRouter
Extn:ASExternal Grp:GroupMembership Typ7:Type7 Link:Link
Iap:IntraPrefix Grc:Grace

Area ID      Type LSID      Adv Rtr      Seq(Hex) Age Cksum Len  Sync
0            Link 6472      1.1.1.1     80000001 371 93e1 56  Yes
0            Link 6416      2.2.2.2     80000001 382 d73d 56  Yes
0            Rtr  0         2.2.2.2     80000003 341 bdfc 40  Yes
0            Rtr  0         1.1.1.1     80000002 341 f096 40  Yes
0            Net  6416      2.2.2.2     80000001 341 b536 32  Yes
0            Iap  192480    2.2.2.2     80000001 341 d8bf 44  Yes
```

8. The following example of the **show ipv6 ospf spf tree** command with the **tree** shows information about the SPF trees.

```
device# show ipv6 ospf spf tree

SPF tree for Area 0
+- 1.1.1.1 cost 0
  +- 2.2.2.2:6416(N) cost 1
    +- 2.2.2.2:0 cost 1
```

9. The following example of the **show ipv6 ospf spf table** command with the **table** shows information about the SPF table.

```
device# show ipv6 ospf spf table

SPF table for Area 0
Destination          Bits Options  Cost  Nexthop          Interface
R 2.2.2.2             ----- V6E---R--    1  fe80::629c:9fff:fe5b:801  Ve 200
N 2.2.2.2[6416]      ----- V6E---R--    1  ::                    Ve 200
```

10. The following example of the **show ipv6 ospf routes** command shows information about a specified OSPFv3 route.

```
device# show ipv6 ospf routes 2001::/64

Destination          Cost      E2Cost    Tag      Flags  Dis
IA 2001::/64         1         0         0        00000003 110
Next_Hop_Router      Outgoing_Interface Adv_Router
::                   Ve 200           2.2.2.2
```

Multi-VRF

• Multi-VRF overview	229
• Configuring Multi-VRF	231
• Multi-VRF configuration example	234
• Inter-VRF route leaking	240

Multi-VRF overview

Virtual Routing and Forwarding (VRF) allows routers to maintain multiple routing tables and forwarding tables on the same router. A Multi-VRF router can run multiple instances of routing protocols with a neighboring router with overlapping address spaces configured on different VRF instances.

Some vendors also use the terms Multi-VRF CE or VRF-Lite for this technology. VRF-Lite provides a reliable mechanism for a network administrator to maintain multiple virtual routers on the same device. The goal of providing isolation among different VPN instances is accomplished without the overhead of heavyweight protocols used in secure VPN technologies. Overlapping address spaces can be maintained among the different VPN instances.

Central to VRF-Lite is the ability to maintain multiple VRF tables on the same Provider Edge (PE) Router. VRF-Lite uses multiple instances of a routing protocol such as OSPF or BGP to exchange route information for a VPN among peer PE routers. The VRF-Lite capable PE router maps an input customer interface to a unique VPN instance. The router maintains a different VRF table for each VPN instance on that PE router. Multiple input interfaces may also be associated with the same VRF on the router, if they connect to sites belonging to the same VPN. This input interface can be a physical interface or a virtual Ethernet interface on a port.

In Multi-VRF deployments:

- Two VRF-capable routers must be directly connected at Layer 3, deploying BGP, OSPF, or static routes.
- Each VRF maintains unique routing and forwarding tables.
- Each VRF can be assigned one or more Layer 3 interfaces on a router to be part of the VRF.
- Each VRF can be configured with IPv4 address family, IPv6 unicast address family, or both.
- A packet's VRF instance is determined based on the VRF index of the interface on which the packet is received.
- Separate routing protocol instances are required for each VRF instance.
- Overlapping address spaces can be configured on different VRF instances.

Multi-VRF deployments provide the flexibility to maintain multiple virtual routers, which are segregated for each VRF instance. The following illustrates a generic, high-level topology where different enterprise functions are assigned unique VRF instances.

FIGURE 21 Example high-level Multi-VRF topology

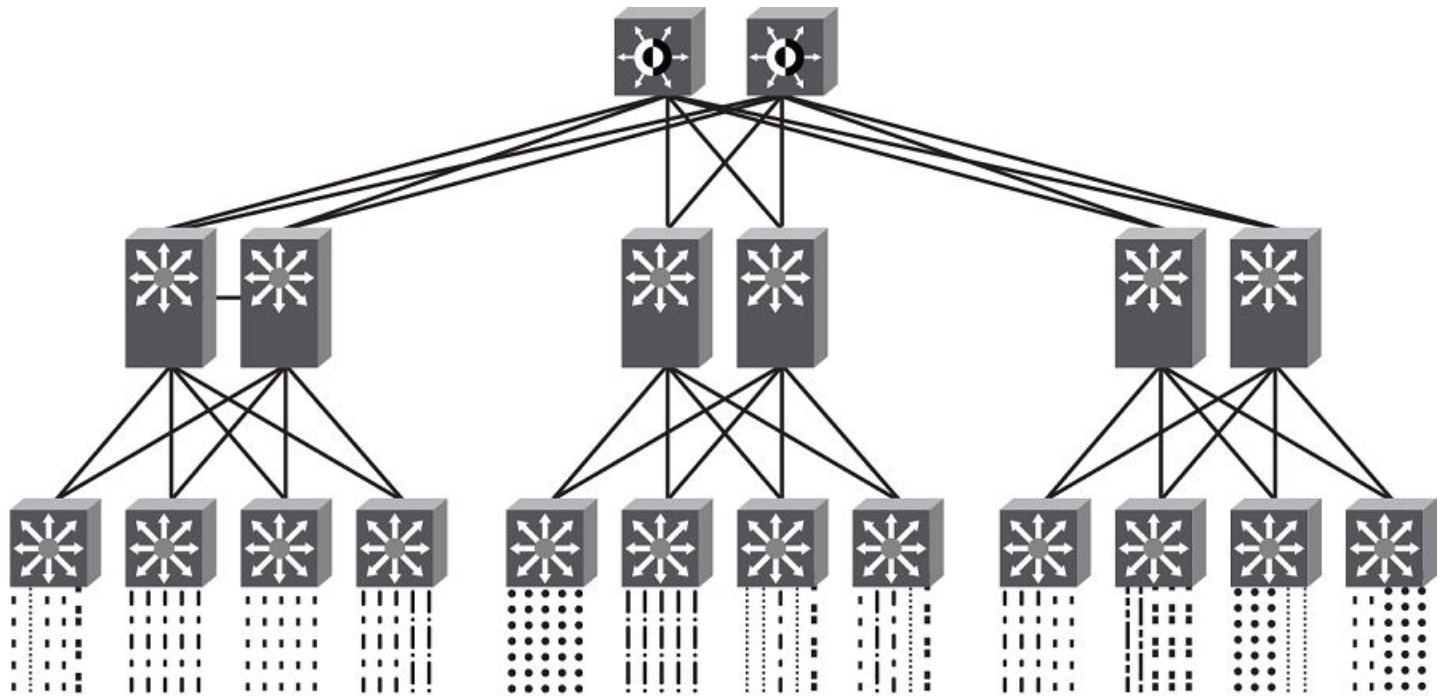

A Multi-VRF instance can be configured on any of the following:

- Virtual interfaces
- Loopback interfaces
- Ethernet interfaces

To configure Multi-VRF, perform the following steps:

- Configure VRF instances.
- Configure an IPv4 address family or IPv6 unicast address family (AF) for new VRF instances.
- Configure routing protocols for new Multi-VRF instances.
- Assign VRF instances to Layer 3 interfaces.

In addition, VRFs operate without knowledge of one another unless they are imported or exported into one another by means of inter-VRF route leaking. For details and configuration examples, refer to "Inter-VRF route leaking" in this chapter.

Configuring Multi-VRF

Configuring a VRF instance

Do the following to configure a VRF instance.

A device can be configured with more than one VRF instance. You should define each VRF instance before assigning the VRF to a Layer 3 interface. The range of the instance name is from 1 through 255 alphanumeric characters. An optional router ID can also be assigned.

Use the **address-family** command in VRF configuration mode to specify an IPv4 or IPv6 address family. For a specific address family you can also configure static route, static ARP, and static route, IPv6 neighbor, and multicast for IPv6.

ATTENTION

Using the **overwrite** option while downloading a configuration from a TFTP server to the running-config will lead to the loss of all VRF configurations when a VRF is configured on a routing interface.

1. Enter global configuration mode and create a VRF instance.

```
device# configure terminal
device(config)# vrf corporate
device(config-vrf-corporate)#
```

2. (Optional) Assign a router ID.

```
device(config-vrf-corporate)# ip router-id 1.1.1.1
```

3. Use the **address-family unicast (VRF)** command to configure an address family on the VRF and exit. This example uses IPv4.

```
device(config-vrf-corporate)# address-family ipv4 unicast
device(config-vrf-corporate-ipv4)# exit
```

4. Verify the configuration.

```
device(config-vrf-corporate)# do show vrf
Total number of VRFs configured: 4
VrfName          VrfId  V4-Ucast  V6-Ucast
corporate        3      Enabled   Disabled
default-vrf      1      Enabled   Enabled
mgmt-vrf         0      Enabled   Enabled
test1            2      Enabled   Enabled
```

Starting a routing process for a VRF

You must enable a routing protocol for each VRF instance. This example uses OSPF.

1. In global configuration mode, enable OSPF for the VRF instance "corporate."

```
device(config)# router ospf vrf corporate
```

2. Configure the VRF to use OSPF Area 0.

```
device(config-ospf-router-vrf-corporate)# area 0
```

3. (Optional) Configure the VRF to ensure that essential OSPF neighbor state changes are logged, especially in the case of errors.

```
device(config-ospf-router-vrf-corporate)# log adjacency
```

Assigning a Layer 3 interface to a VRF

The following example illustrates how a virtual Ethernet (VE) interface is assigned to a VRF, and how IP addresses and the OSPF protocol are configured.

ATTENTION

After a VRF instance is configured on the device, one or more Layer 3 interfaces (physical or virtual Ethernet) must be assigned to the VRF. This causes all existing IP addresses to be deleted; this action also triggers cache deletion, route deletion, and associated cleanup. After assigning an interface to the VRF, the user must reconfigure the IP address and interface properties.

1. Enter global configuration mode.

```
device(config)# configure terminal
```

2. Enter the **interface ve** command to specify a virtual Ethernet (VE) interface and enter VE configuration mode.

```
device(config)# interface ve 10
```

3. In VE configuration mode, enable forwarding for the VRF "guest".

```
device(config-if-Ve-10)# vrf forwarding guest
```

4. Configure an IPv4 address and mask on the VE interface.

```
device(config-if-Ve-10)# ip address 192.168.1.254/24
```

5. Enable OSPF Area 0.

```
device(config-if-Ve-10)# ip ospf area 0
```

6. Configure the interface as passive.

```
device(config-if-Ve-10)# ip ospf passive
```

7. Exit the configuration.

```
device(config-if-Ve-10)# exit
```

Assigning a loopback interface to a VRF

Do the following to assign a loopback interface to a nondefault VRF.

Because a loopback interface is always available as long as the device is available, it allows routing protocol sessions to stay up even if the outbound interface is down. Assigning a loopback interface to a VRF is similar to assigning any interface. A loopback interface that is not assigned to a nondefault VRF belongs to the default VRF.

1. Enter global configuration mode.

```
device# configure terminal
```

2. Enter the **interface loopback** command to specify a loopback interface and enter interface loopback configuration mode.

```
device(config)# interface loopback 1
device(config-Loopback-1)#
```

3. Use the **vrf forwarding** command to assign the interface to the VRF "customer-1" in this example.

```
device(config-Loopback-1)# vrf forwarding customer-1
```

- Assign an IPv4 address and mask to the loopback interface.

```
device(config-Loopback-1)# ip address 10.0.0.1/32
```

Verifying a Multi-VRF configuration

The following examples illustrate the use of a variety of show commands that are useful in verifying Multi-VRF configurations.

To verify all configured VRFs in summary mode, enter the **show vrf** command, as in the following example.

```
device# show vrf
Total number of VRFs configured: 4
VrfName      VrfId  V4-Ucast  V6-Ucast
corporate    3      Enabled   Disabled
default-vrf  1      Enabled   Enabled
mgmt-vrf     0      Enabled   Enabled
test1        2      Enabled   Enabled
```

To verify a specific VRF, enter the **show vrf vrf-name** command, as in the following example.

```
device# show vrf corporate
VRF-Name: corporate, VRF-Id: 3
IP Router-Id: 1.1.1.1
Interfaces:
  Lo 10
Address-family IPV4 unicast
  Max routes:- Route count:0
  No import route-maps
  No export route-maps

Address-family IPV6 unicast
  Max routes:- Route count:2
  No import route-maps
  No Export route-maps
```

Use the **show vrf detail** command to display information about all VRFs.

The following commands display additional information about a specific application, protocol configuration, or protocol state for both the default VRF and user-defined VRFs.

TABLE 10 Additional useful show commands

Default VRF	User-defined VRF
show ip route	show arp vrf
show ip ospf neighbor	show ip route vrf vrf-name
show ip bgp summary	show ip ospf neighbor vrf vrf-name
	show ip bgp summary vrf vrf-name

Removing a VRF configuration

The following examples illustrate a variety of ways by which you can remove a VRF configuration: deleting a VRF instance from a port, deleting an address family from a VRF, and deleting the VRF globally.

To delete a VRF instance from a specific port, use the **no** form of the **vrf forwarding** command. This removes all Layer 3 interface bindings from the VRF, and returns the interface to default VRF mode. All IP addresses and protocol configuration on this Layer 3 interface are removed.

```
device(conf-if-eth-0/1)# no vrf forwarding
```

To delete an IPv4 or IPv6 address family from a VRF instance, use the **no** form of the **address-family** command. All configuration related to the address family on all ports of the VRF are removed. Routes allocated to the address family are returned to the global pool.

```
device(config-vrf-customer1)# no address-family ipv4
```

To delete a VRF instance globally, use the **no** form of the **vrf** command. All IPv4 or IPv6 addresses are removed from all interfaces.

```
device(config)# no vrf customer1
```

Configuring the maximum number of routes

You can use the **max-route** command to specify the number of routes held in the routing table per VRF instance, for an IPv4 or IPv6 VRF address family.

If this command is not used, the maximum number of routes is 4294967295. This number does not appear in a running configuration.

1. Enter global configuration mode.

```
device# configure terminal
```

2. Specify a VRF instance (in this example, "myvrf") and enter VRF configuration mode.

```
device(config)# vrf myvrf
device(config-vrf-myvrf)#
```

3. Enter the **address-family unicast** command, in this example for IPv4, and enter VRF address-family IPv4 unicast configuration mode.

```
device(config-vrf-myvrf)# address-family ipv4 unicast
```

4. Enter the **max-route** command and specify the maximum number of routes to be held in the routing table for this VRF instance, 3600 in this example. (The range is from 1 through 4294967295.)

```
device(vrf-myvrf-ipv4-unicast)# max-route 3600
```

Multi-VRF configuration example

The following is an example of a basic Multi-VRF configuration that uses eBGP with OSPF.

The following example topology shows a typical network that uses the Multi-VRF feature to implement Layer 3 VPNs across two directly connected (at Layer 3) Provider Edge (PE) devices. The Customer Edge (CE) devices can be any router or Layer 3 switch that is capable of running one or many dynamic routing protocols such as BGP or OSPF, or even simple static routing. In this example, we use two devices that interconnect all four CE routers with a single link between the two of them.

FIGURE 22 eBGP configured between PE1 and PE2 with OSPF (Area 0) configured between PEs and CEs

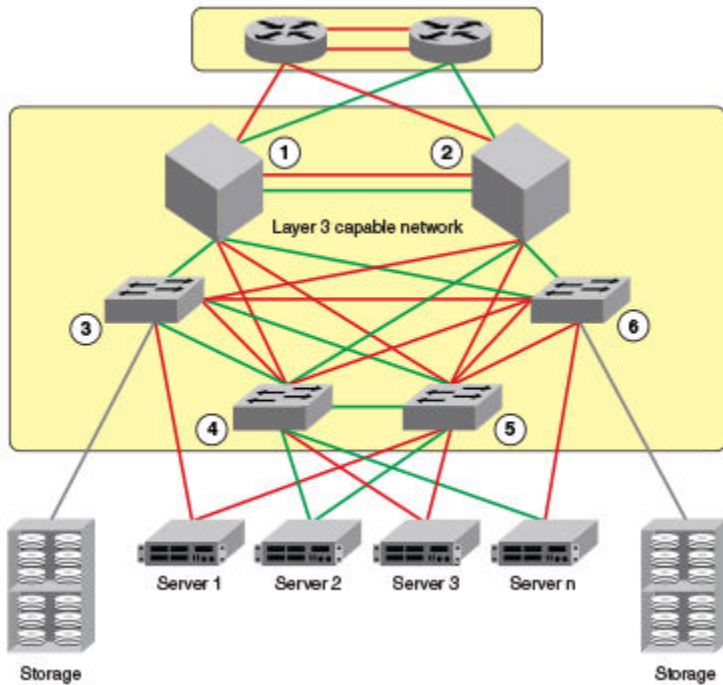

1. PE1
2. PE2
3. CE1
4. CE2
5. CE3
6. CE4

Topology details are listed below.

TABLE 11 Topology details

Node	Description	Networks	Carries routes . . .	Interfaces
PE1	Aggregation	10.1.1.0/24 10.3.1.0/24		0/1 0/2 0/3
PE2	Aggregation	10.2.1.0/24 10.3.1.0/24		0/1 0/2 0/3
CE1	Edge	10.1.1.0/24	10.1.2.0/24 10.1.3.0/24	0/1 0/2
CE2	Edge	10.1.1.0/24	10.1.2.0/24 10.1.3.0/24	0/1 0/2
CE3	Edge	10.2.1.0/24	10.2.2.0/24	0/1

TABLE 11 Topology details (continued)

Node	Description	Networks	Carries routes . . .	Interfaces
			10.2.3.0/24	0/2
CE4	Edge	10.2.1.0/24	10.2.2.0/24 10.2.3.0/24	0/1 0/2

- Traffic is separated by VRF "green" on VLAN 10 and VRF "red" on VLAN 20.
- eBGP and OSPF (Area 0) are used to connect aggregation switches PE1 and PE2.
- iBGP and OSPF (Area 0) are used to connect the aggregation switches to the CE switches.
- Alternatively, with only OSPF used, Areas 1 and 2 could carry traffic between the PEs and CEs.

The following configuration examples for PE1, PE2, CE1, CE2, CE3, and CE4 implement the topology above.

NOTE

The single link between the two PEs could also be replaced by a Layer 2 switched network if direct physical connection between the PEs is not possible. The only requirement for the connections is that the two PEs be directly connected at Layer 3.

In the example topology, because two different VLANs (10 and 20) have overlapping IP address ranges, communication within each customer's VPN across the two PE routers (that is, between CE1 and CE4, and between CE2 and CE3) must be separated by means of two different VRFs ("green" and "red").

Multi-VRF with eBGP and OSPF: Configuring PE1

Two VRFs ("red" and "green") are defined. In the eBGP configuration, PE1 is defined in Local AS 1.

VRFs "green" and "red" are configured, and both have the same IP network address assigned (10.3.1.2/24). This is possible because each of the BGP VRF instances has its own BGP tables. This is also the same IP network address that will be assigned to VRFs "green" and "red" on PE2 within Local AS 2. Redistribution of OSPF routes from PE1's CE peers is enabled to all for their advertisement to PE2.

Both VRFs are configured in Area 0 and are directed to redistribute their routes to BGP. The physical interfaces to the CEs are assigned to the appropriate VRF and are configured with the same network address (10.1.1.1/24) and OSPF Area 0.

The virtual Interfaces (Ve 10 and Ve 20) are configured with the same network address (10.3.1.1/24) and for VRF forwarding in the appropriate VRF ("green" or "red").

1. In global configuration mode, create VLANs 10 and 20.

```
device(config)# vlan 10
device(config-vlan-10)# exit
device(config)# vlan 20
```

2. From global configuration mode, enter interface subtype configuration mode, and then create a virtual Ethernet routing interface for the VLAN.

```
device(config)# vlan 10
device(config-vlan-10)# router-interface ve 10
```

3. Repeat the above steps as appropriate for remaining physical, VLAN, and virtual Ethernet interfaces.

4. Create VRF "green".

```
device(config)# vrf green
device(config-vrf-green)# exit
```

Repeat for every VRF instance. Use the **address-family ipv6 unicast** command for IPv6 addresses. Also, you can use the **max-route** command, which helps restrict the maximum number of routes per VRF.

5. Configure VRF "red" and exit the VRF configuration.

```
device(config)# vrf red
device(config-vrf-red)# exit
```

6. In global configuration mode, enable BGP routing and configure the following in this IPv4 example.

a) Enable BGP routing.

```
device(config)# router bgp
```

b) Assign a Local AS number.

```
device(config-bgp-router)# local-as 1
```

c) Enable IPv4 unicast address-family mode for VRF "green."

```
device(config-bgp-router)# address-family ipv4 unicast vrf green
```

d) Assign Remote AS 2 as a neighbor with the specified address.

```
device(config-bgp-ipv4u-vrf)# neighbor 10.3.1.2 remote-as 2
```

e) Assign the appropriate network.

```
device(config-bgp-ipv4u-vrf)# network 10.3.1.0/24
```

f) Redistribute the OSPF routes into BGP4, specifying the types of routes to be distributed, then exit the address family configuration.

```
device(config-bgp-ipv4u-vrf)# redistribute ospf match internal
device(config-bgp-ipv4u-vrf)# redistribute ospf match external1
device(config-bgp-ipv4u-vrf)# redistribute ospf match external2
device(config-bgp-ipv4u-vrf)# exit
```

7. Repeat as above for VRF "red."

```
device(config)# router bgp
device(config-bgp-router)# address-family ipv4 unicast vrf red
device(config-bgp-ipv4u-vrf)# neighbor 10.3.1.2 remote-as 2
device(config-bgp-ipv4u-vrf)# network 10.3.1.0/24
device(config-bgp-ipv4u-vrf)# redistribute ospf match internal
device(config-bgp-ipv4u-vrf)# redistribute ospf match external1
device(config-bgp-ipv4u-vrf)# redistribute ospf match external2
device(config-bgp-ipv4u-vrf)# exit
device(config-bgp-router)# exit
```

8. Enable OSPF routing for VRF "green" and configure the following.

a) Enable OSPF.

```
device(config)# router ospf vrf green
```

b) Assign Area 0.

```
device(config-ospf-router-vrf-green)# area 0
```

c) Redistribute the OSPF routes into BGP4 and exit the VRF configuration.

```
device(config-ospf-router-vrf-green)# redistribute bgp
device(config-ospf-router-vrf-green)# exit
device(config-ospf-router)# exit
```

9. Repeat as above for VRF "red".

```
device(config)# router ospf vrf red
device(config-ospf-router-vrf-red)# area 0
device(config-ospf-router-vrf-red)# redistribute bgp
device(config-ospf-router-vrf-red)# exit
```

10. Configure the Ethernet interfaces as appropriate, as in the following example.

a) Assign an interface to VRF instance "green" and enable forwarding.

```
device(config)# interface ethernet 0/1
device(conf-if-eth-0/1)# vrf forwarding green
```

b) Assign Area 0.

```
device(conf-if-eth-0/1)# ip ospf area 0
```

c) Assign an IPv4 network.

```
device(conf-if-eth-0/1)# ip address 10.1.1.1/24
```

d) Repeat as above for another Ethernet interface and VRF "red" and exit the interface configuration.

```
device(conf-if-eth-0/2)# interface ethernet 0/2
device(conf-if-eth-0/2)# vrf forwarding red
device(conf-if-eth-0/2)# ip ospf area 0
device(conf-if-eth-0/2)# ip address 10.1.1.1/24
device(conf-if-eth-0/2)# exit
```

11. Configure the VE interfaces for the appropriate VRF and network.

a) Configure VE 10, corresponding to VLAN 10.

```
device(config)# interface ve 10
device(config-if-Ve-10)# vrf forwarding green
device(config-if-Ve-10)# ip address 10.3.1.1/24
device(config-if-Ve-10)# no shutdown
```

b) Repeat the above for VE 20, corresponding to VLAN 20.

```
device(config-ve-10)# interface ve 20
device(config-if-Ve-20)# vrf forwarding red
device(config-if-Ve-20)# ip address 10.3.1.1/24
device(config-if-Ve-20)# no shutdown
device(config-if-Ve-20)# exit
```

Multi-VRF with eBGP and OSPF: Configuring PE2

The PE2 configuration is a mirror image of the PE1 configuration. The only difference is that the BGP neighbor on the corresponding interface has an IP address of 10.3.1.1. This is used in the BGP configuration.

The following summarizes the configuration on PE2.

```

device(config)# vlan 10
device(config-vlan-10)router-interface ve 10
device(config-vlan-10)# exit
device(config)# vlan 20
device(config-vlan-20)router-interface ve 20
device(config-vlan-20)# exit
device(config)# vrf green
device(config-vrf-green)# exit
device(config)# vrf red
device(config-vrf-red)# exit
device(config)# router bgp
device(config-bgp-router)# local-as 1
device(config-bgp-router)# address-family ipv4 unicast vrf green
device(config-bgp-ipv4u-vrf)# neighbor 10.2.1.1 remote-as 2
device(config-bgp-ipv4u-vrf)# network 10.2.1.0/24
device(config-bgp-ipv4u-vrf)# redistribute ospf match internal
device(config-bgp-ipv4u-vrf)# redistribute ospf match external1
device(config-bgp-ipv4u-vrf)# redistribute ospf match external2
device(config-bgp-ipv4u-vrf)# exit
device(config-bgp-router)# address-family ipv4 unicast vrf red
device(config-bgp-ipv4u-vrf)# neighbor 10.3.1.1 remote-as 2
device(config-bgp-ipv4u-vrf)# network 10.3.1.0/24
device(config-bgp-ipv4u-vrf)# redistribute ospf match internal
device(config-bgp-ipv4u-vrf)# redistribute ospf match external1
device(config-bgp-ipv4u-vrf)# redistribute ospf match external2
device(config-bgp-ipv4u-vrf)# exit
device(config)# router ospf vrf green
device(config-ospf-router-vrf-green)# area 0
device(config-ospf-router-vrf-green)# redistribute bgp
device(config-ospf-router-vrf-green)# exit
device(config)# router ospf vrf red
device(config-ospf-router-vrf-red)# area 0
device(config-ospf-router-vrf-red)# redistribute bgp
device(config-ospf-router-vrf-red)# exit
device(config)# interface ethernet 0/2
device(conf-if-eth-0/2)# vrf forwarding green
device(conf-if-eth-0/2)# ip ospf area 0
device(conf-if-eth-0/2)# ip address 10.2.1.1/24
device(conf-if-eth-0/2)# interface ethernet 0/3
device(conf-if-eth-0/3)# vrf forwarding red
device(conf-if-eth-0/3)# ip ospf area 0
device(conf-if-eth-0/3)# ip address 10.3.1.1/24
device(conf-if-eth-0/3)# exit
device(config)# interface ve 10
device(config-Ve-10)# vrf forwarding green
device(config-Ve-10)# ip address 10.2.1.1/24
device(config-Ve-10)# exit
device(config)# interface ve 20
device(config-ve-20)# vrf forwarding red
device(config-ve-20)# ip address 10.3.1.1/24

```

Multi-VRF with eBGP and OSPF: Configuring CE1 and CE2

The CE1 and CE2 router configurations are exactly the same. Both are configured in OSPF Area 0 with route redistribution enabled. The IP addresses 10.1.2.1/32 and 10.1.3.1/32 are configured for loopback interfaces, allowing them to carry routes from these networks.

1. Enable OSPF routing.

```
device(config)# router ospf
device(config-router-ospf-default-vrf)#
```

2. Assign Area 0.

```
device(config-router-ospf-default-vrf)# area 0
```

3. Redistribute connected routes into OSPF and exit the OSPF configuration.

```
device(config-router-ospf-default-vrf)# redistribute connected
device(config-router-ospf-default-vrf)# exit
device(config)#
```

4. Configure a loopback interface.

```
device(config)# interface loopback 1
device(config-Loopback-1)# ip address 10.1.1.1/32
```

5. Configure an Ethernet interface, assign it to Area 0, and assign it to the appropriate network.

```
device(config-Loopback-1)# interface ethernet 0/1
device(conf-if-eth-0/1)# ip ospf area 0
device(conf-if-eth-0/1)# ip address 10.1.2.1/24
```

6. Repeat the above for additional loopback and Ethernet interfaces.

Multi-VRF with eBGP and OSPF: Configuring CE3 and CE4

The CE3 and CE4 router configurations are exactly the same. Both are configured in OSPF Area 0 with route redistribution enabled.

The following summarizes the configuration.

```
device(config)# router ospf
device(config-router-ospf-default-vrf)# area 0
device(config-router-ospf-default-vrf)# redistribute connected
device(config-router-ospf-default-vrf)# exit
device(config)# interface loopback 1
device(config-Loopback-1)# ip address 10.1.1.1/32
device(config-Loopback-1)# exit
device(config)# interface loopback 2
device(config-Loopback-2)# ip address 10.1.1.2/32
device(config-Loopback-2)# exit
device(config)# interface ethernet 0/1
device(conf-if-eth-0/1)# ip ospf area 0
device(conf-if-eth-0/1)# ip address 10.2.2.1/24
device(config)# interface ethernet 0/2
device(conf-if-eth-0/2)# ip ospf area 0
device(conf-if-eth-0/2)# ip address 10.2.3.1/24
```

Inter-VRF route leaking

VRFs operate without knowledge of one another unless they are imported or exported into one another by means of inter-VRF route leaking. This feature allows the leaking of route prefixes from one VRF instance to another VRF instance on the same physical router,

which eliminates the need for external routing. This is useful in cases where multiple VRFs share the same path to reach an external domain, while maintaining the internal routing information limited to their own VRFs. This feature enables a data center to consolidate multiple VRF services onto a single server.

Both static and dynamic route leaking are supported. Each routed interface (whether virtual or physical) can belong to only one VRF.

Static route leaking provides a mechanism to leak manually configured route entries from a source VRF to a destination VRF.

Dynamic route leaking provides a mechanism to leak routes learned from routing protocols such as BGP and OSPF from a source VRF to a destination VRF. The user can leak routes by configuring a route map and associating this route map with a source VRF. The match criteria defined in the route map consist of specific route prefixes that exist in the source VRF.

Dynamic route-leak restrictions

- Exporting of route maps is not supported.
- Match criteria in a route map must be provided with prefix lists; other match criteria is ignored.
- Routes in the management-vrf with a next-hop as eth0 or a management interface are not leaked.

Inter-VRF route conflicts

ATTENTION

This feature should be deployed only by an advanced user, as route leak configuration in source VRFs may collide with route/interface definitions in target VRFs. This may lead to unpredictable behavior in packet forwarding.

Some of the ways that leaked route conflicts can occur are the following:

- Static route conflict
- Dynamic route conflict
- Connected route conflict

A static route conflict may occur when the same prefix is reachable by two different next hops in the target VRF. The forwarding behavior would be different depending on which command occurred later. This following example global configuration lines would present a static route conflict for 10.1.2.0/24.

```
device(config)# vrf red
device(config-vrf-red)# ip route 10.1.2.0/24 next-hop-vrf green 10.1.1.1
device(config)# vrf green
device(config-vrf-green)# ip route 10.1.2.0/24 18.1.1.1
```

NOTE

However, if the source of the prefix in each case is different (for example, 10.1.2.0 comes from OSPF, BGP, static, or connected, then the method of conflict resolution mentioned above (where the most recent configuration takes precedence) does not apply. The order of preference is as follows: (1) connected, (2) static, (3) OSPF, and (4) BGP, assuming that the administrative distances for the prefixes are the defaults. In other words, when the prefix is installed through different sources (OSPF/BGP/static/connected), the prefix with the lowest administrative distance takes precedence. The most recently configured prefix rule applies only if the source of the prefix is the same.

ATTENTION

Ensure that identical prefixes are not leaked.

A dynamic route conflict can occur when dynamic routing protocols advertise different routes to the same prefix in the target VRF.

A connected route conflict is illustrated by the following example configuration lines:

```
device(config)# vrf red
device(config-vrf-red)# address-family ipv4 unicast
device(vrf-red-ipv4-unicast)# ip route 10.1.2.0/24 next-hop-vrf green 10.1.1.1
device(config)# interface ethernet 0/1
device(conf-if-eth-0/1)# vrf forwarding green
device(conf-if-eth-0/1)# ip address 10.1.2.1/24
```

NOTE

The user must be aware of such possible conflicts before deploying the route leak feature, as currently there is no error checking for these scenarios. A good rule is to make sure that definitions are globally unique and route collisions do not exist.

Configuring static inter-VRF route leaking

Use the following procedure to configure static inter-VRF route leaking.

ATTENTION

Static inter-VRF route leaking is a feature that should be deployed only by an advanced user.

1. Create the VRF instances you want to be the leaker (source VRF) and where the route is being leaked to (destination VRF).
2. Specify the interface for the source VRF and map it to the source VRF.
3. Enter the IP address/mask to be used for this VRF instance.
4. Specify the interface you want to be the destination VRF and map it to the destination VRF.
5. Specify the IP address/mask to receive the leaked route.
6. Change the configuration mode to source VRF address-family context.
7. Configure the route to be leaked, specifying the route prefix, the next-hop VRF name as the destination VRF and the next hop to the destination VRF.
8. Optional: (Optional) For bidirectional inter-VRF route leaking, repeat the above steps, but swap the source and destination addresses.

Example of static inter-VRF route leaking

In this example, one of the static routes in VRF "Blue" (10.50.2.0/24) is being allowed to communicate with one in VRF "Green" (10.55.2.0/24).

The ovals represent virtual partitions (VRFs) in the router. The destination VRF ("Green") is where the route is being leaked to, and the source VRF ("Blue") is where the route is being leaked from.

FIGURE 23 Static inter-VRF route leaking

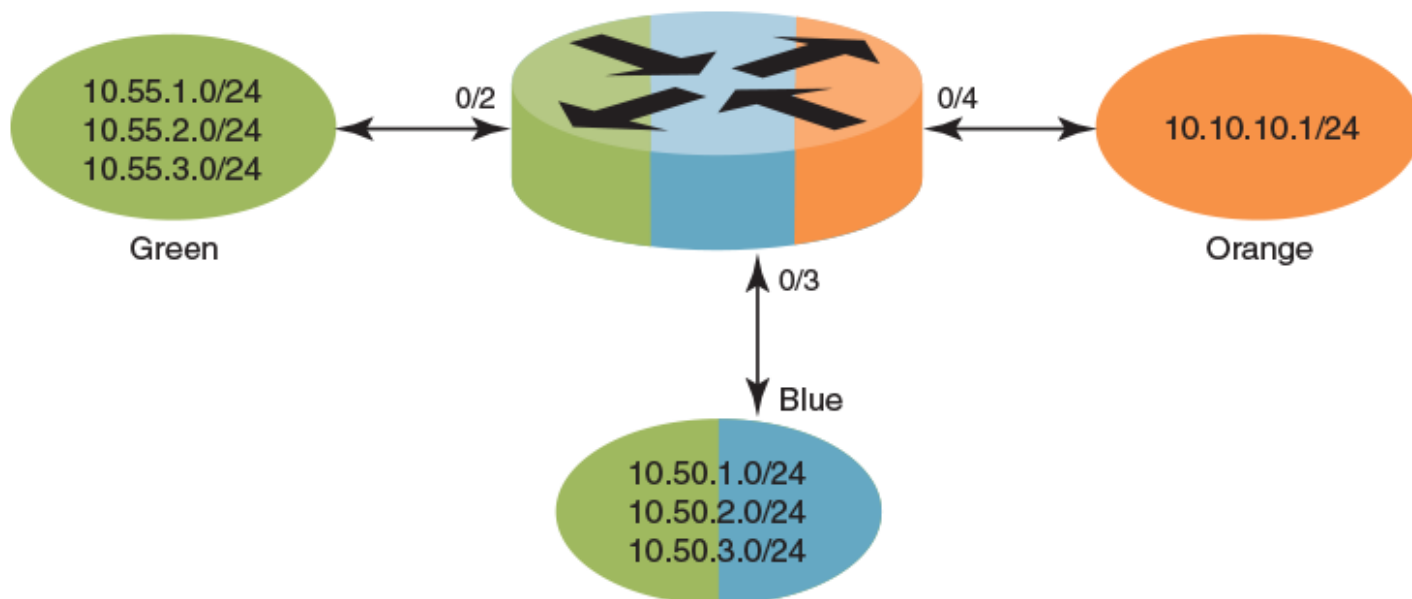

1. In global configuration mode, create and configure VRF "Green".

```
device(config)# vrf Green
device(conf-vrf-Green)# address-family ipv4 unicast
device(vrf-Green-ipv4-unicast)#
```

2. Repeat the above for VRF "Blue".

```
device(config)# vrf Blue
device(conf-vrf-Blue)# address-family ipv4 unicast
device(vrf-Blue-ipv4-unicast)#
```

3. Configure an interface in the destination VRF "Green" by using the **vrf forwarding** command and configuring a corresponding IP address and subnet mask.

```
device(config)# interface eth 0/2
device(conf-eth-0/2)# vrf forwarding Green
device(conf-eth-0/2)# ip address 10.55.1.2/24
```

4. Repeat the above for the source VRF "Blue", with an appropriate interface and network.

```
device(config)# interface eth 0/3
device(conf-eth-0/3)# vrf forwarding Blue
device(conf-eth-0/3)# ip address 10.50.1.2/24
```

5. Enter address-family IPv4 unicast configuration mode for the source VRF address family context for configuring static route leak.

```
device(config)# vrf Blue
device(conf-vrf-Blue)# address-family ipv4 unicast
```

- Configure route leaking for a network (using the IP address and subnet mask), by specifying the destination next-hop VRF instance and the next hop in the destination VRF.

NOTE

The destination VRF can also be a specific port on an Ethernet interface. Refer to the *Brocade SLX-OS Command Reference* for details on the `ip route next-hop-vrf` command.

```
device(vrf-Blue-ipv4-unicast)# ip route 10.55.2.0/24 next-hop-vrf Green 10.55.1.1
```

- Configure route leaking for the default VRF for a network (using the IP address and subnet mask), by specifying the destination next-hop VRF instance and the default-vrf in the destination VRF.

```
device(vrf-Blue-ipv4-unicast)# ip route 20.0.0.0/24 next-hop-vrf default-vrf 10.1.1.1
```

- (Optional) For bidirectional route-leak traffic, you can also configure route leaking from VRF "Green" to VRF "Blue".

Inter-VRF route leaking and DHCP relay

In a DHCP relay setting, route leaking is controlled through a single DHCP server (which may be on a different VRF); this permits multiple VRFs to communicate with that server, something that would normally not be permitted. DHCP relay deployments in a data center can use Inter-VRF route leaking to achieve server consolidation; this permits clients in multiple VRFs to communicate with a single DHCP server in a different VRF (normally this is not permitted, as VRFs provide route/traffic isolation).

The illustration below shows four VRFs, with three of them connecting to the fourth for DHCP services. (For more information on working with DHCP IP Relay, refer to the "DHCPv4" chapter.)

FIGURE 24 Inter-VRF route leaking example for connecting clients to a DHCP server in a different VRF.

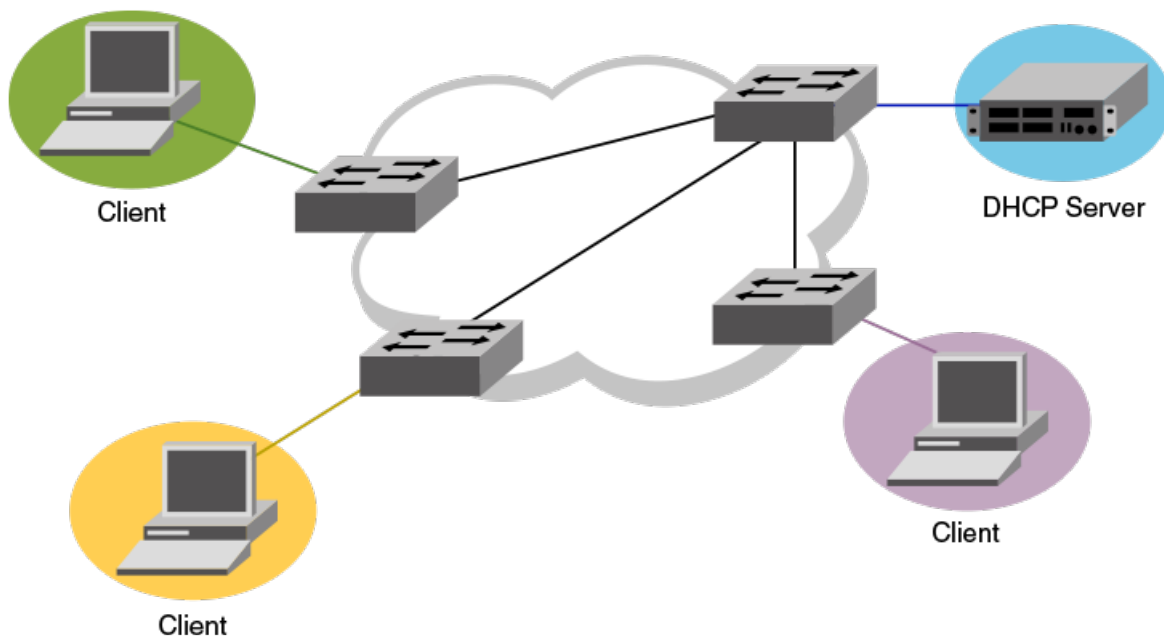

The following example shows setting up Inter-VRF route leaking and DHCP between the red VRF and the blue VRF.

NOTE

Inter-VRF route leaking supports both IPv4 and IPv6. Use the **ip address** and **ip route** commands for IPv4 and the **ipv6 address** and **ipv6 route** commands for IPv6. These commands support IP addresses, Ethernet interfaces, and virtual Ethernet (VE) interfaces for the leak destination. Refer to the *Brocade SLX-OS Command Reference*.

1. Configure VRF forwarding on a VE interface.

```
device(config)# interface ve 100
device(config-if-Ve-100)# no shutdown
device(config-if-Ve-100)# vrf forwarding red
  <- interface is in VRF "red" ->
device(config-if-Ve-100)# ip address 10.1.1.1/24
device(config-if--Ve-100)# ip dhcp relay address 20.1.1.2 use-vrf blue
  <- server is in VRF "blue" ->
```

2. Configure the leaked route on VRF "red".

```
device(config)# vrf red
device(conf-vrf-red)# address-family ipv4 unicast
device(vrf-red-ipv4-unicast)# max-route
device(vrf-red-ipv4-unicast)# ip route 20.1.1.2/32 next-hop-vrf blue 20.2.1.2
```

Configuring dynamic inter-VRF route leaking

Use the following basic procedure to configure dynamic Inter-VRF route leaking.

ATTENTION

Dynamic inter-VRF route leaking is a feature that should be deployed only by an advanced user.

NOTE

Note the following limitations and considerations for route leaking:

- Leaked routes will not be leaked again.
- Control plane protocols cannot run on leaked routes.
- Leaking the same prefix across VRFs is not supported. That is, a given prefix can be present in multiple VRFs, but it should not be leaked from one VRF to another. The behavior in such a case will be inconsistent.

1. Configure the VRF instances you want to be the leaker (source VRF) and where the route is being leaked to (destination VRF).
2. Specify the interface for the source VRF and map it to the source VRF.
3. Enter the IP address/mask to use for this VRF instance.
4. Specify the interface you want to be the destination VRF and map it to the destination VRF.
5. Specify the IP address/mask to receive the leak.
6. Configure the route map and associated prefix-list.
7. Change the configuration mode to destination VRF address family context. (IPv4 and IPv6 are supported.)
8. Configure the import command, specifying the source VRF and route map to be leaked.
9. (Optional) You can leak BGP or OSPF routes that were learned by the source VRF into the destination VRF. Static routes can also be leaked.

Example of Dynamic Inter-VRF route leaking

In this example, a route map called "import-map" has match criteria specified as prefixes that can be learned by means of routing protocols such as OSPF or BGP.

The figure below depicts a typical dynamic route-leaking scenario. VRFs "Yellow" and "Green" are virtual partitions in the same router. The destination VRF ("Green") is where the route is being leaked to, and the source VRF ("Yellow") is where the route is being leaked from. In this example, IPv4 is used.

FIGURE 25 Dynamic inter-VRF route leaking

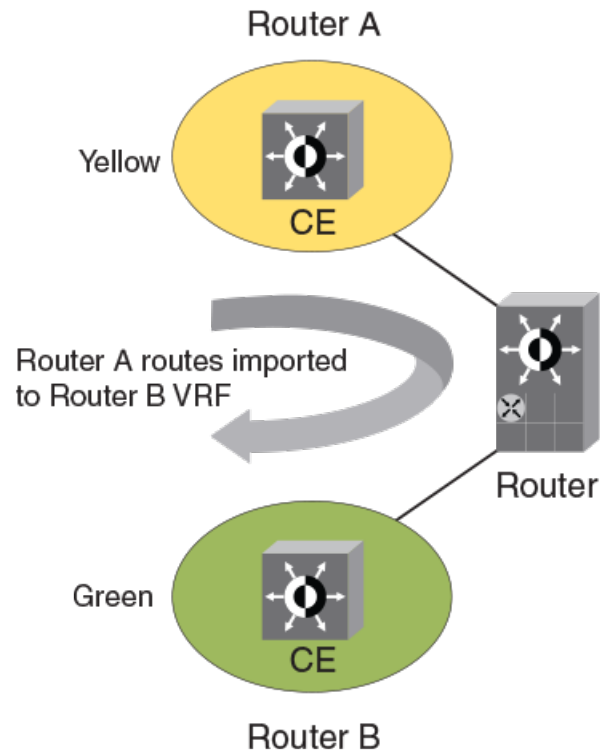

1. Configure VRF "Green".

```
device(config)# vrf Green
device(config-vrf-Green)# address-family ipv4 unicast
```

2. Configure VRF "Yellow".

```
device(config)# vrf Yellow
device(config-vrf-Yellow)# address-family ipv4 unicast
```

3. Configure an IPv4 prefix list, named "import-prefix" in this example.

```
device(config)# ip prefix-list import-prefix permit 10.2.3.0/24
device(config)# ip prefix-list import-prefix permit 10.1.2.0/24
```

4. Configure a route map with "match" conditions, including metric and tag for matched routes, and then import it.

```
device(config)# route-map import-map permit 10
device(config-route-map-import-map/permit/10)# match metric 10
device(config-route-map-import-map/permit/10)# match tag 10
device(config-route-map-import-map/permit/10)# match ip address prefix-list import-prefix
```

5. Import the desired route map for the specified VRF.

```
device(config)# vrf Green
device(config-vrf-Green)# address-family ipv4 unicast
device(vrf-Green-ipv4-unicast)# ip import routes Yellow route-map import-map
```

6. (Optional) Redistribute any routes learned by OSPF (or BGP) in the source VRF into the destination VRF. The following shows an OSPF example.

```
device(config-ipv4-unicast)# exit
device(config-vrf-Green)# exit
device(config)# router ospf
device(config-router-ospf-vrf-default-vrf)# redistribute ospf
```

Commands for dynamic inter-VRF route leaking

Commands you can use to import dynamic routes for Inter-VRF leaking are included in the following table and described in detail in the *Brocade SLX-OS Command Reference*.

Command	Description	Mode
ip import routes <i>VRF_name</i> route-map <i>rmap_name</i>	Leaks IPv4 routes from a specified VRF to the default VRF, based on match criteria defined in the specified route-map.	Global configuration
ip import routes <i>VRF_name</i> route-map <i>rmap_name</i>	Leaks IPv4 routes from one VRF to another VRF, based on match criteria defined in the specified route-map.	VRF address family configuration
ipv6 import routes <i>VRF_name</i> route-map <i>rmap_name</i>	Leaks IPv6 routes from a specified VRF to the default VRF, based on match criteria defined in the specified route-map.	Global configuration
ipv6 import routes <i>VRF_name</i> route-map <i>rmap_name</i>	Leaks IPv6 routes from one VRF to another VRF, based on match criteria defined in the specified route-map.	VRF address family configuration
show ip route import	Displays the IPv4 routes imported to a specified VRF.	Privileged EXEC
show ipv6 route import	Displays the IPv6 routes imported to a specified VRF.	Privileged EXEC
redistribute ospf	Redistributes leaked OSPFv3 (or OSPF v2) routes that were imported to another VRF into OSPF of this VRF instance.	OSPF VRF router configuration
redistribute bgp	Redistributes leaked BGP routes that were imported to another VRF into BGP of this VRF instance.	<ul style="list-style-type: none"> • Address-family ipv4 unicast • Address-family ipv6 unicast • Address-family ipv4 unicast vrf • Address-family ipv6 unicast vrf

NOTE

The **redistribute** commands enable OSPF or BGP to take the routes leaked from other VRFs and advertise them to peers. This enables the propagation of reachability information to other routers in the network for traffic forwarding.

VRRPv2

• VRRPv2 overview.....	249
• Enabling a master VRRP device.....	254
• Enabling a backup VRRP device.....	255
• VRRP multigroup clusters.....	256
• Tracked ports and track priority with VRRP and VRRP-E.....	259
• VRRP owner preemption and interface tracking.....	261
• VRRP backup preemption.....	262
• Virtual router MAC address.....	263
• VRRP-Ev2 overview.....	265
• Enabling a VRRP-E device.....	266
• Configuring MD5 authentication on IPv4 VRRP-E interfaces.....	267
• Track routes and track priority with VRRP-E.....	268
• VRRP-E load-balancing using short-path forwarding.....	270
• Displaying VRRPv2 information.....	272
• Clearing VRRPv2 statistics.....	274

VRRPv2 overview

Virtual Router Redundancy Protocol (VRRP) is an election protocol that provides redundancy to routers within a Local Area Network (LAN).

VRRP was designed to eliminate a single point of failure in a static default-route environment by dynamically assigning virtual IP routers to participating hosts. A virtual router is a collection of physical routers whose interfaces must belong to the same IP subnet. A virtual router ID (VRID) is assigned to each virtual router, but there is no restriction against reusing a VRID with a different address mapping on different LANs.

NOTE

VRRP extended (VRRP-E) is an extended version of the VRRP protocol. Brocade developed VRRP-E as a proprietary protocol to address some limitations in standards-based VRRP.

Before examining more details about how VRRP works, it is useful to see why VRRP was developed to solve the issue of a single point of failure.

FIGURE 26 Single point of failure with Device 1 being the Host1 default gateway

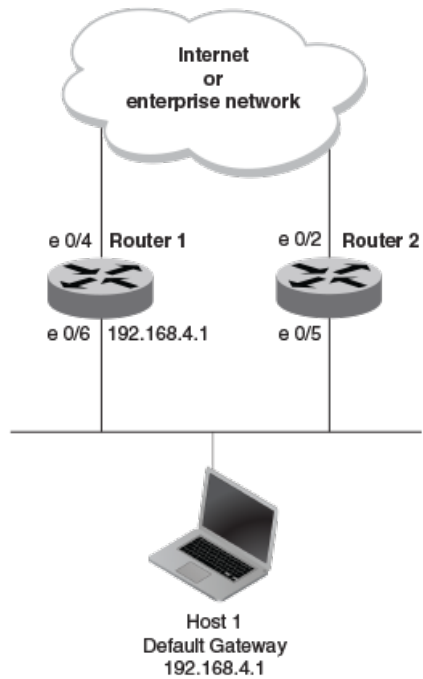

To connect to the Internet or an internal intranet Host 1, in the figure, uses the IP address of 192.168.4.1 on Router 1 as its default gateway. If this interface goes down, Host 1 is cut off from the rest of the network. Router 1 is a single point of failure for Host 1 to access other networks. In small networks, the administrative burden of configuring Router 2 as the new default gateway is not an issue, but in larger networks reconfiguring default gateways is impractical. Configuring a VRRP virtual router on Router 1 and Router 2 provides a redundant path for the hosts. VRRP allows you to provide alternate router paths for a host without changing the IP address or MAC address by which the host knows its gateway.

To illustrate how VRRP works, the following figure shows the same network, but a VRRP virtual router is configured on the two physical routers, Router 1 and Router 2. This virtual router provides redundant network access for Host 1. If Router 1 were to fail, Router 2 would provide the default gateway out of the subnet.

FIGURE 27 Devices configured as VRRP virtual routers for redundant network access for Host 1

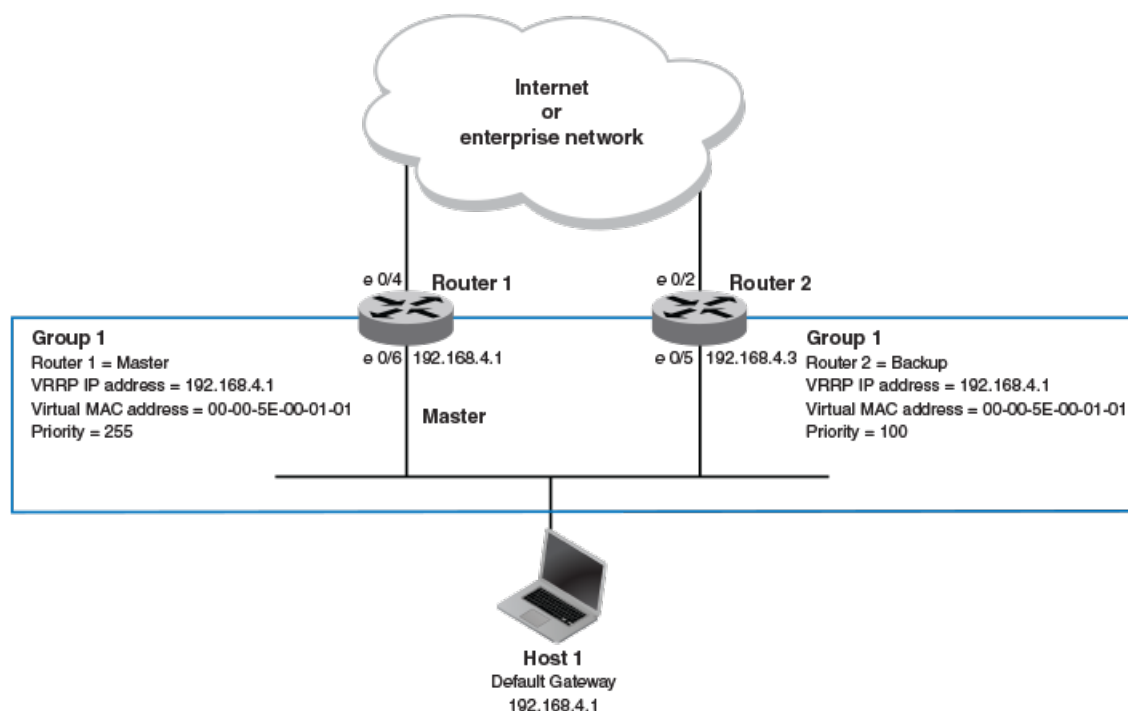

The blue rectangle in the figure represents a VRRP virtual router. When you configure a virtual router, one of the configuration parameters is a group number (also known as a virtual router ID or VRID), which can be a number from 1 through 255. The virtual router is identified with a group, and within the VRRP group, there is one physical device that forwards packets for the virtual router and this is called a master VRRP device. The VRRP master device may be a Layer 3 switch or a router.

In VRRP, one of the physical IP addresses is configured as the IP address of the virtual router, the virtual IP address. The device on which the virtual IP address is assigned becomes the VRRP owner, and this device responds to packets addressed to any of the IP addresses in the virtual router group. The owner device becomes the master VRRP device by default and is assigned the highest priority. Backup devices are configured as members of the virtual router group, and, if the master device goes offline, one of the backup devices assumes the role of the master device.

NOTE

VRRP operation is independent of BGP4 and OSPF. Their operation is unaffected when VRRP is enabled on the same interface as BGP4 or OSPF.

VRRP terminology

Before implementing VRRP in your network, you must understand some key terms and definitions.

The following VRRP-related terms are in logical order, not alphabetic order:

<i>Virtual router</i>	A collection of physical routers that can use VRRP to provide redundancy to routers within a LAN.
<i>Virtual router group</i>	A group of physical routers that are assigned to the same virtual router.
<i>Virtual router address</i>	The virtual router IP address must belong to the same subnet as a real IP address configured on the VRRP interface, and it can be the same as a real IP address configured on the VRRP interface. The virtual router whose virtual IP address is the same as a real IP address is the IP address owner and the default master.

<i>Owner</i>	The owner is the physical router whose real interface IP address is the IP address that you assign to the virtual router. The owner responds to packets addressed to any of the IP addresses in the corresponding virtual router. The owner, by default, is the master and has the highest priority (255).
<i>Master</i>	The physical router that responds to packets addressed to any of the IP addresses in the corresponding virtual router. For VRRP, if the physical router whose real interface IP address is the IP address of the virtual router, then this physical router is always the master.
<i>Backup</i>	Routers that belong to a virtual router, but are not the master. If the master becomes unavailable, the backup router with the highest priority (a configurable value) becomes the new master. By default, routers are given a priority of 100.

SLX-OS VRRP and VRRP-E interoperability

While VRRP follows RFC standards and can be used across devices from multiple vendors, Brocade has its proprietary extension of VRRP, VRRP Extended (VRRP-E) which has strict interoperability rules across Brocade devices.

In the standard SLX-OS VRRP implementation, the first five octets of the virtual MAC (VMAC) address are the standard MAC prefix for VRRP packets. The last octet is the virtual router ID (VRID). The only requirement for interoperability across other Brocade platform devices or other vendor devices is to ensure that the VRID is in the range of 1 to 16.

SLX-OS VRRP interoperability with Brocade or non-Brocade devices

The virtual router ID (VRID) must be in the range of 1 to 16.

SLX-OS VRRP-E interoperability with Brocade VDX devices

- The virtual router ID (VRID) must be in the range of 1 to 16.
- You must manually configure the VMAC on the Brocade VDX device for shared VRRP-E session with a Brocade SLX device.
- You must manually configure the VMAC on the Brocade SLX device for shared VRRP-E session with a Brocade VDX device.

SLX-OS VRRP-E interoperability with Brocade MLXe devices

- The virtual router ID (VRID) must be in the range of 1 to 16.
- You must manually configure the VMAC on the Brocade MLXe device using the MAC address from the SLX device VMAC for shared VRRP-E session with a Brocade SLX device.
- You must manually configure the VMAC on the Brocade SLX device for shared VRRP-E session with a Brocade MLXe device.

VRRP hold timer

The hold timer delays the preemption of a master VRRP device by a high-priority backup device.

A hold timer is used when a VRRP-enabled device that was previously a master device failed, but is now back up. This restored device now has a higher priority than the current VRRP master device, and VRRP normally triggers an immediate switchover. In this situation, it is possible that not all software components on the backup device have converged yet. The hold timer can enforce a waiting period before the higher-priority backup device assumes the role of master VRRP device again. The timer must be set to a number greater than 0 seconds for this functionality to take effect.

Hold timer functionality is supported in both version 2 and version 3 of VRRP and VRRP-E.

VRRP interval timers

Various timers for the intervals between hello messages sent between devices running VRRP can be configured.

Hello intervals

Hello messages are sent from the master VRRP device to the backup devices. The purpose of the hello messages is to determine that the master device is still online. If the backup devices stop receiving hello messages for a period of time, as defined by the dead (or master-down-interval) interval, the backup devices assume that the master device is offline. When the master device is offline, the backup device with the highest priority assumes the role of the master device.

Backup hello message state and interval

By default, backup devices do not send hello messages to advertise themselves to the master device. Hello messages from backup devices can be activated, and the messages are sent at 60-second intervals, by default. The interval between the backup hello messages can be modified.

VRRP authentication

The VRRP authentication type is not a parameter specific to the virtual router. VRRP uses the authentication type associated with the interfaces on which the virtual router is defined.

If your interfaces do not use authentication, neither does VRRP. For example, if you configure your device interfaces to use an MD5 password to authenticate traffic, VRRP uses the same MD5 password, and VRRP packets that do not contain the password are dropped.

In summary, if the interfaces on which you configure the virtual router use authentication, the VRRP or VRRP Extended (VRRP-E) packets on those interfaces must use the same authentication. The following VRRP and VRRP-E authentication types are supported:

- No authentication—The interfaces do not use authentication. This authentication type is the default for VRRP and VRRP-E.
- MD5—This method of authentication ensures that the packet is authentic and cannot be modified in transit. Syslog and SNMP traps are generated when a packet is dropped due to MD5 authentication failure. MD5 authentication is supported only in VRRP-E, and the device configuration is unique on a per-interface basis. The MD5 authentication configuration on an interface takes effect for all VRRP-E virtual routers configured on a particular interface.

ARP and VRRP control packets

Control packets for ARP and VRRP are handled differently by VRRP and VRRP-E.

Source MAC addresses in VRRP control packets

- VRRP—The virtual MAC address is the source.
- VRRP-E—The physical MAC address is the source.

VRRP control packets

- VRRP—Control packets are IP type 112 (reserved for VRRP), and they are sent to the VRRP multicast address 224.0.0.18.
- VRRP-E—Control packets are UDP packets destined to port 8888, and they are sent to the all-router multicast address 224.0.0.2.

Gratuitous ARP

When a VRRP device (either master or backup) sends an ARP request or a reply packet, the MAC address of the sender is the MAC address of the router interface. One exception is if the owner sends an ARP request or a reply packet, in which case the MAC address of the sender is the virtual MAC address. Only the master answers an ARP request for the virtual router IP address. Any backup router that receives this request forwards the request to the master.

- VRRP—A control message is sent only once when the VRRP device assumes the role of the master.
- VRRP-E—A control message is sent every 30 seconds by the VRRP-E master device because VRRP-E control packets do not use the virtual MAC address.

Enabling a master VRRP device

This task is performed on the device that is designated as the master VRRP device. For example, Router 1 is the master VRRP device in the figure that follows.

FIGURE 28 Basic VRRP topology

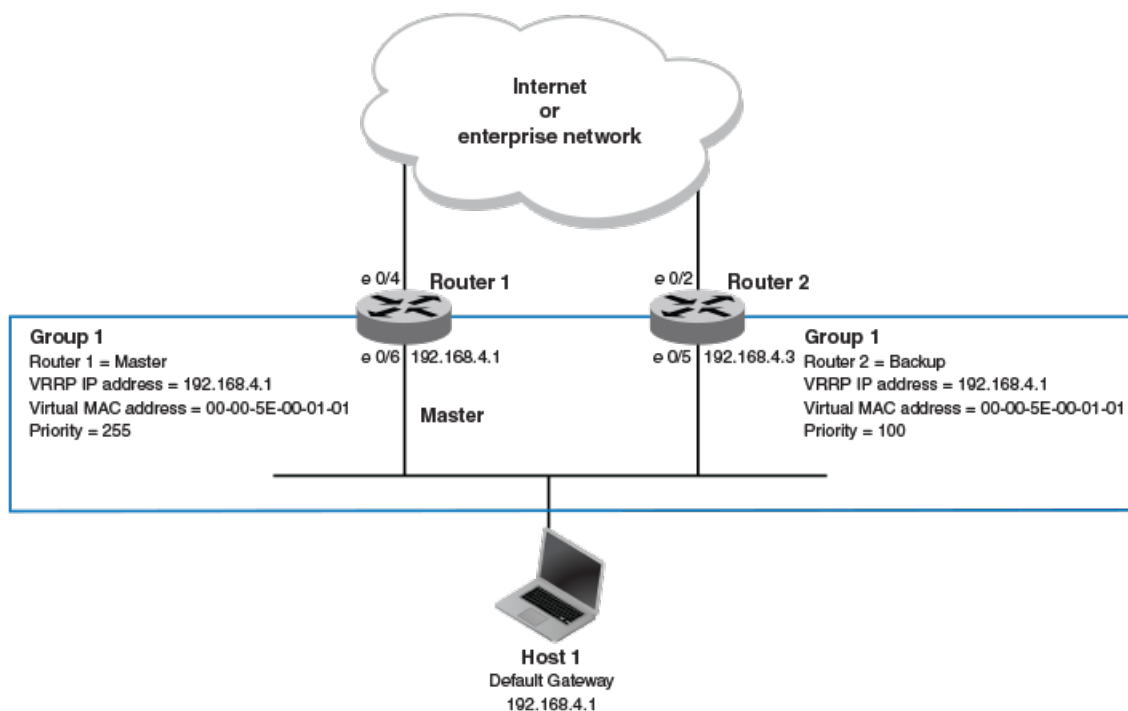

1. On the device designated as the master VRRP device, and from privileged EXEC mode, enter configuration mode.

```
device# configure terminal
```

2. Globally enable VRRP.

```
device(config)# protocol vrrp
```

3. Configure the Ethernet interface link for Router 1.

```
device(config)# interface ethernet 0/6
```

4. Configure the IP address of the interface.

```
device(config-if-eth-0/6)# ip address 192.168.4.1/24
```

5. Assign Router 1 to a group called Group 1.

```
device(config-if-eth-0/6)# vrrp-group 1
```

6. Assign a virtual router IP address.

```
device(config-vrrp-group-1)# virtual-ip 192.168.4.1
```

NOTE

For VRRP, the physical router whose IP address is the same as the virtual router group IP address becomes the owner and master.

The following example configures a VRRP master device.

```
device# configure
device(config)# protocol vrrp
device(config)# interface ethernet 0/6
device(config-if-eth-0/6)# ip address 192.168.4.1/24
device(config-if-eth-0/6)# vrrp-group 1
device(config-vrrp-group-1)# virtual-ip 192.168.4.1
```

Enabling a backup VRRP device

This task is performed on a device that is to be designated as a backup VRRP device. For example, Router 2 in [Figure 28](#) on page 254 is assigned as a backup device. Repeat this task for all devices that are to be designated as backup devices.

1. On the device designated as a backup VRRP device, and from privileged EXEC mode, enter global configuration mode.

```
device# configure terminal
```

2. Globally enable VRRP.

```
device(config)# protocol vrrp
```

3. Configure the Ethernet interface for Router 2.

```
device(config)# interface ethernet 0/5
```

4. Configure the IP address of interface:

```
device(config-if-eth-0/5)# ip address 192.168.4.3/24
```

NOTE

This router will become the backup router to Router 1.

5. Assign Router 2 to the same VRRP group as Router 1.

```
device(config-if-eth-0/5)# vrrp-group 1
```

6. To assign Group 1 a virtual IP address, use the same virtual IP address you used for Router 1.

```
device(config-vrrp-group-1)# virtual-ip 192.168.4.1
```

The following example configures a backup VRRP device.

```
device# configure
device(config)# protocol vrrp
device(config)# interface ethernet 0/5
device(conf-if-eth-0/5)# ip address 192.168.4.3/24
device(conf-if-eth-0/5)# vrrp-group 1
device(config-vrrp-group-1)# virtual-ip 192.168.4.1
```

VRRP multigroup clusters

Multigroup clusters allow redundancy for host devices and are supported by both VRRP and VRRP-E version 2 and version 3.

The figure below depicts a commonly employed virtual router topology. This topology introduces redundancy by configuring two virtual router groups — the first group has Router 1 as the master and Router 2 as the backup, and the second group has Router 2 as the master and Router 1 as the backup. This type of configuration is sometimes called *Multigroup VRRP*.

FIGURE 29 Two routers configured for dual redundant network access for the host

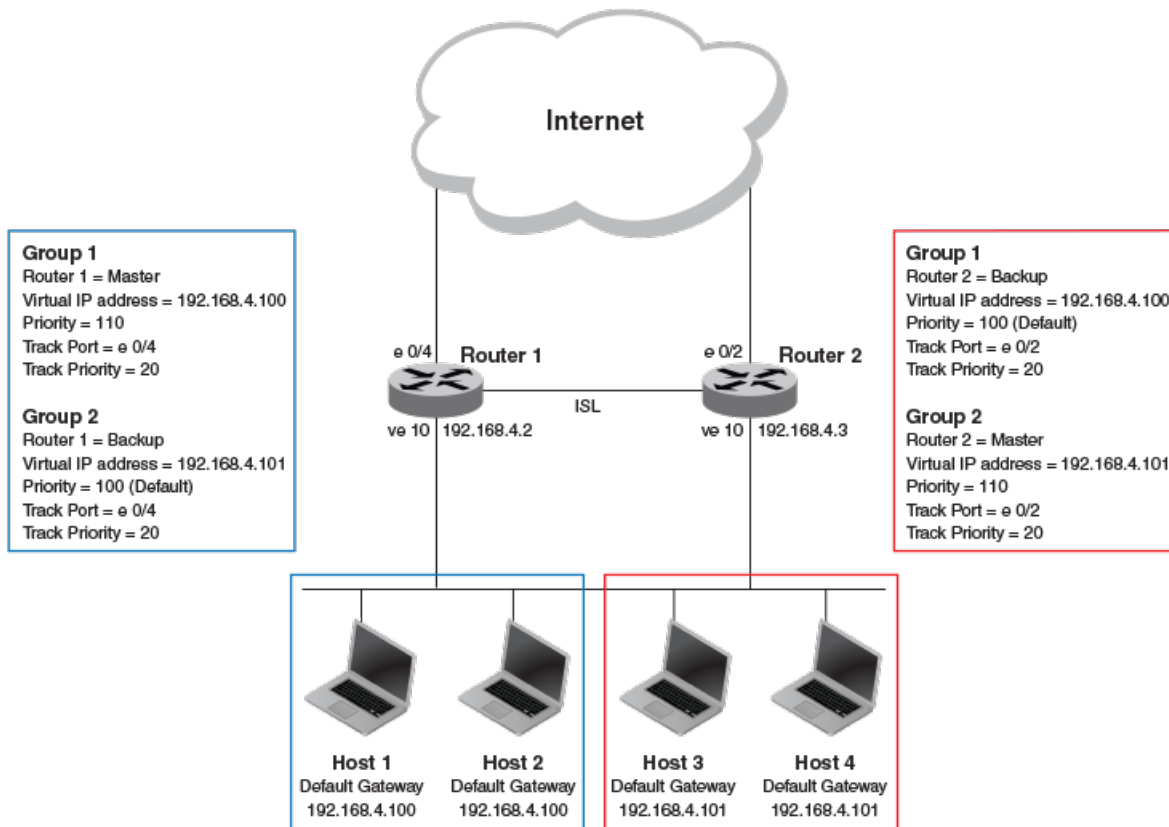

In this example, Router 1 and Router 2 use VRRP-E to load share as well as provide redundancy to the hosts. The load sharing is accomplished by creating two VRRP-E groups, each with its own virtual IP addresses. Half of the clients point to Group 1's virtual IP address as their default gateway, and the other half point to Group 2's virtual IP address as their default gateway. This enables some of the outbound Internet traffic to go through Router 1 and the rest to go through Router 2.

Router 1 is the master for Group 1 (master priority = 110) and Router 2 is the backup for Group 1 (backup priority = 100). Router 1 and Router 2 both track the uplinks to the Internet. If an uplink failure occurs on Router 1, its backup priority is decremented by 20 (track-port priority = 20) to 90, so that all traffic destined to the Internet is sent through Router 2 instead.

Similarly, Router 2 is the master for Group 2 (master priority = 110) and Router 1 is the backup for Group 2 (backup priority = 100). Router 1 and Router 2 are both tracking the uplinks to the Internet. If an uplink failure occurs on Router 2, its backup priority is decremented by 20 (track-port priority = 20) to 90, so that all traffic destined to the Internet is sent through Router 1 instead.

Configuring multigroup VRRP routing

Configuring VRRP multigroup clusters provides access redundancy to the host devices.

Before configuring this task, ensure that a virtual LAN, named vlan 10, has been created.

To implement the configuration of VRRP multigroup clusters as shown in [Figure 29](#) on page 256, configure one VRRP-E router to act as a master in the first virtual router group and as a backup in the second virtual group. Then configure the second VRRP-E router to act as a backup in the first virtual group and as a master in the second virtual group.

This example is for VRRP-E. There are minor syntax differences for VRRP, which you can determine by consulting the appropriate command reference. The task steps below are configured on Router 1 and there are three configuration examples at the end of the task showing how to configure Router 1 as a backup and Router 2 as a master and a backup VRRP-E device.

1. Enable the VRRP-E protocol globally.

```
device(config)# protocol vrrp-extended
```

2. Create a VLAN.

```
device(config)# vlan 10
```

3. Bind the VLAN to the virtual Ethernet (ve) interface link for Router 1.

```
device(config-vlan 10)# router-interface ve 10
```

4. Enter virtual Ethernet (ve) interface 10.

```
device(config-vlan 10)# interface ve 10
```

5. Configure the IP address of the ve link for Router 1.

```
device(config-if-Ve-10)# ip address 192.168.4.2/24
```

6. To assign Router 1 to a VRRP-E group called Group 1, enter the command:

```
device(config-if-Ve-10)# vrrp-extended-group 1
```

7. Configure the ethernet port 0/4 as the tracking port for the interface ve 10, with a track priority of 20.

```
device(config-vrrp-extended-group-1)# track ethernet 0/4 priority 20
```

8. Configure an IP address for the virtual router.

```
device(config-vrrp-extended-group-1)# virtual-ip 192.168.4.100
```

NOTE

(For VRRP-E only) The address you enter with the **virtual-ip** command cannot be the same as a real IP address configured on the interface.

9. To configure Router 1 as the master, set the priority to a value higher than the default (which is 100).

```
device(config-vrrp-group-1)# priority 110
```

Router 1 as backup

The following example configures Router 1 as a backup device for VRRP-E group 2 by configuring a priority (100) that is a lower value than the priority set for Router 2 in VRRP-E group 2.

```
device(config)# protocol vrrp-extended
device(config)# vlan 10
device(config-vlan-10)# router-interface ve 10
device(config-vlan-10)# interface ve 10
device(config-if-Ve-10)# ip address 192.168.4.2/24
device(config-if-Ve-10)# vrrp-extended-group 2
device(config-vrrp-extended-group-1)# track ethernet 0/4 priority 20
device(config-vrrp-extended-group-1)# virtual-ip 192.168.4.101
device(config-vrrp-group-1)# priority 100
```

Router 2 as master

The following example configures Router 2 as the master device for VRRP-E group 2 by configuring a priority (110) that is a higher value than the priority set for Router 1 in VRRP-E group 2.

```
device(config)# protocol vrrp-extended
device(config)# vlan 10
device(config-vlan-10)# router-interface ve 10
device(config-vlan-10)# interface ve 10
device(config-if-Ve-10)# ip address 192.168.4.3/24
device(config-if-Ve-10)# vrrp-extended-group 2
device(config-vrrp-extended-group-2)# track ethernet 0/4 priority 20
device(config-vrrp-extended-group-2)# virtual-ip 192.168.4.101
device(config-vrrp-group-1)# priority 110
```

Router 2 as backup

The following example configures Router 2 as a backup device for VRRP-E group 1 by configuring a priority (100) that is a lower value than the priority set for Router 1 in VRRP-E group 1.

```
device(config)# protocol vrrp-extended
device(config)# vlan 10
device(config-vlan-10)# router-interface ve 10
device(config-vlan-10)# interface ve 10
device(config-if-Ve-10)# ip address 192.168.4.3/24
device(config-if-Ve-10)# vrrp-extended-group 1
device(config-vrrp-extended-group-1)# track ethernet 0/4 priority 20
device(config-vrrp-extended-group-1)# virtual-ip 192.168.4.100
device(config-vrrp-group-1)# priority 100
```

Tracked ports and track priority with VRRP and VRRP-E

Port tracking allows interfaces not configured for VRRP or VRRP-E to be monitored for link-state changes that can result in dynamic changes to the VRRP device priority.

A tracked port allows you to monitor the state of the interfaces on the other end of a route path. A tracked interface also allows the virtual router to lower its priority if the exit path interface goes down, allowing another virtual router in the same VRRP (or VRRP-E) group to take over. When a tracked interface returns to an up state, the configured track priority is added to the current virtual router priority value.

The following conditions and limitations exist for tracked ports:

- Track priorities must be lower than VRRP or VRRP-E priorities.
- The dynamic change of router priority can trigger a master device switchover if preemption is enabled. However, if the router is an owner, the master device switchover will not occur.
- The maximum number of interfaces that can be tracked for a virtual router is 16.
- Port tracking is allowed for physical interfaces and port channels.

Configuring VRRP port tracking

Configuring port tracking on an exit path interface and setting a priority on a VRRP device enables VRRP to monitor the interface. If the interface goes down, the device priority is lowered and another backup device with a higher priority assumes the role of master.

In the following task steps, interface ethernet 0/4 on Router 1 (shown in the diagram below) is configured to be tracked, and if the interface fails, the VRRP priority of Router 1 is lowered by a value of 20. Router 1 is the master VRRP device for group 1 and a lower priority triggers a backup device with a higher priority, Router 2, to become the new master for Group 1. Perform this task on the device on which the tracked interface exists.

FIGURE 30 Multigroup VRRP routing topology

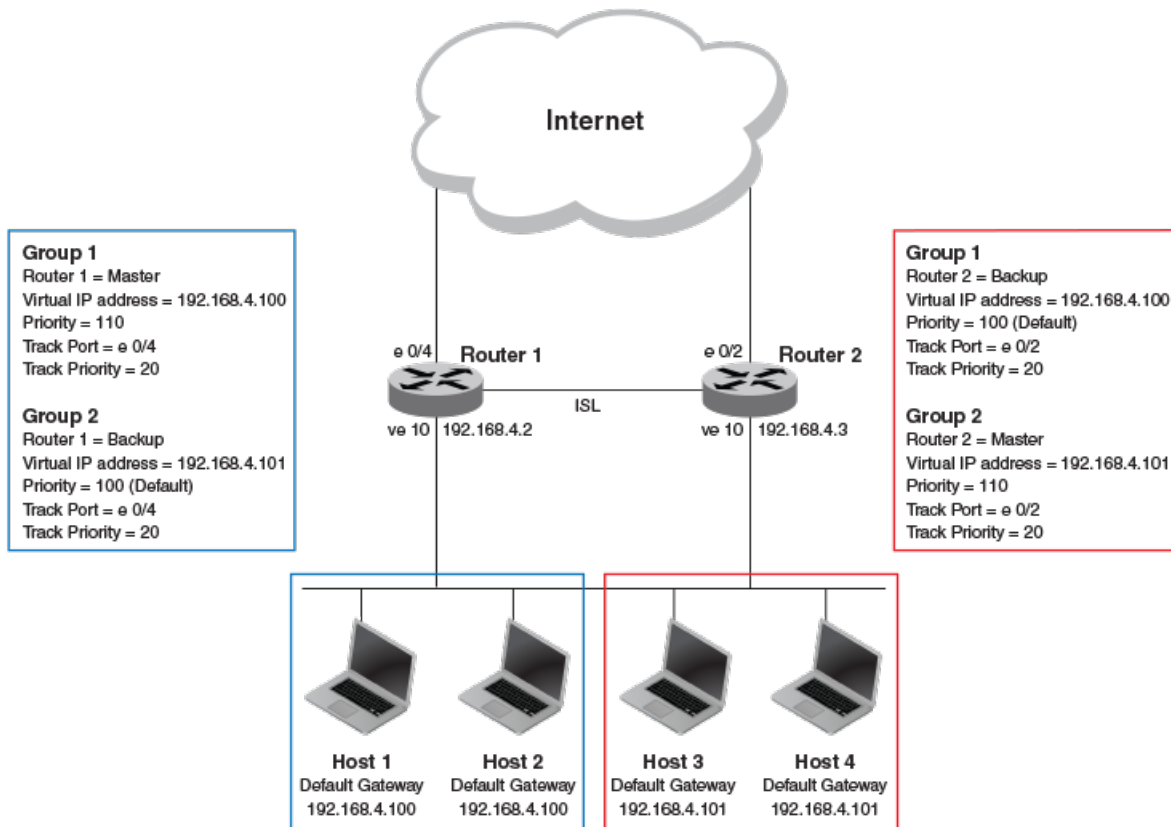

1. Enable VRRP globally.

```
device(config)# protocol vrrp
```

2. Enter interface configuration mode and run the following command:

```
device(config)# interface ve 10
```

3. Run the following command to enter group configuration mode.

```
device(config-if-Ve-10)# vrrp-group 1
```

4. Enter the **track** command to set the track port and priority:

```
device(config-vrrp-group-1)# track ethernet 0/4 priority 20
```

The following example shows how to configure an Ethernet interface on Router 2 to be tracked, and if the interface fails, the VRRP priority of Router 2 is lowered by a value of 40. Router 2 is the master VRRP device for group 2 and a lower priority triggers a backup device, Router 1, to become the new master for group 2.

```
device(config)# protocol vrrp
device(config)# interface ve 10
device(config-if-Ve-10)# vrrp-group 2
device(config-vrrp-group-1)# track ethernet 0/4 priority 20
```

VRRP owner preemption and interface tracking

Owner preemption can be enabled for a VRRP session by setting a priority value less than the default value of 255. Tracking interfaces for an VRRP owner session can be enabled by setting a tracked interface priority value.

In VRRP, an IP address is assigned to a virtual router and owner device is the physical router whose real interface IP address is the IP address that you assign to the virtual router. A virtual router is a collection of physical routers that can use VRRP to provide redundancy to routers within a LAN. The owner device responds to packets addressed to any of the IP addresses in the corresponding virtual router. By default, the owner is the master VRRP device and has the highest priority of 255.

VRRP owner preemption allows a lower device priority to be set and if a backup VRRP device has a higher priority, the backup device assumes the master VRRP role and the current owner device becomes a backup device. One use case for VRRP owner preemption is when you need to install a software upgrade and the device must be reloaded. If the device remains the master device during the upgrade and reload process, network data may be lost. After VRRP preemption is disabled, the owner priority reverts to 255 and the owner device assumes the role of the master VRRP device again.

The tracking of interfaces on a VRRP owner session can be enabled, regardless of whether owner preemption is enabled or disabled. The tracked interface value configured for the owner device overrides any configured individual tracked interface priorities. When owner preemption is enabled, the current priority of the owner session is determined by the configured owner priority and the track priorities of tracked ports. If a backup VRRP device has a higher priority than the combination of the owner and tracked interface priority, it assumes the role of master VRRP device. When owner preemption is disabled, the tracking of interfaces does not affect the current owner priority.

Enabling VRRP owner preemption and interface tracking

VRRP owner preemption is enabled when the owner priority is set to a value less than the default value of 255. Interfaces can be tracked on owner devices when the interface track priority is configured.

This task assumes that VRRP master and backup devices are already configured.

VRRP preemption can be useful when a software upgrade must be installed and reloaded on the owner device. Interface tracking is a useful troubleshooting tool to manage VRRP master and backup device priorities when interfaces fail. Reducing the priority value of the VRRP owner device may cause a backup device to assume the role of the master device.

1. On the device designated as the master VRRP device, and from privileged EXEC mode, enter configuration mode.

```
device# configure terminal
```

2. Globally enable VRRP.

```
device(config)# protocol vrrp
```

3. Configure the Ethernet interface link for Router 1.

```
device(config)# interface ethernet 0/6
```

4. Configure the IP address of the interface.

```
device(conf-if-eth-0/6)# ip address 192.168.4.1/24
```

5. Assign the device to a VRRP group named 1.

```
device(conf-if-eth-0/6)# vrrp-group 1
```

- Assign a virtual router IP address.

```
device(config-vrrp-group-1)# virtual-ip 192.168.4.1
```

NOTE

For VRRP, the physical router whose IP address is the same as the virtual router group IP address becomes the owner and master.

- Enable owner preemption by assigning a lower priority than the master default of 255.

```
device(config-vrrp-group-1)# owner priority 200
```

- Assign an interface track priority for the owner session. This value overrides any configured individual tracked interface priorities.

```
device(config-vrrp-group-1)# owner track-priority 20
```

NOTE

When owner preemption is enabled, if a backup VRRP device has a higher priority than the combination of the owner and tracked interface priority, it assumes the role of the master VRRP device.

The following example configures the VRRP owner device priority to 200 and the tracked interface priority to 20.

```
device# configure terminal
device(config)# protocol vrrp
device(config)# interface ethernet 0/6
device(conf-if-eth-0/6)# ip address 192.168.4.1/24
device(conf-if-eth-0/6)# vrrp-group 1
device(config-vrrp-group-1)# virtual-ip 192.168.4.1
device(config-vrrp-group-1)# owner priority 200
device(config-vrrp-group-1)# owner track-priority 20
```

VRRP backup preemption

Preemption of a backup VRRP device acting as a master device is allowed when another backup device has a higher priority.

By default, preemption is enabled for VRRP. In VRRP, preemption allows a backup device with the highest priority to become the master device when the master (also the owner) device goes offline. If another backup device is added with a higher priority, it will assume the role of the master VRRP device. In some larger networks there may be a number of backup devices with varying levels of priority, and preemption can cause network flapping. To prevent the flapping, disable preemption.

NOTE

If preemption is disabled for VRRP, the owner device is not affected because the owner device always preempts the active master. When the owner device is online, the owner device assumes the role of the master device regardless of the setting for the preempt parameter.

In VRRP-E, preemption is disabled by default. In situations where a new backup device is to be added with a higher priority, preemption can be enabled. There are no owner devices in VRRP-E to automatically preempt a master device.

Enabling VRRP backup preemption

Allowing a backup VRRP device that is acting as the master to be preempted by another backup device with a higher priority value.

A VRRP session must be globally enabled using the **protocol vrrp** command in global configuration mode.

Preemption is enabled by default for VRRP, and disabled by default on VRRP-E. Assuming that preemption is disabled in a VRRP session, perform the following steps on a VRRP backup device.

1. From global configuration mode, configure the ethernet interface for the device.

```
device(config)# interface ethernet 0/5
```

2. Configure the IP address of the interface:

```
device(conf-if-eth-0/5)# ip address 192.168.4.3/24
```

NOTE

This router is a backup router.

3. Assign the device to VRRP group 1.

```
device(conf-if-eth-0/5)# vrrp-group 1
```

4. Enter the **preempt-mode** command to configure backup preemption.

```
device(conf-vrrp-group-1)# preempt-mode
```

If a backup device has a higher priority than the current master device, the backup device will assume the role of the VRRP master device after preemption is enabled.

The following example enables preemption on a backup VRRP device.

```
device(config)# interface ethernet 0/5
device(conf-if-eth-0/5)# ip address 192.168.4.3/24
device(conf-if-eth-0/5)# vrrp-group 1
device(conf-vrrp-group-1)# preempt-mode
```

Virtual router MAC address

When you configure a virtual routing ID (VRID), the software automatically uses the MAC address as the MAC address of the virtual router. The first five octets of the address are the standard MAC prefix for VRRP packets. The last octet is the VRID.

When the virtual router becomes the master router, it broadcasts a gratuitous ARP (GARP) request containing the virtual router's MAC address for each IP address associated with the virtual router. Hosts use the MAC address of the virtual router in routed traffic they send to their default IP gateway.

You can manually configure a unique virtual MAC address for each IPv4 and IPv6 VRRP instance per VRID. If there is no manually configured virtual MAC address for a VRRP instance, the system automatically assigns one.

The ability to configure a unique virtual MAC address is subject to the following limitations:

- This feature does not support configurable VRRP virtual MAC addresses over Multi-Chassis Trunking (MCT).
- This feature has no impact on short-path forwarding for VRRP-E.

NOTE

A virtual MAC address can be dynamically updated while a VRRP or VRRP-E session is enabled. When the VRRP or VRRP-E virtual MAC address is modified on the master device, expect a traffic drop until the host device receives the GARP or Router Advertisement (RA) containing the updated virtual MAC address from the master VRRP device.

Configuring unique virtual MAC addresses per VRID

In addition to system-configured standards-based virtual MAC addresses, you can manually configure a unique virtual MAC address for each IPv4 and IPv6 VRRP or VRRP-E instance per virtual routing ID (VRID). If there is no manually configured virtual MAC address (VMAC) for a VRRP instance, the system automatically assigns one.

On Brocade SLX devices, you can configure a maximum of 16 virtual router MAC addresses per device; this includes both IPv4 VRRP-E & IPv6 VRRP-E sessions.

NOTE

System-assigned virtual MAC addresses and manually configured virtual MAC addresses can exist at the same time on the device under the same VRID, however the configured value takes precedence. When the configured value is deleted, the assigned value again applies.

NOTE

A virtual MAC address can be dynamically updated while a VRRP or VRRP-E session is enabled. When the VRRP or VRRP-E virtual MAC address is modified on the master device, expect a traffic drop until the host device receives the GARP request or Router Advertisement (RA) containing the updated virtual MAC address from the master VRRP device.

To configure a unique VRRP or VRRP-E virtual MAC address for a VRID, complete the following steps.

1. On the device designated as a VRRP-E device, from privileged EXEC mode, enter configuration mode by issuing the **configure terminal** command.

```
device# configure terminal
```

2. Globally enable the VRRP-E protocol.

```
device(config)# protocol vrrp-extended
```

3. Configure a virtual ethernet interface link.

```
device(config)# interface ve 10
```

4. Configure the IP address of the interface. All devices configured for the same VRID must be on the same subnet.

```
device(config-if-Ve-10)# ip address 10.53.5.3/24
```

5. Assign the device to VRID group 12.

```
device(config-if-Ve-10)# vrrp-extended-group 12
```

NOTE

You can assign a VRID number in the range of 1 through 16.

6. Manually configure an IPv4 virtual MAC address for virtual router group 12.

```
device(config-vrrp-extended-group-12)# virtual-mac 02e0.5200.0012
```

NOTE

System-assigned virtual MAC addresses and manually configured virtual MAC addresses can exist at the same time on the device under the same VRID, however the configured value takes precedence. When the configured value is deleted, the assigned value again applies.

7. To display IPv4 VRRP-E virtual MAC address configuration information about VRID 12 (for example), enter the following command:

```
device# show vrrp detail

Total number of VRRP session(s)   : 1

VRID 12
  Interface: Ve 10;  Iindex: 1207959562
  Mode: VRRPE
  Admin Status: Enabled
  Description :
  Address family: IPv4
  Version: 2
  Authentication type: MD5 Authentication
  State: Initialize
  Session Master IP Address:
  Virtual IP(s): 192.168.4.100
  Virtual MAC Address: 02e0.5200.0112
  .
  .
  .
```

The partial output shows the manually configured VMAC address.

The following example configures an IPv4 virtual MAC address for VRID 12 on a VRRP-E device.

```
device# configure terminal
device(config)# protocol vrrp-extended
device(config)# interface ve 10
device(config-if-Ve-10)# ip address 10.53.5.3/24
device(config-if-Ve-10)# vrrp-extended-group 12
device(config-vrrp-extended-group-12)# virtual-mac 02e0.5200.0012
```

VRRP-Ev2 overview

VRRP Extended (VRRP-E) is an extended version of VRRP. VRRP-E is designed to avoid the limitations in the standards-based VRRP.

To create VRRP-E, Brocade has implemented the following differences from RFC 3768 which describes VRRPv2 to provide extended functionality and ease of configuration:

- VRRP-E does not include the concept of an owner device, and a master VRRP-E is determined by the priority configured on the device.
- While the VRRP-E virtual router IP address must belong in the same subnet as a real IP address assigned to a physical interface of the device on which VRRP-E is configured, it must not be the same as any of the actual IP addresses on any interface.
- Configuring VRRP-E uses the same task steps for all devices; there are no differences between master and backup device configuration. The device configured with the highest priority assumes the master role.

VRRP-E is not supported on non-Brocade devices and does not interoperate with VRRP sessions on Brocade devices.

Enabling a VRRP-E device

This task is performed on all devices that are designated as VRRP extended (VRRP-E) devices. While VRRP-E does not have owner devices, there is still a master device and backup devices with the master device determined by the device with the highest priority.

1. From privileged EXEC mode, enter configuration mode by issuing the **configure terminal** command.

```
device# configure terminal
```

2. Globally enable VRRP-E.

```
device(config)# protocol vrrp-extended
```

3. Configure the Virtual Ethernet (VE) interface link for the VRRP-E device.

```
device(config)# interface ve 10
```

Only ve interfaces are supported by VRRP-E.

4. Configure the IP address of the interface.

```
device(config-if-Ve-10)# ip address 192.168.4.1/24
```

5. Assign the device to a group called Group 1.

```
device(config-if-Ve-10)# vrrp-extended-group 1
```

6. Enter the **priority** command with a number to assign a priority.

```
device(config-vrrp-group-1)# priority 110
```

The VRRP-E device with the highest priority number becomes the master device.

7. Assign a virtual router IP address.

```
device(config-vrrp-group-1)# virtual-ip 192.168.4.100
```

NOTE

For VRRP-E, the virtual router group IP address must not be the same as a real IP address configured on the interface.

Router 1

The following example configures a master VRRP-E device for group 1.

```
device# configure terminal
device(config)# protocol vrrp-extended
device(config)# interface ve 10
device(config-if-Ve-10)# ip address 192.168.4.1/24
device(config-if-Ve-10)# vrrp-extended-group 1
device(config-vrrp-group-1)# priority 110
device(config-vrrp-group-1)# virtual-ip 192.168.4.100
```

Router 2

The following example configures a backup VRRP-E device for group 1. In the first configuration of VRRP-E for Router 1 the priority is set to 110, higher than the priority for Router 2 at 80. Router 1 assumes the role of the master VRRP-E device.

```
device# configure terminal
device(config)# protocol vrrp-extended
device(config)# interface ve 10
device(config-if-Ve-10)# ip address 192.168.4.3/24
device(config-if-Ve-10)# vrrp-extended-group 1
device(config-vrrp-group-1)# priority 80
device(config-vrrp-group-1)# virtual-ip 192.168.4.100
```

Configuring MD5 authentication on IPv4 VRRP-E interfaces

Interfaces can be configured with an MD5 encrypted password for authentication, and VRRP-E can use the same authentication type associated with the interfaces on which you define the virtual router.

VRRP Extended (VRRP-E) must be configured on the device and the interface associated with a virtual router group.

Any VRRP-E packets that do not contain the password are dropped. If your interfaces do not use authentication, neither does VRRP-E. Repeat this task on all interfaces on all devices that support the same virtual router group.

NOTE

VRRP-E is not supported on non-Brocade devices.

1. From privileged EXEC mode, enter global configuration mode.

```
device# configure terminal
```

2. Globally enable VRRP-E.

```
device(config)# protocol vrrp-extended
```

3. Configure the Virtual Ethernet (VE) interface link for the VRRP-E device.

```
device(config)# interface ve 10
```

Only ve interfaces are supported by VRRP-E.

4. Enter the MD5 password configuration using the **ip vrrp-extended auth-type** command with a text password. The password will be encrypted when saved in the configuration file.

```
device(config-if-Ve-10)# ip vrrp-extended auth-type md5-auth kfhb61qp
```

5. Exit to privileged EXEC mode.

```
device(config-if-Ve-10)# end
```

6. Display the VRRP-E configuration to verify that MD5 authentication is enabled.

```

device# show vrrp

Total number of VRRP session(s)    : 1

VRID 1
  Interface: Ve 10;  Ifindex: 1207959562
  Mode: VRRPE
  Admin Status: Enabled
  Description :
  Address family: IPv4
  Version: 2
  Authentication type: MD5 Authentication
  State: Initialize
  Session Master IP Address:
  Virtual IP(s): 192.168.4.100
  Configured Priority: 110 (default: 100); Current Priority: unset
  Advertisement interval: 1 sec (default: 1 sec)
  Preempt mode: DISABLE (default: DISABLED)
  Advertise-backup: DISABLE (default: DISABLED)
  Backup Advertisement interval: 60 sec (default: 60 sec)
  Short-path-forwarding: Disabled
  Revert Priority: unset; SPF reverted: No
  Hold time: 0 sec (default: 0 sec)
  Trackport:
    Port(s)                Priority  Port Status
    =====                =====  =====
  Statistics:
    Advertisements: Rx: 0, Tx: 0
    Gratuitous ARP: Tx: 0

```

The following example configures MD5 authentication for the specified VRRP-E interface.

```

device# configure terminal
device(config)# protocol vrrp-extended
device(config)# interface ve 10
device(config-if-Ve-10)# ip vrrp-extended auth-type md5-auth kfhb61qp
device(config-if-Ve-10)# end
device# show vrrp

```

Track routes and track priority with VRRP-E

Route tracking allows networks not configured for VRRP extended (VRRP-E) to be monitored for network reachability changes that can result in dynamic changes to the VRRP-E device priority.

Using network addresses, routes are tracked for online or offline events. The networks to be tracked can be either present or absent from the Routing Information Base (RIB). When route-tracking is enabled in the configured VRRP-E instance, the status of the tracked route is monitored. The priority of the VRRP-E device may be changed dynamically due to the following events:

- When a tracked route goes into an offline state, the configured track priority is subtracted from the current value of the VRRP-E device.
- When a tracked route returns to an online state, the configured track priority is added to the current value of the VRRP-E device.

NOTE

Network tracking is not supported by VRRP; only VRRP-E supports network tracking.

The dynamic change of device priority can trigger a switchover from a master VRRP-E device to a backup VRRP-E device if preemption is enabled.

Forward referencing for tracked routes is supported. The tracked route can be removed and added without the need to reconfigure the tracking for the route.

NOTE

Maximum number of routes that can be tracked for a virtual VRRP-E device is 16.

Configuring VRRP-E route tracking

Configuring route tracking on an exit path network and setting a priority on a VRRP Extended (VRRP-E) device enables VRRP-E to monitor the route. If the network goes down, the device priority is lowered and another backup device with a higher priority assumes the role of master.

In the following task steps, network 10.1.1.0/24 is configured to be tracked, and if the network goes offline, the VRRP priority of the current master device is lowered by a value of 20.

1. Enable VRRP-E globally.

```
device(config)# protocol vrrp-extended
```

2. Enter interface configuration mode.

```
device(config)# interface ve 100
```

3. Run the following command to enter group configuration mode.

```
device(config-if-Ve-100)# vrrp-extended-group 1
```

4. Enter the **track network** command to set the track network (route) and priority:

```
device(config-vrrp-group-1)# track network 10.1.1.0/24 priority 20
```

5. Return to privileged EXEC mode.

```
device(config-vrrp-group-1)# end
```

6. To view tracked networks with their priority and status, enter the following command:

```
device# show vrrp detail

Total number of VRRP session(s)   : 1

VRID 3
  Interface: Ve 100;  Ifindex: 1207959652
  Mode: VRRPE
.
.
.
  Hold time: 0 sec (default: 0 sec)
  Master Down interval: 4 sec
  Trackport:
    Port(s)                Priority  Port Status
    =====                =====  =====

  Tracknetwork:
    Network(s)              Priority  Status
    =====                =====  =====
    10.1.1.0/24             20      Down

  Global Statistics:
  =====
    Checksum Error : 0
    Version Error  : 0
    VRID Invalid   : 0

  Session Statistics:
  =====
    Advertisements           : Rx: 0, Tx: 0
    Neighbor Advertisements  : Tx: 0
.
.
.
```

The following example shows how to configure network 10.1.1.0/24 to be tracked. If the network goes down, the VRRP-E device priority is lowered by a value of 20. The lower priority may trigger a switchover and a backup device with a higher priority becomes the new master for VRRP-E group 1.

```
device(config)# protocol vrrp-extended
device(config)# interface ve 100
device(config-if-Ve-100)# vrrp-extended-group 1
device(config-vrrp-group-1)# track network 10.1.1.0/24 priority 20
```

VRRP-E load-balancing using short-path forwarding

The VRRP-E Extension for Server Virtualization feature allows Brocade devices to bypass the VRRP-E master router and directly forward packets to their destination through interfaces on the VRRP-E backup router. This is called *short-path forwarding*. A backup router participates in a VRRP-E session only when short-path forwarding is enabled.

Packet routing with short-path forwarding to balance traffic load

When short-path forwarding is enabled, traffic load-balancing is performed because both master and backup devices can be used to forward packets.

FIGURE 31 Short-path forwarding

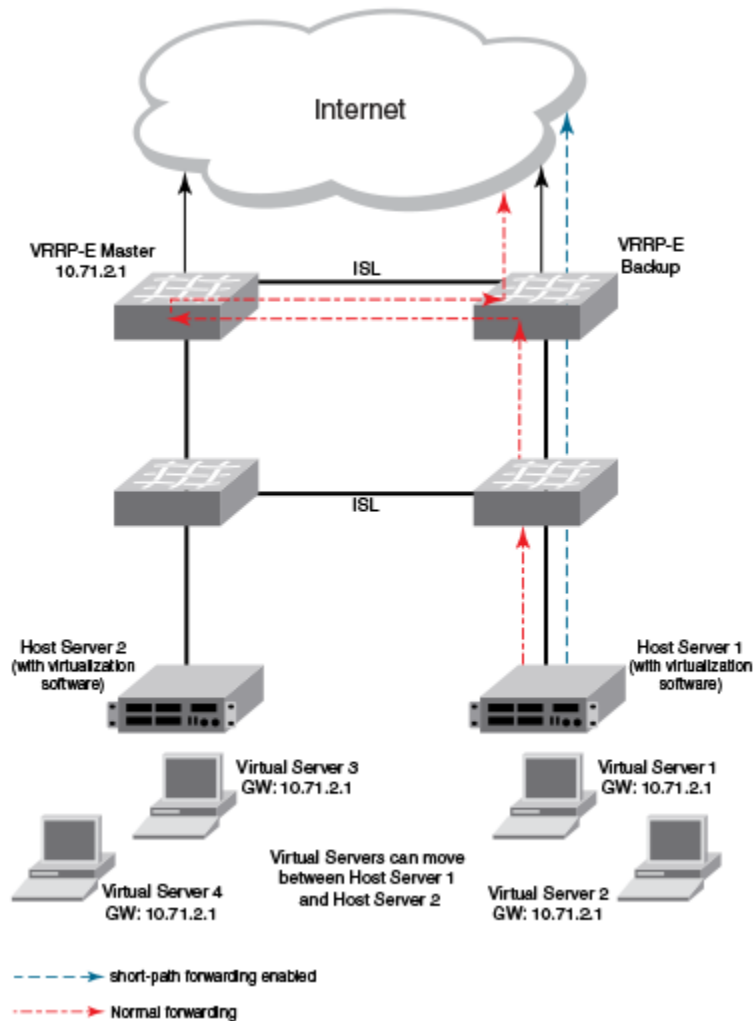

If you enable short-path forwarding in both master and backup VRRP-E devices, packets sent by Host Server 1 (in the figure) and destined for the Internet cloud through the device on which a VRRP-E backup interface exists can be routed directly to the VRRP-E backup device (blue dotted line) instead of being switched to the master router and then back (red dotted-dash line).

In the figure, load-balancing is achieved using short-path forwarding by dynamically moving the virtual servers between Host Server 1 and Host Server 2.

Short-path forwarding with revert priority

Revert priority is used to dynamically enable or disable VRRP-E short-path forwarding.

If short-path forwarding is configured with revert priority on a backup router, the revert priority represents a threshold for the current priority of the VRRP-E session. When the backup device priority is higher than the configured revert priority, the backup router is able to perform short-path forwarding. If the backup priority is lower than the revert priority, short-path forwarding is disabled.

Configuring VRRP-E load-balancing using short-path forwarding

VRRP-E traffic can be load-balanced using short-path forwarding on the backup devices.

Before configuring VRRP-E load-balancing, VRRP-E must be configured on all devices in the VRRP-E session.

Perform this task on all backup VRRP-E Layer 3 devices to allow load sharing within a VRRP extended group.

1. From privileged EXEC mode, enter global configuration mode.

```
device# configure terminal
```

2. Globally enable VRRP-E.

```
device(config)# protocol vrrp-extended
```

3. Enter the **interface ve** command with an associated VLAN number.

```
device(config)# interface ve 2019
```

In this example, virtual Ethernet (ve) configuration mode is entered and the interface is assigned with a VLAN number of 2019.

4. Enter an IP address for the interface using the **ip address** command.

```
device(config-ve-2019)# ip address 192.168.4.1/24
```

5. Enter the **vrrp-extended-group** command with a number to assign a VRRP-E group to the device.

```
device(config-ve-2019)# vrrp-extended-group 19
```

In this example, VRRP-E group configuration mode is entered.

6. Enter the **short-path-forwarding** command with a **revert-priority** value to configure the backup VRRP-E as an alternate path with a specified priority.

```
device(config-vrrp-extended-group-19)# short-path-forwarding revert-priority 50
```

When the backup device priority is higher than the configured **revert-priority** value, the backup router is able to perform short-path forwarding. If the backup priority is lower than the revert priority, short-path forwarding is disabled.

In the following example, short-path forwarding is configured on a backup VRRP-E device and a revert priority threshold is configured. If the backup device priority falls below this threshold, short-path forwarding is disabled.

```
device# configure
device(config)# protocol vrrp-extended
device(config)# interface ve 2019
device(config-ve-2019)# ip address 192.168.4.1/24
device(config-ve-2019)# vrrp-extended-group 19
device(config-vrrp-extended-group-19)# short-path-forwarding revert-priority 50
```

Displaying VRRPv2 information

Various show commands can be used to display statistical and summary information about VRRP and VRRP-E configurations.

Before displaying VRRP information, VRRPv2 must be configured and enabled in your VRRP or VRRP-E network to generate traffic.

Use one or more of the following commands to display VRRPv2 information. The commands do not have to be entered in this order.

1. Enter the **show vrrp** command with a virtual-group ID to display detailed information about one virtual group ID.

```
device# show vrrp 1

Total number of VRRP session(s)   : 1

VRID 1
  Interface: Ve 10;  Ifindex: 1207959562
  Mode: VRRP
  Admin Status: Enabled
  Description :
  Address family: IPv4
  Version: 2
  Authentication type: No Authentication
  State: Initialize
  Session Master IP Address:
  Virtual IP(s): 192.168.4.1
  Configured Priority: unset (default: 100); Current Priority: 100
  Advertisement interval: 1 sec (default: 1 sec)
  Preempt mode: ENABLE (default: ENABLE)
  Hold time: 0 sec (default: 0 sec)
  Trackport:
    Port(s)                Priority  Port Status
    =====
  Statistics:
    Advertisements: Rx: 60, Tx: 6
    Gratuitous ARP: Tx: 2
```

This example output shows that one IPv4 VRRP session is configured.

2. Enter the **show vrrp summary** command.

```
device# show vrrp summary

Total number of VRRP session(s)   : 1
Master session count   : 1
Backup session count   : 0
Init session count     : 0

VRID  Session  Interface      Admin  Current  State  Short-path  Revert  SPF
====  =====  =====      =====  =====  =====  =====  =====  =====
1      VRRP      Ve 100        Enabled  110      Master  Forwarding  Priority  Reverted
```

This example displays information about VRRP sessions.

3. Enter the **show vrrp interface** command with interface ve 10 options and detailed output.

```

device# show vrrp int ve 10 detail

Total number of VRRP session(s)   : 1

VRID 1
Interface: Ve 10;  Ifindex: 1207959562
Mode: VRRP
Admin Status: Enabled
Description :
Address family: IPv4
Version: 2
Authentication type: No Authentication
State: Initialize
Session Master IP Address:
Virtual IP(s): 192.168.4.1
Virtual MAC Address: 0000.5e00.0101
Configured Priority: 110 (default: 100); Current Priority: unset
Advertisement interval: 1 sec (default: 1 sec)
Preempt mode: ENABLE (default: ENABLE)
Hold time: 0 sec (default: 0 sec)
Master Down interval: 4 sec
Trackport:
  Port(s)                Priority  Port Status
  =====                =====  =====

Global Statistics:
=====
Checksum Error : 0
Version Error  : 0
VRID Invalid   : 0

Session Statistics:
=====
Advertisements           : Rx: 60, Tx: 6
Gratuitous ARP           : Tx: 2
Session becoming master  : 0
Advts with wrong interval : 0
Prio Zero pkts           : Rx: 0, Tx: 0
Invalid Pkts Rvcd        : 0
Bad Virtual-IP Pkts      : 0
Invalid Authenticon type : 0
Invalid TTL Value        : 0
Invalid Packet Length    : 0

```

Clearing VRRPv2 statistics

VRRPv2 session counters can be cleared using a CLI command.

Ensure that VRRPv2 or VRRP-Ev2 is configured and enabled in your network.

To determine the effect of clearing the VRRP statistics, an appropriate **show** command is entered before and after the **clear** command.

1. Enter the **end** or **exit** command to return to privileged EXEC mode.

2. Enter the **show vrrp** command with a virtual-group ID.

```
device# show vrrp 1

Total number of VRRP session(s)   : 2

VRID 1
  Interface: Ve 10;  Ifindex: 1207959562
  Mode: VRRP
  Admin Status: Enabled
  Description :
  Address family: IPv4
  Version: 2
.
.
.
Statistics:
  Advertisements: Rx: 0, Tx: 60
  Neighbor Advertisements: Tx: 30
```

3. Enter the **clear vrrp statistics** command.

```
device# clear vrrp statistics
```

4. Enter the **show vrrp** command with a virtual-group ID.

```
device# show vrrp 1

Total number of VRRP session(s)   : 2

VRID 1
  Interface: Ve 10;  Ifindex: 1207959562
  Mode: VRRP
  Admin Status: Enabled
  Description :
  Address family: IPv4
  Version: 2
.
.
.
Statistics:
  Advertisements: Rx: 0, Tx: 6
  Neighbor Advertisements: Tx: 3
```

In this show output after the **clear vrrp statistics** command has been entered, you can see that the statistical counters have been reset. Although some of the counters are showing numbers because VRRP traffic is still flowing, the numbers are much lower (6 transmissions instead of 60 transmissions) than in the initial **show vrrp** command output.

VRRPv3

• VRRPv3 overview.....	277
• Enabling IPv6 VRRPv3.....	278
• Enabling IPv4 VRRPv3.....	279
• Tracked ports and track priority with VRRP and VRRP-E.....	280
• VRRP hold timer.....	281
• Alternate VRRPv2 checksum for VRRPv3 IPv4 sessions.....	283
• VRRPv3 router advertisement suppression.....	284
• Displaying VRRPv3 statistics.....	284
• Clearing VRRPv3 statistics.....	286
• VRRP-Ev3 Overview.....	287
• Enabling IPv6 VRRP-Ev3.....	287
• Configuring MD5 authentication on IPv6 VRRP-Ev3 interfaces.....	288
• VRRP-E load-balancing using short-path forwarding.....	289
• Displaying and clearing VRRP-Ev3 statistics.....	291

VRRPv3 overview

VRRP version 3 (VRRPv3) introduces IPv6 address support for both standard VRRP and VRRP enhanced (VRRP-E).

Virtual Router Redundancy Protocol (VRRP) is designed to eliminate the single point of failure inherent in a static default routed environment by providing redundancy to Layer 3 devices within a local area network (LAN). VRRP uses an election protocol to dynamically assign the default gateway for a host to one of a group of VRRP routers on a LAN. Alternate gateway router paths can be allocated without changing the IP address or MAC address by which the host device knows its gateway.

VRRPv3 implements support for IPv6 addresses for networks using IPv6, and it also supports IPv4 addresses for dual-stack networks configured with VRRP or VRRP-E. VRRPv3 is compliant with RFC 5798. The benefit of implementing VRRPv3 is faster switchover to backup devices than can be achieved using standard IPv6 neighbor discovery mechanisms. With VRRPv3, a backup router can become a master router in a few seconds with less overhead traffic and no interaction with the hosts.

When VRRPv3 is configured, the master device that owns the virtual IP address and a master device that does not own the virtual IP address can both respond to ICMP echo requests (using the **ping** command) and accept Telnet and other management traffic sent to the virtual IP address. In VRRPv2, only a master device on which the virtual IP address is the address of an interface on the master device can respond to ping and other management traffic.

The following are other IPv6 VRRPv3 functionality details:

- VRRPv2 functionality is supported by VRRPv3 except for VRRP authentication.
- Two VRRP and VRRP-E sessions cannot share the same group ID on the same interface.

NOTE

When implementing IPv6 VRRPv3 across a network with devices from other vendors, be aware of a potential interoperability issue with IPv6 VRRPv3 and other vendor equipment. Brocade has implemented IPv6 VRRPv3 functionality to comply with RFC 5798 and will interoperate comfortably with other vendors that support RFC 5798.

Enabling IPv6 VRRPv3

IPv6 VRRPv3 is enabled on a device when a virtual IPv6 address is assigned to a VRRPv3 group.

Before assigning a virtual IPv6 address to a VRRPv3 group, you must configure IPv6 VRRP version 3 on a virtual Ethernet interface and assign a VRRPv3 group to the device. The VRRPv3 session is enabled using a virtual IPv6 address. The device must be a router or another device that supports Layer 3 routing.

Perform this task on all devices that are to run VRRPv3. The device to which the virtual IP address belongs determines the initial master device status with all the other devices acting as backups.

1. Enter the **configure** command to access global configuration mode.

```
device# configure
```

2. To globally enable VRRPv3, enter the **ipv6 protocol vrrp** command.

```
device(config)# ipv6 protocol vrrp
```

3. Enter the **interface ve** command with an associated VLAN number.

```
device(config)# interface ve 2018
```

In this example, virtual Ethernet (ve) interface configuration mode is entered and the interface is assigned with a VLAN number of 2018.

4. Enter an IPv6 address for the interface using the **ipv6 address** command.

```
device(config-ve-2018)# ipv6 address 2001:2018:8192::125/64
```

5. Enter the **ipv6 vrrp-group** command with a number to assign a VRRPv3 group to the device.

```
device(config-ve-2018)# ipv6 vrrp-group 18
```

In this example, VRRP group configuration mode is entered.

6. Enter the **virtual-ip** command to assign a link-local virtual IPv6 address to a VRRPv3 group.

```
device(config-vrrp-group-18)# virtual-ip fe80::2018:1
```

In this example, the link-local IPv6 address of the virtual router is assigned to VRRPv3 group 18. The first virtual IP address entered enables the VRRPv3 session.

NOTE

A link-local IPv6 address is valid only for a single network link. If the virtual IP address can be reached from outside the local network, a global IPv6 address must be configured as a virtual IP address. At least one link-local address is also required.

7. Enter the **virtual-ip** command to assign a virtual IPv6 address to a VRRPv3 group.

```
device(config-vrrp-group-18)# virtual-ip 2001:2018:8192::1
```

In this example, the IPv6 address of the virtual router is assigned to VRRPv3 group 18.

The following example shows how to enable a VRRPv3 session by assigning virtual IP addresses to a VRRPv3 virtual group.

```
device# configure
device(config)# ipv6 protocol vrrp
device(config)# interface ve 2018
device(config-ve-2018)# ipv6 address 2001:2018:8192::122/64
device(config-ve-2018)# ipv6 vrrp-group 18
device(config-vrrp-group-18)# virtual-ip fe80::2018:1
device(config-vrrp-group-18)# virtual-ip 2001:2018:8192::1
```

Enabling IPv4 VRRPv3

IPv4 VRRPv3 is enabled on a device when a virtual IP address is assigned to a VRRPv3 group.

VRRPv3 supports IPv4 sessions as well as IPv6 sessions. To configure a VRRPv3 session for IPv4 assign a virtual router group with the **v3** option to the device. The device must be a router or another device that supports Layer 3 routing.

Perform this task on all devices that are to run IPv4 VRRPv3. The device to which the virtual IP address belongs determines the initial master device status with all the other devices acting as backups.

1. Enter the **configure terminal** command to access global configuration mode.

```
device# configure terminal
```

2. To globally enable VRRP, enter the **protocol vrrp** command.

```
device(config)# protocol vrrp
```

3. Configure the Ethernet interface.

```
device(config)# interface ethernet 0/6
```

In this example, Ethernet interface configuration mode is entered and the interface is assigned with a slot/port number of 0/6.

4. Enter an IPv4 address for the interface using the **ip address** command.

```
device(conf-if-eth-0/6)# ip address 192.168.5.2/24
```

5. Enter the **vrrp-group** command with a number to assign a virtual router group to the device and a version to configure VRRPv3.

```
device(conf-if-eth-0/6)# vrrp-group 10 version 3
```

In this example, a VRRPv3 group is assigned and VRRP group configuration mode is entered.

6. Enter the **advertisement-interval** command with a number in milliseconds to configure the interval at which the master VRRP router advertises its existence to the backup routers.

```
device(config-vrrp-group-10)# advertisement-interval 2000
```

In this example, the interval is expressed as 2000 milliseconds because VRRPv3 uses milliseconds instead of seconds for the advertisement interval.

7. Enter the **virtual-ip** command to assign a virtual IP address to a VRRPv3 group.

```
device(config-vrrp-group-10)# virtual-ip 192.168.5.2
```

In this example, the IPv4 address of the virtual router is assigned to VRRPv3 group 10. This virtual IP address belongs to this device and this device will assume the role of the master device.

The following example shows how to enable an IPv4 VRRPv3 session by assigning virtual IP addresses to a VRRPv3 virtual group.

```
device# configure
device(config)# protocol vrrp
device(config)# interface ethernet 0/6
device(conf-if-eth-0/6)# ip address 192.168.5.2/24
device(conf-if-eth-0/6)# vrrp-group 10 version 3
device(config-vrrp-group-10)# advertisement-interval 2000
device(config-vrrp-group-10)# virtual-ip 192.168.5.2
```

Tracked ports and track priority with VRRP and VRRP-E

Port tracking allows interfaces not configured for VRRP or VRRP-E to be monitored for link-state changes that can result in dynamic changes to the VRRP device priority.

A tracked port allows you to monitor the state of the interfaces on the other end of a route path. A tracked interface also allows the virtual router to lower its priority if the exit path interface goes down, allowing another virtual router in the same VRRP (or VRRP-E) group to take over. When a tracked interface returns to an up state, the configured track priority is added to the current virtual router priority value.

The following conditions and limitations exist for tracked ports:

- Track priorities must be lower than VRRP or VRRP-E priorities.
- The dynamic change of router priority can trigger a master device switchover if preemption is enabled. However, if the router is an owner, the master device switchover will not occur.
- The maximum number of interfaces that can be tracked for a virtual router is 16.
- Port tracking is allowed for physical interfaces and port channels.

Port tracking using IPv6 VRRPv3

The tracking of the link status of an interface not configured for VRRP or VRRP-E can be configured with a priority that can result in dynamic changes to the VRRP device priority.

After enabling IPv6 VRRPv3 you can configure tracking the port status of other interfaces on the device that are not configured for VRRP. Any link down or up events from tracked interfaces can result in dynamic changes in the virtual router priority and a potential master device switchover. The configured priority must be less than the VRRPv3 or VRRP-Ev3 priorities.

1. Enter the **configure** command to access global configuration mode.

```
device# configure
```

2. To globally enable VRRPv3, enter the **ipv6 protocol vrrp** command.

```
device(config)# ipv6 protocol vrrp
```

3. Enter the **interface ve** command with an associated VLAN number.

```
device(config)# interface ve 2018
```

In this example, virtual Ethernet (ve) interface configuration mode is entered and the interface is assigned with a VLAN number of 2018.

4. Enter an IPv6 address for the interface using the **ipv6 address** command.

```
device(config-ve-2018)# ipv6 address 2001:2018:8192::125/64
```

5. Enter the **ipv6 vrrp-group** command with a number to assign a VRRPv3 group to the device.

```
device(config-ve-2018)# ipv6 vrrp-group 18
```

In this example, VRRP group configuration mode is entered.

6. Enter the **virtual-ip** command to assign a link-local virtual IPv6 address to a VRRPv3 group.

```
device(config-vrrp-group-18)# virtual-ip fe80::2018:1
```

In this example, the link-local IPv6 address of the virtual router is assigned to VRRPv3 group 18. The first virtual IP address entered enables the VRRPv3 session.

NOTE

A link-local IPv6 address is valid only for a single network link, another IPv6 address must be configured as a virtual IP address for routing purposes.

7. Enter the **track** command with an interface and a priority to enable the tracking of ports that are not configured as VRRP interfaces.

```
device(config-vrrp-group-18)# track ethernet 0/5 priority 15
```

8. Enter the **no preempt-mode** command to disable preemption.

```
device(config-vrrp-group-18)# no preempt-mode
```

Preemption can be disabled when you do not want to preempt an existing master with a higher priority device.

9. Enter the **priority** command to configure the priority of the virtual router. In VRRPv3, the virtual router with the highest priority becomes the master VRRPv3 device.

```
device(config-vrrp-group-18)# priority 120
```

The following example shows how to configure an IPv6 VRRPv3 session and enable the tracking of a 10 GbE interface.

```
device# configure
device(config)# ipv6 protocol vrrp
device(config)# interface ve 2018
device(config-ve-2018)# ipv6 address 2001:2018:8192::122/64
device(config-ve-2018)# ipv6 vrrp-group 18
device(config-vrrp-group-18)# virtual-ip fe80::2018:1
device(config-vrrp-group-18)# track ethernet 0/5 priority 15
device(config-vrrp-group-18)# no preempt-mode
device(config-vrrp-group-18)# priority 120
```

VRRP hold timer

The hold timer delays the preemption of a master VRRP device by a high-priority backup device.

A hold timer is used when a VRRP-enabled device that was previously a master device failed, but is now back up. This restored device now has a higher priority than the current VRRP master device, and VRRP normally triggers an immediate switchover. In this situation, it is possible that not all software components on the backup device have converged yet. The hold timer can enforce a waiting period before the higher-priority backup device assumes the role of master VRRP device again. The timer must be set to a number greater than 0 seconds for this functionality to take effect.

Hold timer functionality is supported in both version 2 and version 3 of VRRP and VRRP-E.

Configuring VRRP hold timer support

A hold timer can be configured on a VRRP-enabled interface to set an interval, in seconds, before a backup device becomes the master VRRP device.

A hold timer is used when a VRRP-enabled device that was previously a master device failed, but is now back online. The backup device has a higher priority than the current VRRP master device. Before assuming the role of master VRRP device again, the backup device

waits for the time period specified in the hold timer. This task is supported in both versions of VRRP and VRRP-E, but the configuration below is for VRRPv3.

1. Enter the **configure terminal** command to access global configuration mode.

```
device# configure terminal
```

2. Enable IPv6 VRRP-E.

```
device(config)# ipv6 protocol vrrp-extended
```

In this example, virtual Ethernet (ve) interface configuration mode is entered and the interface is assigned with a VLAN number of 2018.

3. Enter the **interface ve** command with an associated vlan number.

```
device(config)# interface ve 2018
```

In this example, virtual Ethernet (ve) interface configuration mode is entered and the interface is assigned with a VLAN number of 2018.

4. Enter an IPv6 address for the interface using the **ipv6 address** command.

```
device(config-ve-2018)# ipv6 address 2001:2018:8192::122/64
```

5. Enter the **ipv6 vrrp-group** command with a number to assign a VRRPv3 group to the device.

```
device(config-ve-2018)# ipv6 vrrp-group 18
```

In this example, VRRP group configuration mode is entered.

6. Enter the **description** command to enter text that describes the virtual router group.

```
device(config-vrrp-group-18)# description Product Marketing group
```

7. Enter the **advertisement-interval** command with a number representing milliseconds.

```
device(config-vrrp-group-18)# advertisement-interval 3000
```

NOTE

In VRRPv3, the advertisement-interval is in milliseconds.

8. Enter the **hold-time** command with a number representing seconds.

```
device(config-vrrp-group-18)# hold-time 5
```

The following example configures and enables a VRRPv3 session and adds a VRRP group description. A hold time of 5 seconds is configured. This example also contains appropriate **virtual-ip** command configuration not included in the task above.

```
device# configure
device(config)# ipv6 protocol vrrp-extended
device(config)# interface ve 2018
device(config-ve-2018)# ipv6 address 2001:2018:8192::122/64
device(config-ve-2018)# ipv6 vrrp-group 18
device(config-vrrp-group-18)# virtual-ip fe80::2018:1
device(config-vrrp-group-18)# description Product Marketing group
device(config-vrrp-group-18)# advertisement-interval 3000
device(config-vrrp-group-18)# hold-time 5
```

Alternate VRRPv2 checksum for VRRPv3 IPv4 sessions

If VRRPv3 is configured on a Brocade device in a network with third-party peering devices using VRRPv2-style checksum calculations for IPv4 VRRPv3 sessions, a VRRPv2-style checksum must be configured for VRRPv3 IPv4 sessions on the Brocade device.

VRRPv3 introduced a new checksum method for both IPv4 and IPv6 sessions, and this version 3 checksum computation is enabled by default. To accommodate third-party devices that still use a VRRPv2-style checksum for IPv4 VRRPv3 sessions, a command-line interface (CLI) command is available for configuration on a Brocade device. The new version 2 checksum method is disabled by default and is applicable only to IPv4 VRRPv3 sessions. If configured for VRRPv2 sessions, the VRRPv2-style checksum command is accepted, but it has no effect.

Enabling the v2 checksum computation method in a VRRPv3 IPv4 session

Enabling the alternate VRRPv2-style checksum in a VRRPv3 IPv4 session for compatibility with third-party network devices.

VRRPv3 uses the v3 checksum computation method by default for both IPv4 and IPv6 sessions on Brocade devices. Third-party devices may only have a VRRPv2-style checksum computation available for a VRRPv3 IPv4 session. The **use-v2-checksum** command is entered in interface configuration mode.

1. Enter the **configure terminal** command to enter global configuration mode.

```
device# configure terminal
```

2. To enable VRRP globally enter the **protocol vrrp** command.

```
device(config)# protocol vrrp
```

3. Enter the **interface ve** command with an associated VLAN number.

```
device(config)# interface ve 2018
```

4. To assign an IPv4 VRRPv3 group to the device use the **vrrp-group** command with a group number and version 3.

```
device(config-ve-2018)# vrrp-group 10 version 3
```

5. To enable v2 checksum computation method in an IPv4 VRRPv3 session, use the **use-v2-checksum** command in the VRRP group configuration mode.

```
device(config-vrrp-group-10)# use-v2-checksum
```

The following example shows the v2 checksum computation method enabled for an VRRPv3 IPv4 session on a Brocade device.

```
device# configure terminal
device(config)# protocol vrrp
device(config)# interface ve 2018
device(config-ve-2018)# vrrp-group 10 version 3
device(config-vrrp-group-10)# use-v2-checksum
```

VRRPv3 router advertisement suppression

VRRPv3 introduces the ability to suppress router advertisements (RAs).

Router advertisements are sent by the VRRP master device and contain the link-local virtual IP address and the virtual MAC address. For network security reasons, if you do not want the MAC addresses of interfaces to be viewed, you can disable RA messages. Disabling RA does not remove the auto-configured addresses being sent by VRRP updates, but the RA messages are dropped by the router interface. There are two other situations where you may want to disable RA messages:

- If an interface is currently the VRRP master but the virtual IP address is not the address of this interface, the device should not send RA messages for the interface IP address.
- If the interface is in a backup state, the device should not send RA messages for the interface IP address.

Disabling VRRPv3 router advertisements

The ability to suppress VRRPv3 master device interface router advertisements is introduced.

Suppressing interface router advertisements from the master VRRPv3 device may be performed for network security concerns because the RA messages include the MAC addresses of interfaces. In this task, VRRP-Ev3 is configured globally and RA messages are suppressed for the virtual ethernet (VE) 2109 interface.

NOTE

To configure this task for VRRPv3, use the **ipv6 protocol vrrp** command.

1. Enter the **configure terminal** command to access global configuration mode.

```
device# configure terminal
```

2. Globally enable VRRP-Ev3.

```
device(config)# ipv6 protocol vrrp-extended
```

3. Enter the **interface ve** command with an associated VLAN number.

```
device(config)# interface ve 2019
```

In this example, virtual Ethernet (ve) configuration mode is entered and the interface is assigned with a VLAN number of 2019.

4. Enter the **ipv6 vrrp-suppress-interface-ra** command to suppress interface RA messages for the ve 2019 interface.

```
device(config-ve-2019)# ipv6 vrrp-suppress-interface-ra
```

The following example shows how to disable VRRPv3 RA messages from interface configuration mode for a VRRP-Ev3 session.

```
device# configure
device(config)# ipv6 protocol vrrp-extended
device(config)# interface ve 2019
device(config-ve-2019)# ipv6 vrrp-suppress-interface-ra
```

Displaying VRRPv3 statistics

Various show commands can display statistical information about IPv6 VRRP configurations.

Before displaying statistics, VRRPv3 must be configured and enabled in your network to generate traffic.

Use one or more of the following commands to display VRRPv3 information. The commands do not have to be entered in this order.

1. Use the **exit** command to return to privileged EXEC mode, if required.
2. Enter the **show ipv6 vrrp summary** command.

```
device# show ipv6 vrrp summary

Total number of VRRP session(s)   : 2
Master session count   : 1
Backup session count   : 1
Init session count     : 0

VRID  Session  Interface  Admin   Current  State   Short-path  Revert   SPF
      =====  =====  =====  =====  =====  =====  =====  =====  =====
18    VRRPE     Ve 2018   Enabled  254      Master   Enabled     unset    No
19    VRRPE     Ve 2019   Enabled  100      Backup   Enabled     unset    No
```

This example shows summary output for the two IPv6 VRRP-E sessions that are configured for virtual routers 18 and 19.

- To display detailed information for a single VRRP virtual router ID(VRID), enter the **show ipv6 vrrp** command with the **detail** keyword and a specific VRID.

```

device# show ipv6 vrrp 19 detail

Total number of VRRP session(s)    : 1

VRID 19
Interface: Ve 2019;  Ifindex: 1207961571
Mode: VRRPE
Admin Status: Enabled
Description :
Address family: IPv6
Version: 3
Authentication type: No Authentication
State: Backup
Session Master IP Address: fe80::205:33ff:fe79:fb1e
Virtual IP(s): 2001:2019:8192::1
Virtual MAC Address: 02e0.5200.2513
Configured Priority: unset (default: 100); Current Priority: 100
Advertisement interval: 1 sec (default: 1 sec)
Preempt mode: DISABLE (default: DISABLED)
Advertise-backup: ENABLE (default: DISABLED)
Backup Advertisement interval: 60 sec (default: 60 sec)
Short-path-forwarding: Enabled
Revert-Priority: unset; SPF Reverted: No
Hold time: 0 sec (default: 0 sec)
Master Down interval: 4 sec
Trackport:
  Port(s)                Priority  Port Status
  =====                =
Global Statistics:
=====
Checksum Error : 0
Version Error  : 0
VRID Invalid   : 0

Session Statistics:
=====
Advertisements           : Rx: 103259, Tx: 1721
Neighbor Advertisements   : Tx: 0
Session becoming master   : 0
Advts with wrong interval : 0
Prio Zero pkts           : Rx: 0, Tx: 0
Invalid Pkts Rcvd        : 0
Bad Virtual-IP Pkts      : 0
Invalid Authenticon type : 0
Invalid TTL Value        : 0
Invalid Packet Length    : 0
VRRPE backup advt sent   : 1721
VRRPE backup advt recvd  : 0

```

This example shows detailed output for the IPv6 VRRP-E session for virtual router 19.

Clearing VRRPv3 statistics

VRRPv3 session counters can be cleared using a CLI command.

Ensure that VRRPv3 is configured and enabled in your network.

- Enter the **end** command, if required, to return to privileged EXEC mode.
- Enter the **clear ipv6 vrrp statistics** command.

```
device# clear ipv6 vrrp statistics
```

VRRP-Ev3 Overview

VRRP Extended version 3 (VRRP-Ev3) introduces IPv6 address support to the Brocade proprietary VRRP Extended version 2 (VRRP-Ev2) protocol. VRRP-Ev3 is designed to avoid the limitations in the standards-based VRRPv3 protocol.

To create VRRP-Ev3, Brocade has implemented the following differences from the RFC 5798 that describes VRRPv3 to provide extended functionality and ease of configuration:

- VRRP-Ev3 does not include the concept of an owner device and a master VRRP-Ev3 device is determined by the priority configured on the device.
- While the VRRP-Ev3 virtual router IP address must belong in the same subnet as a real IP address assigned to a physical interface of the device on which VRRP-Ev3 is configured, it must not be the same as any of the actual IP addresses on any interface.
- Configuring VRRP-Ev3 uses the same task steps for all devices; no differences between master and backup device configuration. The device configured with the highest priority assumes the master role.

VRRP-Ev3 is not supported on non-Brocade devices and does not interoperate with VRRPv2 or VRRPv3 sessions on Brocade devices.

Enabling IPv6 VRRP-Ev3

IPv6 VRRP-Ev3 is enabled on a device when a virtual IPv6 address is assigned to a VRRP-Ev3 group.

Before assigning a virtual IPv6 address to an IPv6 VRRPv3 group, you must configure IPv6 VRRP-Ev3 on a virtual ethernet interface and assign a VRRPv3 group to the device. The IPv6 VRRP-Ev3 session is enabled after the configuration of an IPv6 virtual IP address. The configuration example following after the individual steps represents all the steps together in order.

1. Enter the **configure** command to access the global configuration mode.

```
device# configure
```

2. To globally enable VRRP-Ev3, enter the **ipv6 protocol vrrp-extended** command.

```
device(config)# ipv6 protocol vrrp-extended
```

3. Enter the **interface ve** command with an associated virtual Ethernet (VE) interface number.

```
device(config)# interface ve 2019
```

In this example, virtual Ethernet (ve) configuration mode is entered and the interface is assigned with a VE number of 2019.

4. Enter an IPv6 address for the interface using the **ipv6 address** command.

```
device(config-if-ve-2019)# ipv6 address 2001:2019:8192::122/64
```

5. Enter the **ipv6 vrrp-extended-group** command with a number to assign a VRRP-E group to the device.

```
device(config-if-ve-2018)# ipv6 vrrp-extended-group 19
```

In this example, VRRP-Ev3 group configuration mode is entered.

6. Enter the **virtual-ip** command to assign a link-local virtual IPv6 address to a VRRPv3 group.

```
device(config-vrrp-extended-group-19)# virtual-ip fe80::2019:1
```

In this example, the IPv6 address of the virtual router is assigned to VRRP-Ev3 group 19 and the VRRP-Ev3 session is enabled.

NOTE

A maximum of two virtual IPv6 addresses can be configured on VRRP-Ev3 group. For VRRPv3, Brocade recommends using two IPv6 addresses; one link local address and one global address.

7. Enter the **virtual-ip** command to assign a virtual IPv6 address to a VRRPv3 group.

```
device(config-vrrp-extended-group-19)# virtual-ip 2001:2019:8192::1
```

In this example, a global IPv6 address is configured for the virtual router.

The following example shows how to enable a VRRP-E-v3 session by assigning a virtual IP address to an extended VRRP-E-v3 virtual group.

```
device# configure
device(config)# ipv6 protocol vrrp-extended
device(config)# interface ve 2019
device(config-if-ve-2019)# ipv6 address 2001:2019:8192::122/64
device(config-if-ve-2019)# ipv6 vrrp-extended-group 19
device(config-vrrp-extended-group-19)# virtual-ip fe80::2019:1
device(config-vrrp-extended-group-19)# virtual-ip 2001:2019:8192::1
```

After enabling a VRRP-Ev3 session, you may need to configure some optional parameters such as short-path forwarding for load-balancing or tracking an interface.

Configuring MD5 authentication on IPv6 VRRP-Ev3 interfaces

Interfaces can be configured with an MD5 encrypted password for authentication, and VRRP-Ev3 can use the same authentication type associated with the interfaces on which you define the virtual router.

VRRP Extended version 3 (VRRP-Ev3) must be configured on the device and the interface associated with a virtual router group.

Any VRRP-Ev3 packets that do not contain the password are dropped. If your interfaces do not use authentication, neither does VRRP-Ev3. Repeat this task on all interfaces on all devices that support the same virtual router group.

NOTE

VRRP-Ev3 is not supported on non-Brocade devices.

1. From privileged EXEC mode, enter global configuration mode.

```
device# configure terminal
```

2. Globally enable IPv6 VRRP-Ev3.

```
device(config)# ipv6 protocol vrrp-extended
```

3. Configure the Virtual Ethernet (VE) interface link for the VRRP-E device.

```
device(config)# interface ve 20
```

Only ve interfaces are supported by VRRP-E.

4. Enter the MD5 password configuration using the **ipv6 vrrp-extended auth-type** command with a text password. The password will be encrypted when saved in the configuration file.

```
device(config-if-Ve-20)# ipv6 vrrp-extended auth-type md5-auth kfhb61qp
```

When an MD5 authentication password is configured on an interface, a syslog message is displayed.

5. Exit to privileged EXEC mode.

```
device(config-if-Ve-20)# end
```

6. Display the VRRP-Ev3 configuration. In this example, only partial output is displayed to verify that MD5 authentication is configured.

```
device# show ipv6 vrrp

Total number of VRRP session(s)   : 1

VRID 1
  Interface: Ve 10;  Iindex: 1207959562
  Mode: VRRPE
  Admin Status: Enabled
  Description :
  Address family: IPv6
  Version: 2
  Authentication type: MD5 Authentication
  .
  .
  .
```

The following example configures MD5 authentication for the specified VRRP-E interface.

```
device# configure terminal
device(config)# ipv6 protocol vrrp-extended
device(config)# interface ve 20
device(config-if-Ve-20)# ipv6 vrrp-extended auth-type md5-auth kfhb61qp
device(config-if-Ve-20)# end
device# show ipv6 vrrp
```

VRRP-E load-balancing using short-path forwarding

The VRRP-E Extension for Server Virtualization feature allows Brocade devices to bypass the VRRP-E master router and directly forward packets to their destination through interfaces on the VRRP-E backup router. This is called *short-path forwarding*. A backup router participates in a VRRP-E session only when short-path forwarding is enabled.

Packet routing with short-path forwarding to balance traffic load

When short-path forwarding is enabled, traffic load-balancing is performed because both master and backup devices can be used to forward packets.

FIGURE 32 Short-path forwarding

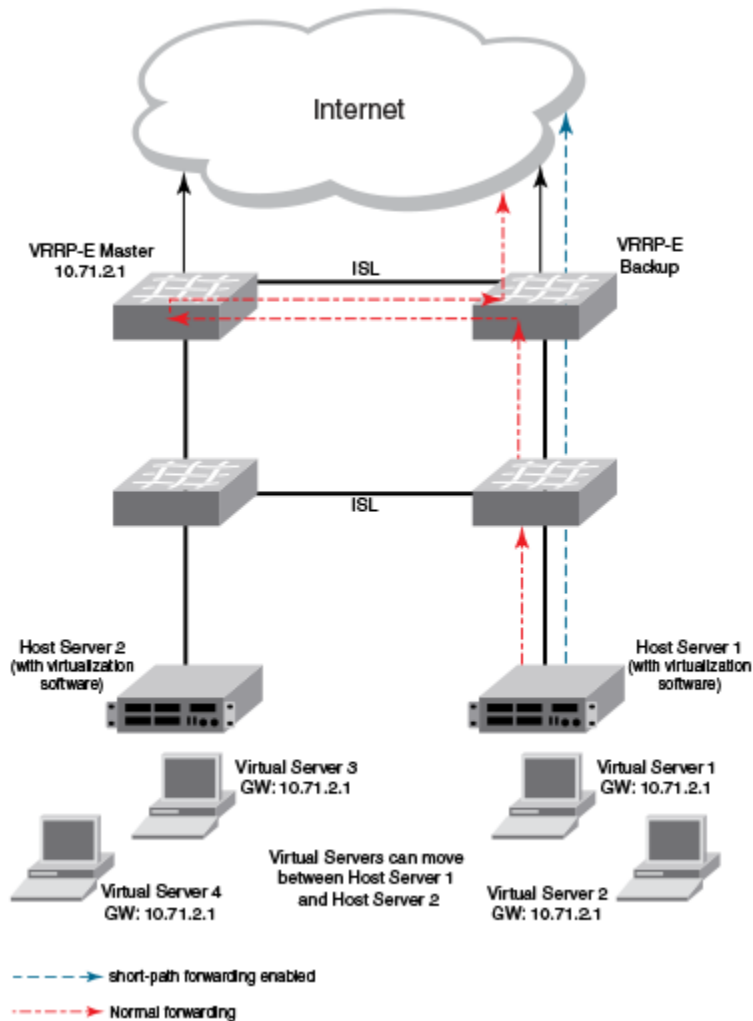

If you enable short-path forwarding in both master and backup VRRP-E devices, packets sent by Host Server 1 (in the figure) and destined for the Internet cloud through the device on which a VRRP-E backup interface exists can be routed directly to the VRRP-E backup device (blue dotted line) instead of being switched to the master router and then back (red dotted-dash line).

In the figure, load-balancing is achieved using short-path forwarding by dynamically moving the virtual servers between Host Server 1 and Host Server 2.

Short-path forwarding with revert priority

Revert priority is used to dynamically enable or disable VRRP-E short-path forwarding.

If short-path forwarding is configured with revert priority on a backup router, the revert priority represents a threshold for the current priority of the VRRP-E session. When the backup device priority is higher than the configured revert priority, the backup router is able to perform short-path forwarding. If the backup priority is lower than the revert priority, short-path forwarding is disabled.

Configuring VRRP-Ev3 load-balancing

VRRP-Ev3 traffic can be load-balanced using short-path forwarding on the backup devices.

Before configuring VRRP-Ev3 load-balancing, VRRP-Ev3 must be configured on all devices in the VRRP-Ev3 session.

Perform this task on all backup VRRP-Ev3 Layer 3 devices to allow load sharing within an IPv6 VRRP extended group.

1. Use the **configure terminal** command to enter global configuration mode.

```
device# configure terminal
```

2. Globally enable VRRP-Ev3.

```
device(config)# ipv6 protocol vrrp-extended
```

3. Enter the **interface ve** command with an associated VLAN number.

```
device(config)# interface ve 2019
```

In this example, virtual Ethernet (ve) configuration mode is entered and the interface is assigned with a VLAN number of 2019.

4. Enter an IPv6 address for the interface using the **ipv6 address** command.

```
device(config-ve-2019)# ipv6 address 2001:2019:8192::122/64
```

5. Enter the **ipv6 vrrp-extended-group** command with a number to assign a VRRP-E group to the device.

```
device(config-ve-2018)# ipv6 vrrp-extended-group 19
```

In this example, VRRP-Ev3 group configuration mode is entered.

6. Enter the **short-path-forwarding** command with a **revert-priority** value to configure the backup VRRP-E as an alternate path with a specified priority.

```
device(config-vrrp-extended-group-19)# short-path-forwarding revert-priority 50
```

When the backup device priority is higher than the configured **revert-priority** value, the backup router is able to perform short-path forwarding. If the backup priority is lower than the revert priority, short-path forwarding is disabled.

In the following example, short-path forwarding is configured on a backup VRRP-Ev3 device and a revert priority threshold is configured. If the backup device priority falls below this threshold, short-path forwarding is disabled.

```
device# configure
device(config)# ipv6 protocol vrrp-extended
device(config)# interface ve 2019
device(config-ve-2019)# ipv6 address 2001:2019:8192::122/64
device(config-ve-2019)# ipv6 vrrp-extended-group 19
device(config-vrrp-extended-group-19)# short-path-forwarding revert-priority 50
```

Displaying and clearing VRRP-Ev3 statistics

Several show commands can display statistical information about IPv6 VRRP-Ev3 configurations. To reset the IPv6 VRRP-Ev3 statistics, there is a CLI command.

Before displaying statistics, VRRP-Ev3 must be configured and enabled in your network to generate traffic.

Use one or more of the following commands to display VRRP-Ev3 information. The commands do not have to be entered in this order.

1. Use the **exit** command to return to privileged EXEC mode, if required.

2. Enter the **show ipv6 vrrp summary** command.

```
device# show ipv6 vrrp summary

Total number of VRRP session(s)   : 2
Master session count   : 1
Backup session count   : 1
Init session count     : 0

VRID  Session  Interface  Admin    Current  State  Short-path  Revert  SPF
=====  =====  =====  =====  =====  =====  =====  =====  =====
18   VRRPE     Ve 2018   Enabled  254     Master  Enabled     unset   No
19   VRRPE     Ve 2019   Enabled  100     Backup  Enabled     unset   No
```

This example shows summary output for the two IPv6 VRRP-E sessions that are configured for virtual routers 18 and 19.

3. Enter the **show ipv6 vrrp 19 detail** command.

```
device# show ipv6 vrrp 19 detail

Total number of VRRP session(s)   : 1

VRID 19
  Interface: Ve 2019; Ifindex: 1207961571
  Mode: VRRPE
  Admin Status: Enabled
  Description :
  Address family: IPv6
  Version: 3
  Authentication type: No Authentication
  State: Backup
  Session Master IP Address: fe80::205:33ff:fe79:fb1e
  Virtual IP(s): 2001:2019:8192::1
  Virtual MAC Address: 02e0.5200.2513
  Configured Priority: unset (default: 100); Current Priority: 100
  Advertisement interval: 1 sec (default: 1 sec)
  Preempt mode: DISABLE (default: DISABLED)
  Advertise-backup: ENABLE (default: DISABLED)
  Backup Advertisement interval: 60 sec (default: 60 sec)
  Short-path-forwarding: Enabled
  Revert-Priority: unset; SPF Reverted: No
  Hold time: 0 sec (default: 0 sec)
  Master Down interval: 4 sec
  Trackport:
    Port(s)                Priority  Port Status
    =====                =====  =====

Global Statistics:
=====
Checksum Error : 0
Version Error  : 0
VRID Invalid   : 0

Session Statistics:
=====
Advertisements           : Rx: 103259, Tx: 1721
Neighbor Advertisements   : Tx: 0
Session becoming master   : 0
Advts with wrong interval : 0
Prio Zero pkts           : Rx: 0, Tx: 0
Invalid Pkts Rvcd        : 0
Bad Virtual-IP Pkts      : 0
Invalid Authentication type : 0
Invalid TTL Value        : 0
Invalid Packet Length    : 0
VRRPE backup advt sent   : 1721
VRRPE backup advt recvd  : 0
```

This example shows detailed output for the IPv6 VRRP-E session for virtual router 19.

4. Enter the **clear ipv6 vrrp statistics** command with the **all** option to reset the statistical counters for all IPv6 VRRP-Ev3 sessions.

```
device# clear ipv6 vrrp statistics all
```

5. Enter the **clear ipv6 vrrp statistics** command with the **session** option to reset the statistical counters for the IPv6 VRRP-Ev3 session for virtual router 19.

```
device# clear ipv6 vrrp statistics session 19
```