



ExtremeCloud™ Orchestrator v4.0.0 vCenter Integration Guide

Configuration and Management

9039319-00 Rev AA
August 2025



Copyright © 2025 Extreme Networks, Inc. All rights reserved.



Table of Contents

Legal Notices.....	5
Legal Notice.....	5
Trademarks.....	5
Open Source Declarations.....	5
Abstract.....	vi
Preface.....	vii
Text Conventions.....	vii
Documentation and Training.....	viii
Open Source Declarations.....	ix
Training.....	ix
Help and Support.....	ix
Subscribe to Product Announcements.....	x
Send Feedback.....	x
What's New in This Document.....	11
Introduction.....	12
Introduction to ExtremeCloud Orchestrator.....	12
XCO Microservices.....	14
Fabric Service.....	14
Tenant Service.....	15
Inventory Service.....	15
Asset Service.....	15
Notification Service.....	15
RASlog Service.....	15
Security Service.....	16
SNMP Service.....	16
Policy Service.....	16
System Service.....	16
Fault Service.....	16
Ecosystem Services.....	16
VMware vCenter.....	17
VMware vSphere Client.....	17
How the XCO vCenter Service Works	17
Before You Begin.....	20
Supported Versions for XCO vCenter Service.....	20
Limitations of XCO vCenter Service.....	20
VMware vCenter Configuration.....	20
XCO vCenter Integration.....	21
Integrate XCO vCenter Service	21
Manage VMware vCenter Server Tenants	21
Example Network	21

Verify Fabric Topology.....	22
Add Devices To Your Fabric	23
Create the vCenter Tenant.....	25
Register VMware vCenter Server as a Tenant	26
XCO vCenter Commands.....	28
efa vcenter.....	29
efa vcenter register	30
efa vcenter update.....	31
efa vcenter list.....	32
efa vcenter links.....	33
efa vcenter delete	35
efa vcenter debug.....	36



Legal Notices

Legal Notice

Extreme Networks, Inc. reserves the right to make changes in specifications and other information contained in this document and its website without prior notice. The reader should in all cases consult representatives of Extreme Networks to determine whether any such changes have been made.

The hardware, firmware, software or any specifications described or referred to in this document are subject to change without notice.

Trademarks

Extreme Networks and the Extreme Networks logo are trademarks or registered trademarks of Extreme Networks, Inc. in the United States and/or other countries.

All other names (including any product names) mentioned in this document are the property of their respective owners and may be trademarks or registered trademarks of their respective companies/owners.

For additional information on Extreme Networks trademarks, see: <https://www.extremenetworks.com/about-extreme-networks/company/legal/trademarks>

Open Source Declarations

Some software files have been licensed under certain open source or third-party licenses. End-user license agreements and open source declarations can be found at: <https://www.extremenetworks.com/support/policies/open-source-declaration/>

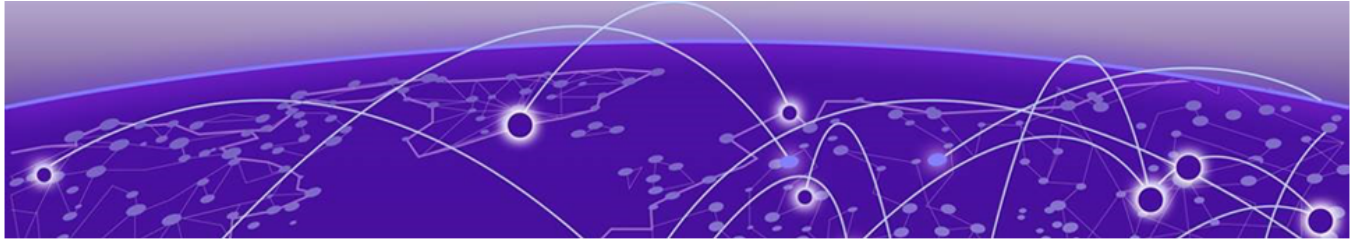

Abstract

The ExtremeCloud™ Orchestrator vCenter version 4.0.0 Integration Guide outlines procedures for integrating VMware vCenter with ExtremeCloud Orchestrator (XCO). It includes steps for configuring the XCO vCenter service, verifying fabric topology, adding devices to the fabric, creating and managing tenants, and registering vCenter servers as tenants. The guide also details commands for managing vCenter server connections and configurations within XCO. This document is intended for IT professionals managing data center networks using XCO and VMware vCenter.

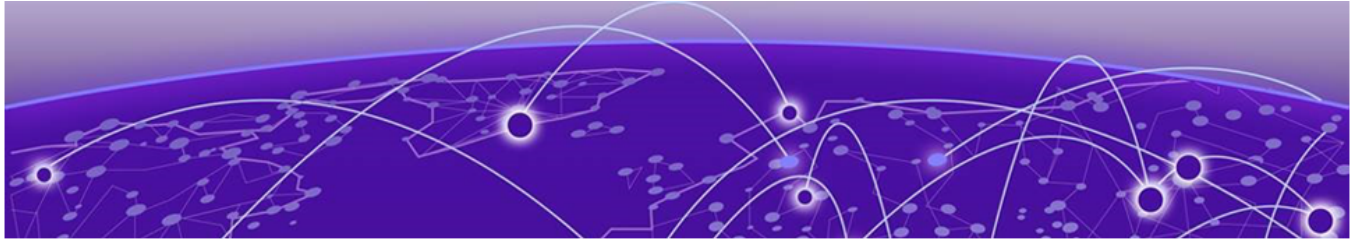

Preface

Read the following topics to learn about:

- The meanings of text formats used in this document.
- Where you can find additional information and help.
- How to reach us with questions and comments.

Text Conventions

Unless otherwise noted, information in this document applies to all supported environments for the products in question. Exceptions, like command keywords associated with a specific software version, are identified in the text.

When a feature, function, or operation pertains to a specific hardware product, the product name is used. When features, functions, and operations are the same across an entire product family, such as Extreme Networks switches or routers, the product is referred to as *the switch* or *the router*.

Table 1: Notes and warnings





Icon	Notice type	Alerts you to..
	Tip	Helpful tips and notices for using the product
	Note	Useful information or instructions
	Important	Important features or instructions
	Caution	Risk of personal injury, system damage, or loss of data
	Warning	Risk of severe personal injury

Table 2: Text

Convention	Description
screen displays	This typeface indicates command syntax, or represents information as it is displayed on the screen.
The words <i>enter</i> and <i>type</i>	When you see the word <i>enter</i> in this guide, you must type something, and then press the Return or Enter key. Do not press the Return or Enter key when an instruction simply says <i>type</i> .
Key names	Key names are written in boldface, for example Ctrl or Esc . If you must press two or more keys simultaneously, the key names are linked with a plus sign (+). Example: Press Ctrl+Alt+Del
Words in italicized type	Italics emphasize a point or denote new terms at the place where they are defined in the text. Italics are also used when referring to publication titles.
NEW!	New information. In a PDF, this is searchable text.

Table 3: Command syntax

Convention	Description
bold text	Bold text indicates command names, keywords, and command options.
<i>italic text</i>	Italic text indicates variable content.
[]	Syntax components displayed within square brackets are optional. Default responses to system prompts are enclosed in square brackets.
{ x y z }	A choice of required parameters is enclosed in curly brackets separated by vertical bars. You must select one of the options.
x y	A vertical bar separates mutually exclusive elements.
< >	Nonprinting characters, such as passwords, are enclosed in angle brackets.
...	Repeat the previous element, for example, <i>member [member...]</i> .
\	In command examples, the backslash indicates a “soft” line break. When a backslash separates two lines of a command input, enter the entire command at the prompt without the backslash.

Documentation and Training

Find Extreme Networks product information at the following locations:

[Current Product Documentation](#)

[Release Notes](#)

[Hardware and Software Compatibility](#) for Extreme Networks products

[Extreme Optics Compatibility](#)

[Other Resources](#) such as articles, white papers, and case studies

Open Source Declarations

Some software files have been licensed under certain open source licenses. Information is available on the [Open Source Declaration](#) page.

Training

Extreme Networks offers product training courses, both online and in person, as well as specialized certifications. For details, visit the [Extreme Networks Training](#) page.

Help and Support

If you require assistance, contact Extreme Networks using one of the following methods:

Extreme Portal

Search the GTAC (Global Technical Assistance Center) knowledge base; manage support cases and service contracts; download software; and obtain product licensing, training, and certifications.

The Hub

A forum for Extreme Networks customers to connect with one another, answer questions, and share ideas and feedback. This community is monitored by Extreme Networks employees, but is not intended to replace specific guidance from GTAC.

Call GTAC

For immediate support: (800) 998 2408 (toll-free in U.S. and Canada) or 1 (408) 579 2800. For the support phone number in your country, visit www.extremenetworks.com/support/contact.

Before contacting Extreme Networks for technical support, have the following information ready:

- Your Extreme Networks service contract number, or serial numbers for all involved Extreme Networks products
- A description of the failure
- A description of any actions already taken to resolve the problem
- A description of your network environment (such as layout, cable type, other relevant environmental information)
- Network load at the time of trouble (if known)
- The device history (for example, if you have returned the device before, or if this is a recurring problem)
- Any related RMA (Return Material Authorization) numbers

Subscribe to Product Announcements

You can subscribe to email notifications for product and software release announcements, Field Notices, and Vulnerability Notices.

1. Go to [The Hub](#).
2. In the list of categories, expand the **Product Announcements** list.
3. Select a product for which you would like to receive notifications.
4. Select **Subscribe**.
5. To select additional products, return to the **Product Announcements** list and repeat steps 3 and 4.

You can modify your product selections or unsubscribe at any time.

Send Feedback

The User Enablement team at Extreme Networks has made every effort to ensure that this document is accurate, complete, and easy to use. We strive to improve our documentation to help you in your work, so we want to hear from you. We welcome all feedback, but we especially want to know about:

- Content errors, or confusing or conflicting information.
- Improvements that would help you find relevant information.
- Broken links or usability issues.

To send feedback, email us at Product-Documentation@extremenetworks.com.

Provide as much detail as possible including the publication title, topic heading, and page number (if applicable), along with your comments and suggestions for improvement.

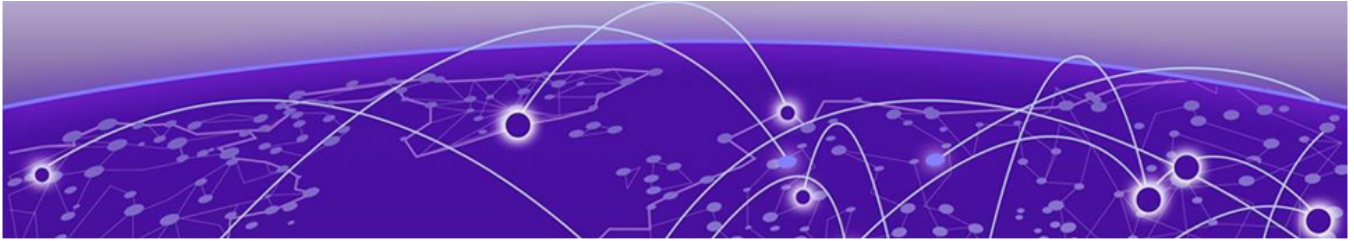

What's New in This Document

There are no content changes for this guide for the ExtremeCloud Orchestrator 4.0.0 software release.

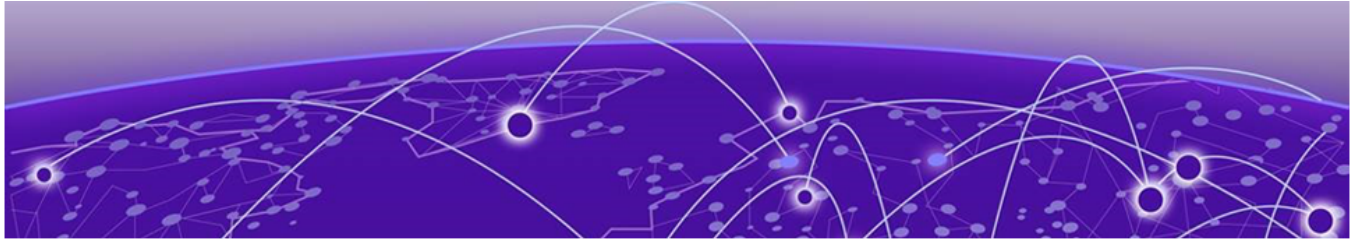

Introduction

[Introduction to ExtremeCloud Orchestrator](#) on page 12

[XCO Microservices](#) on page 14

[VMware vCenter](#) on page 17

[VMware vSphere Client](#) on page 17

[How the XCO vCenter Service Works](#) on page 17

Introduction to ExtremeCloud Orchestrator

ExtremeCloud Orchestrator (XCO) is a micro-services-based scalable fabric automation application.



Note

From release 3.2.0 onwards, Extreme Fabric Automation (EFA) is referred to as ExtremeCloud Orchestrator (XCO). The terms EFA and XCO refer to the same product and are used interchangeably.

XCO automates and orchestrates SLX IP fabrics and tenant networks, with support for the following:

- Building and managing non-Clos small data center fabrics and 3-stage and 5-stage IP Clos fabrics
- Managing tenant-aware Layer 2 and Layer 3 networks
- Configuring integration with several ecosystems: VMware vCenter and Microsoft Hyper-V
- Providing a single point of configuration for your entire fabric

XCO consists of core K3s containerized services that interact with each other and with other infrastructure services to provide the core functions of fabric and tenant network automation. For more information, see [XCO Microservices](#) on page 14.

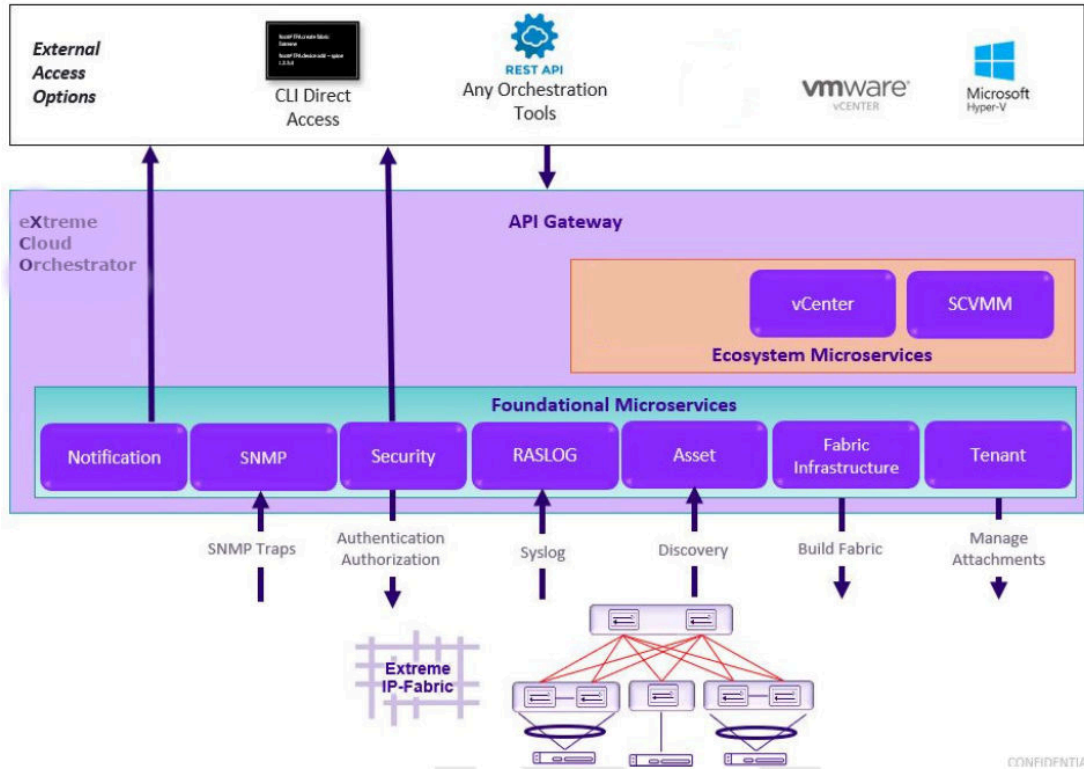

Figure 1: XCO Orchestration

XCO Microservices

XCO consists of core K3s containerized microservices that interact with each other and with other infrastructure services to provide the core functions of fabric and tenant network automation.

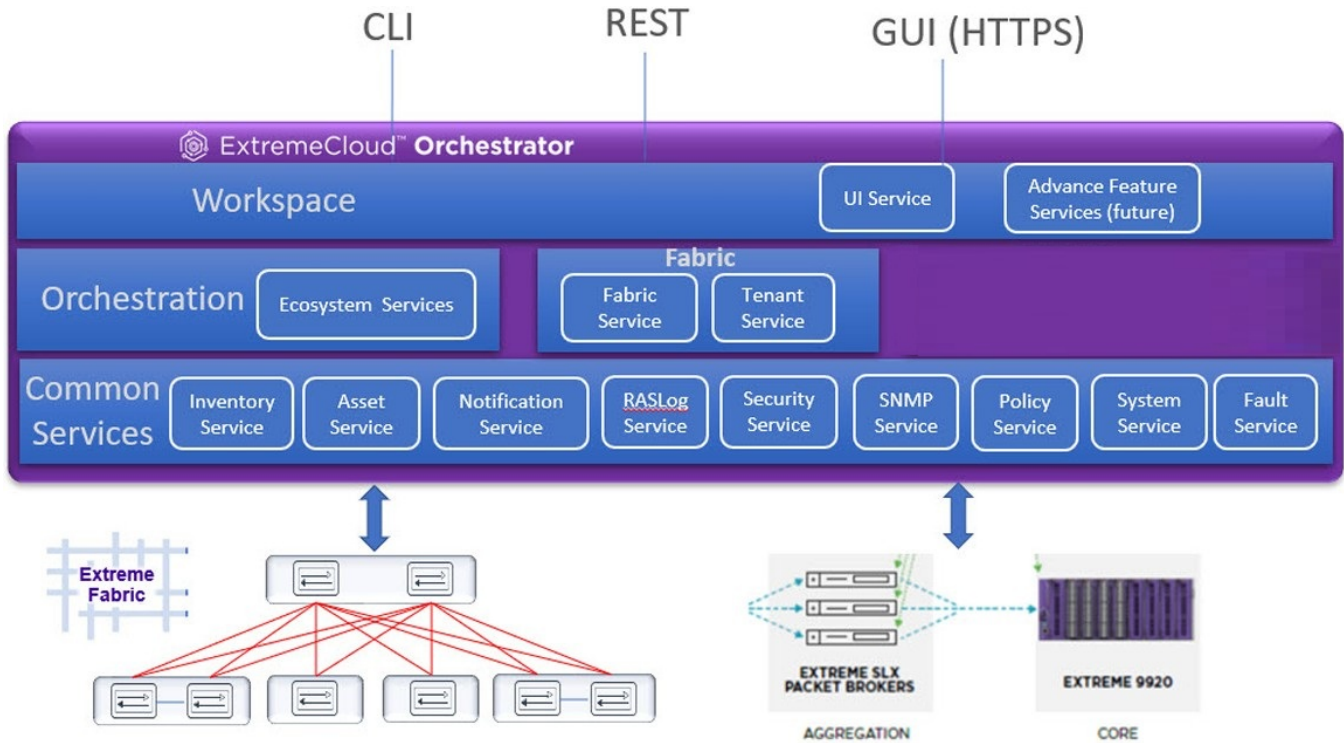

Figure 2: Microservices in the XCO architecture

Fabric Service

The Fabric Service is responsible for automating the fabric BGP underlay and EVPN overlay. By default, the EVPN overlay is enabled but you can turn it off it before provisioning, if necessary. The Fabric Service exposes the CLI and REST API for automating the fabric underlay and overlay configuration.

The Fabric Service features include:

- Support for small data centers (non-Clos)
- Support for 3-stage and 5-stage Clos fabrics
- Support for MCT configuration

Underlay automation includes interface configurations (IP numbered), BGP underlay for spine and leaf, BFD, and MCT configurations. Overlay automation includes EVPN and overlay gateway configuration.

Tenant Service

The Tenant Service manages tenants, tenant networks, and endpoints, fully leveraging the knowledge of assets and the underlying fabric. You can use the CLI and REST API for tenant network configuration on Clos and small data center fabrics.

Tenant network configuration includes VLAN, BD, VE, EVPN, VTEP, VRF, and router BGP configuration on fabric devices to provide Layer 2 extension, Layer 3 extension across the fabric, Layer 2 hand-off, and Layer 3 hand-off at the edge of the fabric.

Inventory Service

The Inventory Service acts as an inventory of all the necessary physical and logical assets of the fabric devices. All other XCO services rely on asset data for their configuration automation. The Inventory Service is a REST layer on top of device inventory details, with the capability to filter data based on certain fields. The Inventory Service securely stores the credentials of devices in encrypted form and makes those credentials available to different components such as the Fabric and Tenant services.

The Inventory Service supports the **execute-cli** option for pushing configuration and exec commands to devices. Examples include configuring SNMP parameters or OSPF configurations. This means you can use XCO for SLX-OS commands and push the same configuration to multiple devices.

Asset Service

The Asset Service provides the secure credential store and deep discovery of physical and logical assets of the managed devices. The service publishes the Asset refresh and change events to other services.

Notification Service

The Notification Service sends events, alerts, alarms, and tasks to external entities:

- Events: Device events derived from the syslog events received from the managed devices.
- Alerts: Notifications that services in XCO send for unexpected conditions.
- Alarms: A stateful entity that is raised and cleared by the system.
- Tasks: User-driven operations or timer-based tasks such as device registration or fabric creation.

RASlog Service

The RASlog Service processes syslog messages from devices and forwards notifications to subscribers. For more information, see RASlog Service in the [ExtremeCloud Orchestrator CLI Administration Guide, 4.0.0](#).

Security Service

The Security Service consists of authentication and authorization features that enforce a security boundary between northbound clients and downstream operations between XCO and SLX devices. The service also validates users and their credentials through Role-based Access Control (RBAC) and supports local and remote (LDAP) login.

You can use LDAP with XCO for user authentication and authorization. Based on the server configuration, XCO provides various options to configure LDAP.

- **TLS Service:** The service enables encrypted communication from XCO to LDAP server.
- **Authentication Service:** The service validates user credentials and supports host user login, local user management and remote (LDAP, TACACS) login.
- **Authorization Service:** The service provides role management and validates the permissions that the user can perform on XCO.

For more information, see XCO User Authentication and Authorization in the [ExtremeCloud Orchestrator Security Configuration Guide, 4.0.0](#)

SNMP Service

The SNMP Service processes SNMP traps from devices and forwards notifications to subscribers. For more information, see XCO as SNMP Proxy in the [ExtremeCloud Orchestrator CLI Administration Guide, 4.0.0](#).

Policy Service

Policy Service in XCO manages and configures IP prefix lists and route maps on fabric devices. It subscribes to the inventory service to receive events including device registration, device deletion, and changes to previously identified IP prefix lists and route maps.

System Service

The system service provides options to configure system-level settings, such as supportsave, backup, and feature enablement. It periodically takes a backup of the XCO system.

Fault Service

The Fault Service raises alerts and alarms when issues are detected to enable system administrators to monitor and troubleshoot.

Ecosystem Services

XCO provides one-touch integration with these ecosystems, providing deep insight into VMs, Switches, port groups, and hosts, and the translation of these into IP fabric networking constructs.

VMware vCenter Service

The vCenter integration provides connectivity between XCO and vCenter using a REST API. XCO does not connect to individual ESXi servers. All integration is done through vCenter. For more information, see the [ExtremeCloud Orchestrator VMware vCenter Integration Guide, 4.0.0](#). Integration support includes the following:

- Registration or deregistration of one or more vCenter servers in XCO
- Updates for vCenter asset details
- Lists of information about vCenter servers
- Inventory integration
- Dynamic updates about Tenant Service integration from vCenter and from XCO services

Hyper-V

The Hyper-V integration supports networking configuration for Hyper-V servers in a datacenter, manual and automated configuration updates when VMs move, and visibility into the VMs and networking resources that are deployed in the Hyper-V setup. For more information, see [ExtremeCloud Orchestrator Hyper-V Integration Guide, 4.0.0](#). Integration support includes the following:

- SCVMM (System Center Virtual Machine Manager) server discovery
- SCVMM server update
- Periodic polling of registered SCVMM servers
- SCVMM server list
- SCVMM server delete and deregister
- Network event handling

VMware vCenter

VMware's *vCenter* server software enables you to administer and manage your virtual machines and physical servers running VMware's ESXi OS from a single location. ESXi is a type-1 hypervisor that enables you to deploy and manage virtual machines.

The vCenter software reduces management complexity and time taken to manage complex deployments and reduces day-to-day tasks of managing a large deployment. vCenter Server software enables dynamic provisioning new services, balancing resources and automating high availability of your resources.

VMware vSphere Client

VMware *vSphere* client is a software that is used to manage VMware's *vCenter* servers. It provides a graphical user interface that enables you to quickly control and manage all virtual machines hosted on your vCenter devices.

How the XCO vCenter Service Works

Use the ExtremeCloud Orchestrator (XCO) application to automate the configuration of the data center's physical network hardware once you have finished configuring your VMware vCenter Server and the associated virtual machines. XCO then imports

VMware's infrastructure and topology information and then applies this to the fabric managed by it.

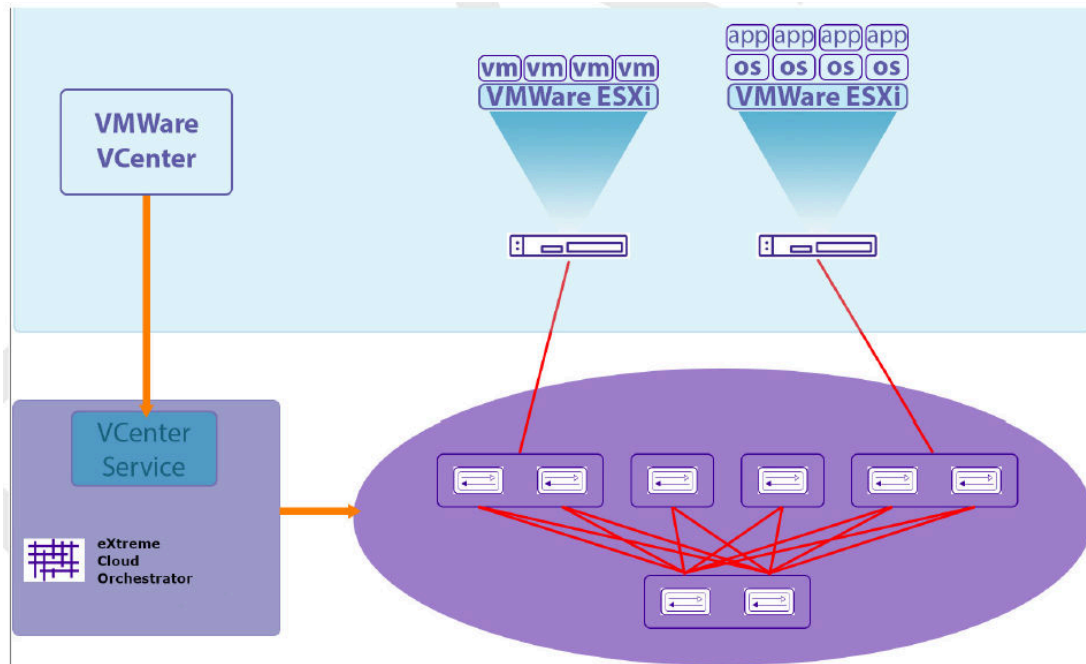

Figure 3: vCenter Service Overview

XCO requires that the physical connection between the VMware ESXi servers and ExtremeCloud devices is working and is configured properly. You should also ensure that the XCO server can access the vCenter Server. The XCO server need not be connected to the individual ESXi servers for this service to work.

Once properly configured, the XCO vCenter service queries the VMware vCenter server to:

- Discover network assets and configurations for the specific VMware vCenter server that will be used.
- Discover the ESXi servers that the specific VMware vCenter server manages. It also discovers the virtual machines and virtual network adapters that are configured on each physical ESXi server.

Discover the physical network adapters that are associated with the virtual machines discovered as mentioned above. All the above information are saved in a local database for use. This stored information is used to verify if there are any changes in the networking assets/configurations for the specified VMware vCenter server.

- Interact with XCO's Inventory service to inquire and find the connections between the physical network adapters and the ESXi servers. It also constantly interacts with the Inventory service to find the port information for any new connections with the ESXi servers.
- Interact with XCO's Tenant Service to create the required tenants and End Point Groups. It also uses the Tenant Service to periodically update the tenants and EPG

information to ensure that the information stored locally is in-sync with the actual network topology.

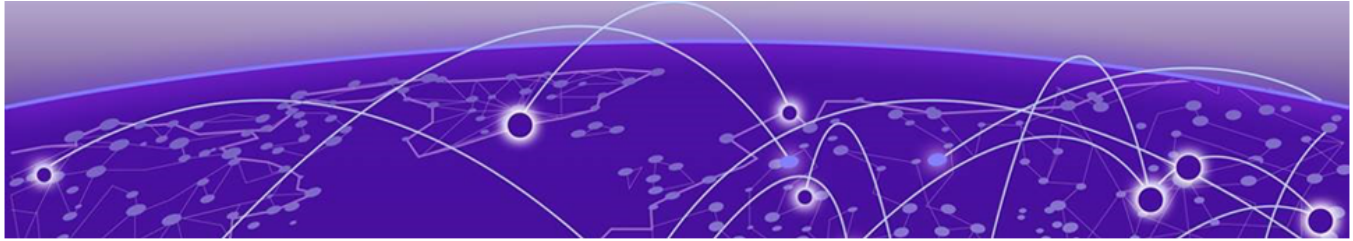

Before You Begin

[Supported Versions for XCO vCenter Service](#) on page 20

[Limitations of XCO vCenter Service](#) on page 20

[VMware vCenter Configuration](#) on page 20

Supported Versions for XCO vCenter Service

XCO vCenter Service supports all platforms and SLX-OS versions.

Limitations of XCO vCenter Service

XCO vCenter Service has the following limitations and restrictions:

- VMware vCenter Server version 6.5 and 6.7 (all releases) are supported. XCO vCenter Service will work with other version than those listed above. However, XCO does not provide support for issues that arise with the use of any versions than listed above.
- XCO requires the open standards LLDP protocol to be enabled under Distributed vSwitch (vDS) to verify the ESXi host topology. The Distributed vSwitch must be configured as "Both" under vDS Discovery Protocol settings so that it can both transmit and receive LLDP messages.
- Currently, ESXi hosts allow LLDP configuration only for the Distributed vSwitch and not the Standard vSwitch. This limitation prevents XCO vCenter Integration from supporting Standard vSwitch deployments.
- XCO does not manage VMware licenses. Users are responsible for VMware vMotion, ESXi, and vCenter licenses.
- XCO cannot detect and fix vCenter connection issues.

VMware vCenter Configuration

No configuration changes are required on the VMware vCenter Server.

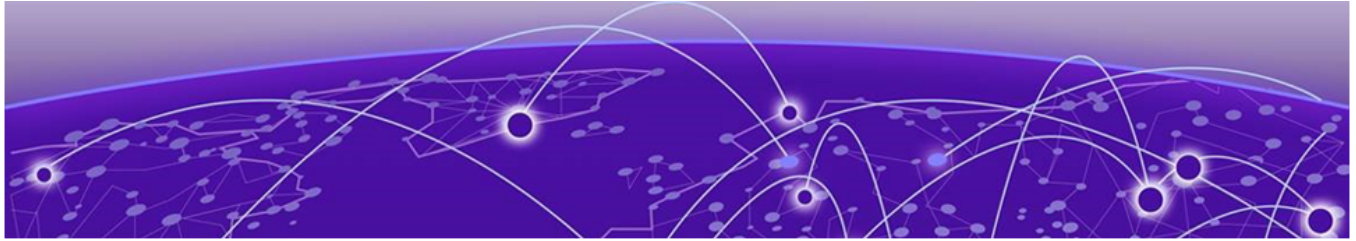

XCO vCenter Integration

[Integrate XCO vCenter Service](#) on page 21

[Verify Fabric Topology](#) on page 22

[Add Devices To Your Fabric](#) on page 23

[Create the vCenter Tenant](#) on page 25

[Register VMware vCenter Server as a Tenant](#) on page 26

Integrate XCO vCenter Service

To integrate your VMware vCenter server with your XCO vCenter service, you need to do the following:

1. Create or modify your fabric as required.
2. Create or modify your tenant information as required.
3. Register your new VMware vCenter Server as a tenant of the fabric.
4. Verify your integration.

Manage VMware vCenter Server Tenants

The primary tasks of managing your existing VMware vCenter servers as tenants would be to update them periodically or when you add new devices to them. Another task would be to delete these servers when not required.

Example Network

The following network diagram will be used throughout this section to explain the various configurations.

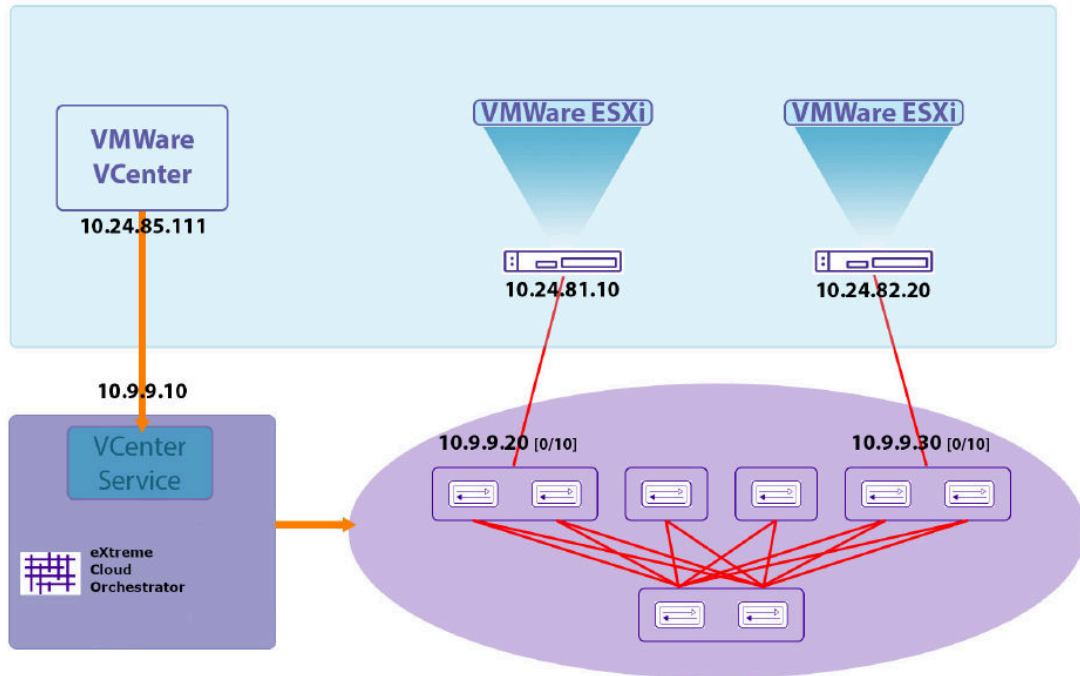

Figure 4: Sample Network Diagram

This table lists the devices, their IP or Port information, and their role within the example network.

IP Address & Port	Device & Role
10.24.85.111	VMWare vCenter Server
10.24.81.10	ESXi Server #1
10.24.82.20	ESXi Server #2
10.9.9.10	XCO Server
10.9.9.20 [0/10]	Fabric Leaf Node #1. This node is connected to the ESXi server with IP address 10.24.81.10 on port 10.
10.9.9.30 [0/10]	Fabric Leaf Node #2. This node is connected to the ESXi server with IP address 10.24.82.20 on port 10.

Verify Fabric Topology

About This Task

Verify that the fabric devices that you wish to add are present in your fabric, and when verified, fetch additional information for each of these devices.

Procedure

Execute the `efa fabric show` command.

```
efa fabric show
```

The command returns information for all the spine and leaf devices in your fabric.

Example

The following example lists the devices that make up your fabric.

```
$ efa fabric show

Fabric Name: efa-fabric-1, Fabric Description: Fabric #1, Fabric Stage: 3, Fabric Type:
clos
+-----+-----+-----+-----+-----+-----+-----+-----+
+-----+-----+-----+-----+
| IP ADDRESS | POD | HOST NAME | ASN |
ROLE | DEVICE STATE | APP STATE | CONFIG GEN | PENDING | VTLB | LB |
REASON | CONFIGS | ID | ID |
+-----+-----+-----+-----+
+-----+-----+-----+-----+
| 10.10.10.10 | | SLX | 64512 | spine
| provisioned | cfg in-sync | NA | NA | NA | 1 |
| 10.10.10.20 | | SLX | 64512 | spine
| provisioned | cfg in-sync | NA | NA | NA | 1 |
| 10.9.9.20 | | FRE-134 | 65001 | leaf
| provisioned | cfg in-sync | NA | NA | 2 | 1 |
| 10.9.9.30 | | FRE-135 | 65001 | leaf
| provisioned | cfg in-sync | NA | NA | 2 | 1 |
| 10.9.9.40 | | Orca-74 | 65000 | leaf
| provisioned | cfg in-sync | NA | NA | 2 | 1 |
| 10.9.9.50 | | Orca-76 | 65000 | leaf
| provisioned | cfg in-sync | NA | NA | 2 | 1 |
| 10.9.9.60 | | Avalanche-11 | 65002 | leaf
| provisioned | cfg in-sync | NA | NA | 2 | 1 |
| 10.9.9.70 | | Avalanche-46 | 65002 | leaf
| provisioned | cfg in-sync | NA | NA | 2 | 1 |
+-----+-----+-----+-----+
+-----+-----+-----+-----+

CONFIG GEN REASON:
LD - Link Delete, LA - Link Add, IU - Interface Update
MD - MCT Delete, OD - Overlay Gateway Delete, OU
- Overlay Gateway Update, ED - Evpn Delete
DD - Dependent Device Update, DA - Device Add, DR
- Device ReAdd, ASN - Asn Update, HN - HostName Update, NA - Not Applicable

PENDING CONFIGS:
MCT - MCT Cluster, O - Overlay Gateway, SYSP - System Properties, INTIP - Interface IP
C/D/U - Create/Delete/Update, PA/PD - Port Add/Port Delete

For App or Device Error/Failure reason, run "efa fabric error show" for details
For config refresh reason, run "efa fabric debug config-gen-reason" for details

--- Time Elapsed: 6.1824056s ---
```

What to Do Next

If needed, create a new fabric and/or add new devices to an existing fabric.

Add Devices To Your Fabric

About This Task

Add devices to a new fabric or to an existing fabric. Do the following:

Procedure

1. Use the `efa fabric device add` command to add a single device. To add multiple devices in a single command, use the `add-bulk` option instead.

```
efa fabric device add
efa fabric device add-bulk
```

2. Use the `efa fabric configure` command with the `--force` option to force the fabric to update itself by removing and adding all devices that make up the fabric. When the fabric comes up again, it will include the newly added devices.

The following command adds two leaf devices and a spine device to an existing fabric.

```
$ efa fabric device add-bulk --name efa-fabric-1 --leaf 10.9.9.80,10.9.9.90 --spine 10.10.10.30 --username administrator@mshyperv.local --password 'aBc123#'
```

```
$ efa fabric show
```

```
Fabric Name: efa-fabric-1, Fabric Description: Fabric #1, Fabric Stage: 3, Fabric Type: clos
```

IP ADDRESS	POD	HOST NAME	ASN	ROLE	DEVICE	STATE	APP STATE	CONFIG GEN REASON	PENDING CONFIGS	VTLB ID	LB ID
10.10.10.10		SLX	64512	spine	provisioned	cfg in-sync	NA	NA	NA	1	
10.10.10.20		SLX	64512	spine	provisioned	cfg in-sync	NA	NA	NA	1	
10.10.10.30		SLX	64512	spine	provisioned	cfg in-sync	NA	NA	NA	1	
10.9.9.20		FRE-134	65001	leaf	provisioned	cfg in-sync	NA	NA	2	1	
10.9.9.30		FRE-135	65001	leaf	provisioned	cfg in-sync	NA	NA	2	1	
10.9.9.40		Orca-74	65000	leaf	provisioned	cfg in-sync	NA	NA	2	1	
10.9.9.50		Orca-76	65000	leaf	provisioned	cfg in-sync	NA	NA	2	1	
10.9.9.60		Avalanche-11	65002	leaf	provisioned	cfg in-sync	NA	NA	2	1	
10.9.9.70		Avalanche-46	65002	leaf	provisioned	cfg in-sync	NA	NA	2	1	
10.9.9.80		Orca-78	65002	leaf	provisioned	cfg in-sync	NA	NA	2	1	
10.9.9.90		Avalanche-72	65002	leaf	provisioned	cfg in-sync	NA	NA	2	1	

```
CONFIG GEN REASON:
```

```
LD - Link Delete, LA - Link Add, IU - Interface Update
```

```
MD - MCT Delete, OD - Overlay Gateway Delete, OU - Overlay
```

```
Gateway Update, ED - Evpn Delete
```

```
DD - Dependent Device Update, DA - Device Add, DR -
```

```
Device ReAdd, ASN - Asn Update, HN - HostName Update, NA - Not Applicable
```

```
PENDING CONFIGS:
```

```
MCT - MCT Cluster, O - Overlay Gateway, SYSP - System Properties, INTIP - Interface IP  
C/D/U - Create/Delete/Update, PA/PD - Port Add/Port Delete
```

```
For App or Device Error/Failure reason, run "efa fabric error show" for details
For config refresh reason, run "efa fabric debug config-gen-reason" for details

--- Time Elapsed: 6.1824056s ---
```

This command forces all the devices to be removed and added back to the fabric. This step is necessary to ensure that the overlay and underlay information for the newly added devices are propagated throughout the fabric.

```
$ efa fabric configure --name efa-fabric-1 --force
```

Create the vCenter Tenant

About This Task

Add the VMware vCenter Server to the XCO vCenter Service instance. Do the following:

Procedure

1. Use the `efa tenant create` command to create your tenant entry. When creating your tenant, ensure that you provision adequate number of VLANs that are available for use.
2. Once you have created the new tenant, verify that the devices you added are added to the correct fabric. Use the `efa inventory device list` command to do so.

Results

This command will create a tenant entry that is used when registering a VMware vCenter Server with XCO.

Example

This command creates a tenant entry with the name *vcenter-10.24.85.111*.

```
$ efa tenant create --name vcenter-10.24.85.111 --vlan-range 2-4096 --port
10.9.9.20[0/10],10.9.9.30[0/10]
```

Use this command to verify if the devices that you have added to the fabric are associated with the correct fabric.

```
$ efa inventory device list
```

```
root@ubuntu:~# efa inventory device list
```

```
+-----+-----+-----+-----+-----+-----+-----+-----+
| IP Address | Host Name | Model | Chassis Name | Firmware | ASN | Role | Fabric |
+-----+-----+-----+-----+-----+-----+-----+-----+
| 10.9.9.20 | FRE-134 | | | | 65001 | leaf | efa-fabric-1 |
| | | | | | | | |
| 10.9.9.30 | FRE-135 | | | | 65001 | leaf | efa-fabric-1 |
| | | | | | | | |
+-----+-----+-----+-----+-----+-----+-----+-----+
Device Details
--- Time Elapsed: 32.932576ms ---
```

Register VMware vCenter Server as a Tenant

About This Task

Register the VMware vCenter server as a tenant of XCO. Do the following:

Procedure

1. Use the `efa vcenter register` command to register the VMware vCenter server as a tenant with this XCO instance.

Before you register the VMware vCenter server, verify that the tenant is created. Use the `efa tenant show` command to do so.

2. Once you have registered your VMWare vCenter server as a tenant, verify that the VMware vCenter server was registered successfully and know the status of discovery of ESXi hosts managed by it.

Example

This example shows the use of the `efa tenant show` command to view a list of registered tenants for this instance of the XCO vCenter service.

```
$ efa tenant show
+-----+-----+-----+-----+-----+-----+
+-----+
| Name           | L2VNI-Range | L3VNI-Range | VLAN-Range | VRF-Count | Enable-
BD | Ports |
+-----+-----+-----+-----+-----+-----+
+-----+
| vcenter-10.24.85.111 |           |           | 2-4096     | 0         | False
|           |
+-----+-----+-----+-----+-----+-----+
+-----+
Tenant Details
--- Time Elapsed: 948.4093ms ---
```

Use this command to register a VMware vCenter server with the IP address of 10.24.85.111 as a tenant with this instance of XCO vCenter service.

```
$ efa vcenter register --host 10.24.85.111 --username administrator@vmvcenter.local --
password 'aBc123#' --tenant vcenter-10.24.85.111
+-----+-----+-----+-----+-----+-----+
+-----+
| Host Name      | Name           | Version | Discovery Status |
+-----+-----+-----+-----+-----+-----+
| 10.24.85.111 | VMware vCenter Server | 6.7.0  | Pending Complete Discovery |
+-----+-----+-----+-----+-----+-----+
+-----+
VCenter Details
--- Time Elapsed: 10.0346556s ---
```

Use this command to verify the status of discovery of your newly added VMware vCenter server.

```
$ efa vcenter list
+-----+-----+-----+-----+-----+-----+
+-----+
| Host Name      | Name           | Version |
+-----+-----+-----+-----+-----+-----+
| 10.24.85.111 | VMware vCenter Server | 6.7.0  |
+-----+-----+-----+-----+-----+-----+
```

```

Discovery Status          | Datacenters Count | Host Count | VM Count |
+-----+-----+-----+-----+
| 10.24.85.111 | VMware vCenter Server | 6.7.0
| Pending Complete Discovery | 1          | 1          | 0          |
+-----+-----+-----+-----+
vCenter Details
--- Time Elapsed: 1.0318464s ---

```

This example shows the same VMware vCenter server after the `vcenter update` process is complete.

```

$ efa vcenter list
+-----+-----+-----+-----+-----+
+-----+-----+
| Host Name      | Name                | Version | Discovery Status | Datacenters
Count | Host Count | VM Count |
+-----+-----+-----+-----+-----+
| 10.24.85.111 | VMware vCenter Server | 6.7.0  | Update Completed | 5
| 4             | 13                 |
+-----+-----+-----+-----+-----+
vCenter Details
--- Time Elapsed: 1.3625964s ---

```

This example show a VMware vCenter server after the `register` and background discovery process is completed.

```

$ efa vcenter list
+-----+-----+-----+-----+-----+
+-----+-----+
| Host Name      | Name                | Version
| Discovery Status | Datacenters Count | Host Count | VM Count |
+-----+-----+-----+-----+-----+
+-----+-----+
| 10.24.85.111 | VMware vCenter Server
| 6.7.0       | Completed Discovery | 5          | 4          | 11          |
+-----+-----+-----+-----+-----+
vCenter Details
--- Time Elapsed: 197.886032ms ---

```

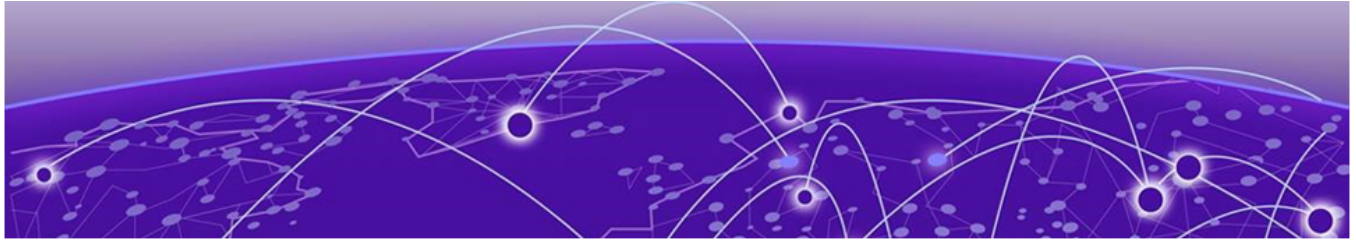

XCO vCenter Commands

- [efa vcenter](#) on page 29
- [efa vcenter register](#) on page 30
- [efa vcenter update](#) on page 31
- [efa vcenter list](#) on page 32
- [efa vcenter links](#) on page 33
- [efa vcenter delete](#) on page 35
- [efa vcenter debug](#) on page 36

efa vcenter

The base command for all XCO vCenter actions.

```
efa vcenter { register | update | list | delete | links | debug }
```

There are no defaults for this command

register

Command to register VMware vCenter server as a tenant.

update

Command to update the local XCO database with topology changes on the virtual machines managed by the VMware vCenter server.

list

Command to list all the VMware vCenter servers registered as tenants with XCO vCenter service.

delete

Command to delete specific VMware vCenter server registered as a tenant with XCO vCenter service.

links

Command to list the links on a VMware vCenter server or any ESCi device that is managed through this tenant. This command can display link information for physical and virtual NICs and also those NICs that are not connected/used.

debug

Command to debug any issue with respect to this vCenter tenant.

This command lists the registered VMware vCenter servers registered as tenants with this instance of XCO.

```
$ efa vcenter list
+-----+-----+-----+-----+
+-----+-----+-----+-----+
| Host Name   | Name                               | Version |
Discovery Status | Datacenters Count | Host Count | VM Count |
+-----+-----+-----+-----+
| 10.24.85.166 | VMware vCenter Server | 6.7.0
| Pending Complete Discovery | 1 | 1 | 0 |
+-----+-----+-----+-----+
+-----+-----+-----+-----+
```

efa vcenter register

Registers a VMware vCenter server as a tenant with the XCO instance.

```
efa vcenter register [ --host string | --username string | --password string | --tenant string ]
```

This command has no defaults. All flags are mandatory.

Tenant details must be registered before running the command.

--host *string*

IP address or hostname of the VMware vCenter Server to connect to.

--username *string*

Username to connect to the VMware vCenter Server.

--password *string*

Password to connect to the VMware vCenter Server.

--tenant *string*

Tenant associated with the VMware vCenter Server host.

This example registers a VMware vCenter Server as a tenant with XCO vCenter service.

```
$ efa vcenter register --host 10.24.85.111 --username administrator@vmvcenter.local  
--password 'aBc123#' --tenant tenant-10.24.85.111
```

efa vcenter update

Updates the local database with configuration changes made to the VMware vCenter server and the ESXi servers managed by it.

```
efa vcenter update [ --host string | --username string | --password string ]
```

This command has no defaults. All flags are mandatory.

--host *string*

IP address or host name of the VMware vCenter server from which the local XCO vCenter service database needs to be updated.

--username *string*

Username to connect to the VMware vCenter Server.

--password *string*

Password to connect to the VMware vCenter Server.

This example updates the local XCO vCenter service database with the latest state of the VMware vCenter server with the IP address 10.24.85.111.

```
$ efa vcenter update --host 10.24.85.111 --username administrator@vmvcenter.local --password 'aBc123#'
```

efa vcenter links

Displays the links for VMware vCenter server tenants and their ESXi hosts.

```
efa vcenter links [ physical | unconnected ] [ --host string | --esxi string ]
```

```
efa vcenter links virtual --esxi string
```

physical

Displays the physical links for the selected device. Device can be a VMware vCenter Server or an ESXi server.

unconnected

Displays the unconnected (unused) links for the selected device. Device can be a VMware vCenter Server or an ESXi server.

virtual

Displays the virtual links created on a ESXi server.

--host

The IP address or host name of the VMware vCenter Server for which to view the physical and unconnected (unused) links.

--esxi

The IP address or host name of the ESXi tenant for which to view the physical, virtual, and unconnected (unused) links.

For VMware vCenter server tenants, physical and unconnected links are displayed. For ESXi hosts, physical, unconnected, and virtual links are displayed.

This example is list of ESXi device managed by the VMware vCenter Server with the IP 10.24.85.111.

```
$ efa vcenter links physical --host 10.24.85.111
Physical Links for vCenter 10.24.85.111
+-----+-----+-----+-----+-----+-----+-----+
+-----+-----+-----+-----+-----+-----+-----+
| ESXi Host   | PNIC   | Driver | PNIC MAC | Missing | Missing Time |
| Interface   | PO Number | PO Name | Device   |         |              |
+-----+-----+-----+-----+-----+-----+-----+
| 10.24.81.10 | vmnic3 | ntg3   | 40:f2:e9:bb:4c:83 |         |              |
Ethernet 0/10 |         |         | 10.9.9.20 |         |              |
+-----+-----+-----+-----+-----+-----+-----+
| 10.24.82.20 | vmnic2 | ntg3   | 40:f2:e9:bb:58:b2 |         |              |
Ethernet 0/10 |         |         | 10.9.9.30 |         |              |
+-----+-----+-----+-----+-----+-----+-----+
| 10.24.83.30 | vmnic3 | ntg3   | 40:f2:e9:bb:58:b3 |         |              |
Ethernet 0/10 |         |         | 10.9.9.40 |         |              |
+-----+-----+-----+-----+-----+-----+-----+
Physical Link Details
--- Time Elapsed: 359.1528ms ---
```

This example is a list of virtual machines and their virtual links on the ESXi host with the IP 10.24.81.10.

```
$ efa vcenter links virtual --esxi 10.24.81.10
Virtual Links for ESXi server 10.24.81.10
+-----+-----+-----+-----+-----+
| Virtual Machine | vNIC          | MAC          |
| VLAN | Port Group | vSwitch      | Distributed |
+-----+-----+-----+-----+-----+
| 20200221 v1     | Network adapter 1 | 00:50:56:9c:75:29
| 3048 | VM Network | vSwitch0     | false      |
+-----+-----+-----+-----+-----+
| test_vm2       | Network adapter 2 | 00:50:56:9c:7e:83
| 3048 | VM Network | vSwitch0     | false      |
+-----+-----+-----+-----+-----+
| 20200221 v1     | Network adapter 2 |
00:50:56:9c:f6:13 | 3048 | VM Network | vSwitch0     | false      |
+-----+-----+-----+-----+-----+
| vMotionVm      | Network adapter 1 | 00:50:56:9c:8f:fd
| 10   | DPortGroup | Real-DV-Switch | true       |
+-----+-----+-----+-----+-----+
| test_vm2       | Network adapter 1 |
00:50:56:9c:1d:09 | 10   | DPortGroup | Real-DV-Switch | true       |
+-----+-----+-----+-----+-----+
vNIC Link Details
--- Time Elapsed: 500.4792ms ---
```

efa vcenter delete

Deletes the VMware vCenter server registered as a tenant with this XCO instance.

```
efa vcenter delete --host string [ --cleanup-tenants ]
```

```
--host string
```

IP address or hostname of the VMware vCenter server tenant to delete.

```
--cleanup-tenants
```

When included, the tenants and EPGs associated to the VMware vCenter Server are deleted. When not included, the tenants and EPGs associated with the VMware vCenter Server are retained when the server is removed.

When the `cleanup-tenants` parameter is supplied, the command removes the registered ESXi hosts and EPGs for this VMware vCenter Server tenant.

This example deletes the VMware vCenter Server with host IP 10.24.85.111 while retaining the associated tenants and EPGs.

```
$ efa vcenter delete --host 10.24.85.111
```

This example deletes the VMware vCenter Server with host IP 10.24.85.111 and removes the associated tenants and EPGs.

```
$ efa vcenter delete --host 10.24.85.111 --cleanup-tenants
```

efa vcenter debug

A set of debug commands for troubleshooting XCO vCenter issues. This command also sets configuration parameters for vCenter tenants.

efa vcenter debug tenant show --host *string*

Shows a list of tenants for a particular VMware vCenter server host.

efa vcenter debug event show --host *string* [**--page** *int32* | **--page-size** *int32*]

Shows a list of events recorded for a particular VMware vCenter server host.

efa vcenter debug setting show

Shows the different settings configured on the VMware vCenter server host. These settings are global in nature and are applicable to all VMware vCenter Server hosts registered with this XCO vCenter Service instance.

efa vcenter debug setting update [**--poll-frequency** *string* | **--dead-link-clearing-time** *string*]

Updates the different settings for the added VMware vCenter server hosts registered with this XCO vCenter Service instance. These settings are applicable to all the VMware vCenter Server hosts.

efa vcenter debug set --level [*info* | *debug*]

Sets the debug level for this instance of XCO vCenter service. Debug levels can be set to receiving information level messages or complete debugging messages.

This command has no defaults.

--host *string*

IP address or hostname of the VMware vCenter Server to connect to.

--page *int32*

Events are fetched for the page number specified in this parameter. When this parameter is not passed, page number 1 is always fetched by default.

--page-size *int32*

The number of events to display per page. When this parameter is not passed, twenty (20) records are shown per page.

--poll-frequency *string*

The poll duration in hours. The XCO vCenter Service polls all the VMware vCenter servers registered with it after this time duration has expired.

--dead-link-clearing-time *string*

The time duration in days. This is the time duration for which dead links are removed from the XCO vCenter service database.

--level [*info* | *debug*]

Sets the debug level for this XCO vCenter service instance. Can be one of *info* or *debug*. Use *info* to view only messages of the level *info*. Use *debug* to view all debug messages.

The following example returns the debug information for tenant creation failure (and any other reported errors) for a vCenter server with IP address 10.24.85.111. This example shows only a portion of the possible output.

```
$ efa vcenter debug tenant --host 10.24.85.111
Tenant Configuration Details for vCenter 10.24.85.111
+-----+-----+-----+-----+
+-----+
| Tenant Name          | Ports
| VLANs | Status          | Reason
+-----+-----+-----+-----+
| vcenter-10.24.85.111 |      |
2-4089 | Creation Failed | Tenant vcenter-10.24.85.111 is missing the
|                               |
| following interfaces: 10.25.225.46="ethernet-0/5"
+-----+-----+-----+-----+
+-----+
Tenant Details

EPG Configuration Details for vCenter 10.24.85.111
+-----+-----+-----+-----+
+-----+
| EPG Name
| Ports              | Switchport Mode |
+-----+-----+-----+-----+
+-----+
| vCenter_10.24.85.111_10.24.82.20_vSwitch1_VMNetwork2 |
10.24.82.20[0/11] | trunk              |
+-----+-----+-----+-----+
+-----+
```

This example shows the vCenter service settings.

```
$ efa vcenter debug setting show

vCenter service settings
+-----+-----+-----+-----+
| Poll Frequency Hours | Dead Link Clearing Time Days |
+-----+-----+-----+-----+
| 4                     | 3                             |
+-----+-----+-----+-----+
```

This example shows tenant and endpoint group information for the specified IP address.

```
$ efa vcenter debug tenant --host 10.24.85.111

+-----+-----+-----+-----+-----+
| Tenant Name          | Ports | VLANs | Status          | Reason |
+-----+-----+-----+-----+-----+
| vcenter-10.24.85.111 |      | 2-4089 | Created Successfully |      |
+-----+-----+-----+-----+-----+
```

```

+-----+-----+-----+-----+-----+
Tenant Details

EPG Configuration Details for vCenter 10.24.85.111
+-----+-----+-----+-----+-----+
| EPG Name | Ports | POs | Switchport Mode | VLANS | Status | Reason |
+-----+-----+-----+-----+-----+

```

This example shows event details for the specified host. This example shows only a portion of the possible output.

```

$ efa vcenter debug event --host 10.24.85.111

+-----+-----+-----+-----+-----+
| Task: Update network configuration | 10.24.81.10 |
+-----+-----+-----+-----+-----+
| dvPort group VM network 200-220 in SRA-Dev-DC | VM network 200-220 |
| was reconfigured. Modified: | |
| config.defaultPortConfig.vlan: (inherited = false, vlanId | |
| = 200) -> (inherited = false, vlanId = ((start = 0, end = | |
| 200)); Added: Deleted: | |
+-----+-----+-----+-----+-----+
| Task: Update network configuration | 10.24.82.20 |
+-----+-----+-----+-----+-----+
| dvPort group VM network 200-220 in SRA-Dev-DC | VM network 200-220 |
| was reconfigured. Modified: | |
| config.defaultPortConfig.vlan: (inherited = false, vlanId = | |
| ((start = 200, end = 220)) -> (inherited = false, vlanId = | |
| 200); Added: Deleted: | |
+-----+-----+-----+-----+-----+

```

The following example shows typical output for the specified host.

```

$ efa vcenter debug tenant --host 10.24.85.111

Tenant Configuration Details for vCenter 10.24.85.111
+-----+-----+-----+-----+-----+
| Tenant Name | Ports | VLANS | Status | Reason |
+-----+-----+-----+-----+-----+
| vcenter-10.24.85.111 | | 2-4089 | Created Successfully | |
+-----+-----+-----+-----+-----+

Tenant Details

EPG Configuration Details for vCenter 10.24.85.111
+-----+-----+-----+-----+-----+
| EPG Name | Ports | POs | Switchport Mode | VLANS | Status | Reason |
+-----+-----+-----+-----+-----+

```

This example shows typical, but truncated, output for debugging events for the specified host.

```

$ efa vcenter debug event --host 10.24.85.111

vCenter Events Total Count (4) for host 10.24.85.111
+-----+-----+-----+-----+-----+

```

Description	Target
Task: Update network configuration	10.24.81.10
dvPort group VM network 200-220 in SRA-Dev-DC was reconfigured. Modified: config.defaultPortConfig.vlan: (inherited = false, vlanId = 200) -> (inherited = false, vlanId = ((start = 0, end = 200))); Added: Deleted:	VM network 200-220
Task: Update network configuration	10.24.82.20
dvPort group VM network 200-220 in SRA-Dev-DC was reconfigured. Modified: config.defaultPortConfig.vlan: (inherited = false, vlanId = ((start = 200, end = 220))) -> (inherited = false, vlanId = 200); Added: Deleted:	VM network 200-220

This command sets the polling frequency to 5 minutes.

```
$ efa vcenter debug setting update --poll-frequency=5
vCenter service settings updated successfully
```

This example command sets the dead-link-clearing-time value to 4 days.

```
$ efa vcenter debug setting update --dead-link-clearing-time=4
vCenter service settings updated successfully
```

This example sets the log level to debug for this XCO instance.

```
$ efa vcenter debug set --level=debug
Level debug set successfully.
```