

# X690 Series Switch Quick Reference

Follow these steps to get your switch up and running.

For complete installation instructions see the *ExtremeSwitching and Summit Switches: Hardware Installation Guide* at [www.extremenetworks.com/documentation](http://www.extremenetworks.com/documentation)

## Tools You'll Need

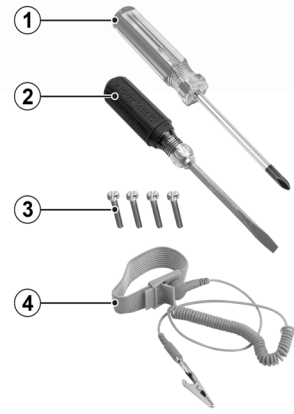

- 1 #1 Phillips screwdriver (magnetic screwdriver recommended)
- 2 Flat-head screwdriver
- 3 Rack-mounting screws
- 4 ESD-protective wrist strap

## 1 Prepare the Site

The installation site must meet the following requirements:

- Appropriate grounded power receptacles located within 1.8 m (6 ft.)
- A readily accessible device for disconnecting power, such as a breaker or master switch
- Network cabling within reach
- At least of 7.6 cm (3.0 in.) on all sides, for proper ventilation
- Temperature between 0°C (32°F) and 45°C (113°F) with fluctuations of less than 10°C (18°F) per hour

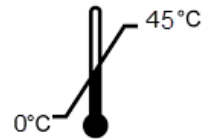

## 2 Unpack the Box

Remove the packing material. Break the tape seal on the non-conductive bag and remove the switch.

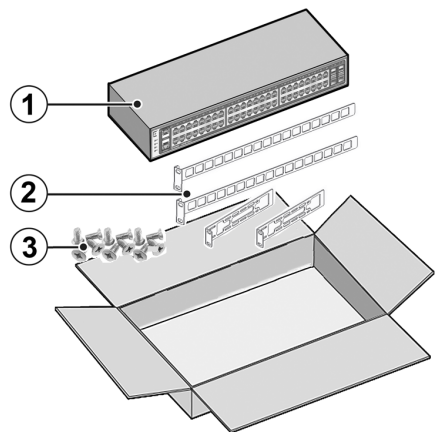

- 1 Switch (48-port model shown)
- 2 Mounting brackets
- 3 Bracket screws

If the switch appears to be damaged, contact Extreme Networks. See "Getting Help" for more information.

Extreme Networks does not include power input cords with this product. To purchase the correct power cord for your country, refer to [www.extremenetworks.com/product/powercords/](http://www.extremenetworks.com/product/powercords/). This page lists details for purchasing a power cord from Extreme Networks or from your local supplier.

## 3 Install the Switch

You can install any X690 Series switch in a standard 19-inch equipment rack.

There are four ways to mount the X690 Series switch in a rack:

- Either the I/O ports or the power-supply side can face front.
- The switch can be mounted flush with the rack posts or mid-mounted.

- 1 Attach the mounting brackets to the sides of the switch using six screws (included) for each bracket.

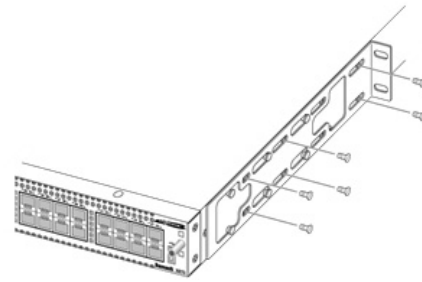

- 2 Align the holes in the brackets with the rack post holes.
- 3 Secure the switch to each post with fasteners appropriate to the rack.

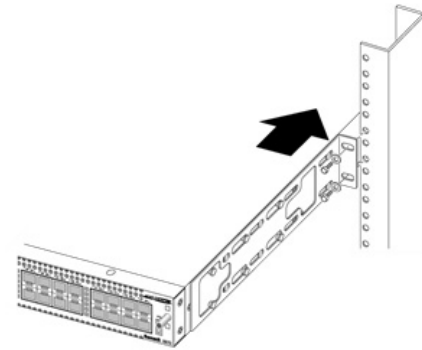

## 4 Install Transceivers

(Optional) Transceivers can send and receive data over optical fiber rather than through electrical wires. This installation procedure applies to all transceivers.



**Note:** Transceivers are Class 1 or Class 1M laser devices.

- 1 Attach the ESD wrist strap to your wrist and connect the metal end to an appropriate ground point on the rack.
- 2 Remove the transceiver from its packaging.
- 3 If applicable, remove the protective dust cover from the connector.
- 4 Hold the transceiver so that the connector will seat properly.
- 5 Carefully align the transceiver with the port slot.
- 6 Push the transceiver into the port slot until it clicks into place.

## 5 Connect Power

X690 Series switches can run on AC or DC power. Connect the switch to a primary power source.



**Note:** Installing the system as described in this guide meets the protective earth grounding requirements of the National Electrical Code (NEC) UL 60950 and IEC 60950 standards. However, in some cases, it may be necessary to use an alternative grounding method. In these cases, a 14 AWG wire can be connected between the grounding lug on the chassis and a nearby building ground point.

### Connecting to the Primary Power Source

To attach your X690 Series switch to a power source, do the following:

- 1 Connect the AC power cord to the AC power input socket on the power supply and an AC power outlet.
- 2 For DC powered supplies, verify that the DC circuit is de-energized and then do the following:
  - a Identify the grounding stud on the DC power supply. The grounding stud is next to the DC input connector, identified by the international symbol for earth ground.
  - b Using the nut and washer provided, connect the ring terminal end of the ground wire to the grounding stud on the DC power supply. Use green and yellow stranded copper wire, sized at least 14 AWG.
  - c Connect the other end of the ground wire to a reliable earth ground.
  - d Connect the DC power input cables to the DC input connector provided. Use copper wires rated for at least 60°C and sized between 14 AWG and 8 AWG.
  - e Energize the circuit.
- 3 When power is connected, verify that the switch's PWR LED turns green. If the PWR LED does not turn green, refer to the *Hardware Installation Guide* for troubleshooting information.

## 6 Configure the Switch

To connect the switch to the network and configure it for use, follow the steps in [www.extrconfig.com/exos](http://www.extrconfig.com/exos).

### Safety Notices



**Electrical Hazard:** Only qualified personnel should perform installation procedures.

**Risques d'électrocution:** Seul un personnel qualifié doit effectuer les procédures d'installation.



**Warning:** Extreme Networks power supplies do not have switches for turning the unit on and off. Before servicing, disconnect all power cords to remove power from the device. Make sure that these connections are easily accessible.  
**Avertissement:** Extreme Networks alimentations ne sont pas des interrupteurs pour allumer l'appareil et en dehors. Avant l'entretien, débranchez tous les cordons d'alimentation pour couper l'alimentation de l'appareil. Assurez-vous que ces connexions sont facilement accessibles.



**Warning:** A dedicated Listed circuit breaker rated at 15A is to be used for each power supply connection.  
**Avertissement:** Un disjoncteur cotée dédiée évalué à 15A doit être utilisée pour chaque connexion d'alimentation.



**Caution:** Before mounting the device, ensure that the rack can support it without compromising stability. Otherwise, personal injury and/or equipment damage may result.



**Caution:** Follow appropriate ESD procedures when unpacking and handling the switch. These include unpacking the switch in an ESD-safe environment and wearing appropriate ESD protective gear, such as ESD-safe footwear and ESD wrist straps where appropriate.



**Caution:** Use of controls or adjustments or performance of procedures other than those specified herein may result in hazardous radiation exposure.



**Warning:** Do not use optical instruments to view the laser output. The use of optical instruments to view laser output increases eye hazard. Use only UL/CSA, IEC/EN60825-1/-2 recognized pluggable modules.

**Avertissement:** Ne pas utiliser d'instruments optiques pour voir la sortie du laser. L'utilisation de instruments optiques pour afficher la sortie laser augmente les risques oculaires. Utilisez uniquement UL/CSA, IEC/EN60825-1 /-2 reconnu modules enfichables.

## Hardware Components

Figure 1 X690 Series Switch: Front Panel

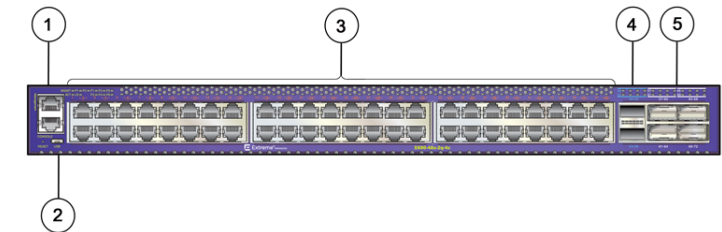

- 1 Console/management port
- 2 USB port
- 3 1Gb/10GBASE-T ports (48t model) or 1Gb/10Gb SFP+ ports (48x model)
- 4 10Gb/40Gb QSFP+ ports
- 5 10Gb/25Gb/40Gb/50Gb/100Gb capable QSFP28 ports

Figure 2 X690 Series Switch: Rear Panel

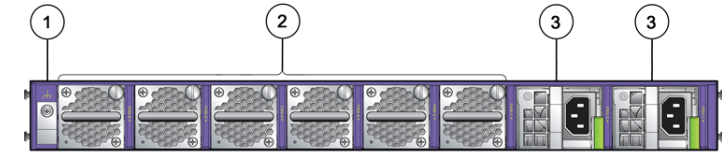

- 1 Grounding lug
- 2 Fan modules
- 3 DC power input connector

For component details, see the *Hardware Installation Guide*.

## Operating Conditions

**Operating Temperature:** 0°C (32°F) to 45°C (113°F)

**Storage Temperature:** -40°C to 70°C (-40°F to 158°F)

**Operating Relative Humidity:** 5% to 95% (non-condensing)

## Interfaces

Each X690 Series switch has a management port, a console port, and a USB port. The following table lists the specific interfaces for each switch.

X690-48t-2q-4c (Part no. 17360)	X690 base unit with 48 1Gb/10GBASE-T ports, 2 10Gb/40Gb QSFP+ ports, 4 10Gb/25Gb/40Gb/50Gb/100Gb capable QSFP28 ports, 2 unpopulated power supply slots, 6 unpopulated fan module slots, ExtremeXOS Advanced Edge License
X690-48x-2q-4c (Part no. 17350)	X690 base unit with 48 1Gb/10Gb SFP+ ports, 2 10Gb/40Gb QSFP+ ports, 4 10Gb/25Gb/40Gb/50Gb/100Gb capable QSFP28 ports, 2 unpopulated power supply slots, 6 unpopulated fan module slots, ExtremeXOS Advanced Edge License

## Power Specifications

X690-48t-2q-4c (Part no. 17360)	AC Input: 100-127VAC, 4.0A max. 50-60Hz for each PSU AC Input: 200-240VAC, 2.0A max. 50-60Hz for each PSU DC Input: -48 to -60VDC, 8.0A max. for each PSU
X690-48x-2q-4c (Part no.17350)	AC Input: 100-127VAC, 3.0A max. 50-60Hz for each PSU AC Input: 200-240VAC, 1.5A max. 50-60Hz for each PSU DC Input: -48 to -60VDC, 6.0A max. for each PSU

## Power Supply and Fan Options

X690-48t-2q-4c X690-48x-2q-4c	
Part no. 10960	770W AC power supply, Front-to-Back airflow
Part no. 10961	770W AC power supply, Back-to-Front airflow
Part no. 10962	1100W DC power supply, Front-to-Back airflow
Part no. 10963	1100W DC power supply, Back-to-Front airflow
Part no. 17115	X870 Fan Module, Front-to-Back airflow
Part no. 17116	X870 Fan Module, Back-to-Front airflow

## Getting Help

For additional support related to X690 Series switches or this document, contact Extreme Networks using one of the following methods:

<b>Product Documentation</b>	<a href="https://www.extremenetworks.com/documentation/">https://www.extremenetworks.com/documentation/</a>
<b>Global Technical Assistance Center (GTAC)</b>	Phone: 1-800-998-2408 (toll-free in U.S. and Canada) or +1-408-579-2826. For the support phone number in your country, visit: <a href="http://www.extremenetworks.com/support/contact/">http://www.extremenetworks.com/support/contact/</a>
<b>GTAC Knowledge</b>	Get on-demand and tested resolutions from the GTAC Knowledgebase, or create a help case if you need more guidance. Visit: <a href="https://gtacknowledge.extremenetworks.com/">https://gtacknowledge.extremenetworks.com/</a>
<b>The Hub</b>	A forum for Extreme customers to connect with one another, get questions answered, share ideas and feedback, and get problems solved. The community is monitored by Extreme Networks employees, but is not intended to replace specific guidance from GTAC. Visit: <a href="https://community.extremenetworks.com">https://community.extremenetworks.com</a>
<b>Support Portal</b>	Manage cases, downloads, service contracts, product licensing, and training and certifications. Visit: <a href="http://support.extremenetworks.com/">http://support.extremenetworks.com/</a>

## Notice

Copyright © 2017 Extreme Networks, Inc. All Rights Reserved.

### Legal Notices

Extreme Networks, Inc. reserves the right to make changes in specifications and other information contained in this document and its website without prior notice. The reader should in all cases consult representatives of Extreme Networks to determine whether any such changes have been made.

The hardware, firmware, software or any specifications described or referred to in this document are subject to change without notice.

### Trademarks

Extreme Networks and the Extreme Networks logo are trademarks or registered trademarks of Extreme Networks, Inc. in the United States and/or other countries.

All other names (including any product names) mentioned in this document are the property of their respective owners and may be trademarks or registered trademarks of their respective companies/owners. For additional information on Extreme Networks trademarks, please see: [www.extremenetworks.com/company/legal/trademarks/](http://www.extremenetworks.com/company/legal/trademarks/)

## Warranty

Warranty information for X690 Series series switches is located online at:

[www.extremenetworks.com/support/policies/](http://www.extremenetworks.com/support/policies/)

## Regulatory and Compliance Information

### Federal Communications Commission (FCC) Notice

This device complies with Part 15 of the FCC rules. Operation is subject to the following two conditions: (1) this device may not cause harmful interference, and (2) this device must accept any interference received, including interference that may cause undesired operation.

**NOTE:** This equipment has been tested and found to comply with the limits for a class A digital device, pursuant to Part 15 of the FCC rules. These limits are designed to provide reasonable protection against harmful interference when the equipment is operated in a commercial environment. This equipment uses, generates, and can radiate radio frequency energy and if not installed in accordance with the operator’s manual, may cause harmful interference to radio communications. Operation of this equipment in a residential area is likely to cause interference in which case the user will be required to correct the interference at his own expense.

**WARNING:** Changes or modifications made to this device which are not expressly approved by the party responsible for compliance could void the user’s authority to operate the equipment.

### Industry Canada Notice CAN ICES-3 (A)/NMB-3(A)

This digital apparatus does not exceed the class A limits for radio noise emissions from digital apparatus set out in the Radio Interference Regulations of the Canadian Department of Communications.

Le présent appareil numérique n’émet pas de bruits radioélectriques dépassant les limites applicables aux appareils numériques de la class A prescrites dans le Règlement sur le brouillage radioélectrique édicté par le ministère des Communications du Canada.

### Class A ITE Notice

**WARNING:** This equipment is compliant with Class A of CISPR 32. In a residential environment this equipment may cause radio interference.

### Product Safety

This product complies with the following international safety standards:

- UL 60950-1 2nd edition, A2:2014
- CAN/CSA-C22.2 No.60950-1-07 2nd Ed. 2014-10
- IEC 60950-1:2005 2nd+A1:2009+A2:2013
- EN 60950-1:2006+A11+A1+A12+A2
- 2014/35/EU
- CNS 14336-1



Warning: The X690 switch may be hot to the touch during normal operation.

Attention: Le X690 peut être chaude au toucher pendant le fonctionnement normal.



**Warning:** The X690 switch is designed for installation in restricted access locations.



**Attention:** Le X690 est conçu pour une installation dans des endroits à accès restreint.

### Optical Module Compliance

Extreme Networks pluggable optical modules and direct-attach cables meet the following regulatory requirements:

- UL and/or CSA registered component for North America
- Class 1 or Class 1M Laser Product
- FCC 21 CFR Chapter 1, Sub-chapter J in accordance with FDA & CDRH requirements
- IEC/EN 60825-1:2007, IEC/EN 60825-2:2004+A1+A2 or later, European Standard

### Korea EMC Statement

이 기기는 업무용 환경에서 사용할 목적으로 적

합성평가를 받은 기기로서 가정용 환경에서 사

용하는 경우 전파간섭의 우려가 있습니다.

### Australia (RCM)

**WARNING:** This equipment is compliant with Class A of CISPR 32. In a residential environment this equipment may cause radio interference.

### Electromagnetic Compatibility (EMC)

This product complies with the following: FCC 47 CFR Part 15 Subpart B Class A (US), ICES-003 (Canada), EN 55032 (ITE Emissions), EN 55024 (ITE Immunity), EN 61000-3-2 (Harmonics), EN 61000-3-3 (Flicker), 2014/30/EU (EMC Directive), EN 300 386 (Telecom), EN 55011 (ISM), EN 61000-6-2 (Ind. Immunity), EN 61000-6-4 (Ind. Emissions), RCM (Australia), VCCI (Japan), MSIP KCC (Korea), BSMI (Taiwan), ANATEL (Brazil), CCC (China).

### VCCI Notice

This is a Class A product based on the standard of the Voluntary Control Council for Interference by Information Technology Equipment (VCCI). If this equipment is used in a domestic environment, radio disturbance may arise. When such trouble occurs, the user may be required to take corrective actions.

この装置は、クラスA情報技術装置です。この装置を家庭環境で使用すると電波妨害を引き起こすことがあります。この場合には使用者が適切な対策を講ずるよう要求されることがあります。

VCCI-A

### BSMI EMC Statement — Taiwan

This is a Class A product. In a domestic environment this product may cause radio interference in which case the user may be required to take adequate measures.

警告使用者:

此為甲類資訊技術設備，於居住環境中使用時，可能會造成射頻

擾動，在此種情況下，使用者會被要求採取某些適當的對策。

警告使用者:

此为A级产品，在生活环境中，该产品可能会造成无线电干扰。

在这种情况下，可能需要用户对干扰采取切实可行的措施。

### Battery Warning — Taiwan

警告

如果更換不正確之電池型式會有爆炸的風險，

請依製造商說明書處理用過之電池。



### Battery Notice

**Warning:** This product contains a battery used to maintain product information. If the battery should need replacement it must be replaced by Service Personnel. Please contact Technical Support for assistance. Risk of explosion if battery is replaced by an incorrect type. Dispose of expended battery in accordance with local disposal regulations. **Avvertimento:** Ce produit renferme une pile servant à conserver les renseignements sur le produit. Le cas échéant, faites remplacer la pile par le personnel du service de réparation. Veuillez communiquer avec l’assistance technique pour du soutien. Il y a risque d’explosion si la pile est remplacée par un type de pile incorrect. Éliminez les piles usées en conformité aux règlements locaux d’élimination des piles.

### Hazardous Substances- China and Taiwan BSMI RoHS

Guidance concerning the China and Taiwan BSMI RoHS (Restriction of Hazardous Substances) directive for this Extreme Networks® product can be found on the following web page:

[www.extremenetworks.com/support/documentation/restriction-hazardous-substances/](http://www.extremenetworks.com/support/documentation/restriction-hazardous-substances/)

The page contains tables detailing the presence of 10 substances defined by the RoHS directive.

### Hazardous Substances - EU

This product complies with the requirements of Directive 2011/65/EU of the European Parliament and of the Council of 8 June 2011 on the restriction of the use of certain hazardous substances in electrical and electronic equipment.

### European Waste Electrical and Electronic Equipment (WEEE) Notice



In accordance with Directive 2012/19/EU of the European Parliament on waste electrical and electronic equipment (WEEE):

- 1** The symbol above indicates that separate collection of electrical and electronic equipment is required.
- 2** When this product has reached the end of its serviceable life, it cannot be disposed of as unsorted municipal waste. It must be collected and treated separately.
- 3** It has been determined by the European Parliament that there are potential negative effects on the environment and human health as a result of the presence of hazardous substances in electrical and electronic equipment.
- 4** It is the users’ responsibility to utilize the available collection system to ensure WEEE is properly treated. For information about the available collection system, please contact Extreme Customer Support at +353 61 705500 (Ireland).

P/N 121148-00