



ExtremeCloud Edge - Managed Orchestration Deployment Guide

for Universal Compute Platform Version 5.07.01

9038935-00 Rev. AB
July 2024



Copyright © 2024 Extreme Networks, Inc. All rights reserved.

Legal Notice

Extreme Networks, Inc. reserves the right to make changes in specifications and other information contained in this document and its website without prior notice. The reader should in all cases consult representatives of Extreme Networks to determine whether any such changes have been made.

The hardware, firmware, software or any specifications described or referred to in this document are subject to change without notice.

Trademarks

Extreme Networks and the Extreme Networks logo are trademarks or registered trademarks of Extreme Networks, Inc. in the United States and/or other countries.

All other names (including any product names) mentioned in this document are the property of their respective owners and may be trademarks or registered trademarks of their respective companies/owners.

For additional information on Extreme Networks trademarks, see: <https://www.extremenetworks.com/about-extreme-networks/company/legal/trademarks>

Open Source Declarations

Some software files have been licensed under certain open source or third-party licenses.

End-user license agreements and open source declarations can be found at: <https://www.extremenetworks.com/support/policies/open-source-declaration/>



Table of Contents

Preface.....	5
Text Conventions.....	5
Documentation and Training.....	6
Open Source Declarations.....	7
Training.....	7
Help and Support.....	7
Subscribe to Product Announcements.....	8
Send Feedback.....	8
Revision History.....	8
Introduction and Prerequisites.....	9
ExtremeCloud Edge.....	11
Service Set 1: Cluster Administration, Account Access (https), CAPWAP Master, Diagnostics.....	12
Service Set 2: AP Registration/CAPWAP Load Balancing.....	12
Service Set 3: AP Registration/CAPWP Load Balancing.....	13
Service Set 4: AP Registration/CAPWP Load Balancing.....	13
Firewall Setup.....	14
Deployment Overview.....	15
Customer On-Site Representative.....	15
Extreme CloudOps.....	15
Universal Compute Platform Administrator.....	15
Supported Hardware for Managed Orchestration.....	16
Prerequisites for ExtremeCloud Edge Installation.....	17
IP Addresses.....	18
VRRP Configuration.....	18
Inter-Cluster VRRP Configuration.....	19
Services VRRP Configuration.....	19
Reserved IP Addressing.....	20
Port Information for Firewalls.....	20
Basic Access for ExtremeCloud Services.....	20
Access.....	21
Access for Production Sanity Verification.....	22
Source Address Information.....	23
Configure an Appliance.....	25
Basic Configuration Wizard.....	25
Use the Basic Configuration Wizard.....	26
Upgrade the Appliance Software.....	30
IP Address Configuration.....	32

Configure VRRP (VIP).....	33
Configure the Cluster Settings.....	35
Select an Engine.....	37
Install an Engine Instance.....	37
Network Service Configuration.....	38
Validate the Cluster.....	39
Onboard Cluster to ExtremeCloud IQ.....	40
Onboarding a Cluster to ExtremeCloud IQ	41
Account Registration.....	43
Cloud Visibility.....	43
Appendix A: Migrate Virtual IQ Account.....	44
Export VIQ Account.....	44
Import VIQ Account.....	45
Appendix B: Replace or Add a Node.....	46
Prepare to Replace a Node.....	46
Replace a Node.....	47
Add Node.....	47
Index.....	49

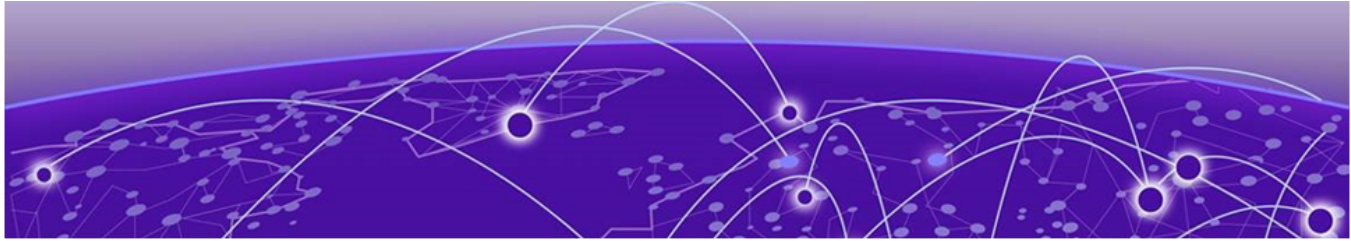

Preface

Read the following topics to learn about:

- The meanings of text formats used in this document.
- Where you can find additional information and help.
- How to reach us with questions and comments.

Text Conventions

Unless otherwise noted, information in this document applies to all supported environments for the products in question. Exceptions, like command keywords associated with a specific software version, are identified in the text.

When a feature, function, or operation pertains to a specific hardware product, the product name is used. When features, functions, and operations are the same across an entire product family, such as Extreme Networks switches or SLX routers, the product is referred to as *the switch* or *the router*.

Table 1: Notes and warnings





Icon	Notice type	Alerts you to...
	Tip	Helpful tips and notices for using the product
	Note	Useful information or instructions
	Important	Important features or instructions
	Caution	Risk of personal injury, system damage, or loss of data
	Warning	Risk of severe personal injury

Table 2: Text

Convention	Description
screen displays	This typeface indicates command syntax, or represents information as it is displayed on the screen.
The words <i>enter</i> and <i>type</i>	When you see the word <i>enter</i> in this guide, you must type something, and then press the Return or Enter key. Do not press the Return or Enter key when an instruction simply says <i>type</i> .
Key names	Key names are written in boldface, for example Ctrl or Esc . If you must press two or more keys simultaneously, the key names are linked with a plus sign (+). Example: Press Ctrl+Alt+Del
Words in italicized type	Italics emphasize a point or denote new terms at the place where they are defined in the text. Italics are also used when referring to publication titles.
NEW!	New information. In a PDF, this is searchable text.

Table 3: Command syntax

Convention	Description
bold text	Bold text indicates command names, keywords, and command options.
<i>italic text</i>	Italic text indicates variable content.
[]	Syntax components displayed within square brackets are optional. Default responses to system prompts are enclosed in square brackets.
{ x y z }	A choice of required parameters is enclosed in curly brackets separated by vertical bars. You must select one of the options.
x y	A vertical bar separates mutually exclusive elements.
< >	Nonprinting characters, such as passwords, are enclosed in angle brackets.
...	Repeat the previous element, for example, <i>member [member...]</i> .
\	In command examples, the backslash indicates a “soft” line break. When a backslash separates two lines of a command input, enter the entire command at the prompt without the backslash.

Documentation and Training

Find Extreme Networks product information at the following locations:

[Current Product Documentation](#)

[Release Notes](#)

[Hardware and Software Compatibility](#) for Extreme Networks products

[Extreme Optics Compatibility](#)

[Other Resources](#) such as articles, white papers, and case studies

Open Source Declarations

Some software files have been licensed under certain open source licenses. Information is available on the [Open Source Declaration](#) page.

Training

Extreme Networks offers product training courses, both online and in person, as well as specialized certifications. For details, visit the [Extreme Networks Training](#) page.

Help and Support

If you require assistance, contact Extreme Networks using one of the following methods:

Extreme Portal

Search the GTAC (Global Technical Assistance Center) knowledge base; manage support cases and service contracts; download software; and obtain product licensing, training, and certifications.

The Hub

A forum for Extreme Networks customers to connect with one another, answer questions, and share ideas and feedback. This community is monitored by Extreme Networks employees, but is not intended to replace specific guidance from GTAC.

Call GTAC

For immediate support: (800) 998 2408 (toll-free in U.S. and Canada) or 1 (408) 579 2800. For the support phone number in your country, visit www.extremenetworks.com/support/contact.

Before contacting Extreme Networks for technical support, have the following information ready:

- Your Extreme Networks service contract number, or serial numbers for all involved Extreme Networks products
- A description of the failure
- A description of any actions already taken to resolve the problem
- A description of your network environment (such as layout, cable type, other relevant environmental information)
- Network load at the time of trouble (if known)
- The device history (for example, if you have returned the device before, or if this is a recurring problem)
- Any related RMA (Return Material Authorization) numbers

Subscribe to Product Announcements

You can subscribe to email notifications for product and software release announcements, Field Notices, and Vulnerability Notices.

1. Go to [The Hub](#).
2. In the list of categories, expand the **Product Announcements** list.
3. Select a product for which you would like to receive notifications.
4. Select **Subscribe**.
5. To select additional products, return to the **Product Announcements** list and repeat steps 3 and 4.

You can modify your product selections or unsubscribe at any time.

Send Feedback

The User Enablement team at Extreme Networks has made every effort to ensure that this document is accurate, complete, and easy to use. We strive to improve our documentation to help you in your work, so we want to hear from you. We welcome all feedback, but we especially want to know about:

- Content errors, or confusing or conflicting information.
- Improvements that would help you find relevant information.
- Broken links or usability issues.

To send feedback, email us at documentation@extremenetworks.com.

Provide as much detail as possible including the publication title, topic heading, and page number (if applicable), along with your comments and suggestions for improvement.

Revision History

Revision	Date	Description
AA	26 June 2024	Initial publish for 5.07.01
AB	25 July 2024	<ul style="list-style-type: none"> • Updated port assignment tables for all four service sets in <i>ExtremeCloud Edge</i> section. • Removed <code><rdc>-inlets</code> entry from <i>Inbound Traffic Port Mapping (when using NAT)</i> table. The inlets ports are covered within the four Service Set port tables in <i>ExtremeCloud Edge</i>.

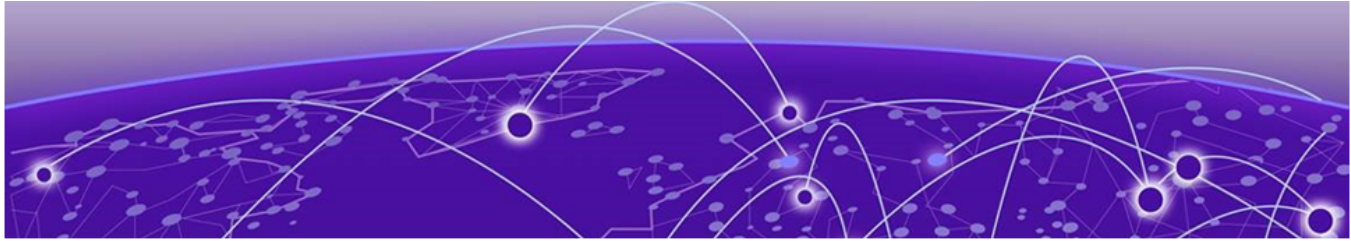

Introduction and Prerequisites

This guide provides the steps needed to bring a Universal Compute Platform cluster online. Universal Compute Platform leverages Kubernetes and Docker to deploy and manage the delivery of applications to the customer premises.

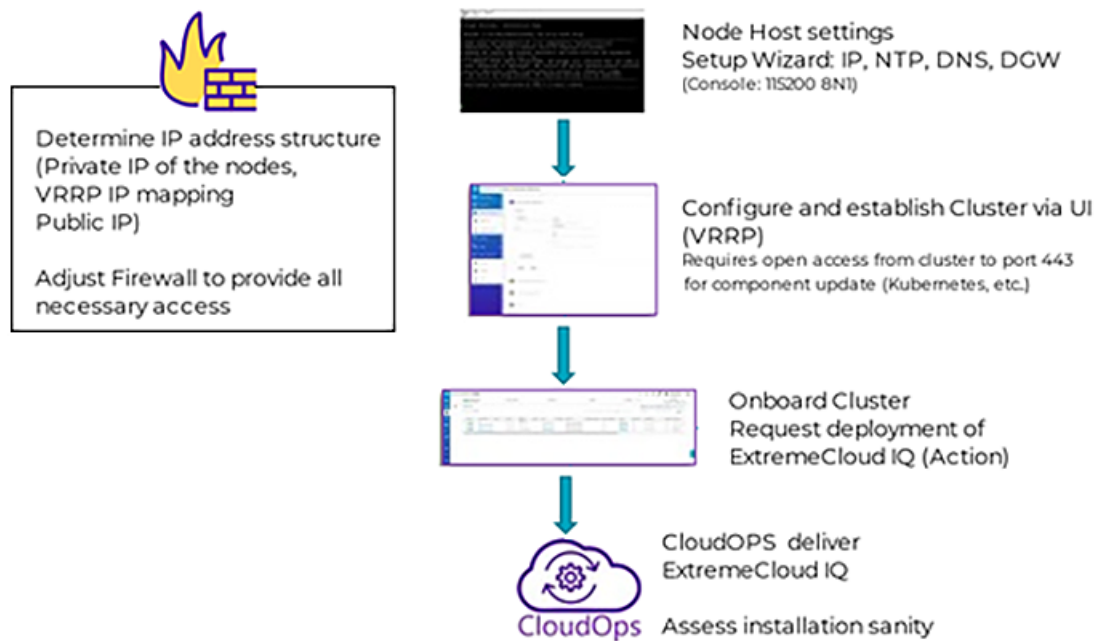
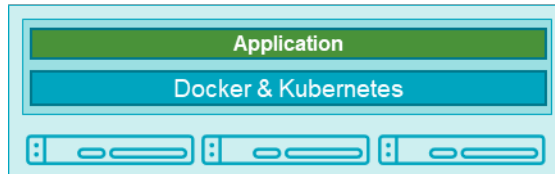

Figure 1: ExtremeCloud IQ Deployment Workflow

The following figure depicts the three physical host boxes required for Universal Compute Platform, with ports mapped as follows:



As an option, the system leverages VRRP (Virtual Router Redundancy Protocol) to provide support for both high-availability and load balancing, supported by an NGINX engine. All service operations to the cluster should be directed to the corresponding VRRP IP so that the load balancing logic can direct the request to the best node.

Deployment configuration requirements vary over different applications deployed into the Universal Compute Platform. One main requirement in the establishment and operation of the cluster is the Inter-Cluster Connection. This connection operates as the backplane between nodes in the cluster. This backplane carries all the synchronization data between nodes for both component and data states. It is a best practice to deploy the interface as a segregated 10 Gbps inter-connect (separate switch port), allowing for the best performance in synchronization between nodes.

- Inter-Cluster Connection: Backend interaction and synchronization between all the members of a cluster. Minimum required connection requires 10 Gbps between nodes.
- The internal Kubernetes engine requires the reservation of two (2x) /16 subnets. This set of IP Address ranges is for internal use only by inter-component and framework operations. This reserved range can be anything, but customer should ensure that this IP address range does not conflict with any routable address space within the organization.

Related Topics

[ExtremeCloud Edge](#) on page 11



ExtremeCloud Edge

This guide outlines the steps required to prepare a cluster environment that will support deployment of ExtremeCloud Edge applications to the customers' premises.

Minimum Requirements for Installation

- 4 Public IP addresses exposed via the firewall and port-forwarded to the internal service sets
- Firewall adjustments to allow communication of system functions to external entities (licensing, component upgrades, device management) and CloudOPS access for lifecycle management of the installed applications/software. Please refer to section [Firewall Setup](#) on page 14.
- 6 x 4120C-1 Universal Compute Platform appliances configured as a cluster.
- Network Connectivity for the hosts both in backplane (ICC) and application data operations (data ports). 10 Gbps minimum links recommended.
- ICC: Interconnect (backplane) for cluster operations, component state and shared filesystem synchronization. Each node requires connection of ICC to common backplane network segment.
- Data: Interfaces that the applications will utilize with other devices or systems for operation management, such as remote device management (Access Points, Switches, etc..) and license services. Data interface is also utilized for remote lifecycle management of installed software.

Application requirements for the cluster configuration:

- 4 IP addresses representing the various services offered by the application to effectuate load balancing (Service Set 1 – 4).
- Each node in the cluster must map each of the services to a data interface, and all services can be mapped into the same interface. The same data interface can represent a direct point of reference for each of the front-end VRRP services.
- Four VRRP IP address are required to support port-overlap services for different services or a functional model (such as CAPWAP Master vs CAPWAP Server).

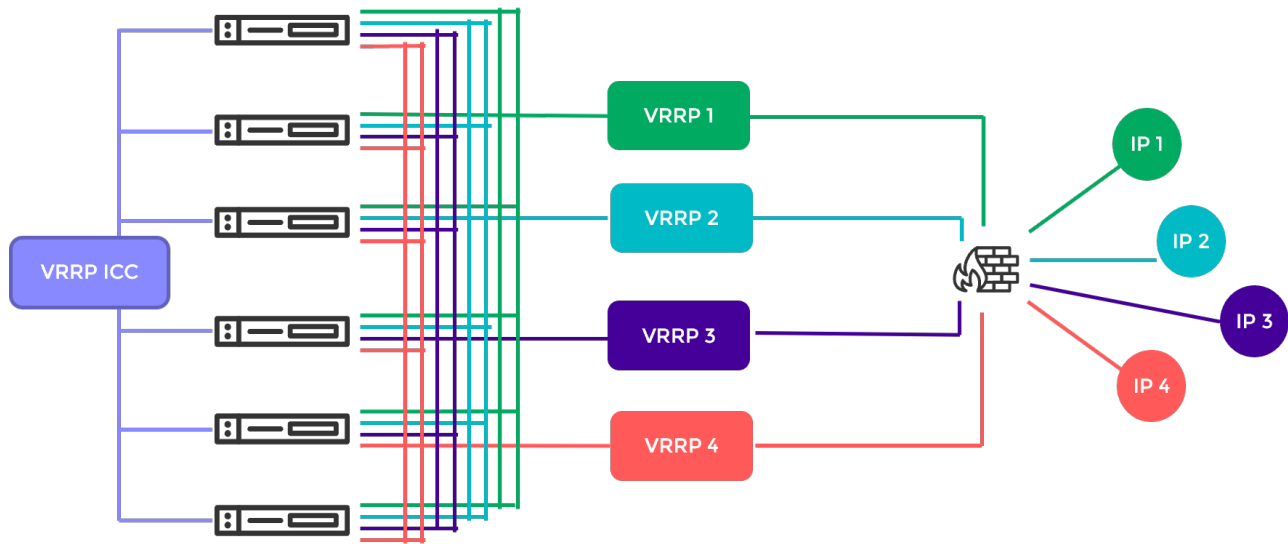

Service Set 1: Cluster Administration, Account Access (https), CAPWAP Master, Diagnostics

Table 4: Example port assignments for Service Set 1

Port	Protocol	Service	Description
80	TCP	CAPWAP	CAPWAP Master
443	TCP	NGINX	ExtremeCloud IQ Admin, software management
1443	TCP	XAPI	ExtremeCloud IQ API
2083	TCP	IDM	IDM Auth
12222	TCP	CAPWAP	CAPWAP Master

Service Set 2: AP Registration/CAPWAP Load Balancing

Table 5: Example port assignments for Service Set 2

Port	Protocol	Service	Description
80	TCP	CAPWAP	CAPWAP Master
443	TCP	SD-WAN	SD-WAN Communicator
5825	TCP	Inlets	Device Communication
8090	TCP	Inlets	Device Communication
9090	TCP	SD-WAN	SD-WAN Communicator
12222	TCP	CAPWAP	CAPWAP Master

Service Set 3: AP Registration/CAPWP Load Balancing

Table 6: Example port assignments for Service Set 3

Port	Protocol	Service	Description
80	TCP	CAPWAP	CAPWAP Master
443	TCP	SD-WAN	SD-WAN Communicator
12222	TCP	CAPWAP	CAPWAP Master

Service Set 4: AP Registration/CAPWP Load Balancing

Table 7: Example port assignments for Service Set 4

Port	Protocol	Service	Description
80	TCP	CAPWAP	CAPWAP Master
443	TCP	NGINX	ExtremeCloud GDC access
1443	TCP	XAPI	ExtremeCloud IQ API
1444	TCP	API	GDC API
1445	TCP	License	ExtremeCloud IQ License Management
12222	TCP	CAPWAP	CAPWAP Master

Related Topics

[Firewall Setup](#) on page 14

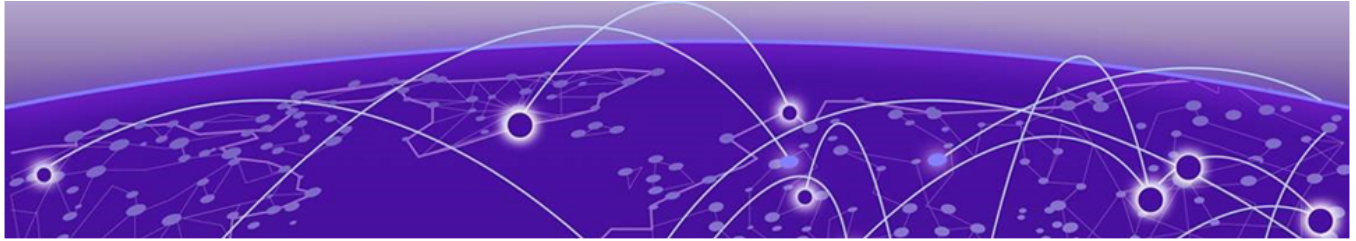

Firewall Setup

In a typical on-premise installation, the cluster is installed behind an access firewall, providing network address translations between the public and private address spaces. Always allow access for CloudOps management of the cluster. The standard deployment of ExtremeCloud Edge requires 4 Public IP addresses to front-end the installation. They are mapped to forward traffic into the four VRRP IP addresses of the service sets.

During system setup, the following configuration settings are critical to the deployment:

- **Default Gateway:** Each node in the cluster supports a single default gateway (0.0.0.0/0) definition. This gateway must be mapped to a next-hop attached on the data port interface.



Note

Do not configure the default gateway to map to the Inter-Cluster Connection (ICC) interface. The ICC is an internal connection between systems that is not used for management or operation of the cluster.

- **DNS server:** At least one reachable DNS server must be configurable, allowing the system to resolve several URLs during installation and interaction with ExtremeCloud IQ and CloudOps functions.
- **Network Time Protocol (NTP) Servers:** At least one reachable NTP, allowing the system to synchronize its time with a trusted time source. The same NTP must be configured, in the same order, on all nodes in the cluster.

A best practice is to have two NTP definitions to support availability of the primary server. If there is an issue with the primary server, the system resorts to the alternate server.



Deployment Overview

[Supported Hardware for Managed Orchestration](#) on page 16

This topic outlines the key deployment responsibilities for deploying ExtremeCloud Edge on Universal Compute Platform. Each of the following components have unique responsibilities:

- Customer On-Site Representative
- Extreme CloudOPS
- System Administrator of Universal Compute Platform

Customer On-Site Representative

Customer On-Site Representatives are responsible for the following tasks:

- Set up a firewall that enables cluster access to the appropriate internet ports (for example, port 443) and enables CloudOps access. Follow the firewall configuration guidelines under [Firewall Setup](#) on page 14.
- Configure each node for service — Provide the necessary IP, DNS, and Host addresses, ICC Configure and form cluster (VRRP).
- Register the cluster with an ExtremeCloud IQ Public account.
- Register an ExtremeCloud IQ deployment request. The request requires a valid XIQ-EDGEOPS-S-EW in good standing. This SKU is a required component of an ExtremeCloud Edge BOM quote.

For detailed information, see [Introduction and Prerequisites](#) on page 9.

Extreme CloudOps

ExtremeCloud IQ CloudOps is responsible for the following tasks:

- Deploy ExtremeCloud applications (ExtremeCloud IQ, etc.) to the Universal Compute Platform cluster.
- Create monitoring and backup frameworks.
- Validate the state of all operational components.

Universal Compute Platform Administrator

Universal Compute Platform Administrators are responsible for the following tasks:

- Create ExtremeCloud IQ user accounts for end-device management.

- Onboard managed devices from the ExtremeCloud IQ local account.

NEW! Supported Hardware for Managed Orchestration

ExtremeCloud Edge - Managed Orchestration deployments of Universal Compute Platform support the following hardware appliances.

Table 8: Supported Hardware for ExtremeCloud Edge - Managed Orchestration

Hardware Appliance	Details
4120C-1	Ports: <ul style="list-style-type: none">• 2 x 1/10 Gbps ICC Ports/RJ45• 2 x 1/10 Gbps Data 1-2/ RJ45• 2 x 1/10/25/40/50 Gbps Data 3-4/QSFP



Prerequisites for ExtremeCloud Edge Installation

[IP Addresses](#) on page 18

[VRRP Configuration](#) on page 18

[Reserved IP Addressing](#) on page 20

[Port Information for Firewalls](#) on page 20

Address planning is the fundamental step in successful deployment of the Universal Compute Platform to support installing ExtremeCloud applications such as ExtremeCloud IQ. It is important to understand the following:

- Decide how you will deploy and access the services offered by the cluster. Is the cluster going to serve applications that operate only within the on-premises installation? Or is application access going to require external access? Pre-determination of the IP address and connectivity structure are fundamental to a successful deployment. These deployment decisions drive the configuration choices.
- Consider the address plan of the installation, including how the cluster is going to be presented externally via a firewall.

Each externally exposed address must be mapped to an internal VRRP of the cluster. You can either directly expose the VRRP IP addresses for the three service sets directly through a firewall, or in the case of NAT translation, ensure that the externally available IP addresses are mapped 1:1 to the internal services, and that the corresponding application ports are allowed for access (per firewall rules definition).



Important

Before you begin step-by-step configuration, make sure that you clearly understand and document all the elements of the network presence and topology related to the deployment.

The Inter-Cluster Connection (ICC) IP address is critical to the continuous operation of the system. If address definitions for ICC require re-addressing, the entire cluster will need to be rebuilt and the application re-deployed in order to re-establish all the correct references of services within the cluster.

It is strongly recommended that the *entire* IP address structure for all services be defined once and not changed. Re-addressing can expose internal dependencies on references to mapped services and therefore affect the integrity and stability of the deployed installation.

IP Addresses

The most important point of definition is to record the IP address relationship between the cluster's direct interfaces (Node, Service Set, Virtual IP address (VIP)), and external access. Each node has its own data interface IP address.

Table 9: IP address relationship between the cluster's direct interfaces and external access

Service Set	Virtual IP (VIP)	Public IP
Service Set 1 (cmudp, cmtcp, cmauth, https)	<i>VIP 1</i>	<i>Public IP 1</i>
Service Set 2 (csudp1, cstcp1)	<i>VIP 2</i>	<i>Public IP 2</i>
Service Set 3 (csudp2, cstcp2)	<i>VIP 3</i>	<i>Public IP 3</i>
Service Set 4 (csudp3, cstcp3)	<i>VIP 4</i>	<i>Public IP 4</i>

VRRP Configuration

In support of load balancing and high-availability functions, the Universal Compute Platform relies on Virtual Router Redundancy Protocol (VRRP) to provide IP abstraction to key functionality. VRRP is critical in the configuration model.

The following operation settings must be defined as part of the VRRP configuration of member nodes:

- **Priority**— VRRP uses priority settings as a mechanism to arbitrate mastery of the state of exchanges across members of the cluster.

The node with the higher priority defaults to the master. However, in the case of failovers of the master node, VRRP algorithms assign mastery to the next higher priority member of the cluster. Therefore, it is important to properly assign corresponding priority settings to each node, so that their hierarchical priority in terms of VRRP state ownership is clear.

As a best practice:

- Designate node 1 as the highest priority, node 2 for second highest priority, and nodes 3-6 as lower priority.
- The same priority should be used across all services (ICC, Services)
- **RouterID** — This setting allows segmentation of a routing domain, and it is important to separate from any other VRRP uses on the same network segment. The assigned value is arbitrary, but the value must not overlap when another VRRP usage is visible in the attached network segments.

Inter-Cluster VRRP Configuration

An Inter-Cluster Connection refers to the back-end interaction and synchronization between all the members of a cluster. Minimum required connection requires 10 Gbps between nodes.

Table 10: Inter-Cluster Connection VRRP Configuration

	Nodes 1 -6 (Port #)
ICC	<ul style="list-style-type: none"> Node 1 ICC IP /CIDR Node 2 ICC IP/CIDR Node 3 ICC IP/CIDR Node 4 ICC IP/CIDR Node 5 ICC IP/CIDR Node 6 ICC IP/CIDR
VLAN	VLAN Tagged/Untagged
Port type	Physical
VRRP	
VRRP IP addresses	ICC VRRP IP
Priority	Set a unique priority for each node. For example: <ul style="list-style-type: none"> Highest (200) Next (150) Medium (100) Next (75) Next (50) Low (25)
Router ID	ID (2)

Services VRRP Configuration

The VRRP configuration relates to the number of services you are exposing. Configure a VRRP IP address (VIP) for each service.

Table 11: Services VRRP Configuration

	Nodes 1-6 (Port #)
Data Port	Node Port IP /CIDR. Unique Port IP for each node.
VLAN	VLAN Tagged/Untagged
Port type	Physical
VRRP	
VRRP IP address (VIP)	6 VIP addresses. Unique VIP for each node
Priority	Unique priority value for each VIP
Router ID	ID (1)

Reserved IP Addressing

Container orchestration by Kubernetes within the cluster requires reservation of private network segments for each Pod. Plan for network segmentation regardless of your deployment mode.



Note

Review the default IP range values for your pod and service networks in the following table. Use them if they are suitable and do not conflict with the deployed infrastructure network routing definitions. If there is a conflict, adjust the segment IP range as required.

Table 12: IP Address range for network segmentation

Restricted IP Range	Default Value	IP Address /Range
Pod Network IP Range	10.96.0.0/16	<reserved ip>/16
Service Network IP Range	10.97.0.0/16	<reserved ip>/16

VRRP operations require visual representation of where the IP addresses are allocated.

Port Information for Firewalls

Map the following service ports to the Service Set VRRP IP addresses listed in [Table 9](#) on page 18.

- VLAN/VIP address for CAPWAP Master and API services (TCP 80/UDP 12222/TCP 2083/443)
- VLAN/VIP address for CAPWAP Server 1 service (TCP 80/UDP 12222)
- VLAN/VIP address for CAPWAP Server 2 (TCP 80/UDP 12222)

ExtremeCloud IQ on-premises installations require access to ExtremeCloud IQ core services. Make sure the firewall configuration allows for access to ExtremeCloud IQ core services.

The following tables list outbound ports for use when the firewall configuration requires rules that enable outbound traffic.

Basic Access for ExtremeCloud Services

This is required for ExtremeCloud applications to run properly on ExtremeCloud Edge RDC.

Table 13: Firewall Configuration Details (Outbound Traffic)

Domain Name	IPv4 Addresses	Protocol	Port
hac.extremecloudiq.com	34.253.190.192 ~ 34.253.190.255	HTTPS	443
<rdc>-inlets.extremecloudiq.com	Dynamic IP range	TCP	8090
hmupdates-ng.aerohive.com	54.86.95.132	HTTPS	443

Table 13: Firewall Configuration Details (Outbound Traffic) (continued)

Domain Name	IPv4 Addresses	Protocol	Port
extremecloudiq.com	34.253.190.192 ~ 34.253.190.255	HTTPS	443
	18.194.95.0 ~ 18.194.95.15		
	3.234.248.0 ~ 3.234.248.31		
	44.234.22.92 ~ 44.234.22.95		
mx.extremecloudiq.com	34.202.197.56/57	TCP	587
stun.extremecloudiq.com	3.234.248.28 - 29	UDP	12222
api.ip2location.com	Dynamic IP range	HTTPS	443
docker.io	Dynamic IP range	HTTPS	443
gcr.io	Dynamic IP range	HTTPS	443
maven.org	Dynamic IP range	HTTPS	443
Amazon S3	Dynamic IP range	HTTPS	443
NTP Service	<Any NTP Server IP>	UDP/TCP	123
extremeportal.force.com	Dynamic IP range	HTTPS	443
prod.extreme.sentinelcloud.com	Dynamic IP range	HTTPS	443
cloud-status.extremecloudiq.com	18.67.39.6	HTTPS	443
cloud-cdn2.extremecloudiq.com	Dynamic IP range	HTTPS	443
rest.nexmo.com	Dynamic IP range	HTTPS	443

Access

Table 14: Outbound Traffic

Domain Name	IPv4 Addresses	Protocol	Port
lc-eu.extremecloudiq.com	3.64.95.0/29	HTTPS	443

**Note**

Rancher connection is required for day-to-day service operation. (It creates a tunnel to Kubernetes cluster for CloudOps remote access/management.)

For NAT deployments where you deploy your cluster with private addressing, you must provide the CloudOps team with direct admin access to the cluster nodes in your

internal network. Use the mappings in the following table to map inbound ports on the public side of the NAT router to specific cluster nodes and ports in your private network.



Note

Make sure to let the CloudOps team know which IP address you are using for inbound connections. As a best practice, use the first public IP address, although you can use another address, including a public IP address that is dedicated to this connection type.

Table 15: Inbound Traffic Port Mapping (when using NAT)

Service	Source IP	Inbound IP (public NAT)	Inbound Port (public NAT)	Forward to UCP Node	On Port	Protocol
SSH	Restricted IP list Extreme Bastion servers: <ul style="list-style-type: none"> • Raleigh Bastion Host 134.141.117.45/32 • Salem Bastion Host 134.141.4.8/32 	Your public IP address	20001	Node 1	22	TCP
			20002	Node 2	22	TCP
			20003	Node 3	22	TCP
			20004	Node 4	22	TCP
			20005	Node 5	22	TCP
			20006	Node 6	22	TCP
UCP Remote Access	<ul style="list-style-type: none"> • San Jose: 208.185.247.165 • Thornhill: 216.123.81.194 • Bangalore AMR: 14.143.116.18 • Bangalore Bagmane: 121.244.44.28 • Bangalore Ecospace: 115.110.157.126 • LC-EU: 3.64.95.7 	Your public IP address	20501	Node 1	5825	HTTPS
			20502	Node 2	5825	HTTPS
			20503	Node 3	5825	HTTPS
			20504	Node 4	5825	HTTPS
			20505	Node 5	5825	HTTPS
			20506	Node 6	5825	HTTPS



Note

For SSH or UCP Remote access, inbound access is needed only on-demand for the initial deployment, software upgrade, or issue troubleshooting. For <rdc>-inlets, inbound access is needed on an ongoing basis.

Access for Production Sanity Verification

The Extreme QA team will run production santify verification after the release upgrade to make sure all of the services are still working properly. The following table shows the

connection info they'll use, including the public-facing IPs from which they'll connect (column 1) and the destination ports mappings to access the cluster (column 5).

Table 16: Inbound Traffic

Source IPs	Protocol	IP Port	Description	Destination Port Mapping
Restricted IP list Extreme Bastion servers:	HTTPS (TCP)	443	GDC Web Service RDC Web Service	IP1:443 → VRRP1:443 IP4:443 → VRRP4:443
<ul style="list-style-type: none"> • Raleigh Bastion Host 134.141.117.45/32 • Salem Bastion Host 134.141.4.8/32 • San Jose: 208.185.247.165 • Thornhill: 216.123.81.194 • Bangalore AMR: 14.143.116.18 • Bangalore Bagmane: 121.244.44.28 • Bangalore Ecospace: 115.110.157.126 • LC-EU: 3.64.95.7 	TCP	80	CAPWAP Services	IP1:80 → VRRP1:80 IP2:80 → VRRP2:80 IP3:80 → VRRP3:80 IP4:80 → VRRP4:80
	UDP	12222	CAPWAP Services	IP1:12222 → VRRP1:12222 IP2:12222 → VRRP2:12222 IP3:12222 → VRRP3:12222 IP4:12222 → VRRP4:12222
	TCP	2083	RADSEC Proxy	IP1:2083 → VRRP1:2083

Related Topics

[Source Address Information](#) on page 23

Source Address Information

For installations where APs are installed off-premises and connecting for service through a firewall, relax the access rules to specific service ports because source addresses are not always deterministic.

These settings are required to support remote diagnostics and to set up validation operations.

Table 17: Source address information (examples):

Source IP	Port	Description	Action
0.0.0.0/0	TCP 80	AP CAPWAP registration	Allow
0.0.0.0/0	TCP 443	ExtremeCloud IQ login access and software updates	Allow
0.0.0.0/0	TCP 2083	RADSEC	Allow
0.0.0.0/0	UDP 12222	AP CAPWAP	Allow

Table 17: Source address information (examples): (continued)

Source IP	Port	Description	Action
Restricted IP list	TCP 22	Support SSH Access	Allow
Extreme Bastion servers: <ul style="list-style-type: none">• Raleigh Bastion Host 134.141.117.45/32• Salem Bastion Host 134.141.4.8/32• San Jose: 208.185.247.165• Thornhill: 216.123.81.194• Bangalore AMR: 14.143.116.18• Bangalore Bagmane: 121.244.44.28• Bangalore Ecospace: 115.110.157.126	TCP 5825	Cluster Admin GUI. Remote diagnostics	Allow



Configure an Appliance

[Basic Configuration Wizard](#) on page 25

[Upgrade the Appliance Software](#) on page 30

[IP Address Configuration](#) on page 32

Deployment of a Universal Compute Platform appliance involves the following steps:

1. Connect the hardware appliance to the network.
2. Run the [Basic Configuration Wizard](#) to deploy a fully-functioning appliance on a network.
3. [Upgrade](#) the Universal Compute Platform appliance software to the latest revision.
4. Validate the network settings and configure additional data plane interfaces if necessary.
5. Configure the Universal Compute Platform cluster creation.
6. Run the Readiness Assessment to test whether your planned configuration works.
7. Install and deploy the engine applications.

After the engine application is deployed, refer to the [documentation](#) for the individual application for information on how to manage your network with that application.

Basic Configuration Wizard

The Universal Compute Platform software provides a **Basic Configuration Wizard** that can help administrators configure the minimum settings necessary to deploy a fully functioning appliance on a network.

Administrators can use the wizard to quickly configure the appliances for deployment, and then after the installation is complete, continue to revise the configuration accordingly.

The wizard is automatically launched when an administrator logs on to the appliance for the first time, including after the system has been reset to the factory default settings.

The configuration wizard prompts with a set of **Yes** or **No** questions. The default value is indicated in parenthesis. To accept the default value, press **Enter**.

Related Topics

[Use the Basic Configuration Wizard](#) on page 26

Use the Basic Configuration Wizard

After logging into the appliance, the **Basic Configuration Wizard** displays. You are presented a set of **Yes** or **No** commands.

1. To begin the Admin password setup, press **Enter**. The **Admin Password Configuration** screen is displayed.

The following is the default factory settings for a Universal Compute Platform appliance:

- The default username is: admin
- The default password is: abc123



Note

The values are case-sensitive.

- a. To change the password for the admin account, press **Enter**.
- b. Enter the new password for the admin account.



Note

The password must be between 8-24 characters.

- c. Repeat the new password for the admin account and press **Enter**.

If the passwords match, the password gets accepted, and the ICC1 configuration is displayed.

```
-----
Press [enter] to begin setup or CTRL-C to exit: <enter>
-----
Admin password Configuration
Change the password for the 'admin' account?(y/n)[y]:
Enter the new password for the 'admin' account:
Repeat the new password for the 'admin' account:
The passwords do not match.
The password you have entered is incorrect.
Enter the new password for the 'admin' account:
Repeat the new password for the 'admin' account:
Password accepted
Do you accept these changes?(y/n)[y]y
ICCl Port IP Address: 192.168.10.1
ICCl Port Netmask: 255.255.255.0
ICCl Port VRRP IP address:
ICCl Port VRRP Priority: 100
ICCl Port VRRP Router Id: 1

Please enter the IP address for ICCl Port[192.168.10.1]:
```

Figure 2: Basic Configuration Wizard - ICC1 Configuration

2. To update the ICC1 (Admin Port):

Use the information gathered under [ExtremeCloud Edge](#) on page 11 and accept the changes.

- Enter the new IP address of the ICC1 Admin Port.
- Enter the new IP netmask for the ICC1 port.
- Do you you want to configure VRRP? Type *y* or *n* and press **Enter**. If you chose *y*, enter the ICC1 VRRP details.
- Do you want to enable LAG on ICC1? Type *y* or *n* and press **Enter**.

3. Press **Enter** to accept the changes.



Note

If you need to reconfigure the ICC1 settings, enter *n* and enter a new IP address of the ICC 1 Admin Port.

4. Go to Data Port configuration.

Current Data Port Settings

After you set up the **Admin Password configuration**, you are prompted to set up the **Current Data Port Settings**:

1. Change Port 1 settings: Select the number that corresponds to the port you will configure as the data port, and press **Enter**.
2. Set the default IP address for the data port **10.0.0.1**, or type a new IP address and press **Enter**.

The IP Address is selected.

3. Set the Netmask to the default **255.255.255.0**, or provide a new IP address and press **Enter**.

The Netmask is set.

4. Default VLAN: Set the default VLAN ID, or provide a new VLAN ID and press **Enter**.
5. Tagged Frames: Set the tagged frames to **No**, or type *y* to set tagged frames.
6. Management Traffic (admin interface): Set *y* to enable management traffic on the interface, or type *n* to not enable management traffic, and press **Enter**.
7. To accept the changes and keep the data port settings you have chosen, press **Enter**.



Note

If you need to reconfigure the data port settings, enter *n* and select your data port again.

The Data Port Interface is now set.

Current Host Attributes

To set up the current host attributes:

1. Press **Enter** to enter the host name for the appliance.

**Note**

The host name must be all lower case letters.

2. Type the IP address for the ICC port.
3. Domain name: Set the domain name to the default value **extremenetworks.com**, or enter a domain name and press **Enter**.
4. IP netmask: Set the IP netmask for the ICC port, or enter an IP address and press **Enter**.
5. Primary DNS server: Set the IP address for the primary DNS server, or enter another IP address and press **Enter**.
6. If you need a secondary DNS server, type **Y** and provide the IP address. Otherwise, press **Enter** to accept **No** as the default value.

The updated Host Attribute settings are displayed.

7. To accept the changes you have made, press **Enter**.

**Note**

If you need to reconfigure the Host Attributes settings, enter **n** and enter the host name for the appliance again.

Current Global Default Gateway Settings

The global default gateway can be on any Admin or data port topology/subnet.

**Note**

The system's default gateway must be pointing to a next hop connection through the service ports.

Enter the default gateway:

1. Type an IP address.
2. Press **Enter** to accept the changes.

Current Time Settings

The Current Time Settings option allows you to change the time zone as per your location.

1. To set the Time Zone, press **Enter** . The Region number list is displayed.

**Important**

Ensure that Universal Compute Platform is configured with the correct Network Time Protocol (NTP) Server settings. Several system functions are dependent on an accurate timestamp.

- Pick a number from those displayed on the screen that corresponds to the Continent. Then, enter a number that corresponds to the Region.

You can enter **n** to move down the list, or **p** to move up the list. To go back to the Region selection, press **c**.

For example, for Toronto select Americas (2) then Toronto (141).

- Provide the fully qualified domain name or IP address of the NTP server. Press **Enter**.
- You are prompted to enter a second NTP server and the default option is **y**. Type **n** and press **Enter**.

NTP Client is enabled.

- Accept the changes you have made to the time zone and NTP server by pressing **Enter**.



Note

If you need to reconfigure the current time settings, enter **n** and enter the settings again.

- If you want to revisit any of the previous screens or exit without applying the configuration changes, enter one of the corresponding numbers/alphabets displayed on screen.

```

Controller Post Installation Configuration

Admin password Configuration          1
Change ICC Port Settings             2
Change Data Port Settings            3
Change Host Attributes Settings       4
Change Global Default Gateway Settings 5
Change Time Settings                 6
Apply Settings and Exit               A
Exit Without Applying                 E
.....
Main Menu[A]: █

```

Figure 3: Controller Post Installation Configuration Menu Screen

Table 18: Controller Post Installation Configuration Menu

Menu Option	Command
Admin password Configuration	1
Change ICC Port Settings	2
Change Data Port Settings	3
Change Host Attribute Settings	4
Change Global Default Gateway Settings	5

Table 18: Controller Post Installation Configuration Menu (continued)

Menu Option	Command
Change Time Settings	6
Apply Settings and Exit	A
Exit Without Applying	E

When you revisit any other screen, you will have to reconfigure all subsequent area settings. For example, if you decide to reconfigure the Admin Password, which is at the beginning of the configuration wizard, you will have to reconfigure all the subsequent configuration wizard settings.

7. Press **Enter** to accept the settings. The default option for accepting the settings is **A**. Your settings are now applied successfully.

Test Connectivity

Test connectivity to the external services in the cluster using the `ping` command.

1. To test connectivity to external services such as DNS, ping the IP address of the DNS server.
2. Ping the cluster IP address to test connectivity.

```

Extreme Universal Compute Platform
Copyright Extreme Networks Inc. 2022
-----+-----
c2-xca4.pinewoods.tor.lab.local# ping
Usage: ping [source-interface (name <name>) | (number <id>)] <ip address>
c2-xca4.pinewoods.tor.lab.local# ping 8.8.8.8
PING 8.8.8.8 (8.8.8.8) 56(84) bytes of data.
64 bytes from 8.8.8.8: icmp_seq=1 ttl=112 time=2.82 ms
64 bytes from 8.8.8.8: icmp_seq=2 ttl=112 time=2.05 ms
64 bytes from 8.8.8.8: icmp_seq=3 ttl=112 time=2.01 ms

--- 8.8.8.8 ping statistics ---
3 packets transmitted, 3 received, 0% packet loss, time 2003ms
rtt min/avg/max/mdev = 2.008/2.293/2.818/0.371 ms
c2-xca4.pinewoods.tor.lab.local#

```

Figure 4: Example ping command

Upgrade the Appliance Software

Before configuring the cluster, use your Extreme Support account to download the latest revision of Universal Compute Platform software from the support portal: <https://extremeportal.force.com/>. At this time, UCP 5.04.01 is the minimum required revision.

1. Log in to the controller Admin user interface: `https://node ip:5825`
2. Go to **Administration** > **System** > **Software Upgrade** > **Upload**.

3. Upload the desired revision of Universal Compute Platform.

**Note**

A best practice is to upgrade each of the nodes on a new cluster to the latest revision before proceeding with the cluster set up and configuration.

Extreme Universal Compute Platform (Cluster) admin

Image Management Upload Schedule Kubernetes Upgrade Logs

Upload Image

Image Type
Upgrade

Destination
Local

Upload Method
HTTP

↑
Choose Upgrade file or
Drag and drop image here

Figure 5: Select the upgrade image

4. From the **Image Management** Tab, select the Upgrade image, and select .
5. In the popup window, complete the following fields:
 - **Image**—Select the platform image file.
 - **Backup System Image to**—Select **Local**.
 - **Upgrade**—Select **Now**.

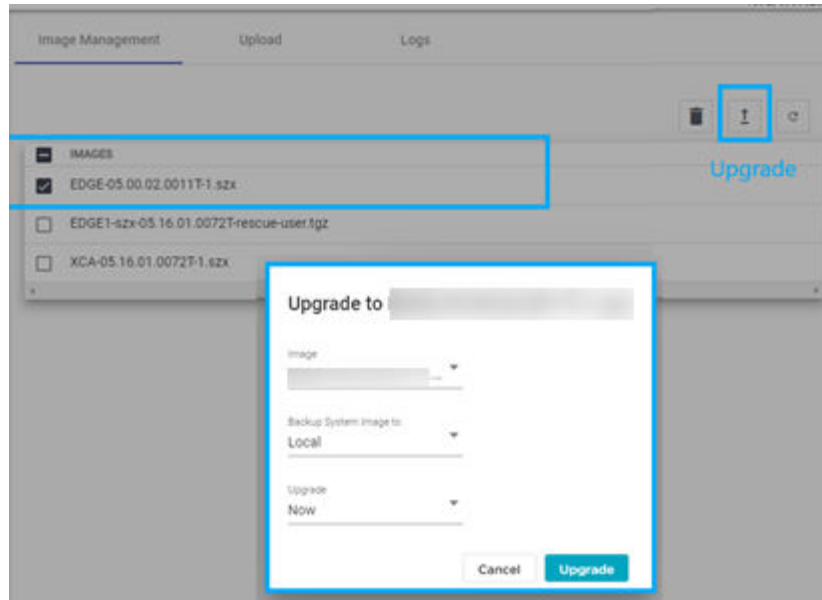

Figure 6: Upgrade the selected image

6. Select **Upgrade**.

When all nodes in the cluster are upgraded to the latest revision, proceed to [IP Address Configuration](#) on page 32.

IP Address Configuration

Use the configuration wizard to initialize nodes in a cluster to the pre-determined IP addresses.



Note

IP address configuration for interfaces on the cluster must be set only once. If you change IP addresses after initial deployment (for example, due to a cluster relocation), you must rebuild and re-deploy the cluster, and re-install the application.

The following is example information that must be gathered during the prerequisite stages for each node in the cluster, and for the ICC VRRP:

IP Address

A unique IP address for each node. Example:192.227.109.81

Mask

Common Mask. Example:/26 (255.255.255.192)

Gateway

Common Gateway. Example:192.227.109.65

VRRP Precedence

Common Router ID with a unique precedence level for each node. Provide a unique precedence value for each node.

For example:

- Node1 - 100 Router ID1
- Node2 - 75 Router ID1
- Node3 - 50 Router ID1
- Node4 - 25 Router ID1
- Node5 - 10 Router ID1
- Node6 - 01 Router ID1

Related Topics

[Use the Basic Configuration Wizard](#) on page 26

Configure VRRP (VIP)

Take the following steps to configure the Virtual Router Redundancy Protocol (VRRP) IP addresses.

1. Navigate to **Administration > System > Network Setup**.
2. From the **Interfaces** list, select the data access interface that you configured from the **System Startup Wizard** for (Port 1).

The **Port Configuration Settings** menu displays.

3. Provide a list of IP addresses that will be offered via VRRP.

4. Set the Router Priority and Router ID for each node.

Each node must have the same list of IP addresses and the same Router ID.

Each node must have the same list of IP addresses and the same Router ID, but have a unique Priority setting. The Priority setting determines which node in the cluster is the Primary node. The node with the higher priority is considered the default Primary node.

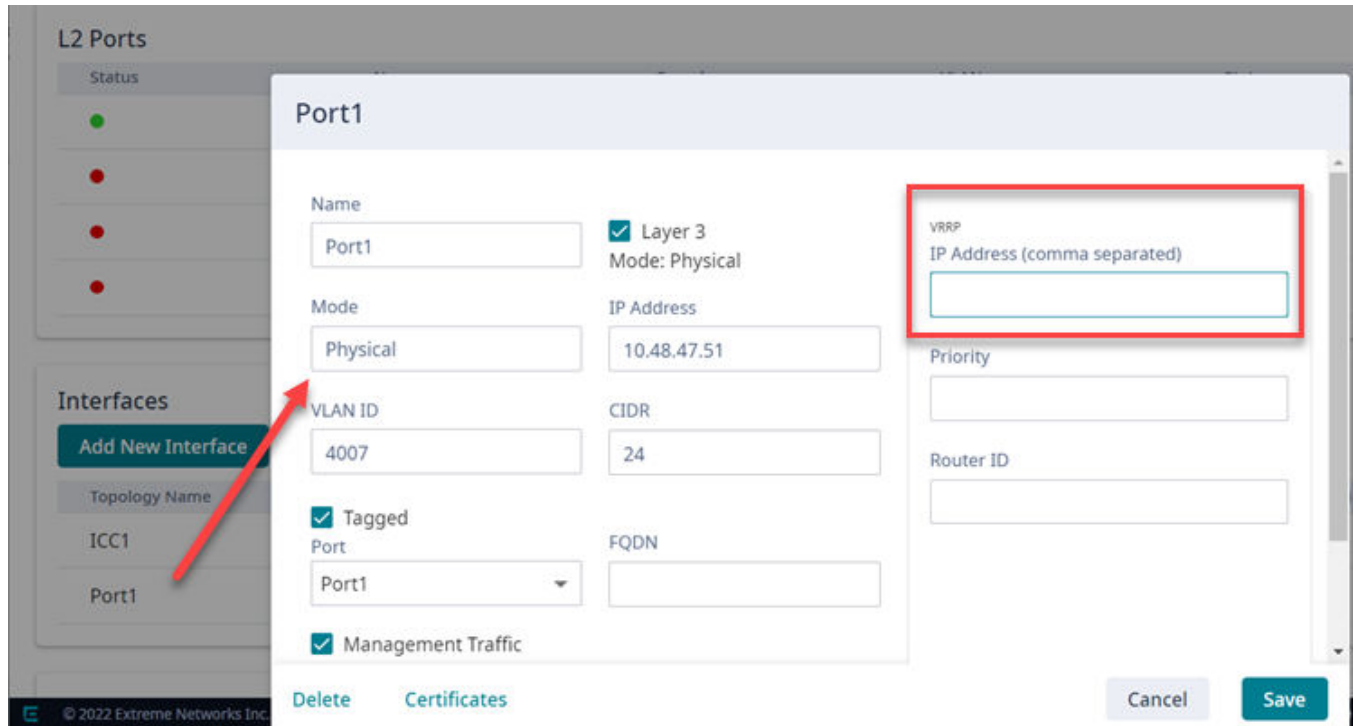

Figure 7: User Interface showing properties window for Port 1

5. Repeat this process in each of the nodes of the cluster.



Configure the Cluster Settings

An engine is an instance of a containerized application. This process follows the user interface to configure the orchestration engine settings. From the management IP address, log into the user interface using the admin credentials that you configured under [Use the Basic Configuration Wizard](#) on page 26.

Go to **Cluster Settings > Cluster Configuration** and configure the cluster following the order shown on screen:

1. Deployment Type
 2. Cluster Node Information
 3. Pod Network Configuration
 4. Finish
1. From the **Deployment Type** drop-down list, select **ExtremeCloud Edge - Managed Orchestration**.
 2. Provide the settings for **Pod Network Configuration**:
 - Pod Network IP Address
 - Pod Network CIDR
 - Service Network IP Address
 - Service Network CIDR

The screenshot shows the 'Pod Network Configuration' step in a wizard titled 'Extreme Universal Compute Platform (Cluster)'. The wizard progress bar shows four steps: 1. Cluster Node Information, 2. Pod Network Configuration (current), 3. Finish, and 4. Finish. The configuration fields are: Pod Network IP Address (10.96.0.0), Pod Network CIDR (16), Service Network IP Address (10.97.0.0), and Service Network CIDR (16). At the bottom, there are 'Back' and 'Create Cluster' buttons.

Figure 8: Pod Settings

3. Select **Create Cluster**.

The screenshot shows the 'Resetting this node' step in the wizard. The progress bar shows four steps: 1. Deployment Type, 2. Cluster Node Information, 3. Pod Network Configuration, and 4. Finish. Below the progress bar, there is a circular progress indicator and a 'Done' button.

4. Select **Done**.

The screenshot shows the 'Extreme Universal Compute Platform (Cluster)' dashboard. The top navigation bar includes 'Deployment Health', 'System Health', 'Nodes', 'Pods', 'VMs', 'Services', and 'Volumes'. The main content area displays four summary cards: Nodes (3), Pods (22), Services (3), and Volumes (0). Below these cards, there are two sections: 'Configuration' and 'Operational'. The 'Configuration' section lists four items, with the first three having green status indicators and the last one having a yellow indicator. The 'Operational' section lists three items, all with green status indicators.



Select an Engine

[Install an Engine Instance](#) on page 37

[Network Service Configuration](#) on page 38

From the **Engines** page, select the engine type for your cluster.

ExtremeCloud™ IQ is the only available engine for an ExtremeCloud Edge deployment. An Edge Cloud deployment of ExtremeCloud IQ must be configured in a cluster. The minimum number of cluster nodes is three for ExtremeCloud IQ only, and six nodes if you're also deploying other applications.

Install an Engine Instance

Install ExtremeCloud IQ engine once from a single node.

To install an engine instance:

1. Go to **Engines**.
2. From the ExtremeCloud IQ pane, select **Install**.

After installation is complete, a confirmation notice is displayed and the XIQ instance displays.

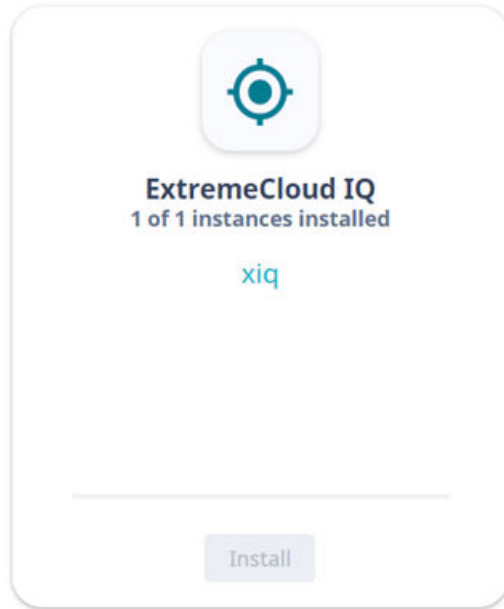
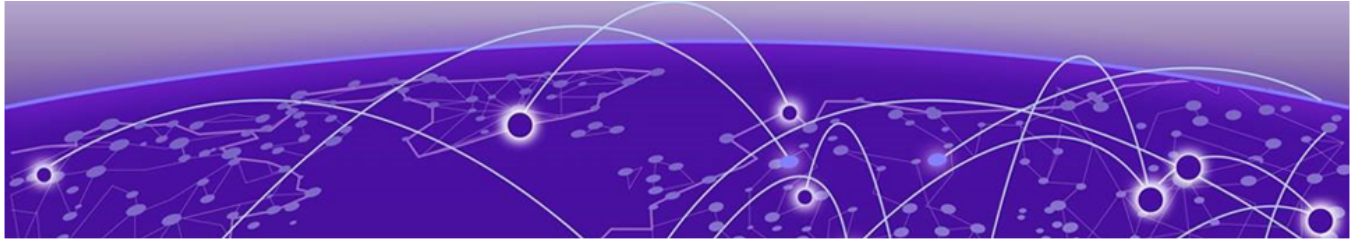

Figure 9: Installed ExtremeCloud IQ Engine Instance

Network Service Configuration

Map each core service set to the corresponding Virtual Router Redundancy Protocol (VRRP). Assign a VRRP virtual router address for each set of services. VRRP enables a virtual router to act as the default network gateway, improving host network reliability and performance.



Validate the Cluster

Click the **Deployment Health** tab for information.

The screenshot shows the 'Extreme Universal Compute Platform (Cluster)' dashboard. The 'Deployment Health' tab is selected, showing a summary of cluster components: 3 Nodes, 22 Pods, 3 Services, and 0 Volumes. Below the summary, there are two sections: 'Configuration' and 'Operational'. The 'Configuration' section lists four items, with the first three having green status indicators and the last one having a yellow indicator. The 'Operational' section lists three items, all with green status indicators.

Section	Item	Status
Configuration	Default Route configured for router on data Interface	Green
	NTP settings are synchronized	Green
	Backup of system configuration has not been scheduled	Yellow
	VRRP interface configured correctly	Green
Operational	NTP is reachable	Green
	Kubernetes nodes are healthy	Green
	Kubernetes HA cluster is healthy	Green



Onboard Cluster to ExtremeCloud IQ

[Onboarding a Cluster to ExtremeCloud IQ](#) on page 41

[Account Registration](#) on page 43

[Cloud Visibility](#) on page 43

After the Universal Compute Platform cluster is installed, associate the node cluster with your ExtremeCloud IQ account:

1. Onboard the cluster to your ExtremeCloud IQ account.
2. Initiate action for the ExtremeCloud IQ Operations team to deploy a Regional Data Center (RDC) for the cluster.
3. Register your ExtremeCloud IQ account.
4. Onboard your devices and operate the account.

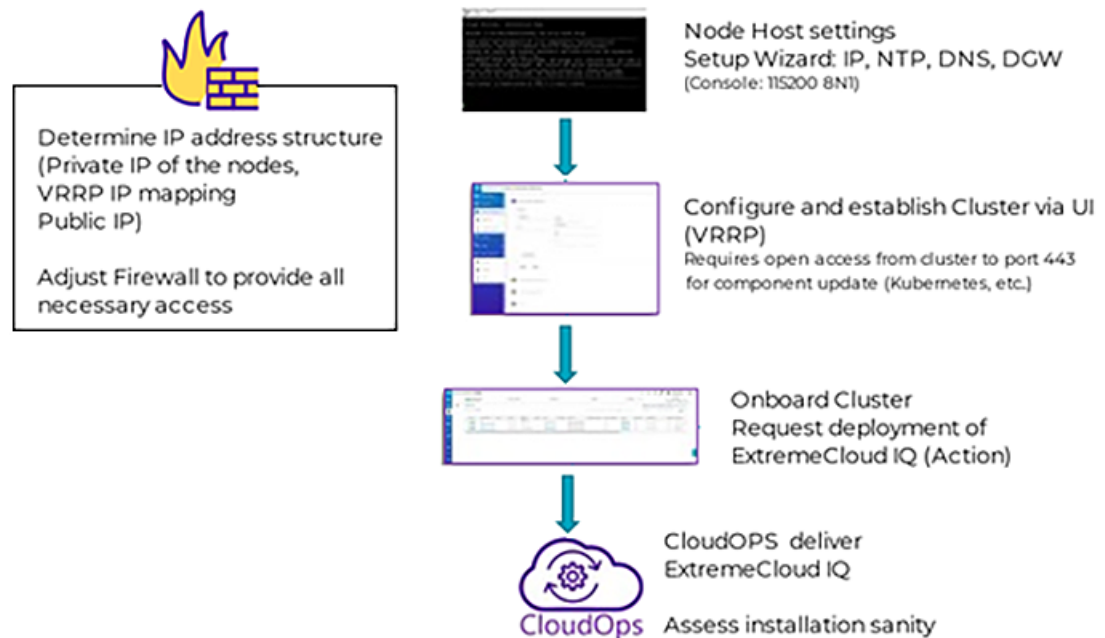



Figure 10: ExtremeCloud Edge Deployment Workflow

Onboarding a Cluster to ExtremeCloud IQ

To onboard a Universal Compute Platform cluster into ExtremeCloud IQ use the ExtremeCloud IQ Quick Add function:

1. From the ExtremeCloud IQ main navigation pane, select  (Manage), and then select **Devices**.
2. Select **+** (Add) and then select **Quick Add Devices > Manage your devices directly from the cloud**.
3. In the **Serial Number** field, enter the serial number for one node in the cluster.

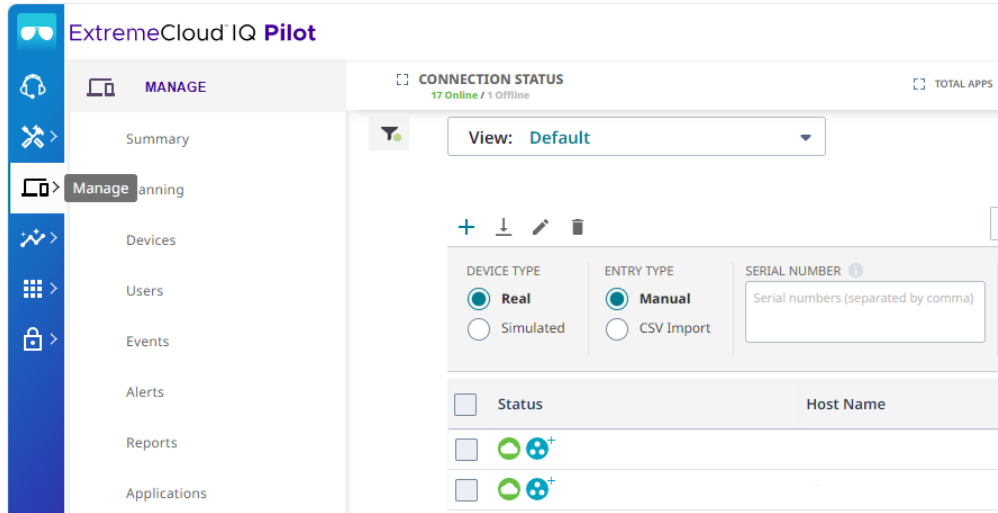

Figure 11: Add Cluster to ExtremeCloud IQ

The **Device Make** field displays.

4. From the **Device Make** menu, select **Universal Appliance**.
5. Select **Add Devices**.

The full cluster is added based on the serial number of a single node in the cluster.



Note

To view details about the cluster, select the **Host Name** link.

6. Select **Actions > Applications > ExtremeCloud IQ Manage**.



Figure 12: ExtremeCloud IQ Actions menu

This initiates the action for ExtremeCloud IQ OPs to deploy a Regional Data Center (RDC) for the cluster.

7. Fill out the online form:



Note

Required fields are noted with an asterisk.

- Customer Information
- Primary Technical Contact
- Secondary Technical Contact
- Notification List — Provide a list of email addresses for notification.
- Nightly Backup
- Scheduled Upgrades
- RDC Name — Provide a meaningful name, up to 6 characters. The system will verify that the name is available.
- IP Address Mapping — Provide the mapping between the external Public IP Address to the internal virtual VRRP IP Address for each service set.

c3-xca1.pinewoods.tor.lab.local
✕

Customer Information *

Primary Technical Contact *

Secondary Technical Contact *

Notification List *

Nightly Backups ON

Scheduled Upgrades ON Communications

RDC Name *

MYRDC

IP Address Mapping *

SERVICE SET	VRRP IP ADDRESS	PUBLIC IP ADDRESS
Service Set 1	<input style="width: 100%;" type="text"/>	<input style="width: 100%;" type="text"/>
Service Set 2	<input style="width: 100%;" type="text"/>	<input style="width: 100%;" type="text"/>
Service Set 3	<input style="width: 100%;" type="text"/>	<input style="width: 100%;" type="text"/>

DEPLOY CANCEL

Figure 13: ExtremeCloud IQ Deploy a Cluster Form

8. Select **Deploy**.

A ticket is generated for ExtremeCloud IQ OPs. Operations personnel will provide an estimate for the expected deployment schedule.

During deployment, the OPs team will do the following:

- Deploy ExtremeCloud IQ software to the on-premise hosts
- Validate the deployment to ensure that the site is deployed and operating correctly
- Once validated, OPs will provide notification of readiness
- Provide the installation token that enables customers to create accounts directly on the newly deployed ExtremeCloud IQ private Regional Data Center (RDC).



Note

You can view the status of the deployment process from the **Application Status** column on the **Device List**

Account Registration

For information about creating accounts after you set up ExtremeCloud Edge, consult the Managed Service Partner (MSP) documentation.

Cloud Visibility

If your deployment is onboarded to ExtremeCloud IQ, you can view the cloud address from **Administration > System > Settings**. This page populates automatically when you onboard the cluster to ExtremeCloud IQ. For example, the URL may look like:

<RDC name>-cw.extremecloudiq.com where:

- <RDC name> is your Regional Data Center (RDC) information available under **About ExtremeCloud IQ**.
- -cw indicates a Universal Compute Platform appliance.
- .extremecloudiq.com is the ExtremeCloud IQ host address.

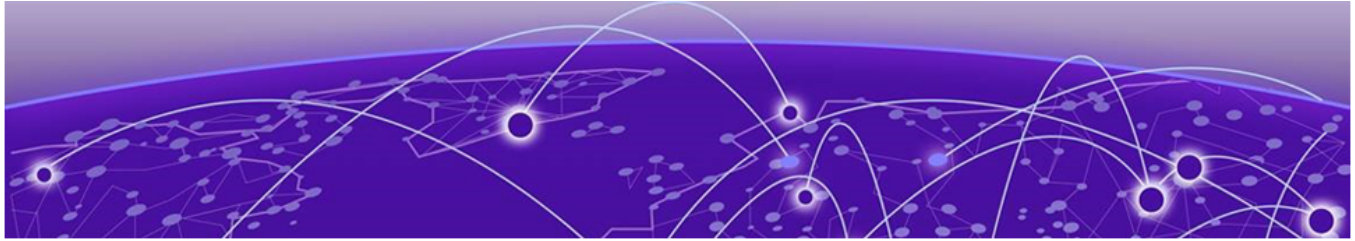

Appendix A: Migrate Virtual IQ Account

[Export VIQ Account](#) on page 44

[Import VIQ Account](#) on page 45

This Appendix describes how to migrate a Virtual IQ (VIQ) account to a new Regional Data Center (RDC). To migrate the account, complete each of the subsequent procedures in order:

1. Export VIQ Account
2. Import VIQ Account



Note

Moving the VIQ account also moves the account inventory (for example, devices, floor plans, private pre-shared keys) as well as configurations and assignments.

Export VIQ Account

Use this procedure to create and download an export file for a VIQ account.

1. In ExtremeCloud IQ Pilot, go to **Global Settings** and select **VIQ Management**.
2. Create a backup of the current VHM:
 - a. Under **VIQ Management**, select **BACK UP NOW**.
 - b. Select **YES**.
VIQ suspends itself until the backup completes.
3. Export the VHM to a local drive:
 - a. Go to **Global Settings** and select **VIQ Management**.
 - b. Select **Export VIQ**.
 - c. In the **VIQ Export** popup window, select **Export Now**.
 - d. Click **YES**. VIQ suspends itself until the Export completes.
 - e. Once the export completes successfully, select **OK**.



Note

If the export fails, click the **Detailed Report** link to get a detailed report on the issue.

What to do Next

After the export file downloads, you can import the file into a different Regional Data Center (RDC).

Import VIQ Account

Use this procedure to import the VIQ export file into the new RDC. Note the following:

- If a conflict occurs, imported objects get renamed.
 - Source and destination VHM's must be the same version. Otherwise, an incompatible data scheme occurs.
1. From ExtremeCloud IQ Pilot, go to **Global Settings > VIQ Management**.
 2. Create a backup of the current VHM:
 - a. Under **VIQ Management**, select **BACK UP NOW**.
 - b. Select **YES**.
VIQ suspends itself until the backup completes.
 3. Import the VHM export file that you created in the preceding procedure:
 - a. Select **Import VIQ**.
 - b. Select **Import VIQ from ExtremeCloud IQ**.
 - c. Select **Choose** and then browse and select the VHM export file.
 - d. Select **Import Now**.
 - e. After the import completes, select **OK**.



Note

- If the import fails, download the log file for information on the issues.
- If you need to roll back the import, restore the backup.

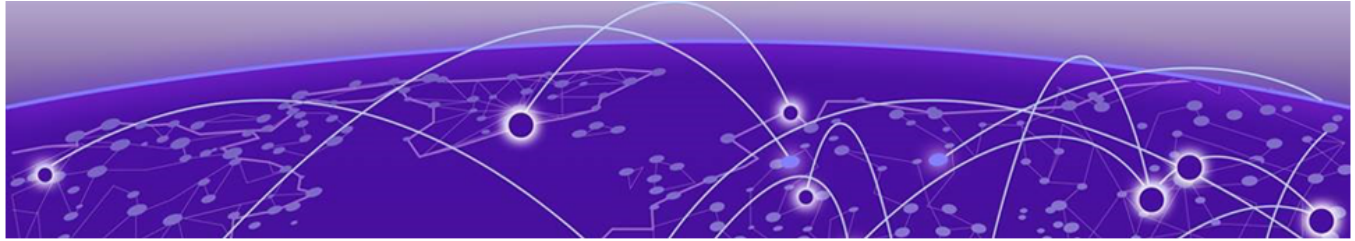

Appendix B: Replace or Add a Node

[Prepare to Replace a Node](#) on page 46

[Replace a Node](#) on page 47

[Add Node](#) on page 47

Use the procedures in this Appendix if you need to replace a node or add a node.

Prepare to Replace a Node

1. Gather the IP address settings of the failed node.

Unless stated otherwise, you will set the new node with the same IP address values as the unit being replaced:

- ICC Interface IP Address—For the ICC interface, you must assign a new IP address to the replacement node.
- Data Port Interface IP Address
- DNS Server Address
- NTP Server Address

2. Configure the VRRP priority for the replacement node.



Note

To ensure that the replacement node successfully joins the cluster, set the VRRP node priority of the replacement node to a value that is lower than the value of the existing nodes. This ensures that the VRRP address is pointing at a working node in the cluster during the joining process. After the replacement node has joined the cluster, you can set the VRRP node priority to first priority if desired, but this is not required.

3. Use the Basic Configuration Wizard to configure the replacement unit.

This is required if you are replacing the unit hardware. Node Replacement initially resets the node connections. It may not require new hardware.

For information about the Basic Configuration Wizard, see the appropriate Deployment Guide.

4. [Upgrade the Appliance Software](#) on page 30 for the new node to the current firmware version.

After you have gathered the necessary information and verified the firmware version of all nodes in the cluster, you can run the [Replace a Node](#) on page 47 procedure.

Replace a Node

Replacing a node in a cluster is performed when a node has failed and must be replaced. The replacement node gets delivered in a reset state. After initializing the node for its network presence, the new node is added to the cluster and assumes the service load of the removed node.

From the primary node in the cluster (Node 1), take the following steps:

1. Go to **Cluster Services > Node Replacement**.

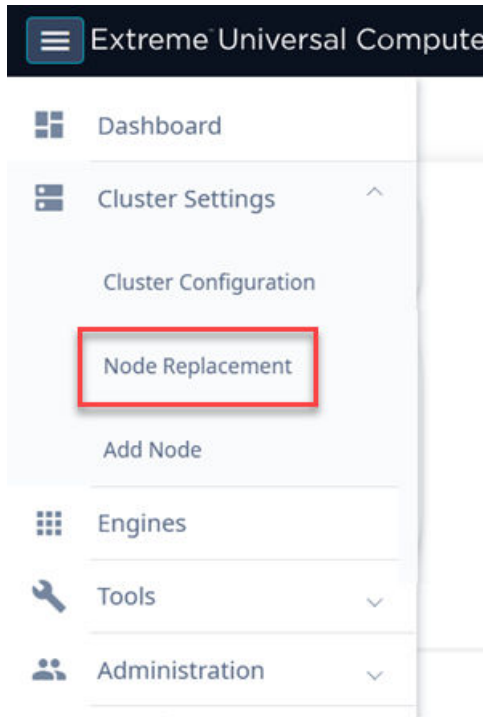

Figure 14: Node Replacement

2. Select the failed node and select **Next**.
Existing credentials are used to establish connection to the failed node. Configuration and services information is transferred from the primary node to the failed node in an effort to re-establish a connection.

If it is necessary to replace the node hardware, refer to the [Universal Compute Platform Appliance 4120C Installation Guide](#) for detailed information.

Add Node



Note

Before adding a new node, you must configure the new controller and ensure that it is running the current firmware version. Refer to [Prepare to Replace a Node](#) on page 46.

A node is one appliance. Universal Compute Platform clusters typically support up to three or more nodes, with the ability to scale up when the cluster reaches capacity.

To add a node to a cluster, take the following steps:

1. Go to **Cluster Settings > Add Node**.

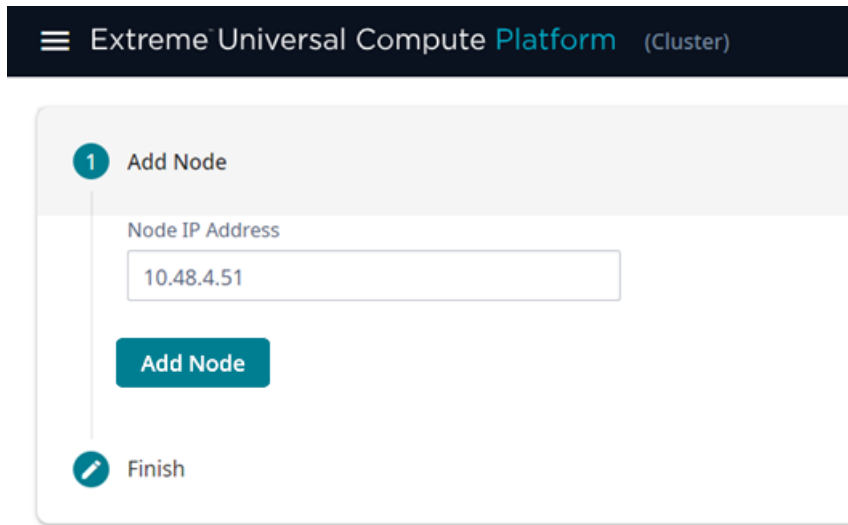

The screenshot shows the 'Add Node' dialog in the Extreme Universal Compute Platform interface. The dialog has a dark header with a hamburger menu icon, the text 'Extreme Universal Compute Platform', and '(Cluster)' in parentheses. Below the header, there is a progress indicator with a '1' in a circle and the text 'Add Node'. The main content area contains a text input field labeled 'Node IP Address' with the value '10.48.4.51' entered. Below the input field is a teal 'Add Node' button. At the bottom of the dialog, there is a 'Finish' button with a pencil icon.

Figure 15: Add Node dialog

2. Provide the appliance IP address for the node and select **Add Node**.
The **Node Addition** confirmation dialog displays.

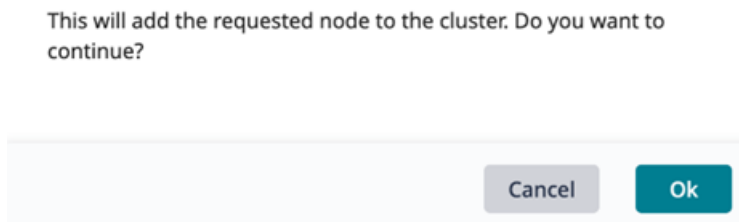

The screenshot shows the 'Node Addition Confirmation Dialog'. The dialog contains the text: 'This will add the requested node to the cluster. Do you want to continue?'. At the bottom of the dialog, there are two buttons: a grey 'Cancel' button and a teal 'Ok' button.

Figure 16: Add Node Confirmation Dialog

3. Select **OK** to begin the Add Node process.

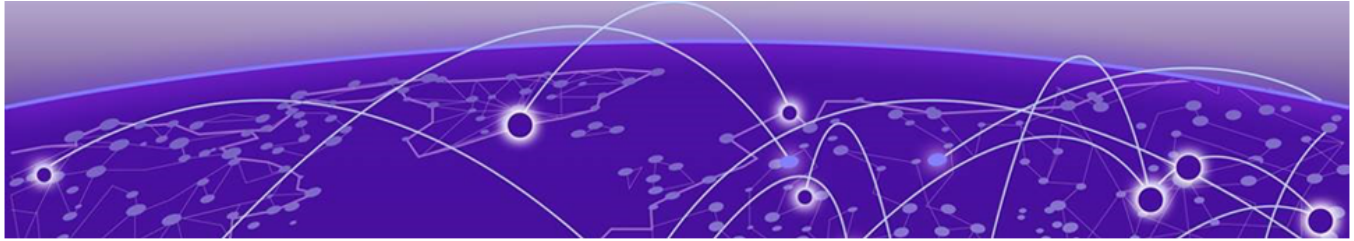

Index

A

add node 47
announcements 7, 8

C

cloud visibility 43
cluster
 prerequisites 9
 validating 39
cluster settings
 configure 35
conventions
 notice icons 5
 text 5

D

deployment overview 15
documentation
 feedback 8
 location 6, 7

E

Engines 37
ExtremeCloud IQ
 installation 17
ExtremeCloud IQ registration
 user account registration 43

F

feedback 8
firewall configuration 20–23
Firewalls 14

H

hardware support
 managed orchestration 16

I

install
 ExtremeCloud IQ engine 37
IP addresses
 cluster interfaces and external access 18
 configuration 32

IP addresses (*continued*)
 reserving private network segments 20

K

Kubernetes
 reserving private network segments 20

N

network service configuration 38
node
 add 47
 prepare to replace 46
node replacement 47
notices 5

O

onboard the cluster 40
onboarding
 cluster 41

P

product announcements 7, 8

R

replace node 47
revision history 8

S

service ports 20–22
source address 23
support, *see* technical support

T

technical support
 contacting 7, 8

U

upgrading
 appliance firmware 30
user accounts
 ExtremeCloud IQ registration 43

V

VIQ

- create export file 44

- import VHM 45

- migrate account to new RDC 44

Virtual Router Redundancy Protocol (VRRP)

- configuration 18, 19, 33

W

warnings 5