



Avaya Virtual Services Platform 7000 Series Installation — SFP and SFP+

Release 10.1
NN47202-302
Issue 01.04
March 2013

Notice

While reasonable efforts have been made to ensure that the information in this document is complete and accurate at the time of printing, Avaya assumes no liability for any errors. Avaya reserves the right to make changes and corrections to the information in this document without the obligation to notify any person or organization of such changes.

Documentation disclaimer

"Documentation" means information published by Avaya in varying mediums which may include product information, operating instructions and performance specifications that Avaya generally makes available to users of its products. Documentation does not include marketing materials. Avaya shall not be responsible for any modifications, additions, or deletions to the original published version of documentation unless such modifications, additions, or deletions were performed by Avaya. End User agrees to indemnify and hold harmless Avaya, Avaya's agents, servants and employees against all claims, lawsuits, demands and judgments arising out of, or in connection with, subsequent modifications, additions or deletions to this documentation, to the extent made by End User.

Link disclaimer

Avaya is not responsible for the contents or reliability of any linked websites referenced within this site or documentation provided by Avaya. Avaya is not responsible for the accuracy of any information, statement or content provided on these sites and does not necessarily endorse the products, services, or information described or offered within them. Avaya does not guarantee that these links will work all the time and has no control over the availability of the linked pages.

Warranty

Avaya provides a limited warranty on its hardware and Software ("Product(s)"). Refer to your sales agreement to establish the terms of the limited warranty. In addition, Avaya's standard warranty language, as well as information regarding support for this Product while under warranty is available to Avaya customers and other parties through the Avaya Support website: <http://support.avaya.com>. Please note that if you acquired the Product(s) from an authorized Avaya reseller outside of the United States and Canada, the warranty is provided to you by said Avaya reseller and not by Avaya. "Software" means computer programs in object code, provided by Avaya or an Avaya Channel Partner, whether as stand-alone products or pre-installed on hardware products, and any upgrades, updates, bug fixes, or modified versions.

Licenses

THE SOFTWARE LICENSE TERMS AVAILABLE ON THE AVAYA WEBSITE, [HTTP://SUPPORT.AVAYA.COM/LICENSEINFO](http://support.avaya.com/licenseinfo) ARE APPLICABLE TO ANYONE WHO DOWNLOADS, USES AND/OR INSTALLS AVAYA SOFTWARE, PURCHASED FROM AVAYA INC., ANY AVAYA AFFILIATE, OR AN AUTHORIZED AVAYA RESELLER (AS APPLICABLE) UNDER A COMMERCIAL AGREEMENT WITH AVAYA OR AN AUTHORIZED AVAYA RESELLER. UNLESS OTHERWISE AGREED TO BY AVAYA IN WRITING, AVAYA DOES NOT EXTEND THIS LICENSE IF THE SOFTWARE WAS OBTAINED FROM ANYONE OTHER THAN AVAYA, AN AVAYA AFFILIATE OR AN AVAYA AUTHORIZED RESELLER; AVAYA RESERVES THE RIGHT TO TAKE LEGAL ACTION AGAINST YOU AND ANYONE ELSE USING OR SELLING THE SOFTWARE WITHOUT A LICENSE. BY INSTALLING, DOWNLOADING OR USING THE SOFTWARE, OR AUTHORIZING OTHERS TO DO SO, YOU, ON BEHALF OF YOURSELF AND THE ENTITY FOR WHOM YOU ARE INSTALLING, DOWNLOADING OR USING THE SOFTWARE (HEREINAFTER REFERRED TO INTERCHANGEABLY AS "YOU" AND "END USER"), AGREE TO THESE TERMS AND CONDITIONS AND CREATE A BINDING CONTRACT BETWEEN YOU AND AVAYA INC. OR THE APPLICABLE AVAYA AFFILIATE ("AVAYA").

Avaya grants you a license within the scope of the license types described below, with the exception of Heritage Nortel Software, for which the scope of the license is detailed below. Where the order documentation does not expressly identify a license type, the applicable license will be a Designated System License. The applicable number of licenses and units of capacity for which the license is granted will be one (1), unless a different number of licenses or units of capacity is specified in the documentation or other materials available to you. "Designated Processor" means a single stand-alone computing device. "Server" means a Designated Processor that hosts a software application to be accessed by multiple users.

Licence types

Designated System(s) License (DS). End User may install and use each copy of the Software only on a number of Designated Processors up to the number indicated in the order. Avaya may require the Designated Processor(s) to be identified in the order by type, serial number, feature key, location or other specific designation, or to be provided by End User to Avaya through electronic means established by Avaya specifically for this purpose.

Heritage Nortel Software

"Heritage Nortel Software" means the software that was acquired by Avaya as part of its purchase of the Nortel Enterprise Solutions Business in December 2009. The Heritage Nortel Software currently available for license from Avaya is the software contained within the list of Heritage Nortel Products located at <http://support.avaya.com/LicenseInfo> under the link "Heritage Nortel Products". For Heritage Nortel Software, Avaya grants Customer a license to use Heritage Nortel Software provided hereunder solely to the extent of the authorized activation or authorized usage level, solely for the purpose specified in the Documentation, and solely as embedded in, for execution on, or (in the event the applicable Documentation permits installation on non-Avaya equipment) for communication with Avaya equipment. Charges for Heritage Nortel Software may be based on extent of activation or use authorized as specified in an order or invoice.

Copyright

Except where expressly stated otherwise, no use should be made of materials on this site, the Documentation, Software, or hardware provided by Avaya. All content on this site, the documentation and the Product provided by Avaya including the selection, arrangement and design of the content is owned either by Avaya or its licensors and is protected by copyright and other intellectual property laws including the sui generis rights relating to the protection of databases. You may not modify, copy, reproduce, republish, upload, post, transmit or distribute in any way any content, in whole or in part, including any code and software unless expressly authorized by Avaya. Unauthorized reproduction, transmission, dissemination, storage, and or use without the express written consent of Avaya can be a criminal, as well as a civil offense under the applicable law.

Third Party Components

"Third Party Components" mean certain software programs or portions thereof included in the Software that may contain software (including open source software) distributed under third party agreements ("Third Party Components"), which contain terms regarding the rights to use certain portions of the Software ("Third Party Terms"). Information regarding distributed Linux OS source code (for those Products that have distributed Linux OS source code) and identifying the copyright holders of the Third Party Components and the Third Party Terms that apply is available in the Documentation or on Avaya's website at: <http://support.avaya.com/Copyright>. You agree to the Third Party Terms for any such Third Party Components.

Preventing Toll Fraud

"Toll Fraud" is the unauthorized use of your telecommunications system by an unauthorized party (for example, a person who is not a corporate employee, agent, subcontractor, or is not working on your company's behalf). Be aware that there can be a risk of Toll Fraud associated with

your system and that, if Toll Fraud occurs, it can result in substantial additional charges for your telecommunications services.

Avaya Toll Fraud intervention

If you suspect that you are being victimized by Toll Fraud and you need technical assistance or support, call Technical Service Center Toll Fraud Intervention Hotline at +1-800-643-2353 for the United States and Canada. For additional support telephone numbers, see the Avaya Support website: <http://support.avaya.com>. Suspected security vulnerabilities with Avaya products should be reported to Avaya by sending mail to: securityalerts@avaya.com.

Trademarks

The trademarks, logos and service marks ("Marks") displayed in this site, the Documentation and Product(s) provided by Avaya are the registered or unregistered Marks of Avaya, its affiliates, or other third parties. Users are not permitted to use such Marks without prior written consent from Avaya or such third party which may own the Mark. Nothing contained in this site, the Documentation and Product(s) should be construed as granting, by implication, estoppel, or otherwise, any license or right in and to the Marks without the express written permission of Avaya or the applicable third party.

Avaya is a registered trademark of Avaya Inc.

All non-Avaya trademarks are the property of their respective owners, and "Linux" is a registered trademark of Linus Torvalds.

Downloading Documentation

For the most current versions of Documentation, see the Avaya Support website: <http://support.avaya.com>.

Contact Avaya Support

See the Avaya Support website: <http://support.avaya.com> for product notices and articles, or to report a problem with your Avaya product. For a list of support telephone numbers and contact addresses, go to the Avaya Support website: <http://support.avaya.com>, scroll to the bottom of the page, and select Contact Avaya Support.

Contents

Chapter 1: Introduction	7
Purpose.....	7
Related resources.....	7
Documentation.....	7
Training.....	7
Avaya Mentor videos.....	8
Support.....	8
Chapter 2: New in this release	9
Chapter 3: Safety messages	11
Translations of safety messages.....	15
Chapter 4: Equipment care	25
Fiber optic equipment care.....	25
Cleaning single connectors.....	27
Cleaning duplex connectors.....	28
Cleaning receptacles.....	29
Chapter 5: SFP transceivers	31
Selecting an SFP.....	31
Installing an SFP.....	33
Removing an SFP.....	36
Chapter 6: SFP+ transceivers	39
Selecting an SFP+.....	39
Installing an SFP+.....	40
Removing an SFP+.....	43
Chapter 7: SFP specifications	45
SFP labels.....	45
General SFP specifications.....	46
SFPs.....	46
Chapter 8: SFP+ specifications	55
SFP+ labels.....	55
General SFP+ specifications.....	56
SFP+s.....	56

Chapter 1: Introduction

Purpose

This document provides safety information, equipment care information, installation procedures, and technical specifications for:

- Small form factor pluggable (SFP) transceivers
- SFP plus (SFP+) transceivers

Related resources

Documentation

For a list of the documentation for this product, see *Avaya Virtual Services Platform 7000 Documentation Roadmap* (NN47202–103).

Training

Ongoing product training is available. For more information or to register, see <http://avaya-learning.com/>.

Enter the course code in the **Search** field and click **Go** to search for the course.

Course code	Course title
7D00080W	Avaya Stackable ERS and VSP Product Overview
7D00085V	Stackable ERS & VSP Installation, Configuration and Maintenance
7D00085I	Stackable ERS & VSP Installation, Configuration and Maintenance

Avaya Mentor videos

Avaya Mentor is an Avaya-run channel on YouTube that includes technical content on how to install, configure, and troubleshoot Avaya products.

Visit <http://www.youtube.com/AvayaMentor> and do one of the following:

- Enter a key word or key words in the Search channel to search for a specific product or topic.
- Click the name of a playlist to scroll through the posted videos.

Support

Visit the Avaya Support website at <http://support.avaya.com> for the most up-to-date documentation, product notices, and knowledge articles. You can also search for release notes, downloads, and resolutions to issues. Use the online service request system to create a service request. Chat with live agents to get answers to questions, or request an agent to connect you to a support team if an issue requires additional expertise.

Chapter 2: New in this release

This document is new for VSP 7000 Release 10.1.

New in this release

Chapter 3: Safety messages

This section describes the different precautionary notices used in this document. This section also contains precautionary notices that you must read for safe operation of the switch.

Notices

Notice paragraphs alert you about issues that require your attention. The following sections describe the types of notices. For a list of safety messages used in this guide and their translations, see [Translations of safety messages](#) on page 15.

Attention Notice

Important:

An attention notice provides important information regarding the installation and operation of Avaya products.

Caution ESD Notice

Electrostatic alert:

ESD

ESD notices provide information about how to avoid discharge of static electricity and subsequent damage to Avaya products.

Electrostatic alert:

ESD (décharge électrostatique)

La mention ESD fournit des informations sur les moyens de prévenir une décharge électrostatique et d'éviter d'endommager les produits Avaya.

Electrostatic alert:

ACHTUNG ESD

ESD-Hinweise bieten Information dazu, wie man die Entladung von statischer Elektrizität und Folgeschäden an Avaya-Produkten verhindert.

Electrostatic alert:

PRECAUCIÓN ESD (Descarga electrostática)

El aviso de ESD brinda información acerca de cómo evitar una descarga de electricidad estática y el daño posterior a los productos Avaya.

Electrostatic alert:

CUIDADO ESD

Os avisos do ESD oferecem informações sobre como evitar descarga de eletricidade estática e os conseqüentes danos aos produtos da Avaya.

 **Electrostatic alert:**

ATTENZIONE ESD

Le indicazioni ESD forniscono informazioni per evitare scariche di elettricità statica e i danni correlati per i prodotti Avaya.

Caution Notice

 **Caution:**

Caution notices provide information about how to avoid possible service disruption or damage to Avaya products.

 **Caution:**

ATTENTION

La mention Attention fournit des informations sur les moyens de prévenir une perturbation possible du service et d'éviter d'endommager les produits Avaya.

 **Caution:**

ACHTUNG

Achtungshinweise bieten Informationen dazu, wie man mögliche Dienstunterbrechungen oder Schäden an Avaya-Produkten verhindert.

 **Caution:**

PRECAUCIÓN

Los avisos de Precaución brindan información acerca de cómo evitar posibles interrupciones del servicio o el daño a los productos Avaya.

 **Caution:**

CUIDADO

Os avisos de cuidado oferecem informações sobre como evitar possíveis interrupções do serviço ou danos aos produtos da Avaya.

 **Caution:**

ATTENZIONE

Le indicazioni di attenzione forniscono informazioni per evitare possibili interruzioni del servizio o danni ai prodotti Avaya.

Warning Notice

Warning:

Warning notices provide information about how to avoid personal injury when working with Avaya products.

Warning:

AVERTISSEMENT

La mention Avertissement fournit des informations sur les moyens de prévenir les risques de blessure lors de la manipulation de produits Avaya.

Warning:

WARNUNG

Warnhinweise bieten Informationen dazu, wie man Personenschäden bei der Arbeit mit Avaya-Produkten verhindert.

Warning:

ADVERTENCIA

Los avisos de Advertencia brindan información acerca de cómo prevenir las lesiones a personas al trabajar con productos Avaya.

Warning:

AVISO

Os avisos oferecem informações sobre como evitar ferimentos ao trabalhar com os produtos da Avaya.

Warning:

AVVISO

Le indicazioni di avviso forniscono informazioni per evitare danni alle persone durante l'utilizzo dei prodotti Avaya.

Danger High Voltage Notice

Voltage:

Danger—High Voltage notices provide information about how to avoid a situation or condition that can cause serious personal injury or death from high voltage or electric shock.

Voltage:

La mention Danger—Tension élevée fournit des informations sur les moyens de prévenir une situation ou une condition qui pourrait entraîner un risque de blessure grave ou mortelle à la suite d'une tension élevée ou d'un choc électrique.

 **Voltage:**

GEFAHR

Hinweise mit „Vorsicht – Hochspannung“ bieten Informationen dazu, wie man Situationen oder Umstände verhindert, die zu schweren Personenschäden oder Tod durch Hochspannung oder Stromschlag führen können.

 **Voltage:**

PELIGRO

Los avisos de Peligro-Alto voltaje brindan información acerca de cómo evitar una situación o condición que cause graves lesiones a personas o la muerte, a causa de una electrocución o de una descarga de alto voltaje.

 **Voltage:**

PERIGO

Avisos de Perigo—Alta Tensão oferecem informações sobre como evitar uma situação ou condição que possa causar graves ferimentos ou morte devido a alta tensão ou choques elétricos.

 **Voltage:**

PERICOLO

Le indicazioni Pericolo—Alta tensione forniscono informazioni per evitare situazioni o condizioni che potrebbero causare gravi danni alle persone o il decesso a causa dell'alta tensione o di scosse elettriche.

Danger Notice

 **Danger:**

Danger notices provide information about how to avoid a situation or condition that can cause serious personal injury or death.

 **Danger:**

La mention Danger fournit des informations sur les moyens de prévenir une situation ou une condition qui pourrait entraîner un risque de blessure grave ou mortelle.

 **Danger:**

GEFAHR

Gefahrenhinweise stellen Informationen darüber bereit, wie man Situationen oder Umständen verhindert, die zu schweren Personenschäden oder Tod führen können.

 **Danger:**

PELIGRO

Los avisos de Peligro brindan información acerca de cómo evitar una situación o condición que pueda causar lesiones personales graves o la muerte.

⚠ Danger:

PERIGO

Avisos de perigo oferecem informações sobre como evitar uma situação ou condição que possa causar graves ferimentos ou morte.

⚠ Danger:

PERICOLO

Le indicazioni di pericolo forniscono informazioni per evitare situazioni o condizioni che potrebbero causare gravi danni alle persone o il decesso.

Translations of safety messages

This section contains translations of precautionary notices that you must read and follow for safe operation of the Virtual Services Platform 7000 Series.

Electromagnetic interference caution statement

⚠ Caution:

This device is a Class A product. Operation of this equipment in a residential area is likely to cause harmful interference, in which case users are required to take appropriate measures necessary to correct the interference at their own expense.

⚠ Caution:

ATTENTION

Le périphérique est un produit de Classe A. Le fonctionnement de cet équipement dans une zone résidentielle risque de causer des interférences nuisibles, auquel cas l'utilisateur devra y remédier à ses propres frais.

⚠ Caution:

ACHTUNG

Dies ist ein Gerät der Klasse A. Bei Einsatz des Geräts in Wohngebieten kann es Störungen des Radio- und Fernsehempfangs verursachen. In diesem Fall muss der Benutzer alle notwendigen Maßnahmen ergreifen, die möglicherweise nötig sind, um die Störungen auf eigene Rechnung zu beheben.

⚠ Caution:

PRECAUCIÓN

Este es un producto clase A. El uso de este equipo en áreas residenciales puede causar interferencias nocivas, en cuyo caso, se requerirá que los usuarios tomen cualquier medida necesaria para corregir la interferencia por cuenta propia.

⚠ Caution:

CUIDADO

Este dispositivo é um produto Classe A. Operar este equipamento em uma área residencial provavelmente causará interferência prejudicial; neste caso, espera-se que os usuários tomem as medidas necessárias para corrigir a interferência por sua própria conta.

⚠ Caution:

ATTENZIONE

Questo dispositivo è un prodotto di Classe A. Il funzionamento di questo apparecchio in aree residenziali potrebbe causare interferenze dannose, nel cui caso agli utenti verrà richiesto di adottare tutte le misure necessarie per porre rimedio alle interferenze a proprie spese.

Electrostatic discharge caution statement

⚠ Electrostatic alert:

ESD

To prevent damage from electrostatic discharge, always wear an antistatic wrist strap connected to an electrostatic discharge (ESD) jack when you perform maintenance on this product. Ensure that the wrist strap makes contact with your skin.

⚠ Electrostatic alert:

ATTENTION

ESD (décharge électrostatique)

Pour prévenir tout dommage dû à une décharge électrostatique, vous devez toujours porter un bracelet antistatique connecté à une prise pour décharge électrostatique (ESD) lors de l'exécution d'opérations de maintenance sur ce produit. Assurez-vous que le bracelet antistatique est en contact avec votre peau.

⚠ Electrostatic alert:

ACHTUNG

ESD

Um Schäden durch elektrostatische Entladung zu verhindern, tragen Sie bei der Instandhaltung dieses Produkts immer ein antistatisches Band am Handgelenk, das mit einer ESD-Buchse verbunden ist. Stellen Sie

⚠ Electrostatic alert:

PRECAUCIÓN

ESD (Descarga electrostática)

Para prevenir el daño producido por una descarga electrostática, use siempre una pulsera antiestática conectada a un enchufe de descarga electrostática (ESD) al realizar el

mantenimiento de este producto. Asegúrese de que la pulsera antiestática haga contacto con su piel.

⚠ Electrostatic alert:

CUIDADO

ESD

Para evitar danos com descarga eletrostática, sempre use uma pulseira antiestática que esteja conectada a uma tomada de descarga eletrostática (ESD) quando estiver realizando a manutenção deste produto. Certifique-se de que a pulseira esteja em contato com sua pele.

⚠ Electrostatic alert:

ATTENZIONE

ESD

Per evitare danni derivanti da scariche elettrostatiche, indossare sempre un polsino antistatico collegato a una presa di scarico elettrostatico (ESD) durante la manutenzione del prodotto. Accertarsi che il polsino sia a contatto con la pelle.

Laser eye safety warning statement

⚠ Warning:

Risk of eye injury by laser

Fiber optic equipment can emit laser or infrared light that can injure your eyes. Never look into an optical fiber or connector port. Always assume that fiber optic cables connect to a light source.

⚠ Warning:

AVERTISSEMENT

Risques de blessure oculaire par lumière laser

L'équipement de fibres optiques peut émettre une lumière laser ou infrarouge nuisible à vos yeux. Ne regardez jamais en direction de fibres optiques ou d'un port connecteur. Supposez toujours que les câbles de fibres optiques sont connectés à une source de lumière.

⚠ Warning:

WARNUNG

Risiko einer Augenverletzung durch Laser

Risiko einer Augenverletzung durch Laser Glasfasergeräte können Laserstrahlen oder ultraviolettes Licht aussenden, das Ihre Augen verletzen kann. Schauen Sie nie direkt in einen Glasfaserleiter oder Verbindungsanschluss. Gehen Sie immer davon aus, dass Glasfaserkabel mit einer Lichtquelle verbunden sind.

⚠ Warning:

ADVERTENCIA

Riesgo de lesión en los ojos por láser

El equipo de fibra óptica puede emitir una luz láser o infrarroja que dañe sus ojos. Nunca mire un puerto de fibra óptica o conector. Siempre asuma que los cables de fibra óptica están conectados a una fuente de luz.

⚠ Warning:

AVISO

O laser pode causar ferimentos no olho

O equipamento de fibra óptica pode emitir laser ou luz infravermelha que pode causar danos a sua vista. Nunca olhe para dentro da fibra óptica ou da porta do conector. Tenha sempre em mente que os cabos de fibra óptica estão ligados a uma fonte de luz.

⚠ Warning:

AVVISO

Rischio di ustioni agli occhi dovute al laser

Le apparecchiature con fibre ottiche possono emettere raggi laser o infrarossi in grado di provocare ferite agli occhi. Non guardare mai all'interno di una porta di connessione o una fibra ottica. Tenere sempre presente che i cavi a fibra ottica sono collegati a una sorgente luminosa.

Laser eye safety connector inspection warning statement

⚠ Warning:

Risk of eye injury

When you inspect a connector, ensure that light sources are off. The light source used in fiber optic cables can damage your eyes.

⚠ Warning:

AVERTISSEMENT

Risques de blessure oculaire

Assurez-vous que toutes les sources de lumière ont été désactivées avant de procéder au contrôle d'un connecteur. La source de lumière utilisée dans les câbles de fibres optiques risque de provoquer des lésions oculaires.

⚠ Warning:

WARNUNG

Verletzungsrisiko der Augen

Achten Sie bei der Kontrolle der Anschlüsse darauf, dass die Lichtquellen abgeschaltet sind. Die für die Glasfaserkabel verwendeten Lichtquellen können Augenschäden hervorrufen.

 **Warning:**

ADVERTENCIA

Riesgo de lesiones oculares

Quando inspeccione un conector, controle que las fuentes de luz estén apagadas. La fuente de luz que utilizan los cables de fibra óptica puede ocasionar daños en la vista.

 **Warning:**

AVISO

Risco de ferimento nos olhos

Ao inspecionar um conector, verifique se as fontes luminosas estão desligadas. A fonte luminosa usada nos cabos de fibra óptica pode causar danos a seus olhos.

 **Warning:**

AVVISO

Rischio di lesioni agli occhi

Quando si esamina un connettore, assicurarsi che le sorgenti di luce siano spente. La sorgente di luce utilizzata nei cavi a fibre ottiche potrebbero danneggiare gli occhi.

Connector cleaning safety warning statement

 **Warning:**

Risk of eye injury

When you inspect a connector, ensure that light sources are off. The light source used in fiber optic cables can damage your eyes. To avoid getting debris in your eyes, wear safety glasses when you work with the canned air duster. To avoid eye irritation on contact, wear safety glasses when you work with isopropyl alcohol.

 **Warning:**

AVERTISSEMENT

Risques de blessure oculaire

Assurez-vous que toutes les sources de lumière ont été désactivées avant de procéder au contrôle d'un connecteur. La source de lumière utilisée dans les câbles de fibres optiques risque de provoquer des lésions oculaires. Pour éviter tout risque de projection vers les yeux, portez des lunettes de protection lorsque vous utilisez la bombe dépoussiérante à air comprimé. Pour éviter tout risque d'irritation oculaire, portez des lunettes de protection lorsque vous utilisez de l'alcool à 90°.

⚠ Warning:

WARNUNG

Verletzungsrisiko der Augen

Achten Sie bei der Kontrolle der Anschlüsse darauf, dass die Lichtquellen abgeschaltet sind. Die für die Glasfaserkabel verwendeten Lichtquellen können Augenschäden hervorrufen. Zum Schutz vor Schmutzteilchen tragen Sie eine Schutzbrille, wenn Sie mit einem Pressluft-Spray arbeiten. Zum Schutz vor Augenirritationen tragen Sie eine Schutzbrille, wenn Sie mit Isopropanol arbeiten.

⚠ Warning:

ADVERTENCIA

Riesgo de lesiones

Cuando inspeccione un conector, controle que las fuentes de luz estén apagadas. La fuente de luz que utilizan los cables de fibra óptica puede ocasionar daños en la vista. Cuando trabaje con el pulverizador de aire envasado, utilice gafas de seguridad para evitar el ingreso de residuos en los ojos. Utilice gafas de seguridad cuando trabaje con alcohol isopropilo para evitar irritación en los ojos.

⚠ Warning:

AVISO

Risco de ferimento nos olhos

Ao inspecionar um conector, verifique se as fontes luminosas estão desligadas. A fonte luminosa usada nos cabos de fibra óptica pode causar danos a seus olhos. Para evitar que seus olhos sejam atingidos por resíduos, use óculos de segurança ao trabalhar com lata de ar comprimido. Para evitar irritação dos olhos, use óculos de segurança ao trabalhar com álcool isopropílico.

⚠ Warning:

AVVISO

Rischio di lesioni agli occhi

Quando si esamina un connettore, assicurarsi che le sorgenti di luce siano spente. La sorgente di luce utilizzata nei cavi a fibre ottiche potrebbero danneggiare gli occhi. Per evitare l'accidentale introduzione di detriti negli occhi, indossare gli occhiali di sicurezza quando si lavora con un'impolveratrice ad aria compressa. Per evitare irritazioni oculari da contatto, indossare gli occhiali di sicurezza quando si lavora con alcool isopropilico.

Optical fiber damage caution statement

⚠ Caution:

Risk of equipment damage

Do not crush fiber optic cable. If fiber optic cable is in the same tray or duct with large, heavy electrical cables, the weight of the electrical cable can damage the fiber optic cable.

 **Caution:**

ATTENTION

Risques d'endommagement de l'équipement

N'exercez pas de pression sur les câbles de fibres optiques. Ne placez pas de câbles de fibres optiques dans la même caisse ou dans le même fourreau que des câbles électriques lourds car leur poids risquerait de les endommager.

 **Caution:**

ACHTUNG

Risiko von Geräteschäden

Das Glasfaserkabel darf nicht zerdrückt werden. Wenn sich ein Glasfaserkabel zusammen mit großen und schweren Elektrokabeln im gleichen Kabelkanal oder in der gleichen Führung befindet, kann es durch das Gewicht der Elektrokabel beschädigt werden.

 **Caution:**

PRECAUCIÓN

Riesgo de daños en los equipos

Evite aplastar los cables de fibra óptica. Si el cable de fibra óptica se encuentra en la misma bandeja o conducto que otros cables eléctricos grandes y pesados, puede dañarse.

 **Caution:**

CUIDADO

Risco de danos ao equipamento

Não amasse o cabo de fibra ótica. Se o cabo de fibra ótica estiver na mesma bandeja ou duto com cabos elétricos longos e pesados, ele pode ser danificado pelo peso do cabo elétrico.

 **Caution:**

ATTENZIONE

Rischio di danno all'apparecchio

Non schiacciare o piegare il cavo a fibre ottiche. Se il cavo a fibre ottiche è posizionato in un vassoio o condotto con cavi elettrici pesanti e di grosse dimensioni, esso potrebbe essere danneggiato dal peso dei cavi elettrici.

Optical fiber connector damage caution statement

 **Caution:**

Risk of equipment damage

To prevent further contamination, clean fiber optic equipment only when you see evidence of contamination.

To prevent contamination, cover the optical ports of all active devices with a dust cap or optical connector.

To avoid the transfer of oil or other contaminants from your fingers to the end face of the ferrule, handle connectors with care.

 **Caution:**

ATTENTION

Risques d'endommagement de l'équipement

Pour éviter tout risque de nouvelle contamination, nettoyez uniquement le matériel en fibre optique lorsque les preuves de contamination sont avérées.

Pour éviter tout risque de contamination, assurez-vous que tous les ports optiques des périphériques sous tension sont protégés par un capuchon anti-poussière ou par un connecteur optique.

Manipulez les connecteurs avec précaution afin d'éviter toute application d'huile provenant de vos doigts ou d'autres contaminants sur l'extrémité de la ferrule.

 **Caution:**

VORSICHT

Risiko von Geräteschäden

Zur Vermeidung weiterer Verunreinigungen reinigen Sie die Glasfaser-Ausrüstung nur dann, wenn sie offensichtlich kontaminiert ist.

Zur Vermeidung von Verunreinigungen schützen Sie die optischen Ports aller aktiven Geräte mit einer Staubkappe oder einem optischen Steckverbinder.

Zur Vermeidung von Verunreinigungen des hinteren Muffenteils durch Öl von den Fingern oder durch andere Kontaminationsstoffe behandeln Sie die Anschlüsse vorsichtig.

 **Caution:**

PRECAUCIÓN

Riesgo de daños en los equipos

Limpie los equipos de fibra óptica únicamente cuando existan rastros de contaminación para evitar diseminarla aun más.

Para evitar la contaminación, controle que los puertos ópticos de todos los dispositivos activos estén cubiertos con una tapa protectora o un conector óptico.

Maneje los conectores con cuidado para no contaminar la superficie de los casquillos con la grasa de los dedos ni otros contaminantes.

 **Caution:**

CUIDADO

Risco de danos ao equipamento

Para evitar contaminação futura, limpe o equipamento ótico apenas quando houver evidência de contaminação.

Para evitar a contaminação, verifique se as portas óticas de todos os dispositivos ativos estão cobertas com uma proteção contra pó ou conector ótico.

Para evitar a transferência de óleo ou outro agente contaminador de seus dedos para a extremidade final da ponteira, manuseie os conectores com cuidado.

⚠ Caution:

ATTENZIONE

Rischio di danno all'apparecchio

Per evitare ulteriori contaminazioni, pulire l'apparecchio a fibre ottiche solo in presenza di evidente contaminazione.

Per evitare contaminazioni, assicurarsi che le porte ottiche di tutti i dispositivi attivi siano coperte da un tappo antipolvere o da un connettore ottico.

Per evitare il trasferimento di olio o di altri agenti contaminanti dalle dita alla parte finale della ghiera, maneggiare con cura i connettori.

SFP damage caution statement

⚠ Caution:

Risk of equipment damage

SFPs are keyed to prevent incorrect insertion. If the SFP resists pressure, do not force it; turn it over, and reinsert it.

⚠ Caution:

ATTENTION

Risques d'endommagement de l'équipement

Afin d'éviter tout risque d'insertion incorrecte, les modules SFP sont verrouillés. Si vous ne parvenez pas à insérer un module SFP, ne forcez pas. Retournez-le et renouvelez l'opération.

⚠ Caution:

VORSICHT

Risiko von Geräteschäden

Die SFPs sind so konstruiert, dass ein falsches Einsetzen verhindert wird. Lässt sich ein SFP auch auf Druck hin nicht einsetzen, versuchen Sie nicht, es gewaltsam einzusetzen, sondern drehen Sie es um, und setzen Sie es erneut ein.

⚠ Caution:

PRECAUCIÓN

Riesgo de daños en los equipos

Los módulos SFP cuentan con cuñas que no permiten insertarlos de forma incorrecta. Si el módulo SFP opone resistencia a la presión, no lo fuerce; gírelo e insértelo nuevamente.

 **Caution:**

CUIDADO

Risco de danos ao equipamento

Os SFPs são chaveados para evitar inserção indevida. Se o SFP resistir à pressão, não o force; inverta e recoloque-o.

 **Caution:**

ATTENZIONE

Rischio di danni all'apparecchio

Gli SFP dispongono di chiavi in modo da evitarne l'inserimento errato. Se l'SFP resiste alla pressione, non forzarlo ma capovolgerlo e reinserirlo.

Chapter 4: Equipment care

About this task

Read this section before you install small form factor pluggable (SFP) and SFP plus (SFP+) transceivers.

SFPs and SFP+s are static sensitive.

Dust contamination can reduce the performance of optical parts in transceivers. When you store a transceiver, or after you disconnect it from a fiber optic cable, always keep a dust cover over the optical bore.

Dispose of this product according to all national laws and regulations.

To prevent equipment damage, observe the following electrostatic discharge (ESD) precautions when you handle or install the components:

- Ground yourself and the equipment to an earth or building ground. Use a grounded workbench mat (or foam that dissipates static charge) and a grounding wrist strap. The wrist strap must touch the skin and you must ground it through a one megaohm resistor.
- Do not touch anyone who is not grounded.
- Leave all components in their ESD-safe packaging until installation, and use only a static-shielding bag for all storage, transport, and handling.
- Clear the area of synthetic materials such as polyester, plastic, vinyl, or styrofoam because these materials carry static electricity that damages the equipment.

Fiber optic equipment care

You must keep fiber optic equipment connections clean and damage-free. Use the information in this job aid to properly maintain and care for fiber optic equipment.

Fiber optic cable care

Although reinforcing material and plastic insulation protects the glass fiber in fiber optic cable, it is subject to damage. Use the following precautions to avoid damaging the glass fiber.

- Do not kink, knot, or vigorously flex the cable.
- Do not bend the cable to less than a 40 mm radius.
- Do not stand on fiber optic cable; keep the cable off the floor.
- Do not pull fiber optic cable harder than you do a cable containing copper wire of comparable size.
- Do not allow a static load of more than a few pounds on a section of the cable.

- Place protective caps on fiber optic connectors that are not in use.
- Store unused fiber optic patch cables in a cabinet, on a cable rack, or flat on a shelf.

Frequent overstressing of fiber optic cable causes progressive degeneration that leads to failure.

If you suspect damage to a fiber optic cable, either due to mishandling or an abnormally high error rate observed in one direction, reverse the cable pairs. If the high error rate appears in the other direction, replace the cable.

⚠ Caution:

Risk of equipment damage

Do not crush fiber optic cable. If fiber optic cable is in the same tray or duct with large, heavy electrical cables, the weight of the electrical cable can damage the fiber optic cable.

Fiber optic connector care

Before you connect fiber optic connectors to transmission equipment, test equipment, patch panels, or other connectors, ensure fiber optic connectors are clean. The performance of an optical fiber connector depends on how clean the connector and coupling are at the time of connection.

A damaged or dirty connector can damage a connector with which it pairs. A connector must be clean before you insert it into a transmitter or receiver.

Never clean an optical connector while it carries light. Optical power can cause ignition of the cleaning material when it contacts the end of the optical connector and can destroy the connector. Typical cleaning materials, for example, tissues saturated with alcohol, combust almost instantaneously after you expose them to optical power levels of +15 dBm or higher.

Visually inspect the connector to determine cleanliness and to determine if it needs replacing. You must replace a connector that has a scratch across the core, or a scratch that appears to end in the core.

The proper connector cleaning method depends on the connector contaminants:

- Judge cleanliness by visual inspection with a fiber microscope. First inspect the connector, and then clean as required.

⚠ Warning:

Risk of eye injury

When you inspect a connector, ensure that light sources are off. The light source in fiber optic cables can damage your eyes.

- If you suspect only the possibility of dust particles, for example, if you leave a connector uncapped in a clean environment, use high-quality canned air or a reel cleaner, for example, a Cletop, to clean the connector. A reel cleaner is a good choice to ensure that no dust contaminates the connector.
- If the connector is visibly dirty or you suspect contamination by chemicals (for example, matching gel), use high-quality alcohol and canned air to clean the connector. This

method is the most thorough cleaning method. In some cases, a reel cleaner can suffice.

The more surface manipulation you apply to the connector, the more likely you are to damage the connector.

When you insert a connector ferrule into a connector or adapter, ensure that the ferrule tip does not touch the outside of the mating connector or adapter. This action can produce scratches and dirt deposits on the connector.

To help prevent connectors from collecting dust, cover them when not in use. To avoid the transfer of oil or other contaminants from your fingers to the end face of the ferrule, handle connectors with care. Do not touch the connector end face.

Cleaning single connectors

Clean connectors so that the optical signal is minimally attenuated by the connector.

Perform this procedure if you suspect more than dust contamination.

Before you begin

- You need a lens-grade, lint-free tissue, for example, Kimwipes.
- You need an optical-grade isopropyl alcohol (IPA) (98% or more pure).
- You need a high-quality canned compressed air with extension tube.

Compressed air must be free of dust, water, and oil, or filmy deposits or scratches on the surface of the connector can result.

- You need a fiber optic microscope to inspect connectors.

Warning:

Risk of eye injury

When you inspect a connector, ensure that light sources are off. The light source used in fiber optic cables can damage your eyes.

To avoid getting debris in your eyes, wear safety glasses when you work with the canned air duster.

To avoid eye irritation on contact, wear safety glasses when you work with isopropyl alcohol.

Procedure

1. Remove dust or debris by applying canned air to the cylindrical and end-face surfaces of the connector.

2. Gently wipe the cylindrical and end-face surfaces with a tissue dampened with optical-grade isopropyl alcohol.
3. Gently wipe the cylindrical and end-face surfaces with a dry tissue.

Important:

Do not let the IPA evaporate; wipe it dry immediately. Alcohols can leave a residue that is difficult to remove.

4. Dry the connector surfaces by applying canned air.
5. Inspect the connector to ensure it is clean and undamaged.
To prevent contamination, do not touch the connector surfaces after cleaning; and cover connectors with dust caps if they are not in use.

Cleaning duplex connectors

Clean connectors so that the optical signal is minimally attenuated by the connector.

Perform this procedure when you suspect more than dust contamination.

Before you begin

- You need a lens-grade, lint-free tissue, for example, Kimwipes.
- You need an optical-grade isopropyl alcohol (IPA) (98% or more pure).
- You need a high-quality canned compressed air with extension tube.

Compressed air must be free of dust, water, and oil, or filmy deposits or scratches on the surface of the connector can result.

- You need a fiber optic microscope to inspect connectors.

About this task

 **Warning:**

Risk of eye injury

When you inspect a connector, ensure that light sources are off. The light source in fiber optic cables can damage your eyes.

To avoid getting debris in your eyes, wear safety glasses when you work with the canned air duster.

To avoid eye irritation on contact, wear safety glasses when you work with isopropyl alcohol.

Procedure

1. Remove or retract the shroud.
On removable shroud connectors, hold the shroud on the top and bottom at the letter designation, apply medium pressure, and then pull it free from the connector body. Do not discard the shroud.

OR

On retractable shroud connectors, hold the shroud in the retracted position.

2. Remove dust or debris by applying canned air to the cylindrical and end-face surfaces of the connector.
3. Gently wipe the cylindrical and end-face surfaces of both ferrules using a tissue saturated with optical-grade isopropyl alcohol.
4. Gently wipe the cylindrical and end-face surfaces with a dry tissue.

Important:

Do not let the IPA evaporate; wipe it dry immediately. Alcohols can leave a residue that is difficult to remove.

5. Blow dry the connector surfaces with canned air.
 6. Inspect the connector to ensure it is clean and undamaged.
 7. Using care to not touch the clean ferrules, gently push the shroud back onto the connector until it seats and locks in place.
-

Cleaning receptacles

Clean connector receptacles or ports so that the optical signal is minimally attenuated by the connection.

Before you begin

- You need an optical-grade isopropyl alcohol (IPA) (98% or more pure).
- You need cleaning swabs (also called cleaning sticks or wands).
- You need a high-quality canned compressed air with extension tube.

Compressed air must be free of dust, water, and oil, or filmy deposits or scratches on the surface of the connector can result.

Caution:

Risk of equipment damage

To avoid contamination, only clean optical ports if you see evidence of contamination or reduced performance exists, or during their initial installation.

To prevent oil contamination of connectors, use only high-quality canned compressed air.

Do not allow the air extension tube to touch the bottom of the optical port.

Procedure

1. Remove dust or debris by blowing canned air into the optical port of the device using the canned air extension tube.
2. Clean the optical port by inserting a wand moistened with alcohol into the receptacle and rotating it.
Use each cleaning wand to clean only one optical port.
3. Dry the optical port by inserting a dry wand into the receptacle and rotating it.

Important:

Do not let the IPA evaporate; wipe it dry immediately. Alcohols can leave a residue that is difficult to remove.

4. Remove lint by blowing compressed air into the optical port.
 5. Reconnect the optical connector and check for proper function.
If you do not reinstall the connector, use a protective cap.
If problems persist, ensure that the connector or receptacle is free from damage.
-

Chapter 5: SFP transceivers

About this task

This section describes how to select and install small form factor pluggable (SFP) transceivers.

Selecting an SFP

Use an SFP transceiver to connect a device motherboard to a fiber optic or unshielded twisted pair network cable. Select the appropriate transceiver to provide the required reach.

Procedure

1. Determine the required reach.
Depending on the product, you can obtain SFPs for cable distances of up to 100 meters (m), 550 m, 10 kilometers (km), 40 km, 70 km, and 120 km.
2. Determine the required media and connector type.
You need fiber optic cable for a reach over 100 m.
Possible media include CAT5, single mode fiber, and multimode fiber. Possible connectors include Lucent connector (LC) and RJ-45.
3. If the media is optical fiber, determine wavelength restrictions or requirements.
To expand available bandwidth on a common optical fiber, use Coarse Wavelength Division Multiplexing (CWDM) SFPs.

Related topics:

[Job aid](#) on page 31

Job aid

The following table describes the reach provided by various SFPs. This table is informational only—not all Avaya products support all the SFPs listed here.

SFP model	Common application
1000BASE-T	Lowest-cost gigabit Ethernet solution. Up to 100 m reach over Category 5 (CAT5) unshielded twisted pair (UTP).

SFP model	Common application
1000BASE-SX	Well-suited for campus local area networks (LAN) and intrabuilding links. Up to 275 or 550 m reach (fiber-dependent) over a fiber pair.
1000BASE-LX	Up to 10 km reach over a single mode fiber (SMF) pair. Up to 550 m reach over a multimode fiber (MMF) pair.
1000BASE-XD	Up to 40 km reach over a single mode fiber pair.
1000BASE-ZX	Up to 70 km reach over a single mode fiber pair.
1000BASE-BX	Up to 40 km reach. Bidirectional over one single mode fiber.
1000BASE-EX	Up to 120 km reach over a single mode fiber pair.

SFPs are hot-swappable input and output enhancement components that permit Gigabit Ethernet ports to link with other Gigabit Ethernet ports over various media types.

The system also supports Coarse Wavelength Division Multiplexer (CWDM) SFPs. CWDM technology consolidates multiple optical channels on a common optical fiber. CWDM uses multiple wavelengths to expand available bandwidth.

CWDM SFPs support high speed data communications for Metropolitan Area Networks (MAN). The system uses a grid of eight CWDM optical wavelengths in both ring and point-to-point configurations. All components are color-coded by wavelength.

Important:

The attainable cable length can vary depending on the quality of the fiber optic cable used.

The following table lists and describes the Avaya SFP models the Virtual Services Platform 7000 Series supports.

Model	Supported on the 7024XLS	ROHS product number	Description
1000BASE-T	Yes	AA1419043-E6	CAT5 UTP, up to 100 m. The 1000BASE-T device is all electrical.
1000BASE-SX	Yes	AA1419048-E6	850 (nm), up to 275 or 550 m
1000BASE-LX	Yes	AA1419049-E6	1310 nm, up to 10 km
1000BASE-XD	Yes	AA1419050-E6	1310 nm, up to 40 km
	Yes	AA1419051-E6	1550 nm, up to 40km (non-CWDM)
1000BASE-ZX	Yes	AA1419052-E6	1550 nm, up to 70 km (non-CWDM)
1000BASE-BX-U	Yes	AA1419069-E6	1310nm up to 10km
	Yes	AA1419076-E6	1310nm up to 40km

Model	Supported on the 7024XLS	ROHS product number	Description
1000BASE-BX-D	Yes	AA1419070-E6	1490nm up to 10km
	Yes	AA1419077-E6	1490nm up to 40km
1000BASE-EX	Yes	AA1419071-E6	1550 nm, up to 120 km (non-CWDM)
1000BASE CWDM	Yes	AA1419053-E6	1470 nm, up to 40 km
	Yes	AA1419054-E6	1490 nm, up to 40 km
	Yes	AA1419055-E6	1510 nm, up to 40 km
	Yes	AA1419056-E6	1530 nm, up to 40 km
	Yes	AA1419057-E6	1550 nm, up to 40 km
	Yes	AA1419058-E6	1570 nm, up to 40 km
	Yes	AA1419059-E6	1590 nm, up to 40 km
	Yes	AA1419060-E6	1610 nm, up to 40 km
	Yes	AA1419061-E6	1470 nm, up to 70 km
	Yes	AA1419062-E6	1490 nm, up to 70 km
	Yes	AA1419063-E6	1510 nm, up to 70 km
	Yes	AA1419064-E6	1530 nm, up to 70 km
	Yes	AA1419065-E6	1550 nm, up to 70 km
	Yes	AA1419066-E6	1570 nm, up to 70 km
	Yes	AA1419067-E6	1590 nm, up to 70 km
Yes	AA1419068-E6	1610 nm, up to 70 km	

Installing an SFP

Install an SFP to provide an interface between the device and the network cable.

Before you begin

- Verify that the SFP is the correct model for your network configuration.
- Verify the ports are configured to support SFP (10Gbps) transceivers.
- Before you install the optical connector, ensure it is clean.

⚠ Warning:

Risk of eye injury by laser

Fiber optic equipment can emit laser or infrared light that can injure your eyes. Never look into an optical fiber or connector port. Always assume that fiber optic cables connect to a light source.

⚠ Electrostatic alert:

Risk of equipment damage

To prevent damage from electrostatic discharge, always wear an antistatic wrist strap connected to an ESD jack.

⚠ Caution:

Risk of equipment damage

Only trained personnel can install this product.

⚠ Caution:

Risk of equipment damage

SFP transceivers are keyed to prevent incorrect insertion. If the SFP resists pressure, do not force it; turn it over, and reinsert it.

About this task

Installing an SFP takes approximately three minutes.

Procedure

1. Remove the SFP from its protective packaging.
2. Grasp the SFP between your thumb and forefinger.
3. As shown in the following figure, insert the device into the port.
Apply a light pressure to the SFP until the device clicks and locks into position in the port.

Important:

The lower port row is inverted. You must invert the SFP device to correctly insert the device into a lower port.

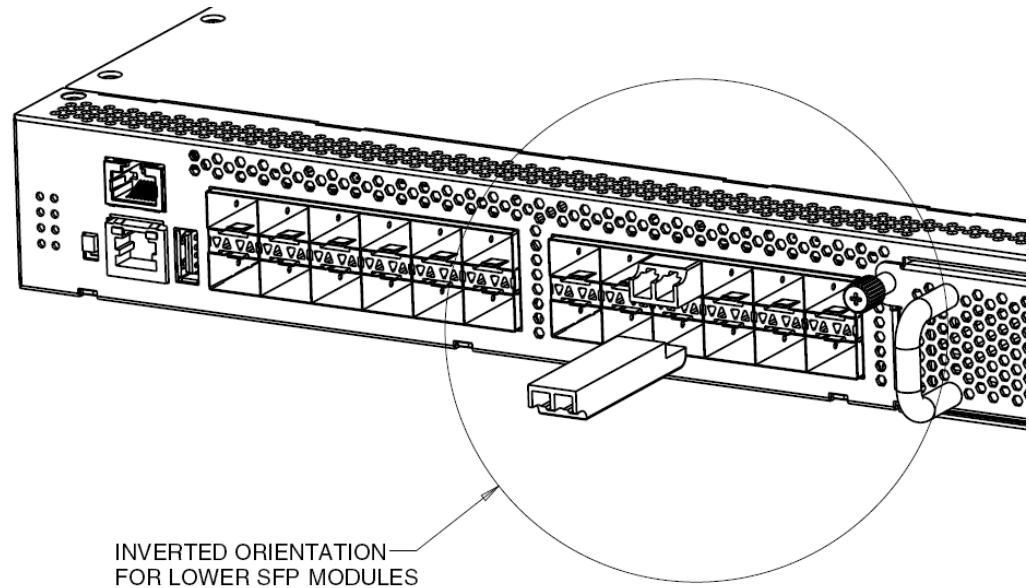

4. Remove the dust cover from the optical bore and insert the fiber optic connector.

Related topics:

[Job aid](#) on page 35

Job aid

Depending on the transceiver manufacturer, the SFP transceiver can use different types of locking and extractor mechanisms.

The following figures show typical mechanisms used on SFP transceivers; other locking and extractor mechanisms exist, although they are not shown here. In the following figure, the SFP still uses the bore plug. Pull the bail to release the device.

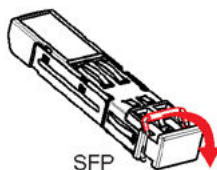

The following figure shows the wrap-around latch-type extraction mechanism. To remove the device, push the collar towards the module.

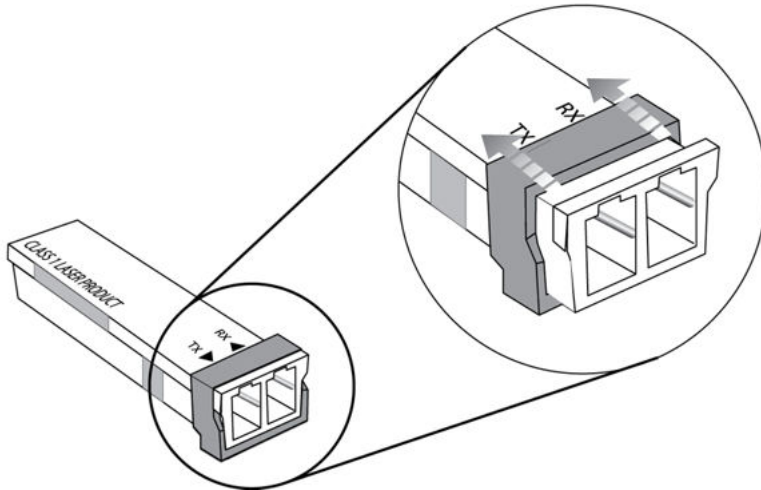

Removing an SFP

Remove an SFP to replace it or to commission it elsewhere.

Before you begin

- Wear an antistatic wrist strap.

⚠ Warning:

Risk of eye injury by laser

Fiber optic equipment can emit laser or infrared light that can injure your eyes. Never look into an optical fiber or connector port. Always assume that fiber optic cables connect to a light source.

⚠ Electrostatic alert:

Risk of equipment damage

To prevent damage from electrostatic discharge, always wear an antistatic wrist strap connected to an ESD jack.

Procedure

1. Disconnect the network fiber optic cable from the SFP connector.
2. Depending on your SFP model, to release the SFP, pull the latch handle and use it to extract the module.
3. Slide the SFP out of the module SFP slot.

If the SFP does not slide easily from the module slot, use a gentle side-to-side rocking motion while firmly pulling the SFP from the slot.

4. Affix dust covers over the fiber optic bore and connector.
5. Store the SFP in a safe place until needed.

Important:

If you discard the SFP, dispose of it according to all national laws and regulations.

Chapter 6: SFP+ transceivers

About this task

This section describes how to select and install small form factor pluggable plus (SFP+) transceivers.

Use an SFP+ to connect a device motherboard to a fiber optic or direct attached cables. SFP+ transceivers are similar to SFPs in physical appearance but SFP+ transceivers provide Ethernet at 10 gigabit per second (Gb/s).

Important:

Avaya recommends that you only use Avaya-qualified transceivers. If you use other vendor transceivers, Avaya does not support them.

Selecting an SFP+

Use an SFP+ transceiver to interface a switch port to a fiber optic cable. Select the appropriate transceiver to provide the required reach.

Procedure

1. Determine the required reach.
Depending on the product, you can obtain a SFP+ for cable distances of up to 40 km.
2. Determine wavelength restrictions or requirements.
3. Use the following job aid to determine the appropriate SFP+ for your application.

Related topics:

[Job aid](#) on page 39

Job aid

SFP+ transceivers are hot-swappable input and output enhancement components that allow 10 Gigabit Ethernet ports to link with other 10 Gb Ethernet ports.

All Avaya SFP+ transceivers use Lucent connectors (LC) to provide precision keying and low interface losses.

The following table lists and describes the Avaya SFP+ models. [SFP+ specifications](#) on page 55 provides more information about these SFP+s.

Model number	Product number	Description
10GBASE-SR	AA1403015-E6	850 nanometers (nm). The range is up to <ul style="list-style-type: none"> • 22 m using 62.5 micrometer (μm), 160 megaHertz times km (MHz-km) MMF • 33 m using 62.5 μm, 200 MHz-km MMF • 66 m using 62.5 μm, 500 MHz-km MMF • 82 m using 50 μm, 500 MHz-km MMF • 300 m using 50 μm, 2000 MHz-km MMF • 400 m using 50 μm, 4700 MHz-km MMF
10GBASE-LRM	AA1403017-E6	1310 nm. Up to 220 m reach over Fiber Distributed Data Interface (FDDI)-grade 62.5 μm multimode fiber. Suited for campus LANs.
10GBASE-LR	AA1403011-E6	1310 nm SMF. The range is up to 10 km.
10GBASE-ER	AA1403013-E6	1550 nm SMF. The range is up to 40 km.
10GBASE-CX1 Direct Attach Cables	AA1403018-E6 to AA1403020-E6	SFP+ twinaxial copper cable to connect 10 Gb ports. The maximum range is 10 m.

Installing an SFP+

Install an SFP+ to provide a 10 Gb Ethernet interface between the device and other network devices.

Before you begin

Important:

Do not install an SFP+ transceiver in an SFP slot. The two transceivers look the same but function differently. Ensure the slot is an SFP+ slot.

- Verify that the SFP+ is the correct model for your network configuration.
- Verify the ports are configured to support SFP+ (10 gbps) transceivers.
- Before you install the optical connector, ensure it is clean.

⚠ Warning:

Risk of eye injury by laser

Fiber optic equipment can emit laser or infrared light that can injure your eyes. Never look into an optical fiber or connector port. Always assume that fiber optic cables connect to a light source.

⚠ Electrostatic alert:

Risk of equipment damage

To prevent damage from electrostatic discharge, always wear an antistatic wrist strap connected to an ESD jack.

⚠ Caution:

Risk of equipment damage

Only trained personnel can install this product.

⚠ Caution:

Risk of equipment damage

SFP+ transceivers are keyed to prevent incorrect insertion. If the SFP+ resists pressure, do not force it; turn it over, and reinsert it.

About this task

Installing an SFP+ takes approximately three minutes.

Procedure

1. Remove the SFP+ from its protective packaging.
2. Grasp the SFP+ between your thumb and forefinger.
3. As shown in the following figure, insert the device into an SFP+ port.
Apply a light pressure to the SFP+ until the device clicks and locks into position in the port.

Important:

The lower port row is inverted. You must invert the SFP+ device to correctly insert the device into a lower port.

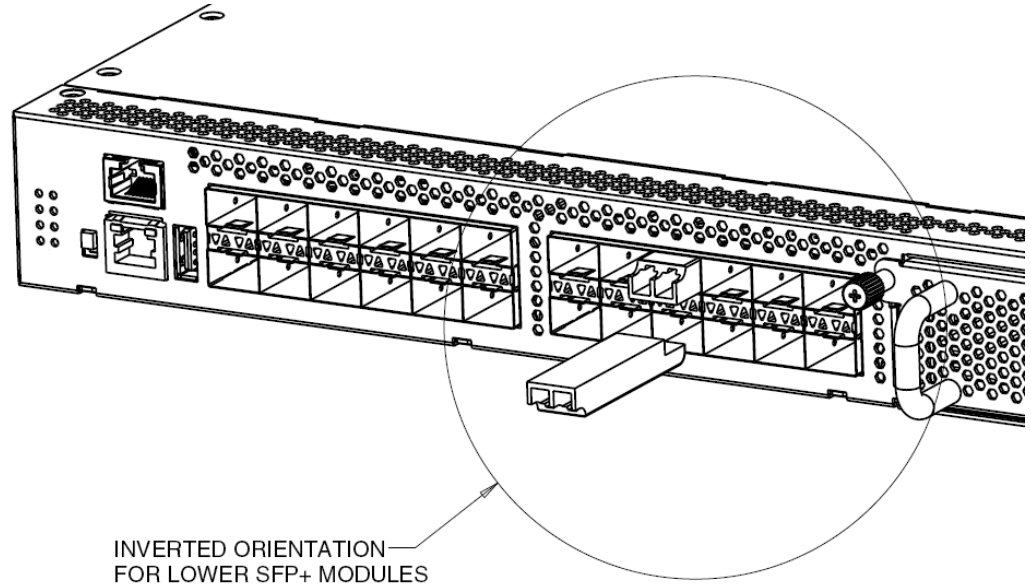

4. Remove the dust cover from the SFP+ optical bores and insert the fiber optic cable.

Related topics:

[Job aid](#) on page 42

Job aid

Depending on the transceiver manufacturer, the SFP+ transceiver uses bail-latch type of locking and extractor mechanism.

The following figure shows typical mechanism used on SFP+ transceivers; other locking and extractor mechanisms exist. SFP+ transceivers are similar to SFPs in physical appearance. In the following figure, the SFP+ uses the bore plug. Pull the bail to release the device.

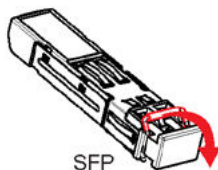

Removing an SFP+

Remove an SFP+ to replace it or to commission it elsewhere.

About this task

⚠ Warning:

Risk of eye injury by laser

Fiber optic equipment can emit laser or infrared light that can injure your eyes. Never look into an optical fiber or connector port. Always assume that fiber optic cables connect to a light source.

⚠ Electrostatic alert:

Risk of equipment damage

To prevent damage from electrostatic discharge, always wear an antistatic wrist strap connected to an ESD jack.

Procedure

1. Disconnect the network fiber optic cable from the SFP+ connector.
2. Pull the swing-down latch handle and use it to extract the module.
3. Slide the SFP+ out of the module SFP+ slot.
If the SFP+ does not slide easily from the module slot, use a gentle side-to-side rocking motion while firmly pulling the SFP+ from the slot.
4. Affix dust covers over the fiber optic bore and connector.
5. Store the SFP+ in a safe place until needed.

Important:

If you discard the SFP+, dispose of it according to all national laws and regulations.

Chapter 7: SFP specifications

This section provides technical specifications for the supported small form factor pluggable (SFP) models. Use this information to aid in proper network design.

The specifications in this section meet or exceed those specified in the applicable IEEE standards, where they exist.

In these specifications, unless otherwise noted, receiver sensitivity is the minimum average input optical power for which Avaya guarantees the receiver meets the bit error rate (BER) of 10^{-12} .

Important:

For instances where you install a significant number of long-range SFPs and XFPs, you must be sure to have sufficient power available to power these optical devices.

SFP labels

The Avaya label on a typical SFP contains an Avaya serial number, a bar code, a manufacturer code, an interface type, and a part number.

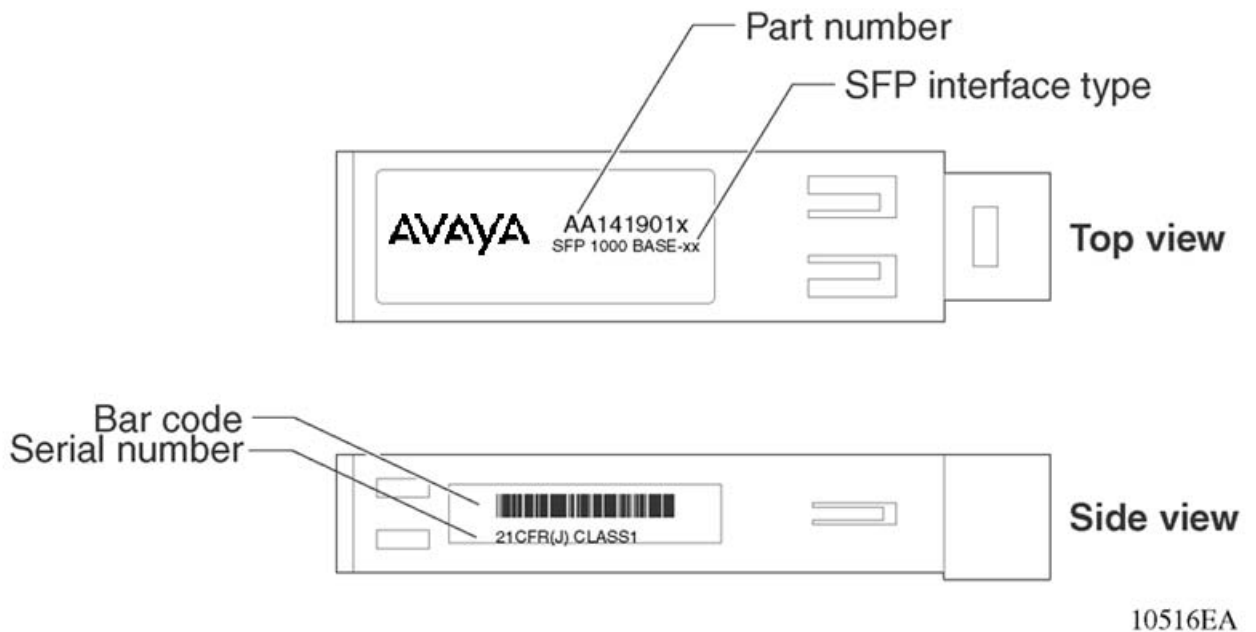

Figure 1: SFP label

General SFP specifications

The following table describes general SFP specifications.

Table 1: General SFP specifications

Parameter	Description
Dimensions (H x W x D)	13.4 x 8.50 x 56.4 millimeters (mm) 0.53 x 0.33 x 2.22 inches (in.) unless otherwise stated
Operating temperature	– 5 to 85C for RoHS -E6 models
Storage temperature	– 40 to 85C
Maximum supply current	300 mA unless otherwise stated
Maximum power consumption	1.0 W unless otherwise stated

SFPs

The following sections provide specifications for supported SFPs:

1000BASE-T SFP specifications

The 1000BASE-T SFP provides gigabit Ethernet connectivity using a single eight-pin RJ-45 connector. The 1000BASE-T SFP only operates at 1 Gb/s and does not support 100BASE-T or 10BASE-T interfaces. The part number for this model is AA1419043-E6.

Important:

You must disable autonegotiation before you operate the 1000BASE-T SFP. After you insert SFPs into certain product-specific modules, the system activates autonegotiation by default.

The maximum current requirement of the SFP is 375 milliamperes (mA) at 5 volts (V).

The following table describes the 1000BASE-T SFP specifications.

Table 2: IEEE 802.3z 1000BASE-T SFP specifications

Parameter	Specifications
Standards	IEEE 802.3z, IEEE 802.3ab
Connectors	RJ-45

Parameter	Specifications
Cabling	CAT5E or better UTP
Distance	Up to 100 m

1000BASE-SX DDI SFP specifications

The following table describes the 1000BASE-SX DDI SFP, which has a reach of up to 550 m using 50 μm MMF, and of 275 m using 62.5 μm MMF. This SFP operates at 850 nm. The part number of this SFP is AA1419048-E6.

Table 3: 1000BASE-SX SFP DDI (550 m) specifications

Parameter	Specifications
Maximum electrical power consumption	1 watt (W)
Connector	Duplex LC
Cabling	MMF
Data rate	1.0 Gb/s
Line rate (8B/10B code)	1.25 Gb/s
Link optical power budget	7.5 dB
Transmitter characteristics	
Launch power	- 9.5 to -4.0 dBm
Receiver characteristics	
Receiver sensitivity	- 17 dBm
Maximum receiver power	0 dBm

1000BASE-LX DDI SFP specifications

This SFP provides 1000BASE-LX gigabit Ethernet connectivity at 1310 nanometers (nm) using single mode or multimode optical fiber. The part number of this SFP is AA1419049-E6.

Table 4: 1000BASE-LX DDI SFP specifications

Parameter	Specifications
Maximum electrical power consumption	1.0 watt (W)
Connectors	Duplex LC
Cabling	<ul style="list-style-type: none"> • 50 micrometer (μm) multimode fiber (MMF) • 62.5 μm multimode fiber • 9 μm single mode fiber (SMF)

Parameter	Specifications
Distance	<ul style="list-style-type: none"> • Up to 550 meters (m) using MMF • Up to 10 kilometers (km) using SMF
Data rate	1.0 Gb/s
Line rate (8B/10B code)	1.25 Gb/s
Link optical power budget	9.5 dB
Transmitter characteristics	
Launch power	– 9.5 to -3.0 dBm
Receiver characteristics	
Receiver sensitivity	– 19.0 dBm
Maximum receiver power	– 3.0 dBm

1000BASE-XD DDI 1310 nm SFP specifications

The following table describes the 1000BASE-XD DDI SFP. This SFP operates at 1310 nm and has a reach of up to 40 km. The part number is AA1419050-E6.

Table 5: 1000BASE-XD DDI 1310 nm SFP specifications

Parameter	Specifications
Maximum electrical power consumption	1.0 W
Connectors	Duplex LC
Cabling	SMF, 9 µm
Data rate	1.0 Gb/s
Line rate (8B/10B) code	1.25 Gb/s
Link optical power budget	18 dB
Transmitter characteristics	
Launch power	– 4.5 to 0 dBm
Receiver characteristics	
Receiver sensitivity	– 22.5 dBm
Maximum receiver power	0 dBm

1000BASE-XD DDI 1550 nm SFP specifications

The following table describes the 1000BASE-XD DDI SFP. This SFP operates at 1550 nm and has a reach of up to 40 km. The part number is AA1419051-E6.

⚠ Caution:**Risk of equipment damage**

To prevent damage to the optical receiver, ensure that at least 3 dB of attenuation exists between the transmit and receive ports.

Table 6: 1000BASE-XD DDI 1550 nm SFP specifications

Parameter	Specification
Maximum electrical power consumption	1.0 W
Connectors	Duplex LC
Cabling	SMF, 9 μm
Data rate	1.0 Gb/s
Line rate (8B/10B code)	1.25 Gb/s
Link optical power budget	22 dB
Maximum dispersion power penalty	2 dB at 40 km
Transmitter characteristics	
Launch power	– 2.0 to 3.0 dBm
Receiver characteristics	
Receiver sensitivity	– 24 dBm
Maximum receiver power	0 dBm

1000BASE-ZX DDI SFP specifications

The following table describes the 1000BASE-ZX DDI SFP. This SFP operates at 1550 nm and has a reach of up to 70 km. The part number is AA1419052-E6.

⚠ Caution:**Risk of equipment damage**

To prevent damage to the optical receiver, ensure that at least 5 dB of attenuation exists between the transmit and receive ports.

Table 7: 1000BASE-ZX DDI 1550 nm SFP specifications

Parameter	Specification
Maximum electrical power consumption	1.0 W
Connectors	Duplex LC
Cabling	SMF, 9 μm
Data rate	1.0 Gb/s

Parameter	Specification
Line rate (8B/10B code)	1.25 Gb/s
Link optical power budget	24 dB
Maximum dispersion power penalty	2 dB at 70 km
Transmitter characteristics	
Launch power	0 to 5 dBm
Receiver characteristics	
Receiver sensitivity	- 24 dBm
Maximum receiver power	- 0 dBm

1000BASE-BX DDI SFP specifications

The 1000BASE-BX bidirectional SFPs provide gigabit Ethernet connectivity over a single fiber.

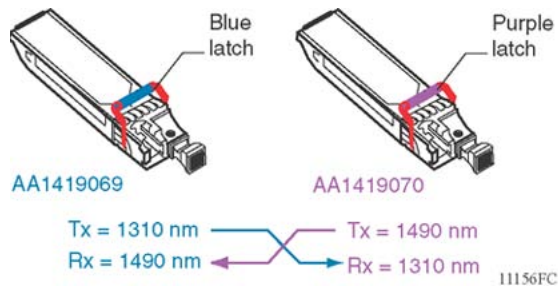

Figure 2: 1000BASE-BX

As shown in the preceding figure, the transmit (Tx) and receive (Rx) paths share the same fiber by using two different wavelengths. One model transmits at 1310 nm and receives at 1490 nm, while the mating model transmits at 1490 nm and receives at 1310 nm. You can only connect a mating pair. The following table provides the part numbers for mating pairs.

Table 8: 1000BASE-BX DDI SFP part numbers

Reach	1310 nm	1490 nm
10 km	AA1419069-E6	AA1419070-E6
40 km	AA1419076-E6	AA1419077-E6

You can use 1000BASE-BX SFPs to double the number of your fiber links. For example, if you install 20 fiber pairs with 20 conventional ports connected, you can use 1000BASE-BX SFPs to expand to 40 ports, using the same fiber.

The long wavelength optical transceivers used in these models provide variable distance ranges using single mode fiber optic cabling.

The following table describes standards, connectors, cabling, and distances for the 1000BASE-BX SFP.

Table 9: IEEE 802.3ah 1000BASE-BX10 SFP specifications

Parameter	Specification
Connectors	Single-fiber LC
Data rate	1.0 Gb/s
Line rate (8B/10B code)	1.25 Gb/s
Distance	Up to 10 or 40 km
Wavelength	1310 nm and 1490 nm
Link optical power budget	11.0 dB
Maximum transmitter and dispersion power penalty	3.3 dB
Transmitter characteristics	
Maximum launch power	– 3.0 dBm
Minimum launch power	– 9.0 dBm
Receiver characteristics	
Maximum receiver sensitivity	– 19.5 dBm
Maximum input power (maximum average receive power)	– 3.0 dBm

1000BASE-EX DDI SFP specifications

The following table describes the 1000BASE-EX DDI SFP. This SFP operates at 1550 nm and has a reach of up to 120 km. The part number of this SFP is AA1419071-E6.

⚠ Caution:**Risk of equipment damage**

To prevent damage to the optical receiver, ensure that at least 14 dB of attenuation exists between the transmit and receive ports.

To attain the BER of 10^{-12} , the minimum attenuation between the transmit and receive ports is 15 dB.

Table 10: 1000BASE-EX DDI SFP specifications

Parameter	Specification
Maximum electrical power consumption	1.2 W
Connectors	Duplex LC
Cabling	SMF, 9 μ m
Data rate	1.0 Gb/s
Line rate (8B/10B code)	1.25 Gb/s

Parameter	Specification
Link optical power budget	30 dB
Maximum dispersion power penalty	2.0 dB at 120 km
Transmitter characteristics	
Launch power	0 to 5.0 dBm
Receiver characteristics	
Receiver sensitivity	– 30 dBm
Maximum receiver power	– 9.0 dBm

1000BASE DDI CWDM 40 km SFP specifications

The 1000BASE SFPs provides CWDM gigabit Ethernet connectivity using single mode fiber. These SFPs support full-duplex operation only.

Important:

For the 40 km CWDM SFPs, a minimum attenuation of 4 dB must be present between the transmitter and receiver. To avoid receiver saturation, you must insert a minimum attenuation of 4 dB when you test the CWDM SFP in loopback mode.

The following table describes specifications for 1000BASE DDI CWDM SFPs numbered AA1419053-E6 to AA1419060-E6.

⚠ Caution:

Risk of equipment damage

To prevent damage to the optical receiver, ensure that at least 4 dB of attenuation exists between the transmit and receive ports.

Table 11: 1000BASE CWDM SFP DDI (40 km) specifications

Parameter	Specifications
Maximum electrical power consumption	1.0 W
Connectors	Duplex LC
Cabling	SMF, 9 μm
Data rate	1.0 Gb/s
Line rate (8B/10B code)	1.25 Gb/s
Link optical power budget	17 dB
Maximum dispersion power penalty	1 dB at 40 km
Transmitter characteristics	
Launch power	– 4.0 to 1.0 dBm

Parameter	Specifications
Receiver characteristics	
Receiver sensitivity	– 21 dBm
Maximum receiver power	– 3.0 dBm

1000BASE DDI CWDM 70 km SFP specifications

The 1000BASE SFPs provides CWDM gigabit Ethernet connectivity using single mode fiber. These SFPs support full-duplex operation only.

Important:

For the 70 km CWDM SFPs, a minimum attenuation of 10 dB must be present between the transmitter and receiver.

The following table describes specifications for CWDM SFPs numbered AA1419061-E6 to AA1419068-E6.

⚠ Caution:

Risk of equipment damage

To prevent damage to the optical receiver, ensure that at least 8 dB of attenuation exists between the transmit and receive ports.

Table 12: 1000BASE-ZX CWDM SFP DDI (70 km) specifications

Parameter	Specifications
Maximum electrical power consumption	1.0 W
Connectors	Duplex LC
Cabling	SMF, 9 μm
Data rate	1.0 Gb/s
Line rate (8B/10B code)	1.25 Gb/s
Link optical power budget	24 dB
Maximum dispersion power penalty	2 dB at 70 km
Transmitter characteristics	
Launch power	0 to 5.0 dBm
Receiver characteristics	
Receiver sensitivity	– 24 dBm
Maximum receiver power	– 3.0 dBm

Chapter 8: SFP+ specifications

This section provides technical specifications for the supported 10 gigabit SFP+ models. Use these specifications to aid in network design.

The specifications in this section are a subset of the IEEE 802.3ae, 802.3aq, and 802.3ak specifications. For more information, see these standards documents. All Avaya SFP+ transceivers meet or exceed these standards.

Important:

Avaya recommends that you only use Avaya-qualified transceivers. If you do choose to use other vendor transceivers, Avaya does not support them.

SFP+ labels

The typical Avaya SFP+ has a label on the top and bottom or side of the transceiver. The following figures show example labels. Avaya does use alternate labels, depending on the size of the device and space available for label information.

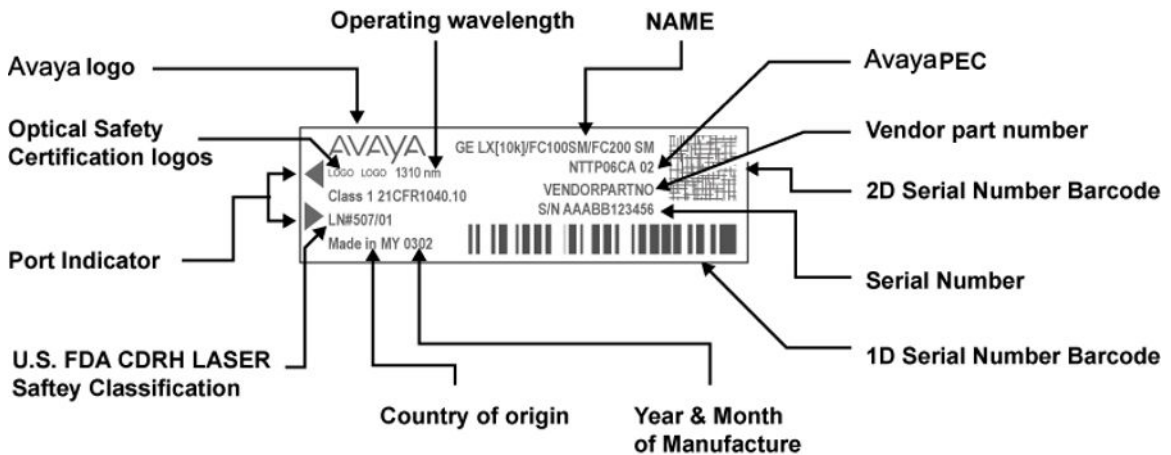

Figure 3: SFP+ top label



Figure 4: SFP+ bottom label

General SFP+ specifications

The following table describes general SFP+ specifications.

Table 13: General SFP+ specifications

Parameter	Specifications
Dimensions (H x W x D)	13.4 x 8.50 x 56.4 millimeters (mm) 0.53 x 0.33 x 2.22 inches (in.) unless otherwise stated
Connectors	LC ultra physical contact (UPC)
Storage temperature	-40 to 85C
Operating temperature	-5 to 85C for RoHS -E6 models

SFP+s

The following sections provide specifications for supported SFP+s:

10GBASE-SR/SW SFP+ specifications

The 10GBASE-SR/SR SFP+ provides 10 GbE service at 850 nm.

The following table lists the specifications for the 10GBASE-SR/SW SFP+. The part number of this SFP+ is AA1403015-E6.

For more information about the 10GBASE-SR/SW SFP+, including test and measurement information, see the IEEE 802.3ae standard.

⚠ Caution:

Risk of equipment damage

To prevent damage to the optical receiver, ensure that at least 1 dB of attenuation exists between the transmit and receive ports.

Table 14: IEEE 802.3ae 10GBASE-SR/SW SFP+ specifications

Parameter	Specifications
Data rate	10.0 Gb/s
Line rate (64B/66B code)	10.3125 gigabits per second (Gb/s) ± 100 parts per million (ppm)

Parameter	Specifications
Mean Time Between Failures (MTBF)	675 000 hours
Center wavelength range	840 to 860 nanometers (nm), nominal 850 nm
Distance	Using 62.5 μ m MMF optic cable: <ul style="list-style-type: none"> • 160 MHz-km fiber: 2 to 26 m • 200 MHz-km fiber: 2 to 33 m Using 50 μ m MMF optic cable: <ul style="list-style-type: none"> • 400 MHz-km fiber: 2 to 66 m • 500 MHz-km fiber: 2 to 82 m • 2000 MHz-km fiber: 2 to 300 m • 4700 MHz-km fiber (OM4): 2 to 400 m
Link optical power budget	7.3 dB
Maximum transmitter and dispersion penalty	3.9 dB at 300 m
Transmitter characteristics	
Root-mean-square spectral width	0.05 to 0.40 nm
Launch power	– 7.3 to – 1.0 decibels referenced to 1 milliwatt (dBm)
Maximum average launch power of OFF transmitter	– 30 dBm
Minimum extinction ratio	3.0 dB
Maximum relative intensity noise ₁₂ OMA	– 128 dB per Hertz (dB/Hz)
Maximum optical return loss tolerance	– 12 dB
Receiver characteristics	
Average receive power for BER 10^{-12}	– 9.9 to – 1.0 dBm
Maximum average receive power for damage	0 dBm
Maximum receiver sensitivity in OMA	– 11.1 dBm
Maximum receiver reflectance	– 12 dB
Stressed receiver sensitivity in OMA	– 7.5 dBm
Receiver electrical 3 dB upper cutoff frequency	12.3 gigaHertz (GHz)

The stressed sensitivity values are for system level BER measurements, which include the effects of clock and data recovery (CDR) circuits. Avaya recommends that you allocate at least

0.4 dB additional margin if you make component level measurements without the effect of CDR circuits.

10GBASE-LRM SFP+ specifications

The 10GBASE-LRM SFP+ provides 10 GbE service at a wavelength of 1310 nm. This SFP+ can attain a reach of up to 220 m on 62.5 μ m multimode fiber. This SFP+ provides built-in electronic dispersion compensation.

The following table lists the transmitter and receiver specifications for the 10GBASE-LRM SFP+. These parameters meet the IEEE 802.3aq-2006 standard. The part number of this SFP+ is AA1403017-E6.

In this table, the OMA, average launch power, and peak power specifications apply at TP2, after accounting for patch cord loss.

Table 15: IEEE 802.3aq 10GBASE-LRM SFP+ specifications

Parameter	Specifications
Data rate	10.0 Gb/s
Line rate (64B/66B code)	10.3125 Gb/s \pm 100 ppm
Center wavelength range	1260 to 1355 nm; 1310 nm nominal
Distance	Up to 220 m, for more information, see Table 16: 10GBASE-LRM channel insertion loss and range on page 59
Link optical power budget	1.7 to 1.9 dB, for more information, see Table 16: 10GBASE-LRM channel insertion loss and range on page 59
Maximum transmitter waveform and dispersion penalty (TWDP)	4.7 dB
Transmitter characteristics	
Average launch power	– 6.5 to 0.5 dBm
Peak launch power	3 dBm
Root-mean-square spectral width	2.4 to 4 nm
Launch power in OMA	– 4.5 to 1.5 dBm
Maximum average launch power of OFF transmitter	– 30 dBm
Minimum extinction ratio	3.5 dB
Maximum relative intensity noise at OMA— RIN_{12OMA}	– 128 dB/Hz
Optical return loss tolerance (minimum)	– 20 dB
Receiver characteristics	

Parameter	Specifications
Maximum receive average power for damage	1.5 dBm
Receiver reflectance (maximum)	- 12 dB

For more information about the conditions used for the stressed receiver tests, and other information, see the IEEE 802.3aq standard.

The following table (from IEEE 802.3aq) describes the maximum channel insertion loss. The channel insertion loss includes both attenuation and connector loss (1.5 dB); therefore the maximum fiber attenuation is 0.2 to 0.4 dB.

Table 16: 10GBASE-LRM channel insertion loss and range

Fiber type (core diameter and OFL bandwidth)	Range	Maximum channel insertion loss
62.5 μ m (FDDI grade) <ul style="list-style-type: none"> • 160 MHz-km at 850 nm • 500 MHz-km at 1300 nm 	Up to 220 m	1.9 dB
62.5 μ m (ISO/IEC OM1) <ul style="list-style-type: none"> • 200 MHz-km at 850 nm • 500 MHz-km at 1300 nm 	Up to 220 m	1.9 dB
50 μ m (ISO/IEC OM2) <ul style="list-style-type: none"> • 500 MHz-km at 850 nm • 500 MHz-km at 1300 nm 	Up to 220 m	1.9 dB
50 μ m <ul style="list-style-type: none"> • 400 MHz-km at 850 nm • 400 MHz-km at 1300 nm 	Up to 100 m	1.7 dB
50 μ m (ISO/IEC OM3) <ul style="list-style-type: none"> • 1500 MHz-km at 850 nm (includes laser launch bandwidth) • 500 MHz-km at 1300 nm (includes laser launch bandwidth) 	Up to 220 m	1.9 dB

In the table, FDDI denotes Fiber Distributed Data Interface, ISO denotes International Standards Organization, IEC denotes International Electrotechnical Commission, and OFL denotes Over Filled Launch.

The following table uses the 802.3aq standard and specifies the measurement conditions for each fiber type.

Table 17: Launch conditions for each fiber type

Parameter	Minimum encircled flux	Notes
Optical launch for OM1 and FDDI-grade fiber	<ul style="list-style-type: none"> • 30% within 5 μm radius • 81% within 11 μm radius 	Uses 62.5 μm mode conditioning patch cord
Optical launch for OM2 and 50 μm 400/400 fiber	<ul style="list-style-type: none"> • 30% within 5 μm radius • 81% within 11 μm radius 	Uses 50 μm mode conditioning patch cord
Optical launch for OM3 and 50 μm fiber	<ul style="list-style-type: none"> • 30% within 5 μm radius • 81% within 11 μm radius 	—

10GBASE-LR/LW SFP+ specifications

The 10GBASE-LR/LW SFP+ provides 10 GbE or OC-192 service at a nominal wavelength of 1310 nm. This SFP+ can attain link lengths of up to 10 km.

The following table lists the transmitter and receiver specifications for the 10GBASE-LR/LW SFP+. The part number of this SFP+ is AA1403011-E6.

For more information about the 10GBASE-LR/LW SFP+, including test and measurement information, see the IEEE 802.3ae standard.

Table 18: IEEE 802.3ae 10GBASE-LR/LW SFP+ specifications

Parameter	Specifications
Center wavelength range	1260 to 1355 nm; 1310 nm nominal
Distance	Up to 10 km
Link optical power budget	9.4 dB
Maximum transmitter and dispersion penalty	3.2 dB at 10 km
Transmitter characteristics	
Line rate (nominal)	10GBASE-LR 10.3125 Gb/s \pm 100 ppm (10 GbE)
Average launch power	– 8.2 to 0.5 dBm
Minimum side mode suppression ratio	30 dB
Minimum launch power in OMA minus transmission and dispersion penalty (TDP)	– 6.2 dBm
Minimum optical modulation amplitude	– 5.2 dBm
Maximum average launch power of OFF transmitter ^c	– 30 dBm
Minimum extinction ratio	3.5 dB
RIN ₁₂ OMA (maximum)	– 128 dB/Hz

Parameter	Specifications
Maximum optical return loss tolerance	-- 12 dB
Maximum transmitter reflectance	- 12 dB
Receiver characteristics	
Line rate (nominal)	10GBASE-LR 10.3125 Gb/s ± 100 ppm (10 GbE)
Average receive power for BER 10 ⁻¹²	- 14.4 dBm to 0.5 dBm
Maximum average receive power for damage	1.5 dBm
Maximum receiver sensitivity in OMA	- 12.6 dBm
Maximum receiver reflectance	- 12 dB
Stressed receiver sensitivity in OMA	- 10.3 dBm
Receiver electrical 3 dB upper cutoff frequency	12.3 GHz

Examples of an OFF transmitter are as follows: no power supplied to the PDM, laser shutdown for safety conditions, activation of a PMD_global_transmit_disable or other optional transmitter shut down condition

10GBASE-ER/EW SFP+ specifications

The following table lists the transmitter and receiver specifications for the 10GBASE-ER/EW SFP+. The reach for this SFP+ is up to 40 km at a wavelength of 1550 nm. The part number of this SFP+ is AA1403013-E6.

For more information about the 10GBASE-ER/EW SFP+, including test and measurement information and more specifications, see the IEEE 802.3ae standard.

Table 19: IEEE 802.3ae 10GBASE-ER/EW SFP+ specifications

Parameter	Specifications
Line rate (nominal)	10GBASE-ER 10.3125 Gb/s ±100 ppm (10 GbE)
Center wavelength range	1530 to 1565 nm; nominal 1550 nm
Distance	Up to 40 km
Link optical power budget	15 dB
Transmitter and dispersion power penalty	3.0 dB at 40 km
Transmitter characteristics	
Launch power	-- 4.7 to 4.0 dBm
Minimum side mode suppression ratio	30 dB

Parameter	Specifications
Minimum launch power in OMA minus transmission and dispersion penalty (TDP)	- 2.1 dBm
Minimum optical modulation amplitude	- 1.7 dBm
Maximum average launch power of OFF transmitter	-- 30 dBm
Minimum extinction ratio	3.0 dB
Maximum RIN_{12OMA}	- 128 dB/Hz
Maximum optical return loss tolerance	- 21 dB
Receiver characteristics	
Average receive power for BER 10^{-12}	- 15.8 dBm to - 1.0 dBm
Maximum receive power for damage	4.0 dBm
Maximum receiver sensitivity in OMA	- 14.1 dBm
Maximum receiver reflectance	- 26 dB
Stressed receiver sensitivity in OMA	- 11.3 dBm
Receive electrical 3 dB upper cutoff frequency (maximum)	12.3 GHz

Examples of an OFF transmitter are as follows: no power supplied to the PDM, laser shutdown for safety conditions, activation of a `PMD_global_transmit_disable` or other optional transmitter shut down conditions.

10GBASE-CX1 specifications

The 10GBASE-CX1 is a 4-pair twinaxial copper cable that directly plugs into the SFP+ socket and connects two 10 Gb ports. The reach for this cable is up to 10 m with a bit error rate (BER) better than 10^{-12} . The signaling speed for each lane is 3.125 Gb/s \pm 100 ppm. The 10GBASE-CX1 is a lower cost alternative to the optical SFP+ devices.

10GBASE-CX1 can also be referred to as SFP+ Direct Attach Cable, 10GSFP+Cu, or 10GBASE-CR. The following table identifies the part numbers for specific cable lengths.

Table 20: 10GBASE-CX1 cables

Cable length	Part number
3 meter	AA1403019-E6
5 meter	AA1403020-E6
10 meter	AA1403018-E6