



ExtremeAnalytics PV-A-305 Installation Guide

05/2021
9037064-00
Subject to Change Without Notice

Copyright © 2021 Extreme Networks, Inc. All Rights Reserved.

Legal Notices

Extreme Networks, Inc., on behalf of or through its wholly-owned subsidiary, Enterasys Networks, Inc., reserves the right to make changes in specifications and other information contained in this document and its website without prior notice. The reader should in all cases consult representatives of Extreme Networks to determine whether any such changes have been made.

The hardware, firmware, software or any specifications described or referred to in this document are subject to change without notice.

Trademarks

Extreme Networks and the Extreme Networks logo are trademarks or registered trademarks of Extreme Networks, Inc. in the United States and/or other countries.

All other names (including any product names) mentioned in this document are the property of their respective owners and may be trademarks or registered trademarks of their respective companies/owners.

For additional information on Extreme Networks trademarks, please see: www.extremenetworks.com/company/legal/trademarks/

Contact

If you require assistance, contact Extreme Networks using one of the following methods.

- [Global Technical Assistance Center \(GTAC\) for Immediate Support](#)
 - **Phone:** 1-800-998-2408 (toll-free in U.S. and Canada) or 1-603-952-5000. For the Extreme Networks support phone number in your country, visit: www.extremenetworks.com/support/contact
 - **Email:** support@extremenetworks.com. To expedite your message, enter the product name or model number in the subject line.

- [GTAC Knowledge](#) — Get on-demand and tested resolutions from the GTAC Knowledgebase, or create a help case if you need more guidance.
- [The Hub](#) — A forum for Extreme customers to connect with one another, get questions answered, share ideas and feedback, and get problems solved. This community is monitored by Extreme Networks employees, but is not intended to replace specific guidance from GTAC.
- [Support Portal](#) — Manage cases, downloads, service contracts, product licensing, and training and certifications.

Table of Contents

ExtremeAnalytics PV-A-305 Installation Guide	1
Table of Contents	4
About This Guide	6
Engine Overview and Setup	7
Kit Contents	7
Specifications	7
Front Panel Features	9
Hard Drive LED Indicator Patterns	10
Back Panel Features	11
Power Supply Status Indicator Patterns	11
Removing and Installing the Front Bezel	12
Removing the Front Bezel	12
Installing the Front Bezel	13
Installing the Engine into a Rack	13
Torque Values	14
Configuration	15
Pre-Configuration Tasks	15
Configuring the ExtremeAnalytics Engine	15
Launching the ExtremeAnalytics Application	26
Adding the ExtremeAnalytics Engine	27
Changing ExtremeAnalytics Engine Settings	29
Changing Basic Network Configuration	29
Changing SNMP Configuration	30

Changing Date and Time Settings30

Changing the ExtremeCloud IQ - Site Engine Server IP Address 30

Changing the Web Service Credentials 30

Upgrading ExtremeAnalytics Engine Software 31

Reinstalling Engine Software 33

Product Regulatory and Compliance Information 35

Federal Communications Commission (FCC) Notice35

Industry Canada, Class A 36

CE Notice36

VCCI Notice 36

BSMI EMC Statement – Taiwan36

Hazardous Substances37

European Waste Electrical and Electronic Equipment (WEEE) Notice 37

Declaration of Conformity39

About This Guide

This document describes the installation and initial configuration of the ExtremeAnalytics PV-A-305 hardware engine.

This document is intended for experienced network administrators who are responsible for implementing and maintaining communications networks.

Engine Overview and Setup

This chapter lists the components shipped with the PV-A-305 engine, describes the front and back panels, and provides information on engine specifications.

For complete regulatory compliance and safety information, refer to the document Intel® Server Products Product Safety and Regulatory Compliance, available at the following links:

https://www.intel.com/content/dam/support/us/en/documents/motherboards/server/sb/g23122003_safetyregulatory.pdf

<http://www.extremenetworks.com/support/documentation/>

Kit Contents

The PV-A-305 engine ships with the following components:

- Extreme Networks URL card
- Front bezel label
- A rack mounting kit
- Two rack handles and appropriate screws
- Two AC power cables
- AC power cord bracket and cable clamp kit
- One USB flash drive

Specifications

The following tables list the physical and environmental specifications for the engine.

PV-A-305 Physical Specifications

Processor	
Processor type	PV-A-305 - Intel® Xeon® E5-2620 v4 processor
Processor speed	2.1 GHz
CPU Cores	8
Memory	

Architecture	2400 MHz Dual Ranked Registered (RDIMM) ECC DDR4
Memory module capacities	4 GB DIMMs
Minimum RAM (included)	64 GB (sixteen 4 GB DIMMs)
Maximum RAM	128 GB (thirty-two 4 GB RDIMMs)
RAID Configuration	RAID 1 with BBU
Drives	
Hard drives	One 960 GB SSD hard drive
Connectors	
Back	
NIC	Four RJ-45
Serial	9-pin, DTE, 16550-compatible
USB	Three 4-pin, USB 2.0-compliant
Video	15-pin VGA
Networking	Two 1 GB Ethernet
Front	
USB	Two 4-pin, USB 2.0-compliant
Video	15-pin VGA
Power	
AC power supply (per power supply)	Redundant power supply
Wattage	750 watts
Input voltage	<ul style="list-style-type: none"> • 90 - 132 V at 47/63 Hz 8.2 A • 180 - 264 V at 47/63 Hz 4.4 A
Output voltage	<ul style="list-style-type: none"> • 62.0A at 12 V • 2.1A at 12 VSB
Physical	
Height	4.45 cm (1.72 in.)
Width	43.0 cm (16.93 in.)
Depth	70.99 cm (27.95 in.)
Weight (maximum configuration)	13.15 kg (29 lb.)

PV-A-305 Environmental Specifications

Parameter	Limits
Operating temperature	+10°C (+50°F) to +35°C (+95°F) with the maximum rate of change not to exceed 10°C (+50°F) per hour
Storage temperature	-40°C (-40°F) to +70°C (+158°F)
Storage humidity	50% to 90%, non-condensing at 28°C (82°F)
Vibration, unpackaged	5 Hz to 500 Hz, 2.20 g RMS random
Shock, operating	Half sine, 2 g-force peak, 11 milliseconds
Shock, unpackaged	Trapezoidal, 25 g, velocity change 136 inches/second (40 lb to < 80 lb)
Shock, packaged	Non-palletized free fall in height 24 inches (40 lb to < 80 lb)
ESD	±12 KV except I/O port ±8 KV per Intel® Environmental test specification
Estimated thermal dissipation	1550 BTU/Hr

Front Panel Features

This section shows the front panel and describes the major features.

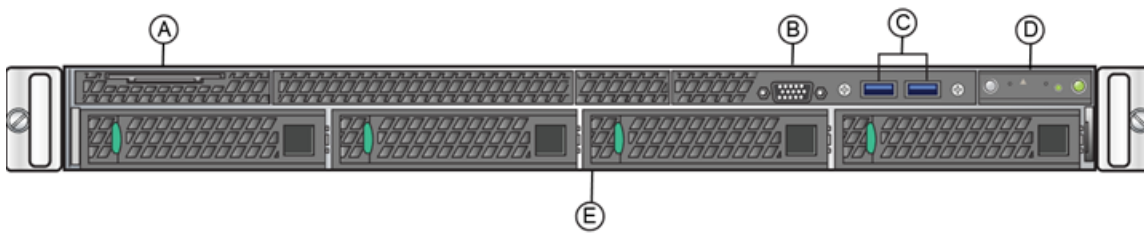

PV-A-305 Front Panel Features

A	System label pull-out	D	Front control panel (see figure below)
B	Video Connector	E	Hard disk drive bays
C	USB 3.0 Ports		

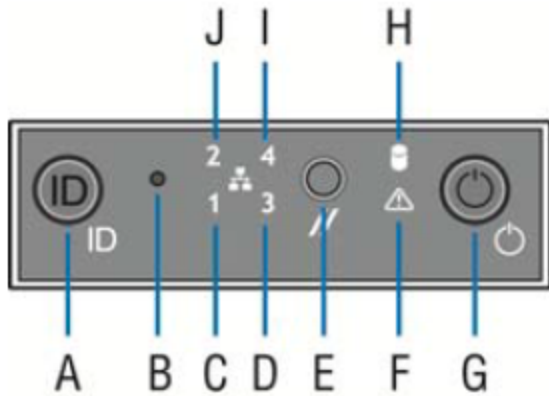

Front Control Panel

A	System ID button w/integrated LED	F	System status LED
B	NMI button (recessed, tool required for use)	G	Power button w/integrated LED
C	Mgmt port activity LED	H	Hard drive activity LED
D	Not used	I	Not used
E	System cold reset button	J	Not used

Hard Drive LED Indicator Patterns

The hard drive has two LED indicators visible from the front of the system: one is a green LED for disk activity, and the other is amber and indicates hard drive status. The following tables describe the LED states.

Hard Drive Activity LED Indicator Patterns

Hard Drive Condition	Activity LED Patterns
Power on and drive spinning up or spinning down	Off
Power on with drive activity	Blinking green

Hard Drive Status LED Indicator Patterns

Hard Drive Condition	Status LED Patterns
No access or no fault	Off
Hard drive fault has occurred	Solid amber

Back Panel Features

This section shows the back panel and describes the major features.

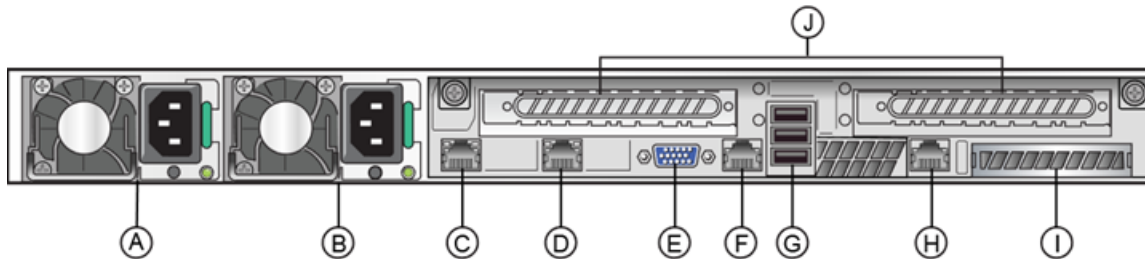

PV-A-305 Back Panel

A	Power supply module #1	F	Serial port
B	Power supply module #2	G	USB 2.0 ports
C	eth0	H	Mgmt port, out of band
D	eth1	I	I/O Module Bay
E	Video connector	J	Riser cards

The following table describes the LEDs for the RJ45 management port.

RJ45 Port LEDs (Management Port)

LED Type	LED Pattern	Status Indication
Network speed (right)	Off	10 Mbps
	Amber	100 Mbps
	Green	1000 Mbps
Link activity (left)	Off	No link
	Solid Green	Active link
	Blinking Green	Data traffic activity

Power Supply Status Indicator Patterns

The engine has two power supplies, supplying hot-pluggable power redundancy. The system distributes the power load across both power supplies

to maximize efficiency.

Each power supply has a single bi-color LED to indicate power supply status, as described in the following table.

Power Supply Status LED Indicator Patterns

LED Pattern	Power Supply Condition
Green	Output on and OK
Off	No AC power to all power supplies
1Hz blinking green	AC present / Only 12VSB on (PS off) or PS in cold redundant state
Amber	AC power cord unplugged or AC power lost. With a 2nd PS in parallel still with AC input power
1Hz blinking amber	Power supply warning events where PS continues to operate – high temp, high power, high current, slow fan
Amber	Power supply critical event causing a shutdown, failure, OCP, OVP, fan fail
2Hz blinking green	Power supply firmware updating

Removing and Installing the Front Bezel

The PV-A-305 engine comes with an optional front panel bezel that can be attached to the front of the chassis by snapping the bezel onto the chassis handles. A key lock allows you to lock the bezel in place so that front panel controls cannot be used. You can still monitor system status indicators with the bezel in place.

Removing the Front Bezel

To remove the front bezel:

1. Unlock the bezel if it is locked.
2. Remove the left end of the front bezel from rack handle.
3. Rotate the front bezel counterclockwise to release the latches on the right end from the rack handle.

Installing the Front Bezel

Note: Before installing the bezel, you must install the rack handles. See [Installing the Engine into a Rack](#).

To install the front bezel:

1. Lock the right end of the front bezel to the rack handle.
2. Rotate the front bezel clockwise till the left end clicks into place.
3. Lock the bezel, if needed.

Installing the Engine into a Rack

A rack mounting kit and installation guide are included with the PV-A-305 engine. The rack mounting kit allows you to install the engine into a four-post rack cabinet. Refer to the installation guide for complete installation instructions.

If you are table mounting the engine, ensure at least 6 cm of clearance on all sides of the engine for proper ventilation.

If you are installing the engine in a rack:

1. Install the rack handles by aligning a rack handle with the two holes on each side of the engine and attaching each handle to the engine with two screws as shown below.

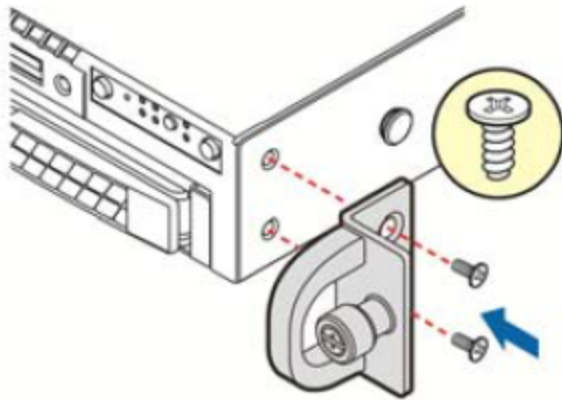

Installing the Rack Handles

2. Read the installation guide included with the rack mounting kit.
3. Install the rails and mount the controller in the rack as instructed.

Torque Values

The following table describes the recommended torque values to use when installing the engine using standard threaded fastener machine screws and bolts.

Recommended Torque Values by Screw Size

Screw Size		Torque in Pounds			Bit Size
English	Metric	-%5	Nominal	+%5	
N/A	N/A	1.42	1.5	1.57	0
2 - 56	1.5	2.85	3.0	3.15	0
4 - 40	2.5	4.75	5.0	5.25	0/1
6 - 32	3.5	8.55	9.0	9.45	1
8 - 32	4.5	17.10	18.0	18.90	2
10 - 32	5	30.40	32.0	33.60	2
1/4 - 20	6.5	63.65	67.0	70.35	3

Configuration

Once you have installed the engine into a rack, you need to connect a monitor and a USB keyboard, connect the power cord and network cable, and power the engine on.

After the engine boots and the engine installation is complete, you must go through the initial configuration process described in this chapter.

This chapter also includes information on how to change your engine settings following your initial configuration and how to upgrade the ExtremeCloud™ IQ - Site Engine application software. For information on reinstalling the ExtremeCloud IQ - Site Engine engine software, see [Reinstalling Engine Software](#).

Pre-Configuration Tasks

Ensure that you have the following information prior to executing the configuration steps in the next section:

- Engine hostname, IP address, and netmask
- Default gateway IP address
- Name server IP address and domain name
- NIS (Network Information Services) server IP address
- Network Time Protocol (NTP) server IP address

In addition, you need to obtain the appropriate ExtremeCloud IQ - Site Engine software license prior to launching the ExtremeCloud IQ - Site Engine applications. You will be prompted to enter a license when you launch the application. (When you purchased ExtremeCloud IQ - Site Engine, you received a Licensed Product Entitlement ID. This Entitlement ID allows you to generate a product license. Refer to the instructions included with the Entitlement ID that was sent to you.)

Configuring the ExtremeAnalytics Engine

After the initial engine installation is complete, use the following steps to

configure the virtual engine to run the ExtremeAnalytics application:

1. Login as root with no password, and press [Enter].

The following screen appears:

```
=====
=====
Extreme Networks - ExtremeAnalytics Engine -

Welcome to the ExtremeAnalytics Engine Setup
=====
=====
Please enter the information as it is requested to continue with the
configuration. Typically a default value is displayed in brackets.
Pressing the [enter] key without entering a new value will use the
bracketed value and proceed to the next item. If a default value
cannot be provided, the prompt will indicate that the item is either
(Required) or (Optional). The [enter] key may be pressed without
entering data for (Optional) items. A value must be entered for
(Required) items. At the end of the setup process, the existing
settings will be displayed and opportunity will be provided to correct
any errors.

=====
=====

Press [enter] to begin setup or CTRL-C to exit:
```

2. Press [Enter] to begin the setup. The Root Password Configuration screen appears:

```
=====
=====
Root Password Configuration
=====
=====
There is currently no password set in the system administrator
account (root). It is recommended that you set one that is active the
first time the machine is rebooted.
```



```

=====
=====  

Would you like to set a root password (y/n) [y]?
    
```

Note: You must set a new root password. This new root password will be used by the initial user when logging in to the ExtremeAnalytics application.

3. Enter y to set the new root password.
4. Press [Enter] and enter the new password as prompted.

```

Enter new UNIX password:
Retype new UNIX password:
Password updated successfully.
    
```

The ExtremeAnalytics Engine Deployment screen appears.

5. Select the deployment mode that matches your network environment.
The default deployment mode is 3.

```

=====
=====  

ExtremeAnalytics Engine Deployment Modes
=====
=====  

This engine supports multiple deployment modes to suit different network environments and connectivity characteristics. Please select a deployment mode below that best fits your requirements.

0. Single Interface - A single interface is used for both management and monitoring traffic. Suitable for feeds from XOS/VOSS/SLX switches.

1. Single Interface With Tunnel - A single interface is used for both management and monitoring traffic. A GRE Tunnel will be configured for traffic monitoring. Suitable for feeds from Coreflow switches.

2. Interface Mirrored - Separate interfaces are configured for management and monitoring traffic. The monitoring interface will put into tap mode for traffic monitoring. Suitable for feeds from XOS/VOSS/SLX switches.
    
```

3. Interface Tunnel Mirrored - Separate interfaces are configured for management and monitoring traffic. The monitoring interface will get its own IP Address and GRE Tunnels will be configured for traffic monitoring. Suitable for feeds from Coreflow switches.

4. Manual Mode - The interface and tunneling configurations will not be modified by this script, leaving them to be manually edited by the user instead.

Please select a deployment mode [2]:

Note: If you select deployment mode 4, refer to the Extreme ExtremeAnalytics Deployment Guide for information on how to configure your deployment manually.

6. If you selected deployment mode 0, 1, 2, or 3 the ExtremeAnalytics Engine Network Configuration for eth0 screen appears. For each line, type the requested configuration information and press [Enter].

If you will be using DNS, provide the IP address of the name server. If you are using a name server enter a domain name for the engine. The NIS server is used to authenticate users logging into the engine. If you are using an NIS server, make sure the NIS domain name is valid or users may not be able to log in to the ExtremeCloud IQ - Site Engine applications.

```

=====
===== ExtremeAnalytics Engine Network Configuration for eth0
=====
=====
Enter information below to configure eth0
Enter the hostname for the engine (Required):
Enter the IP address for eth0 on 10.54.56.141 [10.54.56.141]:
Enter the IP netmask [255.255.255.0]:
Enter the gateway address [10.54.56.2]:
Enter the IP address of the name server (Optional):
Enter the domain name for 10.54.56.141 (Optional):
Enable NIS (y/n) [n]?
    
```

7. Continue to the appropriate section:
 - For deployment mode 0, proceed to step [9](#).

- For deployment mode 1, proceed to step [7](#).
 - For deployment mode 2, proceed to step [8](#).
8. Specify one or more tap ports. If you have an installed optional PV-A-300-10G-UG I/O module, the ports are eth4 and eth5. For each line, type the requested configuration information and press **[Enter]**.

```

=====
===== ExtremeAnalytics Engine Network Configuration for Tap Mode
=====
=====  

Enter the interface name for Tap Mode [eth1]: eth4
Would you like to add another interface for Tap Mode (y/n) [n]? y
Enter the interface name for Tap Mode [eth2]: eth5
Would you like to add another interface for Tap Mode (y/n) [n]? n

```

Proceed to step [10](#).

9. Specify one or more GRE tunnel interfaces. If you have an installed optional PV-A-300-10G-UG I/O module, the ports are eth4 and eth5. For each line, type the requested configuration information and press **[Enter]**.

```

=====
===== ExtremeAnalytics Engine Network Configuration for Tunnel
Interfaces
=====
=====  

Enter the interface name for Tunnel Configuration [eth1]: eth4
Enter information below to configure eth4
Enter the IP address for eth4 on pv88 [10.54.211.116]:
Enter the IP netmask [255.255.255.0]:
Enter the gateway address [10.54.211.1]:
Would you like to add another interface for Tunnel Configuration
(y/n) [n]? y
Enter the interface name for Tunnel Configuration [eth1]: eth5
Enter information below to configure eth5
Enter the IP address for eth5 on pv88 [10.54.222.117]:
Enter the IP netmask [255.255.255.0]:
Enter the gateway address [10.54.222.1]:

```

Would you like to add another interface for Tunnel Configuration (y/n) [n]? n

10. Enter the IP addresses for one or more GRE tunnels. For each line, type the requested configuration information and press [Enter].

```

=====
===== ExtremeAnalytics Engine GRE Configuration=====
=====
=====  

Remote mirroring can be configured in Coreflow Switches using GRE tunnels. This requires a specific mirroring configuration enabled on the switches.  
  

Enter the SRC IP address for the GRE Tunnel [10.54.211.116]:  

Enter the DST IP address for the GRE Tunnel [192.168.1.1]: 10.54.1.116  

Add another GRE Tunnel (y/n) [n]? y  

Enter the SRC IP address for the GRE Tunnel [10.54.222.117]:  

Enter the DST IP address for the GRE Tunnel [192.168.1.1]: 10.54.2.117  

Add another GRE Tunnel (y/n) [n]? n
    
```

11. A screen appears asking you to confirm your network setting. Enter 0 to accept the settings.
The following example shows the Confirm Network Settings screen for deployment mode 1.

```

=====
=====  

Confirm Network Settings  

=====
=====  

These are the settings you have entered. Enter 0 or any key other than a valid selection to continue. If you need to make a change, enter the appropriate number now or run the /usr/postinstall/dnetconfig script at a later time.  

=====
=====  

0. Accept settings and continue  

1. Hostname: pv88
    
```

- 2. Deployment Mode: Dual Interface Mirrored**
- 3. Management Interface Configuration (eth0):**
 - Address: 10.54.184.88
 - Netmask: 255.255.255.0
 - Gateway: 10.54.184.1
 - Nameserver: 10.54.188.120
 - Domain name: nac2003.com
- 4. NIS Server/Domain: Not Configured
- 5. Monitor Interface Configuration: Tap Mode Interfaces: eth4, eth5

The following example shows the **Confirm Network Settings** screen for deployment mode 2.

```

=====
=====
Confirm Network Settings
=====
=====
These are the settings you have entered. Enter 0 or any key other
than a valid selection to continue. If you need to make a change, enter
the appropriate number now or run the
/usr/postinstall/dnetconfig script at a later time.
=====
=====
0. Accept settings and continue
1. Hostname: pv88
2. Deployment Mode: Dual Interface Tunnel Mirrored
3. Management Interface Configuration (eth0):

- Address: 10.54.184.88
- Netmask: 255.255.255.0
- Gateway: 10.54.184.1
- Nameserver: 10.54.188.120
- Domain name: nac2003.com

```

4. NIS Server/Domain: Not Configured

5. Mirror Interface Configuration:

- Name: eth4
- Address: 10.54.211.116
- Netmask: 255.255.255.0
- Gateway: 10.54.211.1
- Name: eth5
- Address: 10.54.222.117
- Netmask: 255.255.255.0
- Gateway: 10.54.222.1

6. GRE tunnels:

- 10.54.211.116/10.54.1.116
- 10.54.222.117/10.54.2.117

12. In the **SNMP Configuration** screen, type the requested information for each line and press [Enter].

```

=====
=====
SNMP Configuration
=====
===== The following information will be used to configure SNMP
management of this device. The SNMP information entered here must
be used to contact this device with remote management applications
such as ExtremeCloud IQ - Site Engine Console.
=====
=====
Please enter the SNMP user name [snmpuser]:
Please enter the SNMP authentication credential [snmpauthcred]:
Please enter the SNMP privacy credential [snmpprivcred]:
    
```

13. A summary screen appears asking you to accept your SNMP Configuration settings. Enter 0 to accept the settings.

```

=====
=====
    
```

```

SNMP Configuration
=====
=====
These are the current SNMP V3 settings. To accept them and complete
SNMP configuration, enter 0 or any key other than the selection
choices. If you need to make a change, enter the appropriate number
now or run the /usr/postinstall/snmpconfig script at a later time.
0. Accept the current settings
1. SNMP User: snmpuser
2. SNMP Authentication: snmpauthcred
3. SNMP Privacy: snmpprivcred
4. Modify all settings
=====
=====
Enter selection [0]: 0

```

14. In the **Configure Date and Time Settings** screen, select whether you want to use an external Network Time Protocol (NTP) server. Enter **y** to use NTP, and enter your NTP server IP address(es). Enter **n** to configure the date and time manually and proceed to step [15](#).

```

=====
=====
Configure Date And Time Settings
=====
=====
The engine date and time can be set manually or using an external
Network Time Protocol (NTP) server. It is strongly recommended that
  NTP is used to configure the date and time to ensure accuracy of
time  values for SNMP communications and logged events. Up to 5
server IP addresses may be entered if NTP is used.
=====
=====
Do you want to use NTP (y/n) [y]? y
Please enter a NTP Server IP Address (Required): 144.131.10.120
Would you like to add another server (y/n) [n]? y
Please enter a NTP Server IP Address (Required): 144.131.10.121
Would you like to add another server (y/n) [n]? n

```

15. In the **NTP Servers validate selection** screen, enter **0** to accept the current settings and proceed to the **Set Time Zone** screen at step [17](#).

```

=====
=====
NTP Servers
=====
=====
These are the currently specified NTP servers. Enter 0 or any key
other than a valid selection to complete NTP configuration and
continue. If you need to make a change, enter the appropriate
number from the choices listed below.
144.131.10.120
144.131.10.121
0. Accept the current settings
1. Restart NTP server selection
2. Set date and time manually
=====
=====
Enter selection [0]: 0
    
```

16. If you answered "no" to using an NTP server to set date and time, set the date and time in the **Set Date and Time** screen.

```

=====
=====
Set Date And Time
=====
=====
The current system date and time is: Thu Oct 28 09:34:08 2013 Please
enter the values for date and time as directed where input is expected
in the following format:
MM - 2 digit month of year
DD - 2 digit day of month
YYYY - 4 digit year
hh - 2 digit hour of day using a 24 hour clock
mm - 2 digit minute of hour
ss - 2 digit seconds
=====
=====
Please enter the month [08]:
    
```



```

Please enter the day of the month [02]:
Please enter the year [2016]:
Please enter the hour of day [09]:
Please enter the minutes [34]:
Please enter the seconds [08]:
    
```

17. In the **Use UTC** screen, select whether you want the system clock to be set to use UTC.

```

=====
=====
Use UTC
=====
=====
The system clock can be set to use UTC. Specifying no for using UTC,
sets the hardware clock using localtime.
=====
=====
Do you want to use UTC (y/n) [n]?
    
```

18. In the **Set Time Zone** screen, select the appropriate time zone and press **[Enter]**.

```

=====
=====
Set Time Zone
=====
=====
You will now be asked to enter the time zone information for this
system. Available time zones are stored in files in the
/usr/share/zoneinfo directory. Please select from one of the following
example time zones:
1. US Eastern
2. US Central
3. US Mountain
4. US Pacific
5. Other - Shows a graphical list
=====
=====
Enter selection [1]:
    
```

19. The **Modify Settings** screen summarizes the settings you have entered and provides an opportunity to modify the settings, if desired. Enter **0** to accept the settings.

```

=====
=====  

Modify Settings  

=====
=====  

All of the information needed to complete the installation of the  

ExtremeAnalytics Engine has been entered. Enter 0 or any key other  

than a valid selection to continue. If you need to make a change, enter  

the appropriate number from the choices listed below.  

=====
=====  

0. Accept settings and continue  

1. Set the root user password  

2. Set user to run server as  

3. Set hostname and network settings  

4. Set SNMP settings  

5. Set the system time  

6. Modify all settings  

Enter selection [0]:

```

The ExtremeAnalytics application software is automatically installed. This may take a few minutes. When the installation is complete, you see the following screen.

```

=====
=====  

Extreme Networks - ExtremeAnalytics Engine - Setup Complete  

=====
=====  

Setup of the ExtremeAnalytics Engine is now complete. The engine is now  

operational and ready to accept remote connections. Details of the  

installation are located in the /var/log/install directory.  

=====
=====  

```

Launching the ExtremeAnalytics Application

Now that you have configured the ExtremeAnalytics engine, you are ready to

access the ExtremeCloud IQ - Site Engine Launch Page and run the applications from a remote client machine.

1. Open a browser window on the remote client machine and enter the ExtremeCloud IQ - Site Engine Launch page URL in the following format:

`http://<servername>:8080/`

where `<servername>` is the ExtremeCloud IQ - Site Engine engine IP address or hostname, and 8080 is the required port number. For example, `http://10.20.30.40:8080/`

The ExtremeCloud IQ - Site Engine Launch Page opens.

2. Enter your ExtremeCloud IQ - Site Engine username and password and click **Login**.
3. Click the **Analytics** tab at the top of the window.

The **Analytics** tab displays.

For more information on the ExtremeCloud IQ - Site Engine Launch page, access the Online Help by clicking on ? in top-right corner. In the Online Help Table of Contents, select *Installation Guide* and then read the section titled "Remote Client Launch."

Adding the ExtremeAnalytics Engine

Use the following procedure to add the ExtremeAnalytics engine to the **Analytics** tab in ExtremeCloud IQ - Site Engine:

1. Select the **Configuration** tab in the **Analytics** tab.

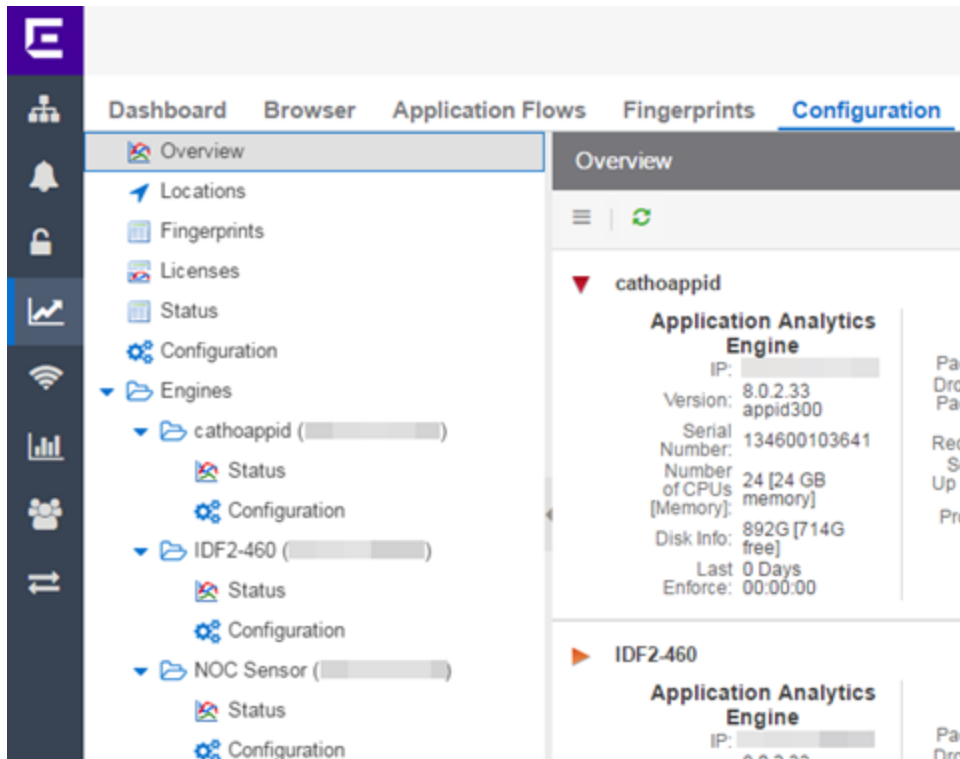

2. Click the **Menu** icon and select **Add Engine**.

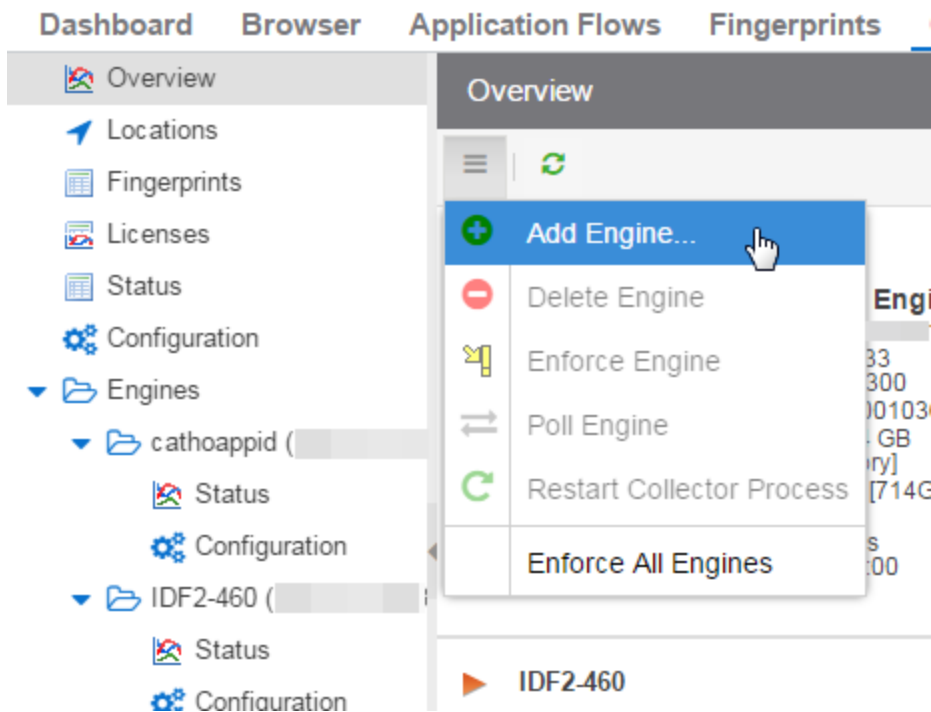

The **Add ExtremeAnalytics Engine** window displays.

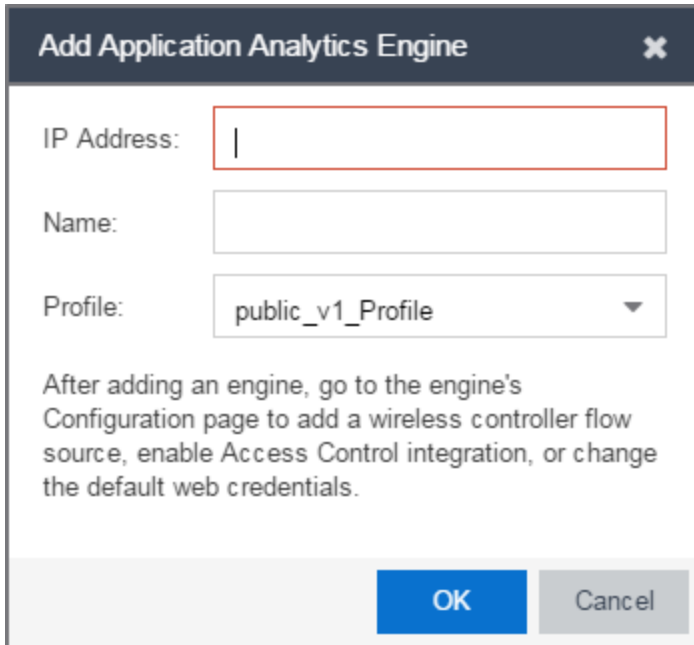

Add Application Analytics Engine ✕

IP Address:

Name:

Profile:

After adding an engine, go to the engine's Configuration page to add a wireless controller flow source, enable Access Control integration, or change the default web credentials.

OK Cancel

3. Enter the **IP Address** of the eth0 interface and the **Name** of the ExtremeAnalytics engine.
4. Select the appropriate SNMP Profile from the **Profile** drop-down list.
5. Click **OK**.
6. Select **Enforce Engine** from the drop-down list.

The ExtremeAnalytics engine is added to Management Center.

Changing ExtremeAnalytics Engine Settings

Use these steps if you need to change your ExtremeAnalytics engine settings following your initial engine configuration.

Changing Basic Network Configuration

To change basic network configuration settings such as hostname and engine IP address, enter the following command at the engine CLI:

```
/usr/postinstall/dnetconfig
```

This starts the network configuration script and allows you to make the required changes. You must reboot the engine for the new settings to take effect.

Changing SNMP Configuration

To change SNMP configuration settings such as SNMP Trap Community String, SNMP User, SNMP Authentication, and SNMP Privacy credentials, enter the following command at the engine CLI:

```
/usr/postinstall/snmpconfig
```

This starts the SNMP configuration script and allows you to make the required changes.

Changing Date and Time Settings

To enable or disable using NTP to configure the engine date and time, or to manually set the date and time on the engine, enter the following command at the engine CLI:

```
/usr/postinstall/dateconfig
```

This starts the date and time configuration script and allows you to change the settings.

Changing the ExtremeCloud IQ - Site Engine Server IP Address

To change the IP address of the ExtremeCloud IQ - Site Engine server, enter the following command at the engine CLI:

```
/opt/appid/configMgmtIP <ipaddress>
```

Enter the following command to start using the new ExtremeCloud IQ - Site Engine server:

```
service appidserver restart
```

Changing the Web Service Credentials

The Web Service credentials provide access to the ExtremeAnalytics Engine Administration web page and the web services interface for the

ExtremeAnalytics engine. Engines are shipped with a preconfigured default password.

If you have changed the credentials in the **Analytics** tab and then install a new engine using the default password, you will not be able to monitor or enforce to the new engine until you change the password on the engine using this command. The credentials you enter on the engine must match the credentials specified in **Analytics > Configuration**.

To change Web Service credentials:

1. Enter the following command at the login prompt in the **Console** tab:

```
/opt/appid/configWebCredentials <username><password>
```

2. Restart the engine:

```
service appidserver restart
```

Upgrading ExtremeAnalytics Engine Software

Upgrades to the ExtremeAnalytics engine software will be made available from the Network Management Suite (NMS) Download web page.

1. Download the Extreme Analytics Engine Image 64bit (ZIP) file to your system.

To download an engine image:

1. Access the Extreme Portal at: <https://extremeportal.force.com/>.
 2. After entering your email address and password, you are on the Support page.
 3. Click the **Products** tab and select **ExtremeAnalytics**.
 4. Click **ExtremeAnalytics** in the right-panel.
 5. Select a version.
 6. Download the following image file and extract the file to a directory on your system:
`ExtremeAnalytics Engine Upgrade (BIN)`
2. Use FTP, SCP, or a shared mount point, to copy the upgrade file to the ExtremeAnalytics engine.
 3. SSH to the engine.

4. Cd to the directory where you downloaded the upgrade file.
For example, enter the following to change to the /Users/jsmith directory: `cd /Users/jsmith`
5. Change the permissions on the upgrade file by entering the following command:
`chmod 755 purview_appliance_upgrade_to_ version.bin`
6. Run the install program by entering the following command:
`./purview_appliance_upgrade_to_ version.bin`
The upgrade begins automatically.

The ExtremeAnalytics engine restarts automatically when the upgrade is complete. Because your ExtremeAnalytics engine settings were migrated, you are not required to perform any configuration on the engine following the upgrade.

Reinstalling Engine Software

In the event a software reinstall becomes necessary, use this procedure. Be aware that this procedure reformats the hard drive and reinstalls all the engine software, the operating system, and all related Linux packages.

Connect a monitor and a USB keyboard to the ExtremeAnalytics engine prior to performing these steps.

1. Download the Extreme Analytics Engine Image 64bit (ZIP) file to your system.

To download an engine image:

1. Access the Extreme Portal at: <https://extremeportal.force.com/>.
2. After entering your email address and password, you are on the Support page.
3. Click the **Products** tab and select **ExtremeAnalytics**.
4. Click **ExtremeAnalytics** in the right-panel.
5. Select a version.
6. Download the following image file and extract the file to a directory on your system:

```
ExtremeAnalytics Engine Upgrade (BIN)
```

2. Insert the USB flash drive that came with the PV-A-305 engine into the USB port on your system and note the drive letter it is assigned.
3. Format the USB flash drive.
4. Open a command prompt window and cd to the directory where you extracted the file.

For example, enter the following to change to the /Users/jsmith directory: cd /Users/jsmith

5. Type `make_disk.bat <drive letter>:.`

Note: Because the reinstall procedure reformats the drive, be sure you have specified the correct drive letter.

6. Press [Enter].

The files are copied to the USB flash drive. When the copy is complete you see the message:

```
Successfully installed into <drive letter>: Press any key  
to continue.
```

7. Remove the USB flash drive from your system.

8. Insert the USB flash drive into a USB port on the engine (see [Front Panel Features](#)).
9. Press the power button on the PV-A-305 engine.
10. Verify the USB flash drive is available as a boot option:
 - Press **F2** to open the BIOS Setup Menu when prompted.
 - Press the right arrow button to select the **Boot Options** tab.
 - Select **Internal EFI Shell** as **Boot Option #1** in the boot menu.
 - Select **[Enabled]** in the **USB Boot Priority** field.
 - Press **F10** to save the changes.
A confirmation window displays.
 - Select **Yes** and press **[Enter]**.

The engine restarts.
11. Type **F6** to open the Boot Menu when prompted, as shown in the figure below.
12. Select **Install <version number>** from the menu.
The installation begins automatically and once complete, the engine shuts off.
13. Remove the USB flash drive.
14. Turn on the engine.
15. Proceed to [Configuration](#), and follow the instructions for configuring the engine.

Product Regulatory and Compliance Information

For complete regulatory compliance and safety information, refer to the document Intel® Server Products Product Safety and Regulatory Compliance, available at the following links:

https://www.intel.com/content/dam/support/us/en/documents/motherboards/server/sb/g23122003_safetyregulatory.pdf

<https://www.extremenetworks.com/support/documentation/>

Federal Communications Commission (FCC) Notice

This product has been tested and found to comply with the limits for a class A digital device, pursuant to Part 15 of the FCC rules. These limits are designed to provide reasonable protection against harmful interference when the equipment is operated in a commercial environment. This product uses, generates, and can radiate radio frequency energy and if not installed and used in accordance with the manufacturer's instruction manual, may cause harmful interference to radio communications. Operation of this product in a residential area is likely to cause harmful interference, in which case you will be required to correct the interference at your own expense.

This device complies with Part 15 of the FCC rules. Operation is subject to the following two conditions: (1) this device may not cause harmful interference, and (2) this device must accept any interference received, including interference that may cause undesired operation.

Any changes or modifications not expressly approved by the grantee of this device could void the user's authority to operate the equipment. The customer is responsible for ensuring compliance of the modified product.

Intel Corporation
5200 N.E. Elam Young Parkway
Hillsboro, OR 97124 6497
Phone: 1 800 628 8686

Industry Canada, Class A

This Class A digital apparatus complies with Canadian ICES 003.

This digital apparatus does not exceed the Class A limits for radio noise emissions from digital apparatus set out in the interference causing equipment standard entitled “Digital Apparatus,” ICES 003 of the Canadian Department of Communications.

Cet appareil numérique respecte les limites bruits radioélectriques applicables aux appareils numériques de Classe A prescrites dans la norme sur le matériel brouilleur: “Appareils Numériques”, NMB 003 édictée par le Ministre Canadian des Communications.

CE Notice

This product has been determined to be in compliance with 2006/95/EC (Low Voltage Directive), 2004/108/EC (EMC Directive).

VCCI Notice

This is a class A product based on the standard of the Voluntary Control Council for Interference by Information Technology Equipment (VCCI). If this equipment is used in a domestic environment, radio disturbance may arise. When such trouble occurs, the user may be required to take corrective actions.

この装置は、情報処理装置等電波障害自主規制協議会（VCCI）の基準に基づくクラスA情報技術装置です。この装置を家庭環境で使用すると電波妨害を引き起こすことがあります。この場合には使用者が適切な対策を講ずるよう要求されることがあります。

BSMI EMC Statement — Taiwan

This is a class A product. In a domestic environment this product may cause radio interference in which case the user may be required to take adequate

measures.

警告使用者：

這是甲類的資訊產品，在居住的環境中使用時，可能會造成射頻干擾，在這種情況下，使用者會被要求採取某些適當的對策。

Hazardous Substances

This product complies with the requirements of Directive 2011/65/EU of the European Parliament and of the Council of 8 June 2011 on the restriction of the use of certain hazardous substances in electrical and electronic equipment.

European Waste Electrical and Electronic Equipment (WEEE) Notice



In accordance with Directive 2012/19/EU of the European Parliament on waste electrical and electronic equipment (WEEE):

1. The symbol above indicates that separate collection of electrical and electronic equipment is required.
2. When this product has reached the end of its serviceable life, it cannot be disposed of as unsorted municipal waste. It must be collected and treated separately.
3. It has been determined by the European Parliament that there are potential negative effects on the environment and human health as a result of the presence of hazardous substances in electrical and electronic equipment.
4. It is the users' responsibility to utilize the available collection system to ensure WEEE is properly treated.

For information about the available collection system, please contact Extreme Customer Support at +353 61 705500 (Ireland).

产品说明书附件 Supplement to Product Instructions

部件名称 (Parts)	有毒有害物质或元素 (Hazardous Substance)					
	铅 (Pb)	汞 (Hg)	镉 (Cd)	六价铬 (Cr ⁶⁺)	多溴联苯 (PBB)	多溴二苯醚 (PBDE)
金属部件 (Metal Parts)	×	○	○	○	○	○
电路模块 (Circuit Modules)	×	○	○	○	○	○
电缆及电缆组件 (Cables & Cable Assemblies)	×	○	○	○	○	○
塑料和聚合物部件 (Plastic and Polymeric parts)	○	○	○	○	○	○
电路开关 (Circuit Breakers)	○	○	○	○	○	○

○： 表示该有毒有害物质在该部件所有均质材料中的含量均在 SJ/T 11363-2006 标准规定的限量要求以下。
Indicates that the concentration of the hazardous substance in all homogeneous materials in the parts is below the relevant threshold of the SJ/T 11363-2006 standard.

×： 表示该有毒有害物质至少在该部件的某一均质材料中的含量超出 SJ/T 11363-2006 标准规定的限量要求。
Indicates that the concentration of the hazardous substance of at least one of all homogeneous materials in the parts is above the relevant threshold of the SJ/T 11363-2006 standard.

对销售之日的所售产品, 本表显示。
极进供应链的电子信息产品可能包含这些物质。注意: 在所售产品中可能会也可能不会含有所有列出的部件。
This table shows where these substances may be found in the supply chain of Extreme's electronic information products, as of the date of sale of the enclosed product. Note that some of the component types listed above may or may not be a part of the enclosed product.

除非另外特别的标注, 此标志为针对所涉及产品的环保使用期标志。某些零部件会有一个不同的环保使用期(例如, 电池单元模块)贴在其产品上。
此环保使用期限只适用于产品是在产品手册中所规定的条件下工作。
The Environmentally Friendly Use Period (EFUP) for all enclosed products and their parts are per the symbol shown here, unless otherwise marked. Certain parts may have a different EFUP (for example, battery modules) and so are marked to reflect such. The Environmentally Friendly Use Period is valid only when the product is operated under the conditions defined in the product manual.



Declaration of Conformity

Application of Council Directive(s):	2004/108/EC 2006/95/EC 2011/65/EU
Manufacturer's Name:	Extreme Networks, Inc.
Manufacturer's Address:	145 Rio Robles San Jose, CA 95134 USA
European Representative Name:	Extreme Networks Limited
European Representative Address:	Nexus House, Newbury Business Park London Road, Newbury Berkshire RG14 2PZ, England
Conformance to Directive(s)/Product Standards:	EC Directive 2004/108/EC EN55022:2006 A1:2007 EN 55024:1998 A1:2001 A2:2003 EN 61000-3-2:2006 A1:2009 A2:2009 EN 61000-3- 3:2008 EC Directive 2006/95/EC EN 60950- 1:2006 A1:2009 EN 60825-1:2007 EN 60825- 2:2004 A1:2007 EC Directive 2011/65/EU
Equipment Type/Environment:	Information Technology Equipment, for use in a Commercial or Light Industrial Environment.

The object of the declaration described above is in conformity with Directive 2011/65/EU of the European Parliament and of the Council of 8 June 2011 on the restriction of the use of certain hazardous substances in electrical and electronic equipment.